

STAR TREK STARSHIP HANDBOOKS

<http://trek.escape-committee.co.uk>





trek.escape-committee.co.uk

INTRODUCTION

STAR TREK STARSHIP HANDBOOKS



<http://trek.escape-committee.co.uk>

Volume 7: Supplemental

Compiled by Mark Gill - mark.gill@escape-committee.com
<http://trek.escape-committee.co.uk>

First Edition - Summer 2009 - Version 1.0 (20th August 2009)

INTRODUCTION:

This seventh ebook includes specifications and schematics for nineteen more vessels from the Star Trek universe. This volume features notable ships that didn't make it into the previous compilations.

Earth starships are listed first, followed by Federation Starfleet vessels, auxiliary vessels, Vulcan ships, Son'a ships, and finally additional ships from the Delta Quadrant. Many noteworthy vessels had to be left out again due to space, so another supplemental volume will hopefully follow in due course.

As always, a full list of sources used is included in the bibliography - they're all well worth checking out. Many thanks again to everyone who's kindly granted permission for their images to be used. As with previous volumes, if I've used your image and haven't managed to contact you to ask permission, or I've not credited you, my apologies - please email me at the address above.

This ebook has been produced by a fellow fan for reference and fun. All copyrights are acknowledged.

Mark Gill

Contents:

Page	Vessel
1	Contents
2	Conestoga
4	DY-100 Class
6	NX Prototype
8	Phoenix
10	Holoship
12	Ptolemy Class
14	Federation Tug
16	Whorfin Class
18	Inspection Pod
20	Travel Pod
22	Work Bee
24	Maquis Raider
26	Vulcan Apollo Class
28	Vulcan T'Plana Hath
30	Son'a Battleship
32	Son'a Command Ship
34	Hirogen Venatic Class
36	Vidlian Cruiser
38	Voth City Ship
40	Size Comparison
41	Bibliography

CONESTOGA

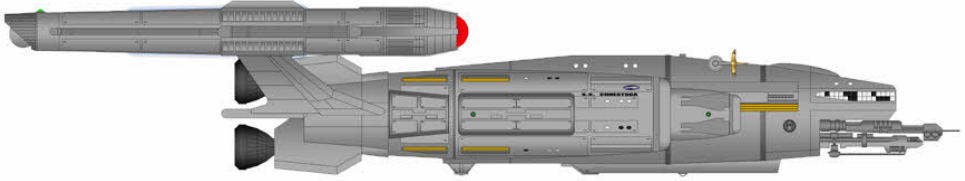

Class: Conestoga
Type: Colony Ship
Commissioned: 2069
Production Base: Unknown,
Earth
Length: 180 metres
Beam: 67 metres
Height: 33 metres

Mass: 10,000 metric tons
Crew: 25 (plus 200 colonists)
Cruising Speed: Warp 1.3
Maximum Speed: Warp 1.4
Armament: 2 Plasma cannons

Known Ships (SS)
Conestoga

CLASS INFORMATION:

The S.S. *Conestoga* was an Earth colony ship built shortly after Zefram Cochrane's first warp flight, for the colonization of Terra Nova, a nearby class M planet. It was capable of carrying around two hundred colonists, and was equipped for long-term travel. The expedition was the first Human extra-solar colony effort.

The ship was specially constructed so that it could be dismantled on arrival to serve as homes and service buildings for the colony. The *Conestoga* was commanded by Captain Mitchell.

Launched in 2069, the *Conestoga* took nine years, travelling at Warp 1.3, to reach Terra Nova. The *Conestoga* reached the planet on June 23rd 2078, and its modules were dismantled to form the colony's initial structures.

The *Conestoga* inspired the design of the later *Discovery*-class United Earth scout ships of the mid-22nd century.



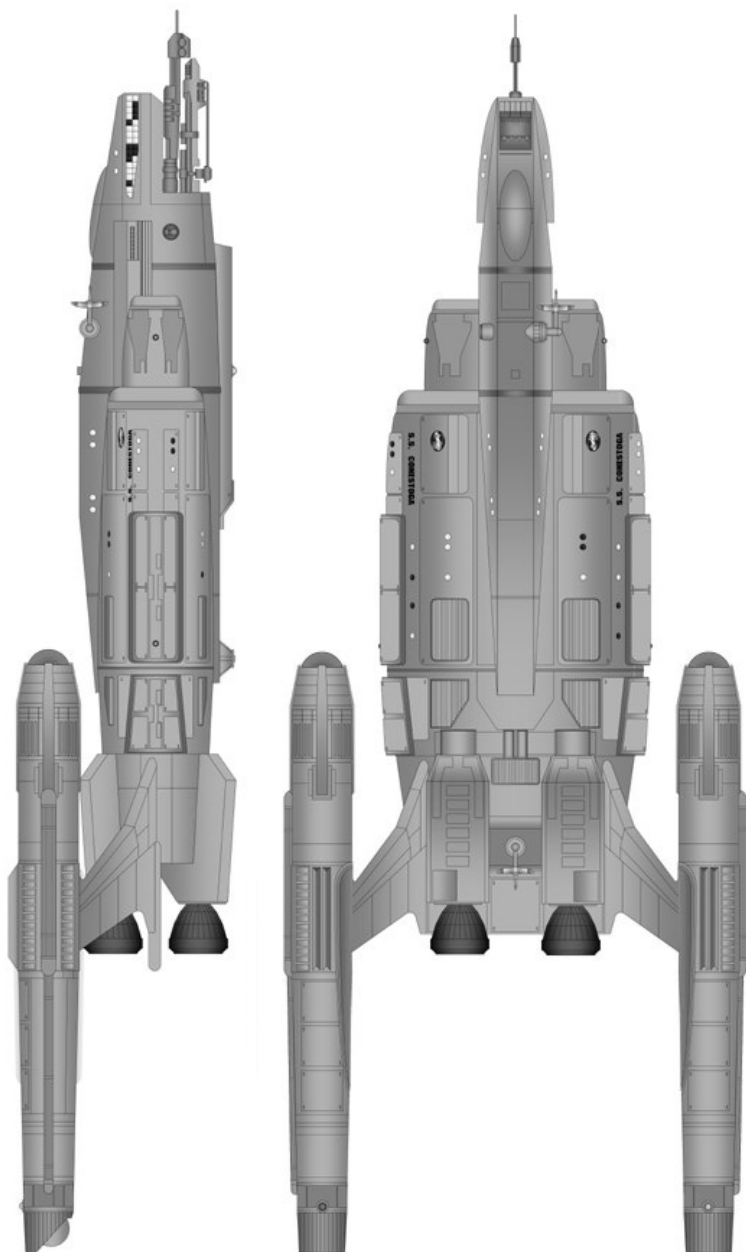

DY-100 CLASS

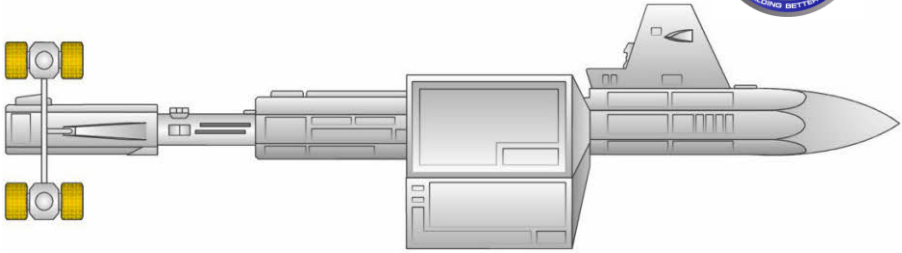

Class: DY-100
Type: Interplanetary Freighter
Commissioned: 1996
Production Base: Unknown, Earth
Length: 107.59 metres
Beam: 32.31 metres
Height: 48.77 metres

Mass: 21,100 metric tons
Crew: 85
Cruising Speed: Sublight
Maximum Speed: 0.2 c
Armament: None

DY Known Ships (SS)
DY-102 Botany Bay †
Copernicus ☿
DY-116 Woden †
† *Lost or destroyed*
☿ *Non-canon*

CLASS INFORMATION:

The *DY-100* class was an early Earth interplanetary vessel from the late 20th century. The *DY-100* was launched into orbit with booster rockets, then used simple nuclear powered engines once in space. They were equipped with artificial gravity, but still used transistors as components. Up to sixteen wedge-shaped cargo modules could be fitted around the spine of the vessel, with five as standard.

At least some *DY-100* vessels were sleeper ships. In these the crew were placed in suspended animation inside life support canisters prior to liftoff. Overall life support was then turned off for the journey. The use of suspended animation was necessary up to around 2018.

The *DY-100* class S.S. *Botany Bay*, carrying the former dictator Khan Noonien Singh and a group of his followers, was found adrift in the Mutara Sector in 2267 by the U.S.S. *Enterprise*. Khan and his augments were resettled to Ceti Alpha V.

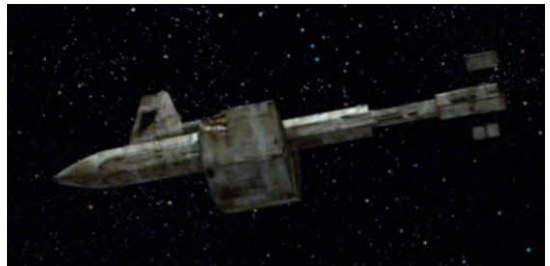

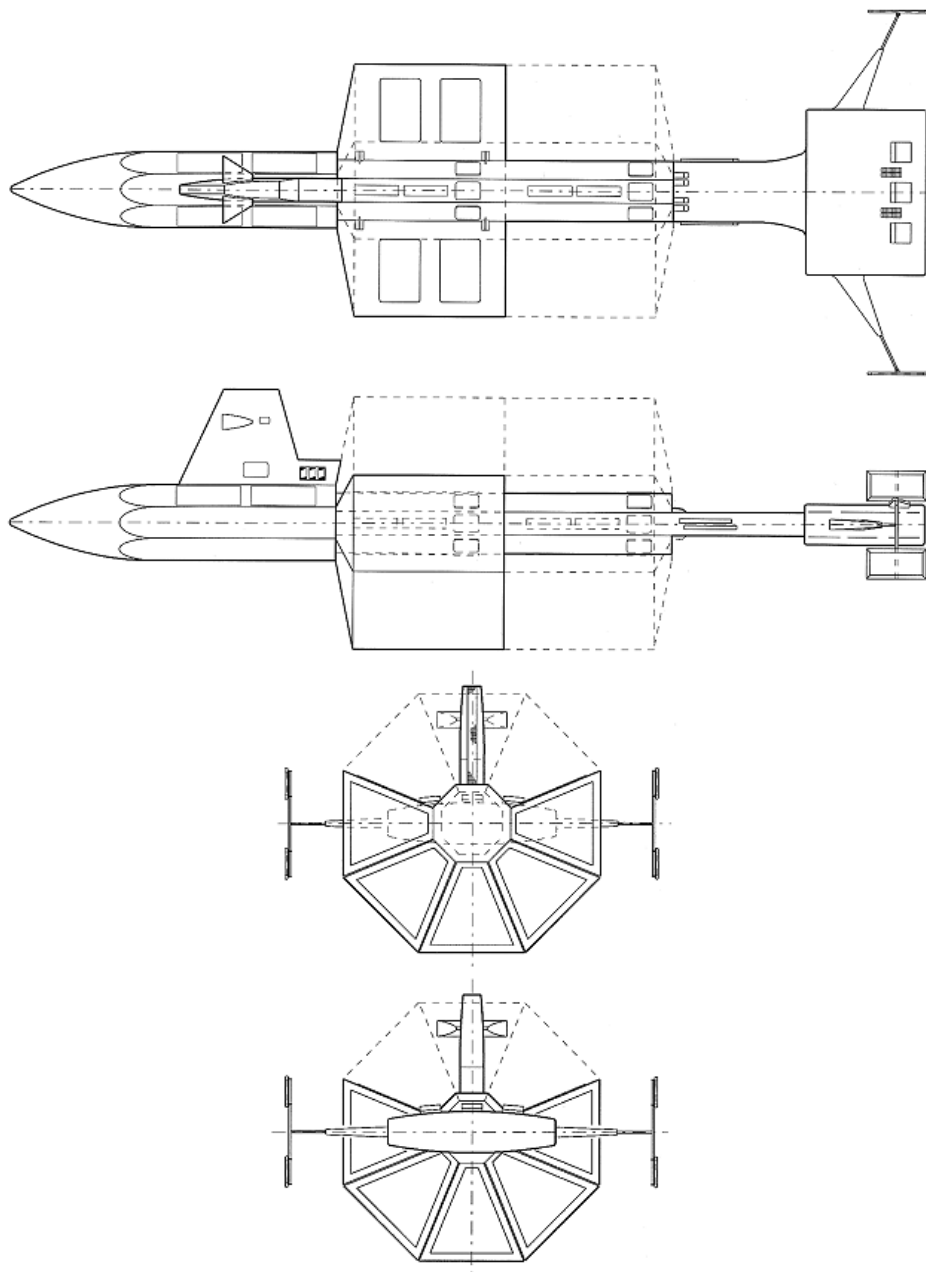

NX PROTOTYPE



Class: NX Prototype
Type: Warp 3 Prototype
Commissioned: 2143
Production Base: Warp Five Complex, Earth
Length: 20 metres
Beam: 14 metres
Height: 2.5 metres

Mass: 40 metric tons
Crew: 2
Cruising Speed: Warp 2
Maximum Speed: Warp 3
Armament: None

Known Ships
NX-Alpha
NX-Beta
NX-Gamma
NX-Delta

CLASS INFORMATION:

The *NX Prototype* was used as a testbed for Earth Starfleet's NX Project - to develop a starship using the engine designed by the Warp Five programme. Prior to the project, Human ships were only capable of achieving Warp 2.

First launched in 2143, the two-seater prototypes comprised of a rocket-shaped main hull with various fins and control surfaces at the rear. Two warp nacelles were mounted to the sides via wings that could be folded to optimise hangar space.

NX-Alpha, the first of the prototypes, was piloted by A.G. Robinson. It broke apart after Robinson had reached Warp 2.2. Shortly after that, Jonathan Archer and Robinson achieved Warp 2.5 during an unauthorised flight on *NX-Beta*. After the ships had been grounded for extensive simulations, the Vulcans confirmed that the engine would work. Eight months later, Duvall broke the Warp 3 barrier on *NX-Delta*.



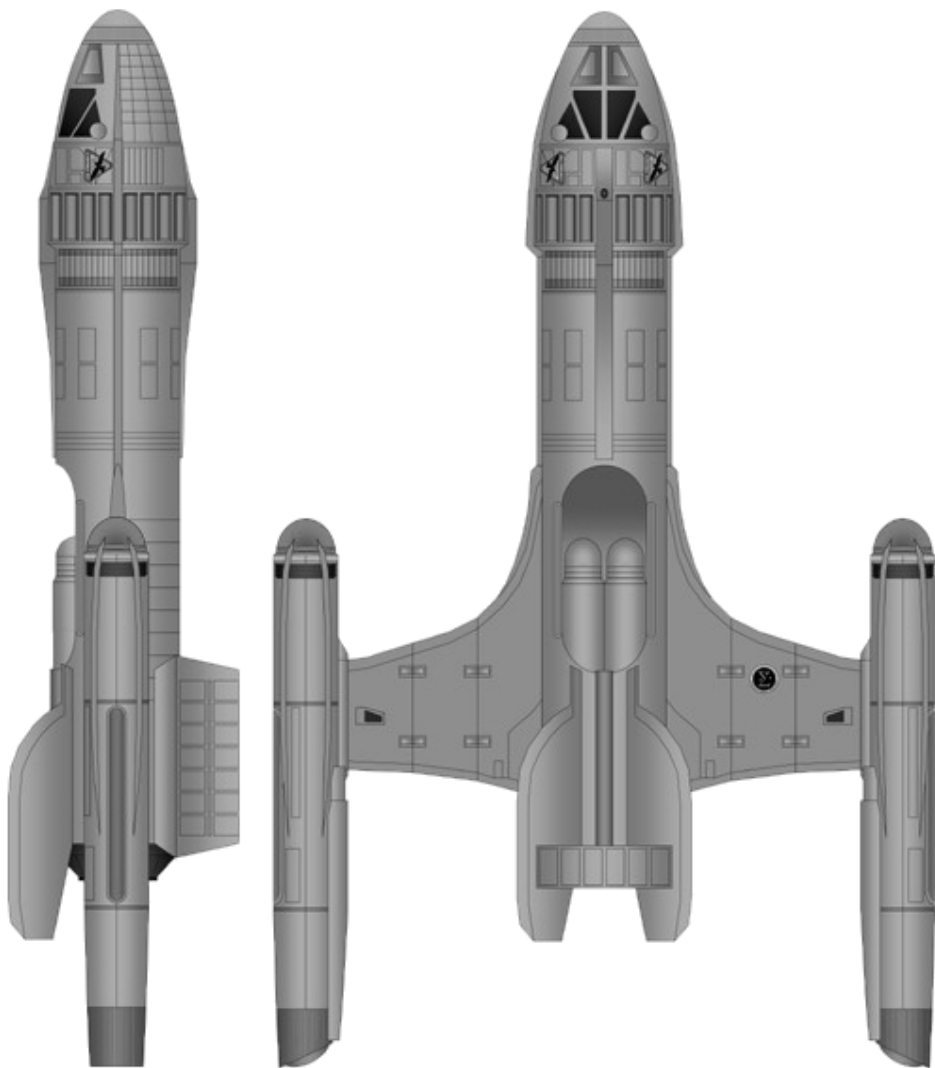

PHOENIX

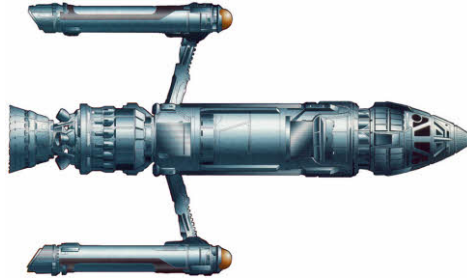

Class: Phoenix
Type: Prototype Warp Ship
Commissioned: 2063
Production Base: Bozeman,
Montana, Earth
Length: 27.5 metres
Beam: 16 metres
Height: 3.4 metres

Mass: 80 metric tons
Crew: 3
Cruising Speed: Sublight
Maximum Speed: Warp 1
Armament: None

Known Ships
Phoenix

N.B. Top view shown above

CLASS INFORMATION:

The *Phoenix* was Earth's first manned spacecraft to achieve the speed of light with warp drive. The *Phoenix* was built by space pioneer Dr. Zefram Cochrane and engineer Lily Sloane, inside a missile silo in Bozeman, Montana. It was mounted on a Titan V nuclear missile, and had a four metre titanium-cased cockpit and twin warp nacelles.

The *Phoenix* made its historic first warp flight on April 5th 2063, piloted by Zefram Cochrane. The flight attracted the attention of a passing Vulcan ship, the *T'Polana-Hath*, and the Vulcans initiated Humanity's first official contact with extraterrestrials.

The *Phoenix* was later placed on display at the Smithsonian Institution, and was the subject of a course taught at Starfleet Academy.

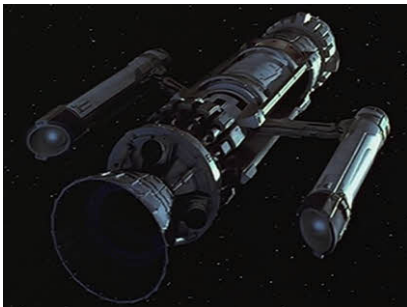

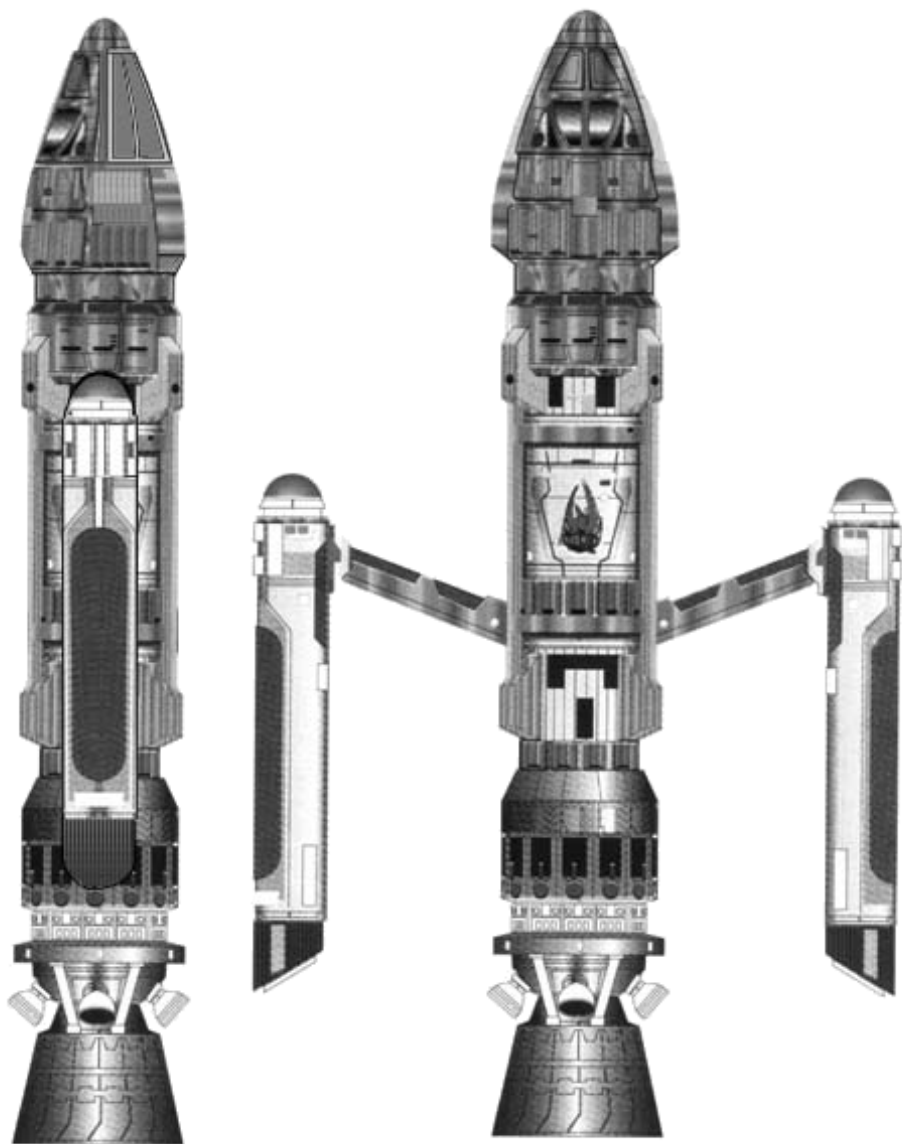

HOLOSHIP

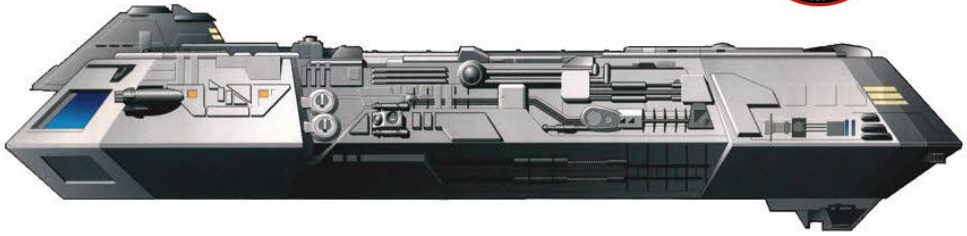

Class: Unknown
Type: Holoship
Commissioned: 2375
Production Base: Unknown
Length: 247 metres
Beam: 100 metres
Height: 52.2 metres
Mass: 550,000 metric tons

Crew: 75
Cruising Speed: Warp 8
Maximum Speed: Warp 9
Armament: None

NX **Known Ships (USS)**
75115 (Name unknown)

CLASS INFORMATION:

The *Holoship* was a prototype Federation starship constructed by Section 31 and launched in 2375. The ship had a rectangular design, with an aft mounted bridge module, and warp nacelles set into the main body.

The vessel was built to serve as a mobile holodeck which could simulate surroundings familiar to its passengers. It was also equipped with fourteen long-range transporters and a cloaking device.

The *Holoship* was employed by Admiral Matthew Dougherty and Ahdar Ru'afo, the leader of the Son'a, to secretly transport the entire six hundred Ba'ku inhabitants off their planet without their knowledge, in order to utilise the metaphasic radiation present in the planet's rings. The ship was to be destroyed by Starfleet Command after the Ba'ku incident became public, but was captured by a group of Starfleet officers covertly working against Section 31.



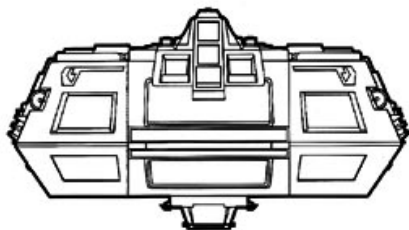
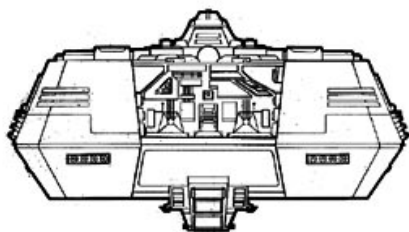
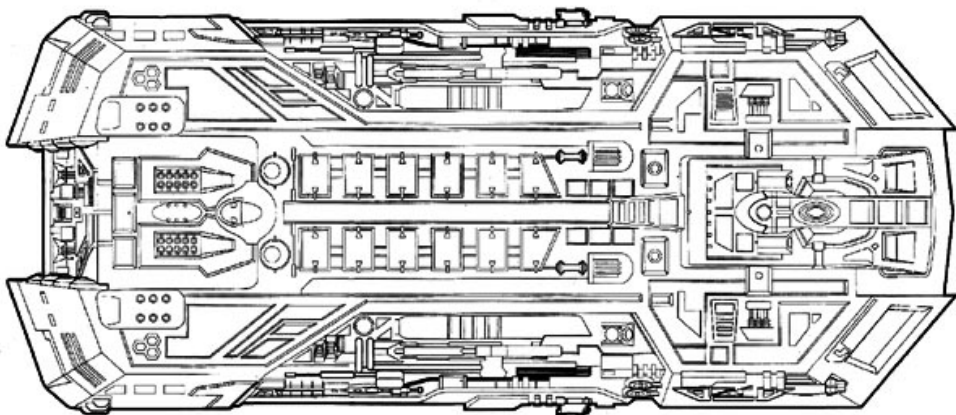
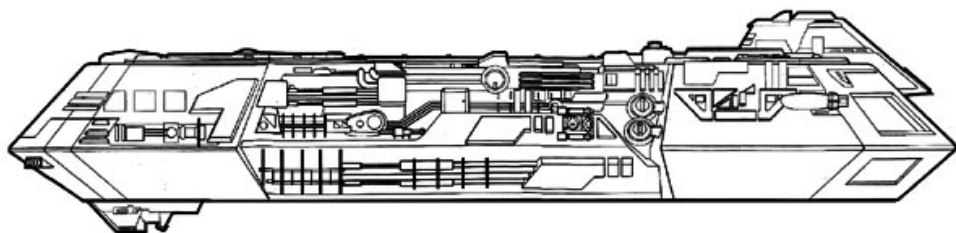

PTOLEMY CLASS

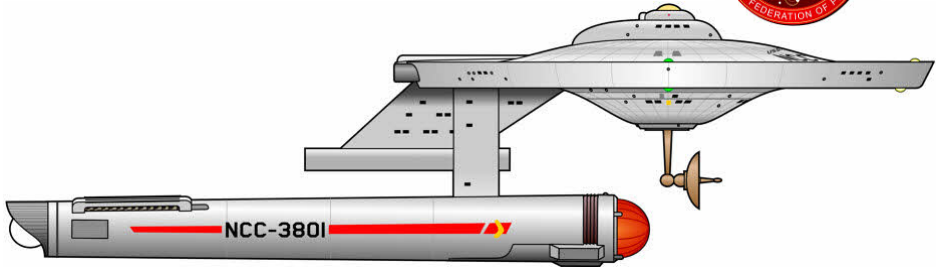

Class: Ptolemy
Type: Transport/Tug
Commissioned: 2245
Production Base: San Francisco Fleet Yards, Earth
Length: 222 metres
Beam: 127.1 metres
Height: 66 metres

Mass: 126,500 metric tons
Crew: 220
Cruising Speed: Warp 6 *
Maximum Speed: Warp 8 *
Armament: 3 Phaser banks

* *Original Cochrane Unit (OCU)*

NCC	Known Ships (USS)
3801	Ptolemy
3802	Al Rashid ϕ
	ϕ <i>Non-canon</i>

CLASS INFORMATION:

The *Ptolemy*-class was a transport/tug used by Starfleet during the 23rd century to transport priority military and government cargo and troops.

Based on the standard Starfleet design tree and hull components of the time, the *Ptolemy*-class replaced the engineering hull of the *Constitution*-class with a connector at the base of the neck, which could accept a variety of cylindrical transport containers. The *Ptolemy*-class could pull up to three containers towed in line.

Several types of container pod were available, optimised for bulk liquids, dry bulk, refrigeration, personnel, and other products. The starliner pod could carry up to 300 personnel, and was usually used to carry relief crews to isolated outposts. Freight pods were unmanned, but contained accessways for crew and station personnel to oversee loading and unloading.



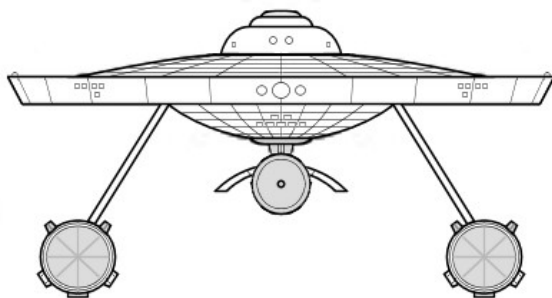
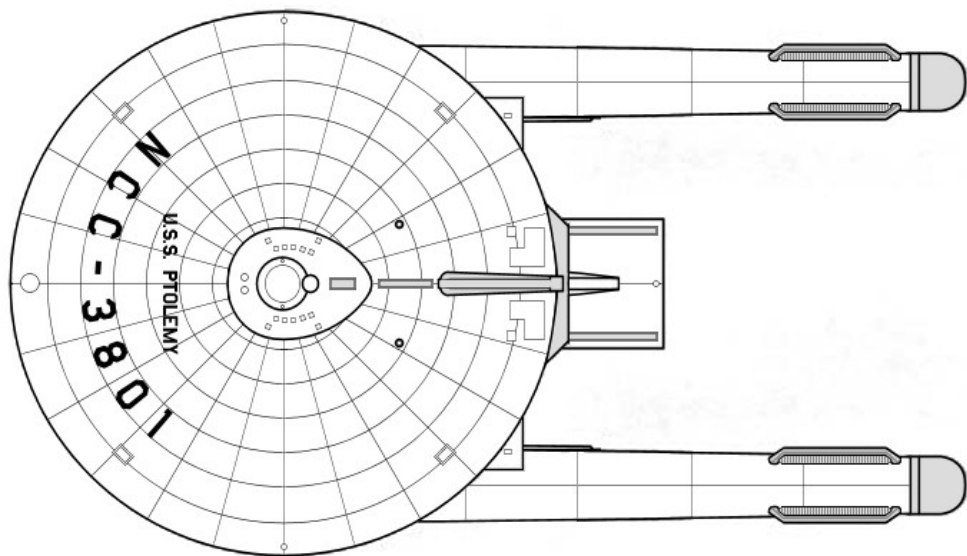
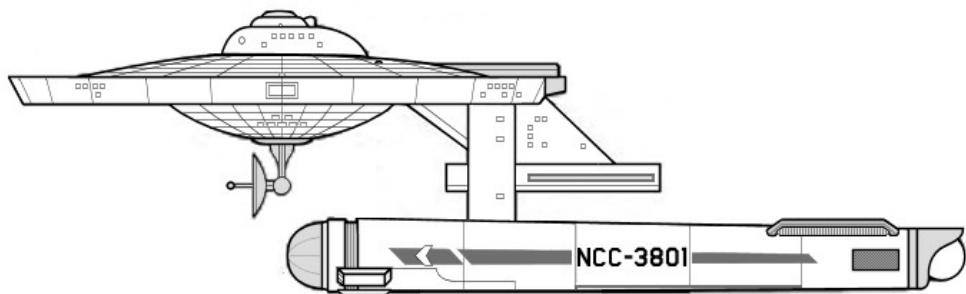

FEDERATION TUG

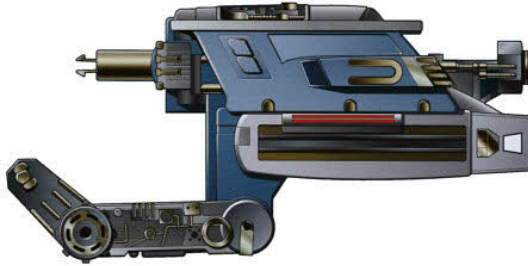

Class: Atlas
Type: Tug
Commissioned: 2370
Production Base: Various
Length: 66 metres
Beam: 54.5 metres
Height: 33 metres
Mass: 7,800 metric tons

Crew: 0
Cruising Speed: Warp 3
Maximum Speed: Warp 4
Armament: None

NCC **Known Ships (USS)**
Ertl

CLASS INFORMATION:

The *Atlas*-class tug was a type of specialized Federation starship used exclusively for towing damaged or disabled vessels.

The compact and utilitarian design incorporated two small nacelles on either side of the main hull, and a pair of powerful tractor emitters mounted on twin pylons which trailed behind the craft. The tug could be automated or operated remotely, requiring no flight crew, but was capable of towing ships of at least the size of an *Excelsior*-class starship.

During the Dominion War *Atlas*-class tugs were utilized in the evacuation of disabled vessels from battle zones. The *U.S.S. Fredrickson* NCC-42111 was one starship to benefit from these utility vessels in 2374.



drex files

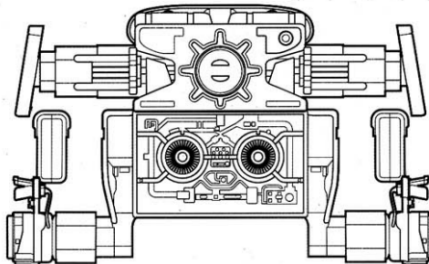
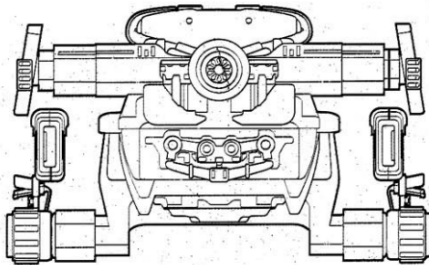
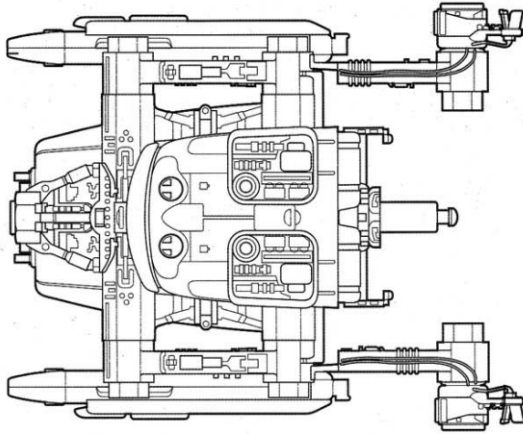
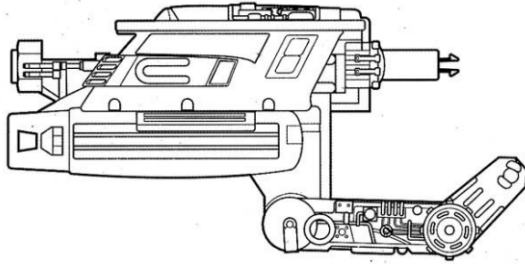

WHORFIN CLASS

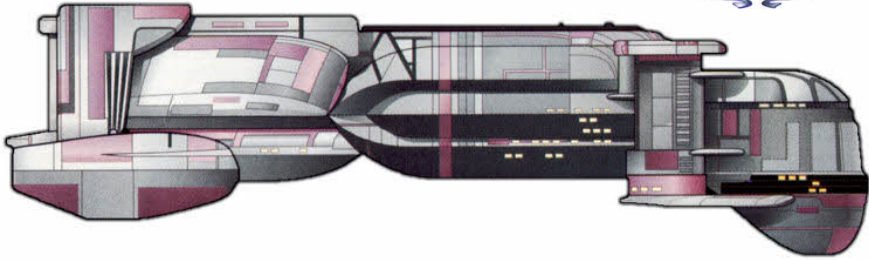

Class: Whorfin
Type: Transport
First Encountered: 2293
Production Base: Unknown
Length: 270 metres
Beam: 247 metres
Height: 80 metres
Mass: 420,000 metric tons

Crew: 15 (plus 200 passengers)
Cruising Speed: Warp 3
Maximum Speed: Warp 4
Armament: None

NFT	Known Ships (SS)
7793	Lakul †
1327	Robert Fox †
1024	Whorfin (U.S.S.) *

* *Starfleet ship (NCC registry)*
† *Lost or destroyed*

CLASS INFORMATION:

The *Whorfin*-class was a type of transport ship used by the Federation in the late 23rd century. It was capable of carrying upwards of 200 passengers. The class used TPS pulse fusion engines.

In 2293, two civilian *Whorfin*-class starships transporting El Aurian refugees, the *S.S. Lakul* NFT-7793 and the *S.S. Robert Fox* NFT-1327, were caught in the Nexus energy ribbon three light years from Earth. The *U.S.S. Enterprise* NCC-1701-B answered their distress call and managed to rescue 47 passengers from the *Lakul* before hull stresses destroyed both ships.

Starfleet also used *Whorfin*-class vessels, and the prototype *U.S.S. Whorfin* NCC-1024 was assigned to patrol the Neutral Zone at the time Operation Retrieve was proposed earlier the same year.

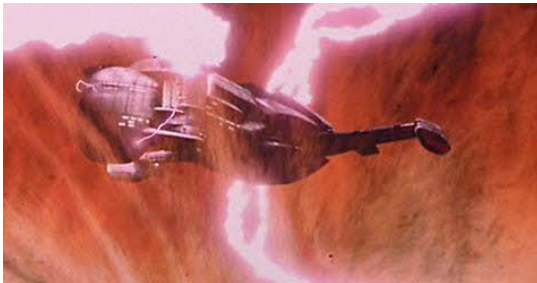

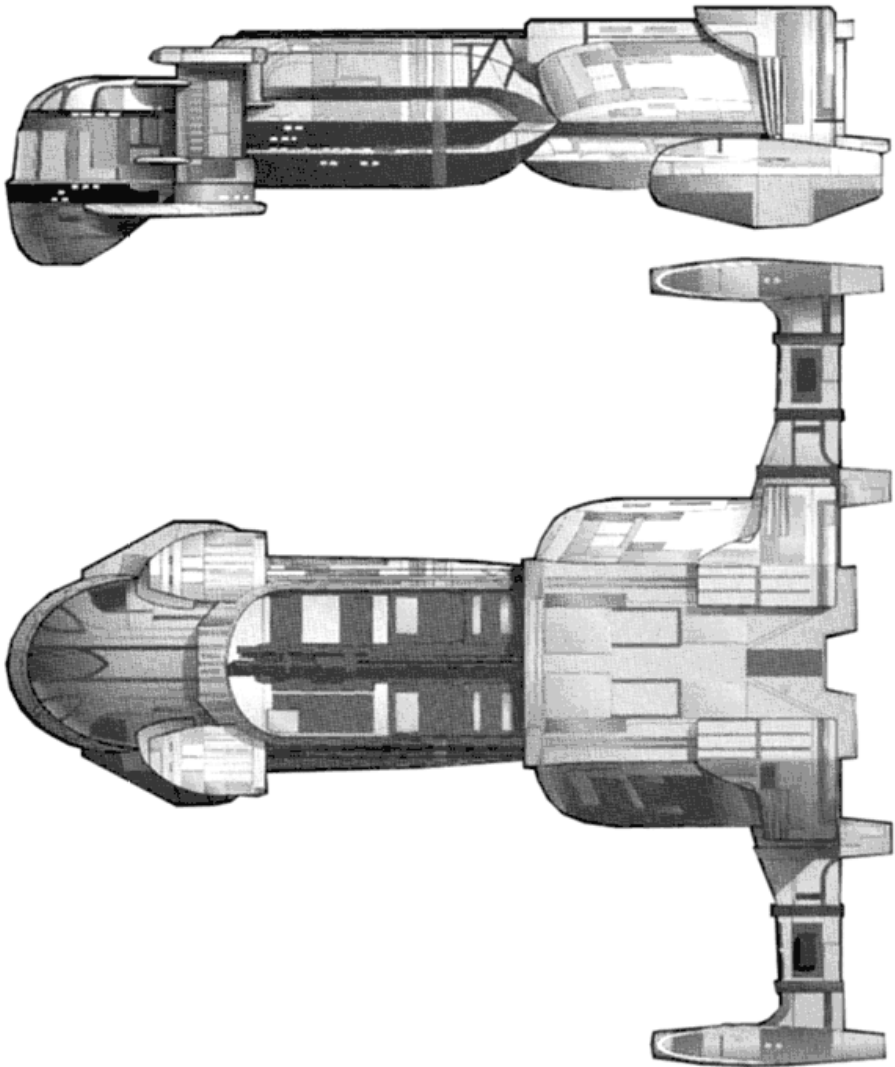

INSPECTION POD

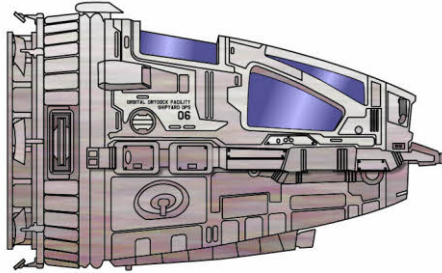

Class: Inspection Pod
Type: Interorbital Personnel Transport
Commissioned: 2148
Production Base: Warp Five Complex, Earth
Length: 3.3 metres
Beam: 2.26 metres

Height: 2 metres
Mass: 2.5 metric tons
Crew: 1 (plus 1 passenger)
Cruising Speed: Sublight
Maximum Speed: Sublight
Armament: None

Known Ships
Orbital 5
Orbital 6

CLASS INFORMATION:

An *Orbital Inspection Pod* was a type of shuttlepod used by Earth Starfleet in the mid-22nd century. At that time matter transportation was not yet in regular use, so *Inspection Pods* and shuttles were a principal method of transferring personnel to and from starships.

The capsule featured a two person cockpit with large observation windows, and a docking port at the rear. Remote manipulators enabled the pod operator to handle cargo and carry out repairs. Propulsion was provide by thrusters. *Inspection Pods* could be launched into orbit atop rockets, then manoeuvred to holding areas, and outfitted for specific duties while in orbit.

NX-class starships carried two *Inspection Pods* for handling cargo, repairs and routine maintenance, which could be launched via the ventral cargo bay doors.



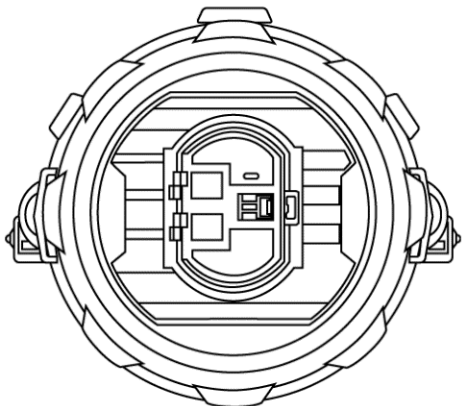
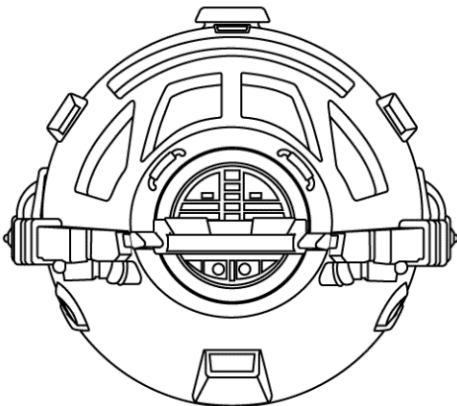
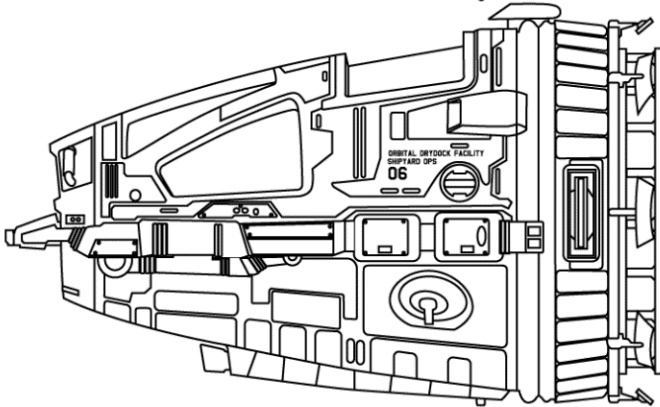
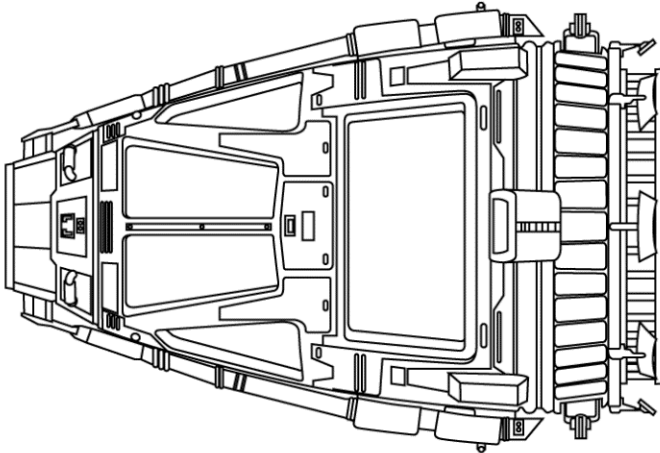

TRAVEL POD

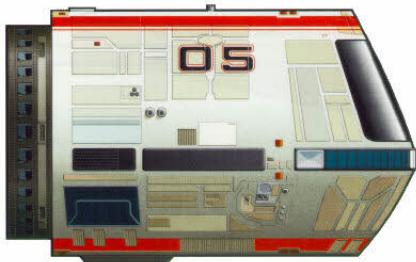

Class: Travel Pod
Type: Interorbital Personnel Transport
Commissioned: 2270
Production Base:
Length: 4.4 metres
Beam: 3.26 metres
Height: 2.85 metres

Mass: 2.85 metric tons
Crew: 1 (plus 7 passengers)
Cruising Speed: 680 m/s
Maximum Speed: 10 km/s
Armament: None

Known Ships
Travel Pod 05
Travel Pod 06

CLASS INFORMATION:

A *Travel Pod* was a small Federation shuttlepod used during the 23rd century to transfer personnel between orbital facilities and spaceships.

The *Travel Pod* was designed to complement the orbital shuttle also produced in the 2270s. Where the orbital shuttle was designed to operate both in space and a planetary atmosphere, the *Travel Pod* was confined purely to space. The bulky shape was designed to maximize internal volume, with no attempt to give it any aerodynamic qualities. Propulsion was provided by microthrusters.

The design featured a standard docking and entry hatch at the rear, simple flight controls at the forward end, and an artificial gravity generator under the floor. The front of the vessel was dominated by a large viewport.

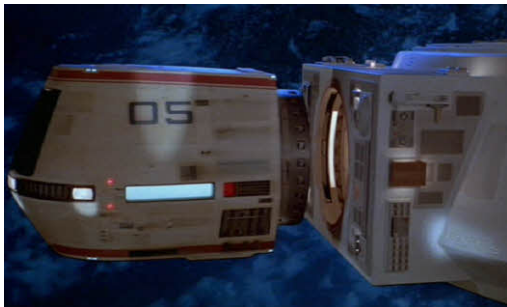

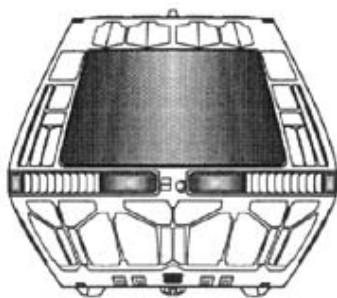
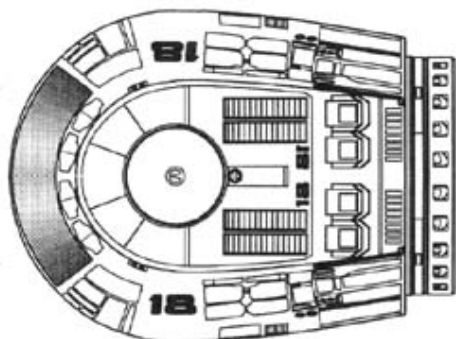
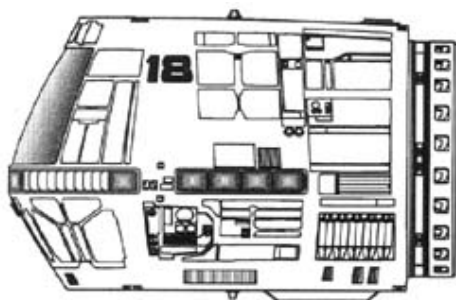

WORK BEE



Class: Work Bee
Type: General Utility Craft
Commissioned: 2268
Production Base: Various
Length: 1.2 metres
Beam: 1.2 metres
Height: 1.3 metres
Mass: 2.23 metric tons

Crew: 1
Cruising Speed: 7.9 km/s
Maximum Speed: 8.2 km/s
Armament: None

Known Ships
005
008
010
342

CLASS INFORMATION:

A *Work Bee* is a small, versatile, microfusion-powered utility craft designed to support the construction and maintenance of starships and space stations.

The *Work Bee* consists of a cab for a single operator, which can be fitted with a variety of specialised add-on modules, including a grabber sled, a welder unit, a 'metal spinner' unit, and cargo or passenger module trains, amongst others. The forward hatch can be opened, allowing the pilot to leave the craft to conduct an EVA. The hatch can also be disconnected and removed for unpressurised work.

With upgrades and enhancements to the basic design, the versatile *Work Bee* has continued in service for over 110 years. *Work Bees* assisted in the refitting of the original *U.S.S. Enterprise NCC-1701* and the launch of the *Enterprise-B*, and were numerous at San Francisco Fleet Yards, Utopia Planitia, and Deep Space Nine.



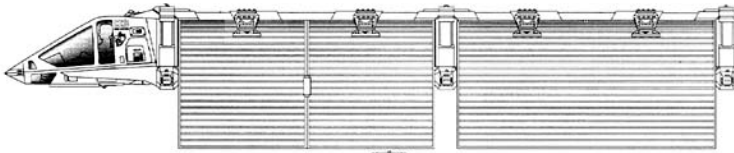
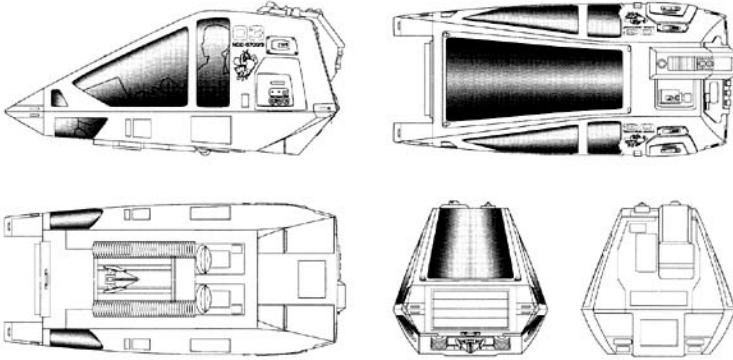

Cargo Train



Bee Packs



Booster Pack

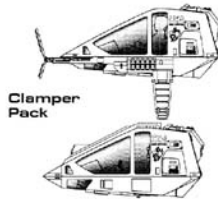

Clamper Pack



Cutter Pack



Heavy Booster Pack



Drone Pack



Floodlight Pack



Grabber Pack



Sensor Pack

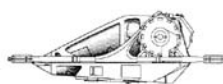

Spinner Pack



Survey Pack



Tractor Pack



Welder Pack

MAQUIS RAIDER

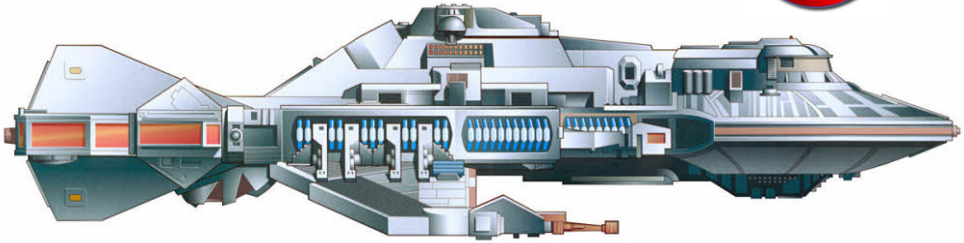

Class: Ju'day
Type: Attack Fighter/Courier
Commissioned: 2332
Production Base: Various
Length: 60 metres
Beam: 66 metres
Height: 14.6 metres
Mass: 2,600 metric tons

Crew: 2-4 (plus 50 passengers)
Cruising Speed: Warp 5
Maximum Speed: Warp 7
Armament: 2 Type V phaser banks, 4 photon torpedo launchers

Known Ships (SS)
Alpha Nine
Alpha Seven
Ju'day
Val Jean *†
* *Variant*
† *Lost or destroyed*

CLASS INFORMATION:

The *Ju'day*-class raider was a relatively small, manoeuvrable starship of Federation design, which was later used by the Maquis in their fight against the Cardassians.

At least two variants of the vessel existed. One version had a small cockpit with seating for two, and a cargo area in the aft section. The second variant featured a separate and much more spacious cockpit which held four stations, and larger crew facilities in the aft sections. Both designs were armed with twin wingtip-mounted phasers, and pairs of forward and aft firing torpedo launchers.

In 2371, the Maquis raider *Val Jean* was dragged across the galaxy by the being known as 'The Caretaker'. The ship was subsequently destroyed ramming a Kazon vessel, and its remaining personnel integrated into the crew of the *U.S.S. Voyager*.

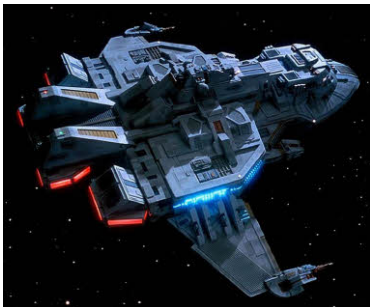

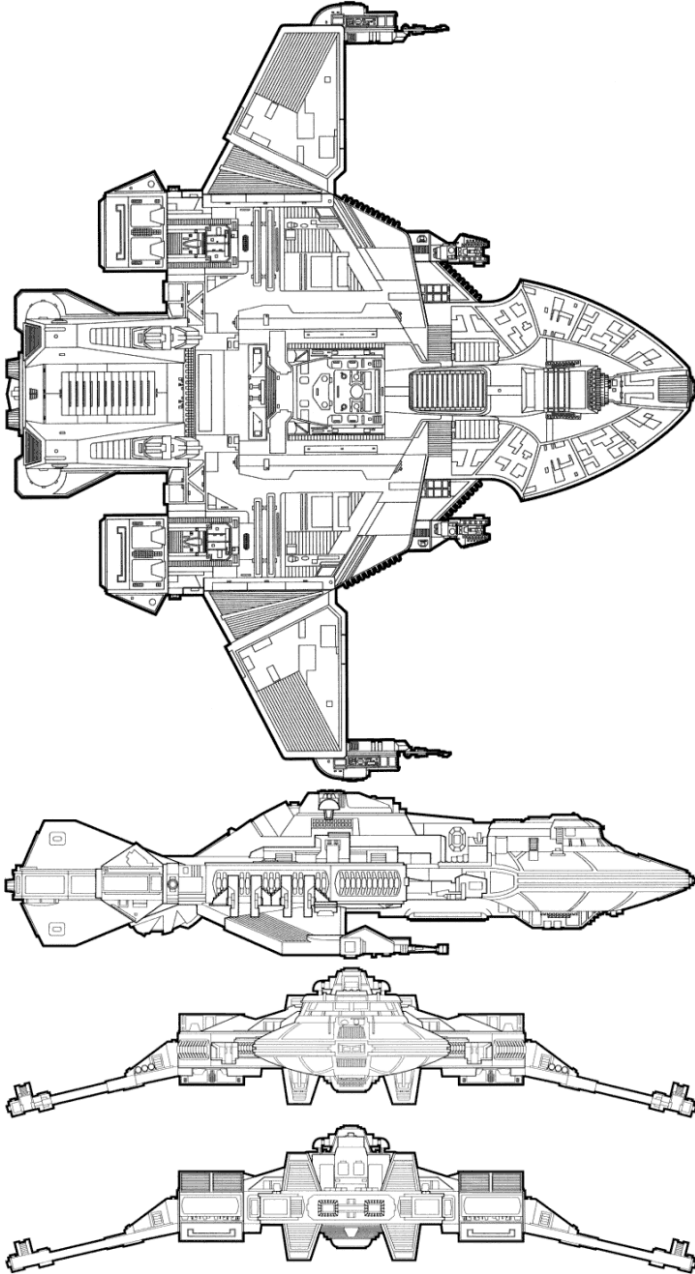

VULCAN APOLLO CLASS

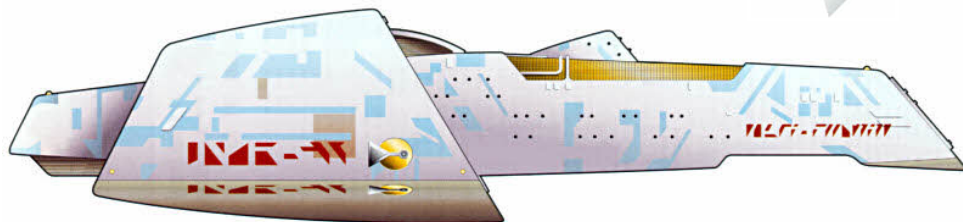

Class: Apollo
Type: Light Cruiser/Transport
Commissioned: 2325
Production Base: 40 Eridani A
Fleet Yards, Vulcan
Length: 170 metres
Beam: 91 metres
Height: 36 metres

Mass: 147,600 metric tons
Crew: 217
Cruising Speed: Warp 5
Maximum Speed: Warp 9.6
Armament: 2 Type VIII phaser
arrays, 1 photon torpedo
launcher

NCC	Known Ships (USS)
11638	Agamemnon
11574	Ajax
12537	Clement
11672	Gage †
17938 *	T'Pau †
* NSP registry	
† Lost or destroyed	

CLASS INFORMATION:

The *Apollo*-class was designed by Vulcan engineers and therefore has an unusual appearance for a Starfleet vessel. The aft section of the hull is surrounded by a trapezoidal structure which contains the ship's warp engines.

The *Apollo*-class is the smallest of Starfleet's light cruisers. Its primary role is to transport troops and other personnel through dangerous areas of space. While not heavily armed, it is usually fast and manoeuvrable enough to avoid or outrun trouble. In times of conflict the *Apollo* may also play a secondary support role.

The *Apollo*-class *T'Pau* NSP-17938 was a civilian Vulcan transport, decommissioned in 2364, and later sent to Surplus Depot Z15 at Qualor II. In 2368, the vessel was refurbished by the Romulans and used as part of a bogus peace convoy, in their failed attempt to conquer Vulcan.



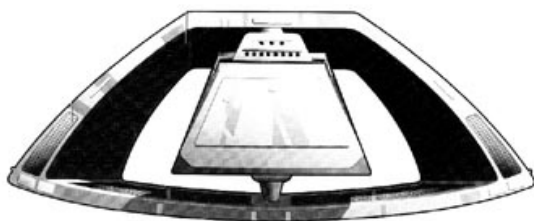
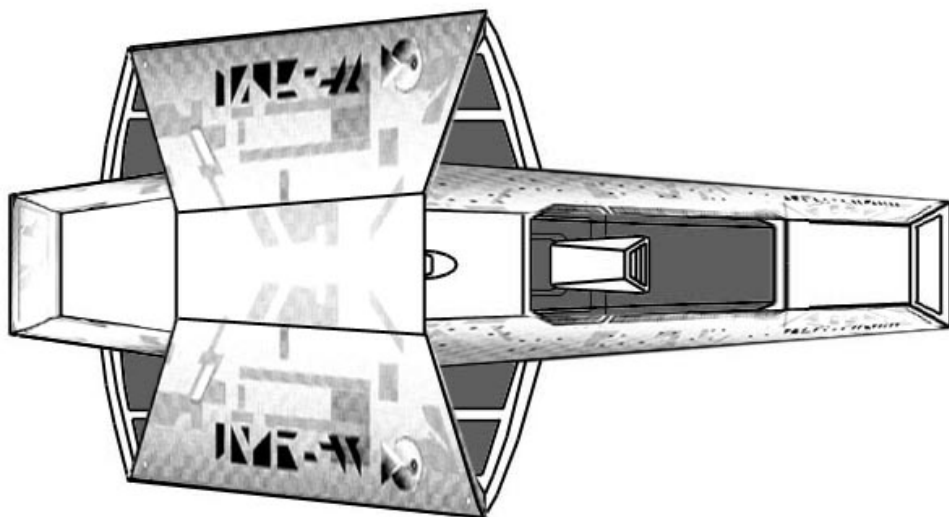
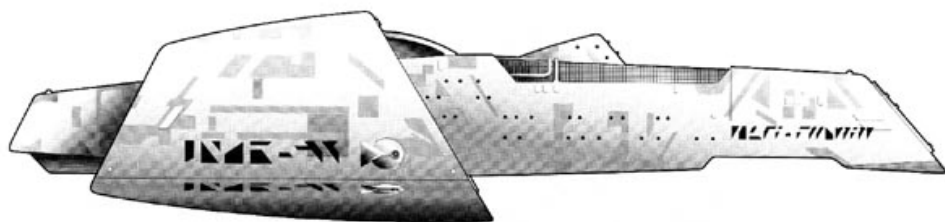

VULCAN T'PLANA HATH CLASS

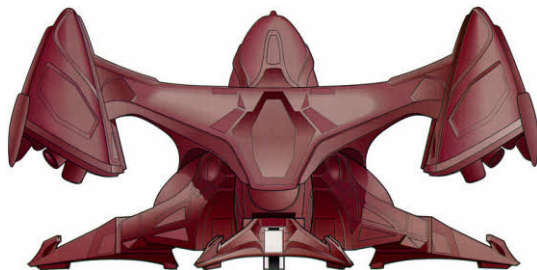

Class: T'Plana Hath

Type: Surveyor

First Encountered: 2063

Production Base: 40 Eridani A
Construction Yards, Vulcan

Length: 45 metres

Beam: 45 metres

Height: 22 metres

Mass: 600 metric tons

Crew: 3

Cruising Speed: Warp 1

Maximum Speed: Warp 1.5

Armament: Phaser arrays, photon torpedo launchers

Known Ships

T'Plana Hath

CLASS INFORMATION:

Named after the matron of Vulcan philosophy, the *T'Plana Hath*-class served as the primary exploration vessel of the Vulcan Science Institute and the Vulcan High Command in the mid-21st century. The ship was suitable for extended medium-range planetary deployment, cultural survey, and clandestine observation missions.

The *T'Plana Hath*'s warp drive was around twice as fast as that of the first human warp engine, at half the size. Sublight propulsion was provided by three ion-powered impulse engines, and the three landing feet folded out from the engine pods. A single dorsal hatch with an extendable ramp provided egress.

On April 5th 2063, while passing through the Sol system, the *T'Plana Hath* detected Dr. Zefram Cochrane's first warp flight aboard the *Phoenix*. The ship landed in Bozeman, Montana, initiating humanity's first official contact with an alien species.



Plans VULCAN T'PLANA HATH CLASS

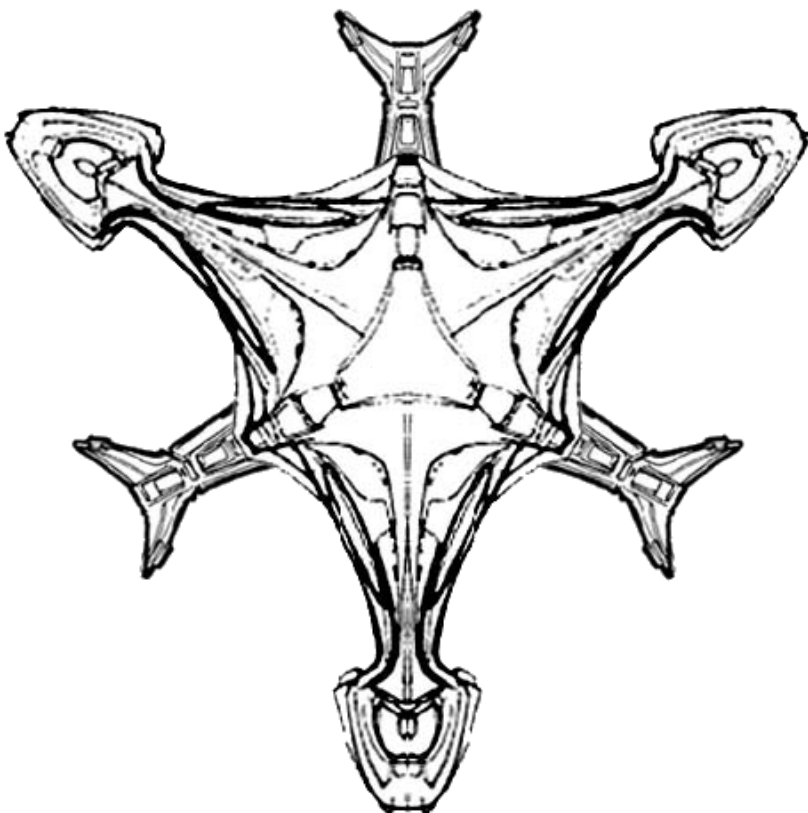
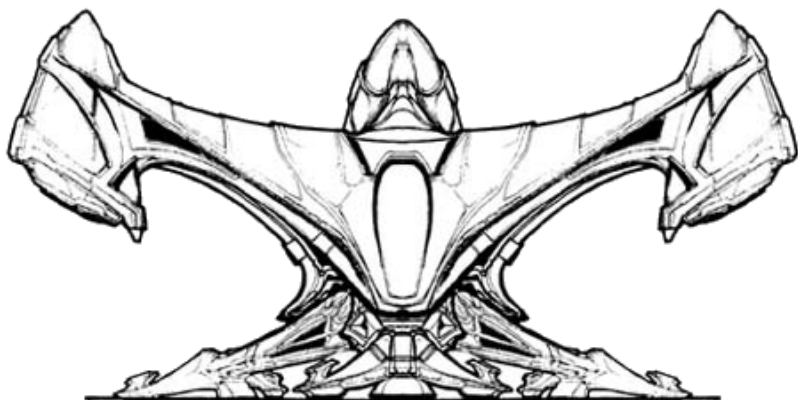

SON'A BATTLESHIP

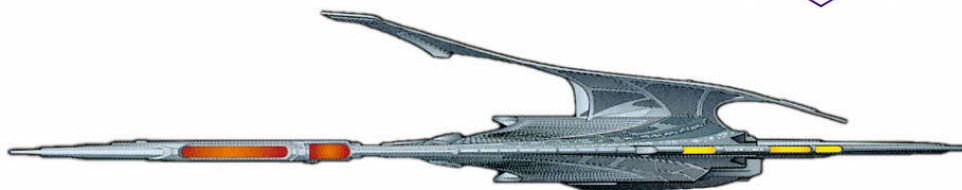

Class: Unknown
Type: Battleship
First Encountered: 2375
Production Base: Unknown
Length: 837 metres
Beam: 1065 metres
Height: 162 metres
Mass: 9,000,000 metric tons

Crew: 1,400
Cruising Speed: Warp 8
Maximum Speed: Warp 9.9
Armament: 24 Phaser banks,
6 photon torpedo launchers,
4 isolytic burst weapons

Known Ships
(Names unknown)

CLASS INFORMATION:

Son'a Battleships are amongst the most powerful vessels in the Alpha and Beta Quadrants. They are equipped with phasers, photon torpedoes and isolytic sub-space weapons - highly unpredictable charges which create tears in subspace - which are outlawed under the Second Khitomer Accords.

The forward torpedo tubes are situated in the protruding structures at the very front of the ship, with phasers mounted in the smaller 'teeth' in between. The isolytic weapon launchers form the leading edge of the curving wings, with three additional weapons arrays on the trailing edge of the upper horn-like structure. Warp vanes and primary impulse engines are housed in the wingtip structures, with additional warp field trim vanes forming the ribbed structure of the wings.

The Federation's first combat experience against Son'a Battleships came in 2374, when two of them attacked the *U.S.S. Enterprise* NCC-1701-E in the Briar Patch. One of the cruisers fired an isolytic burst, forcing the *Enterprise* to eject its warp core, before the Starfleet vessel destroyed one battleship and damaged the other.



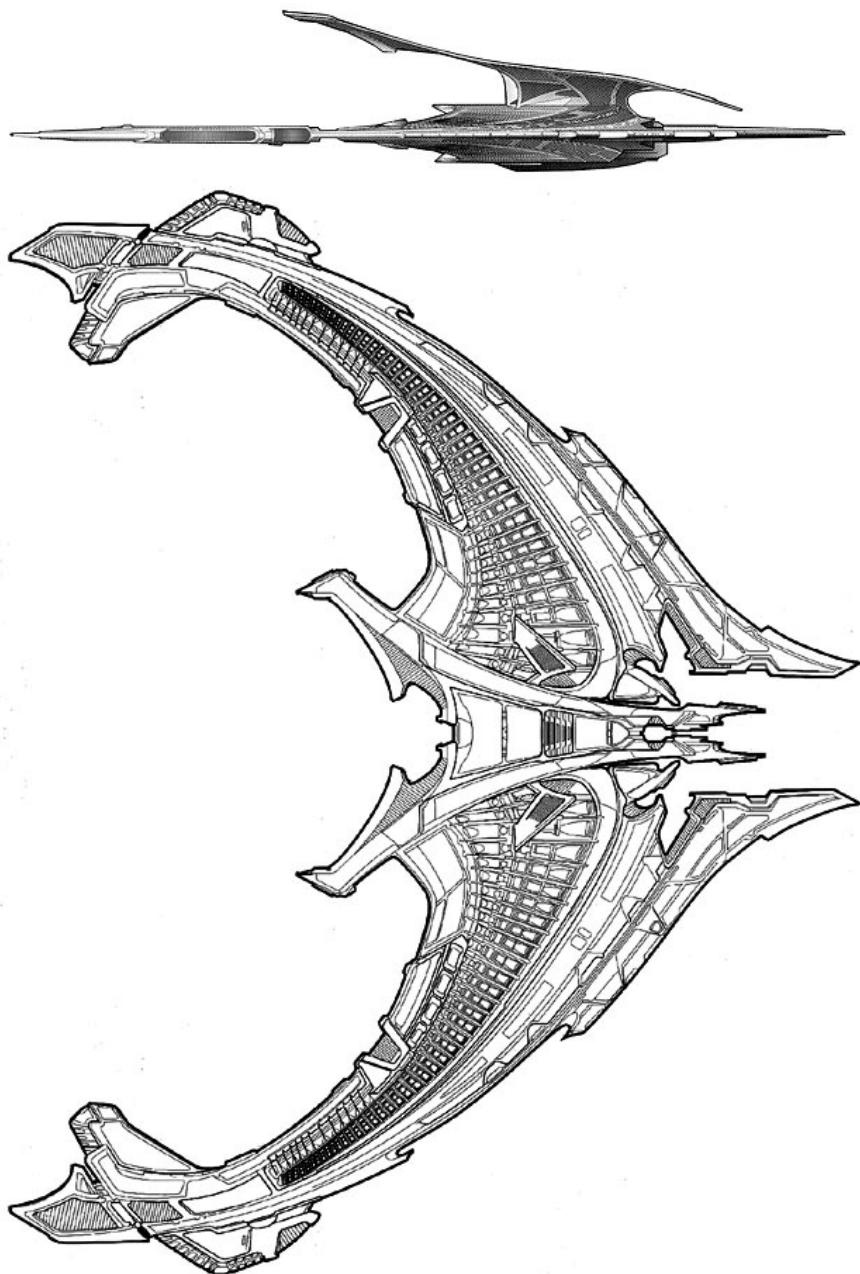

SON'A COMMAND SHIP

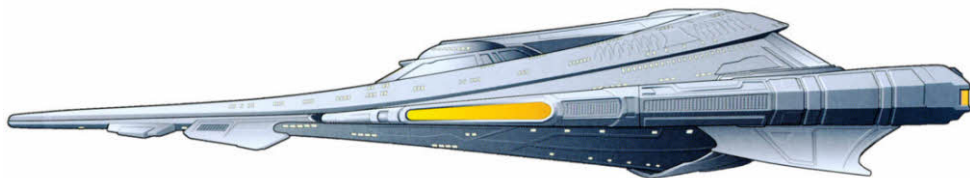

Class: Unknown
Type: Command Ship
First Encountered: 2375
Production Base: Unknown
Length: 354 metres
Beam: 276 metres
Height: 64 metres
Mass: 2,142,000 metric tons

Crew: 100
Cruising Speed: Warp 8
Maximum Speed: Warp 9.6
Armament: 8 Phaser banks,
2 photon torpedo launchers,
1 isolytic burst weapon

Known Ships
(Name Unknown)

CLASS INFORMATION:

The Son'a Command Ship was a medium-sized starship utilized by the Son'a during the late-24th century. It was sometimes designated as a destroyer.

These vessels were equipped with conventional phasers and torpedo launchers (located between the curving wings at the front of the ship), as well as an isolytic subspace burst weapon. The aft cargo hold was poorly shielded from the effects of thermolytic reactions, however. The warp nacelles were housed in the wing sections, with the impulse engines in the tips of the horns at the aft end of the vessel. Son'a Command Ships had subspace transmitter stations on deck twelve.

In 2375, Ahdar Ru'afo used one of these vessels as his flagship during his plan to relocate the Ba'ku from their adopted homeworld in the Briar Patch. Starfleet Vice Admiral Matthew Dougherty also stayed aboard this vessel while working with Ru'afo.



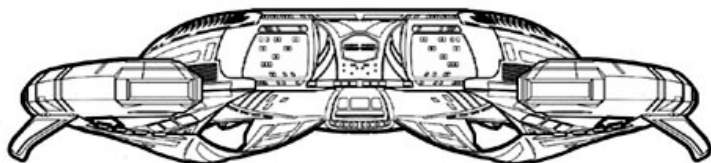
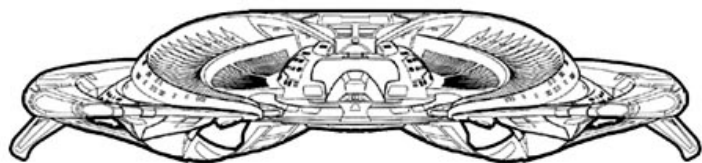
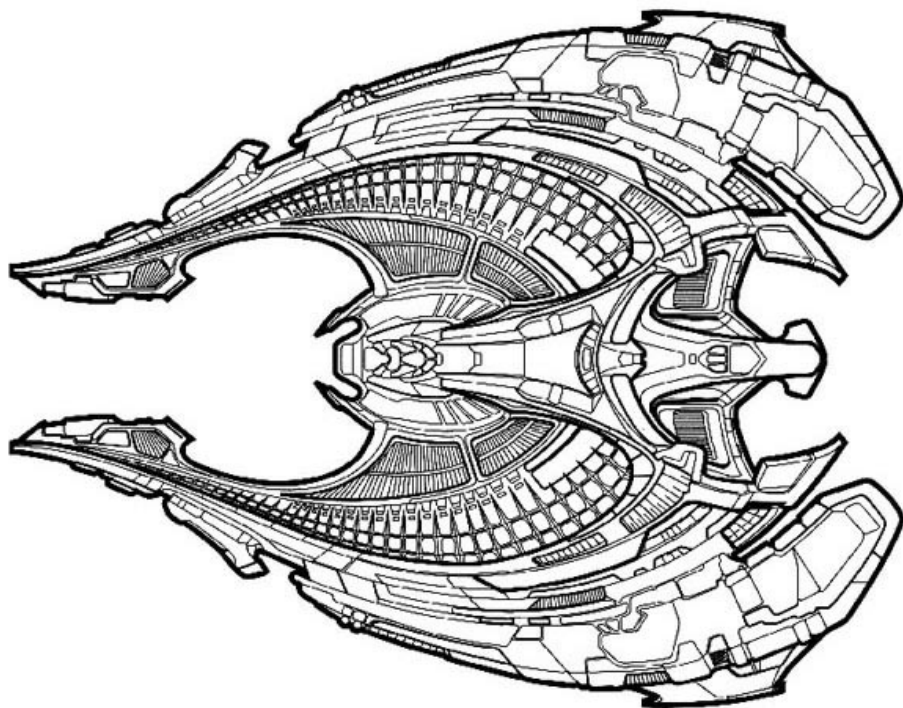
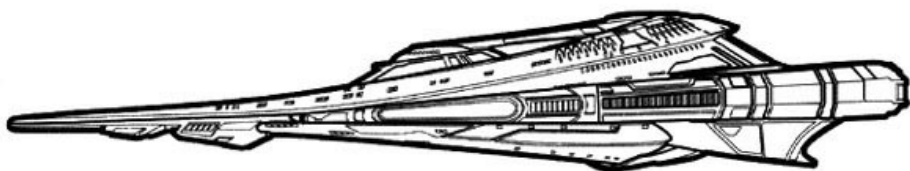

HIROGEN VENATIC CLASS



Class: Venatic
Type: Battleship
First Encountered: 2377
Production Base: Unknown, Delta Quadrant
Length: 600 metres
Beam: 247 metres
Height: 113 metres

Mass: Unknown
Crew: 15-20
Cruising Speed: Unknown
Maximum Speed: Unknown
Armament: Unknown

Known Ships
(Names unknown)

CLASS INFORMATION:

The *Venatic*-class was a type of hunting starship used by the Hirogen during the 2370s. This class of vessel, manned by a crew of fifteen or twenty, was considerably larger than both the Hirogen cruiser and the Federation *Intrepid*-class.

Like the smaller Hunter vessels, the *Venatic*-class was equipped with a subnucleonic beam, monotanium armour plating, and its engines - featuring a quad nacelle design - could be operated in stealth mode. However, the *Venatic*-class had a major flaw in its sensor system: the engines created a blind spot aft of the ship, where smaller vessels could hide and avoid sensor detection by the hunters.

In 2377, the *U.S.S. Voyager* NCC-74656 exploited the sensor weakness to secretly follow two *Venatic*-class ships. These vessels pursued a third ship crewed by Hirogen prey holograms into a nebula and were later disabled by *Voyager*.



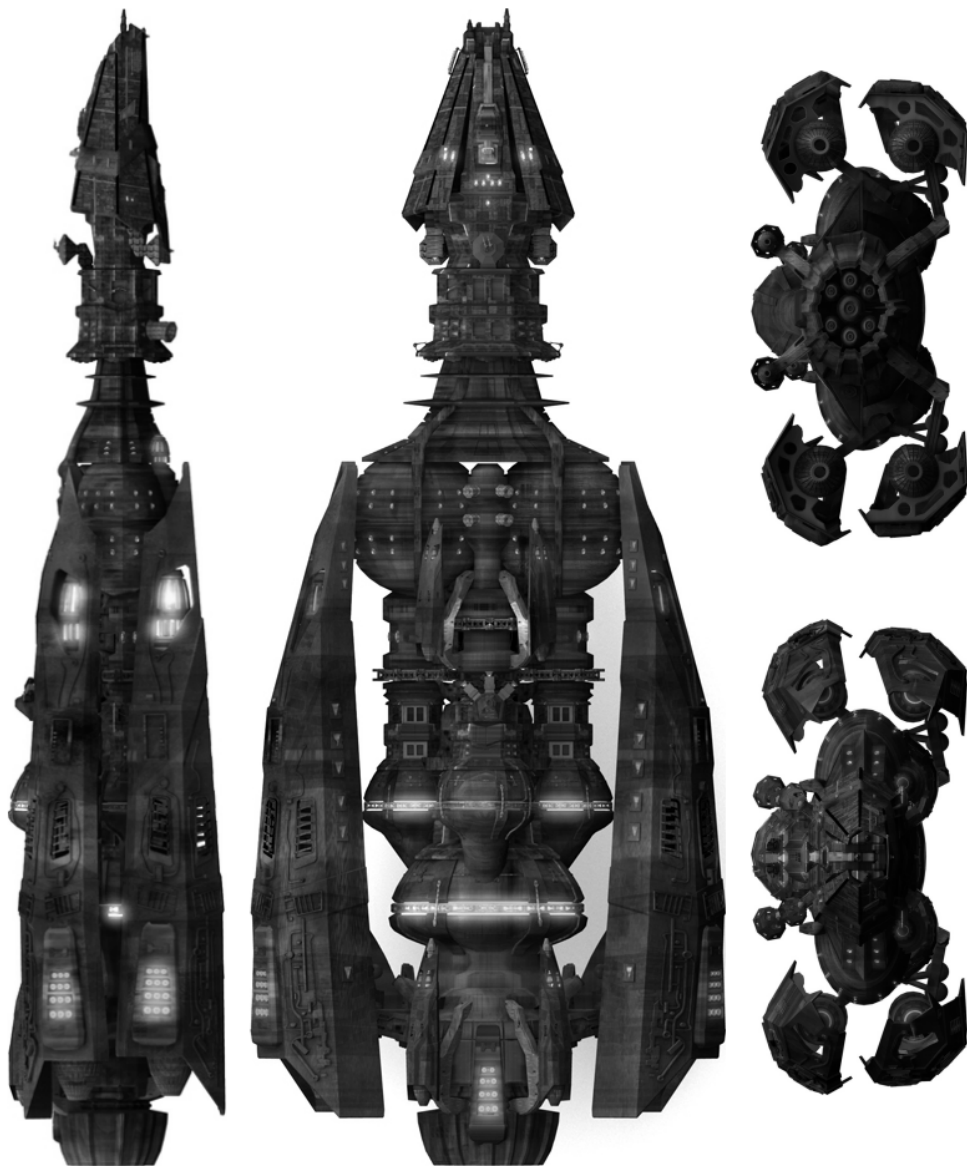

VIDIIAN CRUISER



Class: Unknown

Type: Cruiser

First Encountered: 2371

Production Base: Vidiia Prime,
Vidiiian Sodaloty

Length: 500 metres

Beam: 458 metres

Height: 95 metres

Mass: Unknown

Crew: 350

Cruising Speed: Unknown

Maximum Speed: Unknown

Armament: Hypothermic
charges

Known Ships

Names unknown

CLASS INFORMATION:

The Vidiiian cruiser was a large and heavily armed starship used by the Vidiiians in 2371 and 2372. This class of vessel operated with a crew of well over 300, and was armed with hypothermic charges. As the Vidiiians did not have transporter technology, the cruiser was equipped with extendable grapplers and cutters to board enemy vessels.

In 2372, the *U.S.S. Voyager* NCC-74656 was attacked by a Vidiiian cruiser while trapped in a plasma drift. At the time, a subspace divergence field had created a duplicate of *Voyager*, which was unseen to the Vidiiians. The Vidiiians attacked one of the two ships and destroyed its weapons array, before manoeuvring into grappling range and boring an access route through *Voyager's* hull. *Voyager* was then boarded by over 347 Vidiiians. Captain Kathryn Janeway auto-destructed *Voyager* to destroy the Vidiiian ship, allowing the other *Voyager* to escape unharmed.



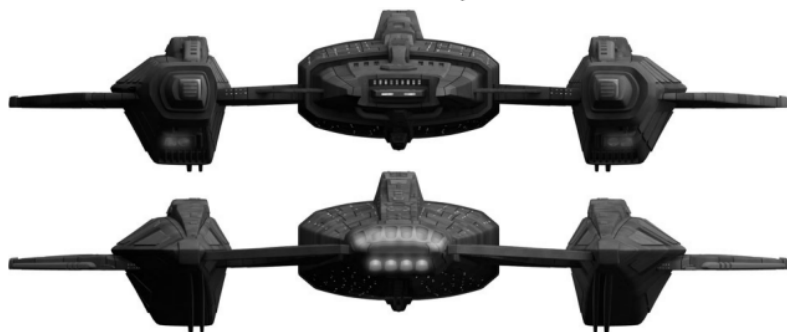
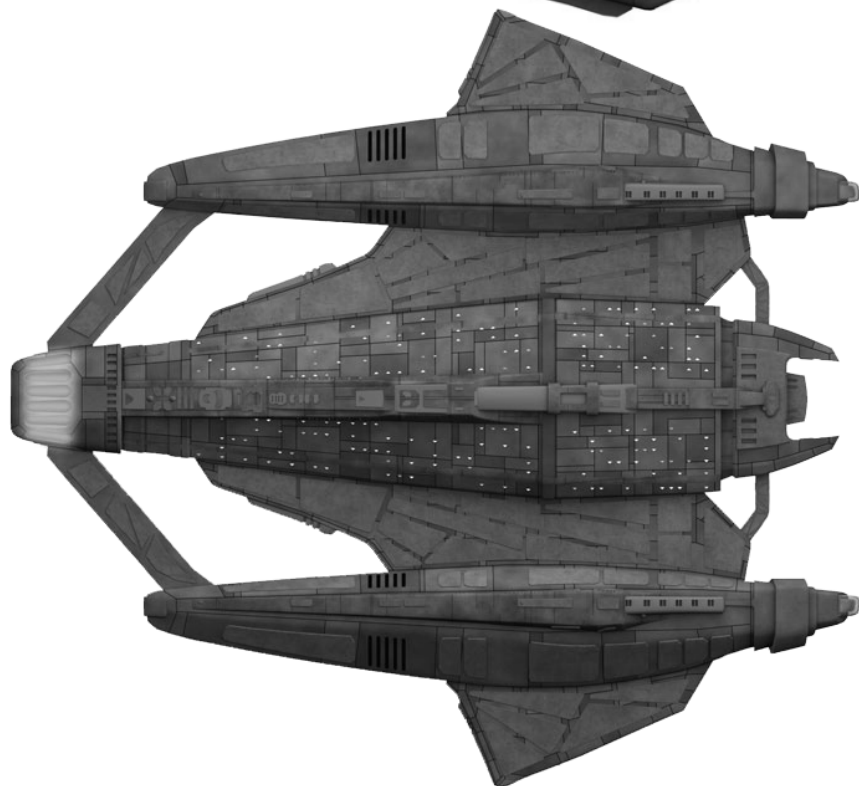

VOTH CITY SHIP

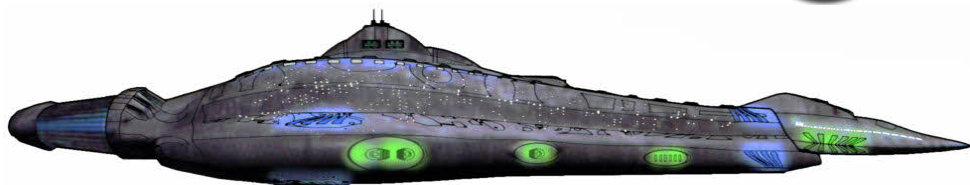

Class: Unknown
Type: City Ship
First Encountered: 2373
Production Base: Unknown
Length: 9,800 metres
Beam: 5,123 metres
Height: 1,840 metres
Mass: Unknown

Crew: Unknown
Cruising Speed: Unknown
Maximum Speed: Unknown
(Transwarp)
Armament: Unknown

Known Ships
(Name Unknown)

CLASS INFORMATION:

Essentially a mobile planet, the Voth city ship is a massive transwarp-capable starship that serves as the centre of the Voth civilization. It is one of the largest known vessels in the galaxy, over three times the length of a Borg cube.

This technologically advanced ship is equipped with high resolution scanners with a range of over ninety light years. The Voth also possess spatial displacement capabilities – a form of cloaking technology that can move their starships or even individuals out of phase.

In 2373 the Voth city ship located and captured the *U.S.S. Voyager* NCC-74656 - beaming the Federation starship into a vast chamber inside the vessel. A dampening field within the city ship made *Voyager's* main power inoperative, and rendered tricorders, communicators, and phasers useless.



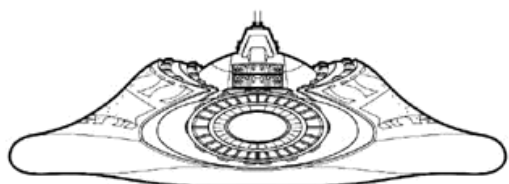
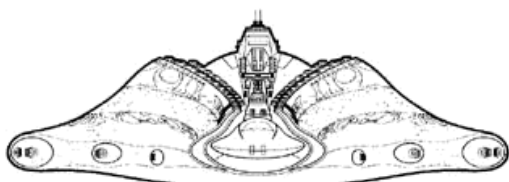
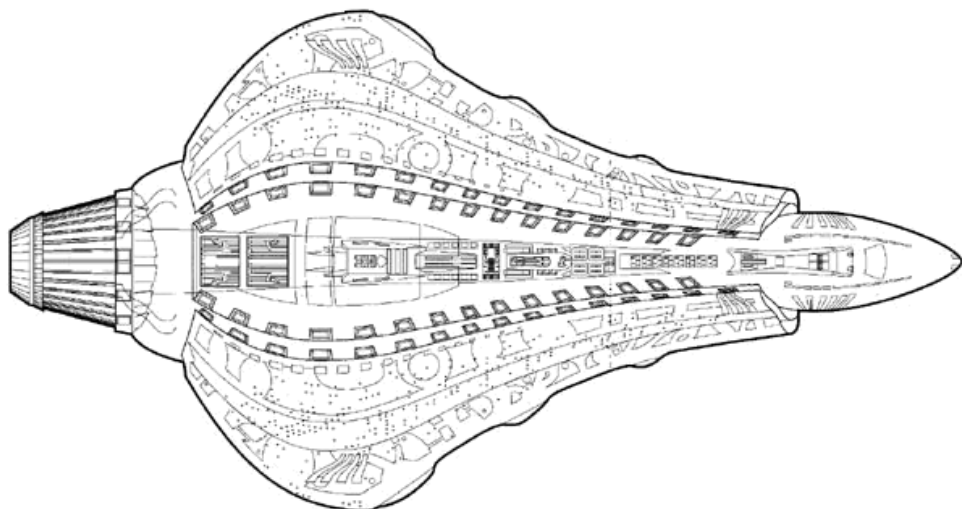
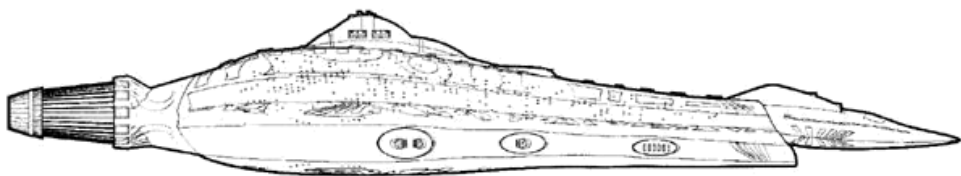

SIZE COMPARISON



0 1000m 2000m 3000m

Voth City Ship: 9,800m

Son'a Battleship: 837m

0 100m 200m 300m



Hirogen Venatic: 600m



Vidlian Cruiser: 500m



Son'a command ship: 354m



Whorfin: 270m



Holoship: 247m



Ptolemy: 222m



Conestoga: 180m



TPau: 170m

Phoenix: 27m



T'Polana Hath: 45m



Maquis raider: 60m



Tug: 66m



DY-100: 108m

0 5m 10m 15m



NX prototype: 20m



Travel pod: 4.4m



Inspection pod: 3.3m



Work bee: 3.2m

BIBLIOGRAPHY

BOOKS, MAGAZINES & EBOOKS

Decipher Starships Sourcebook - *by Bridges et al*
Mr. Scott's Guide to the Enterprise - *by Shane Johnson*
Spacedock Ship Recognition Manual - *by Stephen S. Long*
Starship Recognition Manual Beta - *by Robert Hamilton III*
Starship Spotter - *by Adam Lebowitz & Rob Bonchune*
Star Trek Chronology - *by Michael Okuda & Denise Okuda*
Star Trek Encyclopedia - *by Michael Okuda, Denise Okuda & Debbie Mirek*
Star Trek Fact Files & Star Trek: The Magazine
Star Trek Ships of the Line - *by Doug Drexler & Michael Okuda*
Star Trek Star Charts - *by Geoffrey Mandel*
ST:DS9 Technical Manual - *by Herman Zimmerman, Doug Drexler & Rick Sternbach*
ST:TNG Technical Manual - *by Rick Sternbach & Michael Okuda*

WEBSITES

[Daystrom Institute Technical Library](#)
[Drex Files](#)
[Eavesdropping with Johnny](#)
[Ex Astris Scientia](#)
[Memory Alpha](#)
[Memory Beta](#)
[Neutral Zone Starship Database](#)
[Starship Schematic Database](#)
[Star Trek LCARS Blueprints Database](#)
[ST Starship Tactical Combat Simulator Online Database](#)
[Titan Fleet Yards](#)
[Trekmania](#)
[Trekplace](#)

IMAGE SOURCES

Colour side-views from Ex Astris Scientia.
Emblems from Ex Astris Scientia and Star Trek Minutiae.
CONESTOGA - *Designed by John Eaves*
Page 2: L - Drex Files, R - DITL.org,
Page 23: Schematics - Sven Lindemann
DY-100 CLASS - *Designed by Matt Jefferies*
Page 4: L - Neutral Zone.de, R - Drex Files,
Page 5: Schematics - Phil Broad
NX PROTOTYPE - *Designed by John Eaves*
Page 6: L - DITL.org, R - DITL.org,
Page 7: Schematics - Neutral Zone.de
PHOENIX -
Page 8: L - Neutral Zone.de, R - Ex Astris Scientia,
Page 9: Schematics - Starship Schematic Database
HOLOSHIP - *Designed by John Eaves*
Page 10: L - Neutral Zone.de, R - Neutral Zone.de,
Page 11: Schematics - Starship Schematic Database

PTOLEMY CLASS - *Designed by Franz Joseph*
Page 12: L - Doug Drexler, R - Trekmania,
Page 13: Schematics - Vance
FEDERATION TUG -
Page 14: L - Neutral Zone.de, R - Doug Drexler,
Page 15: Schematics - Starship Schematic Database
WHORFIN CLASS -
Page 16: L - Memory Alpha, R - Memory Alpha,
Page 17: Schematics - Star Trek Fact Files
INSPECTION POD - *Designed by John Eaves*
Page 18: L - Memory Alpha, R - Neutral Zone.de,
Page 19: Schematics - Ex Astris Scientia
TRAVEL POD - *Designed by Andrew Probert*
Page 20: L - The Art of Star Trek, R - DITL.org,
Page 21: Schematics - Starship Schematic Database
WORK BEE - *Designed by Andrew Probert*
Page 22: L - Doug Drexler, R - Memory Alpha,
Page 23: Schematics - Starship Schematic Database
MAQUIS RAIDER -
Page 24: L - Neutral Zone.de, R - Memory Alpha,
Page 25: Schematics - Adam Heinbuch
VULCAN APOLLO CLASS -
Page 26: L - ST:TNG Continuing Mission, R - Neutral Zone.de,
Page 27: Schematics - Star Trek Fact Files
VULCAN T'PLANA HATH CLASS - *Designed by John Eaves*
Page 28: L - Memory Alpha, R - Neutral Zone.de,
Page 29: Schematics - Starship Schematic Database
SON'A BATTLESHIP - *Designed by John Eaves*
Page 30: L - DITL.org, R - Memory Alpha,
Page 31: Schematics - Neutral Zone.de
SON'A COMMAND SHIP - *Designed by John Eaves*
Page 32: L - DITL.org, R - Neutral Zone.de,
Page 33: Schematics - Star Trek Fact Files
HIROGEN VENATIC CLASS - *Designed by Rick Sternbach*
Page 34: L - Neutral Zone.de, R - Star Trek Fact Files,
Page 35: Schematics - Doug Drexler
VIDIIAN CRUISER - *Designed by Rick Sternbach*
Page 36: L - Neutral Zone.de, R - Memory Alpha,
Page 37: Schematics - Doug Drexler
VOTH CITY SHIP -
Page 38: L - Ex Astris Scientia, R - Memory Alpha,
Page 39: Schematics - Starship Schematic Database
SIZE COMPARISON CHART - Page 40: Adapted from the
Fleet Charts of Bernd Schneider (Ex Astris Scientia).

Created with Serif PagePlus software. This ebook was produced purely for reference and fun, on a non-profit, not-for-sale basis. All copyrights are acknowledged and no infringement is intended. Star Trek and all photos, symbols and designs copyright Paramount Pictures as far as I am aware.

This document © Mark Gill 2009.



trek.escape-committee.co.uk