

Issue 25: 2291 - 2292

# STARFLY PROTOTYPE

The Journal of Innovative Design and Ideas

# STARFLEET PROTOTYPE

a joint publication of  
**Starfleet Tactical**  
and  
**Strategic Design**

**PROTOTYPE** is a bi-annual journal, established to familiarize Starfleet and other Federation military personnel with the latest starship designs and technical developments. Due to the sensitive nature of the technical matters discussed herein, extreme caution must be exercised in the distribution and handling of this publication, and the material within has been ruled Security Grade 2B\*8.

Letters and questions to the editors should be forwarded to Strategic Design, Spacedock Terra.

Typesetting and Graphics provided by Dynamic Designs and Publications, Terra.

Copyright © 2292 by the Starfleet Academy Training Command Press in conjunction with the Technical Release Office of Starfleet Tactical and the Distribution Element of Strategic Design (a civilian design and consultation firm contracted to the Research and Development division of the Starfleet Corps of Engineers). All rights reserved.

Two vessels included herein, and other vessels referred to in passing, have appeared previously in the volume: Ships of the Star Fleet. Their inclusion in this journal is not intended as infringement of copyright in any way, but rather is done in the interest of maintaining continuity. All artwork included herein is original.

To Janet



# In This Issue...

## In This Issue...

### Masthead

### Terminology

- Definitions.....	4
- Classifications	
- Performance.....	5
- Definitions & Tables	

### New From the Yards...

#### Cruisers:

- U.S.S. Enterprise - CH 1701A Class Heavy Cruiser.....	8
- U.S.S. Starstalker - CP 2117 Class Patrol Cruiser.....	12
- U.S.S. Ranger - CL 2700 Class Light Cruiser.....	16
- U.S.S. Thruyton - CT 2761 Class Tactical Cruiser.....	20
- U.S.S. S'Harien - CG 3107 Class Battlecruiser.....	24

#### Frigates:

- U.S.S. Pharris - FS 3537 Class Strategic Frigate.....	30
- U.S.S. Adamant - DNF 3029 Class Dreadnought.....	34

#### Escorts:

- U.S.S. Dupleix - PA 2346 Class Perimeter Action Ship.....	40
- U.S.S. Scimitar - DF 2901 Class Fast Destroyer.....	44
- U.S.S. Phantom - SS 2951 Class Superscout.....	48
- U.S.S. Davenport - CV 2635 Class Corvette.....	52

#### Auxiliaries:

- U.S.S. Schmidt - TT 800 Class Tug.....	58
- U.S.S. Archangel - SC 2294 Class Shuttlecarrier.....	60
- Design Philosophy & Purpose	
- Shakedown Trials	
- Vessel Specifications & Related Data	
- Performance Characteristics (Static)	
- Performance Characteristics (Dynamic)	
- Front, Plan, & Profile Views	

## In the Design Tank...

- U.S.S. Constellation- *CN 1017 Class Star Cruiser*..... 66
  - Design Philosophy & Purpose
  - Mission Objectives
  - Vessel Specifications & Related Data
  - Predicted Performance Characteristics (Static)
  - Front View

## TacFleet Review...

- U.S.S. Ascension - *DN 2520 Class Dreadnought*.....70
- U.S.S. Belknap - *CS 2501 Class Strike Cruiser*.....71
- U.S.S. Athabaska - *CE 2560 Class Exploratory Cruiser*.....72
- U.S.S. Menahga - *CG 3100 Class Battlecruiser*.....73
- U.S.S. Avenger - *FH 1860 Class Heavy Frigate*.....74
- U.S.S. Knox - *FR 1940 Class Frigate*.....75
- U.S.S. Monoceros - *ST 601 Class Scout*.....76
- U.S.S. Siva - *DD 520 Class Destroyer*.....77
- U.S.S. Gagarin - *SV 630 Class Survey Vessel*.....78
- U.S.S. Greer - *CR 472 Class Corsair*.....78
- U.S.S. Clarke - *CP 100 Class Clipper*.....79
- U.S.S. Asmodeus - *CVL 200 Class Light Corvette*.....79

## Tactical Section

- *Tactical Starbases*.....82
  - Purpose
  - Approach/Departure Protocols
  - How Do You Hide a Starbase?
  - How will the proposed Klingon/Federation Treaty Affect Them?
- *Ordnance Updates*.....84
  - Fine-tuning Phaser Harmonics Performance
- *Transwarp - Converting the Class I-b Fleet*.....86
  - Development, Theory & Implementation
  - Effect on the Subspace Field
  - Results

## Appendix

- *About the Design Team*.....90
- *Cathedral Unit*.....91

# Masthead

## CHIEF EDITOR/PUBLISHER

Capt. David Schmidt  
Strategic Design

## STRATEGIC EDITOR

Capt. Roger Wright  
Starfleet Command

## TECHNICAL EDITOR

Capt. David Desjardins  
Starfleet Operations

## EXECUTIVE EDITOR

Lt.Cmdr. Janet Reeves  
Starfleet Logistics

## PRODUCTION EDITOR

Brian Oberquell  
Starfleet Oversight Committee  
**ENGINEERING CONSULTANT**

Capt. Kevin Atkinson

Starfleet Corps of Engineers

## SYSTEMS ANALYST

R.Adm. Robert Day  
Starfleet Research & Development

## NAVAL LIAISON

Adm. Lisa Murata  
Starfleet Tactical



# Definitions

## Classifications

### Equipment

With regard to the Incorporated Systems, it is important to note that all vessels included herein are prototypes, and as such were built in Starfleet's Orbital Construction Yards (Supra-Tokyo, -San Francisco, and -Polyarnyy) by the Starfleet Corps of Engineers. As such, the systems incorporated into them were ones Starfleet Logistics has acquired in bulk purchases - and are reasonably similar from vessel to vessel - with little in the way of variety. As each Class goes into production, tenders for construction of the various starships comprising each will be let, and the independent ship-building companies will in all likelihood incorporate systems of different model and manufacturer (but parallel design and capability) into each. The end result will be that no two *Phantom* class Superscouts will be exactly identical, although each must meet or exceed the preset contract performance specifications.

### Classification Levels

Starships are divided into different, hierarchical levels of Classification:

- Level 1: Design
- Level 2: Type
- Level 3: Class

### Design & Type

There are three basic Designs, each divided into a number of Types:

#### Cruiser-Design

Dreadnought  
Heavy Cruiser  
Strike Cruiser  
Battlecruiser  
Through-Deck Cruiser  
Exploratory Cruiser  
Cruiser  
Light Cruiser  
Tactical Cruiser  
Patrol Cruiser

#### Frigate-Design

Dreadnought-Frigate  
Heavy Frigate  
Frigate  
Fast Frigate  
Small Frigate  
Strategic Frigate

#### Escort-Design

Heavy Destroyer  
Destroyer  
Fast Destroyer  
Super Destroyer  
Scout  
Superscout  
Perimeter Action Ship  
Corvette  
Clipper  
Corsair

### Class

Each Type is further divided into Classes. For example the Superscout-Type is comprised of 56 vessels, subdivided into four different Classes, each named for the first vessel (Prototype) constructed of that Class:

#### Superscout-Type - 56 Vessels

Mark 17b *Kruger* class (13 vessels)  
Mark 19b *Reliance* class (18 vessels)  
Mark 23b *Austin* class (11 vessels)  
Mark 26b *Ianetos* class (13 vessels)  
Mark 30b *Kestral* class (4 vessels)

The reason for the multiple Classes is simple. In the case of the Superscout Type, the 14th vessel of the *Kruger* class (U.S.S. *Reliance*) was scheduled for construction when Starfleet decided to try some alterations in the design. Accordingly the vessel was constructed in the Supra-San Francisco Orbital Yards instead of a private contractor's. The modifications proved to be valuable enough that future Superscouts would incorporate them as well - and so U.S.S. *Reliance* became the first ship of the *Reliance* class rather than the fourteenth ship of the *Kruger* class.

### Classification Codes

When referring to various ships by registration number, a Classification Code is usually utilized rather than the acronym NCC (Naval Construction Contract). Thus, the U.S.S. *Enterprise* is also referred to as CH 1701A. In this system, basic classification is signified by two letters - the first defines the design, and the second the type. Additional letters are utilized to modify the two-letter code. The suffix X or T define an Experimental or Training vessel respectively (Shortly before her destruction, *Enterprise* was designated CHT1701). The letter K designates a large variation of a standard design (eg: PKA), and the letter L a small (Light) variation (eg: CVL).

#### Cruisers

DN Dreadnought-Cruiser  
CH Heavy Cruiser  
CS Strike Cruiser  
CG Battlecruiser  
CD Through-Deck Cruiser  
CE Exploratory Cruiser  
CA Cruiser  
CL Light Cruiser  
CT Tactical Cruiser  
CP Patrol Cruiser

#### Escorts

DH Heavy Destroyer  
DD Destroyer  
DF Fast Destroyer  
DS Super Destroyer  
ST Scout  
SS Superscout  
PA Perimeter Action Ship  
CV Corvette  
CP Clipper  
CR Corsair

#### Frigates

DNF Dreadnought-Frigate  
FH Heavy Frigate  
FR Frigate  
FF Fast Frigate  
FS Small Frigate  
FT Strategic Frigate

#### Auxiliaries

SM Medical Ship  
TR Transport  
TT Transport/Tug  
TE Tender  
SP Combat Support Ship  
SC Shuttlecarrier

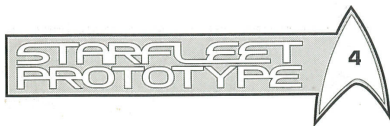

## Enterprise-Class Heavy Cruiser

### Performance Characteristics (Static):

Warp Dynamic Efficiency:	Power Coefficient Indice	1.003
Powerplant:	Maximum Output	$2.4 \times 10^{15}$
	Optimum Output	$1.9 \times 10^{15}$
Subspace Field:	Field Strength	$3.2 \times 10^8$
	Field Threshold	$1.0 \times 10^{10}$
	Field Persistence	8.0
	Field Radius	427.0
	Field Capacity	350,000

### Performance Characteristics (Dynamic):

Structural Strain Parameters:	Differential Stress (Prime)	$1.60 \times 10^7$
	Differential Stress (Beta)	$4.4 \times 10^6$
	Differential Stress (Gamma)	$2.8 \times 10^6$
	Differential Stress (Delta)	$1.4 \times 10^6$
Warpspeed Handling:	Warp Acceleration Rate	2.9
	Warp Deceleration Rate	1.6
	Warp Attitude Change Rate	0.417
Sublight Handling:	Impulse Acceleration Rate	3.7
	Impulse Deceleration Rate	4.2
	Impulse Attitude Change Rate	0.268
Speed Performance:	Cruising Speed	wf8.0
	Flank Speed	wf10.2
	Emergency Maximum Speed	wf12.0

# Performance Definitions & Tables

Included in each prototype starship file is a Performance Characteristics Table. A sample of this is shown to the immediate left. Said table is composed of data from the prototype's shakedown trials, with both static and dynamic test data included. The sample table shows the performance data from the shake-down trial of the U.S.S. *Enterprise* NCC-1701A - the first of the Transwarp-capable Class 1-b starships. The section below explains details on the Performance Characteristics Table, including such items as Term Definition, Term Symbol, and Term Measurement Units.

Symbol	Term	Units	Definition of Term
PCI	Power Coefficient Indice	0.1 Petajoules/second	Number of Joules/second required to operate warp drive at a given warp factor. 1 PCI delivers wf1.0, 2 PCI delivers wf2.0, etc.
Ssf	Subspace Field Strength	Cochranes	Inherent energy stored in static subspace field (wf0.0).
Tsf	Subspace Field Threshold	Joules/second	Minimum energy required to generate static subspace field (wf0.0).
Psf	Subspace Field Persistence	Seconds	Time from energy cut-off to subspace field collapse and warp dump.
Rsf	Subspace Field Radius	Meters	Distance from vessel center of mass to subspace field boundary.
Csf	Subspace Field Capacity	Metric Tonnes	Maximum vessel/load mass actionable by field (wf5.0).
ds <sub>a</sub>	Differential Stress (Prime)	Dynes	Strain placed on integrity field by vessel travelling at wf5.0.
ds <sub>b</sub>	Differential Stress (Beta)	Dynes	Strain placed on integrity field by veering 1° at wf 5.0.
ds <sub>c</sub>	Differential Stress (Gamma)	Dynes	Strain placed on integrity field by vessel accelerating from rest to wf5.0.
ds <sub>d</sub>	Differential Stress (Delta)	Dynes	Strain placed on integrity field by vessel decelerating from wf5.0 to rest.
+Δδwf	Warp Acceleration Rate	Seconds	Time to increase speed by 1 wf interger (eg: wf3.0 to wf4.0).
-Δδwf	Warp Deceleration Rate	Seconds	Time to decrease speed by 1 wf interger (eg: wf4.0 to wf3.0).
δ/wf	Warp Attitude Change Rate	Seconds/ Degree	Time to veer 1° in pitch, roll, or yaw at wf5.0.
+Δδi	Impulse Acceleration Rate	Seconds	Time to increase speed by 0.1 C (eg: 0.6 C to 0.7 C).
-Δδi	Impulse Deceleration Rate	Seconds	Time to decrease speed by 0.1 C (eg: 0.6 C to 0.7 C).
δ/i	Impulse Attitude Change Rate	Seconds/Degree	Time to veer 1° in pitch, roll, or yaw at sublight speeds using maneuvering thrusters.
Cwf	Cruising Speed	Warp Factor	Highest speed attainable at optimax powerplant output - maintainable for extended time.
Fwf	Flank Speed	Warp Factor	Highest speed which causes minor structural strain - tolerable for up to 72 hours.
Ewf	Emergency Maximum Speed	Warp Factor	Highest speed which causes moderate structural strain, coupled to maximum powerplant output, sustainable for 2-3 hours, followed by mandatory refit.



STARFLEET  
PROTOTYPE

6

# **New from the Yards...**

## **Cruisers:**



# U.S.S. *Enterprise*

## CH 1701A Class Heavy Cruiser

"This starship may look familiar, but any resemblance to the old Enterprise (CH 1701) class is only skin deep."

### **Enterprise (CH 1701A) class Heavy Cruiser**

#### **History, Design Philosophy & Purpose:**

In 2250, after twenty years of successful operation by the *Korolev* (CE 367) class Cruiser, Starfleet decided that a larger variant was desired, said new class to be the mainstay of the Galaxy Exploration fleet. A large saucer-like primary hull was married to a cylindrical secondary hull and two warp drive units, and in 2260 the designers unveiled the *Constitution* (CH 1700) class Heavy Cruiser - the first design of the newborn Class 1 Starships.

The *Constitution* class marked the beginning of a new era. It could do everything the *Korolev* class could do, and do it better. From a vaguely-defined "larger *Korolev*", the Heavy Cruiser developed into its own, becoming the new standard in space vessels. Although eventually the Heavy Cruiser was joined by several other Class 1 designs (such as Frigates, Scouts, Cruisers etc.), the CH 1700 class was always the most successful. In the following 14 years, 150 Heavy Cruisers were constructed.

Six years later, there were some sixteen Class 1 designs, and all 97 surviving *Constitution* class Heavy Cruisers had been converted/refitted to the *Enterprise* (CH 1701) class configuration. These newly revitalized vessels served well as the workhorses of the Fleet until 2285, when Starfleet reluctantly began decommissioning and scrapping them as a class. Periodic inspections during overhauls had shown that, after 20+

years of service, being repeatedly called upon to operate under conditions which exceeded their design tolerances, the entire class had aged irreparably. Although the onboard systems (including weapons, computers and powerplant/propulsion) were less than ten years old, the structural members were simply no longer up to spec. Frames had warped, stanchions buckled, and hull plates were pitted and brittle.

Much of the Heavy Cruiser's original mandate had by this time been taken-up by the newer types, such as the *Belknap* (CS 2501) class Strike Cruiser. Never-the-less, in anticipation of the *Constitution* class fleet's retirement, Starfleet Galaxy Exploration Command had in 2284 begun a study to design a new starship class to replace it. The new class would be designed from the keel outwards "...to boldly go where no man has gone before." After some five designs were put forth and rejected, Starfleet rather sheepishly agreed that the ideal vessel for Galaxy Exploration was the *Enterprise* class. Since the extant CH 1701 class vessels had reached senescence, the proposed redesigning it from scratch - retaining the Warp Dynamic layout, but incorporating all of the newest onboard systems which had been developed in the 4 years since the last Heavy Cruiser had last been refitted. Said systems include the sensor suite, the warp drive units, and the BLAC-3 control & peripheral console system, which is most

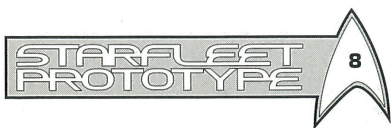

## Enterprise - Class Heavy Cruiser

### Vessel Specifications & Related Data

Prototype Name:	U.S.S. <i>Enterprise</i>
Construction Contract:	NCC-1701A
Series:	Class 1b Starship
Design:	Cruiser
Type:	Heavy Cruiser (CH)
Complement:	72 Officers 428 Enlisted Crewmen
Overall Length:	304.8 meters
Overall Draft:	71.3 meters
Overall Beam:	141.7 meters
Displacement:	200,000 tonnes

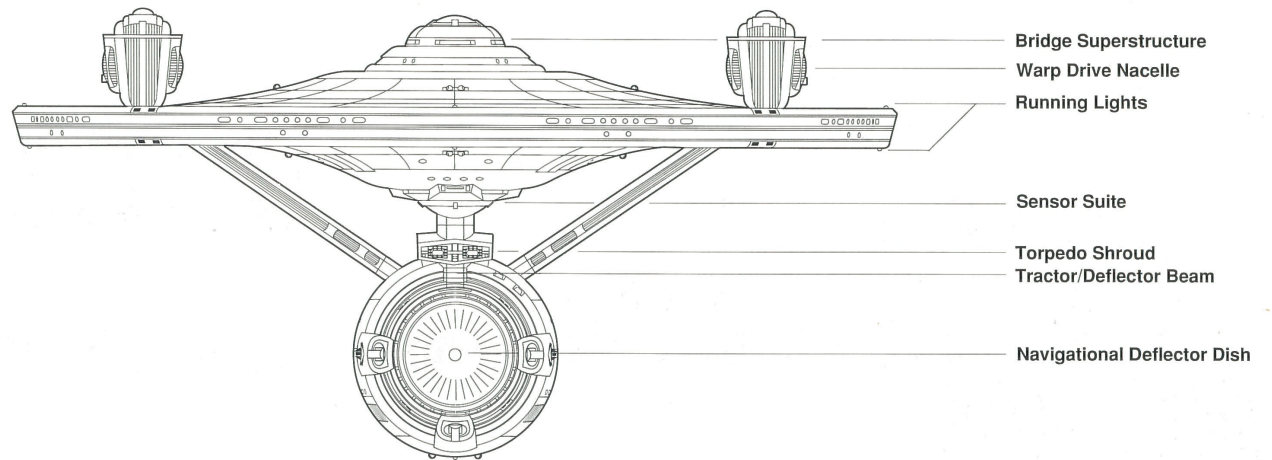

dramatically evidenced in the new Bridge layout. The original Enterprise was destroyed just prior to the prototype's launch, and her name and designation were inherited by the new ship.

### Shake-down Trials

Trial results proved exceptional with regards to performance. The CH 1701A has retained the CH 1701's unexcelled Warp Dynamics, but its Cruising-, Flank-, and Emergency Maximum-Speeds have actually been increased due to the pristine condition of the new structural members, coupled with the new warp drive units and powerplant. Maneuverability, range, and fire-power are also identical to the forerunner.

Onboard systems (power and propulsion excluded) did not deliver as well. From internal doors to turbolifts to environmental controls, onboard systems performance was at best "sporadic", causing the vessel's Admittance Trials Engineer to hypothesize that the ship "...was put together by monkeys." Originally thought to be various separate faults, the problems were eventually traced down to a common denominator - the main computer-peripheral interface. Following replacement of all interface modules the vessel passed her Admissions Trial and became the first ship in the newest Heavy Cruiser class.

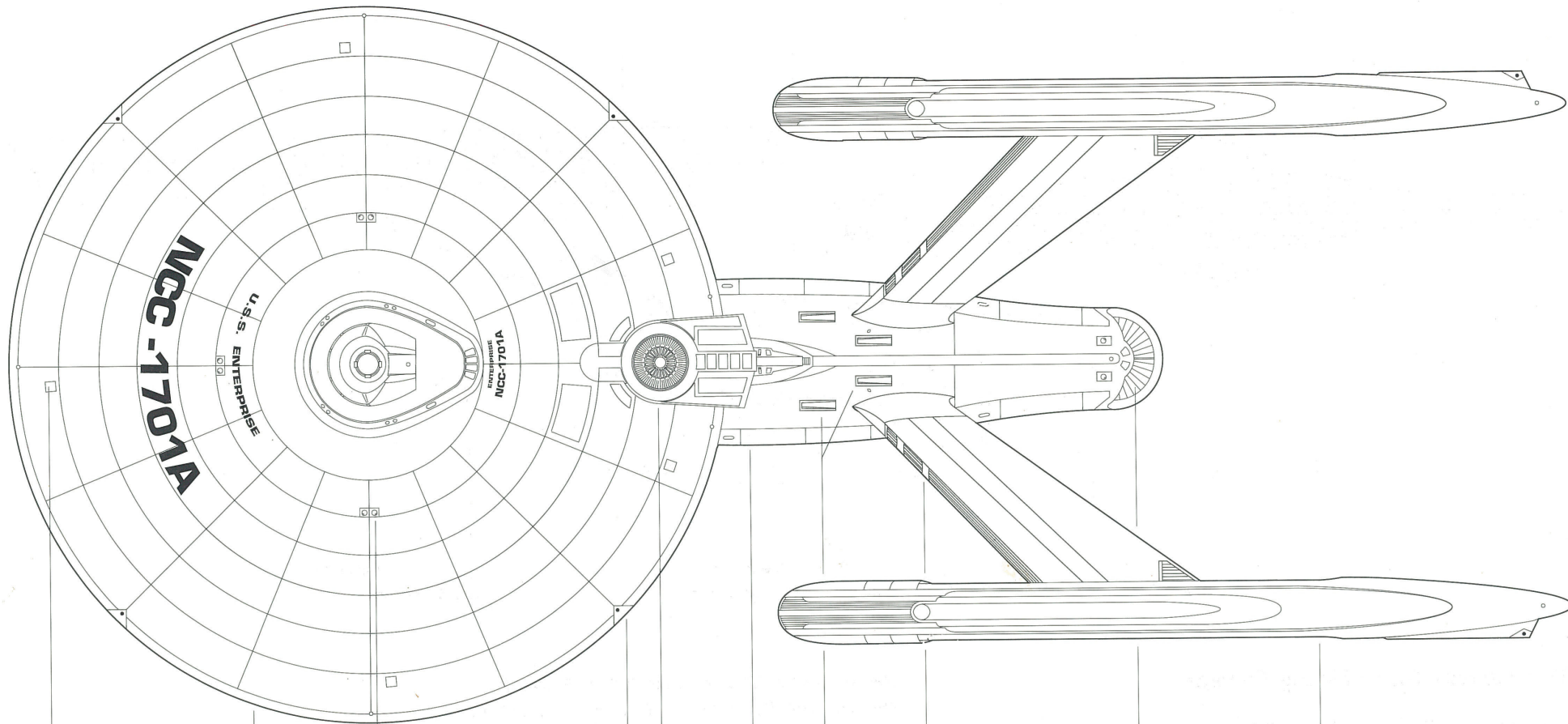

Personnel Hatch

Primary Hull

Phaser Bank

Impulse Drive  
Reaction Control Thruster Package

Thrusters

Secondary Hull

Nacelle Support Strut

Hangar Bay Doors

Warp Drive Nacelle

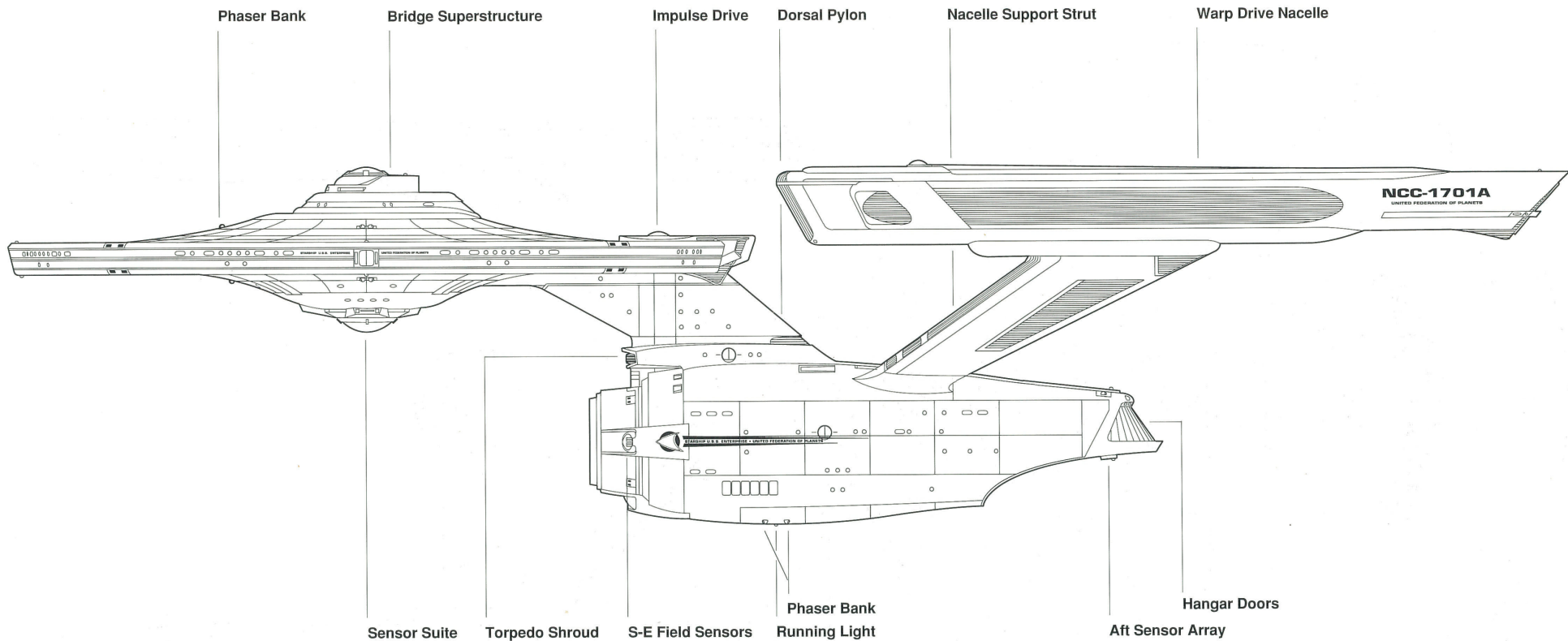

## Enterprise - Class Heavy Cruiser

### Performance Characteristics (Static):

Warp Dynamic Efficiency:	Power Coefficient Indice	1.003
Powerplant:	Maximum Output	$2.4 \times 10^{15}$
	Optimum Output	$1.9 \times 10^{15}$
Subspace Field:	Field Strength	$3.24 \times 10^8$
	Field Threshold	$1.0 \times 10^{10}$
	Field Persistence	8.0
	Field Radius	427.0
	Field Capacity	350,000

### Performance Characteristics (Dynamic):

Structural Strain Parameters:	Differential Stress (Prime)	$1.57 \times 10^7$
	Differential Stress (Beta)	$4.21 \times 10^6$
	Differential Stress (Gamma)	$2.65 \times 10^6$
	Differential Stress (Delta)	$1.28 \times 10^6$
Warp speed Handling:	Warp Acceleration Rate	2.78
	Warp Deceleration Rate	1.6
	Warp Attitude Change Rate	0.387
	Impulse Acceleration Rate	3.7
Sublight Handling:	Impulse Deceleration Rate	4.2
	Impulse Attitude Change Rate	0.268
	Cruising Speed	wf8.9
Speed Performance:	Flank Speed	wf12.3
	Emergency Maximum Speed	wf18.6

Starship

U.S.S. STARSTALKER

NCC-2117

# U.S.S. *Starstalker*

CP 2117 Class Patrol Cruiser

"...the Achilles Heel of the *Enterprise* class was its dependance upon the phaser bank...there was a need for a vessel whose weapons system was independant of available starship power."

## ***Starstalker* (CP 2117) class Patrol Cruiser History, Design Philosophy & Purpose:**

The fourth Cruiser-design prototyped this year was in fact the first Patrol Cruiser class ever developed. In 2269, following the successful completion of the U.S.S. *Enterprise's* third five-year mission, her Chief Engineer was transferred to the Design Division of the Starfleet Corps of Engineers. He took advantage of this opportunity to collate years of notes he had compiled on starship design theory, gathered about him a dedicated core of engineers, and set about the task of evolving the ideal fighting cruiser starship - from an Engineer's point of view.

According to Commander Scott, the Achilles Heel of the *Enterprise* (CH 1701) class (and every other starship of the time) was its dependance upon its primary weapons system: the phaser bank. Although much more flexible than the Mark 1 torpedo, the phaser had one potentially fatal flaw: its enormous energy consumption. A starship in fighting trim could put out megajoules of phased energy - but if its main reactor was disabled (or if the vessel was required to shift full power to propulsion or shields), the phaser and thus the entire ship was impotent. Scott saw the need for a vessel whose primary weapon system was independant of available starship power: the photon torpedo. Torpedoes require minimal ship's power to launch; they utilize onboard thrusters. Likewise their striking power is independant; being a product of their warhead's stored antimatter. Further

flexibility could be attained by adding multiple launch tubes, increasing fire-arcs and salvo rates.

Sixteen of the *Starstalker* (CP 2117) class were constructed in all, and served the newly-formed TacFleet with distinction. When the class was scheduled for conversion to Class 1b configuration this year, Strategic Design elected to upgrade the Patrol Cruiser's energy weapons with a pair of megaphaser cannon. They reasoned that just because a vessel can function without energy weapons doesn't mean that its Captain wouldn't like the option. Therefore cannon were mounted atop the extended hull - similar to the *Knox* (FF1940) class deployment.

The strong suit of the *Starstalker* class is survivability - testified to by the fourteen vessels still in service. In terms of ordnance, the *Starstalker* class has few equals (and with the addition of cannon, no superiors). Her secondary hull is decidedly unorthodox, even uncouth when compared to the *Enterprise* class' smoothly sculptured contours. Scott had noted that faceted hulls bore the brunt of torpedo implisions better than convex ones in case of shield failure. A shockwave striking a convex hull always impacts part of it directly broadside - maximizing kinetic energy absorbtion. The same shockwave striking a faceted hull has only a 23% chance of impacting a facet broadside, 77% of the time the shockwaves will be at

STARFLEET  
PROTOTYPE

12

## Starstalker - Class Patrol Cruiser

### Vessel Specifications & Related Data:

Prototype Name:	U.S.S. <i>Starstalker</i>
Construction Contract:	NCC-2117
Series:	Class 1b Starship
Design:	Cruiser
Type:	Patrol Cruiser (CP)
Complement:	80 Officers 445 Enlisted Crewmen
Overall Length:	307.6 meters
Overall Draft:	66.3 meters
Overall Beam:	141.7 meters
Displacement:	218,000 tonnes

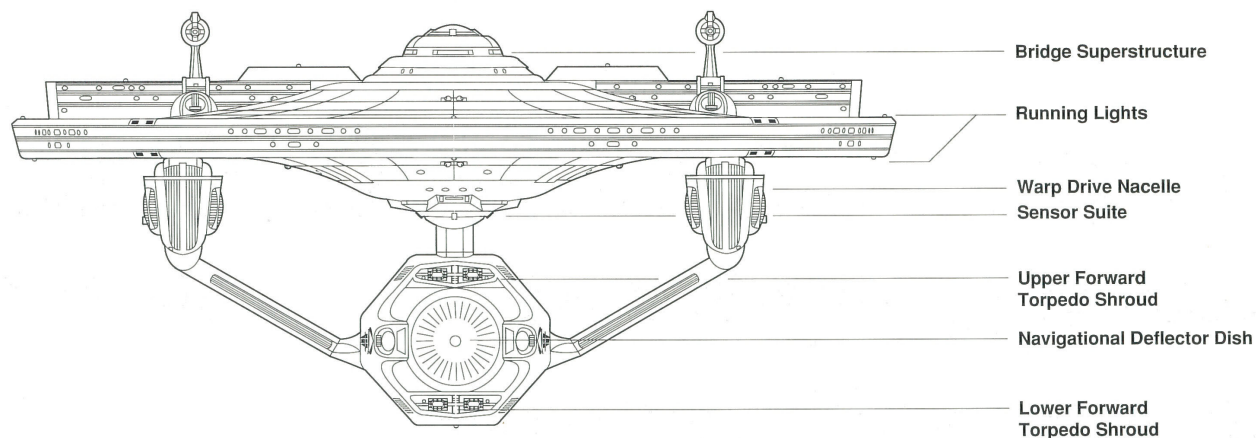

least partially deflected.

The *Starstalker* class is more massive than the *Enterprise* class, with correspondingly decreased acceleration and maneuverability. Scott claimed that these were limitations which a likely Skipper and Helmsman could compromise for, and that the design's strength and durability would give them time to do so. In terms of Hangar space, the *Starstalker* class is second only to the massive Shuttlecarrier-designs. Landing platforms free up extra area for parking embarked fightercraft in the twin primary hull hangars, while the secondary hull hangar is larger than that of the *Enterprise* class and holds general-purpose shuttles. The cargo bay is also larger than the *Enterprise* class, holding 160 cargo containers instead of 128.

### Shake-down Trials

As with the conversion of the *Enterprise* class, all ship's handling capabilities were enhanced by upgrading to Class 1b technology. Performance capabilities remain inferior to the CH1701A class, but this is more than offset by the craft's impressive Ordnance, Defensive, and Hangar capabilities.



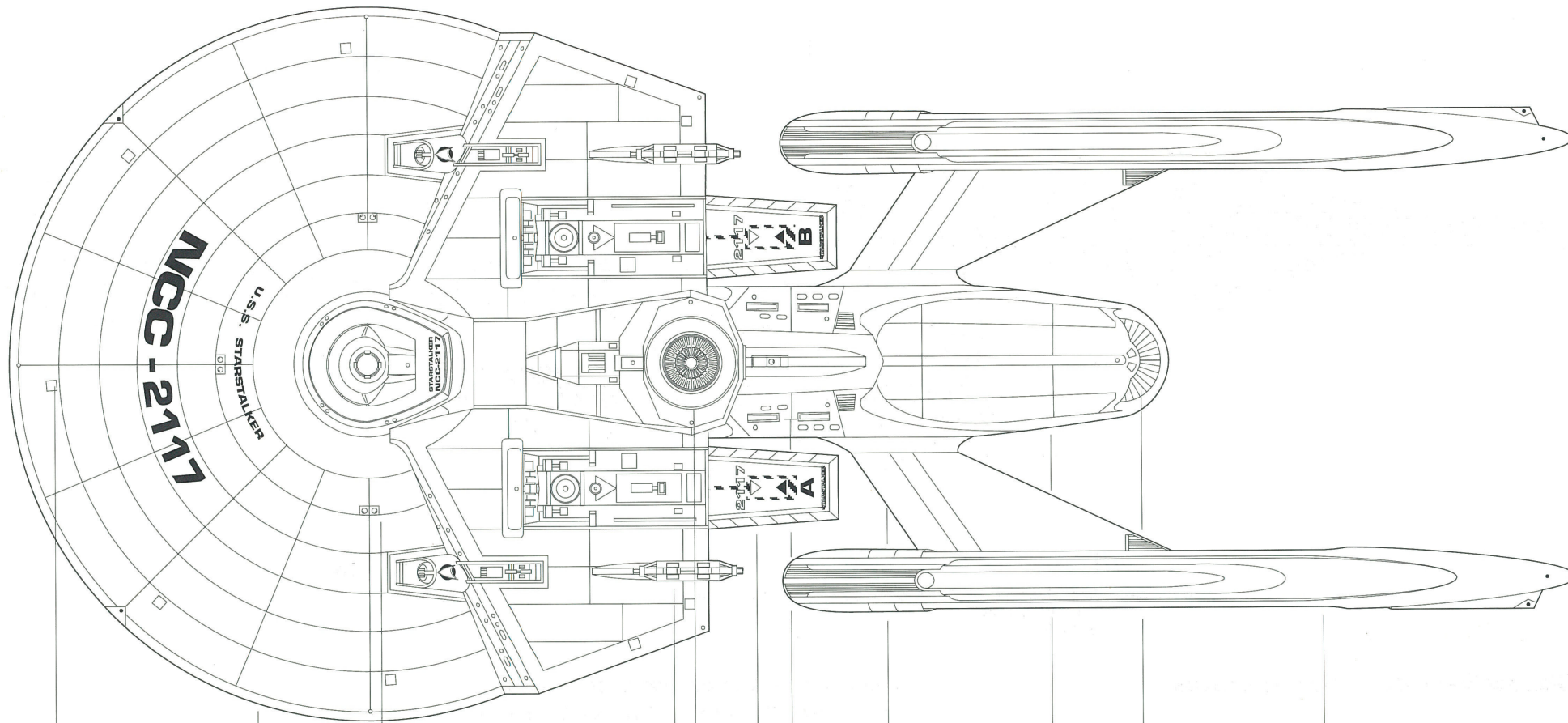

Personnel Hatch

Primary Hull

Phaser Bank

Impulse Drive

Megaphaser Cannon

Thrusters

Secondary Hull

Nacelle Support Strut

Secondary Hull

Primary Hull  
Hangar Bay Doors

Warp Drive Nacelle

STARFLEET  
PROTOTYPE

14

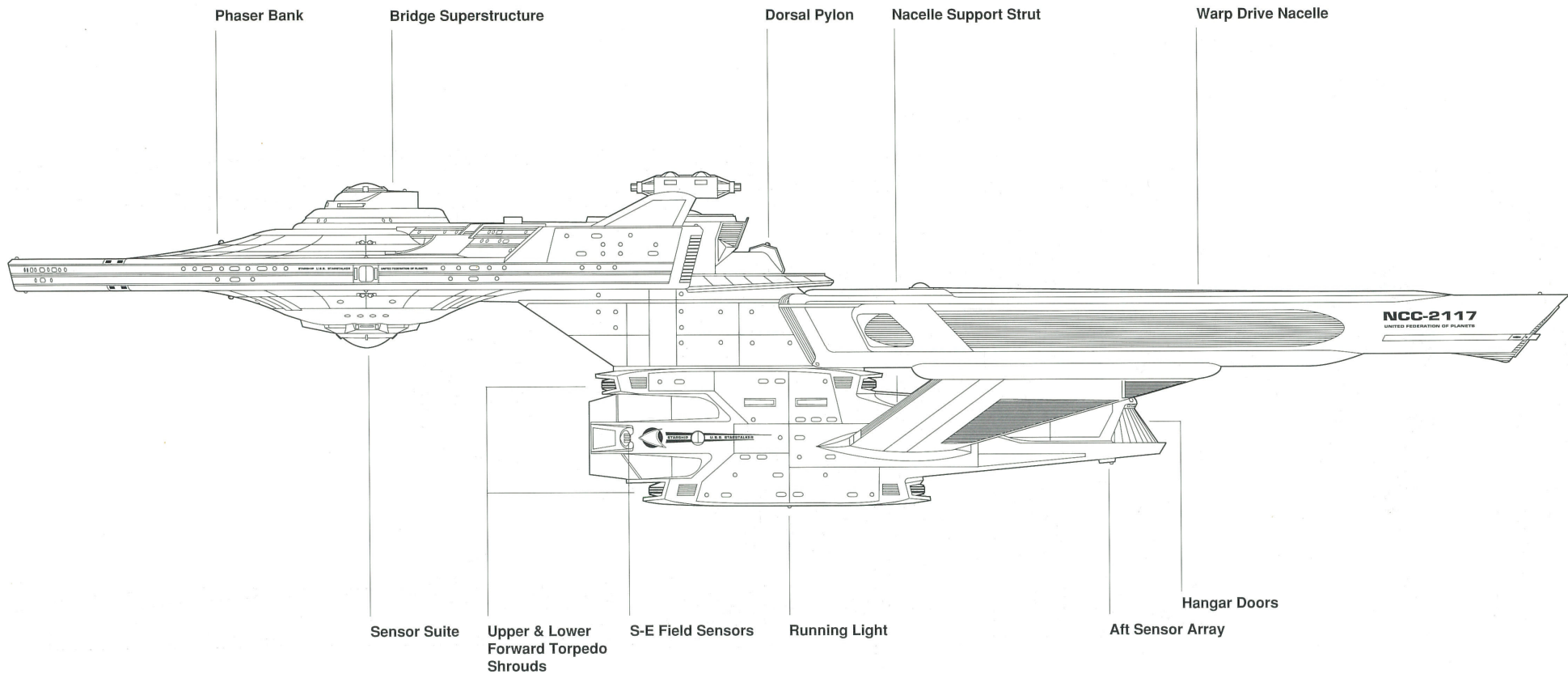

## Starstalker - Class Patrol Cruiser

### Performance Characteristics (Static):

Warp Dynamic Efficiency:	Power Coefficient Indice	1.214
Powerplant:	Maximum Output	$2.4 \times 10^{15}$
	Optimum Output	$1.9 \times 10^{15}$
Subspace Field:	Field Strength	$3.24 \times 10^8$
	Field Threshold	$1.0 \times 10^{10}$
	Field Persistence	8.2
	Field Radius	427.0
	Field Capacity	340,000

### Performance Characteristics (Dynamic):

Structural Strain Parameters:	Differential Stress (Prime)	$1.62 \times 10^7$
	Differential Stress (Beta)	$4.29 \times 10^6$
	Differential Stress (Gamma)	$2.83 \times 10^6$
	Differential Stress (Delta)	$1.29 \times 10^6$
Warp speed Handling:	Warp Acceleration Rate	2.83
	Warp Deceleration Rate	1.9
	Warp Attitude Change Rate	0.396
	Impulse Acceleration Rate	4.3
Sublight Handling:	Impulse Deceleration Rate	5.8
	Impulse Attitude Change Rate	0.289
	Speed Performance:	Cruising Speed
Flank Speed		wf10.9
Emergency Maximum Speed		wf11.4



# Ranger

NCC-2701  
Light Cruiser

## U.S.S. *Ranger* CL 2701 Class Light Cruiser

### **Ranger (CL 2701) class Light Cruiser Design Philosophy & Purpose:**

"At last an acceptable Light Cruiser has been put forth - the Ranger (CL 2701) class."

Among all their features, starships are renowned for their flexibility. Of the Class 1-b starships, it is the Cruiser-design (Dreadnought, Heavy Cruiser, Cruiser, Battlecruiser, Strike Cruiser) which is considered the most protean. For this reason Strategic Design is always experimenting with the design, and there is usually at least one experimental version in each edition of **PROTOTYPE**. This year is no exception, and has two varieties.

Joining the Cruiser-design is a second Light Cruiser-type. It has long been felt that a lighter and even more maneuverable Cruiser-design than the *Belknap* (CS 2501) class was desirable, but most proffered designs were rejected, being merely amputated versions of the *Enterprise* (CH 1701) class, sacrificing secondary hull internal volume, which necessitated a powerplant smaller than the KR13-N matter/antimatter reactor (whose 24 antimatter containment bottles give the Cruiser-design its exceptional range, cargo capacity, and hangar space) for only moderate improvements in speed and maneuverability - sometimes even damaging the external layout which aids the Cruiser-design in being the most Warp Dynamic design extant.

The first Light Cruiser-type was the *Amchitka* (CL 1310) class, which was prototyped in 2288 and will be in service by 2293. However, certain

basic design limitations (not flaws) were detected in the CL 1310 class which inhibit its flexibility, and will prevent more than eight of these vessels being constructed. At long last an acceptable Light Cruiser-type has been put forth - the Ranger (CL 2701) class. It has almost the same secondary hull volume as the *Belknap* class (125% that of the *Amchitka* class) but arranged in a larger, narrower hull, with faceted lateral surfaces and the standard powerplant-intermix complex. Despite the volume, a rather significant reduction in parasitic structural mass was achieved with the new shape, as well as by shortening the dorsal pylon. Said pylon is now just tall enough to allow the torpedo tubes free line-of-fire below the sensor array.

#### **Shake-down Trials**

Trial results proved exceptional. Not only was the basic energy: speed ratio improved due to lower weight, but Cruising-, Flank-, and Emergency-Speeds were also increased due to less strain being placed upon the structure. This has been credited to the secondary hull and dorsal pylon construction, whose internal bracings and smaller sizes reduce torque. Maneuverability was also improved over the *Belknap* class, due to the center-of-mass placement coupled again with the reduced mass and torque.

Ordnance performance was similar to the *Amchitka* class, with the well-

## Ranger - Class Light Cruiser

### Vessel Specifications & Related Data:

Prototype Name:	U.S.S. <i>Ranger</i>
Construction Contract:	NCC-2701
Series:	Class 1b Starship
Design:	Cruiser
Type:	Light Cruiser (CL)
Complement:	70 Officers 400 Enlisted Crewmen
Overall Length:	320.6 meters
Overall Draft:	53.3 meters
Overall Beam:	141.7 meters
Displacement:	168,000 tonnes

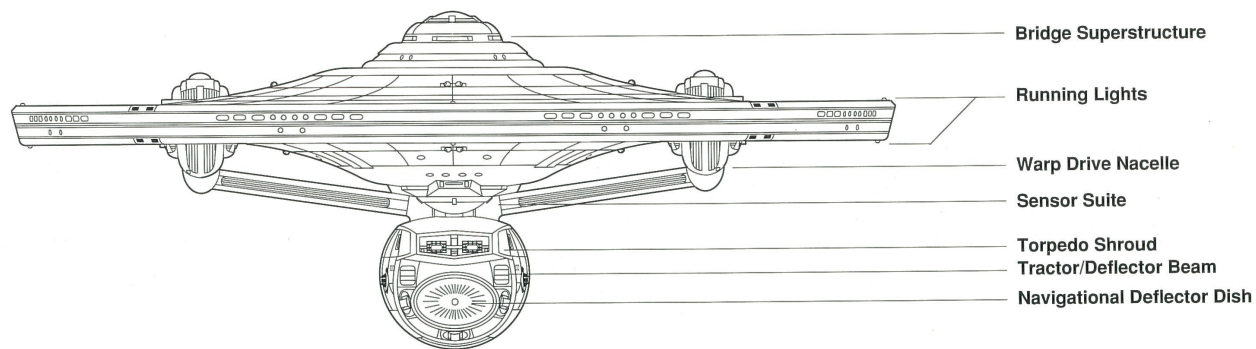

chosen hardpoints eliminating any blind-spots caused by phaser-masking, and well-coordinated fire-control. Defensive field grids were laid-out in patterns similar to the *Enterprise* class, but with 30% less surface area, the shields are slightly more efficient.

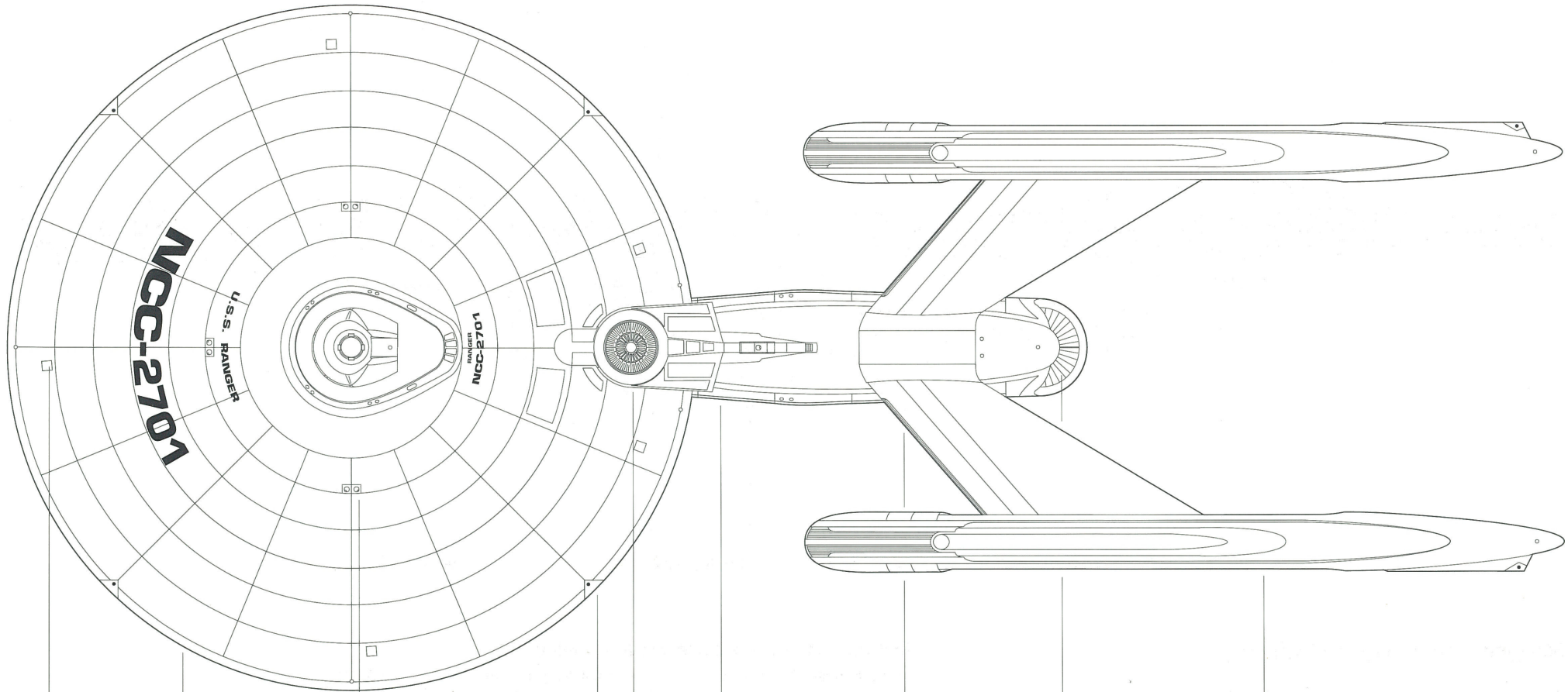

Personnel Hatch

Primary Hull

Phaser Bank

Impulse Drive

Reaction Control Thruster Package

Secondary Hull

Nacelle Support Strut

Hangar Bay Doors

Warp Drive Nacelle

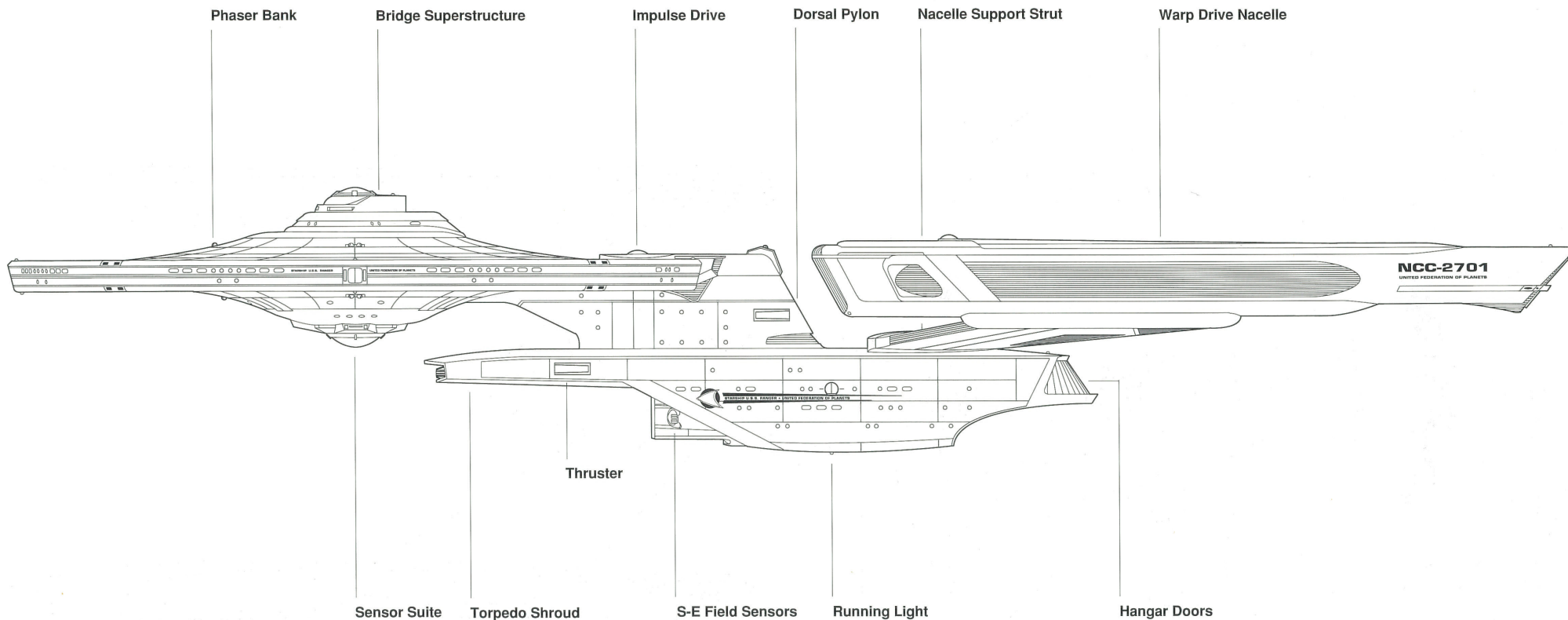

## Ranger - Class Light Cruiser

### Performance Characteristics (Static):

Warp Dynamic Efficiency:	Power Coefficient Indice	1.02
Powerplant:	Maximum Output	$2.4 \times 10^{15}$
	Optimum Output	$1.9 \times 10^{15}$
Subspace Field:	Field Strength	$3.2 \times 10^8$
	Field Threshold	$1.0 \times 10^{10}$
	Field Persistence	8.0
	Field Radius	427.0
	Field Capacity	350,000

### Performance Characteristics (Dynamic):

Structural Strain Parameters:	Differential Stress (Prime)	$1.55 \times 10^7$
	Differential Stress (Beta)	$4.4 \times 10^6$
	Differential Stress (Gamma)	$2.5 \times 10^6$
	Differential Stress (Delta)	$1.2 \times 10^6$
Warp speed Handling:	Warp Acceleration Rate	2.8
	Warp Deceleration Rate	1.3
	Warp Attitude Change Rate	0.413
	Impulse Acceleration Rate	3.4
Sublight Handling:	Impulse Deceleration Rate	4.0
	Impulse Attitude Change Rate	0.255
Speed Performance:	Cruising Speed	wf8.4
	Flank Speed	wf10.7
	Emergency Maximum Speed	wf14.9



# U.S.S. *Thruxton*

## CT 2761 Class Tactical Cruiser

"In a rare development procedure, TacFleet was allowed to specify exactly what it required..."

### **Thruxton (CT 2761) Tactical Cruiser** **Design Philosophy & Purpose:**

The third Cruiser-design introduced this year is of a new type: the Tactical Cruiser - or TacCruiser. In a rare development procedure, TacFleet was allowed to specify exactly what it required - and what it considered of second importance - instead of merely providing a generalized "wish list" of features. After two years of internal conferencing and design, TacFleet Commander presented Strategic Design with a the specifications for this new vessel.

Speed and fire-power were stressed above all considerations, and were to be equal or superior to the *Belknap* (CS 2501) class Strike Cruiser (which has been filling the role of TacCruiser during the new type's genesis). A modicum of maneuverability was sacrificed, but the speed, acceleration, and fire-power (particularly the unprecedented fire-arcs of the megaphaser cannon) are considered to overshadow this. Range and flexibility are even more severely curtailed, but this was deemed to be of no consequence: range mattered little when the TacCruiser could refuel/resupply at the TacBases, and flexibility was unnecessary in a craft with such a specific role.

The *Thruxton* (CT 2761) class is intended to serve as the workhorse of the TacFleet - patrolling the Klingon and Romulan Treaty Zones. Although she is suited for exploration during peace-time, there is no ignoring the fact

that in the event of an out-break of hostilities, these ships would be the first to see battle. As the first combatants in the hypothetical war zone, it was obvious that they would have to be capable of containing the situation until reinforcements (in the form of rapid-deployment task forces) could arrive on the scene. Any ship thus capable would normally be categorized as a Battlecruiser, but the intentional reduced size of this class allowed TacFleet to evade that rather grandiose (and unpopular) nomenclature. As it is, TacFleet has resisted acquiring any of the *Menahga* (CG 3100) or the new *S'Harien* (CG 3107) class Battlecruisers, leaving them to be held in Starfleet's Rapid Deployment fleet.

The under-slung-extended secondary hull of the *Thruxton* class does resemble the Battlecruiser approach, but any resemblance is superficial. This new version has a much sleeker cross-section, without the boxy add-on cargo and hangar section [TacFleet specifically deleted the hangar, stating that its other hangar-equipped vessels (see the *Pharris* (FS 3537) class Strategic Frigate) would and could provide all the fighters the TacCruiser might require on-scene - the TacCruiser would not be required to carry shuttles for exploration].

The most noticeable ordnance feature is the innovative megaphaser cannon deployment - on the nacelle support struts penultimate to the warp

## Thruyton - Class Tactical Cruiser

### Vessel Specifications & Related Data:

Prototype Name:	U.S.S. <i>Thruyton</i>
Construction Contract:	NCC-2761
Series:	Class 1b Starship
Design:	Cruiser
Type:	Tactical Cruiser (CT)
Complement:	65 Officers 390 Enlisted Crewmen
Overall Length:	315.2 meters
Overall Draft:	33.7 meters
Overall Beam:	141.7 meters
Displacement:	150,000 tonnes

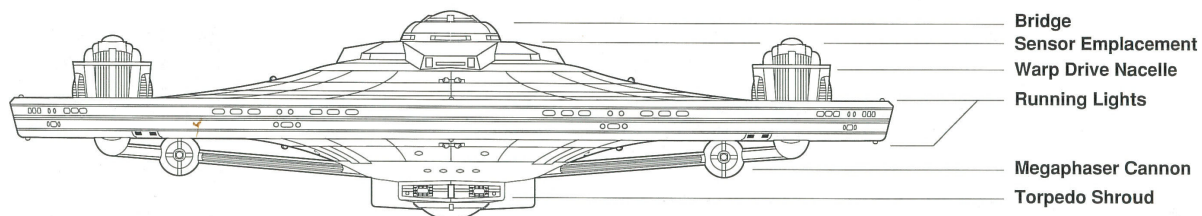

drive units, powered by a separate series of energy conduits. Their positioning accomplishes two goals: First to reduce targeting blind spots and thus increase the fire-arc. Second to allow greater parallax advantage when firing on distant fore or aft targets because of the port and starboard displacement. The cannon was first tried on the *Athabaska* (CE 2560) class Strike Cruiser, and has been found to be a valuable addition to a Cruiser's ordnance, allowing strategic possibilities impossible to either a phaser bank or photon torpedo. The cannons' significant power drain (which proved to be somewhat serious on the *Knox* (FR 1940) class Frigates) was partially compensated for by the use of a second onboard auxiliary fusion reactor. Said reactor is not dedicated to the cannon, but rather kicks-in to deliver power to life-support and other moderate-draw systems whenever the cannon are energized. The torpedo tubes are under-slung, with a pair facing fore and aft as well. From a defense point of view, the shielding grids and generators are strictly standard. However, what may be the most important defensive feature is not a dynamic system at all, but a part of the basic design. The *Thruyton* class was designed to present "minimum aspect" to an enemy from the fore, aft, and lateral angles - her flattened vertical layout presents less target area from these vantage points.

Another feature of the TacCruiser is not particularly an ordnance one,

but should certainly assist fire-control. This is the OC5889S sensor suite, an augmented version of the OC4221U, standard on most Class 1 starships (sensor values improved +140% Passive, +153% Active). This suite was first deployed on the *Monoceros* (ST 601) class Scout fleet, but was given to the *Thruyton* class for its role of Neutral Zone Patrol. In addition to its greater range, it delivers better target discrimination at extreme weapons range.

### Shake-down Trials

Trial results proved satisfactory. Warp Dynamics were similar to the *Belknap* class, and overall performance was superior even to the much lauded *S'harien* class. Ordnance performance was similarly satisfactory, and Starfleet is looking forward to testing the vessel in upcoming wargames against such champions as the *Enterprise* (CH 1701A) class.



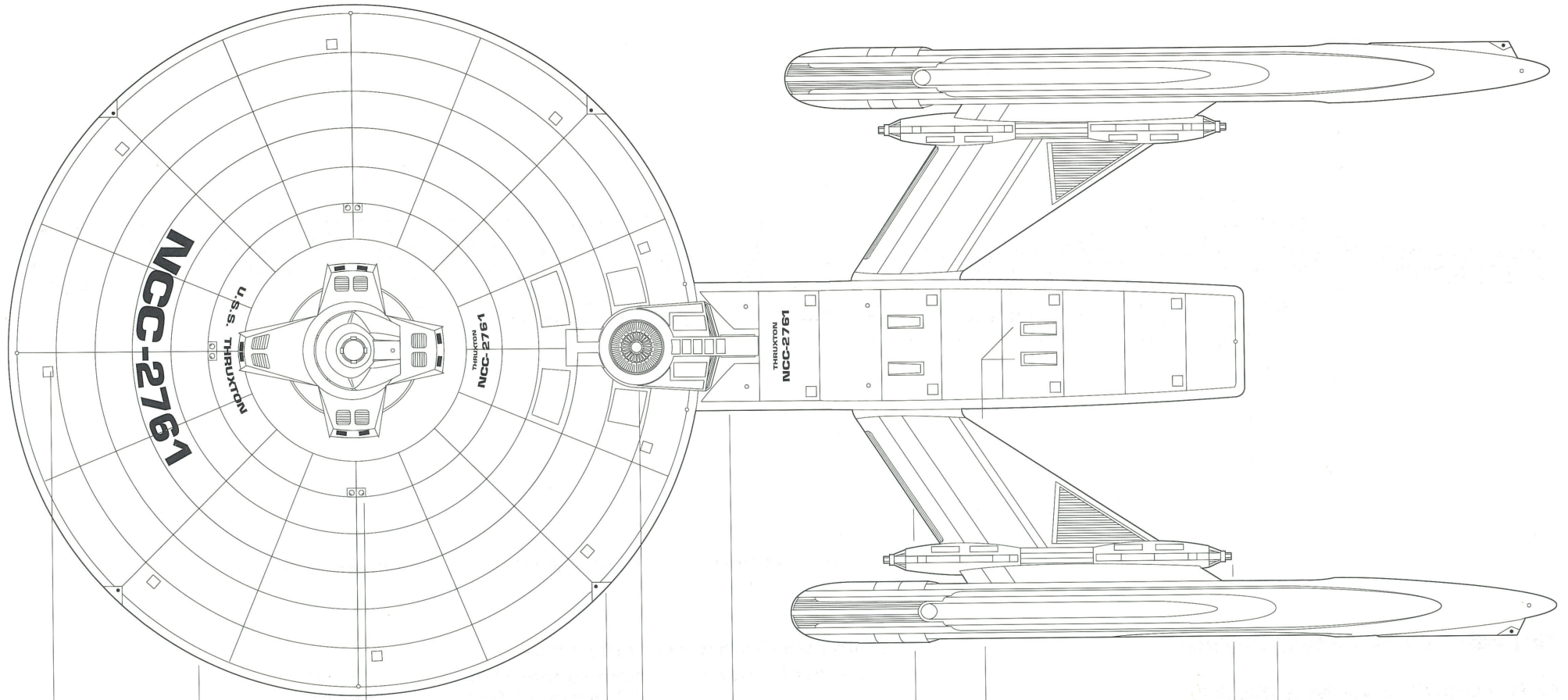

**NCC-2761**

U.S.S. **ENTERPRISE**

THURIXTON  
**NCC-2761**

THURIXTON  
**NCC-2761**

Personnel Hatch

Primary Hull

Phaser Bank

Impulse Drive

Secondary Hull

Thrusters

Warp Drive Nacelle

Nacelle Support Strut

Megaphaser Cannon

Reaction Control Thruster Package

STARFLYER  
PROTOTYPE

22

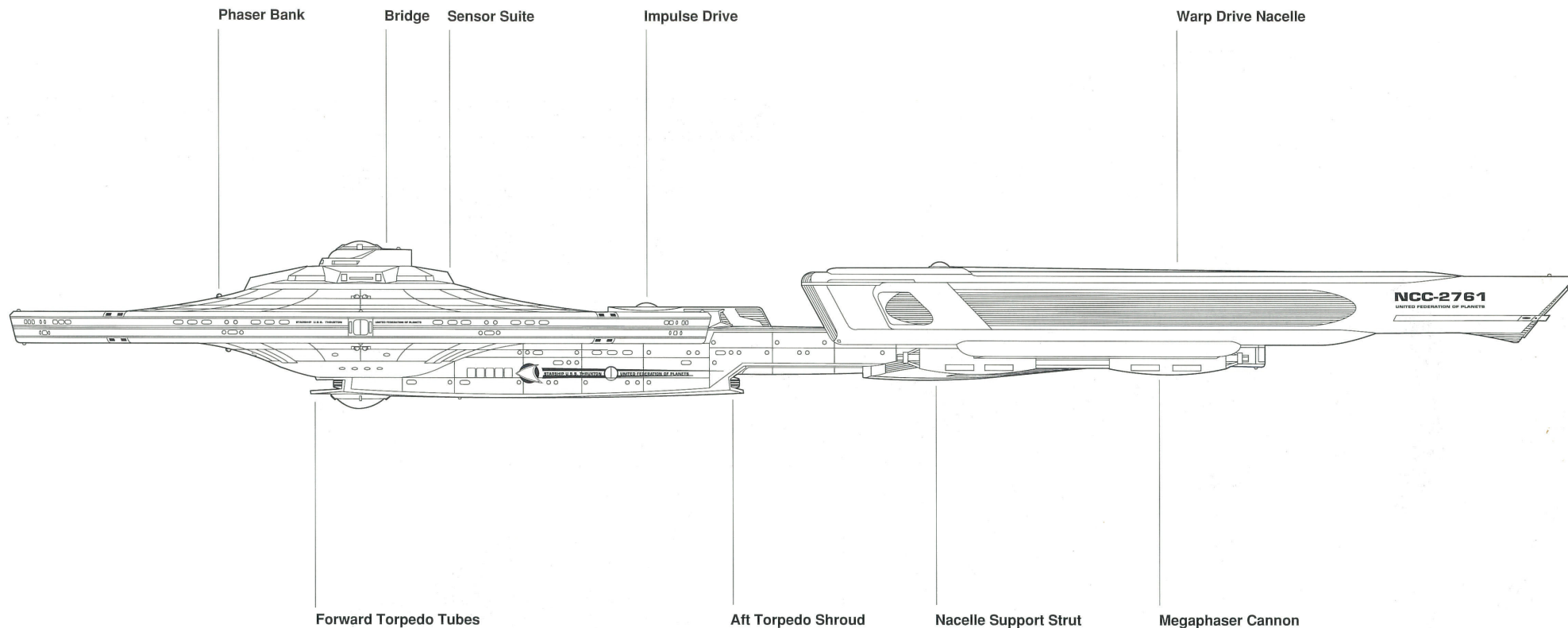

## Thruxton - Class Tactical Cruiser

### Performance Characteristics (Static):

Warp Dynamic Efficiency:	Power Coefficient Indice	1.017
Powerplant:	Maximum Output	$2.4 \times 10^{15}$
	Optimum Output	$1.9 \times 10^{15}$
Subspace Field:	Field Strength	$3.3 \times 10^8$
	Field Threshold	$1.01 \times 10^{10}$
	Field Persistence	7.9
	Field Radius	448.2
	Field Capacity	330,000

### Performance Characteristics (Dynamic):

Structural Strain Parameters:	Differential Stress (Prime)	$1.53 \times 10^7$
	Differential Stress (Beta)	$4.6 \times 10^6$
	Differential Stress (Gamma)	$2.41 \times 10^6$
	Differential Stress (Delta)	$1.01 \times 10^6$
Warp speed Handling:	Warp Acceleration Rate	2.79
	Warp Deceleration Rate	1.5
	Warp Attitude Change Rate	0.479
Sublight Handling:	Impulse Acceleration Rate	3.1
	Impulse Deceleration Rate	3.6
	Impulse Attitude Change Rate	0.294
Speed Performance:	Cruising Speed	wf8.2
	Flank Speed	wf11.8
	Emergency Maximum Speed	wf15.3

"Defending the Final Frontier

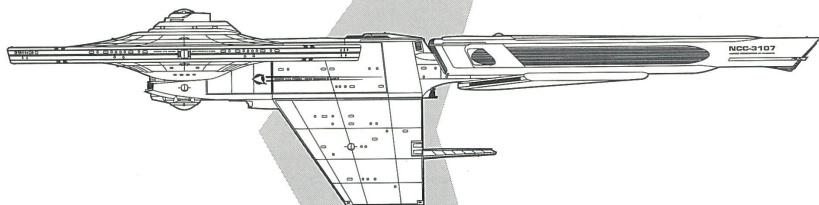

## U.S.S. S'HARIEN

# U.S.S. *S'Harien*

## CG 3107 Class Battlecruiser

"...an R & D task force was assigned, their objective to develop solutions (to the Menahga class' inherent faults)..."

### ***S'Harien* (CG 3107) Battlecruiser**

#### **Design Philosophy & Purpose:**

Due to various perceived design faults in the *Menahga* (CG 3100) class Battlecruiser prototype, the decision to proceed with the production of the class was a disputed one. However, the need for such a class was pressing, and final go-ahead for the class' production was given - with a provision. Thus, an R & D task force, was assigned to study the *Menahga* class' inherent faults, with the objective of developing solutions which could be incorporated into as-yet unbuilt craft, and retro-fitted into already-launched vessels.

#### **Itemized Improvements:**

- 1) Complete redesign of the warp support hull, which houses the matter/antimatter reactor, intermix chamber, warp drive energy conduits, main energizer, and main engineering room. The new hull is larger and positioned higher, fairing into the rear of the central support hull, rather than being attached to the rear of the secondary hull. There are several advantages to this re-positioning. The major one is that the secondary hull can now be jettisoned without carrying the vessel's warp support hull (and warp drive) along with it. This has allowed Starfleet Logistics to contemplate constructing various different secondary hulls for the

class, which could be exchanged while the Battlecruiser is at any medium sized Starfleet facility (which could stock-pile a variety of the hulls. Options for these specialized hulls include the present Marine barracks/Fightercraft Hangar Complex and Cargo Bay Hull (MFHCCB), a dedicated Cargo Bay and Cargo Transporter Hull (CBCT), a Photon Torpedo Multitube Launch Hull (PTML), and a Special Mission Weapons Hull (SMW). Except for the first, all the above are purely speculative at this time.

A second advantage of the truly jettisoning secondary hull is that it offers the Captain yet another strategy. In the event that his ship is being chased and overtaken by superior forces, the Captain could initiate a "Jack-in-the-Box" maneuver. Rather drastic, it would begin by evacuating all Marines and ship's support personnel from the secondary hull. Once emptied, the hull would be jettisoned while the ship was fleeing at warpspeed. The secondary hull would quickly drop behind the vessel, passing out of the warp envelope and thus dumping into realspace (moving at 0.99 C). There are two advantages in this maneuver. Firstly, it decreases the vessel's tonnage by almost 25,000 metric tonnes, effectively converting the battlecruiser into a *Thruxton* (CT 2761)

## S'Harien - Class Battlecruiser

### Vessel Specifications & Related Data:

Prototype Name:	U.S.S. <i>S'Harien</i>
Construction Contract:	NCC-3107
Series:	Class 1b Starship
Design:	Cruiser
Type:	Battlecruiser (CG)
Complement:	80 Officers 360 Enlisted Crewmen
Overall Length:	320.1 meters
Overall Draft:	78.0 meters
Overall Beam:	141.7 meters
Displacement:	180,000 tonnes

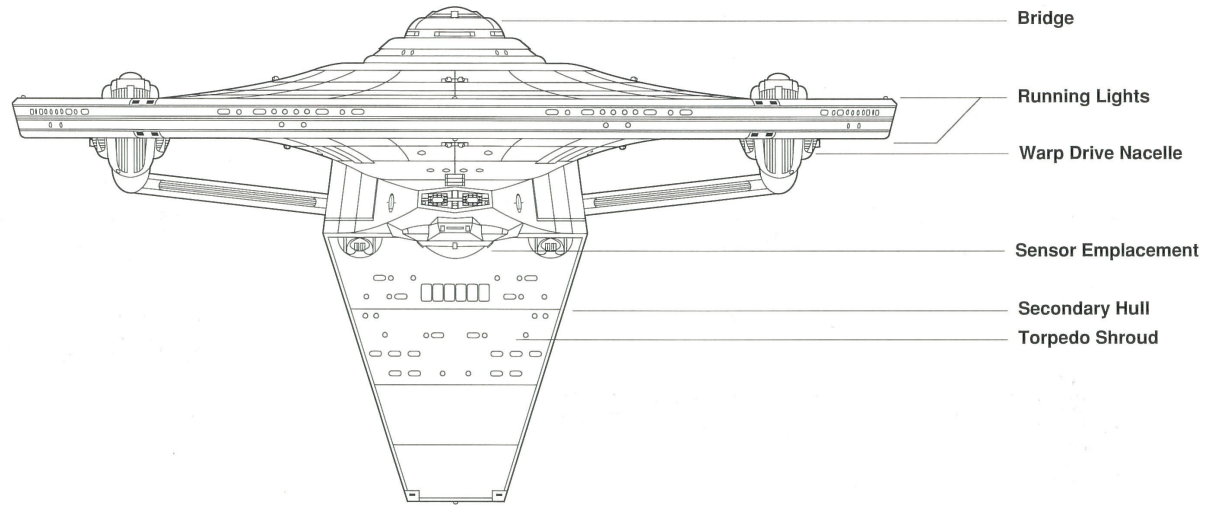

- 2) Redeployment of the warp drive nacelles to a position farther removed from the horizontal axis. This would improve the vessel's warp dynamics while at the same time increase maneuverability.
- 3) Replacement of the standardized (short) separate warp drive nacelle support struts with the new-concept one-piece strut, attaching same to the bottom of the warp support hull. This improves structural integrity, and allows for easier warp nacelle ejection.
- 4) Addition of twin rear-firing torpedo tubes and bays, just below and forward of the warp nacelle support strut attachment point on the warp support hull.
- 5) Relocated rear phaser bank, with improved fire-arc.

- 6) Redeployment of forward torpedo exhaust ports to the central sup port hull lower surface, aft of sensor suite.
- 7) Addition of a standardized sensor suite near the customary position, displaced to make room for the forward torpedo bay.
- 8) Relocation of the Hangar Bay to the rear of the secondary hull, and the addition of an external landing platform.
- 9) Addition of internal energy conduits and external hardpoints for megaphaser cannon - presently left unmounted.

### Shake-down Trials

Trial results were a definite improvement upon the *Menahga* class, and plans are being made to recall most of the present Battlecruiser fleet back to Spacedock for refit, although some of the original Battlecruiser (such as U.S.S. *Menahga*) may be left intact. Like the *Menahga* class, the *S'harien* class Battlecruisers will be assigned to the Rapid Deployment Fleet.

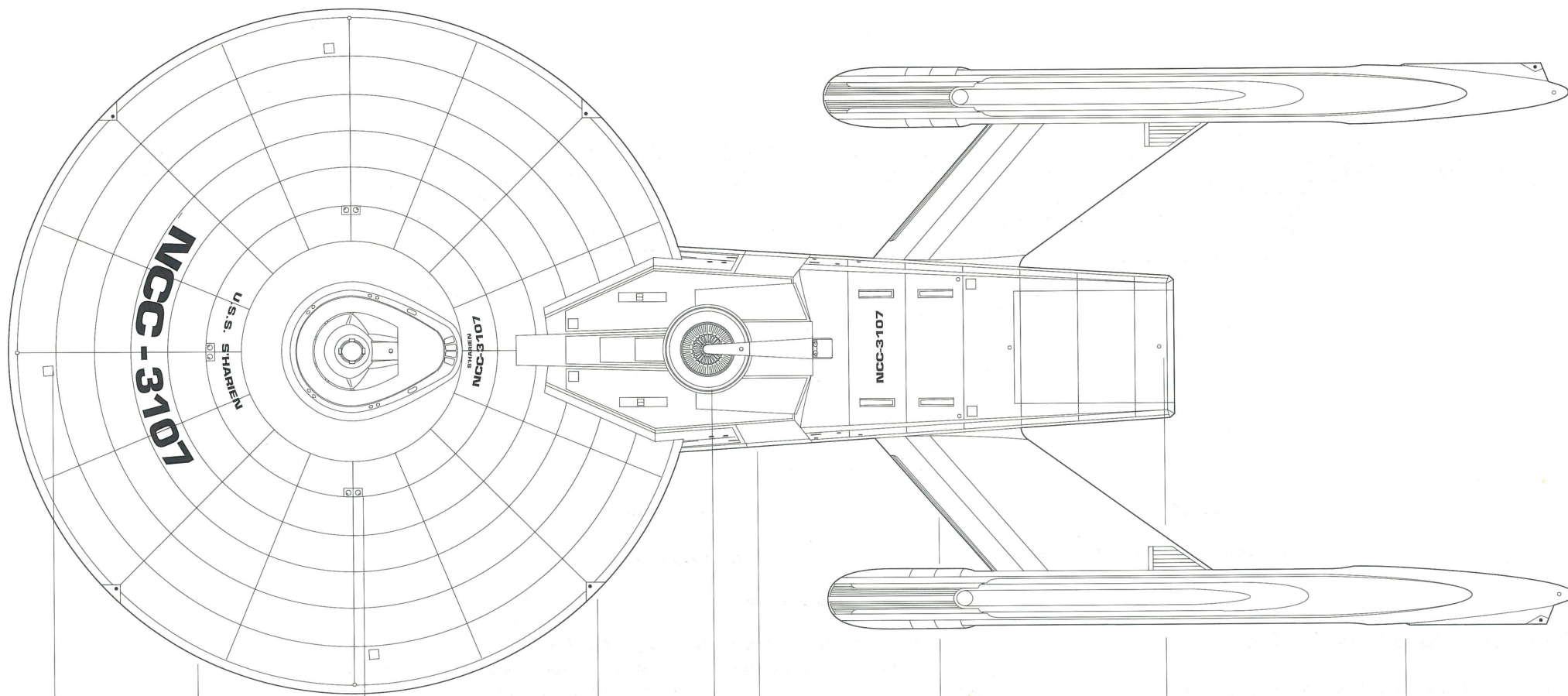

Personnel Hatch

Primary Hull

Phaser Bank

Impulse Drive

Reaction Control Thruster Package

Central Support Hull

Nacelle Support Strut

Warp Drive Support Hull

Warp Drive Nacelle

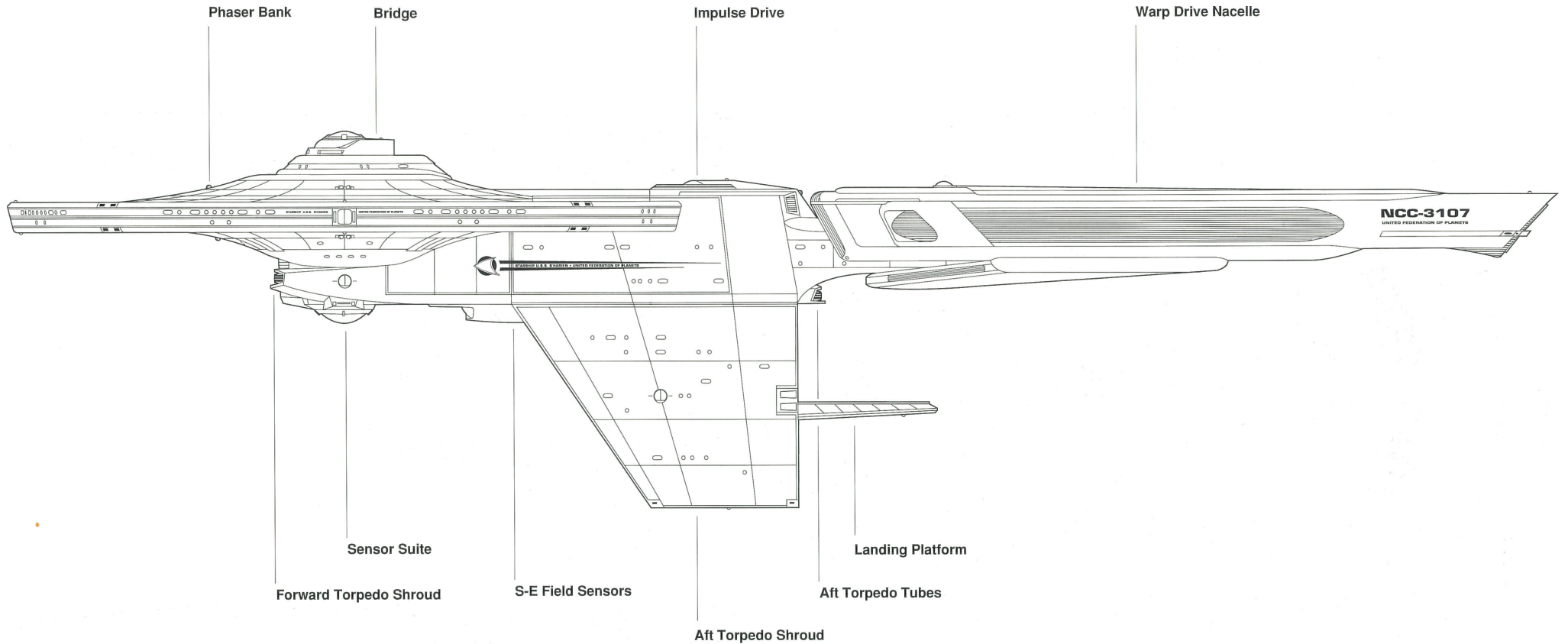

## S'Harien - Class Battlecruiser

### Performance Characteristics (Static):

Warp Dynamic Efficiency:	Power Coefficient Indice	1.13
Powerplant:	Maximum Output	$2.4 \times 10^{15}$
	Optimum Output	$1.9 \times 10^{15}$
Subspace Field:	Field Strength	$3.3 \times 10^8$
	Field Threshold	$1.01 \times 10^{10}$
	Field Persistence	8.1
	Field Radius	448.2
	Field Capacity	330,000

### Performance Characteristics (Dynamic):

Structural Strain Parameters:	Differential Stress (Prime)	$1.61 \times 10^7$
	Differential Stress (Beta)	$4.8 \times 10^6$
	Differential Stress (Gamma)	$2.46 \times 10^6$
	Differential Stress (Delta)	$1.09 \times 10^6$
Warp speed Handling:	Warp Acceleration Rate	2.91
	Warp Deceleration Rate	1.6
	Warp Attitude Change Rate	0.485
Sublight Handling:	Impulse Acceleration Rate	3.5
	Impulse Deceleration Rate	3.9
	Impulse Attitude Change Rate	0.306
Speed Performance:	Cruising Speed	wf8.2
	Flank Speed	wf10.6
	Emergency Maximum Speed	wf13.4



# **New from the Yards...**

## **Frigates:**





# U.S.S. *Pharris*

## FS 3537 Class Strategic Frigate

"In this design, Strategic Design has attempted to remedy imperfections in the basic (Frigate) concept..."

### ***Pharris* (FS 3537) class Strategic Frigate Design Philosophy & Purpose:**

The first Frigate-design launched this year was the long-heralded Strategic Frigate. In this design, Strategic Design has attempted to remedy imperfections in the basic concept - in terms of a Frigate's stated mission of Tactical Fightercraft Launch, Support, & Interdiction.

An oft-stated maxim about the *Knox* (FR 1940) class Frigate is that the presence of megaphaser cannon makes up for the lack of torpedo tubes. However, no Captain of a Heavy Cruiser or other torpedo-equipped vessel would willingly make such a trade: cannon draw enormous amounts of power - power which could usually be utilized for other battle-essential resources and systems (such as propulsion and shields), whereas torpedo launches only draw upon the torpedoes own fuel supply. Therefore, Strategic Design set about the task of equipping a Frigate with torpedoes without so increasing the vessel's tonnage that the vessel would be limited to the handling capabilities of a Heavy Frigate. They were aided in this quest by the advent of the Taylor-Azik Mark-6 Torpedo Load/Handling/Launch System. This automated system is considered so safe in terms of accident prevention and launch exhaust vent dispersion that the Torpedo Complex could be returned to the original Class 1 starship position - forward and just below the Bridge, as with its ancestor the Mark 1 torpedo launcher.

The three main strengths of Frigate designs have always been Hangar/Flight-Deck Capacity (210% that of an *Enterprise* (CH 1701A) class Heavy Cruiser), Small Complement (75%) (and thus less-expensive operating costs), and Maneuverability. Striving to get the maximum efficiency out of the *Pharris* (FS 3537) class' twin Hangar/Flight-Deck Complexes, Strategic Design decided to outfit it with three external landing platforms - one aft of each hangar (as with the older *Daran* (FF 3201) class, and one on the centerline. These platforms are interconnected via a transverse taxiway. When utilized in Tactical Support Mode, the starboard and centerline platforms (B and C) are used to receive incoming Fightercraft, which are then taxied via tractor beam into Hangar 2 (starboard). There they are re-fueled/re-armed, taxied through the interconnecting throughway into Hangar 1 (port), and subsequently launched from the port platform (A). This allows for a faster Fightercraft turnaround (148% of *Daran* class). A second Parallel Mode would have Fightercraft landing on Platform B, re-fueling/re-arming in Hangar 2, and launching from Platform C, leaving Hangar 1 and Platform A free for simultaneous use by the larger Shuttlecraft and other general usage auxiliary craft which are parked in Hangar 1.

The new nacelle positioning increases speed, while slightly decreasing warp maneuverability (96% of *Daran* class). As with the *Thruyton* (CT 2761)

## Pharris-Class Strategic Frigate

### Vessel Specifications & Related Data:

Prototype Name:	U.S.S. <i>Pharris</i>
Construction Contract:	NCC-3537
Series:	Class 1b Starship
Design:	Frigate
Type:	Strategic Frigate (FS)
Complement:	50 Officers 325 Enlisted Crewmen
Overall Length:	257.6 meters
Overall Draft:	46.7 meters
Overall Beam:	141.7 meters
Displacement:	138,000 tonnes

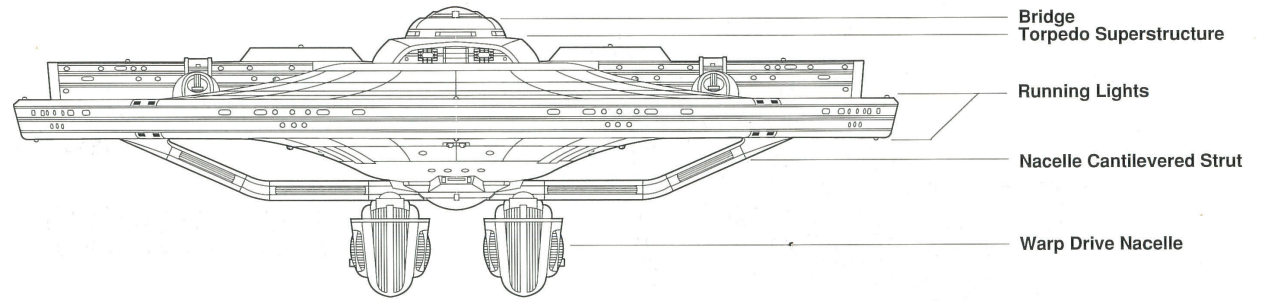

class TacCruiser, the slight reduction of warp maneuverability was deemed acceptable - especially since the Strategic Frigate is still left a high percentage of her design's inherent maneuverability.

### Shake-down Trials

Trial results proved satisfactory. Warp Dynamics were slightly superior to the *Knox* (FR 1940) class, and overall maneuverability was not as pared-down as had been originally allowed-for. Ordnance performance was similarly satisfactory (the Shake-down Captain was most impressed with the new torpedo system), and Starfleet plans to purchase an initial order of twenty-four vessels - some of which will be assigned to internal patrol of hostile systems, and the remaining six assigned to TacFleet.

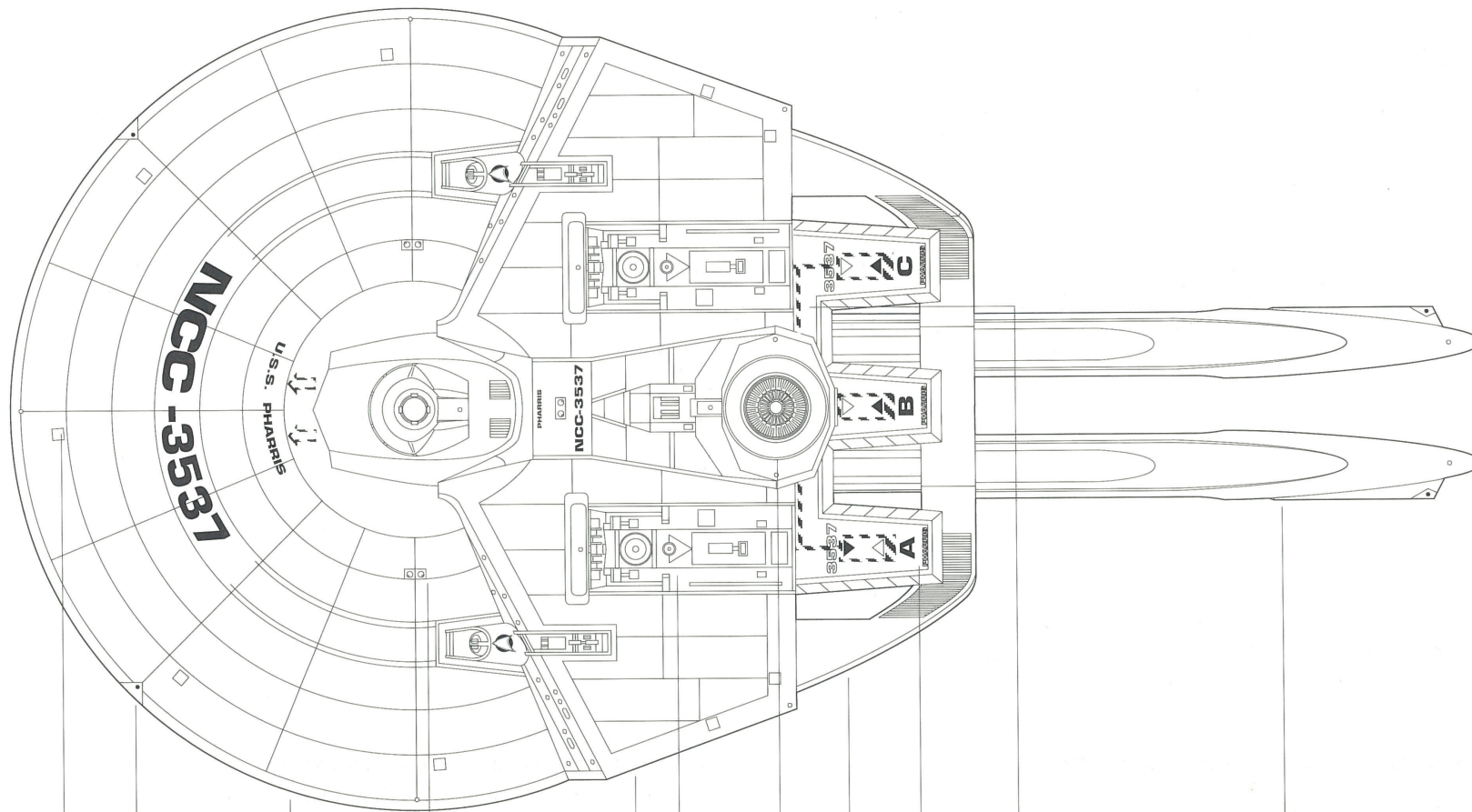

- Personnel Hatch
- Reaction Control Thruster Package
- Primary Hull
- Phaser Bank
- Hangar
- Extended Hull
- Impulse Drive
- Nacelle Cantilevered Strut
- Landing Platform
- Shuttle Taxiway
- Warp Drive Nacelle

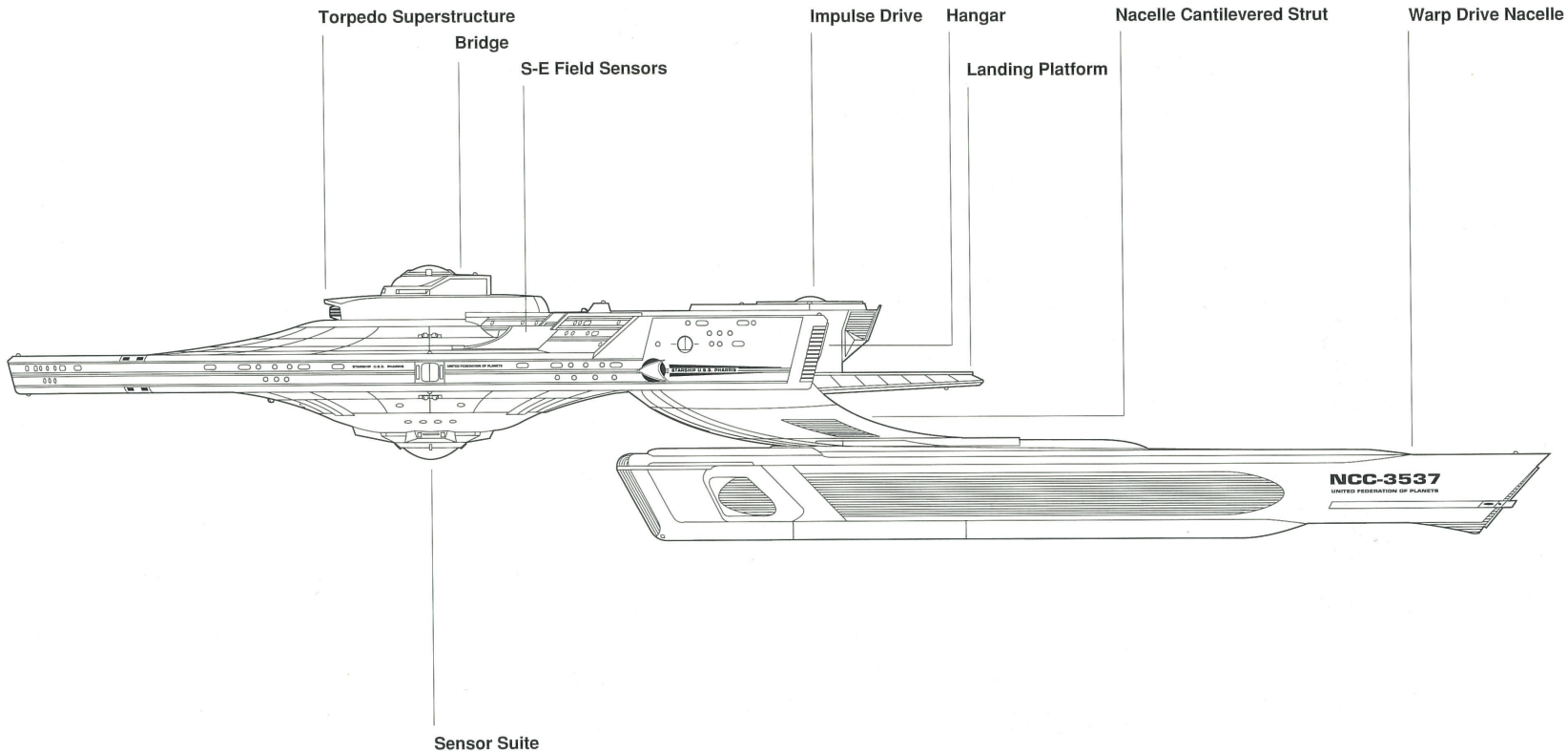

## Pharris - Class Strategic Frigate

### Performance Characteristics (Static):

Warp Dynamic Efficiency:	Power Coefficient Indice	1.02
Powerplant:	Maximum Output	$2.3 \times 10^{15}$
	Optimum Output	$1.7 \times 10^{15}$
Subspace Field:	Field Strength	$2.99 \times 10^8$
	Field Threshold	$1.04 \times 10^{10}$
	Field Persistence	7.6
	Field Radius	413.0
	Field Capacity	280,000

### Performance Characteristics (Dynamic):

Structural Strain Parameters:	Differential Stress (Prime)	$1.63 \times 10^7$
	Differential Stress (Beta)	$4.02 \times 10^6$
	Differential Stress (Gamma)	$2.7 \times 10^6$
	Differential Stress (Delta)	$1.3 \times 10^6$
Warspeed Handling:	Warp Acceleration Rate	3.3
	Warp Deceleration Rate	1.9
	Warp Attitude Change Rate	0.299
	Impulse Acceleration Rate	2.6
Sublight Handling:	Impulse Deceleration Rate	3.4
	Impulse Attitude Change Rate	0.189
	Speed Performance:	Cruising Speed
	Flank Speed	wf9.9
	Emergency Maximum Speed	wf11.8

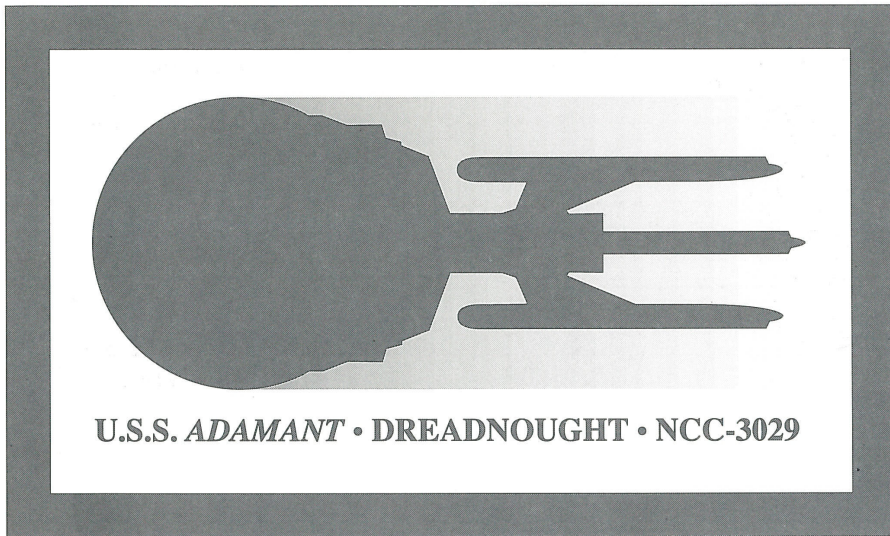

# U.S.S. *Adamant*

## DNF 3029 Class Dreadnought

"Strategic Design has attempted a novel approach in Frigate/Dreadnought configuration..."

### **Adamant (DNF 3029) class Dreadnought Design Philosophy & Purpose:**

One of the more difficult tasks facing starship shipwrights has always been Dreadnought design. The very concept is self-contradictory: A Dreadnought must by definition incorporate all the resources worthy of the name (overwhelming fire-power, large hangar facilities), but at the same time is expected to be one of the fastest ships in the fleet. Speed is usually aquired in a starship by two methods: adding another nacelle (which drastically increases fuel consumption), and trimming excess mass. The latter is not an avenue open to Dreadnought design. For this reason, Dreadnought design prototype releases are few and far between.

The disappointing performance of the ADREFT *Kirov* (DNF 2150) class Frigate/Dreadnought illustrated the problem facing said shipwrights. In attaching a third warp drive nacelle to an *Avenger* (FH 1860) class Heavy Frigate's extended hull, the designers had hoped to mate the large hangar facilities, fearsome fire-power, and high maneuverability of the Heavy Frigate with the speed capability of a Dreadnought. The vessel passed its Acceptance Trials, but the new class was definitely not the supership that the designers had been striving for. The extra nacelle taxed the main reactor at Flank+ speeds, and the additional support systems and auxiliary equipment necessary for the third nacelle (extra internal bracings and frames, energy conduits, etc.) took up a large fraction of valuable and cargo

bay space (just ahead of the impulse drive in the *Avenger* class), which reduced the vessel's operating range. Furthermore, the famous Frigate maneuverability was severely retarded. Although five of these ships were eventually built (refitted Heavy Frigates), the ADREFT concept was shelved in 2289, and no further vessels from the *Avenger* class will be refitted to this design.

Strategic Design has attempted a novel approach in Frigate/Dreadnought configuration by attaching a separate reactor hull aft of the impulse drive (which was also displaced sternward). Normally the addition of a "secondary hull" would upgrade the classification from Frigate to Cruiser, but the hull is so small that this was not thought appropriate. As its name suggests, the reactor hull contains only a matter/antimatter reactor (the KR13-O first developed for the *Menahga* (CG 3100) class Battlecruiser), a horizontal intermix chamber leading forward to the impulse drive, and lateral energy conduits branching-off the intermix chamber to the three warp drive nacelles. Unlike the reactor hulls of the *Menahga* class Battlecruiser and *Thruxton* (CT 2761) class TacCruiser, this does not incorporate thrusters or an Engineering Room - Main Engineering is located forward of the hull separation line, surrounding the impulse drive vertical energy conduit.

## Adamant- Class Dreadnought

### Vessel Specifications & Related Data:

Prototype Name:	U.S.S. <i>Adamant</i>
Construction Contract:	NCC-3029
Series:	Class 1b Starship
Design:	Frigate
Type:	Dreadnought (DNF)
Complement:	85 Officers 345 Enlisted Crewmen
Overall Length:	339.3 meters
Overall Draft:	57.1 meters
Overall Beam:	141.7 meters
Displacement:	255,000 tonnes

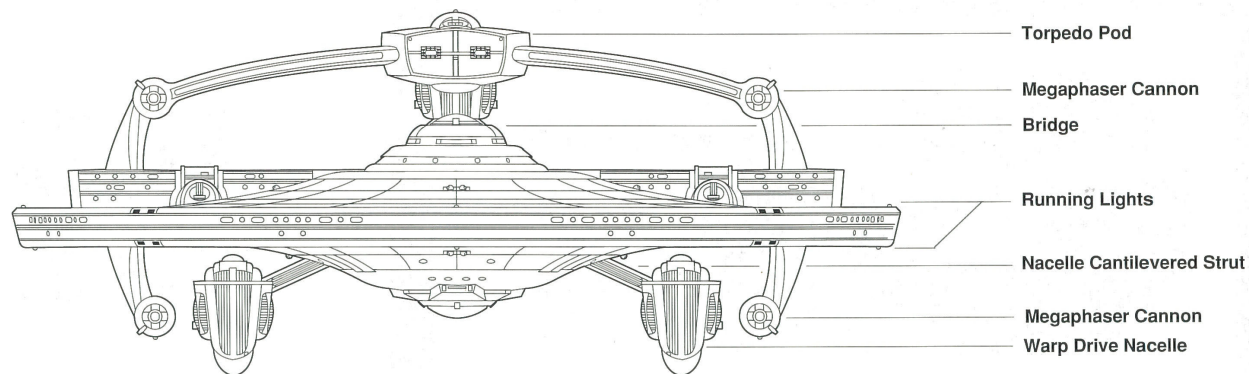

Hangar space was increased by displacing the impulse drive farther aft - allowing the port and starboard hangars to connect via a transverse parking bay located in the space vacated. The cargo bay is located forward of this. Landing platforms were not utilized in this class. Although they would have freed even more hangar parking space, they would have interfered with the warp dynamics of the ship, being located between three warp drive nacelles.

The *Avenger* class' megaphaser fire-arc shadow (being located atop the extended hull, the Heavy Frigates' megaphaser cannon cannot fire at a target located at its Z axis) was repaired by mirroring the top pair of cannon with a lower pair, depending from the same struts, giving the cannon true double 360° coverage. Due to energy limitations, only one pair of cannon can be energized at a time.

### Shake-down Trials

Performance during trial runs was excellent, especially during the all-out speed runs, where the vessel came close to matching the emergency maximum velocity of the *Ascension* (DN 2520) class Dreadnought (a remarkable achievement considering the much greater mass of the *Adamant* class). Maneuvering was optimum for a Dreadnought, besting the *Ascension*

class and nearly as good as the *Avenger* class. Ordnance was tested at the Darkstar wargames played out at Starbase 14 on Stardate 9301.32. The Dreadnought was the clear winner insofar as overall fire-power was concerned, and a close third with regards to concerted, maintained precision attack (first was *Thruyton*, followed by *Starstalker*).

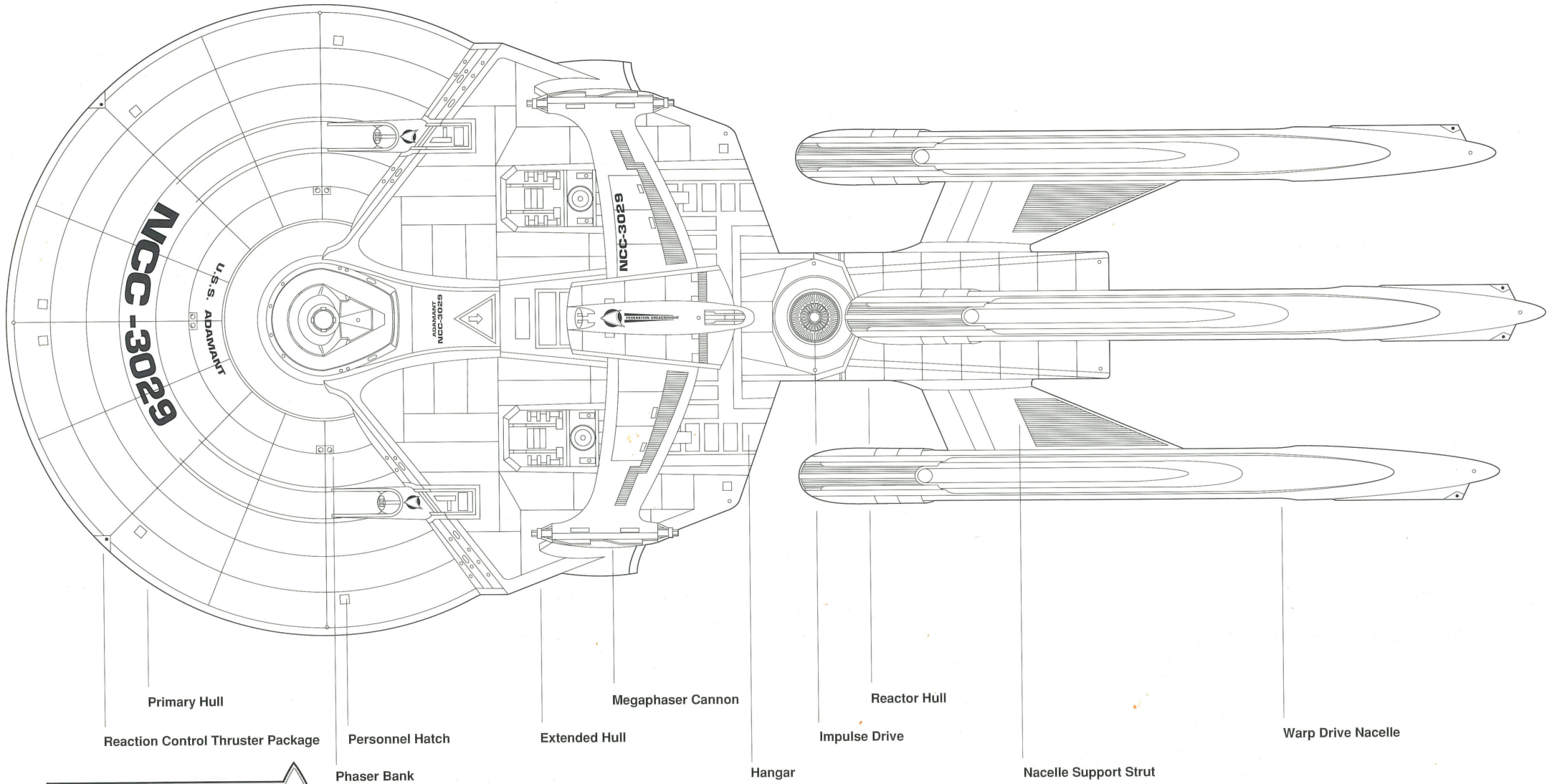

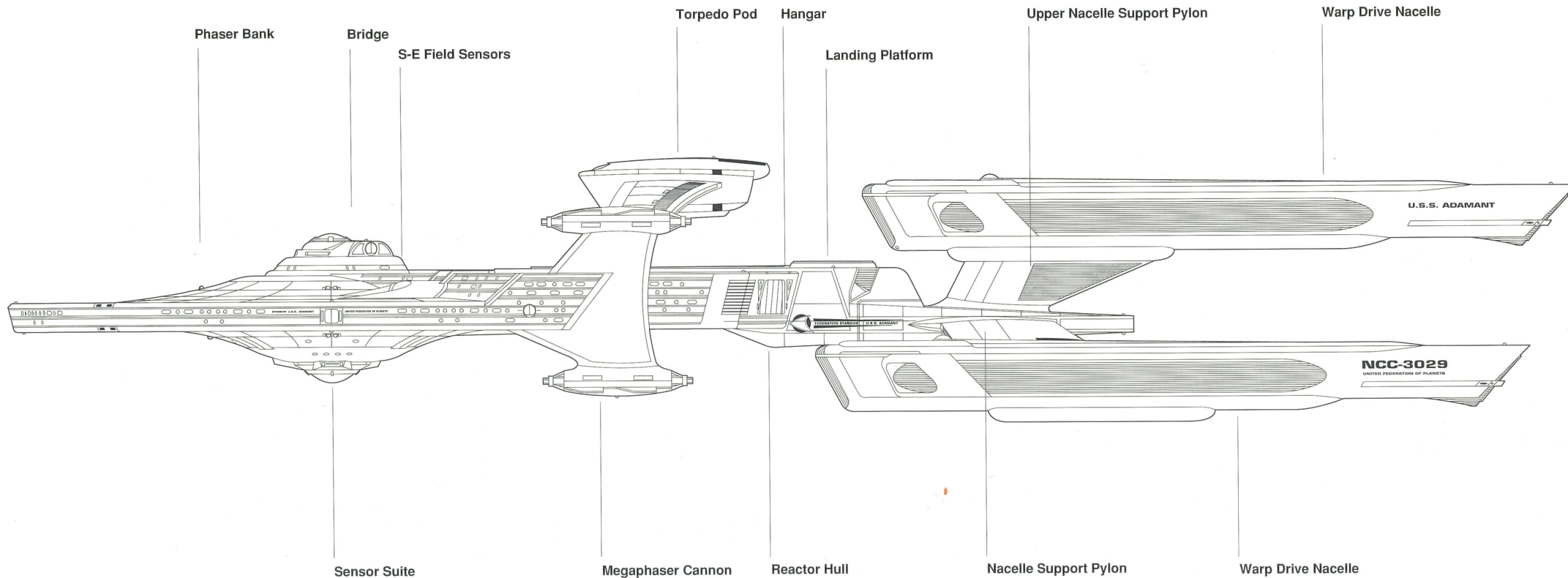

## Adamant - Class Dreadnought

### Performance Characteristics (Static):

Warp Dynamic Efficiency:	Power Coefficient Indice	1.306
Powerplant:	Maximum Output	$2.4 \times 10^{15}$
	Optimum Output	$1.9 \times 10^{15}$
Subspace Field:	Field Strength	$3.8 \times 10^8$
	Field Threshold	$1.58 \times 10^{10}$
	Field Persistence	9.3
	Field Radius	473.0
	Field Capacity	298,000

### Performance Characteristics (Dynamic):

Structural Strain Parameters:	Differential Stress (Prime)	$1.72 \times 10^7$
	Differential Stress (Beta)	$4.21 \times 10^6$
	Differential Stress (Gamma)	$3.1 \times 10^6$
	Differential Stress (Delta)	$1.56 \times 10^6$
Warp speed Handling:	Warp Acceleration Rate	3.5
	Warp Deceleration Rate	2.6
	Warp Attitude Change Rate	0.365
	Impulse Acceleration Rate	4.98
Sublight Handling:	Impulse Deceleration Rate	6.77
	Impulse Attitude Change Rate	0.199
	Speed Performance:	
	Cruising Speed	wf8.3
	Flank Speed	wf9.6
	Emergency Maximum Speed	wf12.6





# **New from the Yards...**

## **Escorts:**

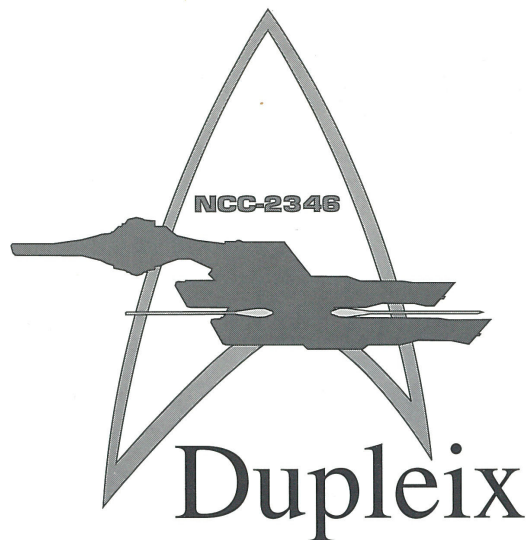

# U.S.S. *Dupleix*

## PA 2346 Class Perimeter Action Ship

" *Dupleix* class Perimeter Action Ships would escort the Dreadnought...one of the few starship types which can keep up with it."

### ***Dupleix* (PA 2346) class Perimeter Action Ship Design Philosophy & Purpose:**

The second Escort-design prototype tested this year was also a Destroyer-type vessel. The *Dupleix* (PA 2346) class is the latest of the Perimeter Action Ships, joining the *Kirsanov* (PKA 1170), *Engage* (PA 1125), and *Akyazi* (PA 1010) classes. Her primary task would be patrolling along major spacelanes - outside the Federation, but within the Treaty Zone. Her second task would be during wartime. In the event of fleet actions (10-15 starship task forces), Escort vessels are intended to do just that, escorting larger starships. Their role would be interdiction: deployed at the outer flanks of the task force, forming an outer defensive screen, occasionally ranging farther out to investigate unknown phenomena and engaging enemy vessels at a distance, buying time for the Capital ships to deploy and attack in strength.

A problem with this tactic however, is that most Capital ships (Frigate and Cruiser-designs) - especially the *Ascension* (DN 2520) class Dreadnought - have Flank- and Emergency-Speeds far exceeding those of regular Escort-designs [*Monoceros* (ST 601) class Scouts and *Siva* (DD 520) class Destroyers]. Thus, if the Capital ships found it necessary to move out at full Emergency Speed, (whether to press an attack or to retreat) the Escorts would find themselves left behind, and the Capital ships would be without their protection.

The *Scimitar* (DF 2901) class Fast Destroyer was one answer to this, but this new Perimeter Action Ship is expected to be the main one. Her specific role would be to patrol the immediate sectors around a task force, hunting for enemy vessels. In the event of fleet dispersal, the *Dupleix* class Perimeter Action Ships would escort the Dreadnought flagship, as they are one of the few starship types which can keep up with it.

The most striking innovation of this Perimeter Action Ship is the twin nacelle deployment. It was hypothesized that this arrangement could gain the absolute maximum speed and acceleration advantage for an Escort-design (while unfortunately seriously sacrificing maneuverability). The *Dupleix* class is also unique among Destroyer-types in that it has no torpedo capability. Based on the example of the *Knox* (FR 1940) class Frigate, it was decided that a pair of megaphaser cannon would more than make up for the lack of torpedoes. Said lack was not necessitated by the positioning of the two nacelles, but rather by weight restrictions.

### **Shake-down Trials**

Trial results were better than predicted with regards to speed - far better than her older, larger sister classes. Maneuverability was reduced as expected (due to the nacelle deployment) - more so than with the *Scimitar* class Fast Destroyer - and unlike the Fast Destroyer this loss of maneuver-

## Dupleix - Class Perimeter Action Ship

### Vessel Specifications & Related Data:

Prototype Name:	U.S.S. <i>Dupleix</i>
Construction Contract:	NCC-2346
Series:	Class 1b Starship
Design:	Escort
Type:	Perimeter Action Ship (PA)
Complement:	38 Officers 273 Enlisted Crewmen
Overall Length:	268.5 meters
Overall Draft:	73.9 meters
Overall Beam:	141.7 meters
Displacement:	123,000 tonnes

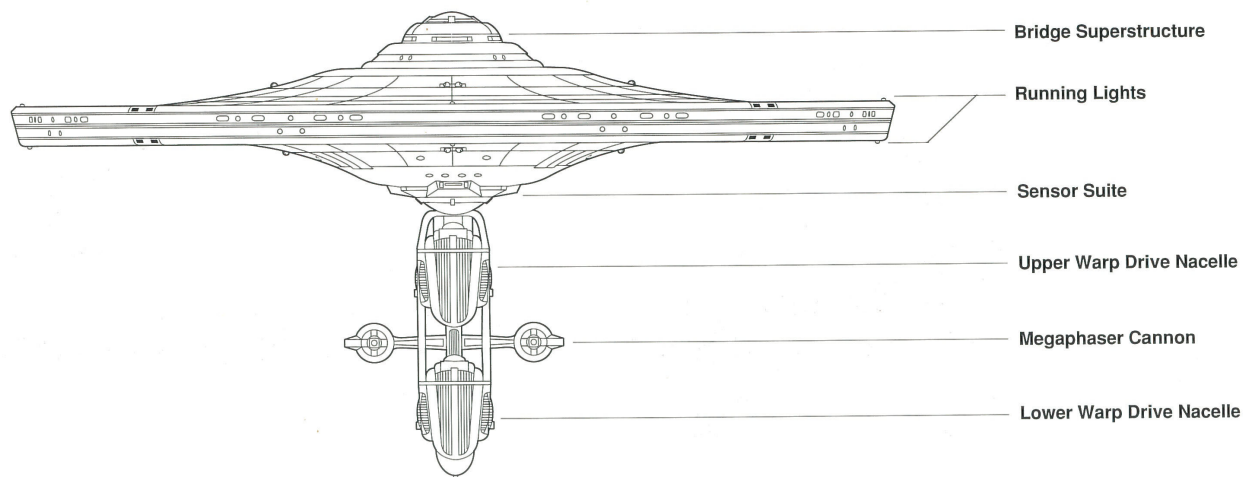

ability was reflected in warp as well as impulse handling. Ordnance performance was excellent, with both phasers and megaphasers being provided optimum power levels. This is due to the presence of an auxiliary fusion reactor, dedicated to the ordnance systems.

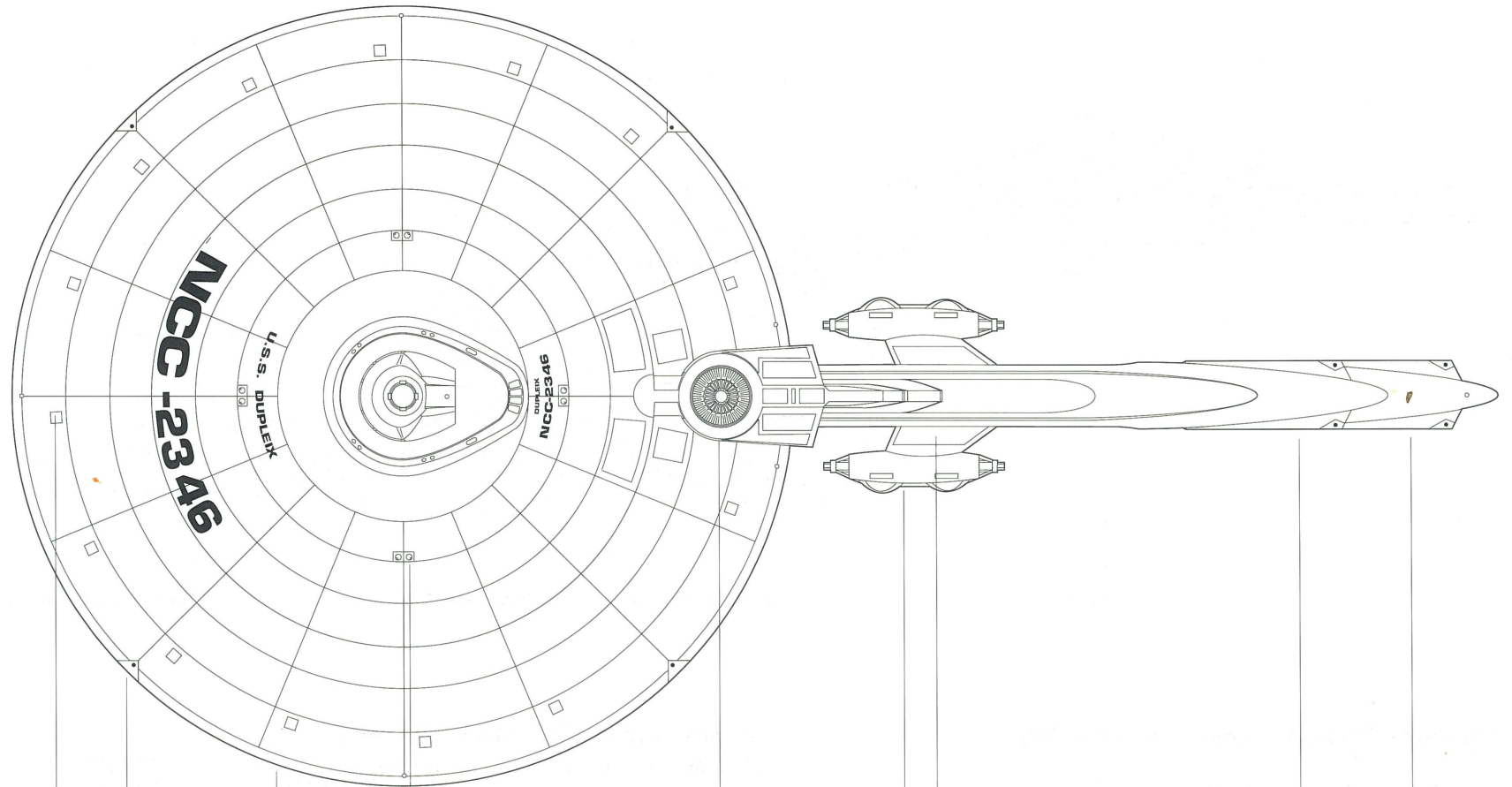

- Personnel Hatch
- Reaction Control Thruster Package
- Primary Hull
- Phaser Bank
- Impulse Drive
- Megaphaser Cannon
- Cannon Support Strut
- Upper Warp Drive Nacelle
- Lower Warp Drive Nacelle

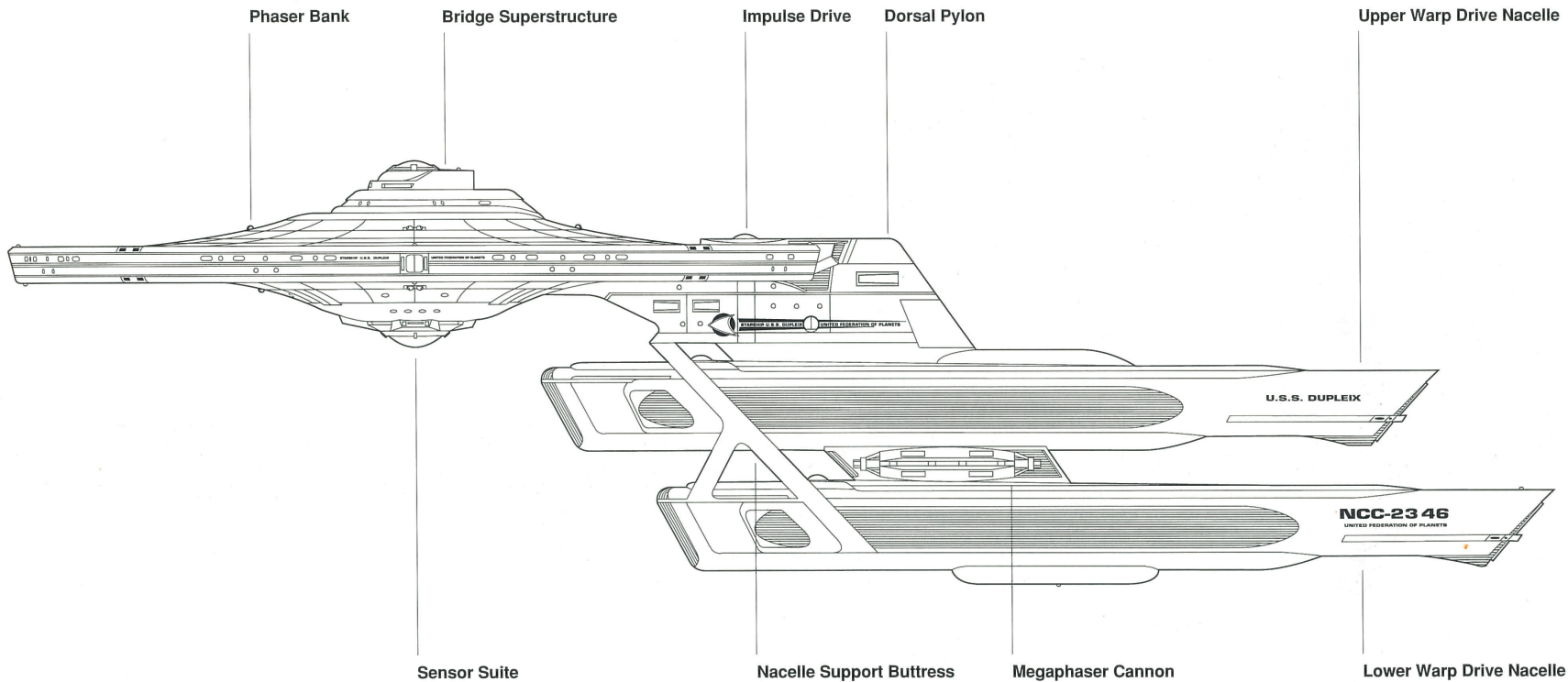

## Dupleix - Class Perimeter Action Ship

### Performance Characteristics (Static):

Warp Dynamic Efficiency:	Power Coefficient Indice	1.026
Powerplant:	Maximum Output	$2.2 \times 10^{15}$
	Optimum Output	$1.6 \times 10^{15}$
Subspace Field:	Field Strength	$2.5 \times 10^8$
	Field Threshold	$9.1 \times 10^9$
	Field Persistence	7.1
	Field Radius	303.4
	Field Capacity	196,000

### Performance Characteristics (Dynamic):

Structural Strain Parameters:	Differential Stress (Prime)	$1.53 \times 10^7$
	Differential Stress (Beta)	$4.4 \times 10^6$
	Differential Stress (Gamma)	$2.2 \times 10^6$
	Differential Stress (Delta)	$1.0 \times 10^6$
Warp speed Handling:	Warp Acceleration Rate	2.3
	Warp Deceleration Rate	1.7
	Warp Attitude Change Rate	0.411
	Impulse Acceleration Rate	2.0
Sublight Handling:	Impulse Deceleration Rate	2.9
	Impulse Attitude Change Rate	0.296
	Speed Performance:	Cruising Speed
Flank Speed		wf10.8
Emergency Maximum Speed		wf14.0

SCIMITAR NCC-2901



# U.S.S. *Scimitar*

## DF 2901 Class Fast Destroyer

### ***Scimitar* (DF 2901) class Fast Destroyer Design Philosophy & Purpose:**

"The *Scimitar* class Fast Destroyer is the first attempt to achieve tandem nacelles (on an Escort design starship)".

Because of their relative economy (in terms of construction, operational, and support costs), Starfleet is always seeking new variants of the Escort-design. Escort-design starships (Scout and Destroyer-types) feature a primary hull and nacelles - no secondary or extended hull. The description used to state primary hull and one nacelle, but this edition of **PROTOTYPE** introduces three variants which make that description obsolete.

The economy of the Escort-design is due to the simplicity of the design. Construction costs are low since there are relatively fewer structures incorporated into the ship than is the case with their larger Class 1-b cousins. Operational costs are lower since fewer personnel are required to man them. Support costs involve fuel economy and Warp Dynamics. A single-nacelle driven Destroyer is extremely fuel efficient. It is not as fast as its larger, dual-nacelle relatives the Frigate- and Cruiser-designs, but for a given warp factor it expends measurably less fuel. Theoretically, adding a second nacelle would make the Destroyer potentially faster than either Frigate or Cruiser-designs with regards to the strain limits which set Cruising-, Flank-, and Emergency- Speeds, since each nacelle would only have half the load of a primary hull. However, the second nacelle would also make the Destroyer less fuel efficient, requiring more fuel for any given

speed, and thus reducing its range markedly from before. The speed gain was extremely attractive to Starfleet, but conceiving of the most efficient twin nacelle deployment has been troublesome. The *Dupleix*' (PA 2346) nacelle deployment was deemed unsuitable for a Destroyer, it is potentially faster than the layout chosen for the *Scimitar* (DF 2901) class, but the retarded maneuverability of the *Dupleix* would be fatal in a Destroyer's close-in fighting role. It was hoped that although speed would be increased, such factors as maneuverability would remain similar to the *Siva* (DD 520) class Destroyer.

The *Scimitar* class Fast Destroyer is the first attempt to achieve tandem nacelles at the bottom of a dorsal pylon. To accommodate same, Strategic Design relocated the photon torpedo complex' shroud to a position below the nacelles with two tubes firing to fore and aft. The *Scimitar* class was chosen as the test vessel for the new BackUP phaser/torpedo augmentation (see article in this issue of **PROTOTYPE**). It is also test vessel for the controversial Perseus Shield System.

The BackUP phaser system reflects three years of research to enhance photon torpedo fire-power without increasing the size of the warhead (which would necessitate changing all starship tubes and torpedo loads). It involves a single phaser turret mounted near the torpedo tubes, facing the

## Scimitar - Class Fast Destroyer

### Vessel Specifications & Related Data:

Prototype Name:	U.S.S. <i>Scimitar</i>
Construction Contract:	NCC-2901
Series:	Class 1b Starship
Design:	Escort
Type:	Fast Destroyer (DF)
Complement:	40 Officers 280 Enlisted Crewmen
Overall Length:	256.5 meters
Overall Draft:	58.7 meters
Overall Beam:	144.0 meters
Displacement:	126,000 tonnes

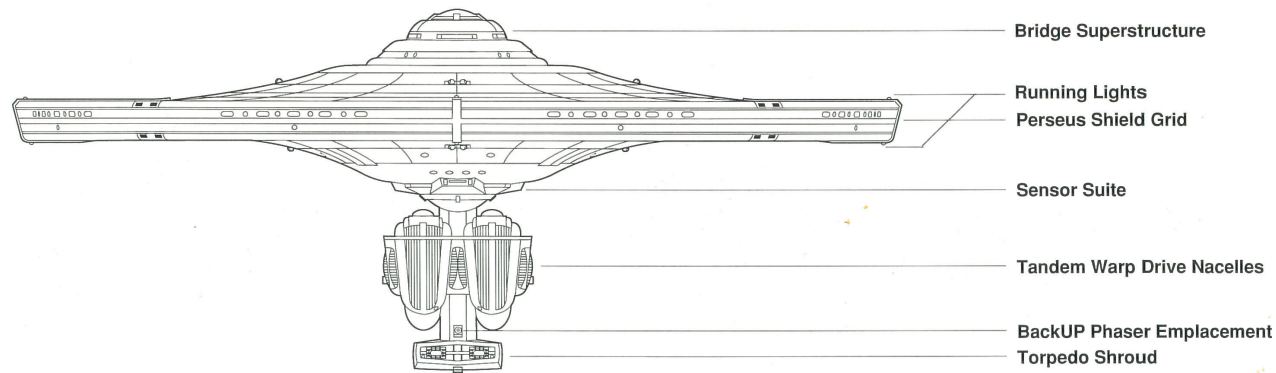

direction of fire. When the torpedo is fired, the turret energizes at a low setting, and the phaser beam touches the rear of the torpedo and tracks it to the target. As the instant of target impact occurs, the phaser turret increases to full power for a 0.5 second burst. If the torpedo detonates but does not buckle the target vessel's shields, the extra energy of the phaser burst, right on the same section of shield, is almost certain to do so. If the torpedo detonates and does buckle the shield, but all or most of the warhead's energy is absorbed in buckling the shield, the burst will fire past the missing shield section, impacting the vessel.

### Shake-down Trials

Trial results backed up the computer simulation predictions, with stress reduced per given warp factor, allowing the vessel to increase Cruising-, Flank-, and Emergency-Speeds. Maneuverability during sublight testing was slightly decreased due to the additional mass, but this did not affect warp maneuverability, which is based upon the ability of the nacelles to rotate the subspace warp field. Ordnance performance (phasers and torpedoes) was expected to be as per the *Siva* class Destroyer, and was except at the higher end of the speed spectrum, where nacelle power demands tended to draw too much power from the grid once the vessel accelerated past Flank-Speed. This was partially compensated-for by the

craft's four torpedo tubes. The class may be retrofitted with a dedicated fusion reactor to assist in powering its phaser weapons (notably the BackUP system) during extreme propulsion draw. For this reason, the dorsal pylon has been extended aft to make room for same.

The Perseus Shield System, while functional, did not notably outperform the standard Adamant System, and therefore did not justify the slight negative influence the grid imposed upon the vessel's warp dynamics.



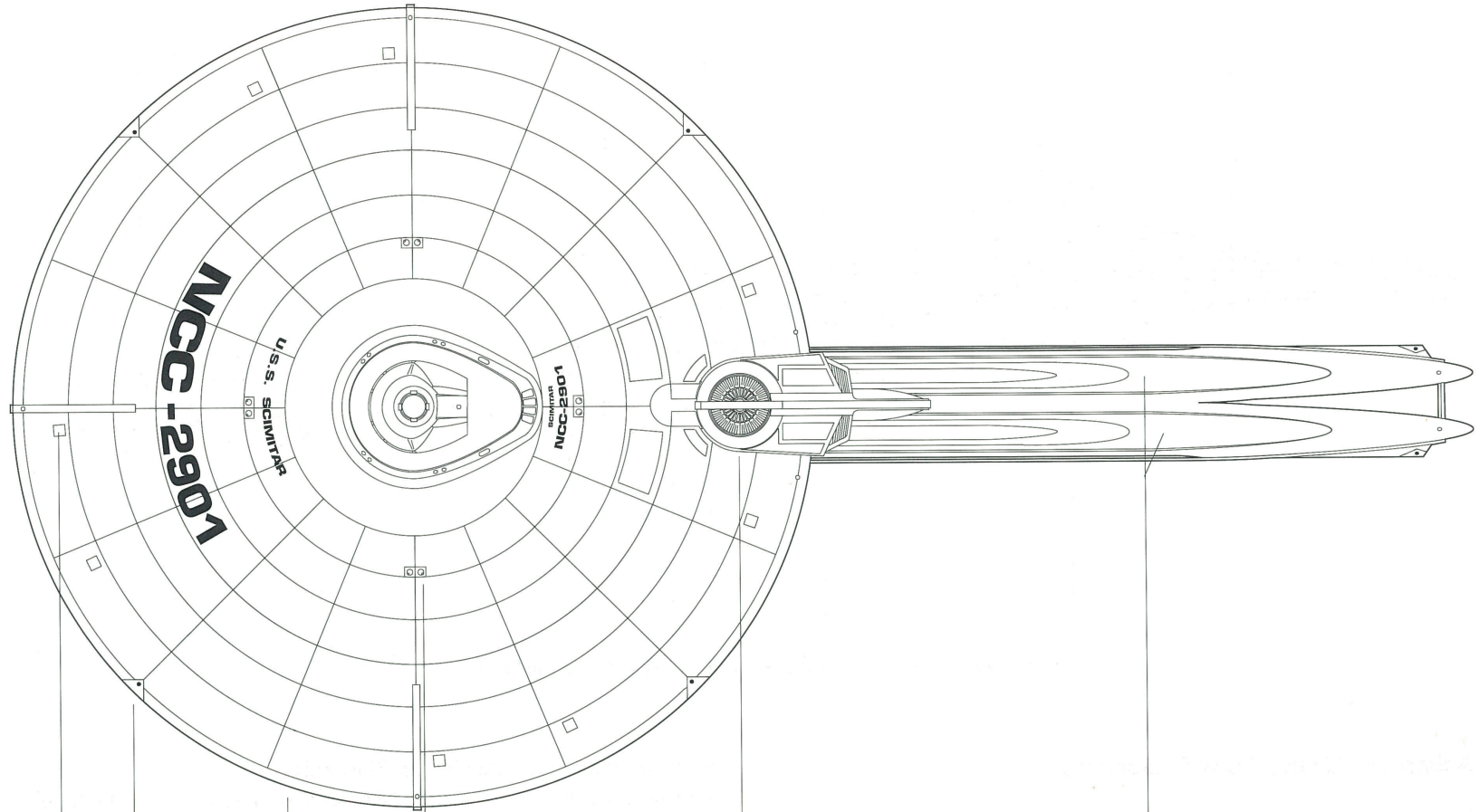

**NCC-2901**

U.S.S. SCIMITAR

SCIMITAR  
NCC-2901

- Personnel Hatch
- Reaction Control Thruster Package
- Primary Hull
- Perseus Shield Grid
- Phaser Bank
- Impulse Drive
- Tandem Warp Drive Nacelles

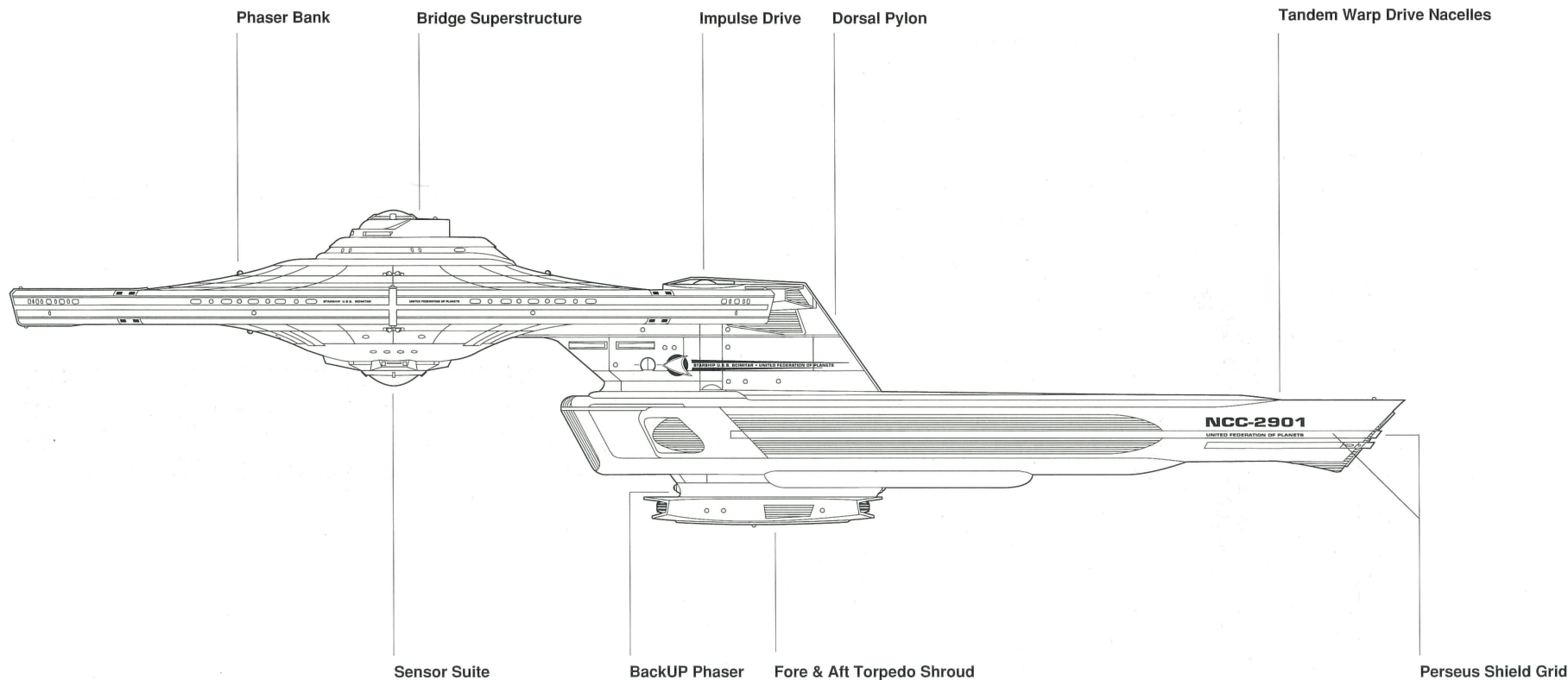

## Scimitar - Class Fast Destroyer

### Performance Characteristics (Static):

Warp Dynamic Efficiency:	Power Coefficient Indice	1.4
Powerplant:	Maximum Output	$2.2 \times 10^{15}$
	Optimum Output	$1.6 \times 10^{15}$
Subspace Field:	Field Strength	$2.6 \times 10^8$
	Field Threshold	$9.3 \times 10^9$
	Field Persistence	7.4
	Field Radius	316.2
	Field Capacity	200,000

### Performance Characteristics (Dynamic):

Structural Strain Parameters:	Differential Stress (Prime)	$1.57 \times 10^7$
	Differential Stress (Beta)	$4.3 \times 10^6$
	Differential Stress (Gamma)	$2.4 \times 10^6$
	Differential Stress (Delta)	$1.1 \times 10^6$
Warp speed Handling:	Warp Acceleration Rate	2.5
	Warp Deceleration Rate	2.1
	Warp Attitude Change Rate	0.391
	Impulse Acceleration Rate	2.2
Sublight Handling:	Impulse Deceleration Rate	3.1
	Impulse Attitude Change Rate	0.278
	Cruising Speed	wf8.3
Speed Performance:	Flank Speed	wf10.5
	Emergency Maximum Speed	wf12.4

# PHANTOM

NCC-2951 • Superscout

## U.S.S. *Phantom* SS 2951 Class Superscout

"One complaint which Starfleet Tactical has often voiced is the lack of mobile covert sensor platforms".

### **Phantom (SS 2951) class Superscout Design Philosophy & Purpose:**

The third Escort-Class prototype released this year is the *Phantom* (SS 2951) class Superscout, joining the five extant classes. One complaint which Starfleet Tactical has often voiced is the lack of mobile covert sensor platforms to back up its system of fixed-position Epsilon-Series Covert Monitoring Stations (stationed on the edge of the Neutral Zones), which use enormous arrays of passive sensors to gather data from the Klingon and Romulan Empires.

An active sensor is made up of both a transmitter and a receiver for electromagnetic and tachyonic waves - much like 20th Century radar. Said waves are transmitted, and proceed through space until they impinge upon a phenomena (planet, nebula, star, vessel, etc.), whereupon they are reflected back to the sensor's receiver, which analyses any changes to the waves and thus deduces the nature of the said phenomena. A passive sensor emits no radiation/waves, but is composed entirely of receiver, which picks up the natural radiations of phenomena, as well as the waste-by-product emissions of spacecraft. Active sensors have much greater range for a given size, but are hardly covert - their out-going emissions can be detected by other vessels. For this reason the *Monoceros* (ST 601) class Scout, and all five of the *Kruger* (SS 1090) class, *Reliance* (SS 915) class, *Ianetos* (SS 710) class, *Kestral* (SS 3000) class, and *Austin* (SS 1318) class

Superscouts were rejected by Tacfleet for this role, their sensors are much more powerful than the norm for starships, but this is an active sensor gain. What Tacfleet wanted was a vessel with no sensor emissions at all.

The mobile platform selected was the *Phantom* (SS 2951) class Superscout. Because of the size of passive array needed to achieve the range Tacfleet needed, the sensors are housed in a pod slung below the warp drive units. There are hazards inherent in this Superscout's mission - either Empire might object to such close scrutiny and send warships to intercept. Therefore, Tacfleet insisted that the *Phantom* class be able to escape. To give it the speed necessary to outrun enemy vessels, the designers gave this Superscout the vertical twin warp nacelles developed for the *Dupleix* (PA 2346) class Perimeter Action Vessel. Although both Cruising- and Flank- Speeds were expected to be similar to the *Dupleix* class (albeit reduced because of the additional weight of the sensor pod), the ship was specifically designed to reduce the structural stresses caused by running at high warp - hopefully giving the Superscout a truly incredible Emergency- Maximum Speed - at the willing sacrifice of maneuverability. In an extreme emergency, such as the Superscout being chased and in danger of being overtaken by an enemy vessel, the entire sensor pod can be jettisoned, which might give the vessel the speed margin necessary to

## Phantom - Class Superscout

### Vessel Specifications & Related Data:

Prototype Name:	U.S.S. <i>Phantom</i>
Construction Contract:	NCC-2951
Series:	Class 1b Starship
Design:	Escort
Type:	Superscout (SS)
Complement:	30 Officers 270 Enlisted Crewmen
Overall Length:	268.5 meters
Overall Draft:	85.9 meters
Overall Beam:	141.7 meters
Displacement:	139,000 tonnes

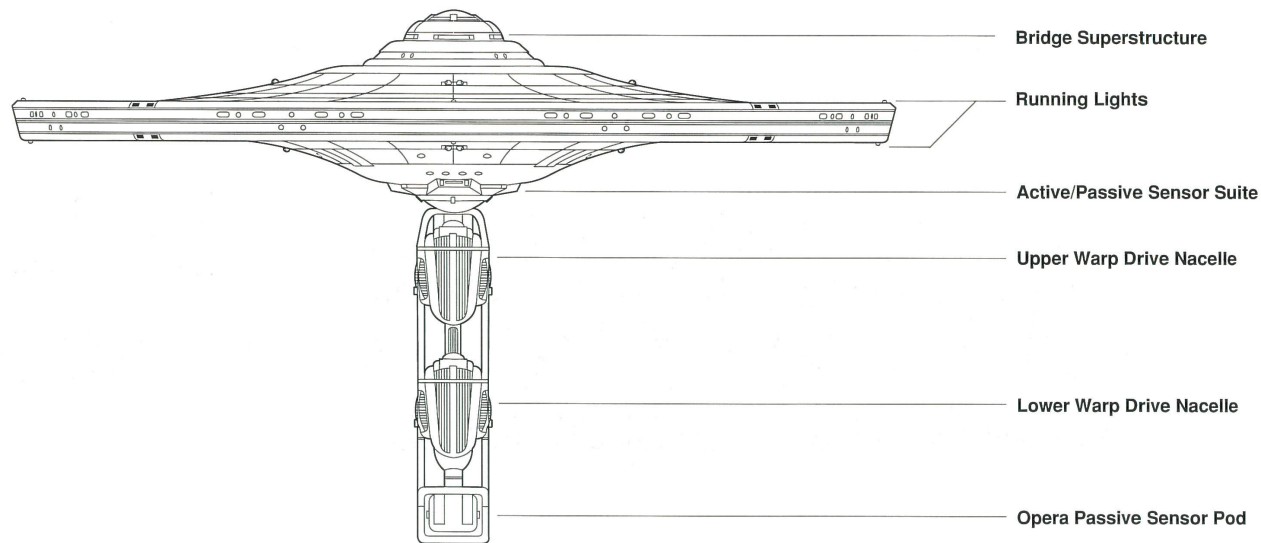

evade (and would certainly help its maneuverability). The pod is self-destructed via emplaced scuttle charges fifteen seconds after jettison, to prevent an enemy from gaining possession of advanced Federation sensor technology.

The Superscout has two operating modes. In the primary, it drops out of warp, holding station for days at a time - with no subspace field for enemy ships to detect. For the secondary, it utilizes an engine feature unique to this design. The lower warp drive unit is powered-down, leaving the upper one operating at low power (warp factor 1 - 3). This technique is known as trailing one nacelle, and allows the vessel moderate mobility with minimum subspace emissions.

The sensitivity of the "Opera" OC9878Z passive array is classified, but it is estimated that the vessel can monitor a volume of space in excess of 15 parsecs radius. In addition to the sensors, the starship possesses dedicated onboard computer nets, aiding it in the following roles:

- Eavesdrop on enemy communications - said acquired data to be decrypted onboard and delivered to the Tacfleet Operations Base.
- Monitor enemy fleet movement via detection and tracking of their subspace warp fields. Since each vessel's field is unique, its signature

can be used (in conjunction with intercepted communications) to identify individual vessels.

- Detect and monitor enemy vessel sensor sidelobes (stray emissions), said data being used to analyze enemy sensor characteristics.

### Shake-down Trials

Trial results must be divided between vessel performance and sensor performance. Maneuverability during sublight testing was slightly decreased due to the additional mass of the sensor pod. Warp maneuverability was severely curtailed, again due to the additional mass, its placement below the nacelles, and the higher placement of the nacelles themselves - but this was deemed irrelevant, as the *Phantom* class will not be expected to fight - her prime evasive maneuver is, simply put, to vacate a dangerous situation at maximum warpspeed - which is higher than any pursuing enemy is likely to possess.

Ordnance performance (phasers and defense fields) is strictly as per the *Monoceros* class Scout. Sensor performance has not been released, but in view of the class' going into production, must be assumed adequate.

All Superscouts operate under the Starfleet Tactical Directorate, and seven vessels have been ordered.

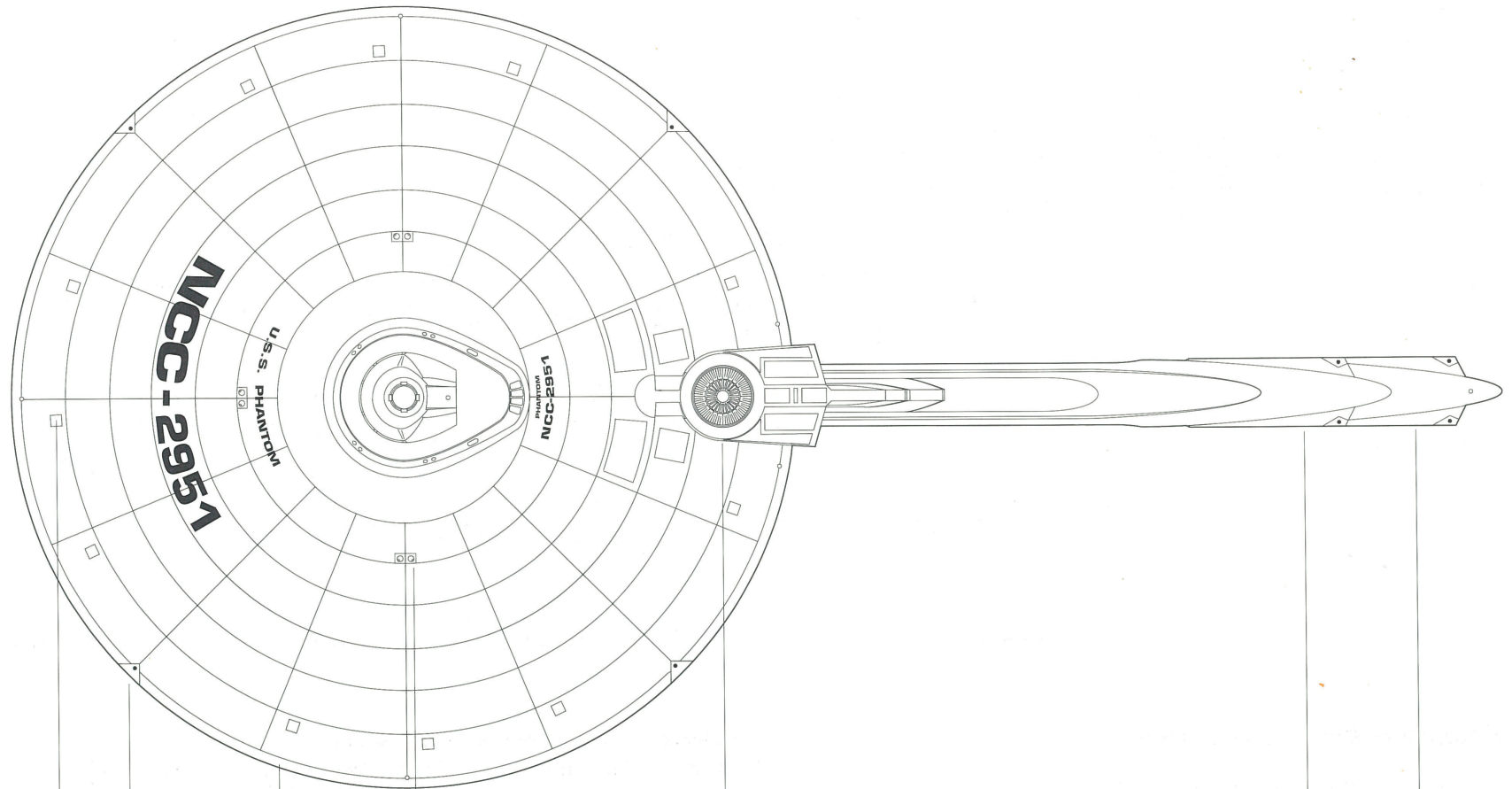

Reaction Control Thruster Package

Personnel Hatch

Primary Hull

Phaser Bank

Impulse Drive

Upper Warp Drive Nacelle

Lower Warp Drive Nacelle

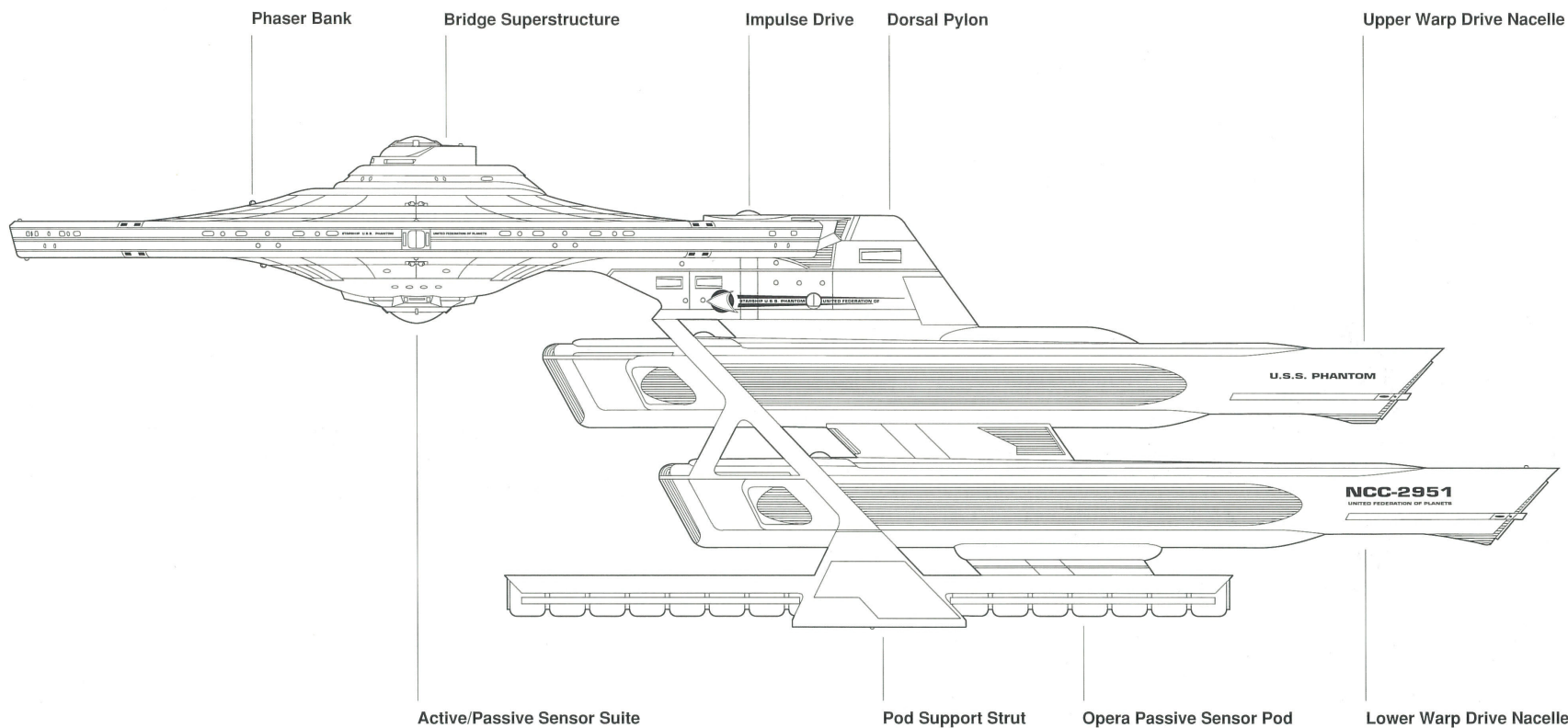

## Phantom - Class Superscout

### Performance Characteristics (Static):

Warp Dynamic Efficiency:	Power Coefficient Indice	1.041
Powerplant:	Maximum Output	$2.2 \times 10^{15}$
	Optimum Output	$1.6 \times 10^{15}$
Subspace Field:	Field Strength	$2.6 \times 10^8$
	Field Threshold	$9.3 \times 10^9$
	Field Persistence	7.4
	Field Radius	316.4
	Field Capacity	200,000

### Performance Characteristics (Dynamic):

Structural Strain Parameters:	Differential Stress (Prime)	$1.57 \times 10^7$
	Differential Stress (Beta)	$4.8 \times 10^6$
	Differential Stress (Gamma)	$2.8 \times 10^6$
	Differential Stress (Delta)	$1.7 \times 10^6$
Warp speed Handling:	Warp Acceleration Rate	3.1
	Warp Deceleration Rate	2.3
	Warp Attitude Change Rate	0.55
	Impulse Acceleration Rate	2.2
Sublight Handling:	Impulse Deceleration Rate	3.0
	Impulse Attitude Change Rate	0.346
	Speed Performance:	Cruising Speed
Flank Speed		wf10.3
Emergency Maximum Speed		wf13.6



# U.S.S. *Davenport*

## CV 2635 Class Corvette

"The result is a light, fast, and most maneuverable starship, ...generally utilized in a special mission capacity..."

### ***Davenport* (CV 2635) class Corvette Design Philosophy & Purpose:**

The Corvette is possibly the most ambiguous design in the fleet. In theory the term refers to the heaviest Escort Class vessels. In practice it can be made up of any starship design (Frigate and Cruiser included) including an extended or secondary hull, so long as the overall displacement is such that it falls into the Escort category (139,000 tonnes or less). This is normally achieved by excising portions of the primary hull not required for the Corvette's mission objectives. The result is a light, fast, and most maneuverable starship, but one whose range and capabilities are limited when compared to other Class 1 starships (curtailed operating and duration range, smaller or no hangar space, reduced cargo and living quarters space).

Although termed an Escort Class by virtue of its tonnage, Corvettes are generally utilized in a special mission capacity, and as such are assigned to Starfleet Intelligence. Mission profiles for other Corvettes (such as the *Renner* (CV 3250) class) have included covert landing party surveillance, Neutral Zone patrols, and surgical strikes by Marine Assault platoons. The *Davenport* (CV 2635) class Corvette lacks the pocket hangar facilities of the *Renner* class, and therefore cannot carry or launch the Assault Shuttlecraft or Talon Interceptor fightercraft used by the Marine Corps. It does however include limited Marine barracks facilities, as well as twin

Tactical-Group (Platoon) transporters.

In order to improve cannon fire-arc coverage without necessitating the addition of two more cannon emplacements, the cannon were placed at the outer edge of the primary hull - penultimate to the port and starboard running lights. This entailed the removal of portions of said primary hull, with a corresponding loss of tonnage.

The secondary hull is even smaller than that of the *Adamant* (DNF 3029) class Frigate/Dreadnought, and its sole tasks are containing the matter/antimatter reactor, and energy distribution to the primary hull and warp drive nacelles.

### **Shake-down Trials**

This was the first experiment with the novel lateral-orientation nacelle deployment, which promised excellent warp efficiency at the slight expense of maneuverability. Trial results proved better than hoped-for. Not only was the efficiency gain realized, but the expected maneuverability loss was not detected (when compared to another twin nacelle Escort Class vessel of comparable displacement).

## ***Davenport* - Class Corvette**

### **Vessel Specifications & Related Data:**

Prototype Name: U.S.S. *Davenport*  
Construction Contract: NCC-2635  
Series: Class 1b Starship  
Design: Escort  
Type: Corvette (CV)  
Complement: 30 Officers  
245 Enlisted Crewmen  
Overall Length: 300.6 meters  
Overall Draft: 35.9 meters  
Overall Beam: 141.7 meters  
Displacement: 125,000 tonnes

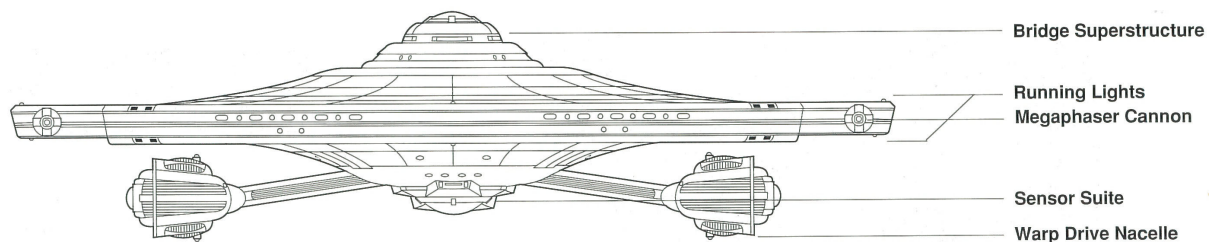



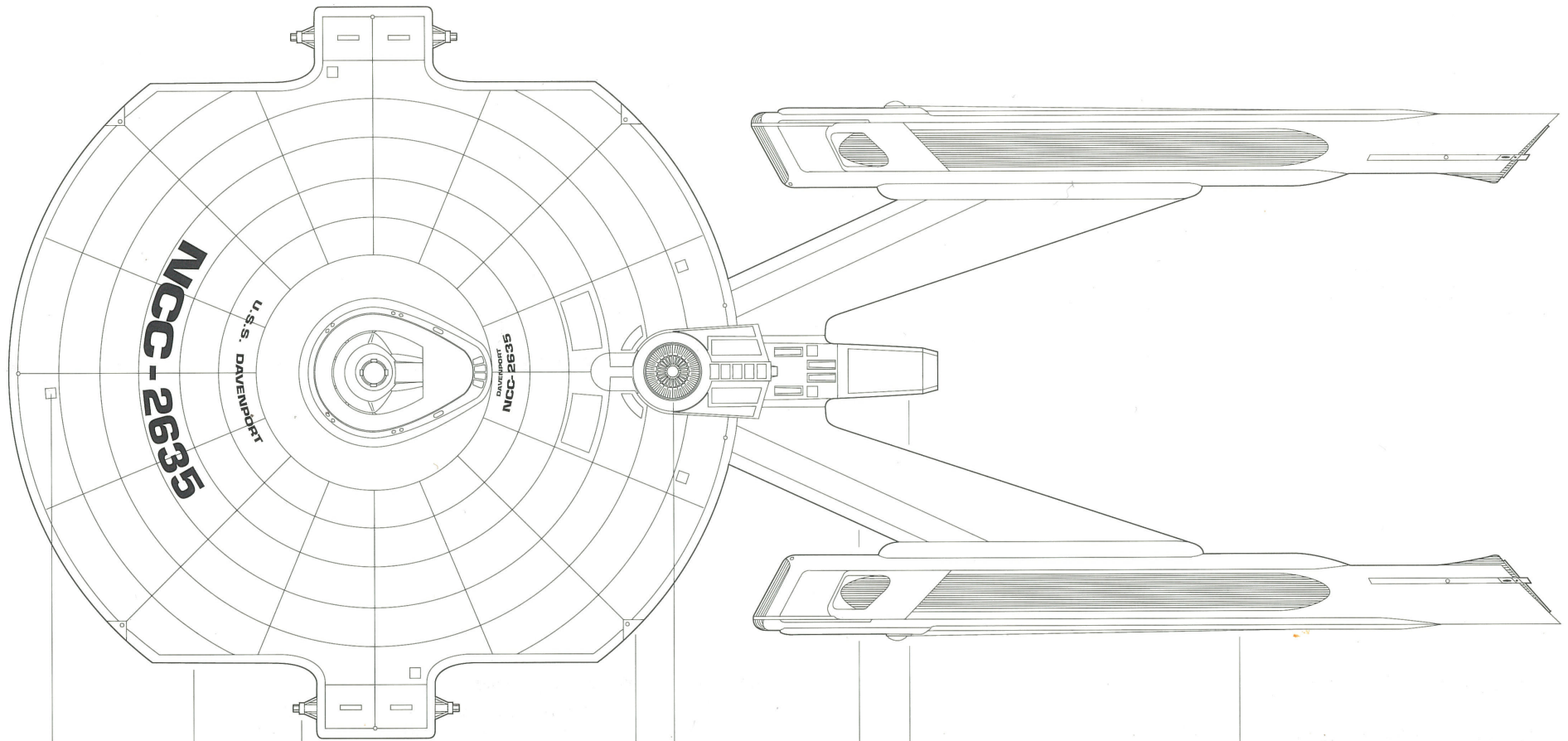

Personnel Hatch

Primary Hull

Megaphaser Cannon

Impulse Drive

Nacelle Support Strut

Reactor Hull

Warp Drive Nacelle

Reaction Control Thruster Package

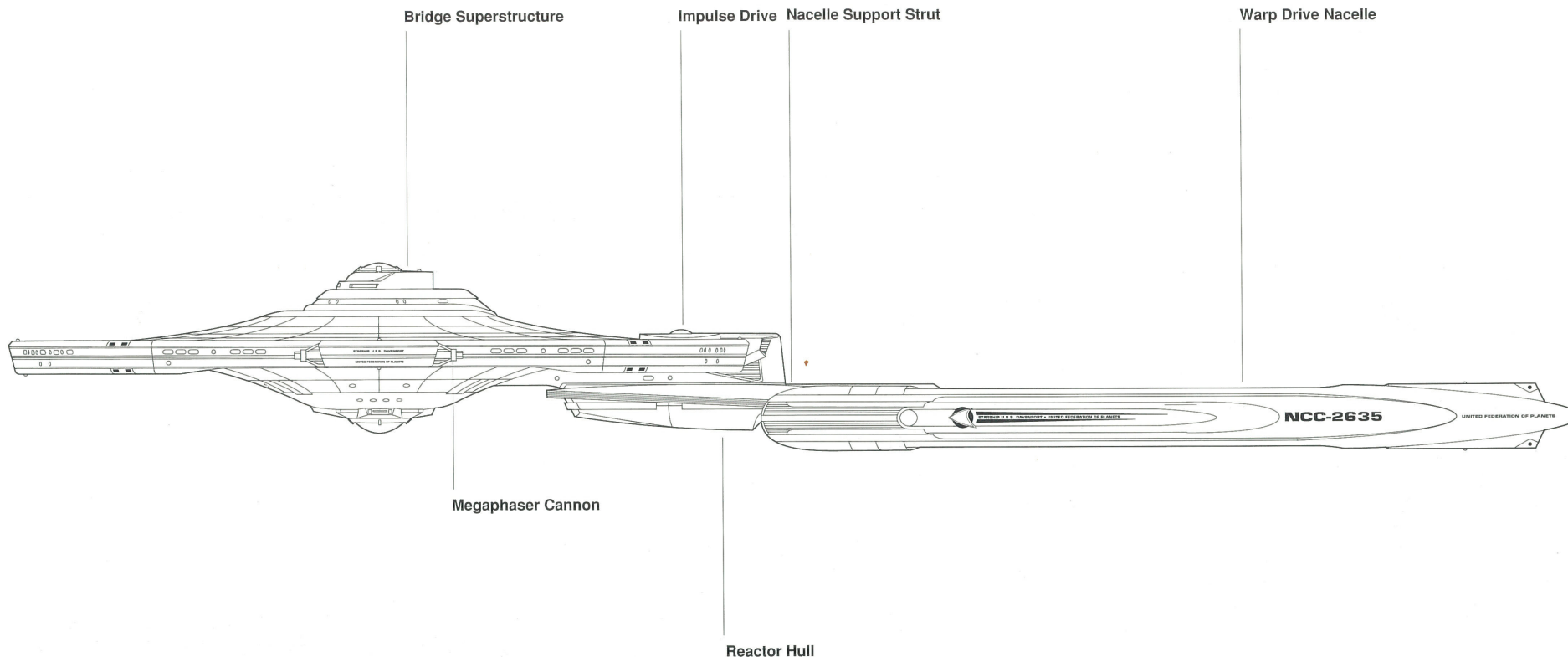

## Davenport - Class Corvette

### Performance Characteristics (Static):

Warp Dynamic Efficiency:	Power Coefficient Indice	1.02
Powerplant:	Maximum Output	$2.4 \times 10^{15}$
	Optimum Output	$1.8 \times 10^{15}$
Subspace Field:	Field Strength	$2.4 \times 10^8$
	Field Threshold	$9.4 \times 10^9$
	Field Persistence	6.2
	Field Radius	400.0
	Field Capacity	200,000

### Performance Characteristics (Dynamic):

Structural Strain Parameters:	Differential Stress (Prime)	$1.42 \times 10^7$
	Differential Stress (Beta)	$4.22 \times 10^6$
	Differential Stress (Gamma)	$2.1 \times 10^6$
	Differential Stress (Delta)	$1.3 \times 10^6$
Warp speed Handling:	Warp Acceleration Rate	2.6
	Warp Deceleration Rate	1.9
	Warp Attitude Change Rate	0.382
Sublight Handling:	Impulse Acceleration Rate	3.0
	Impulse Deceleration Rate	3.6
Speed Performance:	Impulse Attitude Change Rate	0.289
	Cruising Speed	wf8.35
	Flank Speed	wf10.5
	Emergency Maximum Speed	wf13.6





# **New from the Yards...**

## **Auxiliaries:**



NCC-800  
**SCHMIDT**  
Class 2 Tug

# U.S.S. *Schmidt*

## TT 800 Class Tug

"A major drawback of the Transport/Tug series was that it was a starship...The problem is that a Tug really doesn't go...*Where no man has gone before...*"

### **Schmidt (TT 800) class Tug** **Design Philosophy & Purpose:**

Anticipating the de-commissioning of the *Ptolemy* (TT 3801) class Tug fleet, Starfleet put out tenders for designs for a replacement series, said designs to be based upon the Class 2 spaceship. A major drawback of the Transport/Tug-types was that it was a starship. Reflecting the design philosophy fostered by Starfleet at the time, the series had a standard primary hull, incorporating all of the resources of any starship (laboratories, sensor suites, etc.) and requiring a large complement to run same. The problem is that a Tug really doesn't go anywhere, at least not "Where no man has gone before", tending rather to follow the major spacelanes while hauling cargo and passenger containers about. Another problem was its inflexibility - the hard-docking system it utilized to tow said containers was unsuitable for non-standardized loads. Thus, if a Tug was detailed to tow a space station to new coordinates, it could not use its docking system at all, but had to fall back upon its non-specialized (rather weak) standard tractor beam. Thirdly, that enormous primary hull may have been useless, but it was not massless. It was a penalty weight, robbing the Tug of load-towing capacity.

Accordingly, Starfleet de-commissioned the entire fleet, and has been using *Knox* (FR 1940) class Frigates to do the job until a replacement series could be designed. A design has been selected, and the prototype, U.S.S.

*Schmidt* (TT 800) has completed trial runs.

Initial impressions of the new Tug are deceiving. The actual hull of the craft (like all Class 2 spaceships) is unassumingly small - but then it doesn't really have to contain much except powerplant and life support. The mission elements of the Tug are all mounted externally to the hull. The warp nacelles are mounted in their usual positions, to port and starboard of the hull. However, where a normal spaceship has a single secondary hull, the Tug has both secondary and tertiary. Mounted below the primary hull on a roll-bar strut is the tractor beam nacelle. This contains both the rear-facing tractor beam array and a dedicated KR05-P matter/antimatter reactor. The array has a total shear strength of 250,000 tonnes. Mounted above the primary hull on a second roll-bar strut is the impulse nacelle. This unit is as powerful as any Class 1-b impulse drive.

### **Shake-down Trial**

Trial results were predictable - given the reduction of parasitic weight. Without the massive Class 1 Primary Hull, the smaller SW30/3-2 nacelles were easily capable of maintaining a comfortable Cruising-Speed of wf5.0 while towing a load massing 200,000 tonnes (5 Tugs would operate in parallel to tow a space station). During inter-system maneuvering and orbital placement, the powerful impulse drive was still taxed, but did the task adequately. The tractor array also lived up to specifications, with the stress-shear parameter stable at the afore-mentioned load up to speeds of

## Schmidt - Class Tug

### Vessel Specifications & Related Data:

Prototype Name:	U.S.S. <i>Schmidt</i>
Construction Contract:	NCC-800
Series:	Class 2 Spaceship
Design:	Auxiliary
Type:	Tug (TT)
Complement:	12 Officers 50 Enlisted Crewmen
Overall Length:	102.0 meters
Overall Draft:	55.4 meters
Overall Beam:	103.0 meters
Displacement:	35,000 tonnes

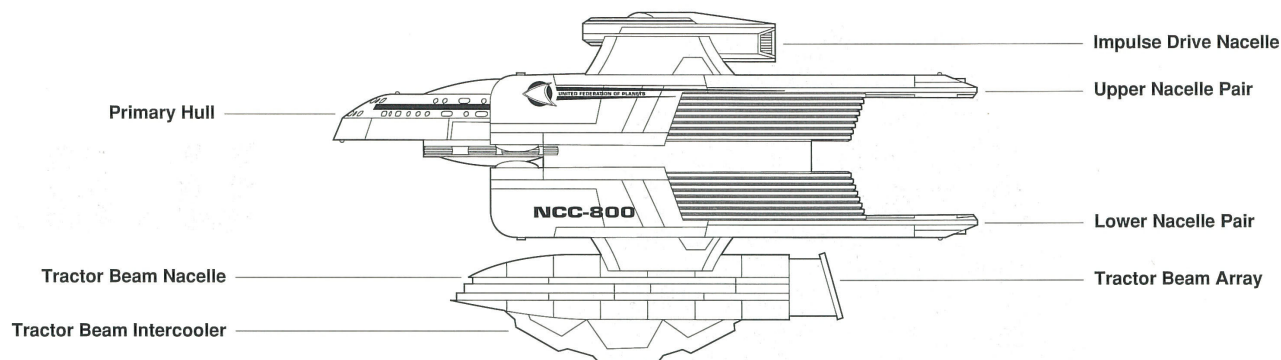

wf5.1. Understandably, warp maneuverability was extremely curtailed, and power to Ordnance Systems (such as phasers and shields) was also unavailable at the Cruising-Speed. Starfleet Logistics has recommended that the vessel be given an escort (Scout or Destroyer) on any loaded run exceeding a distance of 50 parsecs from the Federation center.

### Afterword

The de-commissioned *Ptolemy* class vessels were not scrapped. Metallurgical and structural inspections performed on sample vessels have confirmed that these vessels - although up to 30 years old - are in fairly good shape. Particularly the primary hull's frame and stanchion integrity were found to be almost new. This is understandable in view of the rather sedate operational history of most: of all the original Class 1 starships, these hulls have been punished the least. Accordingly, although the warp and impulse drives were removed and scrapped (along with the support pylons), the primary hulls have been towed and parked at various Starfleet facilities, for conversion/rebuilding to Class 1-b configuration.

As a resource, these 130 primary hulls are proving to be a budgetary windfall, both to Starfleet and to the various ship-building firms which tender contracts to construct new starships. The firms usually include the rebuilding of the primary hulls in their contract, which saves Starfleet Yards from having to do the messy job themselves. The rebuilt hulls are used as the primary hulls for Starfleet's newest Class 1-b prototypes and starships.

### Performance Characteristics (Static):

Warp Dynamic Efficiency:	Power Coefficient Indice	2.1
Powerplant:	Maximum Output	$2.0 \times 10^{15}$
	Optimum Output	$1.4 \times 10^{15}$
Subspace Field:	Field Strength	$4.1 \times 10^8$
	Field Threshold	$4.2 \times 10^9$
	Field Persistence	3.6
	Field Radius	403.0
	Field Capacity	300,000

### Performance Characteristics (Dynamic):

Structural Strain Parameters:	Differential Stress (Prime)	$2.73 \times 10^7$
	Differential Stress (Beta)	$9.2 \times 10^6$
	Differential Stress (Gamma)	$1.2 \times 10^7$
	Differential Stress (Delta)	$8.9 \times 10^6$
Warp speed Handling:	Warp Acceleration Rate	9.77
	Warp Deceleration Rate	8.2
	Warp Attitude Change Rate	2.9
Sublight Handling:	Impulse Acceleration Rate	3.9
	Impulse Deceleration Rate	5.2
	Impulse Attitude Change Rate	9.45
Speed Performance:	Cruising Speed	wf5.0



# U.S.S. *Archangel*

## SC 2294 Class Shuttlecarrier

"The *Archangel* class is only 3% larger by tonnage...,but has approxiamately 125% as much Parking Bay Space..."

### ***Archangel* (SC 2294) class Shuttlecarrier Design Philosophy & Purpose:**

Among Class 1-b starships, the Shuttlecarrier types are the largest. Analogous to the Supercarriers of the Terran late twentieth century, these vessels are constructed for only one purpose: the transport, launching, and support of auxiliary craft.

There are only two shuttlecarrier classes presently in service, comprised of a fleet of six ships. The *Ariel* (SC 2200) class is the oldest and largest of these classes, and is scheduled for decommissioning. Rather than replacing these four vessels with more of the *Fredrikstad* (SC 2204) class, Starfleet Logistics Command requested that Strategic Design attempt to improve upon the basic concept - with a special eye to additional parking space - without enlarging the vessel, which would hamper maneuverability. In fact they also requested that Strategic Design improve said maneuverability - a difficult task in a craft as large as a Shuttlecarrier.

The *Archangel* (SC 2294) class Shuttlecarrier is only three percent larger by tonnage than her immediate predecessor class (well within Logistics Command's mandate), but has approximately 125% as much PB<sup>2</sup> (parking bay space). This was accomplished by completely separating hangar flight deck functions from parking bay functions. The hangar hull incorporates six independent hangars (three each facing starboard and port), each with its own landing platform, tractor beam array, and re-

arm/re-fuel facilities. At the center-line of the hangar hull, between the hangars are the shuttlecraft elevator bays - each holds two shuttlecraft elevators (lowering shuttles to the vast shuttlecraft parking bay below), and is shared by two hangars (e.g.: elevator bay B is shared by hangars 3 & 4), after the shuttles pass through roll-down air-tight doors and force-field pressure curtains. Immediately forward of the hangar hull, within the extended hull are the two fightercraft parking bays - one port of center-line, the other starboard. These hold such attack craft as Tomohawks, Talons, and Killer Bees. There are taxiways between the port fightercraft parking bay and hangar 1, and between the starboard fightercraft parking bay and hangar 2, so that fightercraft need not utilize the elevators for speedy deployment. Hangar bay control rooms are located between the hangar doors. They are only utilized for tractor beam approach and departure sequences. Overall control of flight operations is exercised from the Combat & Information Center.

To improve maneuverability in the face of the *Archangel*' class' displacement, Strategic Design added a second impulse drive below the first. This second drive is normally shut-down, and is only powered-up during battle conditions. Unlike the primary impulse drive (which can be powered by the main reactor or by the auxiliary fusion reactor, it does not draw

## Archangel - Class Shuttlecarrier

### Vessel Specifications & Related Data:

Prototype Name:	U.S.S. <i>Archangel</i>
Construction Contract:	NCC-2294
Series:	Class 1b Starship
Design:	Auxiliary
Type:	Shuttlecarrier (SC)
Complement:	150 Officers 350 Enlisted Crewmen
Overall Length:	300.5 meters
Overall Draft:	52.8 meters
Overall Beam:	141.7 meters
Displacement:	250,000 tonnes

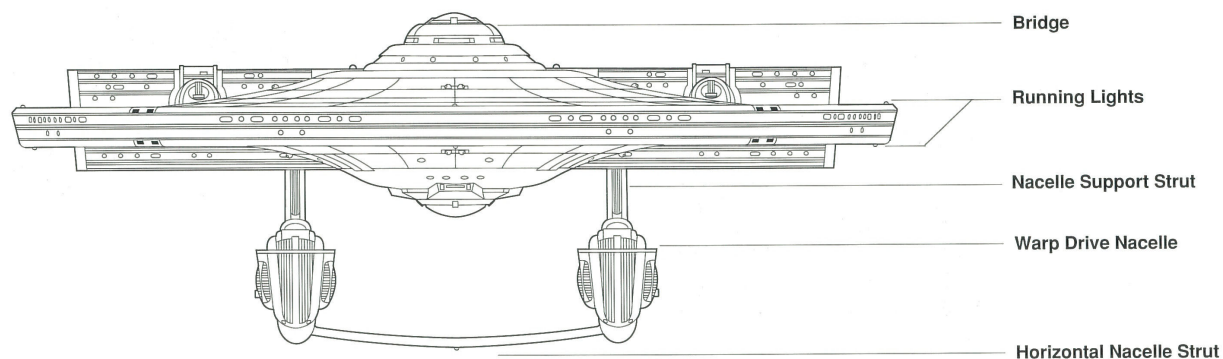

energy from the matter/antimatter reactor at any time, but feeds off its own dedicated fusion reactor. Its principle task is to assist the Shuttlecarrier in making impulse turns, and its exhaust vents have been specially modified to this end.

Shuttlecarriers are lightly armed to save room for mission essentials. There are only eight phaser banks (fourteen turrets), which are set for point defense. A Shuttlecarrier's primary defensive and offensive weaponry are its fightercraft and escorts: Shuttlecarriers never leave port without a pair of Destroyers attending (or as part of a Task Force).

### Shake-down Trials

Overall performance was nominal - the three percent additional mass difference between this prototype and the *Ariel* class being manifested by a reduction in maneuverability during normal sublight maneuvers, but more than compensated for when the second impulse drive was placed on-line. Warspeed capabilities were almost identical to the *Fredrikstad* class. The flight deck/parking bay separation concept was proven out during flight operations - the Flight Deck Officer pronounced the layout not only faster, but safer.



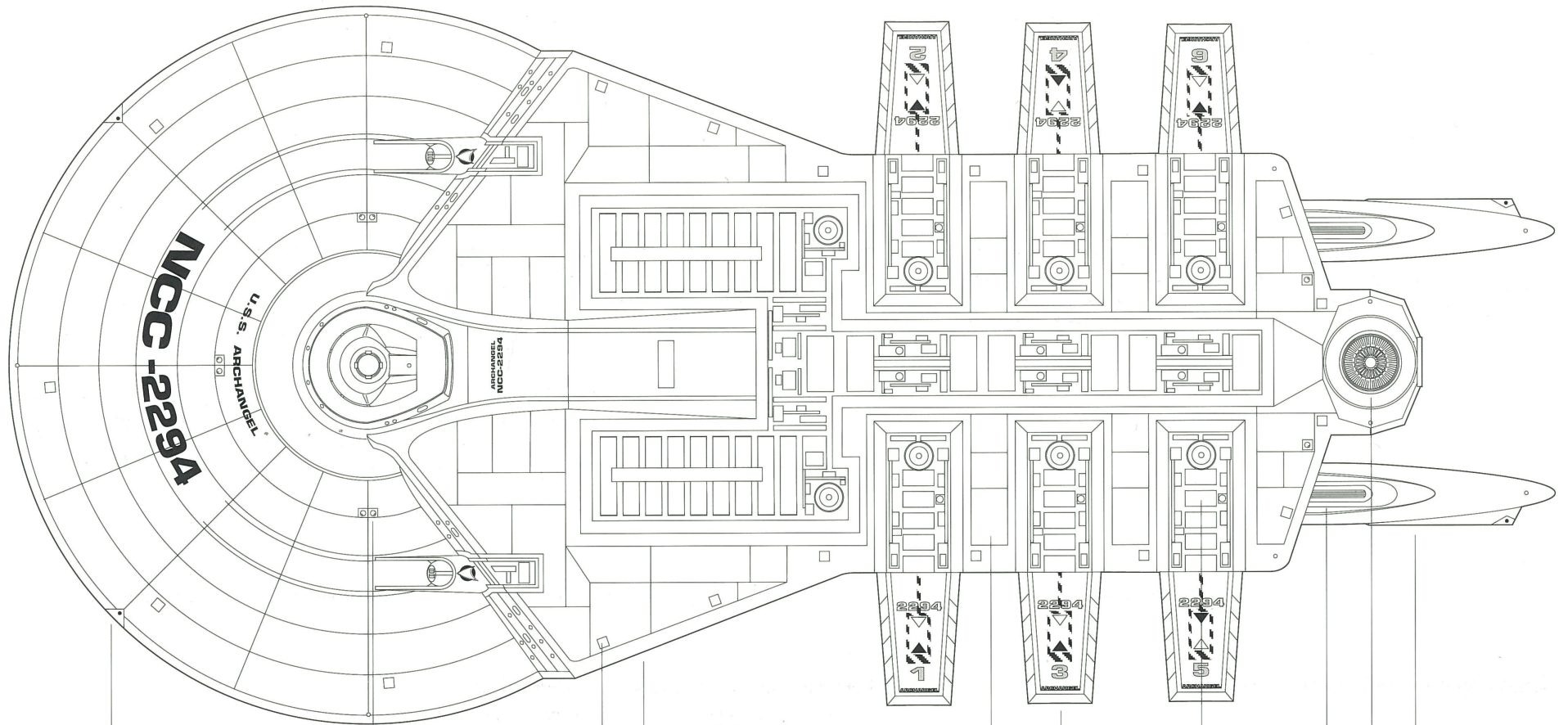

Reaction Control Thruster Package

Primary Hull  
Phaser Bank

Extended Hull  
Personnel Hatch

Landing Platform  
Hangar Hull

Hangar Bay  
Impulse Drive

Warp Drive Nacelle  
Nacelle Support Strut

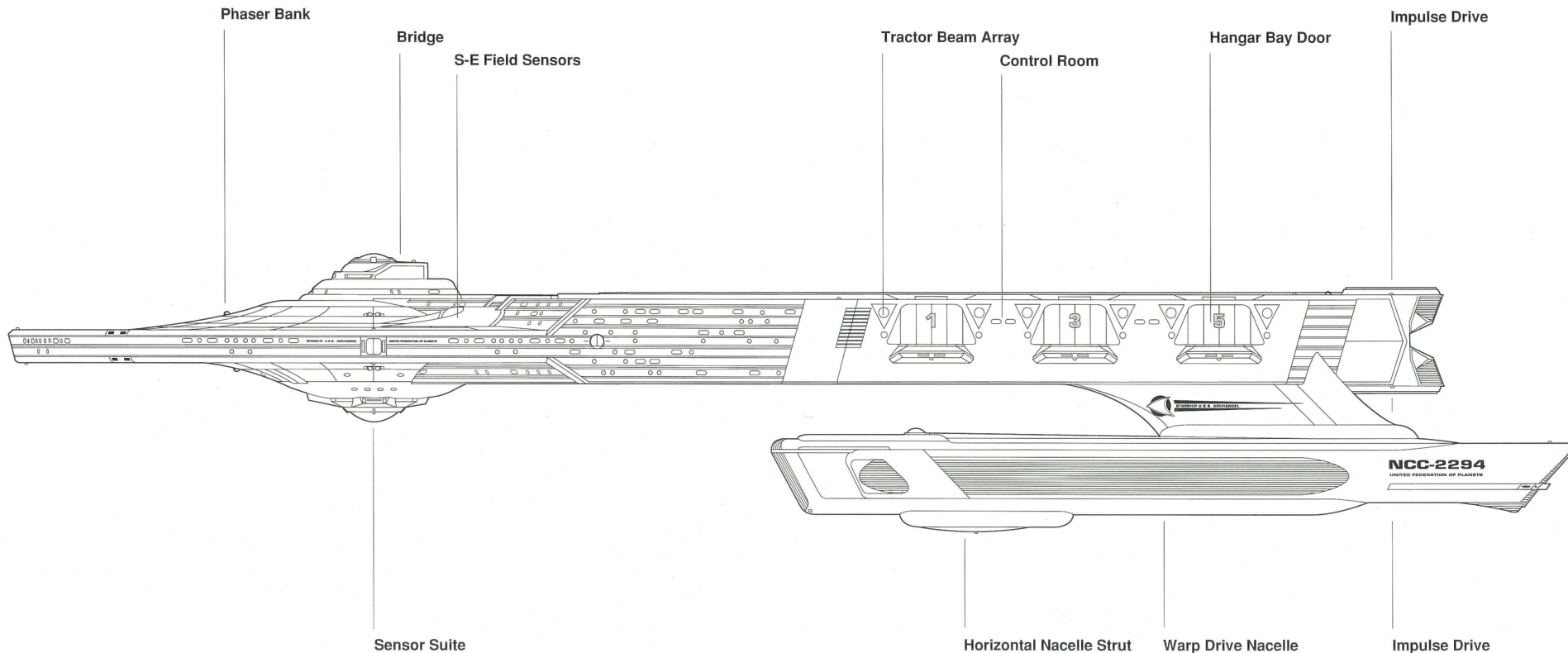

## Archangel - Class Shuttlecarrier

### Performance Characteristics (Static):

Warp Dynamic Efficiency:	Power Coefficient Indice	1.46
Powerplant:	Maximum Output	$2.3 \times 10^{15}$
	Optimum Output	$1.7 \times 10^{15}$
Subspace Field:	Field Strength	$2.97 \times 10^8$
	Field Threshold	$1.35 \times 10^{10}$
	Field Persistence	7.6
	Field Radius	403.0
	Field Capacity	280,000

### Performance Characteristics (Dynamic):

Structural Strain Parameters:	Differential Stress (Prime)	$1.83 \times 10^7$
	Differential Stress (Beta)	$4.36 \times 10^6$
	Differential Stress (Gamma)	$3.25 \times 10^6$
	Differential Stress (Delta)	$1.66 \times 10^6$
Warspeed Handling:	Warp Acceleration Rate	4.7
	Warp Deceleration Rate	3.1
	Warp Attitude Change Rate	0.398
Sublight Handling:	Impulse Acceleration Rate	6.02
	Impulse Deceleration Rate	9.88
	Impulse Attitude Change Rate	0.253
Speed Performance:	Cruising Speed	wf6.8
	Flank Speed	wf7.6
	Emergency Maximum Speed	wf9.5



# In the Design Tank...

(No Logo Authorized)

# U.S.S. *Constellation*

## CN 1017 Class Star Cruiser

### ***Constellation* (CN 1017) class Star Cruiser Design Philosophy & Purpose:**

"...Any way you look at it, the *Constellation* class is a definite departure from established starship designs."

The *Constellation* (CN 1017) class Star Cruiser is presently at the drawing board stage, and the prototype is scheduled to be constructed early in 2297. To look at the external layout the craft would not seem to be a Cruiser-type at all, in view of its Frigate-type extended hull rather than the customary secondary hull, but any way you look at it, the *Constellation* class is a definite departure from established starship designs.

The first innovation is the so-called "laminated hull". This features a wider and thicker addition sandwiched between the upper and lower primary hull surfaces. This portion more than triples the internal volume of the hull, while only doubling the mass, thus increasing the operating duration of the vessel markedly. But perhaps the most striking innovation is the double-tandem perpendicular nacelle design. Due to the tonnage of the vessel, two conventional nacelles would be unable to propel the vessel above wf3.4 without overloading the nacelles. A seeming throwback in the era of the *Excelsior* (CX 2000) class nacelle, the double-tandem perpendicular design represents a different but valid approach to the Star cruiser's intended mission: long-range extended exploration. In addition to being Transwarp-capable in its present deployment, the presence of four nacelles allows a vessel with one or two damaged nacelles the option of re-configuring its remaining units for a wf2.9 return to Federation space. This

was deemed essential, since the *Constellation* class is intended to operate well outside of the Federation, where assistance might be weeks or months away, and a degree of self-sufficiency was vital.

The vessel's hangar and fire-power facilities and capabilities are impressive, bordering on those of the *Adamant* (DNF 3029) class Dreadnought. There are four hangars, two port and starboard. In addition to the three phaser cannon pods mounted beneath the primary hull, there are two separate torpedo pods, each with two tubes facing fore and aft. These pods are mounted between the upper pair of nacelles and between the lower pair as well.

### **Mission Objectives:**

As stated, the mission of the Star Cruisers will be long range extended duration exploration probes, far outside the present boundaries of the Federation Treaty Zone. It is expected that each vessel will undertake a five-year mission. This seems unremarkable until it is realized that the entire five years will be spent exploring extra-Federation space, with no ports-of-call, the only Federation contact being subspace communications and the occasional rendezvous with other far-ranging starships.

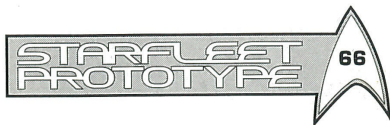

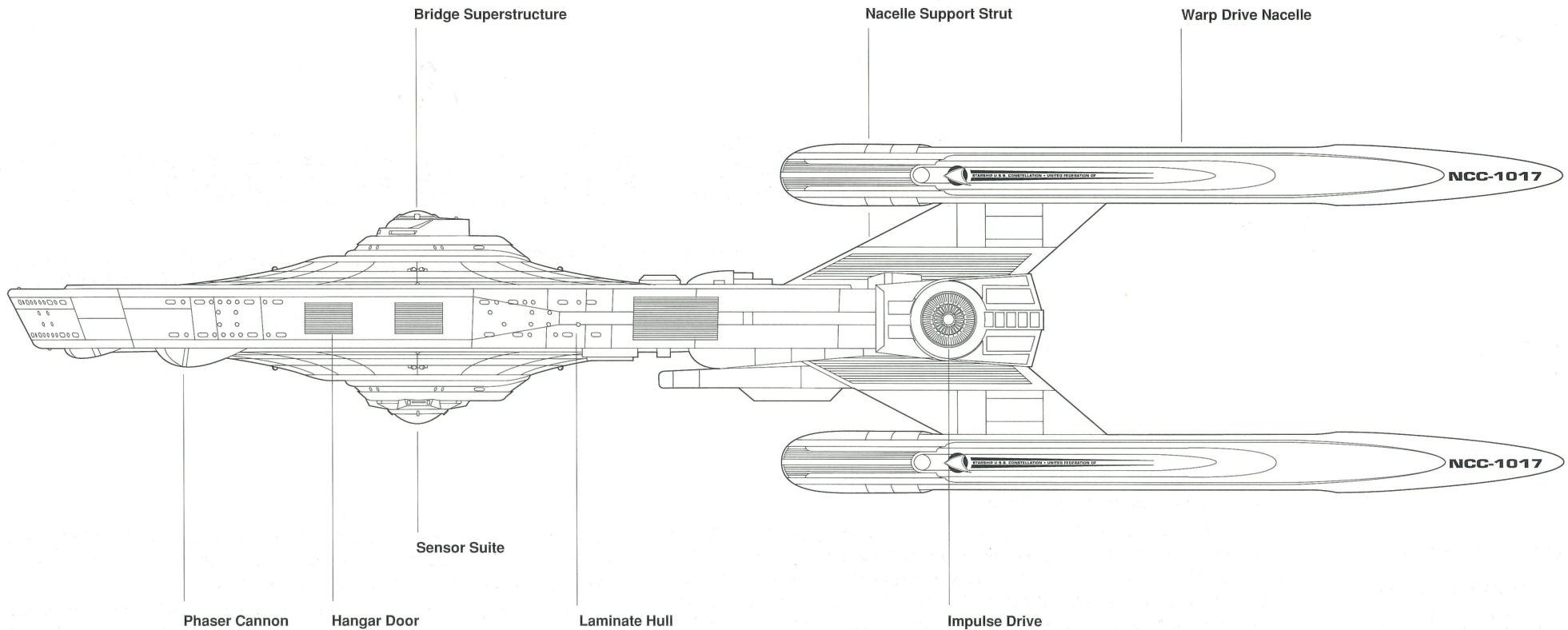

### Constellation - Class Star Cruiser

#### Vessel Specifications & Related Data:

Prototype Name:	U.S.S. <i>Constellation</i>
Construction Contract:	NCC-1017
Series:	Class 1b Starship
Design:	Cruiser
Type:	Star Cruiser (CN)
Complement:	80 Officers 560 Enlisted Crewmen
Overall Length:	313.9 meters
Overall Draft:	61.5 meters
Overall Beam:	141.7 meters
Displacement:	325,000 tonnes

#### Predicted Performance Characteristics (Static):

Warp Dynamic Efficiency:	Power Coefficient Indice	1.44
Powerplant:	Maximum Output	$4.9 \times 10^{15}$
	Optimum Output	$3.7 \times 10^{15}$
Subspace Field:	Field Strength	$6.0 \times 10^8$
	Field Threshold	$2.1 \times 10^{10}$
	Field Persistence	12.5
	Field Radius	587.0
	Field Capacity	500,000



# TacFleet Review...



## ***Ascension* - Class Dreadnought**

### **Vessel Specifications & Related Data:**

Class Name:	U.S.S. <i>Ascension</i>
Construction Contract:	NCC-2520
Series:	Class 1b Starship
Design:	Cruiser
Type:	Dreadnought (DN)
Number in Service:	50
Complement:	80 Officers 450 Enlisted Crewmen
Overall Length:	298.8 meters
Overall Draft:	77.8 meters
Overall Beam:	141.7 meters
Displacement:	245,000 tonnes

# **U.S.S. *Ascension***

## **DN 2520 Class Dreadnought**

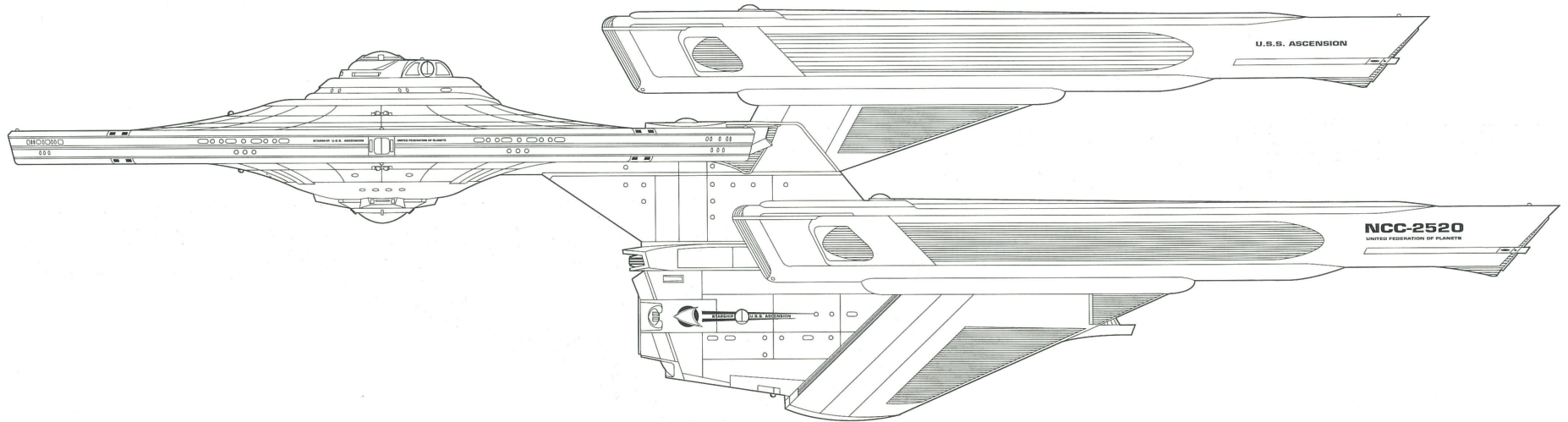

# U.S.S. *Belknap*

## CS 2501 Class Strike Cruiser

### ***Belknap* - Class Strike Cruiser**

#### **Vessel Specifications & Related Data:**

Class Name:	U.S.S. <i>Belknap</i>
Construction Contract:	NCC-2501
Series:	Class 1b Starship
Design:	Cruiser
Type:	Strike Cruiser (CS)
Number in Service	55
Complement:	68 Officers 400 Enlisted Crewmen
Overall Length:	290.0 meters
Overall Draft:	67.5 meters
Overall Beam:	141.7 meters
Displacement:	187,000 tonnes

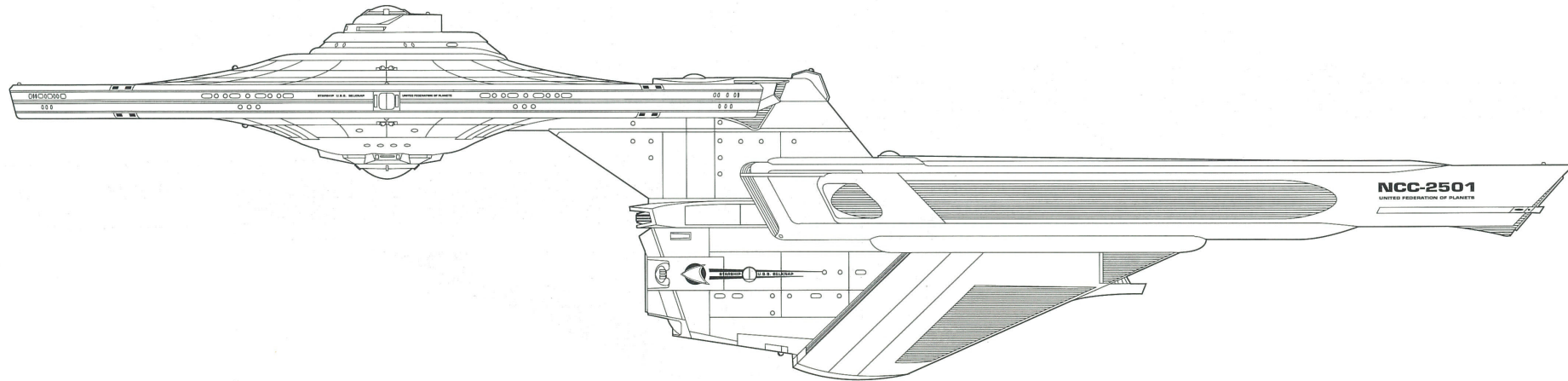

## **Athabaska - Class Exploratory Cruiser**

### **Vessel Specifications & Related Data:**

Class Name:	U.S.S. <i>Athabaska</i>
Construction Contract:	NCC-2560
Series:	Class 1b Starship
Design:	Cruiser
Type:	Exploratory Cruiser (CE)
Number in Service	40
Complement:	70 Officers 420 Enlisted Crewmen
Overall Length:	290.0 meters
Overall Draft:	71.3 meters
Overall Beam:	141.7 meters
Displacement:	190,000 tonnes

# **U.S.S. *Athabaska***

## **CE 2560 Class Exploratory Cruiser**

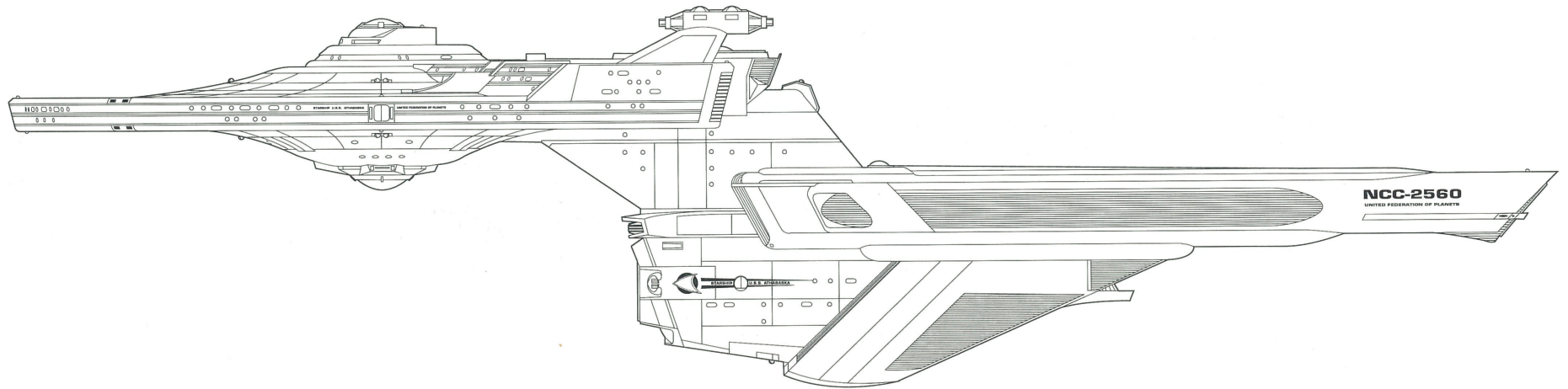

# U.S.S. *Menahga*

## CG 3100 Class Battlecruiser

### ***Menahga* - Class Battlecruiser**

#### **Vessel Specifications & Related Data:**

Class Name:	U.S.S. <i>Menahga</i>
Construction Contract:	NCC-3100
Series:	Class 1b Starship
Design:	Cruiser
Type:	Battlecruiser (CG)
Number in Service	15
Complement:	40 Officers 265 Enlisted Crewmen
Overall Length:	307.0 meters
Overall Draft:	78.0 meters
Overall Beam:	141.7 meters
Displacement:	173,000 tonnes

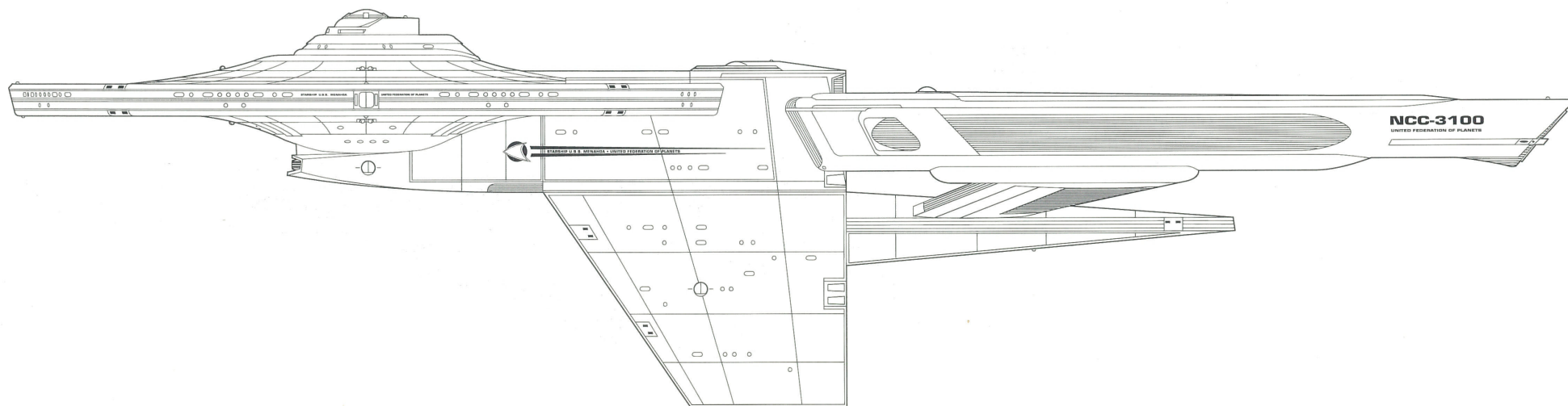

## ***Avenger* - Class Heavy Frigate**

### **Vessel Specifications & Related Data:**

Class Name:	U.S.S. <i>Avenger</i>
Construction Contract:	NCC-1860
Series:	Class 1b Starship
Design:	Frigate
Type:	Heavy Frigate (FH)
Number in Service:	43
Complement:	75 Officers 335 Enlisted Crewmen
Overall Length:	236.0 meters
Overall Draft:	67.8 meters
Overall Beam:	141.7 meters
Displacement:	165,000 tonnes

# **U.S.S. *Avenger***

## **FH 1860 Class Heavy Frigate**

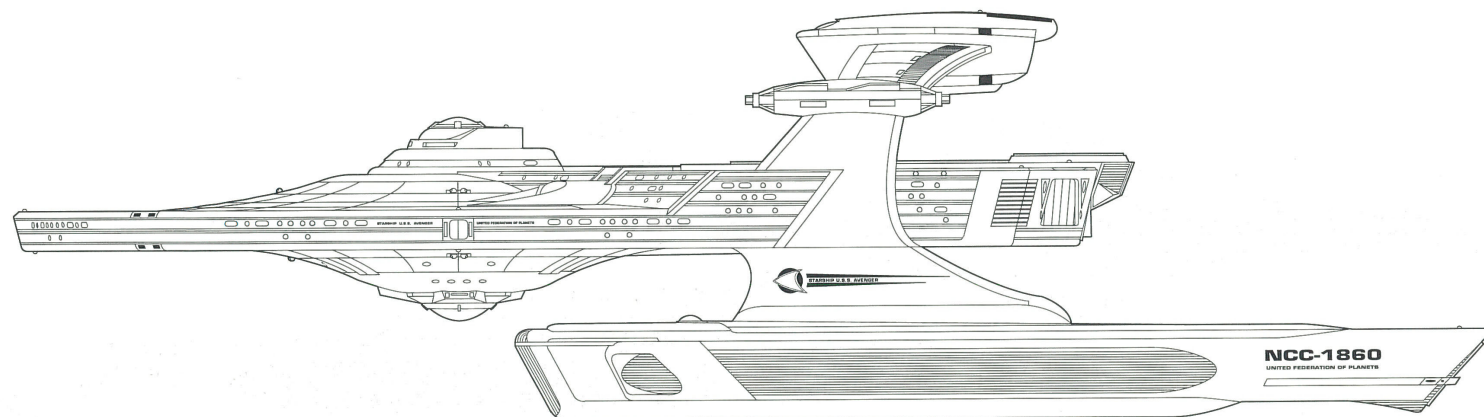

# U.S.S. *Knox*

## FR 1940 Class Frigate

### **Knox - Class Frigate**

#### **Vessel Specifications & Related Data:**

Class Name:	U.S.S. <i>Knox</i>
Construction Contract:	NCC-1940
Series:	Class 1b Starship
Design:	Frigate
Type:	Frigate (FR)
Number in Service	115
Complement:	53 Officers 317 Enlisted Crewmen
Overall Length:	243.3 meters
Overall Draft:	52.8 meters
Overall Beam:	141.7 meters
Displacement:	140,000 tonnes

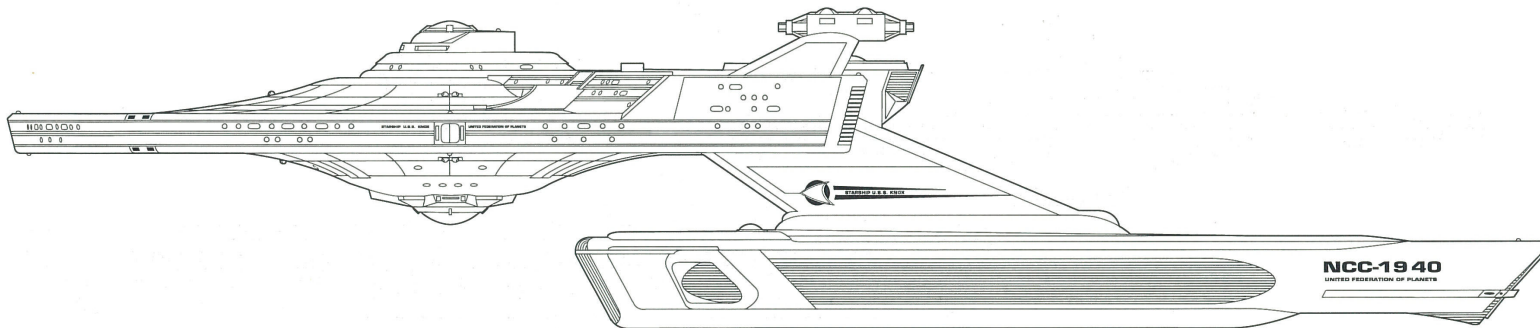

## ***Monoceros* - Class Scout**

### **Vessel Specifications & Related Data:**

Class Name:	U.S.S. <i>Monoceros</i>
Construction Contract:	NCC-601
Series:	Class 1b Starship
Design:	Escort
Type:	Scout (ST)
Number in Service:	73
Complement:	30 Officers 250 Enlisted Crewmen
Overall Length:	200.0 meters
Overall Draft:	60.1 meters
Overall Beam:	141.7 meters
Displacement:	101,000 tonnes

# **U.S.S. *Monoceros***

## **ST 601 Class Scout**

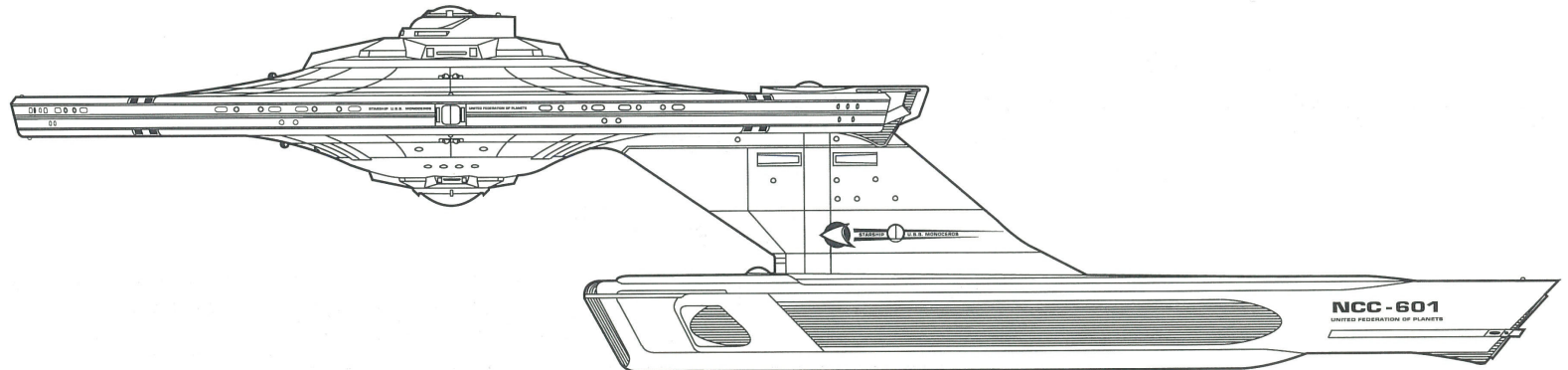

# U.S.S. *Siva*

## DD 520 Class Destroyer

### *Siva* - Class Destroyer

#### Vessel Specifications & Related Data:

Class Name:	U.S.S. <i>Siva</i>
Construction Contract:	NCC-520
Series:	Class 1b Starship
Design:	Escort
Type:	Destroyer (DD)
Number in Service:	110
Complement:	35 Officers 265 Enlisted Crewmen
Overall Length:	200.0 meters
Overall Draft:	60.9 meters
Overall Beam:	141.7 meters
Displacement:	100,000 tonnes

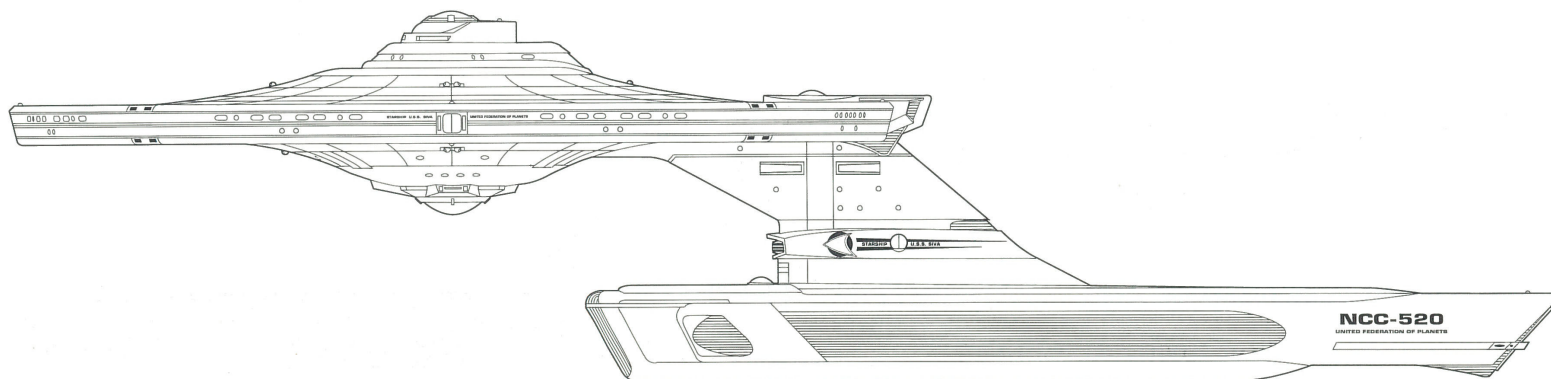



# U.S.S. *Gagarin*

## SV 630 Class Survey Vessel

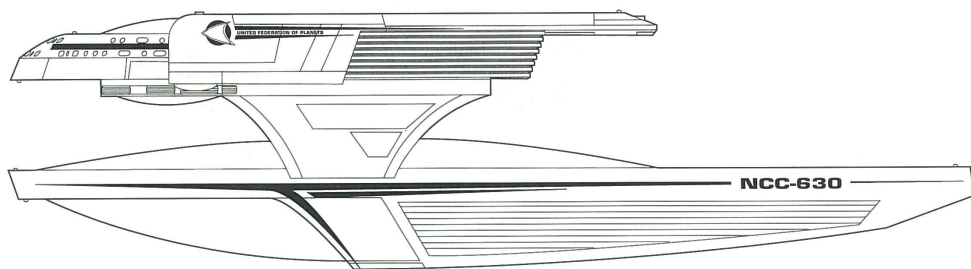

### ***Gagarin* - Class Survey Vessel**

#### **Vessel Specifications & Related Data:**

Class Name:	U.S.S. <i>Gagarin</i>
Construction Contract:	NCC-630
Series:	Class 2 Spaceship
Design:	Auxiliary Vessel
Type:	Survey Vessel (SV)
Number in Service:	470
Complement:	16 Officers 62 Enlisted Crewmen
Overall Length:	148.0 meters
Overall Draft:	59.0 meters
Overall Beam:	103.0 meters
Displacement:	41,000 tonnes

# U.S.S. *Greer*

## CR 472 Class Corsair

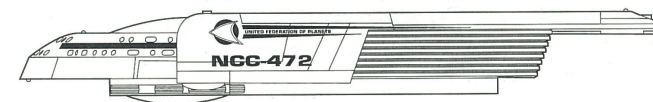

### ***Greer* - Class Corsair**

#### **Vessel Specifications & Related Data:**

Class Name:	U.S.S. <i>Greer</i>
Construction Contract:	NCC-472
Series:	Class 2 Spaceship
Design:	Escort
Type:	Corsair (CR)
Number in Service:	490
Complement:	12 Officers 58 Enlisted Crewmen
Overall Length:	102.3 meters
Overall Draft:	20.0 meters
Overall Beam:	103.0 meters
Displacement:	20,000 tonnes

# U.S.S. *Clarke*

## CP 100 Class Clipper

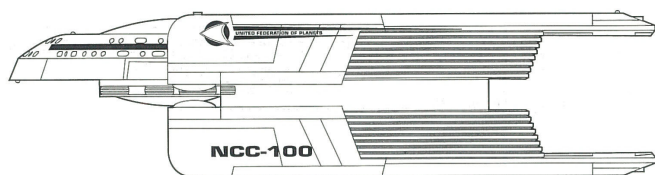

### **Clarke - Class Clipper**

#### **Vessel Specifications & Related Data:**

Class Name:	U.S.S. <i>Clarke</i>
Construction Contract:	NCC-100
Series:	Class 2 Spaceship
Design:	Escort
Type:	Clipper (CP)
Number in Service:	170
Complement:	13 Officers 48 Enlisted Crewmen
Overall Length:	102.3 meters
Overall Draft:	40.0 meters
Overall Beam:	103.0 meters
Displacement:	34,000 tonnes

# U.S.S. *Asmodeus*

## CV 200 Class Light Corvette

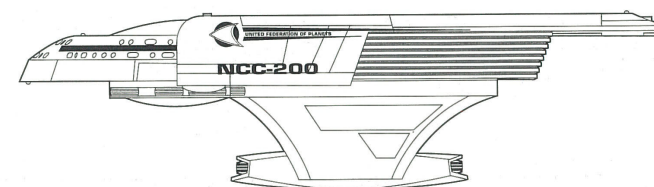

### **Asmodeus - Class Light Corvette**

#### **Vessel Specifications & Related Data:**

Class Name:	U.S.S. <i>Asmodeus</i>
Construction Contract:	NCC-200
Series:	Class 2 Spaceship
Design:	Escort
Type:	Light Corvette (CVL)
Number in Service:	240
Complement:	16 Officers 70 Enlisted Crewmen
Overall Length:	102.3 meters
Overall Draft:	39.5 meters
Overall Beam:	103.0 meters
Displacement:	24,500 tonnes



STARFLIGHT  
PROTOTYPE

80



# Tactical Section:

"How do you hide a Starbase?."

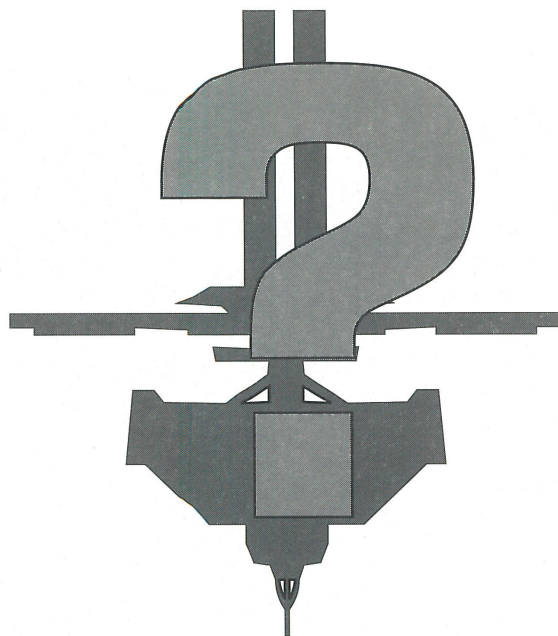

### **Purpose**

In the event of war with either the Klingon or Romulan Empires, known Starbases would be obvious targets. Moreover, enemy fleets would interdict same; keeping relatively close-by and preventing starships from approaching to re-fuel and re-supply by means of ambush. Such a tactic would profit the enemy greatly, for a Starfleet which cannot re-supply, cannot fight for long, which would in turn free other enemy ships for raids into the relatively unprotected inner volume of the Federation.

### **Approach/Departure Protocols:**

Tactical Base Coordinates are known only to starship C.O.'s and F.O.'s. When a starship is enroute to a Tactical Base, the C.O. will order the Helmsman to steer the ship to a pre-selected starting coordinate. At this point the C.O. will order Tactical Base Approach Protocols in effect.

- 1) All computer-sensor navigation relays will be severed, so that no one aboard ship can access the vessel's position or heading via any shipboard station except the Bridge Helm/Navigation console.
- 2) All Viewports blacked-out (full-polarization), preventing anyone aboard with a tricorder from taking star sights during the flight and later collating same to reconstruct the ship's flight-path.

# Tac-Bases

## Tactical Starbases

- 3) Each ship has a library of Approach (and Departure) chips. These are different for every ship, and every Tactical Base. When the C.O. is ordered to a TB (example TB7), he proceeds to his Top Secret safe and selects the first TB7 chip from the library file. The label of said chip will state a spacial coordinate (e.g.: [-203][122][301] - a randomly pre-selected Starting Point for the Spline Run. The C.O. will bring the chip to the Bridge and order the Helmsman to proceed to said coordinates. Once at that point, the C.O. will load the chip into the Navigation Console, and the Spline Run will begin. The Approach and Departure chips are computer-generated and completely random. Since each is individualistic, and each is destroyed upon completion, they represent a fool-proof security system.
- 4) During the Spline Run, the chip readout will order the Helmsman to proceed at specified heading and speed for a specified duration, and then order a new heading/speed and duration, until the vessel has followed several of these splines (10-15 are about average), and the starship is tens of parsecs from the point at which the Spline Run began. The C.O. will then assume direct Helm control, and steer the ship to the Tactical Base.
- 6) From the beginning of the Spline Run, the ship will have been running under ENCON (Emissions-Control). Active sensors will be powered-down and locked-off. The transmitting module of the ship's Subspace and Realspace transceivers will also be powered-down, as will the ship's transponder code transmitter. All viewports will be 100% polarized, which has the twin advantages of preventing crewpersons from attempting to "eyeball" the ship's heading, speed, and position, while at the same time preventing

interior illumination radiation from leaving the ship. Lastly, all navigation beacons and running lights will be powered-down.

- 7) Although the Helmsman and Navigator are still steering the vessel, their consoles are censored; and all position-check or star-reference readouts are blacked-out. Their primary task is to follow the chip's instructions, and see to it that the ship does not stray off the spline.
- 8) The secondary task of the Helmsman and Navigator is to monitor the passive sensors for any sign of a pursuing vessel. Any spline which intersects the path of three vessels must be terminated, whereupon the Captain will access a new chip and proceed to the stated Starting Point for a new Spline Run (after evading contact with any pursuing craft).
- 9) Departure Protocol is similar to the Approach Protocol, except that the chip is engaged at the Tactical Base, and the Spline Run brings the vessel to a Ending point from which the ship is steered under normal conditions to its next assignment.

#### How do you Hide a Starbase?

- 1) The first step in hiding a Starbase-sized facility is not to have a Starbase-sized facility - or rather, to reduce its size to the barest minimum. Such additional structures as quarters for visitors/transients are eliminated - such as there are will stay aboard their vessels. This reduces the chance that a stray Klingon/Romulan sensor probe or survey vessel will detect the presence of a large concentration of refined metals.
- 2) The second step is ENCON. Under no circumstances are outgoing subspace or realspace radio transmissions allowed. Mes sages to be sent are carried by a departing starship, which will transmit same to Starfleet Command when it reaches the end of its Departure Spline Run.
- 3) The third step is secrecy. Even the facility personnel have no idea of where their station is. Access to such items as Tricorders with stellar mapping programs is severely curtailed - which necessitates strict entrance/exit customs examinations.

#### How will the proposed Klingon/Federation Treaty Affect Them?

Not at all. The existence of these bases has never been a secret, and their existence is seen by Starfleet Command and the Federation Defense Council as a deterrent to war. In addition, since their coordinates are unknown, it can be safely assumed that at least some are positioned so as to be close to the Romulan Treaty Zone.

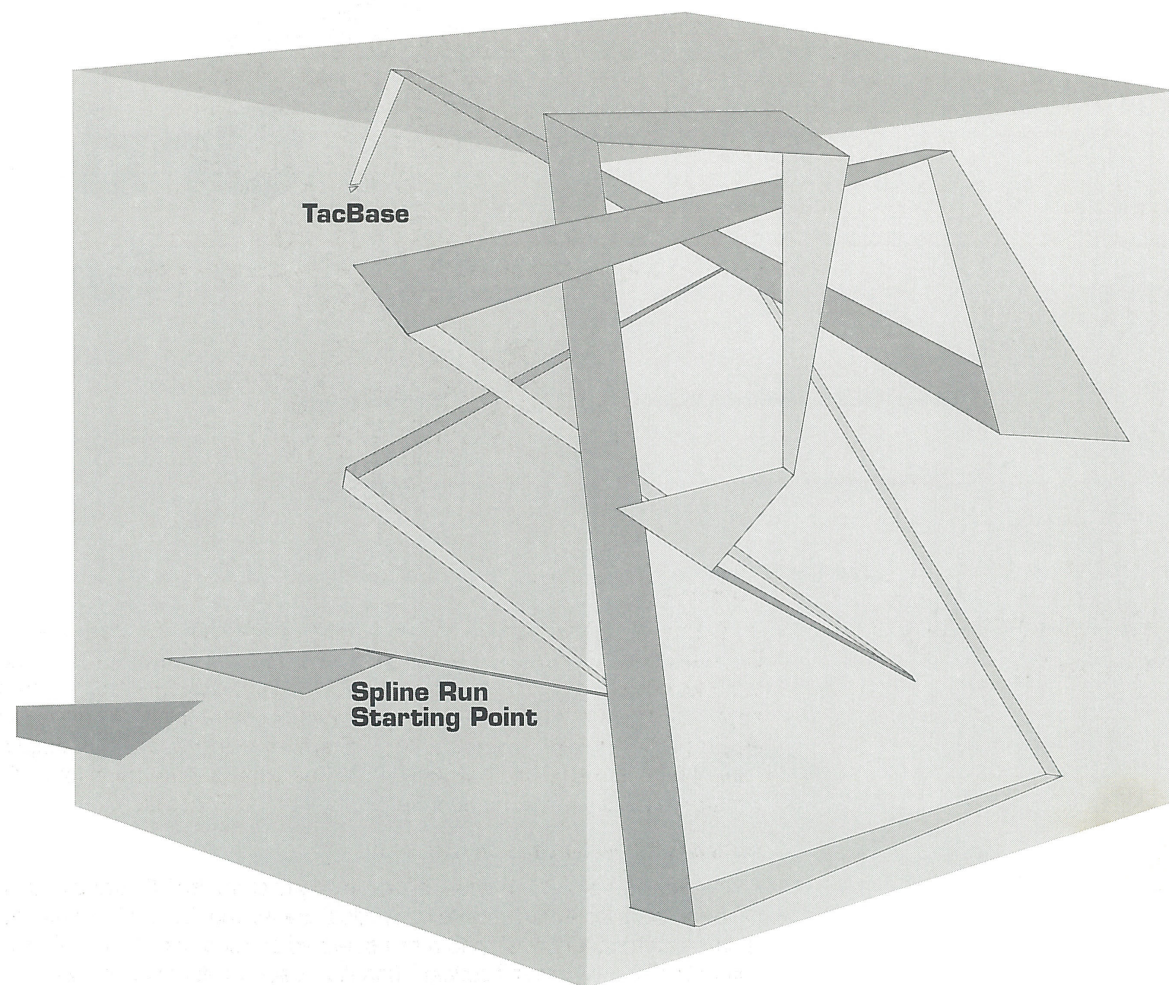

The diagram above shows a theoretical Tactical Base Approach, with the Spline Run beginning at the specified pre-selected coordinates, and ending at the Tactical Base' coordinates. The volume of space represented in the model (enclosing the Spline Run) is variable, as is the number of splines and their length. A Spline Run is known colloquially as a "Drunkard's Walk".

# Ordnance Updates

## Fine-tuning Phaser Harmonics

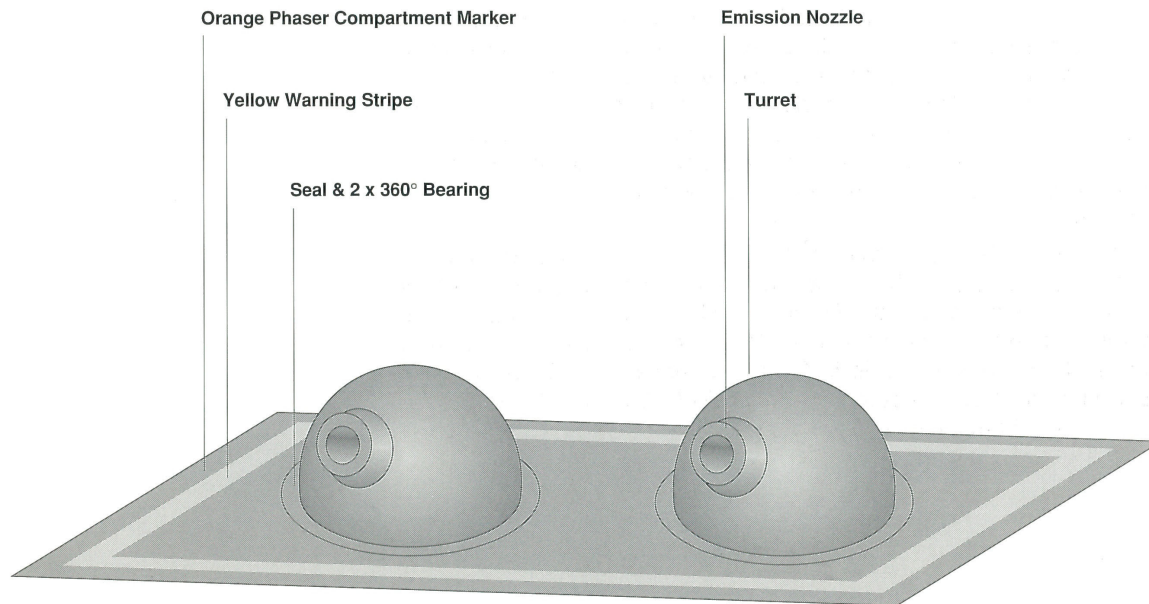

### PHASER: Pulsed HArmonic Sequence Energy Radiation.

The key to phaser performance is its "tunability". This is comprised of several variable factors:

- $f$  - Radiation Frequency
- $i$  - Radiation Intensity
- $d$  - Duration (0.5 second burst - continuous beam)
- $h$  - Variable Harmonic (Spacing of harmonic spikes)
- $c$  - Collimation/focus (Beam Spread)
- $s$  - Beam Spectrum (Tachyonic or Electromagnetic Radiation)

Although  $f$ ,  $d$ ,  $i$  and  $s$  are essential for achieving the desired effect, it is  $h$  which allows the beam to be used at the extreme ranges that it is (controlling  $c$ ). An additional task of  $h$  is its variable stress-field compensation. In most cases, the beam is travelling through at least one subspace field. A beam fired from an orbiting ship to a planetary surface is travelling the whole time within the planet's gravitational field (a subspace phenomena). A beam fired from one vessel to another may be through several subspace fields, including the warp envelope of both firing ship and target. In the latter case, the beam is starting within a subspace field, penetrates the field boundary into normal space, travels through normal space to the target's

warp envelope, and then penetrates that subspace field and travels through it to the target itself.

The problem is that as warp drives evolve into more and more powerful designs (such as Transwarp), the strength of the subspace field also becomes more powerful, with a parallel strengthening of the subspace field's peripheral boundary. This can have the result of distorting phaser beam harmonics, weakening the beam (see figure 1). A novel solution to this problem has been conceived, and is presently being test-implemented. The system - known as ECHO (Enhanced Collimation via Harmonic Oscillation) has already undergone computer simulation and laboratory testing, and will soon be installed in a starship for trials.

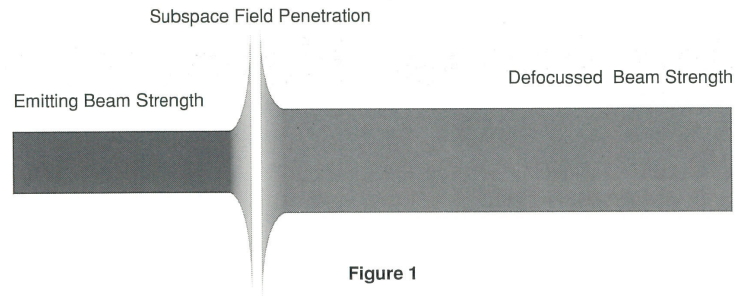

The ECHO system involves adding a delta-wave generator to each phaser, with a ring-shaped output antenna mounted around the phaser nozzle (see figure 2). The  $\partial$ -field generator is physically located within the

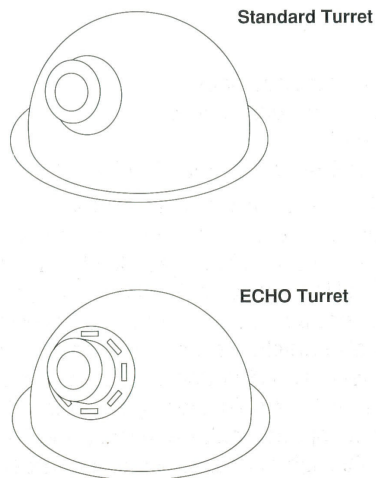

**Figure 2**

Note the differences between the upper (standard) and lower (modified) turrets. Within the hull, the sole change is the addition of a  $\partial$ -wave generator, which feeds the antenna. **WARNING:**  $\partial$  radiation is extremely toxic to carbon-based life forms. The ECHO system must not be activated when the phaserbank is utilized on the STUN setting, as the  $\partial$  waves will prove lethal to any life forms inhabiting the target area, defeating the purpose of the STUN setting.

phaser bank compartment, slaved to the fire-control computer, which inputs emission times and modulations in parallel with its instructions to the phaser energy chambers/turret assembly. As the phaser beam is emitted, it is jacketed by a collar of  $\partial$  radiation (see figure 3). Said jacket is carefully

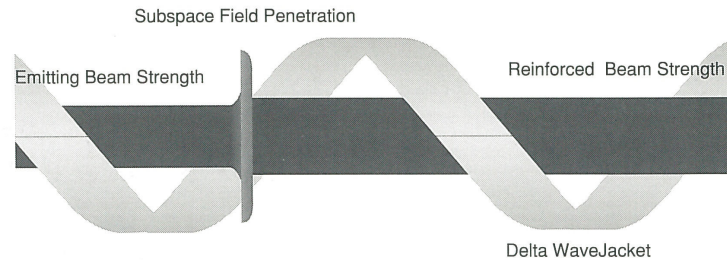

sequenced so as to reinforce the pulse-spikes of the phaser beam, while constraining the pulse stream to its optimax homogenous state. In addition to the obvious increase in range caused by the focus improvement, the jacket has the benefit of bearing the brunt of subspace field penetration, protecting the phaser beam. Even if the jacket were almost completely nullified upon penetrating the target's subspace field, the remaining distance to the target vessel is only a few hundred meters - of no importance.

The starship Ranger - prototype for the up-coming (and long-awaited) Light Cruiser Class, has been chosen to act as the test-bed for the new system. Among the reasons for her selection was the fact that she is presently undergoing her post-shakedown refit - a process expected to take up to 17 weeks. This is fortuitous, since the ECHO system's installation involves the complete removal of all phaser turrets, to be replaced with turrets modified to hold the  $\partial$ -field antenna, as well as the installation of the  $\partial$ -field generators.



# Transwarp

## Converting the Class 1b Fleet

"It become apparent that radically new warp drive nacelles were not required ...rather the changes required were to be found in the starship's energy system...the general implementation is fairly simple."

### Development, Theory & Implementation

In 2284, after the successful testing of the Transwarp Drive System on its test-bed vessel U.S.S. *Excelsior*, then-Commodore Day and the Strategic Design Power & Propulsion Team began developing a like system for the extant Class 1b starships. It become apparent toward the end of *Excelsior's* designing that radically new warp drive nacelles were not required (although *Excelsior's* larger nacelles had certainly been required to move her immense bulk). Rather the changes required were to be found in the power handling and transformation stage of a starship's energy system: within the intermix chamber - between the reactor's generation of energy and the nacelles' utilization of same. Exact details of the finding are still classified at this time, but the general implementation is fairly simple, with retrofitting to Transwarp Drive capability being a two-part process.

The first stage involves altering the matter/antimatter mix ratios according to a cyclic Chaos-physics formula, which is computer-controlled to correspond with the external universe's space/time matrix and the vessel's own warp envelope subspace field. A synergistic effect is obtained, so that

the former actually begins to reinforce the latter. In effect the space/time matrix provides less resistance to the vessel's subspace field, allowing the vessel to net far greater velocity gains for the same amount of energy expended. Although this stage is mainly a software one, some new hardware was required. Specifically, the force-field valves which control the antimatter flow had to be replaced with units capable of finer discrimination. As well, the matter transporter injector sequence had to be enhanced so as to keep up with the rapidly cycling demands of the new intermix computer commands.

The second stage is a major one, and involves the warp drive nacelles. The control reactor within each nacelle is modified so that incoming energy from the intermix chamber is polarized prior to being fed to the nacelle flux chambers. The polarizer fits within each of the fore and aft sub-reactors in the reactor complex, and the modifications are not visible from the outside.

### Effect on the Subspace Field

The field generated by a Transwarp vessel is radically different from that of a non-modified vessel. Visual representations show that the field has a

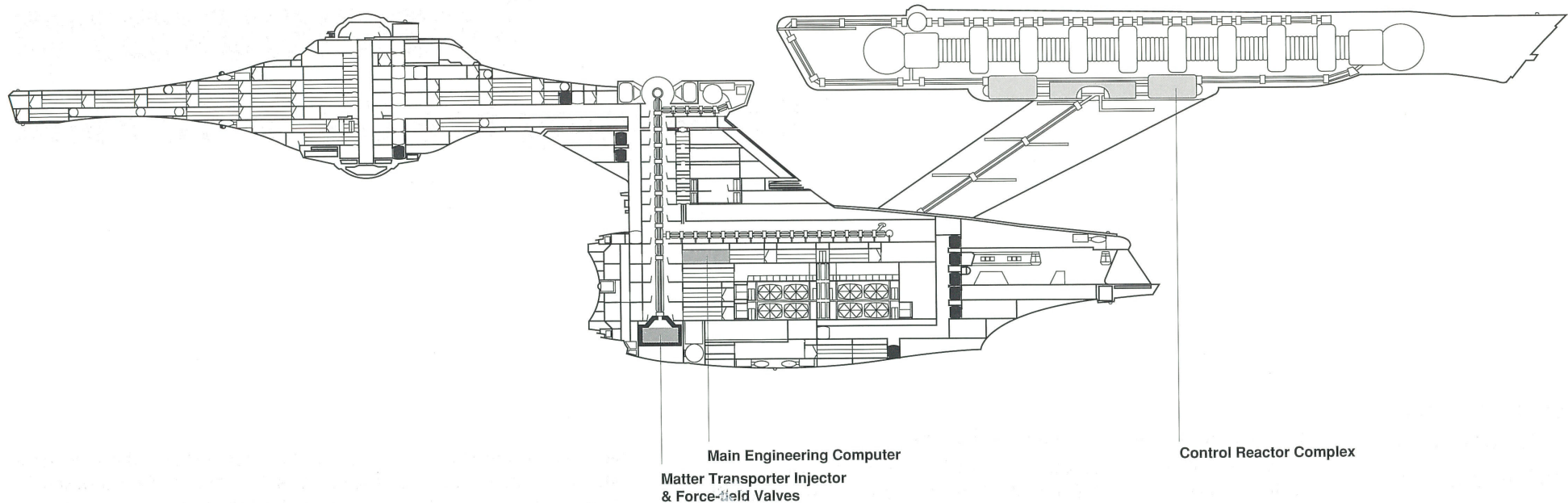

dynamic ripple texture rather than the normal featureless spherical bubble.

**Results**

The new Transwarp Retrofit was first installed and tested in U.S.S. *Enterprise* (CH 1701A). Results were at once phenomenal and as predicted. The vessel retains its Power Consumption Indice Coefficient of 1.003, but it has been enhanced. In terms of Warp Dynamics, the change is one of exponential gain. Put simply, warp factors have been bumped to the fourth power rather than the third. Put numerically, *Enterprise* CH 1701 would expend 1.003 petajoules per second to achieve wf 10 - which equated to a realspace speed of 1000xC (10 to the third power). *Enterprise*

CH 1701A, expending the same output of 1.003 petajoules/sec., would achieve twf 10 - which equates to a realspace speed of 10000xC (10 to the fourth power).

As prototypes are constructed (including the ones included within this journal), they are outfitted with the Transwarp Retrofit. Current Starfleet Logistics estimates call for all existing Class 1b starships to be retrofitted by 2299 - said modifications to be carried out at all major starbases, and according to a rotating schedule to prevent drastic disturbances to existing Starfleet patrol and exploration plans. Once retrofitted, each starship will undergo acceptance trials before re-entering service.



# Appendix:

# About the Design Team

## Strategic Design & Starfleet Personnel

### **Chief Editor/Publisher: Captain David John Schmidt**

Captain Schmidt served for five years in the Federation marine Corps before transferring to Starfleet Tactical. In 2288 he was posted to the position of First Officer of the U.S.S. *Repulse* - an *Athabaska*-class Exploratory Cruiser. After serving there for two years, he was assigned as the military coordinator of the Strategic Design Group. He is attached to the Cathedral Unit as First Officer.

### **Strategic Editor: Captain Roger Wright**

Captain Wright has held many positions within Starfleet, including Special Intelligence, Logistics Analyst, and Commanding Officer of the U.S.S. *S'Harien* and *Repulse*. In 2291 he was attached to the Cathedral Unit as Captain.

### **Technical Editor: Captain David Desardins**

Captain Desjardins served as head of the Starfleet Ordnance Laboratories for six years before being assigned to the Operations Billet within Strategic Design. He is attached to the Cathedral Unit as Tactical Officer.

### **Executive Editor: Commander Janet Reeves**

Commander Reeves has served for years as a Marine Combat Pilot, Test Pilot, and Helmsman. Presently assigned to Starfleet Operations as a small-craft designer, she is also attached to the Cathedral Unit as Chief Helmsman.

### **Production Editor: Brian Oberquell**

Mr. Oberquell is a member of the Federation Military Appropriations Committee, and is head of the Starfleet Oversight Committee.

### **Engineering Consultant: Captain Kevin Atkinson**

Captain Atkinson worked six years in the Federation Merchant Marine prior to joining the Starfleet Corps of Engineers. In 2285 he was loaned to Starfleet Tactical's Strategic Design Group to aid in the development of Megaphaser Cannon. He now heads Power and Propulsion Systems Design within Strategic Design. He is attached to the Cathedral Unit as Chief Engineer.

### **Systems Analyst: Rear Admiral Robert Earl Day**

Rear Admiral Day heads the Astrophysics Department of the Starfleet Research & Development Division. He is presently assigned to the High-Energy Chaos-Physics Laboratory Facility at Spacedock. His accomplishments include co-chairing the Transwarp Design Team for Project *Excelsior*, designing the Opera Sensor Suite for the U.S.S. *Phantom*, and codeveloping the Class 1-b Transwarp Retrofit.

### **Naval Liaison: Admiral Lisa Murata**

Admiral Murata is a member of the Joint Chiefs, and heads Starfleet Tactical.

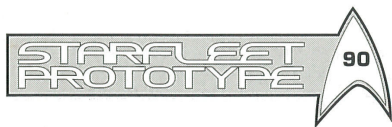

# Cathedral Unit

## A Dedicated Shake-down Crew

### Definition & Conception

Cathedral Unit is the designation for the test crew comprised of personnel from the Starfleet Corps of Engineers and Starfleet Tactical, whose task is to take prototypes out on their shake-down cruise and evaluate the performance of all systems. It is the net sum of the various reports and logs made by these individuals during the shake-down cruise that the Trial Run Finding is drawn from.

In 2290, it was decided by Starfleet Tactical and Starfleet Operations that there would be definite advantages in having a permanent test-crew assigned to Strategic Design. It had been noted that there were problems in simply assigning the Construction crew of a particular prototype to the shakedown run. Firstly, since each prototype was taken out by a different crew, there was no absolute way to compare opinions regarding performance and special features: quantitative features could be recorded (turning and speed capabilities, etc.), but the "feel" of the vessel would be relative to that particular crew's (and Captain's) experience and preferences. Obviously few Engineers have sufficient Tactical training to fully evaluate the handling characteristics of a new Corvette. Secondly, on more than one occasion, catastrophic failures had occurred during trial runs - and in fact the prototype U.S.S. *Ryan* was lost with all hands in 2287. True, having a crew composed of Engineers was useful in case of problems, but these were construction Engineers, not specifically Damage Control personnel.

The test crew was selected from various personnel permanently

stationed on or near Terra. In addition to their regular Starfleet duties, they are on call whenever a prototype is ready for its trial runs. In each case, the personnel were chosen for their particular skills, as these pertained to the desired end goal: the accurate and complete evaluation of a new ship's capabilities. It is thus comprised of some of Starfleet's best Tacticians, Helmsmen, Engineers, and Systems Analysts, as well as Damage Control Teams. From the Propulsion Technicians to the Fire-Control Specialists, all are considered experts in their respective fields.

All starship prototypes undergo their shake-down cruises and acceptance trials in a secluded and cordoned-off sector reserved for this purpose - code-named Cathedral Sector. The coordinates of this sector are of course classified. It is from this sector that the permanent evaluation crew takes its name.





# STARFLEET PROTOTYPE

A Joint Publication of Starfleet Tactical & the Strategic Design Group  
Printed in Canada by the Starfleet Academy Training Command Press