



Starfleet

DYNAMICS

*Starfleet Academy
Training Command*

Reformatted & Updated to Stardate 9100.00

Portions of this manual previously published as a three-volume series under the title
Starfleet Officer Requirements

P

Preface

M A S T H E A D

- Project Head** **Commander David Schmidt**
TacFleet (Starfleet Tactical)
First Officer
U.S.S. *Repulse*
- Flag Liason** **Captain Roger Wright**
ComFleet (Starfleet Command)
Commanding Officer
U.S.S. *Repulse*
- Technical Editor** **Commodore Robert Day**
ReDFleet (Starfleet R & D)
Chief Physicist
Spacedock, Terra
- Support Services** **Lieutenant Janet Reeves**
LogFleet (Starfleet Logistics)
Deck Officer
U.S.S. *Repulse*
- Technical Liason** **Commander Kevin Atkinson**
EngCorps (Engineering Corps)
Chief Engineering Officer
U.S.S. *Kestral*

About the Title...

Much is said about the traditions of Starfleet. What must also be realized is that Starfleet is a dynamic organization - constantly in flux, always ready to change should new or better ways of doing things come along. This is as true with regards to the training of officers as with the designing of ships.

F O R E W O R D

This book has been compiled for both the recruit and the career man alike, as a practical guide to the work and responsibilities of the Starfleet Services. Whether you are an enlisted man using it to gain a broader knowledge-base for rating advancement, a cadet at the Academy or midshipman on a training cruise learning how to be an officer and a leader, or an officer seeking to familiarize himself with the ever-changing entity that is Starfleet, I believe that this volume will provide a keel sturdy enough to prepare you for the heavy demands and responsibilities which await you.

The effectiveness of Starfleet hinges above all else on well-trained, disciplined personnel - exhibiting leadership by example - joined in a resolve to serve the Federation's citizens in the noble traditions of the myriad navies of the component worlds. A poet once said of the men and women of Starfleet:

"...Warrior-priests ever championing freedom, honor, and the cold light of truth..."

...and I can think of no finer accolade or send-off. Whatever your mission area; be it patrolling the far reaches of the Treaty Zone, contacting and befriending new life and new civilizations, or engaging in research and development on a Starbase, I look to you to continue that tradition.



Starfleet DYNAMICS

A Starfleet Academy Reference Guide & Text

Starfleet DYNAMICS

Table of Contents

PREFACE

Masthead	000
Foreword	001
Table of Contents	002

COMMAND DEPARTMENT

United Federation of Planets	006
Federation	006
• Federation Council	
• Security Council	
• Secretariat	
• Economic & Social Council	
• Trusteeship Council	
• Federation High Court	
• Agencies of the United Federation of Planets	
• Membership	
• Federation Pendant	
• Federation Flag	
Federation Starcharts	010
• Galactic Overview	
• Federation Overview	
• Major Stellar Systems	
Galactographic Regional Terms	019
• Quadrants	
• Sectors	
• Neutral Zones	
Starbases	020
• Starbase Locations	
• Other Military Installations	
• Space Stations	
• Private Facilities	
Starfleet	022
Component Services	022
• Starfleet Space Command Corps	
• Starfleet Marine Corps	
• Starfleet Corps of Engineers	
• The Aims & Responsibilities of Starfleet	
Starfleet Command	024
Starfleet Operations	025
• Directorate 1 - Fleet Movement	
• Directorate 2 - Civilian Shipping	
• Directorate 3 - Threat Analysis	
• Directorate 4 - Defense	
Starfleet Academy	026
• Command Program	
• Staff Program	
• Definitions	
• Cadet Commissions	
Officers & Crewmen	027
• Commissioned Officers & Ranks	
• Enlisted Personnel & Petty Officers	
Military Decorum	028
• Addressing Officers	
• Addressing Enlisted Men	
• Answering a Superior Officer	
Discipline & Courts-Martial	028
• 1 - Captain's Mast	
• 2 - Summary Court-Martial	
• 3 - Special Court-Martial	
• 4 - General Court-Martial	
• 5 - Field Court-Martial	
Commanding Officer's Responsibilities	030
Departments & Divisions	030

• Shipboard Organization & Responsibilities	
• Departmental Responsibilities	
• Officer Responsibilities	
• Shift Section & Watches	
• Ship's Alert Status	
• Logs	
• Starfleet ID	
• Command Packet	
• Destruct Sequence Scenario	
First Contact Procedures & the Prime Directive	035
• First Contact Procedures	
• Command Decision	
• Landing Party	
• Outfitting	
Leave, Shoreleave, & Liberty	037
• Jurisdiction	

Uniforms

Uniform of the Day	037
• Basic Components	037
• Grooming	
• Class A - Dress Jacket	
• Class A - Dress Jumper	
• Class B - Duty Jacket	
• Class B - Duty Jumper	
• Class C - Survival Jacket	
• Class C - Marine Assault Fatigues	
• Class C - Security Armor	
• Class C - Surgical Whites	
• Class C - Laboratory Smock	
• Class C - Radiation Suit	
• Class C - Decontam/Maintenance Suit	
Insignia	043
• Departmental Stripe	
• Service Awards - Sleeve Insignia	
• Officer's Rank Insignia	
• Fleet Insignia	
• Departmental & Divisional Emblems	

OPERATIONS DEPARTMENT

Bridge	048
Starship Bridge	048
• Types of Stations	
• Station and Facility Synopsis	
• Command Console	
• Weapons Console & Tactical Computer	
Flagship Bridge	050
Weapons Systems	050
Fire-Control Systems	050
Photon Torpedo (Pho-Torp) Mark 6	052
• Variable Payload Modules	
Phasers	055
Megaphasers	055
Defense Fields	056
Target & Weapon Selection	056
• Photon Torpedo	
• Phaser	
Navigation	057
Navigation & Helm Responsibilities	057
• Navigator	
• Helmsman	
• Maneuvering Orientation	
• Relative Bearings	
• Planetary Orbits	
• Navigational Hazards	
• Navigational References & Pulsars	
Planetary Defense Systems	062
• Components	
• Defense System Tier & Examples	

P r e f a c e

Strategy & Tactics	063	COMMUNICATIONS DEPARTMENT	
• Definitions			
Tactical Advantage	063		
Battle Scenarios	063	Communications Systems	100
• Impulse Jockeying		Intercom	100
• Warpspeed - Overtaking		• Private	
• Warpspeed - Oncoming		• Master Circuit	
Evasive Maneuvers	064	• Sealed & Encoded Transceivers	
• Warpspeed - Jogging		Subspace Communications	101
• Impulse - Veer		• Tachyonic Theory	
• Warpspeed - Pho-Torp Screen Defense		• Bands	
• Stationary - Kirk Defense Pivot		• Enhancement	
• Englobement - Corbomite maneuver Escape		• Universal Translator	
Re-establishing the Offensive	065	• Transmission Encoding	
• Impulse - Sulu Maneuver		• Code Phrasing	
• Impulse - Shadow maneuver		Classified Materials	104
• Warpspeed - Pho-Torp Screen Attack			
• Impulse - April Maneuver		Equipment	105
• Impulse - Fire-Blossom Maneuver		• Type 2 - Field Communicator	
• Warpspeed - Cochrane De-accel Maneuver		• Type 3 - Combat Communicator	
Starships, Spaceships, and Civilian Vessels	066	Sensors	106
Fleet Strength & Stationing	066	• Engineering Sensors	
Class 1-B Starships	067	• Navigational Sensors	
• Models		• Science Sensors	
• Types and Desirable Characteristics			
Main Types	068	Computer Systems	107
Specializing Types	068	System Architecture	107
• Mark 21-B Conquest Class Dreadnought		• Duotronic Theory	
• Mark 9-B Enterprise Class Heavy Cruiser		• Connections and Interfaces	
• Mark 20-B Dahlgren Class Cruiser		Processing Systems	108
• Mark 13-B Constant Class Battlecruiser		• Hardware	
• Mark 22-B Valor Class Strike Cruiser		Memory Systems	109
• Mark 27-B Guam Class Through Deck Carrier		• Hardware Categories	
• Mark 27-B Rickover Class Fast Frigate		• Memory Utilization	
• Mark 11-B Miranda Class Heavy Frigate		Main Computer	110
• Mark 12-B Exultant Class Frigate		• Computer Core	
• Mark 14-B Hippocrates Class Medical Frigate		• Archival Stores	
• Mark 7-B Monoceros Class Scout		• Prioritization	
• Mark 30-B Kestral Class Superscout		Peripheral Systems	111
• Mark 8-B Silva Class Destroyer		• Direct Overrides and Auxiliary Systems	
• Mark 18-B Warlord Class Heavy Destroyer			
• Mark 31-B Thunderbolt Class Fast Destroyer		Buoys	112
Prototypes	084	• Definition	
Class 2 Spaceships	084	• Types	
• Mark 35 Garneau Class Survey Vessel		Civilian Types	112
• Mark 38 Asmodeus Class Corvette		• NA-1 Sector Corner-Marker	
• Mark 39 Clarke Class Diplomatic Clipper		• NA-2 Navigational Spacelane Marker	
Class 3 Commercial Vessels	086	• NA-3 System Traffic Buoy	
• Shipbuilders		• NA-4 Hazard Buoy	
• Power and Propulsion Systems		• NA-5 Spaceport Buoy	
• Shipping Lines		• CO-6 Communications Buoy	
• Type A Passenger Liner		Military Types	114
• Type B Passenger/General Cargo Liner		• MI-8 Surveillance Buoy	
• Type C Cargo Freighter		• MI-9 Interdiction Buoy	
• Type D Container Cargo Freighter		• MI-10 Guardian Buoy	
• Type E Bulk Cargo Freighter			
• Type F Module Freighter		SCIENCES DEPARTMENT	
• Type G Small Freighter			
• Type H Tanker		Stellar Survey Procedures	116
• Type I Fuel Carrier		Survey Stages	116
Class 4 Automated Vessels	093	• Stage 1 - Exploration & Mapping	
Civilian Craft - Spacelanes & Regulations	093	• Stage 2 - Intensive Survey	
Auxiliary Craft	094	• Stage 3 - Diplomatic Liaison	
• Shuttle - SW-7		Stellar Types	117
• Assault Shuttlecraft - S-19		Planetary Classification	118
• Shuttlecraft - S-15		• Class M Characteristics	
• Travel Pod - S-10		Life-Form Classification	120
• Bee - S-2		• Examples	
• Talon - SA-3		Social and Industrial Ratings	120
• Tomohawk - SA-4		• Social Development Scale	
• Auxiliary Craft Regulations		• Industrial Development Scale	
• Hanger Complex			
• Ranger Procedures			

Starfleet DYNAMICS

- Anomalies
- Interference Catastrophe & Unavoidable Interference
- Cultural Dynamicism Chart

Spacecraft Analysis 124

- Propulsion Systems**
 - Faster-Than-Light
 - Slower-Than-Light
- Ordnance Systems** 125
 - Offensive Systems
 - Defensive Systems
 - Unique Systems
- Warp Field Envelope - Analysis & Identification** 127
 - Envelope Geometry
 - VIFEAC System

Technology Update File 128

- Cloaking Device** 128
 - History
 - Function
 - Effect
 - Detection
 - Limitations
- Energy Barrier** 129
 - Description
 - Effect
 - Origin/Cause
 - Inner Barrier
- Project Excelsior** 129
 - Proposal
- Time Travel** 130
 - Theory
- Genesis Device** 131
 - Modality
 - Stage One
 - Stage Two
 - Stage Three
 - Variation From Predicted Results

Equipment 133

- Type 1C - Tricorder** 133
 - Sensors and Scanning Modes
 - Disc 1 - Security
 - Disc 2 - Science
 - Disc 3 - Medical/Ship's Services
 - Disc 4 - Engineering
 - Disc 5 - Command/Operations

MEDICAL DEPARTMENT

Shipboard Systems 136

- Contameter** 136
 - Regulations
 - Function
- Diagnostic Bed** 137
 - Stretcher Mode
 - Sickbay Mode
- Recreation** 138
 - Games
 - Entertainment
 - Libraries
 - Training

Field Equipment 139

- Type 5 Medikit** 139
 - Definition
 - Content
- Type 6 Medical Emergency Case** 142
 - Definition
 - Contents
 - Frame
 - Stretcher

- Telemetry & Computer
- Life-Support
- Transporter Beacon & Platform

SHIP'S SERVICES DEPARTMENT

Shipboard Responsibilities 144

- Decontamination Procedures** 144
 - Contamination Classification/Condition Code
 - Procedures
- Cargo Storage and Handling** 145
 - Container Handling
 - Container Onboard Systems
 - Manifest Coding
 - Item Tag
 - Cargo Container Data Plaque
 - Standing Orders

Anti-Grav Units 147

- Operation
- Functions and Parameters

SECURITY DEPARTMENT

Organization & Procedures 148

- Department Deployment** 148
 - Make-up
 - Officer Duties
 - Squads
 - Condition Status
- Duty Classification** 149
 - Class 1: General Duty
 - Class 2: Special Duty
 - Class 3: Ceremonial Duty
- Communication** 150
 - Routine Check-ins and Multi-channeling
 - Preliminary and Follow-up Calls
- Intruder Control** 151
 - Isolation
 - Anaesthesia
 - Override
- Restricted, Controlled & Sealed** 151
 - Restricted
 - Controlled
 - Sealed

Equipment 153

- Phaser - Technical Evolution
- Type 1C - Hand Phaser** 154
- Type 2C - Phaser** 154
 - Description
 - Operation
- Type 4D - Combat Phaser** 155
 - Description
 - Operation
- Type 10 - Assault Cannon** 156
 - Description
 - Features
 - Fire-Selection and Targeting
- Type 3 - Projectile Grenade** 157
 - Description
- Type 3B - Sonic Grenade** 157
 - Description
- Boatswain's Call** 158
 - History
 - Present-day
 - Operation

Abandoning Ship 159

- Scenarios 1 through 5** 159
 - Scenario 1

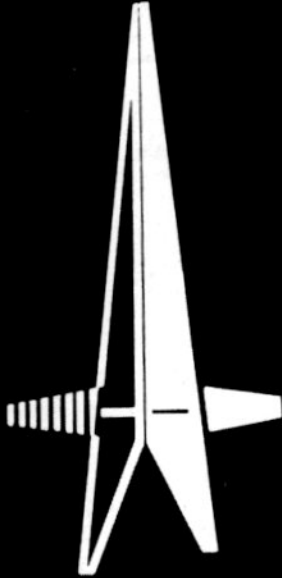

Command Department

UNITED FEDERATION OF PLANETS

Federation

The United Federation of Planets is an organization of sovereign worlds. Membership is completely voluntary and, subject to the Official Charter of Standards, open to any planetary government within the Treaty Zone. The Federation was formed in 2127 when the Articles of Federation were signed by the five founding planetary governments. These five worlds saw definite advantages in a central forum for diplomacy and cooperation. After fifty-six years of relatively slow expansion, faced time-after-time with belligerency on the part of newly contacted worlds, Starfleet was created. The task and responsibility it was charged with was to implement the actions of exploration, defense, and the up-keeping of interstellar law. Since that time, membership in the Federation has grown until, as of the 2290 session of the Federation Council, there are 1,560 member systems.

-Federation Council

The Federation Council includes representatives from every member of the Federation. Each member may send five representatives, but each member is allowed only one vote. Additionally, non-member planets are allowed to send observers to sit in at the Federation Council - and even participate in open discussion - although these may not vote, and may not attend closed sessions. Such non-members as the Klingon and Romulan Empires have occasionally utilized this privilege. A two-thirds majority is required in the Federation Council on all issues it is entitled to deal with. The President and chief administrator of the Federation Council is elected biannually. A representative of a member planet, he is nominated for the position by the Security Council, subject to approval by the Federation Council. He is automatically a member of the Security Council.

Command Department

Security Council

The Security Council is composed of the representatives of the five founding planetary governments (Terra-Sol 3; Vulcan-4; Endani A2; Andor-Epsilon Indi 7; Tellar-61 Cygni 8) and Alpha Centauri A4), plus five non-permanent members' representatives elected by the Federation Council. These diplomats are responsible for the stewardship of the Federation, especially as pertains to executing decisions of the Federation Council. An eleventh member of the Security Council is the Starfleet Commander. He is charged with implementing instructions of the Security Council into actual tactics and fleet logistics, as well as advising the Security Council as regards any threat to Federation peace. As well as the protection of interplanetary peace, the Security Council has the responsibility of approving any non-member's application for membership in the United Federation of Planets.

Secretariat

The Secretariat comprises the civil service branch of the Federation: computer programmers, communications specialists, assistants, and administrators. Evenly distributed throughout among all member planets, none-the-less, all servants owe loyalty only to the Federation itself for the duration of their employment. Their contracts are signed with the full knowledge of their home planets.

Economic & Social Council

Explores such diverse subjects as planetary standard-of-living, interplanetary trade balance, and population expansion. It is the mandate of this Council to formulate and forward to the Federation Council any suggestions which might conceivably improve the quality-of-life generally or in particular.

Trusteeship Council

Some planets are not-yet ready for Federation membership either because of their inability to meet Federation membership standards, or because the planet must be protected from contact due to the Prime Directive of Non-Interference. The Trusteeship Council is charged with monitoring said planets, and with advising the Security Council and Starfleet) on the proper usage and protection of these charges via warning buoys and patrols. It also aids outside planets in raising themselves up to Federation standards with such methods as education in civil rights.

Federation High Court

Final and without appeal, the Federation High Court is the highest judiciary within Federation space, and is used to peacefully settle such interplanetary disagreements as mining rights and trade barriers and tariffs. Governments or individuals may bring their cases to the Federation High

Court. The magistrates thereof (one-hundred and one) are chosen from among the most skilled throughout the Federation, from all planets.

-Agencies of the United Federation of Planets

As well as the above major bodies, the Federation also includes the following smaller and more specialized agencies:

- Food & Drug Agency
- Transportation Regulatory Agency
- Federation Bank
- Commercial Development Agency
- Federation Health Agency
- Communications Agency

-Membership

No planet can be coerced into joining, and there are many advanced civilizations within the Treaty Zone which are not members by choice. These non-affiliated systems are allowed to engage in interstellar trade - but are forbidden to contact of entreaty with any power considered an enemy of the Federation. Also, any non-member which shows itself to be an enemy of the Federation is contained (see: NEUTRAL ZONES). Friendly non-members are not contained. To qualify for membership, a planet must meet the Official Charter of Standards, which - along with the Security Council - ensures that no planet gains membership until it is ready to do so as a full and equal member. After initial contact, developing planets are isolated, and allowed to evolve in their own unique manner and speed. Briefly, the Primary Standards Categories are:

- 1 - Existence of a global government or coordinating body.
- 2 - Global peace for one standard century.
- 3 - Civil Rights meeting Federation guide-lines.
- 4 - Technical development above "F" on the Richter Scale of Industrialization.
- 5 - Social development above 78% on the Federation Scale of Ethics.

-Federation Flag

The flag of the United Federation of Planets has changed several times during the 150 year history of the Federation. The present design was agreed upon in 2277 by a special committee of the Federation Council. Similarities between this and the flag of the United Nations of Terra are intentional, since humans comprise 47% of the intelligent life-forms within the Federation.

The flag consists of a flat representation of the Federation, surrounded by a white circular field, superimposed upon a blue field. The laurel wreath represents the Federation's peaceful goals. The white circular field represents its lofty ideals, unchanged since its founding in 2127. The enveloping blue field represents the infinite vastness of the universe.

Particulars:**Starfleet Standard**

Width 150 centimeters
Height 100 centimeters

Diplomatic Standard

Width 200 centimeters
Height 100 centimeters
Colors White, Sky-Blue



Command Department

Federation Pendant

The Federation Pendant is worn by Diplomats (ambassadors and their aides) and Starfleet personnel while attending meetings of the Federation Council, Security Council, and other Council and Agencies within the Federation Complex. It serves to readily identify said Diplomats and Delegates. The Pendant is never worn by sub-servants. Non-member guests of any meeting (such as a Klingon ambassador) would also wear a Pendant.

Sculpted Silver, the Federation Pendant consists of two pieces, connected by a single link of chain. The upper piece is triangular, with the initials U.F.P. on the front and a magnetic adhesion surface on the back. The lower piece is a stylized map of the Federation in bas-relief. Whether on indigenous raiment or Starfleet uniform, the Pendant is worn with the triangle's top 15 centimeters below the collar-line, centered on the torso.

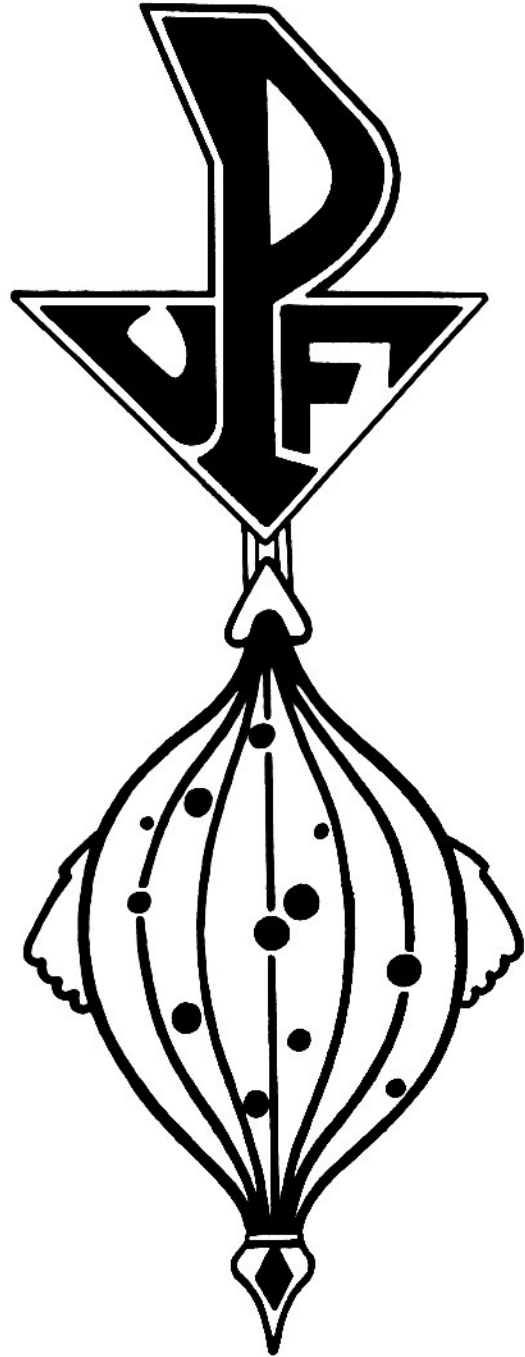

Starfleet
DYNAMICS

Federation Starcharts

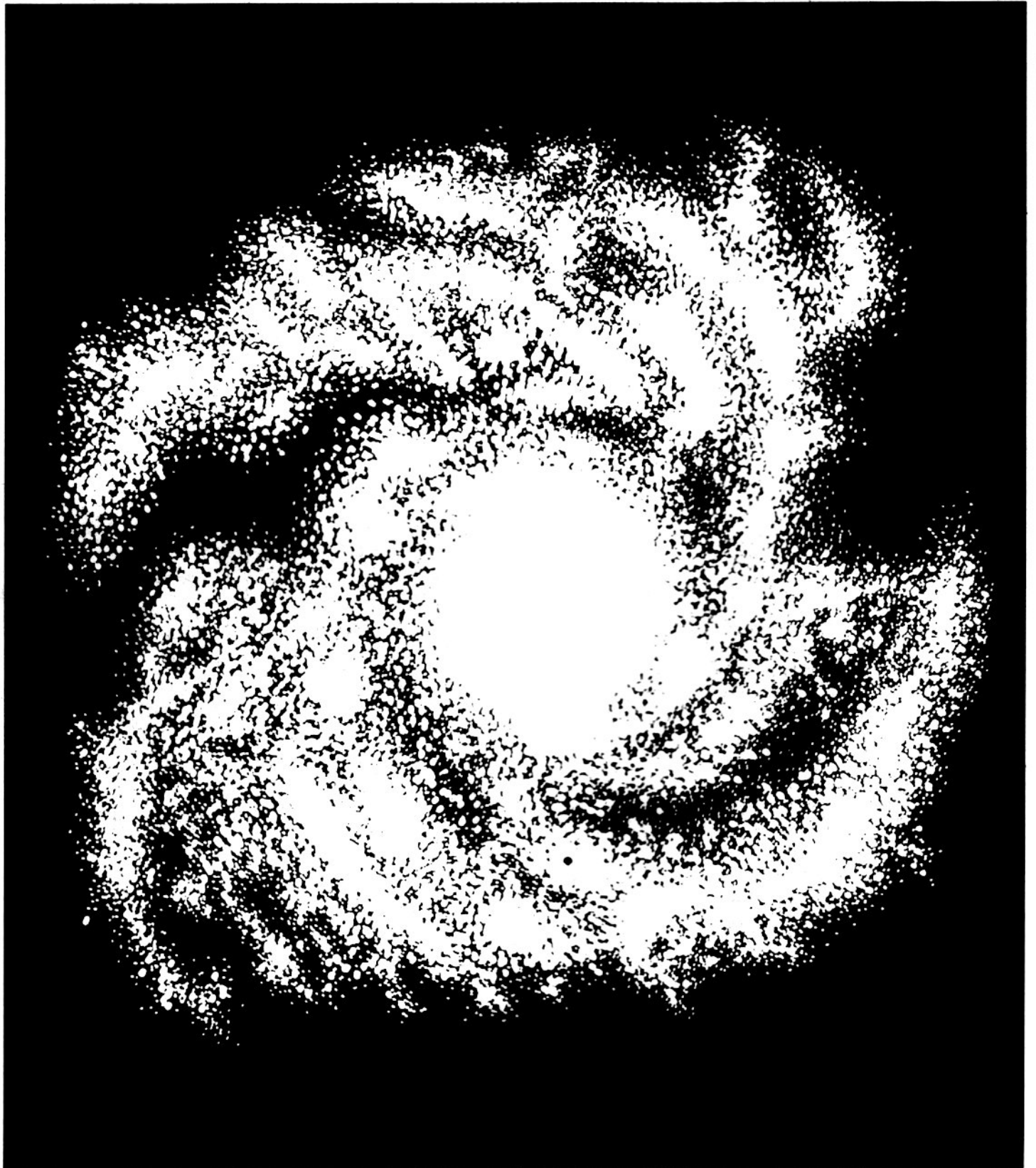

Command Department

-Federation Treaty Zone Overview

Particulars:

Radius 100 parsecs

Volume 4200000 cubic parsecs

Stellar Pop 420000 (estimated)*

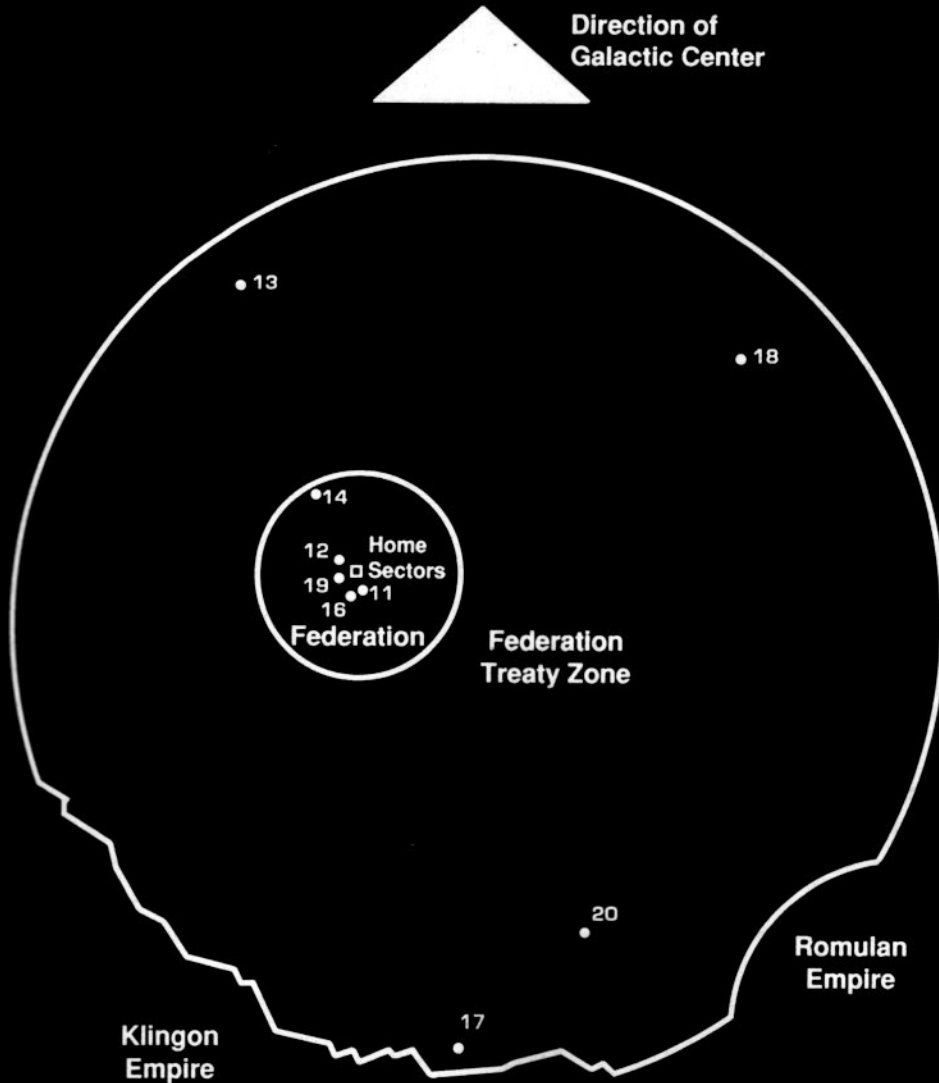

When looking at the enormous stellar population of the Federation, it is necessary to remember that 87% of these are Red Dwarf stars, incapable of supporting a Class M planet.

Starfleet DYNAMICS

-Major Stellar Systems

The above diagrams show the coordinates of the twenty major stellar systems of the Federation. The first shows the relative position of the Federation Treaty Zone within the Milky Way galaxy. The second shows the positions of systems 11 through 20 - those systems not actually within the Federation Boundaries, but rather within the Federation Treaty Zone. This second chart also shows the locations of the Klingon and Romulan Empires. The third Chart shows the positions of systems 1 through 10, in the eight Sectors closest to Sol System - the so-called Home Sectors.

Note that these twenty systems comprise only a minuscule fraction of 1% of the total number of stellar systems within the Treaty Zone (estimated at 5600000). Only 40% of the Treaty Zone has been charted, and only 15% has been explored. Of the 1500 Federation member systems, 73% are within the Federation boundaries, the remainder being in the Treaty Zone.

These twenty systems are included herein because of their primary economic importance to the Federation. As such they are the nexus points for major spacelanes, and over 70% of commercial and private shipping can be found traveling between them.

The following are basic Astro-geographic read-outs of the aforementioned twenty systems.

Major Systems Coordinates				
CODE	SYSTEM	COORDINATES		
		X	Y	Z
MAJOR SYSTEMS WITHIN THE HOME SECTORS				
1	Sol	+023.9	+061.8	+000.0
2	Alpha Centauri	+024.6	+062.5	-001.0
3	Altair	+026.2	+057.4	+000.8
4	Procyon	+022.5	+065.0	+000.3
5	40 Eridani	+028.1	+066.1	-000.7
6	Epsilon Indi	+025.5	+060.9	-002.9
7	61 Cygni	+025.8	+060.0	+002.1
8	Sirius	+023.4	+064.3	-000.8
9	Tau Ceti	+027.0	+063.3	-001.0
10	Vega	+028.2	+061.3	+006.9
OTHER MAJOR SYSTEMS				
11	Aldebaran	+010.6	+056.5	-015.1
12	Arcturus	+027.6	+070.4	+006.6
13	Antares	+172.1	+118.9	-013.9
14	Spica	+085.8	+088.4	-021.4
15	Betelgeuse	+192.1	+380.6	-125.7
16	Capella	+011.1	+060.1	+004.6
17	Rigel	-209.0	+007.7	-136.0
18	Deneb	+142.7	-143.4	+382.5
19	Canopus	+015.4	+063.7	-028.7
20	Argellus	-154.7	-059.2	-121.2

Sol System

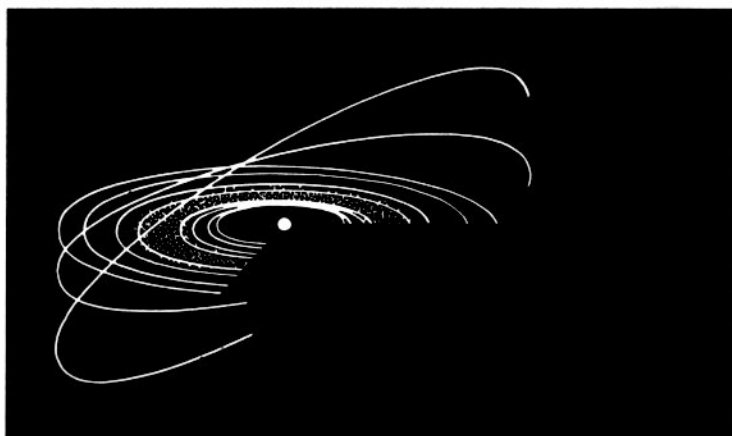

Home system of the Human species. major industrial activity throughout the entire system., with mining centered on Mercury, Luna, and the asteroid belt. Terra is the home of Starfleet Headquarters, Starfleet Academy 1, and the site of the Federation Council.

Stellar Type:
G2 Yellow Medium

Planetary Classes:
I J VI B

Inhabited Planets:
Sol-III Terra
Sol-IV Mars
Sol-IIIa Luna

II C VII B
III M VIII B
IV K IX L
V A X L

Command Department

Alpha Centauri System

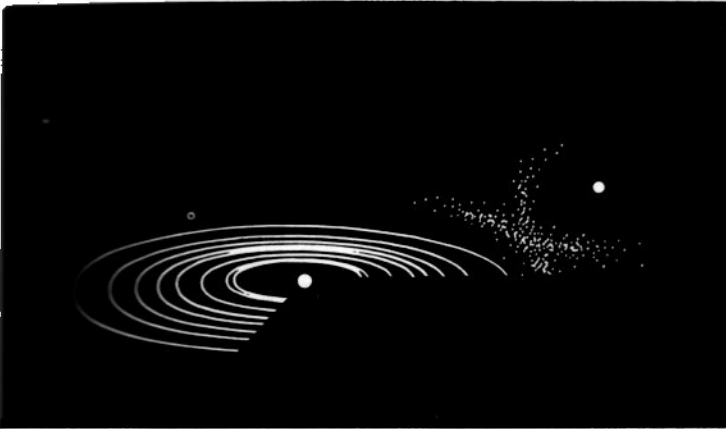

Athens was the first world contacted by Terran slower-than-light starships. Athens is a major industrial and scientific center. Mining activity is centered on the double asteroid field between Alpha Centauri A and B.

Stellar Types:
 G2 Yellow Medium
 Ko Orange Medium
 M5 Red Dwarf

Planetary Classes:
 A-I J
 A-II K
 A-III K
 A-IV M

Inhabited Planets:
 A Cent A-IV Athens

Altair System

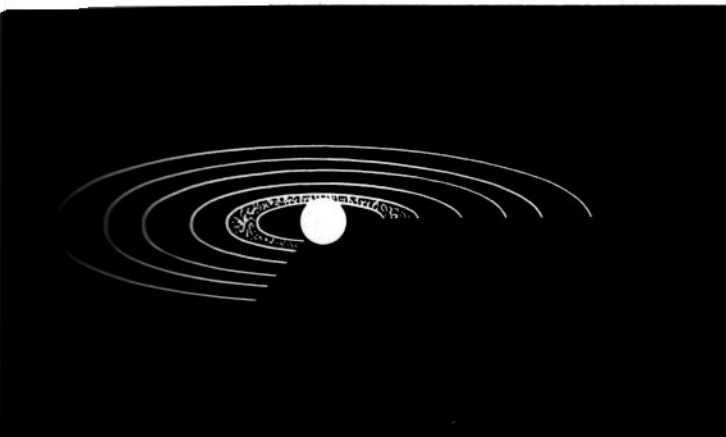

Home system of the Altairan species. C'Pppuux is an ancient colony world of Y'Pppuux [circa 20000 BC], after which a system-wide civil war was waged, dropping both worlds into savagery. Thanks to Federation mediation, both worlds now share their valuable asteroid belt resources.

Stellar Type:
 A7 White Giant

Planetary Classes:
 I J IV M
 II J VI K
 III E VII M

Inhabited Planets:
 Altair-IV Y'Pppuux
 Altair-VI C'Pppuux

Procyon System

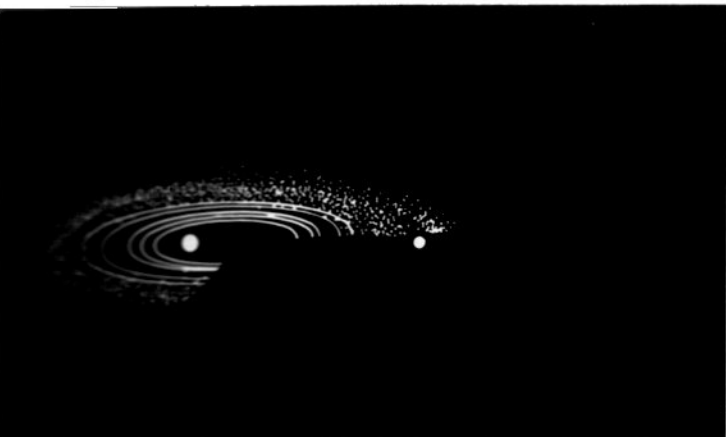

Terra 4 was the third human colony - and the first to be launched after the advent of early warp drive. Terra 4 is a major industrial and agricultural world. Although the planet is mineral-poor, there is major mining activity within the asteroid belt.

Stellar Type:
 F2 Yellow-White Medium
 DF Yellow-White Dwarf

Planetary Classes:
 A-I J A-I K
 A-II J A-V B
 A-III M

Inhabited Planets:
 Procyon A-III Terra 4

Starfleet DYNAMICS

40 Eridani System

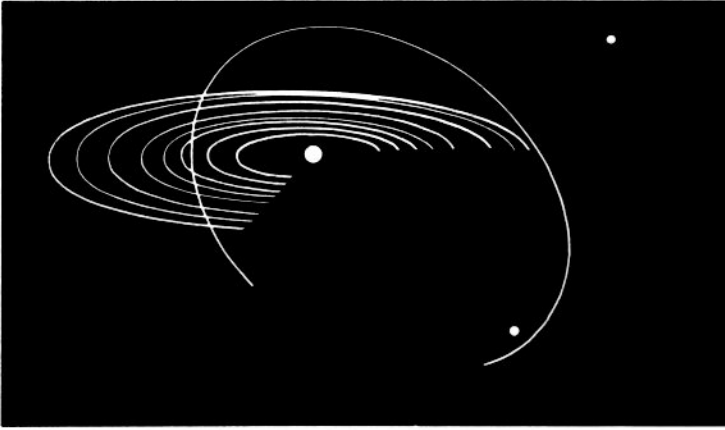

Home of the Vulcan species. 40 Eridani B-I is a Class L Variable Gas Giant. Frozen solid for most of its orbit, it thaws whenever passing close to A. Outgassing during that time can cause severe orbital disturbances to A-II, which in turn triggers tidal and climatic effects on Vulcan.

Stellar Type:	Planetary Classes:		
K1 Orange Medium	A-I M	A-V B	
DA White Dwarf	A-II K	A-VI B	
M4 Red Dwarf	A-III K	A-VII L	
	A-IV A	B-I L	

Inhabited Planets:
40 Eridani A-I Vulcan

Epsilon Indii System

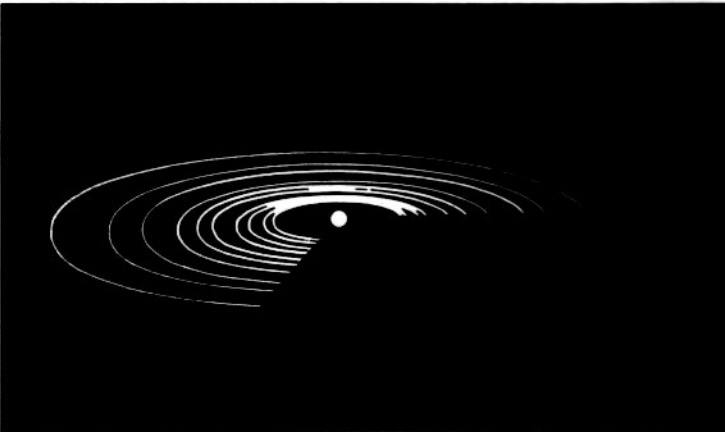

Home system of the Andorian species. Epsilon Indii-IV (Triacus) was once the home base of a marauding pirate fleet, but is now barren. Andor is a technological and industrial center.

Stellar Type:	Planetary Classes:			
K5 Orange Medium	I	J	VI	M
	II	C	VII	M
	III	D	VIII	K
Inhabited Planets:	IV	E	IX	B
E Indii-VII Andor	V	G	X	L

61 Cygni System

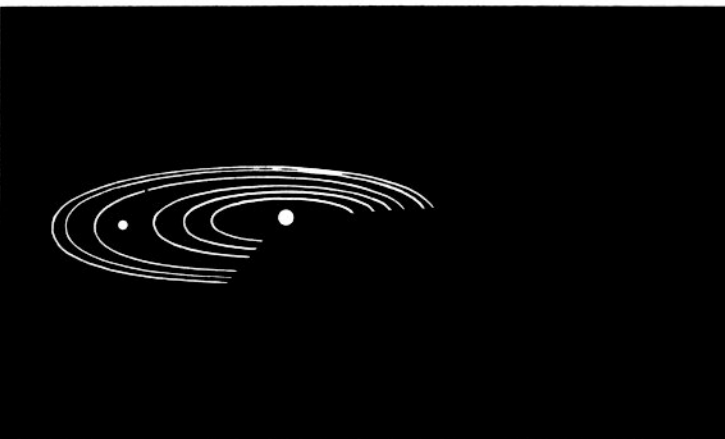

Home system of the Tellarite species. Tellar and 61 Cygni B achieve orbital conjunction every seven standard years, resulting in a brief but extreme climatic heat wave, followed by six years of cooler cycling. Tellar is a major industrial center, relying on out-system mining for raw materials as well as mines on 61 Cygni A-IV.

Stellar Type:	Planetary Classes:		
K5 Orange Medium	A-I J	A-V M	
K7 Orange Medium	A-II C	A-VI B	
	A-III C	A-VII B	
Inhabited Planets:	A-IV E		
61 Cygni A-V Tellar			

Command Department

Sirius System

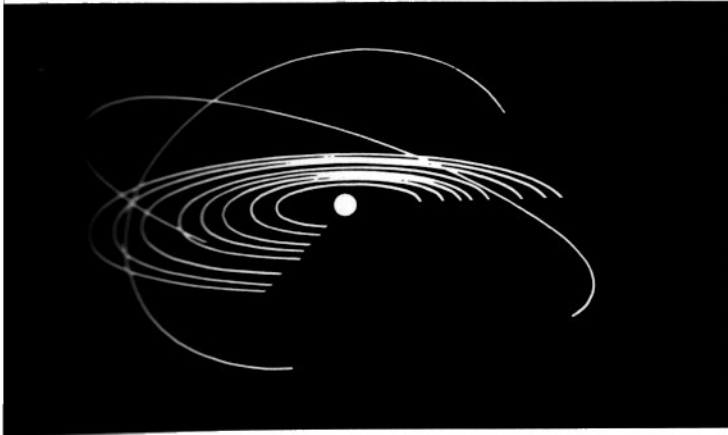

Neo-Caledonia was the first Terran colony. It is a major industrial (shipbuilding) and agricultural world. Sirius A-VII is mined for various metals. Due to the tidal influence of Sirius B (a very dense white dwarf star), the orbits of Sirius A-VIII and -IX are highly inclined to the ecliptic.

Stellar Type:	Planetary Classes:
A1 White Medium	A-I J A-V B
DA White Dwarf	A-II C A-VI B
	A-III M A-VII B
	A-IV K A-VII L
Inhabited Planets:	A-IX L
Sirius A-IX	Neo Caledonia

Tau Ceti System

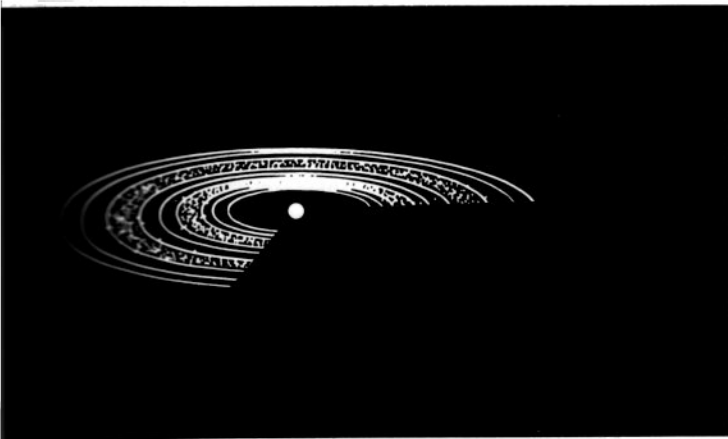

Kaferia is the home planet of the Kaferian species. A botanical paradise, it features little in the way of heavy industry, preferring a more relaxed approach to civilization, although trade is welcome. Amber is the second Terran colony. It serves as a center for Federation shipping. Both worlds share the wealth provided by the metal-rich twin belts, and the crystal-rich Tau Ceti-V.

Stellar Type:	Planetary Classes:
G8 Yellow Medium	I J VI K
	II C VII A
Inhabited Planets:	III M VIII B
Tau Ceti-III Kaferia	IV M IX L
Tau Ceti-IV Amber	V G

Vega System

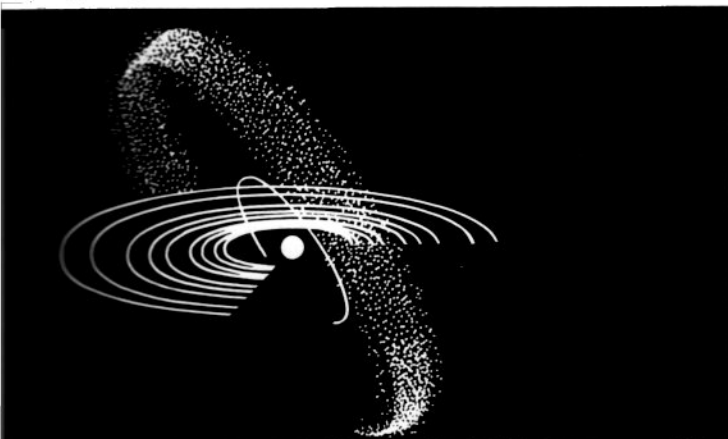

Due to the intensity of Vega's emissions, only the outer planet is habitable. The asteroid belt is especially thick, forming an almost-solid cylindrical ring around the star. Mining activity within the belt is the major source of industry. The planet's inhabitants appear to be descendants of an unknown transplanted human culture. Due to the asteroid belt, ships should exercise care.

Stellar Type:	Planetary Classes:
A0 White Medium	I J VI A
	II J VII K
	III E VIII K
Inhabited Planets:	IV F IX M
Vega-IX	V A

Starfleet DYNAMICS

Aldebaran System

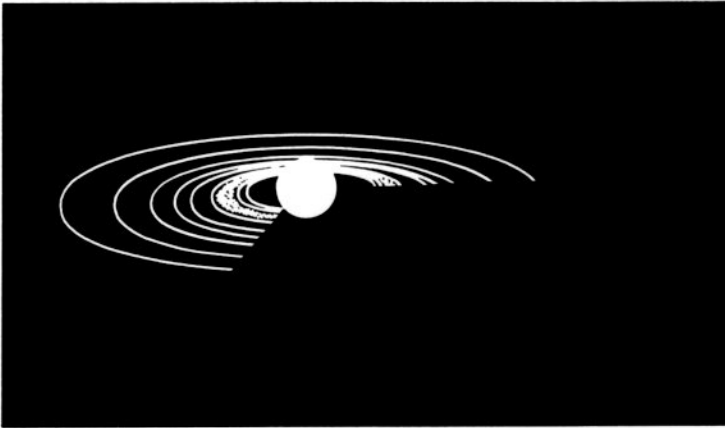

Twenty-fifth Terran colony. Industry centers around construction and agriculture, with extensive mining of Aldebaran-XI for raw materials (Dilithium). Periodic intense solar storms and ion storms can present a hazard to shipping.

	Planetary Classes:			
	I	J	V	K
Stellar Type:	II	C	VI	F
K5 Orange Supergiant	III	M	VII	B
	IV	K	IIIX	B
Inhabited Planets:				
Aldebaran-III	Aldebaran Colony			

Antares System

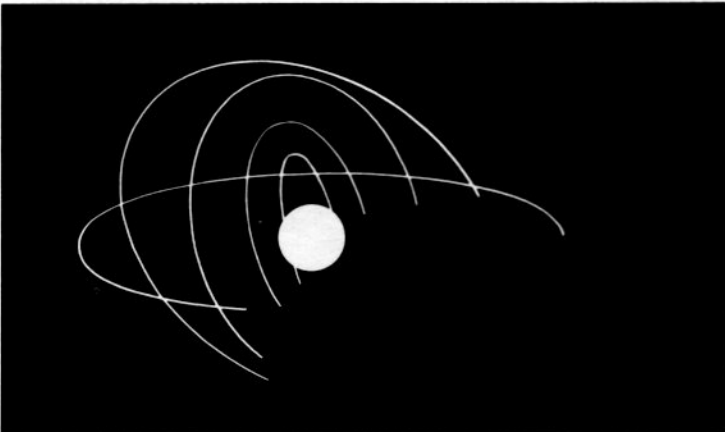

Ultima Thule is not truly a colony world, as it exists merely as a source of various trade items, and is not truly habitable. As such it holds a mostly transient population of miners and other entrepreneurs. No one species approaches being dominant in number, and there is no internal government besides the Federation-appointed regulatory commission.

	Planetary Classes:			
	I	M	VI	A
Stellar Type:	II	K	VII	A
M1.5 Red Giant	III	K		
Inhabited Planets:				
Antares-I	Ultima Thule			

Arcturus System

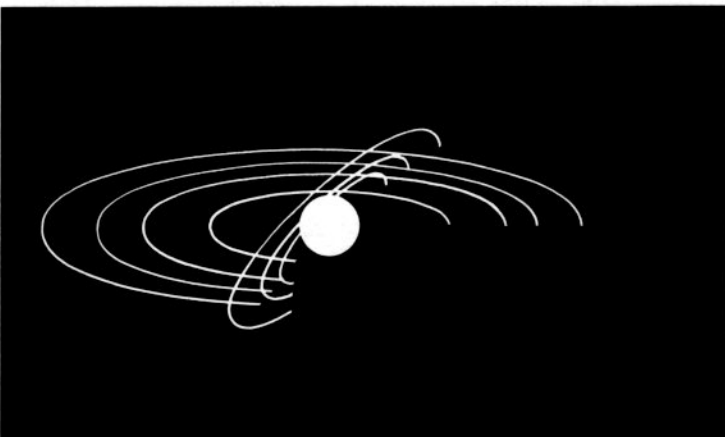

Fifth Terran colony. Planets in the system are in two distinct ecliptic planes, one angled 34° from the other. Arcturus 4 is a cultural and intellectual center, with little heavy industry except for agriculture. Mining of the mineral-rich Arcturus-III is sub-contracted to extra-system corporations.

	Planetary Classes:			
	I	J	IV	M
Stellar Type:	II	C	V	A
K1.5 Orange Supergiant	III	E	VI	B
Inhabited Planets:				
Arcturus-IV	Arcturus 4			VII B

Command Department

Spica System

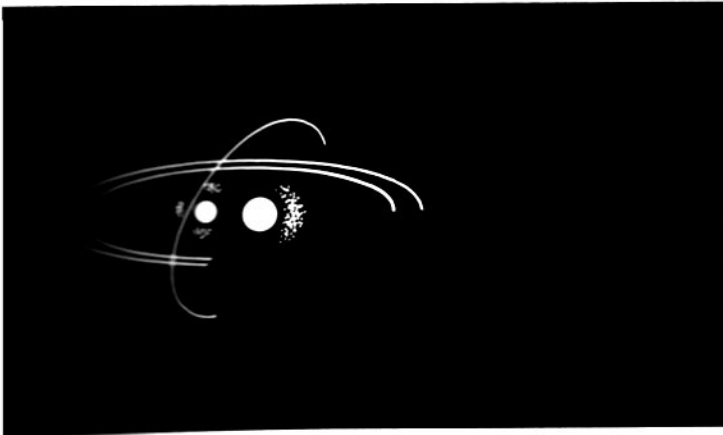

Due to the orientation of Twilight's orbit and axis, only the northern hemisphere is habitable, as the southern hemisphere is irradiated by Spica A. The equatorial regions are agricultural cornucopias. Secondary industries include the mining and processing of various metals in the four Lagrange asteroid fields.

Stellar Type:	Planetary Classes:
B1 Blue-White Giant	A-I A
B5 Blue-White Medium	A-II A
	B-I M

Inhabited Planets:
Spica B-I Twilight

Betelguese System

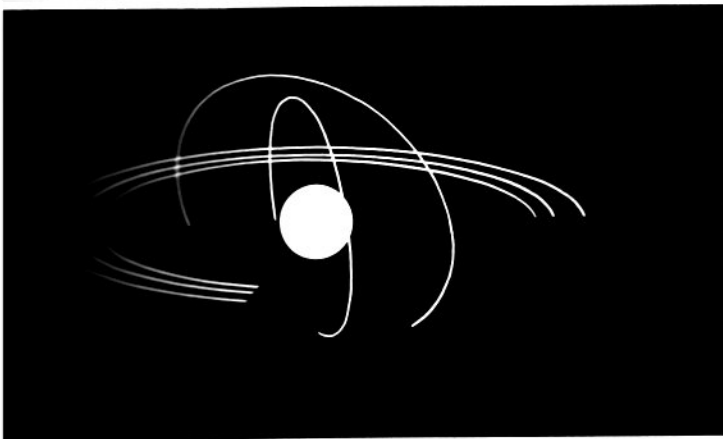

Home system of the Betelguesian species. One of the great tourism destinations in the Federation, due to its spectacular natural beauty. Major industries include bio-science research and development and agriculture.

Stellar Type:	Planetary Classes:
M2 Red Supergiant	I M IV B
	II K V B
Inhabited Planets:	III A

Betelguese-I Zethna

Capella System

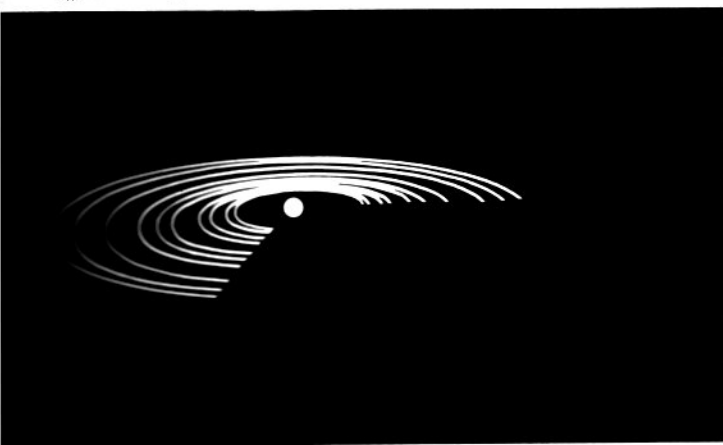

Akaar is a rich source of topaline, the extra-system mining of which is the planet's only major industry. The inhabitants (believed a transplanted Terran culture) are highly civilized, but prefer a nomadic, lo-tech lifestyle. Capella-III is as yet unmined.

Stellar Type:	Planetary Classes:
G6 Yellow Medium	I J VI A
G2 Yellow Medium	II J VII B
	III E VIII B
Inhabited Planets:	IV M IX L
Capella-IV Akaar	V K X L

Starfleet DYNAMICS

Rigel System

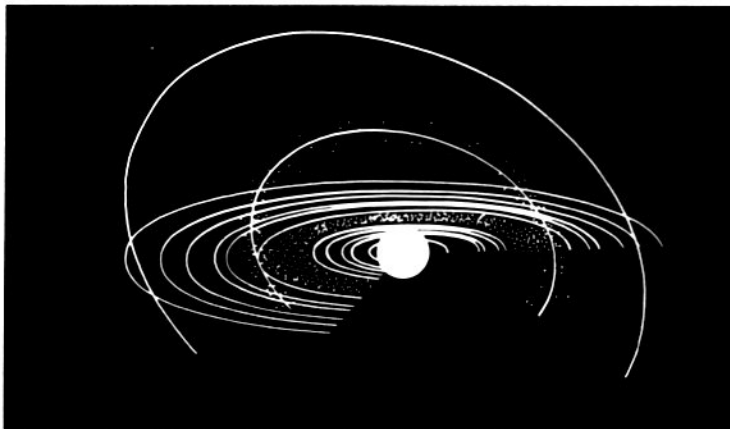

A major Federation power, due to the large number of inhabited planets. Rigel-II and -IV are the 28th and 29th Terran colonies. Rigel -V, -VI and -VII are thought to be lost alien colonies.

Stellar Type:	Planetary Classes:				
B8 Blue-White Giant	I	C	VIII	B	
	II	M	IX	K	
Inhabited Planets:	III	E	X	B	
Rigel-II	Rigel 2	IV	M	XI	B
Rigel-IV	Rigel 4	V	M	XII	G
Rigel-V	T'Chzzee	VI	M	XIII	A
Rigel-VI	Orion	VII	M	XIV	B
Rigel-VII	Kaarrm				
Rigel-XII	Rigel 12				

Deneb System

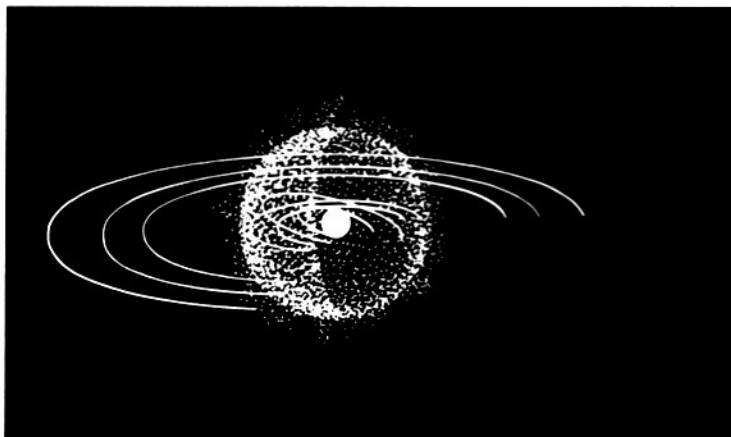

Home system of the Denebian species. Deneb-II is their home world, with Deneb-V being a joint Denebian/Terran colony. Deneb-IV is a small Terran mining-entertainment colony, home base to asteroid miners. The system is a major industrial and intellectual center.

Stellar Type:	Planetary Classes:			
A2 White Supergiant	I	J	V	M
	II	M	VI	B
Inhabited Planets:	III	F	VII	A
Deneb-II	Rsfuult'T	IV	M	
Deneb-IV	Deneb 4			
Deneb-V	Rsm't'T			

Canopus System

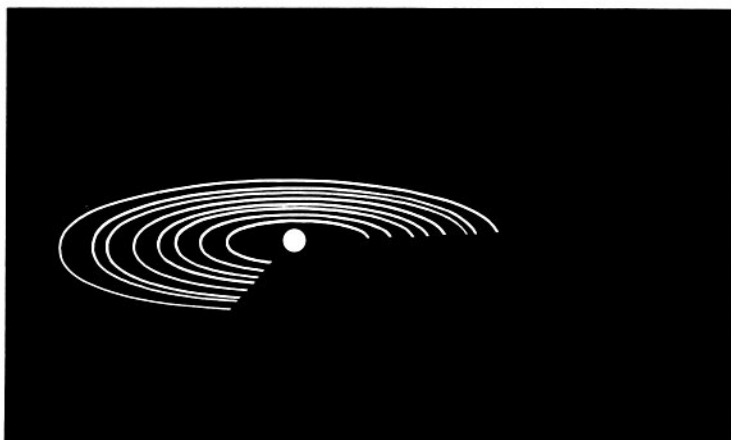

Home system of the Untha^lo species - semi-humanoids protected from outside contact by the Prime Directive. Canopus-III was the 21st Terran colony. It's industries include agriculture and computer manufacture, in addition to the mining of Canopus-IV

Stellar Type:	Planetary Classes:				
A9 White Giant	I	J	V	K	
	II	M	VI	A	
Inhabited Planets:	III	M	VII	B	
Canopus-II	Untha^lo	IV	E	VIII	N
Canopus-III	Colony 21				

Command Department

Argelius System

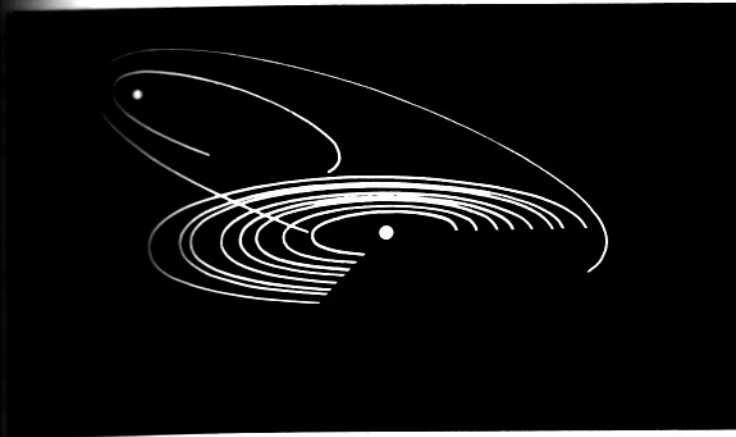

Argelius is inhabited by humans, thought to be a transplanted Terran culture. Originally war-torn, the planet is now completely pacifistic. It's location as a port is essential, but due to the inherent Argelian life-style, major industries, port activities, and defense are contracted to out-worlders.

Stellar Type:	Planetary Classes:				
G3 Yellow Medium	A-I	C	A-VI	B	
DG Yellow Dwarf	A-II	M	A-VII	B	
	A-III	K	A-VIII	L	
Inhabited Planets:	A-IV	K	B-I	J	
Argelius-II	Argelius 2	A-V	A	B-II	J

Galactographic Regional Terms

Quadrants

For purposes of macro-administration, the Federation Treaty Zone and Federation are divided into nine Quadrants.

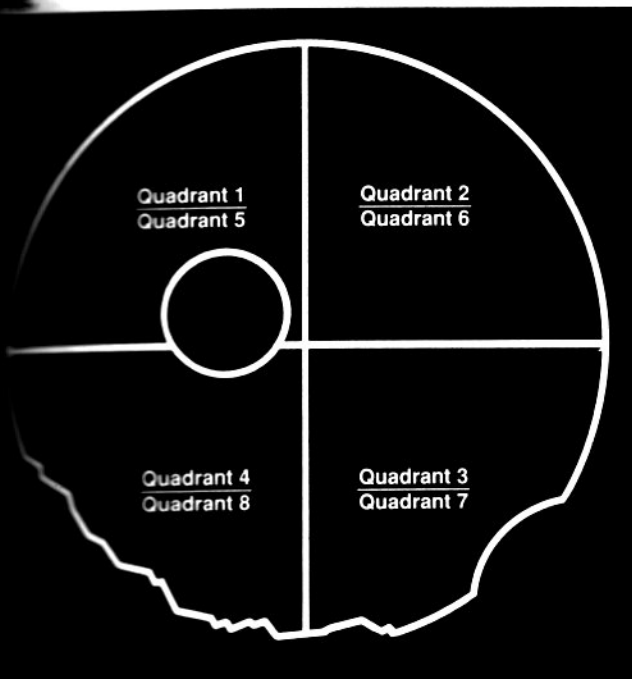

Sectors

For navigational reference purposes, the Federation (and the aforementioned Treaty Zone) have been subdivided into a cubic grid array - each cube (or Sector) being 10 parsecs on a side. A positional coordinate is listed as X-Y-Z displacement from the Federation Center, which has the

coordinates [0.0 , 0.0 , 0.0] and is 9200 parsecs from the Galactic Center. As an example, Sol is located at coordinates [23.9 , 61.8 , 0.0]. The Federation is divided into eight Quadrants, being bisected three times through its center along the X-Y, Y-Z, and Z-X planes. These Quadrants are designated A-H, and continue out to the boundary of the Treaty Zone's theoretical spherical shell. Sectors are officially designated by listing the eight sets of coordinates marking their corners. A more common practice is to refer to each Sector by its most famous star/planet/or astronomical feature. This has led to such colorful nomenclature as the Mutara Sector, the Rigel Sector, and the Home Sector (which contains the home systems of the five original Federation members. (See: MAJOR STELLAR SYSTEMS OF THE FEDERATION).

-Neutral Zones

Within the spherical volume of the Federation (and Treaty Zone) are many Neutral Zones. These are small spherical interdiction volumes of space, surrounding either a single solar system or a group of stars. The reasons for the establishment of these Neutral Zones are varied, and there are several types. However, they can be divided into three groups: Military, Social, and Commercial: Military: A Military Neutral Zone is set up to surround any enemy of the Federation, whose claimed territory exists within, or impinges upon the Federation or the Treaty Zone. Some examples include the Klingon and Romulan Empires, which although they do not exist solely within the Treaty Zone none-the-less part of each impinges upon it. Other Neutral Zones existing entirely within the Federation include the Tholian Annex and the Kzin Patriarchy. The existence of said Neutral Zones are set up by negotiation between the Federation Security Council and the affected enemy government as a treaty. Neither military nor commercial/private vessels from either side are permitted to cross the

Starfleet DYNAMICS

Neutral Zone - in some cases this would be tantamount to a declaration of war.

Social: A Social Neutral Zone is set up to surround a solar system whose inhabitants must be protected from contact with Federation cultures and technologies, for fear of destroying or contaminating a developing culture. Some examples include the M43 Alpha and Omega systems. These Neutral Zones are set up by a permanent committee of the Federation Council, acting on findings of the initial contacting vessel and the logs and recommendations of its Captain. No private or commercial vessel will be allowed within one-tenth parsec of the interdicted system. Any approaching vessels will be detected by the guardian buoy within the system, which will transmit a warning to it. Should the vessel persist, the buoy will broadcast an alert signal to the nearest Starbase, unless the vessel transmits an override signal to temporarily disarm it. These overrides are different for every buoy, and are highly classified. A starship will be dispatched by the Starbase to investigate any trespasser, and trespass carries a severe penalty. Periodically, the Federation committee will request that Starfleet send a starship to investigate and update surveillance on an interdicted world. This will consist of both orbital scanning and landing party missions, the purpose being to re-evaluate the culture and estimate the time required until the planet will be ready for Federation contact. The Prime Directive will be strictly observed during these missions. Reasons for a Captain to recommend a Social Neutral Zone (and the corresponding Prime Directive status) are:

- 1 - Lack of a World Government
- 2 - Existing Global Warfare
- 3 - Lack of Space Travel
- 4 - World-wide Tyranny
- 5 - Unique Cultural Direction
- 6 - Total Racial Paranoia

Commercial: A Commercial Neutral Zone is set up as a punitive measure, to isolate a planet from interstellar trade and contact. These are set up because the conduct of the government involved towards other Federation worlds is, beyond any doubt, of a predatory nature. An example is the Orion Colonies, which were placed into a Commercial Neutral Zone on Stardate 3842 due to government-sponsored acts of piracy. At the recommendation of Captain James T. Kirk, the planet was interdicted. After an arbitrary 10-year period, the Zone will be canceled and the Orions will be placed on probationary status. (See: BUOYS)

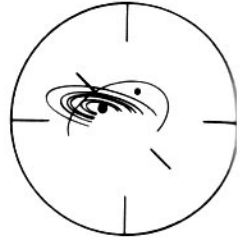
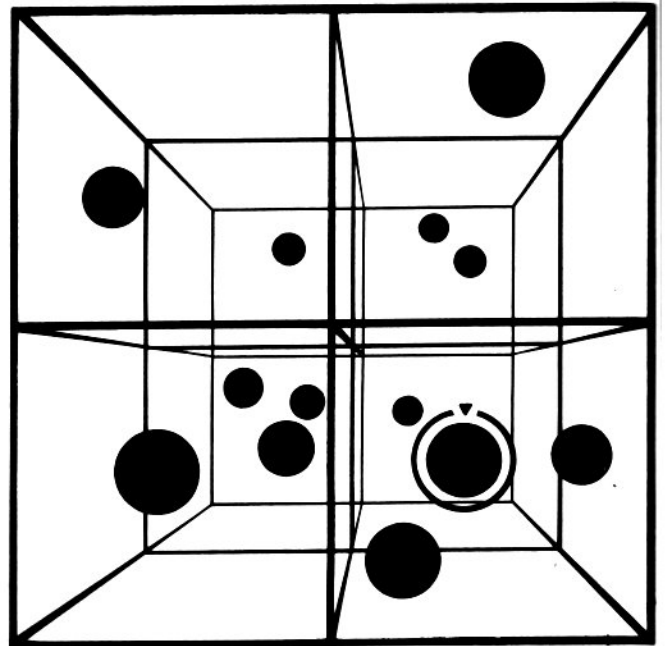

NEUTRAL ZONE 113

ENCLOSED: 892-IV

TYPE: SOCIAL

EFFECTIVE: STARDATE 4040

REASON: WORLD-WIDE TYRANNY

NOTE: CULTURAL MATRIX IS EVOLVING
TOWARD A FREE SOCIETY.

EXAMINER: Cpt. J. T. KIR

Starbases

A Starbase is a large, stationary command - usually on a planet - which includes orbital drydock facilities, storage and warehousing facilities, starship refueling and fuel depot facilities, communications and office facilities, etc. There are presently thirty-two Starbases within the 58,000,000 cubic parsec volume of the Federation Treaty Zone. These are exclusively military posts. In setting up these Starbases, a cubic-holographic array volume network was chosen to precisely represent and cover all of the Treaty Zone (see model). Generally, the stellar system with a

Command Department

Class M planet closest to the coordinates designated was chosen as the site for a particular Starbase. If no suitable planet was available within a parsec of the desired coordinates, either a non-Class M planet was terra-formed with mines and underground installations, or an asteroid was moved into place and terra-formed, or else a large space station was constructed at the desired location.

Starbases are commanded by a flag officer, typically a Commodore. As there are four Starbases per Quadrant (the inner - three outer), the innermost Starbase (that closest to the Federation) will be assigned the senior officer, and will become the seat of Starfleet Operations for that Quadrant. A Quadrant's Sub-fleet will be assigned among the four Starbases in such a manner as to most effectively utilize the vessels to their maximum potential. The various Sub-fleets are of different sizes and make-ups, reflecting each Quadrant's individual challenges.

Starbase Locations

The following illustration shows the coordinates of the thirty-two Starbase presently constructed. Their relative positioning can be best visualized by imagining seven spherical cubes - 100 parsecs on a side - with the center one housing the Federation, and surrounded in turn by the remaining six, one on each face. Each of the resulting thirty-two corners and intersections is a Starbase coordinate. Outside of this model is the spherical boundary of the Federation Treaty Zone. In their diagram provided, the top view shows the X/Z coordinates superimposed on a side-view of the Federation Treaty Zone. The secondary views show the Z ("vertical") plan, using a separate X/Y view for each of the four levels: 4, stacked on 12, stacked on 12, stacked on 4. The result is a Holographic Array, in which the Starbases are spaced equally throughout the Treaty Zone's volume: eight clustered around but inside of the Federation, and sixteen farther out, almost contacting the periphery of the Treaty Zone. Starbases 11, 12, 31, and 32 closest to and responsible for patrolling the Romulan/Federation Border Neutral Zone, just as Starbase 30 is charged with patrolling the Romulan/Federation Neutral Zone (see: FLEET STRENGTHS & STATIONING)

Starbase Coordinates

STAR-BASE	QUADRANT	COORDINATES		
		X	Y	Z
1	1	+050	+050	+050
2	1	+050	+050	+150
3	1	+150	+050	+050
4	1	+050	+150	+050
5	2	-050	+050	+050
6	2	-050	+050	+150
7	2	-050	+150	+050
8	2	-150	+050	+050
9	3	-050	-050	+050
10	3	-050	-050	+150
11	3	-150	-050	+050
12	3	-050	-150	+050
13	4	+050	-050	+050
14	4	+050	-050	+150
15	4	+050	-150	+050
16	4	+150	-050	+050
17	5	+050	-050	-050
18	5	+050	-050	-150
19	5	+050	-150	-050
20	5	+150	-050	-050
21	6	+050	+050	-050
22	6	+050	+050	-150
23	6	+050	+150	-050
24	6	+150	+050	-050
25	7	-050	+050	-050
26	7	-050	+050	-150
27	7	-150	+050	-050
28	7	-050	+150	-050
29	8	-050	-050	-050
30	8	-050	-050	-150
31	8	-050	-150	-050
32	8	-150	-050	-050

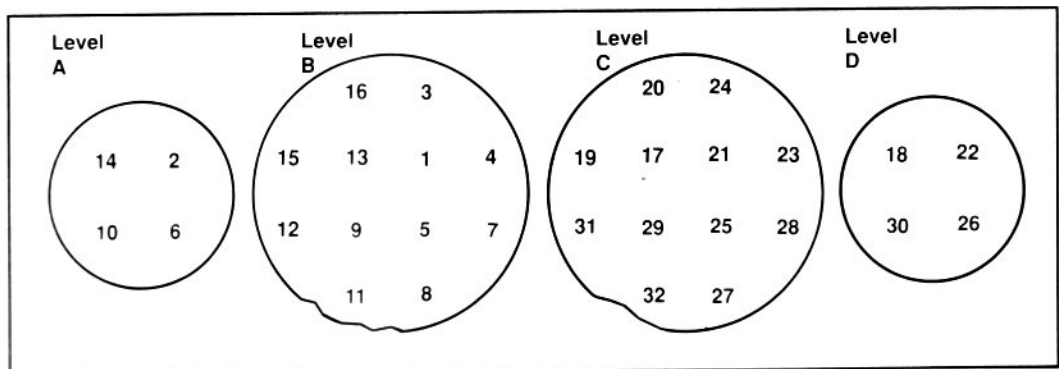
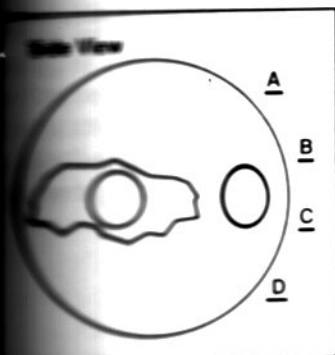

Starfleet DYNAMICS

-Other Military Installations

In addition to Starbases, Starfleet maintains a variety of stationary commands throughout the Federation. These are generally single-purpose in design and function. They include the Epsilon Series Monitoring Stations along the Klingon/Federation and Romulan/Federation borders, the Gamma Series Lithium Cracking Stations, the San Francisco Orbital Drydock Facilities, plus an assortment of supply depots and laboratories scattered throughout Federation space. The Commanding Officers of these establishments may range in rank from Captain to Lieutenant Commander.

-Space Stations

Some off-planet facilities are military, but have resident and transient civilian populations and industry as well. These have an on-board Starfleet Commanding Officer and contingency exactly as do ordinary military bases. The civilian element is responsible to obey such regulations as are issued. Such bi-nature facilities include Spacedock and the Kappa Series space stations.

-Private Facilities

Several off-planet facilities in Federation space are civilian, including private learning centers, research posts of the Vulcan Science Academy, various orbital construction facilities of space-craft manufacturers, and esoteric laboratory facilities. These do not have a Starfleet Commanding Officer or contingent. Rather they are all responsibilities of Starfleet Operations, which keeps track of on-going work, position, and maintenance scheduling, including any lapses in regulations it finds.

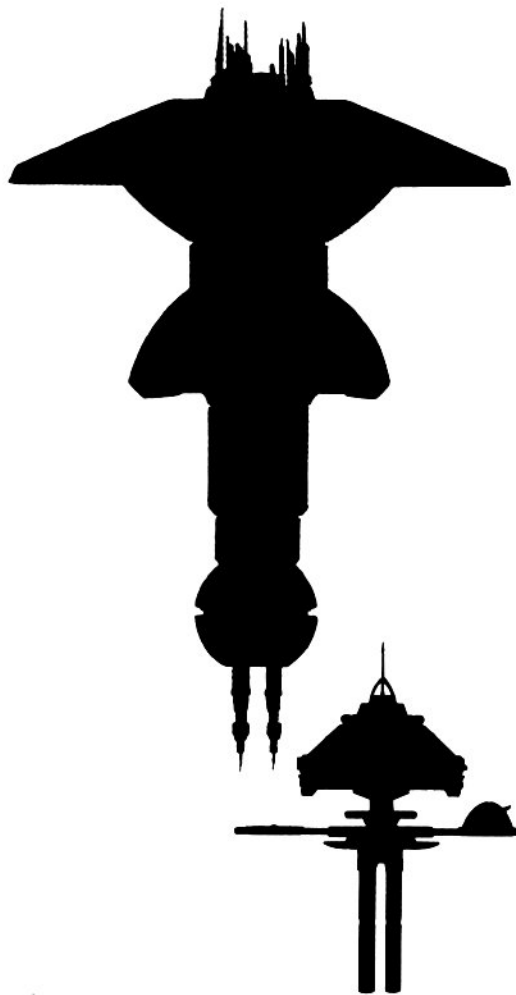

Starfleet

Component Services

Starfleet is a combined service, comprised of three distinct yet interlocking corps, each specializing in one or more disciplines.

Command Department

Starfleet Space Command Corps

Motto: To Boldly Go Where No Man Has Gone Before.

By far the largest component - and the most frequently mentioned and assumed when one is referring to Starfleet. The Space Command Corps comprises 50% of personnel aboard vessels, and roughly the same percentage of personnel within the Fleet as a whole. It includes those officers and enlisted men within the departments of: Command, Communications, Navigation, Sciences, and Medical - including Staff Officers. All personnel fall within the joint responsibility and authority of the Starfleet Commander and Operations Commander.

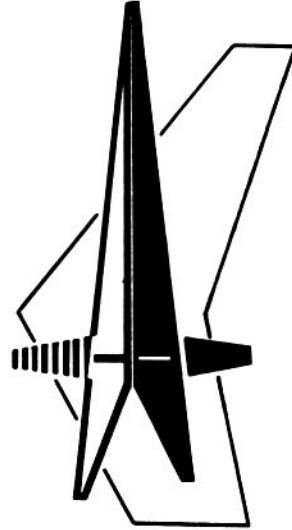

Starfleet Marine Corps

Motto: Forever Faithful.

Easily the second-largest component of Starfleet, comprising up to 30% of personnel. The Corps trains and provides personnel for Infantry, Military Police for various Starfleet installations, and Guards for Federation Embassies on neutral or enemy planets. The very best are assigned duty aboard Starfleet vessels - and serve as a ship's Security Department, but are none-the-less Marines. They fall under the responsibility of the Corps Commandant, who acts as a liaison with and under the Operations Commander.



Starfleet Corps of Engineers

Motto: Can Do!

Like the Marine Corps, the Engineering Corps is subdivided into various responsibilities. The best known is Propulsion & Power, which serves aboard Starfleet vessels and installations as the Engineering and Ship's Services Departments. This section makes up 40% of the Corps. Another section is the Construction Corps, which builds prototypes and Starfleet installations such as Starbases. The final section is Research & Development, which works in conjunction with theoretical scientists in designing various Starfleet projects. All fall under the responsibility of the Engineering Commander.

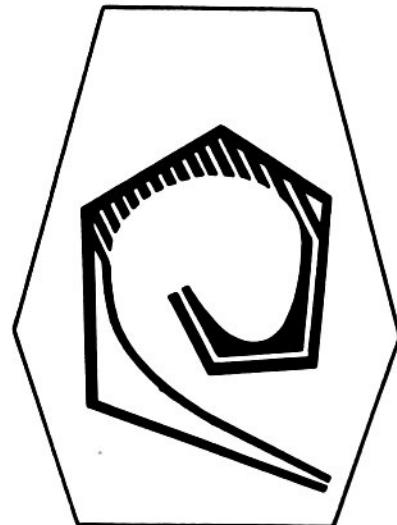

Starfleet DYNAMICS

-The Aims & Responsibilities of Starfleet

Upon the creation of Starfleet in 2183, it was charged with several duties and responsibilities. These act as guidelines for the entire Service, and for individual ships on extended patrol missions. Every officer aboard a Starfleet vessel has a duty to know these responsibilities, to understand them fully, and to be ready to enforce them:

1-To Protect Federation Peace: Starfleet is charged with protecting the peace of the Federation against enemies both domestic and foreign. In order to most effectively carry out this duty, Starfleet maintains a large fleet of armed vessels, and has established patrols along the territorial boundaries of enemies. Patrols within the Federation insure internal peace. However, Starfleet is not a galactic police force. It may not interfere with the activities of a non-member world, so long as said activities do not endanger a member world.

2-To Provide Aid and Assistance to Federation Members: Such aid and assistance may entail the delivery of a diplomatic mission to a distant star system, or it may consist of acting as a courier for an immensely important cargo. Such requests are made by the Federation Council, or by a Planetary Government, to the Starfleet Commander.

3-To Serve as a Gatherer of Knowledge: Starfleet vessels - especially the Class 1-B starships - are equipped with an extensive array of sensing equipment and laboratory facilities. When not actively involved in a military mission, a starship on patrol is always expanding the frontiers of knowledge for the Federation. This information, unless deemed to be of a nature vital to Federation security,

is handed over to the scientific community on a regular basis.

4-To Regulate Shipping Within the Federation Treaty Zone: Any interstellar commercial or private vessel, belonging to a member world or traveling amongst member worlds, falls under the responsibility of Starfleet. Each of these vessels must be documented - must have registers, enrollments, and licenses. These documents state and authorize the vessel holding them to engage in specific forms of commerce or activities (interstellar trade, passenger liner, prospecting ship, pleasure yacht) and within a certain prescribed routing zone. Yachts are solely for pleasure and may not engage in trade. One of the documents is a manifest - which states the amount and precise nature of all cargo aboard. Some goods and materials are proscribed and forbidden within the Federation Treaty Zone. Any materials not listed on the manifest are considered Contraband - goods being smuggled. Starfleet vessels have the right to scan any vessel they encounter and to demand a transmitted copy of the ship's manifest. If the two do not match, or if the starship Captain is suspicious, he may demand that the vessel in question come to a stop and prepare to be boarded for a physical search. As well, starships enforce the Rules of Space Navigation among all interstellar vessels. Any ship found to be breaking these Regulations may be seized by the starship Captain. He will place the vessel's master under arrest and either tow the offending vessel to the nearest port, or else assign an officer and prize crew from the starship to take charge of the vessel and bring it to the nearest military port under its own power.

Starfleet Command

Logistics Command	— Starship Refueling and Supply
Operations Command	— Fleet Deployment
Combat Tactics Command	— Wargaming and Strategic Development
Training Command	— Academy and Ensign/Midshipman Programs
Intelligence Command	— Covert/Official Surveillance and Espionage
Communications Command	— Military/Civilian Band and Relay Monitoring
Legal Command	— Promotions, Reviews, and Courts Martial
Research & Development	— Design and Theoretical Engineering
Engineering Corps	— Construction, Repairs, and Refitting
Traffic Command	— Civilian Spacelane Control - Spacedock
Starbase Command	— Stationary Military Base Coordination

Command Department

Starfleet Command consists of the Starfleet Commander and eleven other flag officers, who have been assigned to Starfleet Headquarters in order to aid and assist him. These flag officers - ranging in rank from Commodore to Fleet Admiral - have been chosen from among the Admiralty-at-large so as to display (and develop) their tactical and administrative skills while serving as the Starfleet Commander's staff. As such, the responsibilities of the Starfleet Commander have been divided and delegated among these officers, so that each heads a Command within the hierarchy of Starfleet. These Commands are listed and defined as shown above.

Starfleet Command is located in San Francisco Terra, and is part of the United Federation of Planets Complex. As staff of the Starfleet Commander, the flag officers of Starfleet Command are also directly responsible to the Security Council. In fact, although Starfleet has only one "seat" in that Security Council, it is common for several members of Starfleet Command to attend such meetings, so as to properly advise Security Council members as regards the status of Starfleet resources.

Membership in Starfleet Command is not a permanent assignment. Members are rotated in and out from among the entire Admiralty, which also heads such Commands as Starbases and flagships. This provides the Starfleet Commander with an opportunity to review any and all of the flag officers within his Admiralty, while at the same time allowing some post-Starfleet Command flag officers a chance to re-familiarize themselves with active Commands. Thus, at any one time the Admiralty consists of 76 flag officers:

1 Starfleet Commander
11 Starfleet Command Flag Officers
32 Starbase Commanders
32 Flagship Commanders

Starfleet Operations

Starfleet Operations is a four-function directorate, under the Operations Commander. Normally located within Starfleet Headquarters - Terra, control can be shifted over to the Command Cruiser Citadel in wartime, and becomes the central control for all Sub-Fleet activity.

The following illustration shows a tactical display of the operation and surrounding Treaty Zone as viewed from a vantage point galactic north. Note that all stars have been edited from this display, leaving only the major spacelanes.

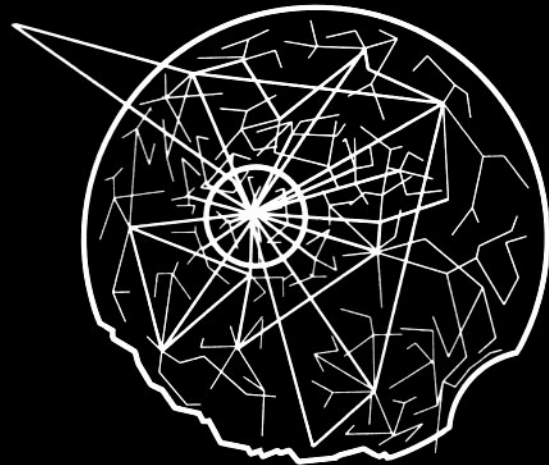

SITUATION: ANDORIAN-REGISTERED FREIGHTER SS THANELN TRANSMITTING DISTRESS CALL. HEAVY DAMAGE SUSTAINED FROM ION STORM OFF GAMMA-ALPHA SYSTEM. MAIN/AUX POWER OUT BATTERIES FAILING. STARSHIP USS POLLUX EN-ROUTE AT MAX W/F 9.5 ETARENDEZVOUS STARDATE: 9001.3. SS THANELN ADVISED AND STANDING-BY TO EVACUATE.

SIX COMMERCIAL VESSELS PRESENTLY TRAVELING WITHIN SECTOR-ALL ALONG MAJOR SPACELANES. TWELVE OTHER COMMERCIAL/PRIVATE VESSELS IN ORBIT SPACEPORT ANTARES II.

ANTARES SECTOR:

SPACELANES:

- ANTARES/RIGEL
- ANTARES/BOOTIS
- ANTARES/SOL

MAJOR SYSTEMS:

- ANTARES

OTHER INHABITED SYSTEMS:

- MEKKALAR
- Z'ZLLNFF

STARFLEET VESSELS:

- USS POLLUX

CIVILIAN VESSELS:

- SS KATHLEEN
- SS TOKYO MARU
- SS SARIL
- SS SPIRIT OF ST LOUIS
- SS THANELN

ENEMY VESSELS:

-

UNIDENTIFIED VESSELS:

-

Starfleet DYNAMICS

-Directorate 1 - Fleet Movement

The Prime function of Starfleet Operations is to coordinate Fleet movements. Acting according to the Starfleet Commander and pursuant to policy set forth by the Security Council, Starfleet Operations plans and arranges such activities as Starship rendezvous, survey missions, patrol routings, and rescue missions. In all such cases Starfleet Operations keeps careful track of all Starship movements as reported in by the individual vessels themselves during routine check-ins. In the event of loss-of-contact, Starfleet Operations alerts the Starfleet Commander at once.

-Directorate 2 - Civilian Shipping

The Second function of Starfleet Operations is to monitor private and commercial shipping traffic according to various sources. These include: direct linkage with the shipping companys' controller computers, flight plans as filed at departure spaceports, sensor telemetry from various surveillance buoys scattered through-out Federation space, and contact reports from Starfleet vessels encountering them underway. Starfleet Operations also arranges for rendezvous with patrolling starships or spaceships for contraband checks. Starfleet Operations monitors the Subspace Distress Band, and will vector a rescue mission to any vessel requiring assistance.

-Directorate 3 - Threat Analysis

The Third function of Starfleet Operations is to detect and monitor any non-Federation craft approaching or within the Federation or Treaty Zone. These may include non-member but friendly space-going races living within the Federation (such as the N'Ggnaatk Alliance) or enemy vessels from outside, who have violated their Neutral Zones (such as the Klingon and Romulan Empires). Sensor data is relayed to Starfleet Command from various sources. These include: border outposts, listening stations, surveillance buoys, and sensor probes launched into enemy territory.

-Directorate 4 - Defense

The Fourth function of Starfleet Operations is to design, assist in the construction, and assist in the maintenance of Global Defense Systems (see: GLOBAL DEFENSE SYSTEMS).

Starfleet Academy

Starfleet Academy is located on two campuses: San Fransisco Terra, and Starbase 1. It offers a wide variety of course programs, each tailored so as to suit the aptitudes of the particular enrollee, training to maximize his potentials in his chosen field, so that upon graduation the cadet will be prepared for commission.

-Command Program

The longest and most comprehensive. It can take 3 - 5 years to complete, depending upon the electives chosen and the aptitudes and abilities shown by the student - as well as any credits transferred from an accredited school in the appropriate area of study (such as the Merchant Marine). Depending upon the grades achieved and the final standing of the cadet, a graduate will be placed aboard a vessel as an Ensign, a Junior Lieutenant, or a Lieutenant, and posted to a position of authority within that vessel as a line officer.

-Staff Program

Shorter (2 - 3 years), and again can be abridged by appropriate pre-Academy training credits. While they include some Command training and orientation, the courses are aimed mainly at giving the trainee an overall education in his Department, outside of the selected area of specialization.

-Definitions

Cadet: Any student of the Academy, of any rank, whether on campus or in space.

Midshipman: A cadet assigned to a vessel for instructional purposes, but not yet graduated from the Academy.

Trainee: A cadet aboard a vessel, with regard to his area of specialization or designated Department. For example, the Chief Engineer would refer to all Engineering cadets as his trainees.

-Cadet Commissions

Before graduation, a cadet may be granted a commission. The reasons for this would be as follows:

- 1 - Excellent grades
- 2 - The cadet is undergoing Command training, and a superior officer wishes to place the cadet within the line of command, for observation in action. If the cadet's performance is outstanding, the officer may recommend that the brevet commission become permanent. Otherwise the cadet will revert to midshipman upon return to the Academy.
- 3 - Pre-Academy experience within the cadet's field of specialization.
- 4 - Pre-Academy space experience.
- 5 - Field commission for outstanding performance.
- 6 - The Commandant of the Academy may wish the cadet to be an instructor within the cadet's own field of expertise. Since an instructor must be an officer, the cadet would be commissioned. The commission might become permanent.

Command Department

Officers & Crewmen

Commissioned Officers & Ranks

All Starfleet personnel aboard a starship are either commissioned officers or enlisted men. Commissioned officers hold their positions of command by the authority of commissions awarded them by the Federation President, through the Starfleet Commander. A rank is a grade or level to which commissioned officers are appointed or promoted. An officer of a given rank is subject to all officers of higher ranks, and is superior in rank to any officer of lower rank. When officers have the same rank, the officer first promoted to that rank takes precedence. Commissioned ranks run from Flag Admiral down to Ensign.

Line Officers: Serve in the Command and Operations Departments aboard a starship. They have been specially trained at the Academy, both in their particular specialty and in how and why to lead men (see: STARFLEET ACADEMY). Only a line officer may serve in these two Departments. A line officer starts his career as an Ensign aboard ship, and has been carefully and rigorously tested by the Captain in all varieties of situations to see how he will perform under stress. Only after he has passed these tests will an Ensign be made a line officer.

Staff Officers: Serve as the heads of the other Departments and Divisions aboard ship. Staff officers were civilians who - because of valuable and highly developed skills/expertise in a particular area - are given commissions and assigned to a Department making use of their skills, with a corresponding rank and rating. As an example, postulate a skilled surgeon wishing to join Starfleet. After the extent and degree of his medical knowledge has been evaluated, he will study at the Academy how to efficiently run his Department or Division in a correct and military manner. As well, he will be familiarized with Starfleet duties and practices. Upon graduating from this rather shortened course, he will be assigned as a staff officer aboard a starship, either as Chief Medical Officer or as the Head of the Surgical Division. As a staff officer, he will only be entitled to issue orders to personnel within his own Department. A staff officer may, at some later time, opt to take Command training. He will be re-assigned to the Academy and complete this one-year course. Upon matriculation, the officer will be rated as both a line and staff officer: still in charge of his particular Department/Division, but also capable of assuming command in the absence of any superior Line officer.

A line officer may be distinguished from a staff officer by the Line/Staff Pin worn upon the back of the Shoulder Departmental Stripe (see: UNIFORM-INSIGNIA).

Design: A unique rank due to its brevet (temporary) nature is the lowest commissioned rank. What makes it special is that it can be lost without incurring a black mark on the record of the cadet, since it was understood to be brevet

from the first. Every graduate of Starfleet Academy is commissioned at graduation, usually as an Ensign. From this point in time the clock starts counting down - the testing period has begun. The rank of Ensign can only last two years. During this time the Ensign's performance in his duties is under constant scrutiny. The Captain and Executive Officer observe this junior officer to see if the traits, aptitudes, and values judged as befitting an officer are exhibited. At the end of the two year term (or sooner at the Captain's discretion) the ship's senior officers will gather in the Briefing Room to evaluate the Ensign. Although the final decision is the Captain's, information brought forward by the Exec, Medical Officer, and the Ensign's own immediate superior (Department Chief) are invaluable in this final evaluation. If the Captain decides that the Ensign is ready he will be promoted to the rank of Lieutenant Junior Grade. If the Ensign does not meet the Captain's expectations, there are several options open. The cadet may choose to return to the Academy in the hope of strengthening any weak areas noted by the Captain. Contrawise the cadet may choose to be decommissioned, and serve as an enlisted crewman (probably as a petty officer).

An Ensign may be placed in charge of a Division - such as the Transporter Division within the Engineering Department. He may not be placed in command of a vessel or shuttlecraft, as he has not yet completed his Command training, and so is not qualified to run a separate command without a senior officer's supervision. Never-the-less he may hold the position of Duty Officer. This designates the officer who sits at the conn (Captain's station in the Bridge) during the Captain's off-duty time. It is not considered a separate command, as the other officers/crewmen may request confirmation from the Captain if they receive orders from the Duty Officer that they believe questionable. In such a case, the Captain or Exec must be aboard ship.

-Enlisted Personnel & Petty Officers

Enlisted men make up the majority of Starfleet personnel. While each commissioned officer must have a general overall knowledge of the various duties and functions within his Division, enlisted men are specialists, each one carefully trained to function flawlessly within his own chosen task. Enlisted men are divided into three rank categories: Petty Officers, Chief Petty Officers, and Technicians (crewmen).

Petty Officers: Only officers may give orders. If one crewman gives an order to another, he is in the wrong. Furthermore, the second crewman would be in the wrong were he to obey that order. This is because the ordinary enlisted man does not have the authority to give orders, he is not in the line of command. All he can do is pass along to another an order he has been given by an officer - naming that officer. However, the ratio of officers to enlisted men is about 1:8, far too few to supervise every activity. For this

Starfleet DYNAMICS

reason, the rank of Petty Officer exists. Petty Officers have earned a special status among the enlisted men. They are in effect non-commissioned officers, falling between Ensign and Technician. Beside being masters in their technical skills, they have been taught command and leadership skills which enable them to smoothly and efficiently supervise a Division in the absence of their commissioned Division Head.

Chief Petty Officer: Each Department aboard ship may have several Petty Officers (usually one per shift per Division). One Petty Officer in each Department will be the Chief Petty Officer. He is senior to all Petty Officers and crewmen in that Department, and is responsible for them to the Department Head.

Ratings and Rates: Used to identify the skills and qualifications of Technicians. The Rating (specialty) identifies a Technician as being qualified in a particular field - each of which is contained within its own Division (eg: Electronics Technician, Geology Technician, etc.). The Rate identifies the level of skill he has achieved within that specialty (eg: 3rd Class, 2nd Class, 1st Class). Thus a Technician might be referred to as Electronics Technician - 2nd Class, Jones. Training, especially on-the-job training, never ends for a Technician. His Petty Officer is always drilling him and his mates to develop and hone their skills - whether it be an already existing task or new technology. A Technician's Rating and Rate can be read from the Division Emblem worn on his Departmental Tabs (see: UNIFORM-INSIGNIA).

Performance Evaluation: A Technician's officers and Petty Officer observe the manner in which he carries out his tasks and learns new skills. Such performance marks are appended to his file semi-annually. These marks help determine such factors as Rate advancement, possible promotion to Petty Officer, or even assignment to Starfleet Academy. **Responsibility:** Each Technician is assigned to a duty station within a Division, under the supervision of a Petty Officer, who will direct the duties of all Technicians within that Division during that shift.

Term and Discharge: Unlike officers, enlisted men are not career men. An enlisted man signs on for a Service Term of five years. At the end of that term, he may (at Starfleet's discretion) re-enlist, or he may resign.

Every officer or enlisted man leaving Starfleet is given a discharge. Each discharge has a particular Type and Reason, and these will depend upon the circumstances surrounding the discharge and the record of service. Types and reasons are shown below:

Types:	Reasons:	
- Expired Term	- Expired Term	- Dependency
- Disability	- Disability	- Reserve Status
- Unsuitability	- Unsuitability	- Retirement
- Fleet Discretion	- Fleet Discretion	

Military Decorum

An officer in Starfleet serves among other officers and over enlisted men. Some officers are his superiors, some his equals, and some his subordinates. Likewise all enlisted men aboard the ship are his subordinates. There are different forms and ways of interacting with all of these, depending upon relative seniority. However, something in common with interacting with all of them is courtesy. Treating fellow Starfleet personnel with proper respect and appropriate obedience is as essential and necessary a part of being an officer as is the giving of orders.

-Addressing Officers

An officer is a peer among other officers. However, some formalities do pertain. When addressing or greeting a superior officer, he is addressed by rank and last name or simply by rank ("Captain Smith" or "Captain"). An officer of equal rank is addressed by rank, rank and last name, or if you have his permission by first name ("Lieutenant", "Lieutenant Jones", or "Bob"). A subordinate officer is addressed by rank, rank and last name, the title Mister, the title Mister and last name, or if you have his permission by first name ("Ensign", "Ensign Peters", "Mister", "Mister Peters", or "Kevin").

-Addressing Enlisted Men

An officer may use the following forms of address when speaking to an enlisted man. A non-rated enlisted man is referred to by last name ("Williams"). A Petty Officer is addressed by his rating, or rating and last name ("Engineer", or "Engineer Wright"). Chief Petty Officers are referred to by the title Chief, or Chief and last name ("Chief", "Chief Brown").

-Answering A Superior Officer

When a superior officer gives an order, the correct response by the subordinate is "Aye, aye, sir". The superior may respond "Very well" or "Very Good", but not the subordinate. Saying "Aye, aye, sir" means three things:

- I heard the order.
- I understood the order.
- I will carry it out to the best of my ability.

To a question requiring a more verbose response, any answer must be respectful and must end with "sir". Similarly, an enlisted man will reply "Aye, aye, Chief" to his Chief Petty Officer.

Discipline & Courts-Martial

The term discipline is often used to mean punishment. But

Command Department

The real meaning of discipline can best be defined by the term "proper attitude". A well disciplined crew have the proper attitudes. They are willing to follow orders because they believe in what they are doing, they respect their superiors, and they believe that they are being treated fairly in return. They behave in a military manner, and take pride in their fleet, their ship, their Department, and their uniform. When discipline fails - that is when some personnel do not have the proper attitude - then punishment may be deemed necessary for those who fail to observe the rules and regulations.

Discipline is more than simply following the Starfleet Code of Military Justice. It refers to virtually any act of an officer or crewman while in uniform. It especially refers to the supervision of personnel of all grades in the day-to-day functioning of ship's routine. Like all military posts everywhere and anywhere, discipline is a living extension of military traditions into daily life. Respect for fellow shipmates, for fellow officers, for enlisted men, and especially for the Commanding Officer are the essentials for a well-disciplined Starfleet officer. Violations of these traditions, regulations, and regulations will lead to one or more of the following actions.

Captain's Mast

When an enlisted man or commissioned officer breaks a regulation, or is negligent or unmilitary in conduct, he may be brought on report by a superior officer. This means that that person must appear before the Captain at a specified time for disciplinary actions - before the Captain's Mast. The Commanding Officer of a starship is authorized to assign certain punishments for minor offences. These punishments include:

- Withholding of privileges for up to two weeks.
- Restriction to certain specified limits for up to two weeks.
- Extra duties of two hours per day for up to two weeks.
- Reduction to next inferior grade or rank.
- Confinement to quarters for up to one week.
- Confinement to quarters when off-duty for up to two weeks.

Summary Court-Martial

For enlisted personnel whose offenses warrant more severe treatment, a Summary Court-Martial may be called. It may be composed of any officer above Lieutenant Jg. - preferably the officer heading the Department or Division of the accused. This officer is appointed to the task by the Captain. The punishments are more severe than a Captain's Mast, and must be reviewed by the Captain before being effect. These punishments include:

- Confinement to quarters for up to one month.
- Restricted to certain specified limits for up to two months.
- Reduction to an inferior grade or rank.
- Forfeiture of one-half month's pay.

An enlisted man may object to a Summary Court-Martial. The designated judging officer and the accused will see the Captain, who may decide the enlisted man is entitled to a Special or General Court-Martial.

-3-Special Court-Martial

A Captain may convene a Special Court-Martial. It is composed of three officers if the accused is an officer, or two officers and one enlisted man if the accused is an enlisted man. If the accused is an officer, one of the designated judges must be of the same rank, and one must be higher. A Special Court-Martial has the authority to try any member of Starfleet for any offense. Prosecution and defense councils will be appointed by the Captain, in concert with the ship's Legal Officer. Punishment given by a Special Court Martial can be as light as a Captain's Mast, or as severe as:

- Confinement to quarters for up to six months.
- Bad Conduct Discharge.
- Forfeiture of four month's pay.

-4-General Court-Martial

A General Court-Martial consists of the ship's Legal Officer and between five and ten other members. If the accused is an enlisted man, one-third of the designated judges must be enlisted. If the accused is an officer, all of the designated judges must be officers, one must be of the same rank, and one must be of superior rank. A General Court-Martial has the authority to try any member officers for any offense punishable under the Starfleet Code of Military Justice. General Court-Martials may also try any person - including civilians - who break the Private Shipping Regulations, or who by the laws of war is subject to trial by Military Tribunal. Severity of punishment includes:

- Dishonorable Discharge.
- Years of hard labor in a penal colony.
- Death.

-5-Field Court Martial

Under certain conditions and circumstances (such as a Landing Party or after evacuation), the Captain or ranking line officer may need to hold a Court Martial while out of the ship. Regulations require that the Court be composed of the three highest ranking personnel present, plus one man chosen by the accused.

Commanding Officer's Responsibilities

Departments & Divisions

The Table below lists the 8 Departments aboard a starship, and the Divisions within each. There will always be a minimum of one commissioned officer per Division, with two Division Heads from each Department also appointed the Department Chief and Assistant Department Chief [*,**]. Larger starships may have two or more officers within some Divisions (Surgeons, Navigators). It should be noted that the commissioned officer only heads his Department/Division for one watch each day. The remaining watches (or duty-shifts) are headed by a Chief Petty Officer or Petty Officer. As shown above, each ship is organized into 8 Departments. Each Department is under a Department Chief Officer [DCO]. Generally, Departments are divided into Divisions, each under a Division Head Officer [DHO], and each Division is further sub-divided into three watches, under a Petty or Chief Petty Officer.

-Department Responsibilities

Command: The Command Department is made up of the Executive Officer's assistants and staff. Thus, the Exec runs both the entire ship (for the Captain) and his own Department.

Operations: The Operations Department, under the Ordnance Officer, is responsible for the safe navigation of the vessel. As well, it is charged with the care and operation of the ship's auxiliary craft (Shuttles) and Weapons Systems.

Engineering: The Engineering Department, under the Warp Drive Propulsion Systems Officer (Chief Engineer), is responsible for the operation and maintenance of all systems, including Propulsion, Life-Support and Damage-Control.

Security: The Security Department, under the Combat Tactics Officer, serves as an independent Space-Marines detachment/mobile unit under the direct command of the Captain. It is responsible for internal security, as well as providing any needed tactical support in hostile territory. Starship Security personnel are chosen from the finest of the Federation Marine Corps, and rotate between Starbase

-Shipboard Organization & Administration

Departmental & Divisional Table			
Command	Operations	Medical	Sciences
Executive* Finance** Records Personnel Legal Yeoman	Ordnance* Navigation** Helm Deck [Hangar] Pilot [Shuttle]	Surgery* Xenomedicine** Psychiatry Dental Pharmacy Nursing Pathology Recreation	Computer Sci* Sensors** Anthropology Archeology Biology Botany Chemistry Astrogeology Physics Astrophysics Cartography Library
	Security Combat Tactics* Armory** Training	Engineering Warp Drive* Power** Environment Impulse Drive Damage Control Shipfitting Transporter	Ship's Services Quartermaster* Commisary** Maintenance Miscellaneous
Communications Sub/Real-space* Cryptography** Computer System Electronics Electrical	Marines 1st Platoon* 2nd Platoon** Assault Shuttles Escort Fighters		

Command Department

and starship postings. At least one Assault Shuttlecraft is carried aboard most starships, this is equipped and modified for Landing/Boarding Assault missions - a Marine specialty (see: COMPONENT SERVICES).

Sciences: The Sciences Department, under the Computer Science Officer, is charged with providing the CO and others with the maximum amount of data possible regarding the surroundings, whether this be by ship's sensors, or in a landing party. It also maintains and updates the Main Computer software programming.

Communications: The Communications Department, under the Sub/Real-Space Communications Officer, is responsible for the coordination, operation, and upkeep of the ship's external and internal communications systems. as well, it maintains the ship's electronics systems, including the Sensors and Main Computer hardware.

Special Services: Among other responsibilities, the Special Services Department, under the Quartermaster, is charged with assignment of quarters, programming of the ship's food fabricators, ordering and receiving general stores, inventory and control of cargo, plus the ship's PX. As well, it's charged with the decontamination of any contaminated compartment, and the cleanliness of the ship's internal compartments and corridors.

Medical: The Medical Department, under the Chief Surgeon & Physician, is charged with caring for the health of the ship's complement, with special emphasis upon the mental health of the CO. As part of these duties, it is responsible for all recreational facilities and activities.

Officer Responsibilities

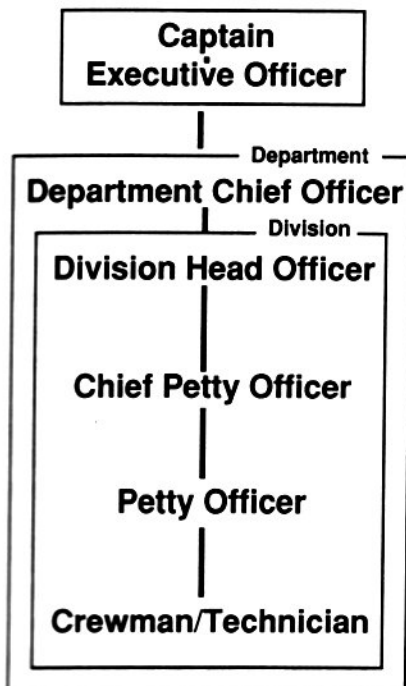

Commanding Officer: (CO, Captain) In general, the CO is responsible for the safety, well being, and efficiency of his command. Although the care and attention of details of this command is delegated to the Department and Division Heads, responsibility for these remains with the CO. During combat, the CO is required to engage the enemy and fight to the best of the ship's ability - not disengaging until the action is complete. Should evacuation be required, the CO will order and oversee it. The CO's power is authoritative and complete - and may not be delegated.

Executive Officer: (Exec, First Officer) The Exec is the aide to the CO, and as such is the second-in-command, the next ranking line officer. He is the CO's direct representative. His duties include maintaining the general efficiency of the ship and crew, coordinating with the Department and Division Heads.

Department Chief Officer: (DCO) The head of a Department is the representative of the CO in all matters regarding that Department. He is responsible for, and makes reports to the Exec regarding his charge.

Division Head Officer: (DHO) The Division is the basic unit of shipboard administration. Division Heads are responsible to their respective Department Chiefs. Especially, the DHO is charged with the training of his personnel.

-Shift Sections & Watches

Section Duty Shift Schedule			
SECTION	WEEKS 1-2	WEEKS 3-4	WEEKS 5-6
A	2400 - 0800	1600 - 2400	0800 - 1600
B	0800 - 1600	2400 - 0800	1600 - 2400
C	1600 - 2400	0800 - 1600	2400 - 0800

With the exception of the Captain and Exec, every officer and enlisted man aboard ship is assigned to a Shift Section. There are three Shift Sections, each having an equal portion of personnel from each Department and Division. Each of these Sections (Alpha, Beta, Gamma) takes a turn at each of the three watches, rotating on a six-week cycle as shown.

At any time, First Shift is that Section on-duty. Second Shift is that Section which will relieve First, and Third Shift is that Section which was relieved by First and which will eventually relieve Second. Each Shift is of eight hours duration.

The placement of personnel within a particular Shift Section is the duty of the Personnel Officer. Should a

Starfleet DYNAMICS

crewman wish to be assigned to a particular Shift Section, he should first get permission from his DHO. The six-week rotating cycle was arrived at after extensive studies and analyses of biorhythm upsets among humanoids. It applies equally well to Homo Sapiens, Homo Cygni, Homo Eridani, and Homo Indii.

Department Chiefs are not assigned to their Shift Sections. Rather, although they must serve one watch in three, they are permitted to adapt their scheduling so as to be present at their duty stations for critical events. The Chief Medical Officer and the Personnel Officer keep pay especial attention over these officers so that they do not become exhausted through biorhythm upset.

A frequent exception to the concept of one-third of a Department being on-duty during each of the three watches is the Sciences Department. As some work requires the combined efforts on behalf of all Sciences personnel, it is normal for all Sciences personnel to work during the same watch, usually 08:00 - 16:00. On the other hand, some experiments or research might require round-the-clock supervision, or be required before a certain deadline. In such cases, the Chief Science Officer will coordinate and control such revisions to the duty roster with the Personnel Officer.

-Ship's Alert Status



The following Alert Status Standing Orders refer to all personnel except the Security Department (see: CONDITION STATUS). The Alert Status controls the readiness and deployment of the ship's complement for battle or other emergency conditions. First Shift refers to the shift presently on-duty, Second Shift refers to the next shift scheduled to relieve the First, and Third Shift refers to the shift just relieved by the First.

Green Status: (Normal) First Shift on duty, Second and Third Shifts off-duty.

Yellow Alert: First Shift remains on-duty and prepares the Duty Station for battle-readiness (warming-up equipment that will be needed, storing and securing fragile items, etc.). Second Shift goes on-duty and reports to respective Duty Stations - joining First. Each station reports to Bridge when the Station is battle-ready.

Red Alert: (Battle Stations) Third Shift goes on-duty and reports to respective Duty Stations - joining First and Second. Each Station reports to Bridge when the station is fully-manned. (See: DAMAGE CONTROL) Those personnel denoted as Damage Control Auxiliaries will assume their proper stations.

Abandon Ship: All personnel drop whatever they are doing and move as ordered for evacuation. Exceptions include only the First Section Security personnel, on-duty Bridge-crew, on-duty Medical personnel, and designated auxiliary craft Command Pilots.

-Logs

The Duty Officer for each watch in each Division has the responsibility for maintaining that watch's Log entries. He must log-in at the beginning of his watch, and log-out at the end. Also, throughout the watch he must update the Log with any information or incidents which directly affect his Division or responsibilities. The Log is a permanent record of any actions, discoveries, decisions, and communications which the personnel within that watch have encountered or executed.

Never be concerned about recording too much information. In the event of a disaster, or subsequent Court-Martial proceedings, a complete and accurate Log recording your Division's watch may be the only method a third party has of accurately recounting past events. Never try to exclude or edit an entry, nor to paraphrase or color it in someone's favor. Any datum, no matter how trivial, could be essential later. If a junior officer's activities or behavior seem out-of-accordance with procedure - record the incident in a concise and accurate fashion. List his actions and responses. If you receive orders from a superior officer, log them. If you are inspecting a piece of equipment and notice a fault, log it and flag the entry for follow-up by the Engineering Department's Shipfitting Division.

Log entries may be recorded from any location using a mobile portable transceiver (communicator, electronic clipboard), or at any station (console, intercom). All entries are automatically shunted by the Main Computer directly into the FLIDAR (see: FLIGHT DATA RECORDER). Persons making log entries should follow proper procedure: Log, Station Designation/Location, Stardate, Name. The FLIDAR will automatically route your entry to the tail-end of your Division's last entry.

Command Department

"Environmental Log: Stardate 9005.13: Engineer Jaffee recording. Coming on duty at 08:00. No standing orders on the board. All systems nominal."

"Environmental Log: Stardate 9005.13: Engineer Jaffee recording. Supplemental. I am reducing the synthetic gravity in the lounge by 50% as per Captain's order. Logging order at 13:00."

"Environmental Log: Stardate 9005.13: Engineer Jaffee recording. Supplemental. Increasing lounge synthetic gravity back to 100% per Captain's order. Logging order at 15:00."

"Environmental Log: Stardate 9005.13: Engineer Jaffee recording. Coming off-duty at 16:00. No standing orders on the board. All systems nominal."

Starfleet ID

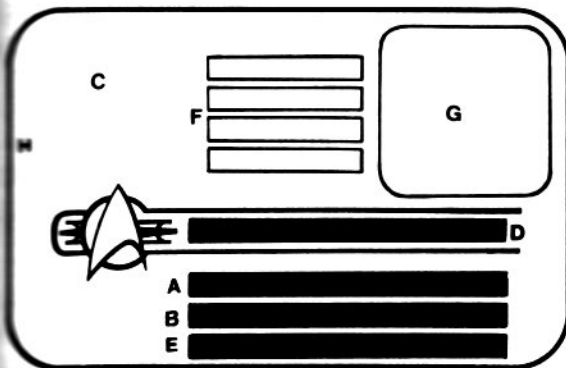

Particulars:

Height 55 millimeters
 Width 85 millimeters
 Depth 2 millimeters
 Colors Clear with Black and Red Markings

- A) Name
- B) Serial Number
- C) Department/Division Symbols
- D) Current Assignment (ship/base)
- E) Rank
- F) Restricted Area Pass List
- G) Holograph
- H) Status Border

The Starfleet ID Card is used as an ID check, a Security Pass, and a Dossier. While within a Starfleet installation or

vessel, whether in uniform or mufti the ID must be carried at all times. It may not be handed to anyone except for purposes of establishing identity verification.

The ID is composed of three transparent layers of plastic, the outer two for protection, and the inner being a semi-conducting liquid crystal processor/display. There are four memory banks within the ID: Basic, Service Record, Medical Record, and Secure. The Basic bank drives the ID's visual display. The others are accessed by a standardized computer interface, into which the ID is inserted. Access codes are required to obtain any information held on the card, and these are known only by the Chief of the respective Departments (the Chief Medical Officer has the Medical Code, the Exec has the Service Code, and the CO has the Security Code). The Secure Bank also drives part of the display, Status and Restricted Area Pass List. The Status display indicates whether the ID-holder is an Active or Inactive member of Starfleet (Clear or Red edge respectively). The Restricted Area Pass List shows a listing of sensitive areas of the ship/base to which the individual is allowed access (Pho-Torp Bay, Emergency Bridge). Also in this display are any temporary passes (Boarding, Shore-leave).

Should the Captain wish to locate an officer or crewman, he need only order the Main Computer to put out a locator signal through the ship's intercom network. This low-power radio signal (coded to match the ID-holder's serial number) will trigger the ID to make a brief low-power reply, pinpointing its location.

-Command Packet

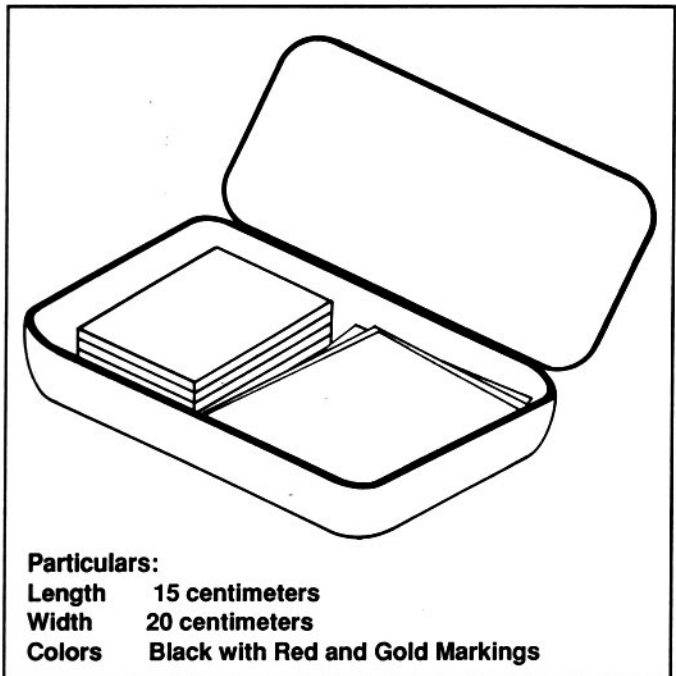

Particulars:

Length 15 centimeters
 Width 20 centimeters
 Colors Black with Red and Gold Markings

Starfleet DYNAMICS

The Command Packet is a locked plastic case containing the Captain's and ship's most-secret orders and directives. As such it is classified Top Secret and carries a corresponding GRADE 3 emblem on both its upper and lower sides. As with any sensitive material, if you find this Packet somewhere in the ship or in the possession of a fellow shipmate, report this at once to the Chief of Security. The only person with legal access is the Captain (see: CLASSIFIED INFORMATION & MATERIALS).

The Command Packet is given to a Captain when he first takes command of his vessel. Its contents are updated and refilled at every Starbase he calls at. It is always kept in his personal safe, and by orders of the Starfleet Commander may not be removed from his quarters. The Captain's safe has three combinations. Each is known to only one person: the Captain, the Exec, and the Chief Engineer. A built-in recorder logs each opening, along with combination used and Stardate reference. Only the Captain is allowed to open the Packet, although he may show the contents to selected officers at his discretion if they possess need-to-know. Upon the Captain's demise, the Packet is inherited by the Exec, who will immediately familiarize himself with its contents and act accordingly. With one exception (the Captain's Final Orders) the contents are written, not taped. This is a security measure based on the reasoning that what never goes through an electronic system cannot be bugged or overheard. The contents are as follows:

Voyage Schedules: Destinations/Rendezvous and expected arrival times. Some arrival times are approximations, others are definite and must be met.

Mission Profiles: Individual instructions for each destination.

Destruct Sequence: Specific 3 Destruct Codes and Confirmation. Intruder Control Override: Blueprint showing location of niche.

Sealed Orders: Regarding specific tasks which a ship must accomplish, and which the Captain may not disclose to any other officer. This protects the Federation and Starfleet from responsibility should the starship be caught in a covert action, by giving them deniability.

Final Orders: A final message from the late Captain to his successor. It is not in the form of specifics, rather it is a series of personal reflections and recommendations regarding hypothetical problems he may face.

-Destruct Sequence Directives

In order to initiate a Destruct Sequence, three command-grade officers must first identify themselves to the Main Computer by name, rank, and position, and then give a Destruct Code. The computer verifies each in turn by

retina-scan and voice-print. It then asks the senior officer for final confirmation. All senior officers aboard ship know all three of the destruct codes for that ship, but only the Captain and First Officer know the Destruct Confirmation. Upon a Destruct Confirmation, a sixty second count-down begins. Until the last ten seconds, the Destruct Order can be countermanded by any of the three officers by giving the Destruct Cancellation Order. At zero seconds, one of the two Destruct Scenarios will take place. The Destruct Codes, Destruct Confirmation, and Destruct Cancellation Order are different for each starship. It takes three of these officers to give the Sequence, non-authorized voices will not be accepted. There are two different modes of self-destruct for every Starship: Directives 2001 and 2005.

The Destruct Sequence given as an example below was the Destruct Sequence for the U.S.S. Enterprise, which was destroyed using it:

First:	Destruct Sequence 1 - Code 1/1-A
Second:	Destruct Sequence 2 - Code 1/1-A/2-B
Third:	Destruct Sequence 3 - Code 1-B/2-B/3
Computer:	Destruct Sequence Completed and Engaged; awaiting Final Code for sixty-second count-down
Confirm:	Code 0, 0, 0, Destruct, 0
Computer:	Sixty seconds, Fifty-nine...
Cancel:	Code 1-2-3, Continuity. Abort Destruct

Starfleet Directive 2001:

- All phaser banks overload and explode - instantaneously killing crew.
- Preplaced explosive charges destroy all computer systems.
- All onboard emergency batteries overload and explode.
- Preplaced explosive charges destroy airlock doors, simultaneously all internal doors lock open, evacuating ship's air into space.
- All Antimatter Containment Bottles are ejected into deep space using built-in thrusters.

Starfleet Directive 2005:

The Chief Engineer instructs the Main Engineering Computer to remove safety interlocks on the Antimatter Containment Bottles. Thus, when the computer counts down to zero, the internal force-fields of the Antimatter Containment Bottles will be cancelled-out. This will result in an explosion which will negate any vessel within a 1000 kilometer radius of the ship.

Command Department

First Contact Procedures & The Prime Directive

"When contacting a planet making normal progress toward a free and united society, a Starfleet officer shall make no identification of self or mission; No interference with the social development of said planet; No references to space, or the fact that there are other worlds or more advanced civilizations."

The Prime Directive of Non-Interference,
Article 2278

First Contact Procedures

The Federation and Starfleet Command have cooperatively designed strict mandates regarding contact with newly discovered races. Foremost of these is that no planet's inhabitants shall be allowed to know the true nature or identity of Starfleet personnel unless said planet is deemed ready for such a revelation. There are therefore two entirely different procedures: Survey and Contact.

Survey: As a corollary of orbital scanning, it is often desirable for a survey team to examine a culture close-up. Sometimes this merely entails covert surveillance of a village from a hilltop via tricorder and visual observation. Alternatively it may require mingling with the populace (assuming everyone on the vessel can be passed as a native). For surveys, the ship's Quartermaster will synthesize and provide native clothing for the landing party, so that they may mix with the population without appearing as visitors. More importantly than costuming, cultural camouflage entails observing and imitating the customs of the native planet. This includes both the obvious language and laws, as well as the unspoken unconscious mannerisms and taboos. Most importantly, natives of a primitive culture must not - under any circumstances - be allowed to observe modern technology in action. For examples, imagine the super-advanced implications of hand-cast lightning bolts, talking animals, clairvoyance, or teleportation to a primitive not acquainted with transtator technology. To a sophisticated, advanced, communicators, tricorders, and transporters are technology - to a primitive they are magic. Next, remember historic Terran examples of one man radically deflecting the course of world society due to divine revelation: Christ, Buddha, Mohammed. Such men - out of sincerest intentions - caused a wide variety of cultural changes (philosophical and political) which turned Terra upside-down. A native observing the wrong phenomena might do the same out of sincere (but mistaken) belief that he had been vouchsafed a revelation from new gods.

Contact: While the goal of a Survey Team is information, that of a First Contact Team is the establishment of permanent diplomatic relations. Unlike the Survey Team - which is mostly made-up of scientists and technicians, the First Contact Team usually includes the Captain, advisers (one or more officers), and a Security escort. Their task is six-fold:

- Contact the center of government from orbit and arrange for beam-down coordinates and an official reception.
- Dispel any extant fears of invasion.
- Explain the Federation.
- Explain the new world's options.
- Offer application for Federation membership. Arrange for the conveyance of ambassadors to the Federation Council aboard the nearest Diplomatic Cruiser.

-Command Decision

It is the responsibility of the Captain to examine both the Social and Technological development of a planet, and then decide whether the planet ready for Contact, or whether the Prime Directive applies and the planet must be isolated (see: NEUTRAL ZONES). This is not merely a matter of analysing the progress of a world and seeing if it meets some minimum standard. There are scales for the measuring of both Social and Technological development (see: SOCIAL & INDUSTRIAL RATING), but calculating how they both affect their culture - singly and cooperatively - is no easy task. For example, Contact may be made with any culture above F on the Social Scale and above 8 on the Industrial Scale. However, some worlds below one of these levels may be contacted if they exceed the other parameter - or they may not. Halka was contacted because it possessed a Social Rating of G+, even though it has an Industrial Rating of 3, since the Social Rating proved that the inhabitants were well prepared to join an interstellar civilization and could cope with the technology suddenly available without danger of destroying themselves or their culture.

Contrawise, Planet 892-IV was isolated despite its Industrial Rating of 7+ because of its low C Social Rating. The danger that such a society would pose to itself and other worlds if it were to acquire modern technology was all too apparent. On the other hand, any world above an Industrial Rating of 9 must be contacted regardless how low its Social Rating. Reasoning: Since that Rating indicates that the race is beginning interstellar travel, it is the duty of Starfleet to advise them of Interstellar Law - both for their own protection and that of nearby star systems, which may be Federation members, friendly neutrals, non-aligned hostiles, or systems protected by the Prime Directive.

An exception to the Prime Directive may be made if a

Starfleet DYNAMICS

planet is not making normal progress toward a free and united society. Such cases as are documented have been caused by:

- Invasion by another race
- Natural catastrophe
- Artificial catastrophe

(For further information on such anomalies, their causes, and symptoms see: SOCIAL & INDUSTRIAL RATING).

-Landing Party

In the course of a vessel's mission, it will be necessary for personnel to transport or shuttle down to a planetary surface. Depending upon the reason for such a mission, the Captain will select the appropriate personnel to complete this task. These officers and crewmen are known as a Landing Party. They can be divided into the following types:

Survey: Newly discovered planets must be classified for Federation records. Although the ship's Science Sensors can analyse and record most aspects of a planet, the information gathered by a Landing Party is invaluable. Firstly; the data recorded by the Landing Party tricorders gives finer, more intensive readings, especially with respect to life-forms. Secondly; the recommendations of the Landing Party's leader can provide almost as important an influence, as his on-the-spot impressions of the planet and its natives can significantly affect the Federation's policy toward that planet. As always, the Landing Party is responsible under the Prime Directive to avoid unnecessary contact with indigenous intelligent life-forms, and failing this (such as when the natives locate the Landing Party) to avoid displaying superior technology. Personnel chosen vary according to specific requirements, usually being comprised of a line officer, three Sciences officers or technicians of various Divisions, and two Security specialists.

Search: Should persons be missing (be they a previous Landing Party, pre-existing research personnel, etc.), the Captain may order a Search Party down to the planet. This will be comprised of a line officer and Security personnel. Their mission will be to locate and retrieve missing personnel, with this goal being understood to be secondary to the Prime Directive.

Medical: If persons on a planet are in distress caused by illness or injury, the Captain - aided by the recommendations of his Chief Medical Officer - will send a Medical Party. This will be comprised of personnel from the Medical Department chosen according to the skills required (Surgeons, Xenomedicos) and escorted by a two-man Security detail. Of any ship's complement of shuttlecraft, one is always designated as the Medical Shuttle, and as such carries a compact Sickbay.

Security: If a military objective must be achieved on a

planet or vessel by tactical means, such as a strike or recon-probe, the Captain and Chief Security Officer will select and send a Security Force. This will be comprised of six to twelve men (1-2 squads), one of whom will be an officer. Prior to the mission, the entire Force will be briefed on their objectives, scenarios, and all data gathered regarding their assignment environment. If the Prime Directive is in effect, suitable precautions must be taken to avoid cultural contamination.

Diplomatic: The Captain must sometimes call on dignitaries of planets which are friendly or members of the Federation. These are courtesy missions, and personnel are chosen according to diplomatic need. Usually a Diplomatic Party consists of the Captain, his Exec, and a Yeoman. Dress Uniforms are worn, and any/all weapons or equipment must be worn unobtrusively. Personnel chosen for such a mission must behave in a manner suitable to their status as Federation ambassadors.

-Outfitting

Just as every planet, mission, and objective is unique, so the equipment chosen for a particular Landing Party differs with the circumstances to adapt to that particular mission. However; Field Equipment Guide-lines have been drawn-up to assist in this task. The following describes Type of Mission, Personal Equipment (that carried by each member of the Landing Party), and Team Equipment (that carried by one or two persons of the Landing Party for the group as a whole). All Field Equipment is stored in the Equipment Locker of every Transporter Room and Shuttlecraft. It is the duty of the Transporter Operator or Deck Officer to equip a Landing Party with the suitable equipment, as ordered by the Captain.

Landing Party Outfitting Guidelines

CODE	MISSION TYPE	PERSONAL EQUIPMENT	TEAM EQUIPMENT
1	Survey Search	Phaser 2 Communicator Survival Jacket	Tricorder Medikit
2	Medical	Communicator Medikit Survival Jacket	Phaser 2 Tricorder M.E.C.
3	Security	Phaser 2 Communicator Assault Suit	Phaser Rifle Tricorder
4	Diplomatic	Phaser 1C Communicator Dress Jacket	Tricorder

Command Department

Leave, Shoreleave, & Liberty

Leave is the time you are authorized to spend away from your ship. Leave is the military version of a vacation. Typically, a crewman earns 50 days of leave in each standard year of active duty (24 leave hours per 6 duty days of 8 hours each), and these earned days are recorded in the Personnel Officer in his Leave Account. Experience shows that vacations and short periods of rest from duty provide benefits to morale and motivation which are essential to maintaining maximum effectiveness. Personnel are encouraged to use their entire 50 days of leave per year and not letting an unused lump sum build-up for later use, as this defeats Starfleet's intent to provide for the health and welfare of its personnel. There are several types of leave:

Shoreleave: Leave time is usually utilized during Shoreleave. From time to time, a ship will lay-over at a friendly port-of-call for an extended period of time, such as for repairs, refitting, supplies, and fueling. During such layovers, the ship will be placed on Inactive Status - requiring only a skeleton crew on the Bridge and in Engineering in order to maintain orbit and essential functions. The Captain and crew normally make use of such opportunities by allowing shoreleave. In such cases, personnel will be allowed to

transport down to the surface - either all but the skeleton crew, or half of the crew at a time. Duration of a Shoreleave also varies, and seldom exceeds 5 days. Regardless of intended length, all personnel on leave are subject to recall at a moment's notice. They are therefore required to keep their communicators with them at all times, so that they can be contacted and transported back to the ship. Shoreleave is charged to a crewman's Leave Account.

Liberty: If a crewman so elects, he may utilize a portion of his accrued leave (up to 50% of time on account) as time-off while still aboard ship. This may enable him to gain some well-needed rest while the ship is still far from its next port-of-call. In case of Alert, all liberties are canceled.

Medical: Medical Leave is a period of authorized absence from the ship or duty as part of care and treatment prescribed for recuperation and convalescence by the Medical Officer. Medical Leave is not charged to the individual's Leave Account.

Advance: Advance Leave is leave granted before it is earned. It is based on the knowledge that a crewman will earn the leave at a later time. It is charged to his Leave Account.

Emergency: Emergency Leave is leave granted for a personal or family emergency requiring a crewman's presence. It is charged to his Leave Account.

Uniforms

Uniform-of-the-Day

The uniform-of-the-day will be announced to enlisted men by their petty officer prior to the commencement of each duty shift. Officers are expected to choose their own uniform using their knowledge of the watch's expected activities and their Captain's wishes. This may entail Class A's (if for example an Admiralty inspection is scheduled), Class B's (for a regular duty shift which may require some physical work), or Class C's (depending upon any special hazards which may be expected).

Class A: (Dress) Suitable for ceremonial functions and/or regular duties where prudent or ordered.

Class B: (Duty) Suitable for regular duties and/or recreation and other off-duty activities.

Class C: (Special) Worn when necessary in order to protect the wearer against special on-the-job hazards or for other requirements.

Class D: (Supplement) Worn with the uniform-of-the-day solely at the discretion of the wearer.

-Basic Components

Tunic: Lacks ornamentation or insignia of any kind. It features ribbed semi-padded collar and cuffs. Color for both officers and enlisted men matches the Departmental Stripe. Cadets and midshipmen wear red tunics.

Pants: Black, with the bottoms bloused-over the boots. A two-centimeter-wide Seam Stripe runs along the sides from waistband to bottoms. This stripe matches the Departmental Stripe in color. The exception are line officers, who feature a four-centimeter-wide red stripe with gold piping running down the center.

Boots: Patent neo-leather, and can be computer-tailored to fit any humanoid foot in comfort. They are suitable for any conditions from Dress Ceremonials to Survey Landing Parties. The boots are proof against most corrosives, high temperatures, and sharp objects. The hexagonal grid pattern of the sole is designed to provide secure traction even on icy terrain.

-Grooming

Appearance and conduct should always reflect credit upon the officer, Starfleet, and the Federation. The uniform should be clean and worn correctly. No articles such as pens or jewelry may be worn exposed on the uniform.

Starfleet DYNAMICS

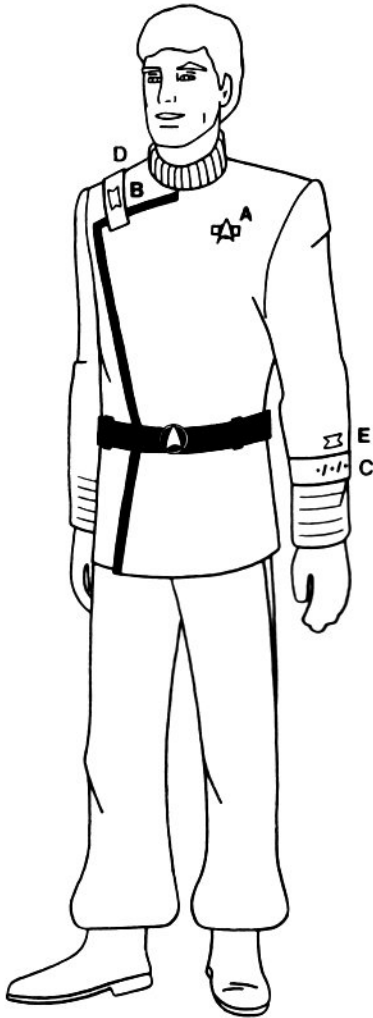

-Class A - Dress Jacket

Worn by officers and chief petty officers for ceremonial and/or regular duties (at their discretion).

- A) Starfleet Insignia
- B) Shoulder Departmental Stripe and Clasp
- C) Sleeve Departmental Stripe
- D) Line/Staff Pin
- E) Rank Insignia

Colors Blood with Black Piping

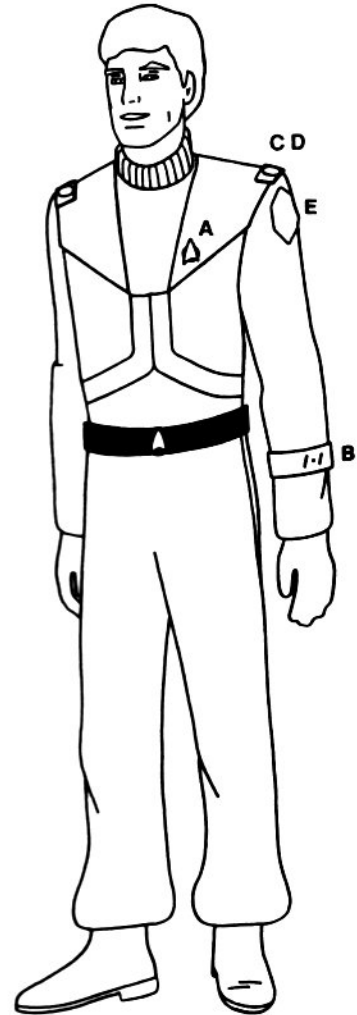

-Class A - Dress Jumper

Worn by enlisted men, cadets, midshipmen, and petty officers for ceremonial and/or regular duties (as ordered).

- A) Starfleet Insignia
- B) Departmental Stripe
- C) Shoulder Departmental Tabs
- D) Divisional Emblems
- E) Shoulder Divisional Patch

Colors Blood Jumper with Charcoal Torso and Sleeves

Command Department

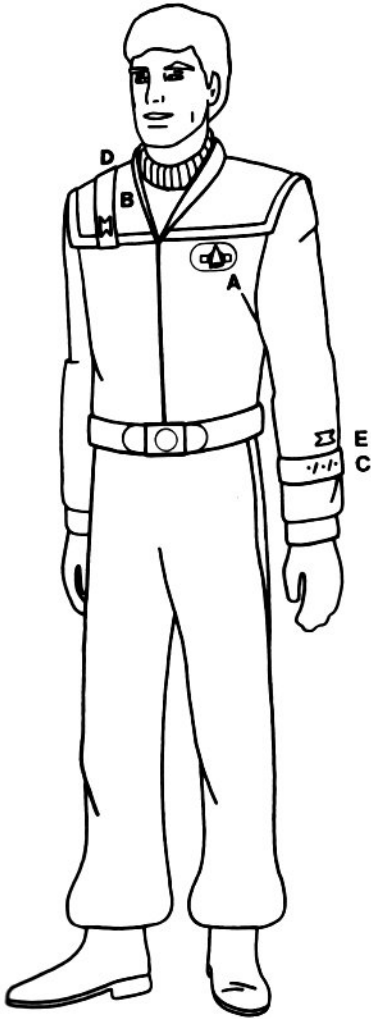

Class B - Duty Jacket

Worn by officers and chief petty officers for regular duties.

- A) Starfleet Insignia
- B) Shoulder Departmental Stripe
- C) Sleeve Departmental Stripe
- D) Line Staff Pin
- E) Rank Insignia

Colors Blood Jacket with Black Piping

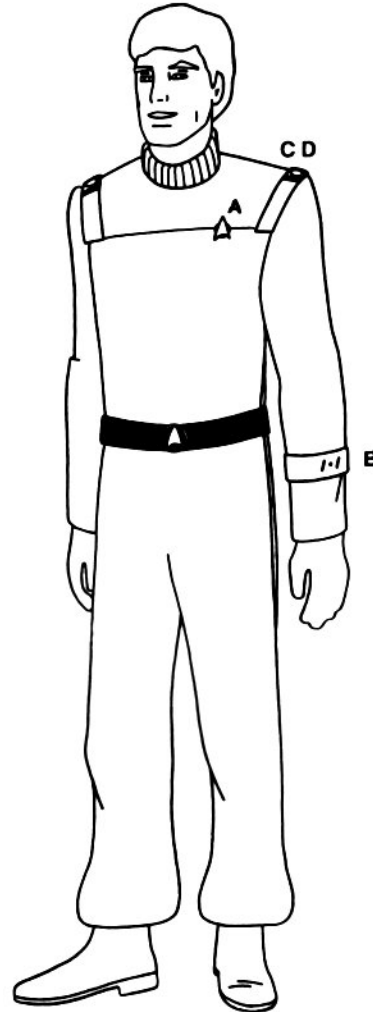

-Class B - Duty Jumper

Worn by enlisted men, cadets, midshipmen, and petty officers for regular duties.

- A) Starfleet Insignia
- B) Sleeve Departmental Stripe
- C) Shoulder Departmental Tabs
- D) Divisional Emblems

Colors Blood Jumper with Ivory Yoke

Starfleet DYNAMICS

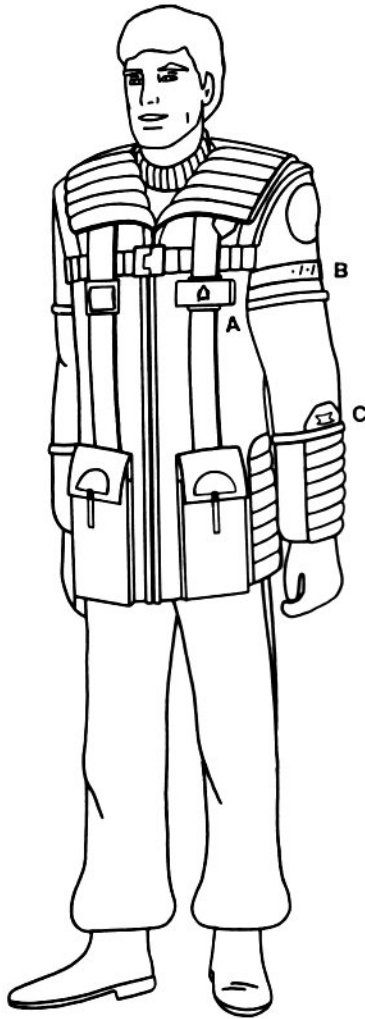

-Class C - Survival Jacket

Worn by any personnel participating in a Landing Party to a Class M world with sub-temperate weather. Power to the internal heaters is supplied by the powerpack.

- A) Starfleet Insignia/Powerpack
- B) Sleeve Departmental Stripe
- C) Rank Insignia

Colors Blood Jacket with Ivory Trim

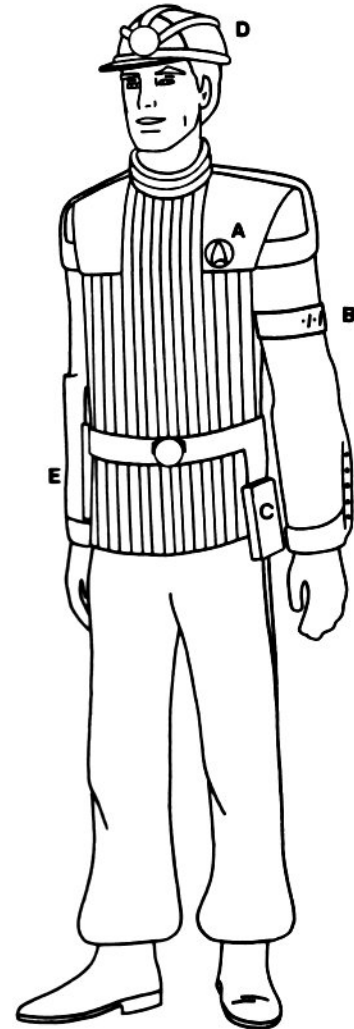

-Class C - Marine Assault Fatigues

Worn by Marines, Security personnel, and sometimes other Department personnel while engaged in a planetary assault mission. The jacket and pants are rated as medium-efficient impact armor. The boots are especially designed to afford excellent footing in all terrains - while leaving a minimum spoor trace. The hand-held deflector shield is proof against medium-intensity phaser blasts, and can be rolled-up and carried on the back, as can a rucksack. Identical for officers and enlisted men. The jacket can be worn tucked into the pants.

- A) Starfleet Insignia
- B) Sleeve Departmental Stripe
- C) Hand-binders Pouch
- D) Reinforced Cap
- E) Phaser Holster

Colors Grey Suit with Black Piping and a White Belt

Command Department

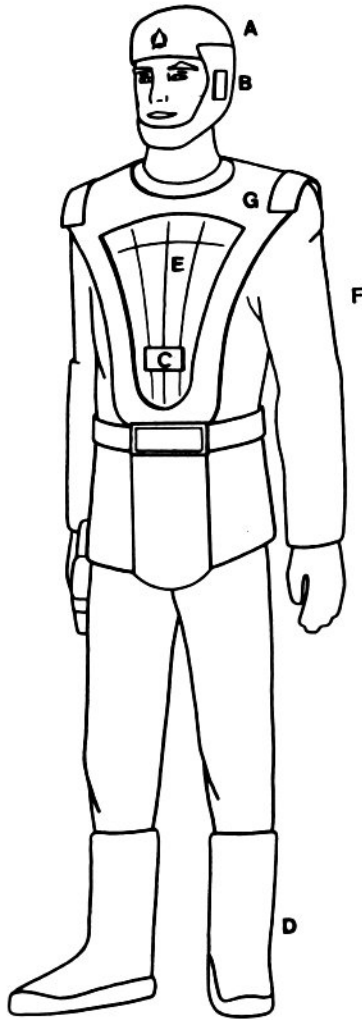

Class C - Security Armor

Worn by the Armor Squad aboard starships and Starbases. The personal scanning device (Perscan) allows the Medical Officer or Security Officer to monitor the vital signs of the men remotely. The Chest and Back Shields are a force-field enhanced radiation shield, proof against low-yield phaser bursts. The supporting Yoke is rated as medium-efficient impact armor, as is the Undersuit.

- A) Helmet
- B) Headphones
- C) Perscan
- D) Variable-Adhesion Boots

- E) Chest Shield
- F) Back Shield
- G) Torso Yoke

Colors Maroon Undersuit with A White Shield and Brown Mounting-yoke

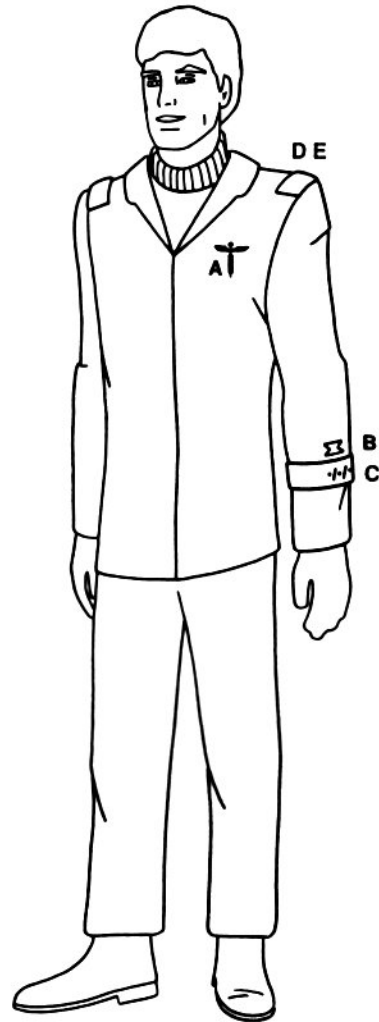

Class C - Surgical Whites

Worn by all surgical and nursing personnel over their regulation tunic, or over the mufti of civilians. Identical for officers, enlisted men, and civilians.

- A) Caduceus
- B) Rank Insignia
- C) Sleeve Departmental Stripe
- D) Shoulder Departmental Tabs
- E) Divisional Emblems

Colors White Jacket and Pants with Green Caduceus

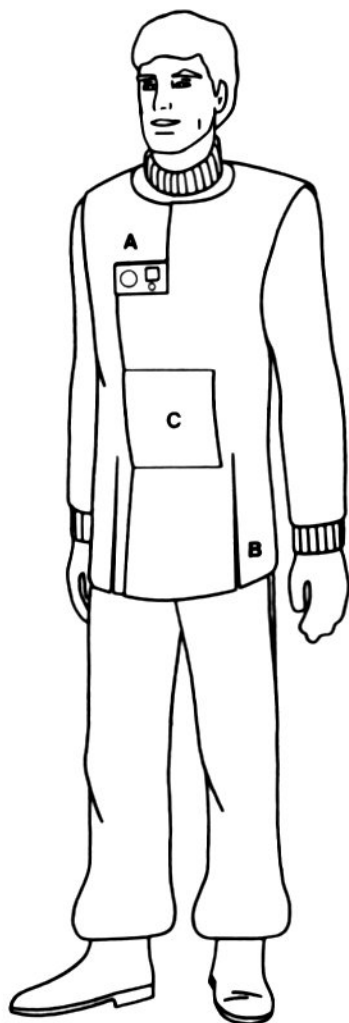

-Class C - Laboratory Smock

Worn by all laboratory personnel - regardless of which lab - while on duty. It is worn over the tunic and pants of officers, the jumper of enlisted men, and the mufti of civilians. It is proof against most radiations, corrosives, and heat/flame. Note the placement of the Contameter.

- A) Contameter
- B) Slits (4)
- C) Pocket (optional)

Colors White

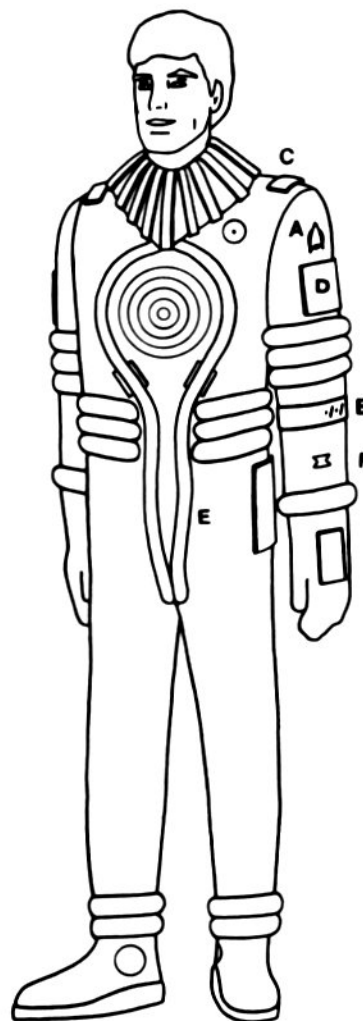

-Class C - Radiation Suit

Worn by the Propulsion, Power, and Damage Control Divisions within the Engineering Department. Mandatory within the Engineering compartments while the Main Reactor is at full-power. An optional helmet can be fitted for vacuum. For minor pressure drops, contaminant leaks, or radiation problems, a respirator (inset) can be donned, and will draw air from the suit's reservoir. Identical for officers and enlisted men.

- A) Starfleet Insignia Patch
- B) Sleeve Departmental Stripe
- C) Shoulder Departmental Tabs
- D) Control Panels/Powerpacks
- E) Force-field guides
- F) Rank Insignia

Colors White for Propulsion and Power Divisions,
 Orange for Damage Control

Command Department

Insignia

-Departmental Stripe

The Departmental Stripe (along with the tunic worn under a uniform) is colored in accordance with an officer's or enlisted man's Department. Except in the case of cadets and midshipmen, all stripes are bordered with gold piping. Officers, cadets, midshipmen, and chief petty officers usually have a stripe at the right shoulder (clasp on front, Federation symbol on back) and the left sleeve (eight centimeters from the cuff). Enlisted men and petty officers usually have the Sleeve Stripe, as well as rectangular tabs at each shoulder. The Sleeve stripe of a cadet will be red, but will contain a diagonal bar of color denoting the Department they are studying.

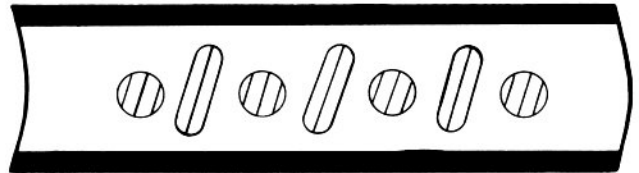

Departmental Colors:

Admiralty	- White
Command	- White
Engineering	- Gold
Operations	- Gold
Communications	- Grey
Sciences	- Grey
Ship's Services	- Black
Security	- Black
Cadet/Trainee	- Red (with color bar)

-Service Awards - Sleeve Insignia

There are two types of insignia worn upon the Sleeve Departmental Stripe: Pips and Bars.

Pip: Service Pips indicate the length of service within Starfleet - one Pip per single year of service. Gold Pips denote years served as an officer, Silver Pips denote years served as an enlisted man.



Bar: Service Bars denote completed five-year terms of service within Starfleet, and replace the preceding four Pips.

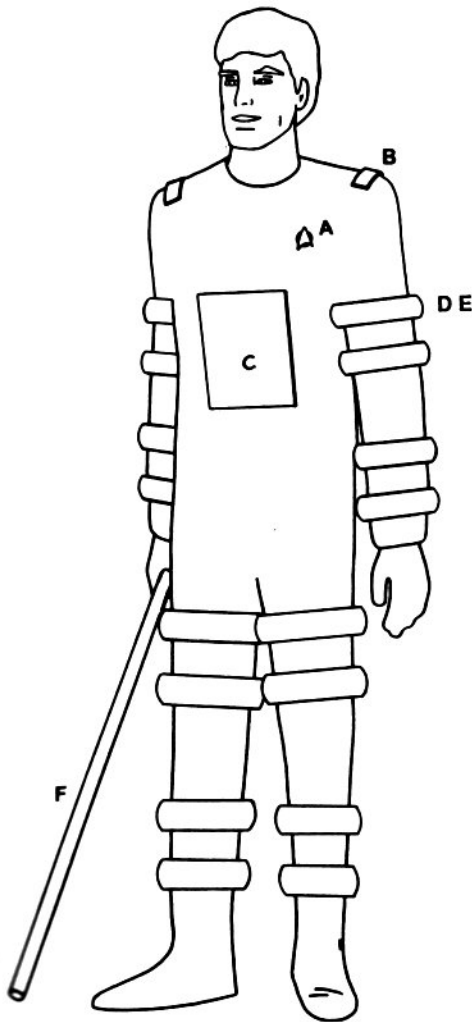

-Class C - Decontam/Maintenance Suit

Worn by Maintenance enlisted personnel. The telescoping Wand utilizes a microwave sterile-field to clean surfaces, while electrostatic and tractor fields remove debris (solid, liquid, gas, subatomic particle).

- A) Starfleet Insignia Patch
- B) Shoulder Departmental Tabs
- C) Control Panel
- D) Powerpack/Debris Holder
- E) Force-field guides
- F) Wand

Colors

Gray Suit with White Units

Starfleet DYNAMICS

Officer's Rank Insignia

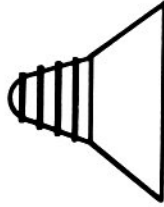

Lieutenant Junior Grade

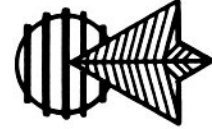

Commodore

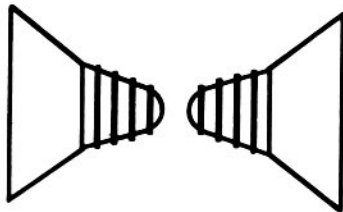

Lieutenant

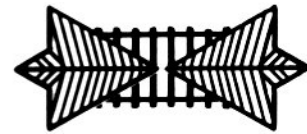

Rear Admiral

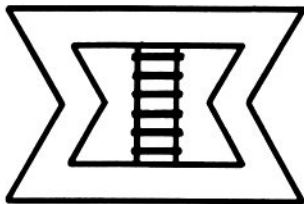

Lieutenant Commander



Vice Admiral

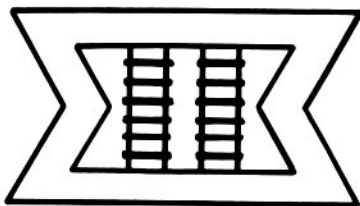

Commander



Admiral

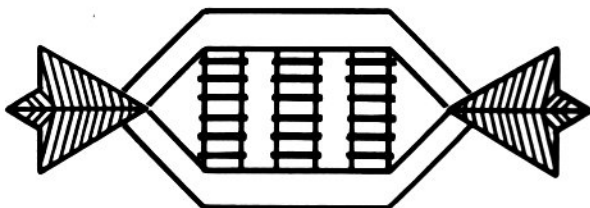

Captain



Fleet Admiral

Command Department

Fleet Insignia

Officer's Insignia:

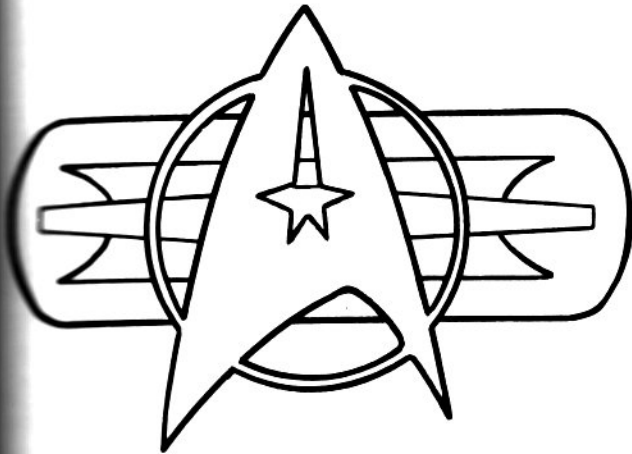

Worn on all uniforms except Class C. Presence of silver-inlaid gold plaque behind the gold shield denotes an officer - whether commissioned or petty.

Enlisted Insignia:

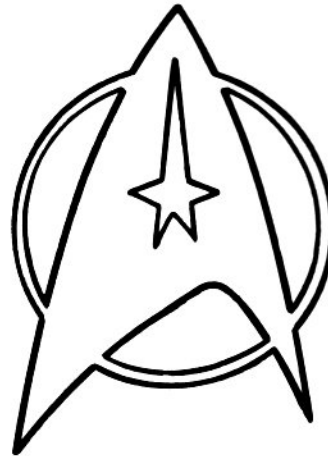

Worn on all uniforms except Class C. Comprised of a gold shield without a plaque - worn by crewmen, cadets, and midshipmen.

Line Staff Pin:

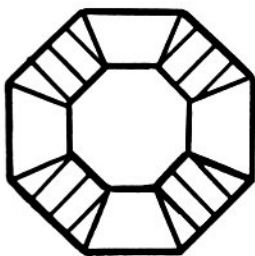

Worn on the rear of the Shoulder Departmental Stripe on Class A and B uniforms, and on the right sleeve of Class C uniforms. Silver and gold denotes a staff officer, gold denotes a line officer.

Belt Buckle:

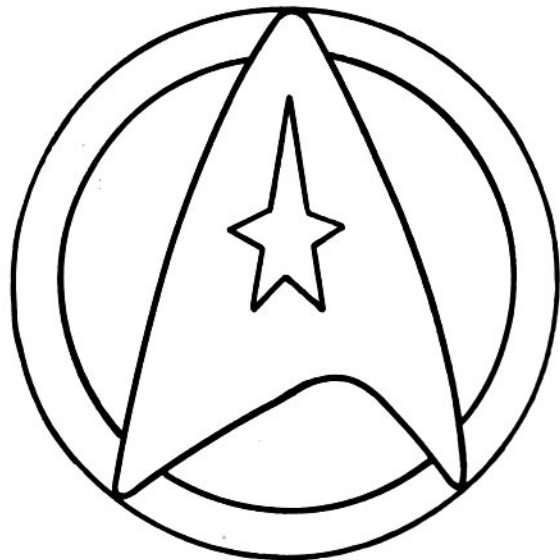

Worn on all Class A uniforms - whether officer or enlisted. Comprised of a gold shield and ring, worn on a 5 centimeter-wide neo-leather belt.

Starfleet DYNAMICS

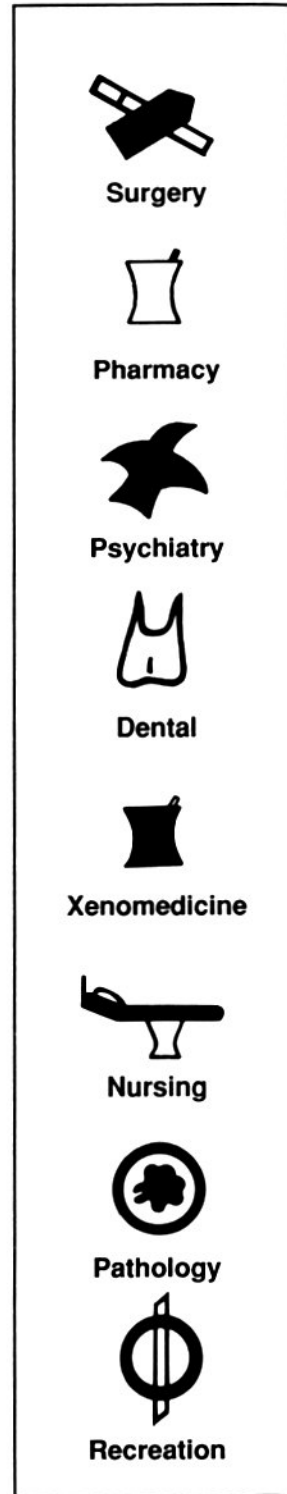
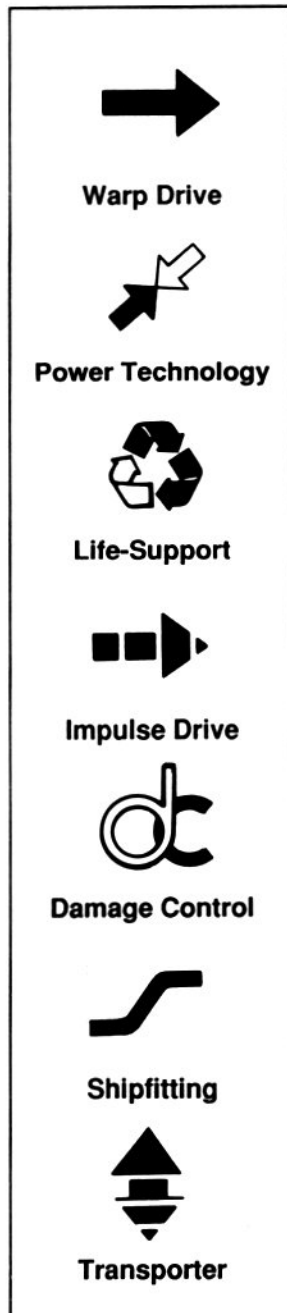
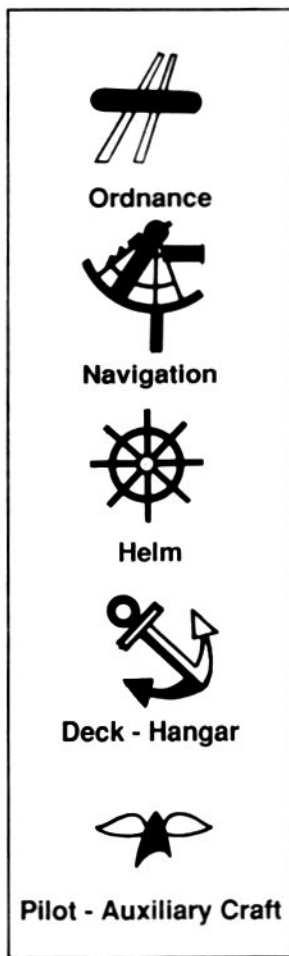
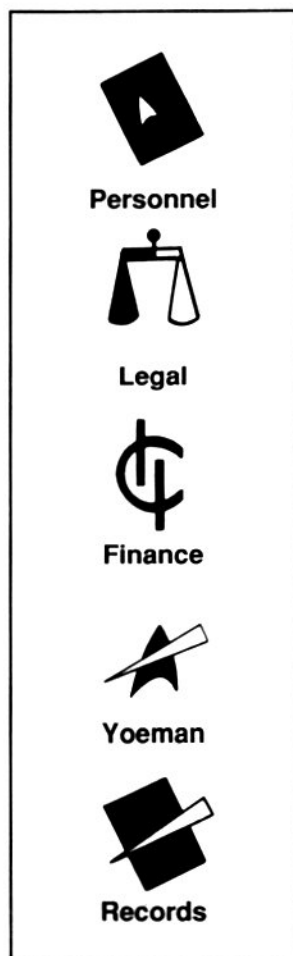
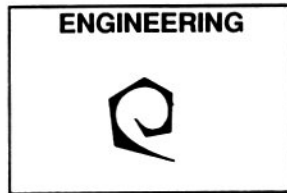

-Departmental & Divisional Emblems

Each Department and Division aboard ship possesses its own unique emblem, an easily distinguished graphic intended to aid in identifying its compartments, personnel, and equipment. When worn upon a uniform or displayed on a document, the emblems are shown without the surrounding shield or circle. When displayed on doorways or equipment, the emblems are always framed - the Departmental Emblem within a shield, the Divisional Emblem within a circle. This chart shows the the eight Departmental Emblems, each with its share of the forty-six Divisional Emblems. When the Divisional Emblems are worn on enlisted uniforms (upon the Departmental Tabs), the emblem is imposed upon a white field within the circle.

Command Department

SCIENCES



SHIP'S SERVICES



COMMUNICATIONS



SECURITY



Computer Science



Sensors



Archeology/
Anthropology



Biology



Botany



Chemistry



Astrogeology



Physics



Quartermaster



Commissary



Maintenance



Miscellaneous



Real/Subspace



Cryptography



Computer



Electronics



Electrical/Optical



Combat Tactics



Armory



Training



Astrophysics



Cartography



Library Science

The color of the circle and emblem will indicate the Rate of the crewman:

- Red = 3rd Class
- Silver = 2nd Class
- Gold = 1st Class



Departmental Emblem
within Shield

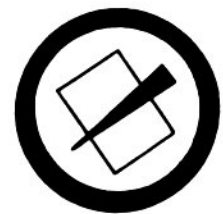

Divisional Emblem
within Circle

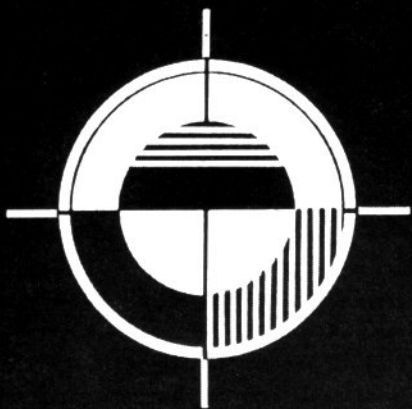

Operations Department

Bridge

Starship Bridge

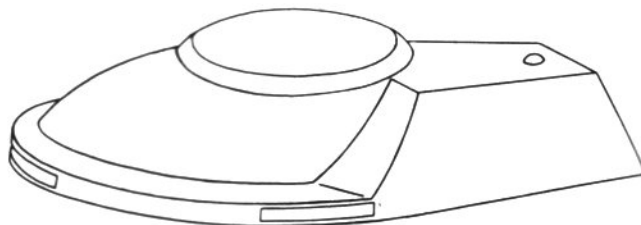

The Bridge is the nerve center of every vessel, the compartment from which all vital functions are monitored and controlled or directed. Located atop of the superstructure (just below the upper navigational sensor dome), it serves as a nexus of information through which the Captain or on-watch CO may possess total control of his vessel from this one centralized location.

As the primary control area, the Bridge is the normal duty station of the CO. As well, there are ten other duty stations, some of which are manned around-the-clock, and some of which are manned only occasionally and when necessary. All serve as the some-time duty station of their particular Department or Division Heads - and in fact these officers usually schedule their on-duty Bridge Activity Shift to match the Captain's - especially during such crisis periods as alien contacts, survey highlights, and possible enemy engagements. This provides the Captain with the most experienced personnel at-hand and on-duty when he selects to be on the Bridge. A duplicate of the Bridge (the Auxiliary or Emergency Bridge) is located mid-ship on G-Deck aboard all Class 1-B starships. It is normally manned only by a skeleton crew (Conn, Helm, and Navigation), but of course is fully manned and readied during Battle Stations.

Operations Department

The center of the Bridge is on a raised flat. It is comprised of the Conn and Command Console - which has both Helm and Navigation stations. The remaining stations and facilities are on a circular flat encircling the normal deck, along the inner surface of the Bridge shell. One or more stations or facilities takes up each of the twelve segments of this shell's perimeter.

-Types of Stations

The following diagram shows an arrangement of Stations, Half-Stations, and other facilities within a Class 1-B starship Bridge. Said arrangement may vary (as may color scheme) from ship to ship.

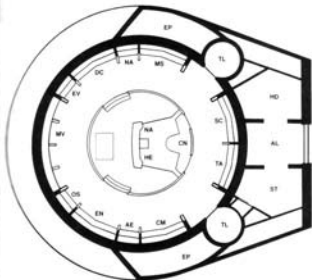

CN - Conn	CM - Communications
HE - Helm	AE - Auxiliary Engineering
NA - Navigation	EN - Engineering
MV - Main Viewer	OS - Override Systems
EV - Environment	TL - Turbo-Lift [2]
DC - Damage Control	AL - Airlock
SE - Security	ST - Staging
MS - Mission Status	HD - Head
SC - Sciences	EP - Emergency Batteries
TA - Tactical	

There are two basic types of stations, Half-Stations and Stations. Stations are those which are normally manned during all shifts - either by the Department/Division Head or his other watch reliefs. Half-Stations are those which are normally manned one watch out of three, enabling the operator to run routine diagnostic checks and procedures. The accompanying diagrams shows one of each: the Communications Station and the Auxiliary Engineering Half-Station.

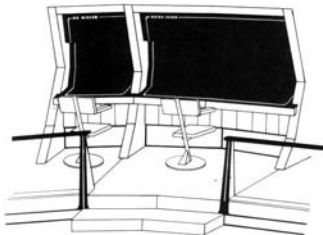

-Command Console

The model 3KCD is the latest upgrading in Helm/Navigation/Command & Control Systems, and is now being installed in all Class 1-B starships as part of the on-going Refurbishing and Refit program. Rather than the thirteen separate panels in use for the past twenty years, the new design features a single one-piece Chromatic Liquid Crystal Display, which is programmed to appear and behave as twenty separate panels. Each of these displays is driven by its own microprocessor and memory bank. Where programmed, sections of the panels act as touch-pads and buttons - eliminating the need for moving parts. Key intelligence panels have both touch-pad and voice-activated systems acting in parallel, for easy computer access.

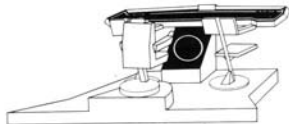

Starfleet DYNAMICS

-Station and Facility Synopsis

The following list includes a brief synopsis of each station and facility on the Bridge, in terms of basic function and capabilities, as well as type. It is not intended to provide detailed panel nomenclature.

Conn: Overseeing and Commanding all stations.

Helm: Selection and execution of pre-programmed courses from Course Preset memory bank. Manual override for close-in and evasive maneuvering. Auxiliary fire-control.

Navigation: Updating ship's positional coordinates. Plotting and setting up courses for Preset bank. Monitoring deviation of ship from established course.

Communications: Maintaining various logs. Tachyonic Communications (Subspace). Electromagnetic Communications (Radio). Internal Communications (Intercom).

Sciences: Deployment and monitoring of sensors. Analysing sensor-acquired data. Library Computer access for CO.

Engineering: Main Reactor and subsystem activity. Warp Drive Nacelle Output. Impulse Drive Assembly. Internal Power Distribution.

Tactical: Monitoring of sector activity. Target identification and selection. Photon Torpedo Coordination. Phaser Bank Coordination. Defense Field Activation.

Environment: Monitoring of Life-support systems. Monitoring of Synthetic Gravity Field. Control of Acceleration Damping Field.

Damage Control: Coordination of routine maintenance. Monitoring Airlock activity. Controlling Damage Control Teams. Displaying ship's damage on schematics.

Security: Monitoring of patrol and sentry personnel. Intruder Control Systems (gas and doors).

Emergency Power: Back-up power for essential Bridge systems [Cold-Fusion Power Cells].

Main Viewer: Display visual and tactical data.

Turbo-lift: [2] Access to all points below. Access to VIP Airlock and Head.

Mission [Fleet] Status: When ship is acting alone; Monitoring of landing-party or deployed shuttles. When ship is acting as Flagship; Monitoring of Task Force.

Override Systems: Capable of overriding and assuming manual direct-control of any non-bridge system within the ship (eg: Turbo-lifts).

Auxiliary Engineering: Monitoring of minor ship sub-systems (eg: piping and wiring). Controlling of such sub-systems as Tractor Beam whenever the Engineering Station is busy.

Flagship Bridge

Monitoring the activity of a Battle-group or entire Sub-Fleet as well as planning, executing, and evaluating strategy, creates a particular set of requirements. The Center Position is divided into two seats: Flag - the Admiral or other Flag Officer orchestrating and commanding the Battle-group, and Captain - who runs the Flagship as his own command.

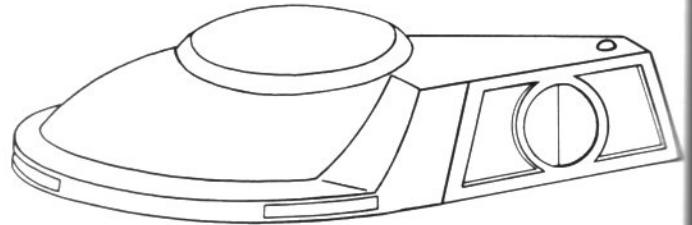

Weapons System

Fire-Control Systems

A Class 1-B starship has two types of Weapons Systems: Offensive (Phasers, Megaphasers, Photon Torpedoes) & Defensive (Force-fields, Deflector Screens). These will be clustered and scattered at various strategically located hardpoints upon the surface of the hull. Each Phaser Bank, Torpedo Bay, or Force-field Generator has its own local control console, capable of operating that specific system. These localized consoles are seldom used in their fire-control capacity however. Instead, their Target Selection and Activation functions are normally slaved to the Bridge Tactical Console, delegating the local consoles to the role of monitoring the ready status of each system. Acting as the nexus for all ordnance systems and sensor arrays, the Tactical Console is capable of coordinating and directing all functions from a location both visible and accessible to the CO. The Tactical Console is the prime interface to the Tactical Computer (TC). Its functions are as follows:

Locating: Any/all objects coming within sensor range are automatically assigned a TARGET REFERENCE CODE by the TC, which will maintain a running update of each one's coordinates. Analysis: Should one or more objects within sensor range fit within stored DANGER PROFILES (known enemy vessels, hazardous phenomena), the TC will raise the shields - even when unmanned - and alert the Bridge personnel via klaxon and computer-synthesized voice.

Tracking: Once advised of target and which weapon systems to use, the TC will bring the indicated weapons to

Operations Department

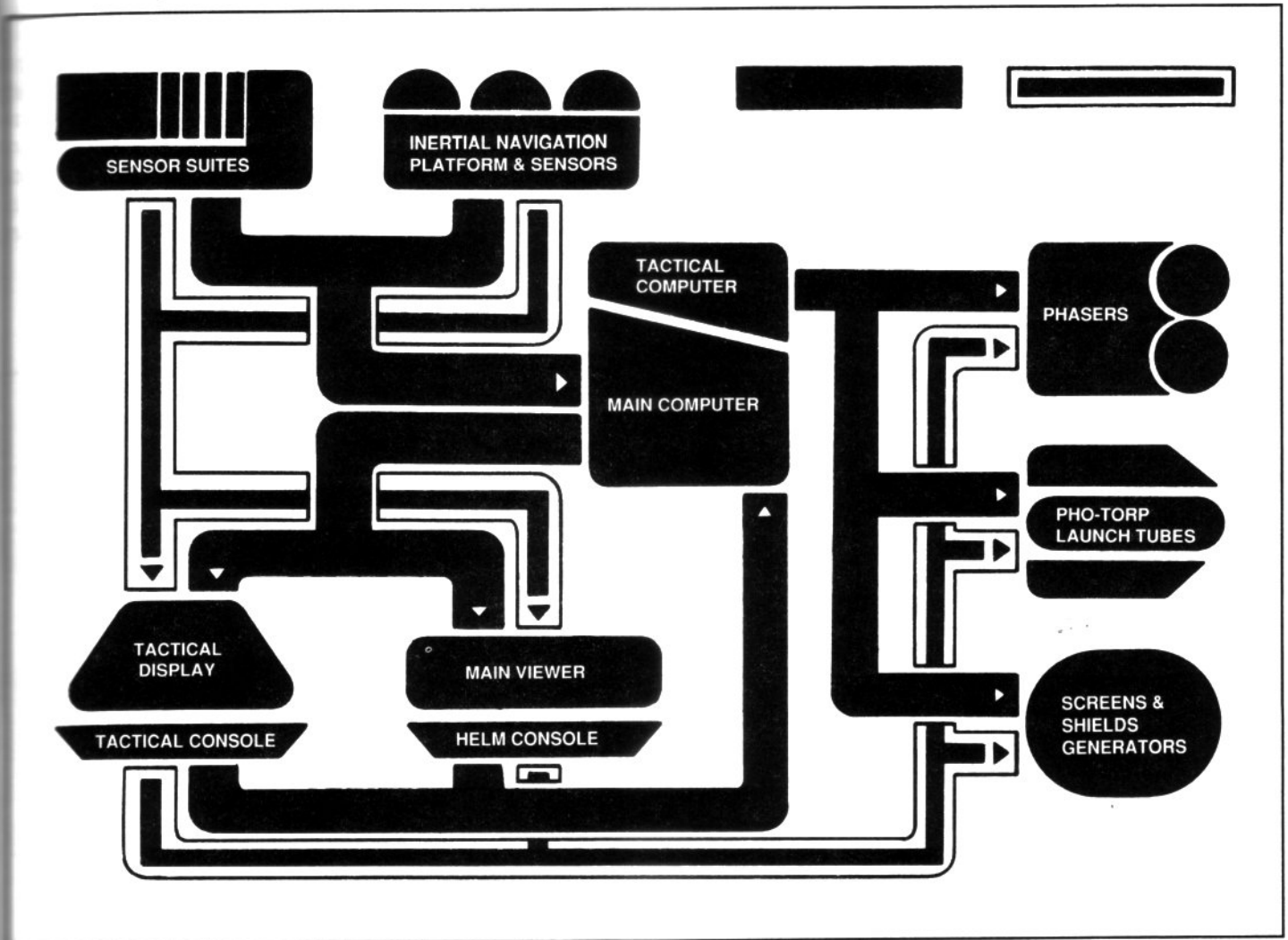

bear upon the target(s) in question, aiming the Phaser Banks or programming the Pho-torp guidance system. Once these chosen weapons are bearing on target, the TC will monitor the target via sensors and automatically update and correct for changes in speed, course, orientation, and bearing on behalf of both ship and target.

Discrimination: If desirable and possible, the operator may select a specific sub-section of the TARGET REFERENCE CODE as a point-of-aim (such as an enemy vessel's engines, or a planet's city). To engage this Target Selection option, the Manual Override is activated. The TC will follow the new point-of-aim and signal TARGET RE-LOCK.

Firing: To fire the weapon's selected, they must first be ARMED and then FIRED via the appropriate touchpads. If the Manual Override is being used, the FIRE button atop it will fire the weapon, but will not arm it.

Multiple Tracking: If more than one TARGET REFERENCE CODE was established, the operator has two options. Firstly he may indicate SERIAL FIRE - in which case

he must arm and fire at the first target, and then re-arm and fire at the second. Secondly he may indicate PARALLEL FIRE - in which case the TC will aim and arm as many weapons as necessary, assigning them to the identified targets, and hitting all sequentially when the FIRE order is given.

Partial Failure: Such conditions as poor sensor data-feed may impede or eliminate the ability of the TC to LOCK. In this case, the operator must use the Manual Override to find and keep his target centered.

Total Failure: If the Bridge Tactical Console and Tactical Computer is down, total control reverts automatically to the localized individual control consoles at each weapon location. Targeting and firing will be carried out manually.

Remote: If the Tactical Console is unmanned but the TC is functioning, the TC can be operated from the Helm Station's Fire-Control Panel, which though simplified can easily direct automatic target selection and firing. The next illustration shows the pattern and flow of telemetry data as

Starfleet DYNAMICS

it pertains to the Weapons Console: from Sensors, through Fire-Control, to the weapons systems themselves. Note that the pattern is split into two main control bank modes: Tactical Console and Helm Console. In either case data is normally fed into and processed by the Tactical Computer on its way from the sensors to the consoles - which in this case acts in its Sentry/Filter Mode. As well, data (instructions) going from the consoles to the weapons systems passes through the Tactical Computer - which in this case acts in its Augmentation Mode, supplying such aids as

automated Phaser-Lock and Tracking. A second set of optical fiber cables, by-passing the Tactical Computer exists, and is known as the Emergency Unprocessed Data Shunt. In the event of TC shut-down, the Shunt allows raw data to proceed directly from sensors to consoles, and hence the weapons systems. In such an event, the Tactical Console would be useless, and weapons control would be passed to the Helm and the various individual weapons consoles.

Photon Torpedo - Mark 6

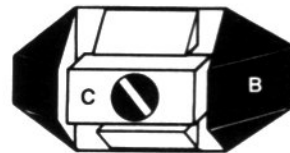
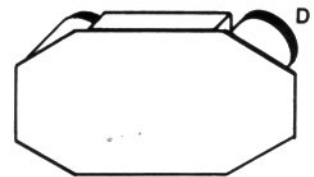
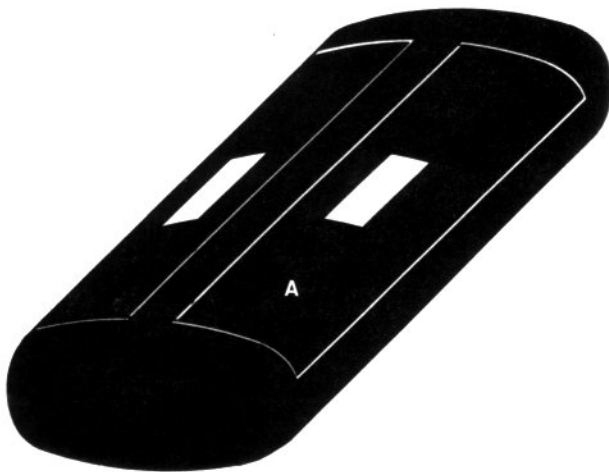

Length 2.5 meters

- A) Terminium Casing
- B) Sensor Arrays
- C) Guidance System
- D) Thrusters (4)

The Mark 6 Photon Torpedo is the second-line offensive weapon of a Class 1-B starship. It is also much more. The Mark 6 can be made endlessly protean by substituting various payload modules. Thus, while the casing provides the propulsion, guidance, and hull, the payload provides and defines the intended function. As an example, a Mark 9-B Heavy Cruiser carries twenty-five torpedo casings within its dorsal hull's Ordnance Armory (just above the Pho-torp Launch Bays). Within the Payload Lockers of said Armory are kept at least forty payload modules - twenty warheads plus an assortment of ancillary modules, whose special purposes are explained in the following section.

Except in the case of the warhead module, all modules and casings are potentially recoverable and reusable.

-Variable Payload Modules

The following is a compendium of some of the more frequently carried Variable Payload Modules, utilized by Starfleet Starships and Spaceships.

Operations Department

Photon Torpedo Warhead: Used as a torpedo or mine, depending on whether it is launched at a target or placed on station to await one. Detonation yield is variable, depending upon the mass of antimatter loaded into the containment sphere.

Yield 10-50 megaton
Lifetime 1 year (mine)
Velocity 0.9 C + ship's

- A) Powerpack
- B) Antimatter Containment Sphere
- C) Onboard Computer
- D) Force-field Generator

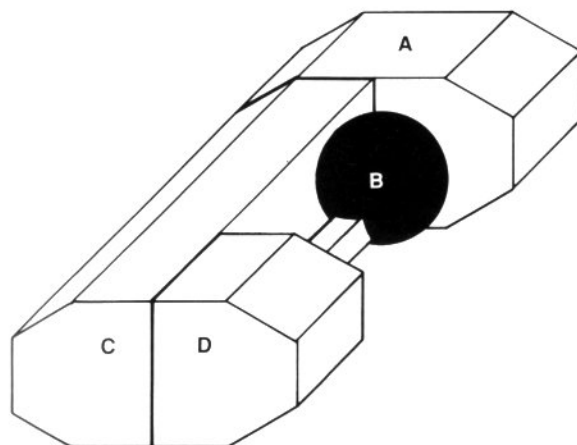

Recorder-Marker Buoy: In its primary usage, the Buoy is used to speed-load the entire contents of the FLIDAR in the event of imminent vessel destruction, and then to depart the vessel at 0.9 C, so as to safe-guard the Log entries and telemetry. A subspace beacon will transmit for ten years. In its secondary usage, a buoy can be placed on station so as to mark a particular coordinate in space (asteroid, rendezvous), acting as a transponder (see: FLIGHT DATA RECORDER, BUOYS).

Beacon Range 5 parsecs
Lifetime 10 years

- A) Powerpack
- B) Memory Bank
- C) Subspace Transmitter

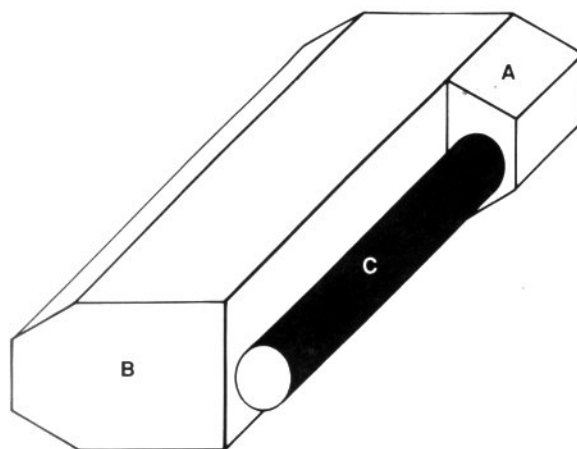

Sensor Probe: Intended to proceed ahead of a vessel through normal space, be placed in position or in close orbit about a hazardous planet, scanning its surroundings and transmitting all acquired telemetry back to the launch vessel in real-time. The Mark 7-B Scout Class starship carries fifty such modules.

Sensor Range 1,000,000 km
Transmitter Range 5 parsecs

- A) Powerpack
- B) Subspace Transceiver
- C) Sensor Arrays
- D) Memory Bank

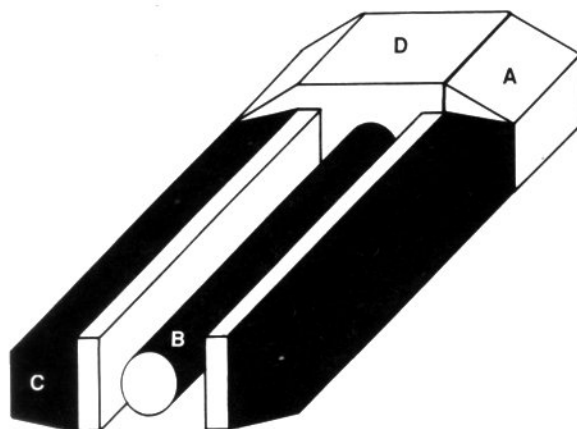

Starfleet DYNAMICS

Vessel Simulator: Intended to deceive an enemy vessel's Long-Range sensors that it is a Federation starship. Transmits such simulated emissions as: ID Transponder, "leaked" intercom signals, navigation lights, sensor scans, and the occasional pre-recorded subspace message. Can be set to simulate any commercial or military vessel, with its course either preset before launch or remoted from the launch vessel.

Velocity Warp 3
Lifetime 20 hours

- A) Micro-warp Drive
- B) Real-space Transmitter
- C) Sub-space Transceiver
- D) Memory Bank
- E) Powerpack

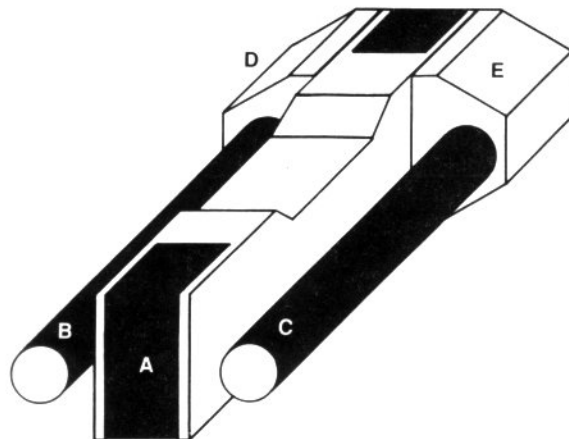

Surveillance Probe: Intended to proceed away from a vessel at warp speed, scanning its surroundings and storing all acquired data until it returns to the launch vessel for retrieval (presence of the micro-warp drive unit leaves no room for a subspace transceiver). The Mark 7-B Scout carries fifty such modules.

Velocity Warp 3
Lifetime 20 hours

- A) Micro-warp Drive
- B) Sensor Arrays
- C) Memory Bank
- D) Powerpack

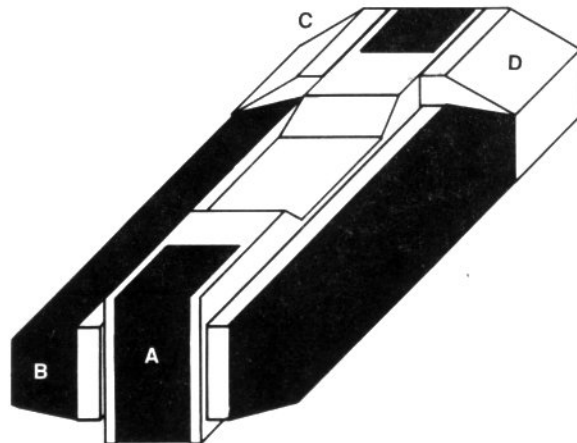

Target Drone: Used for target practice in training fire-control crews and in synchronizing sensor/TC/weapons systems linkages. Maneuvering control is remoted from the Auxiliary Bridge of the vessel. Equipped with both thrusters and warp drive, the drone can mimic almost any vessel.

Velocity Warp 3
Lifetime 10 hours

- A) Micro-warp Drive
- B) Extra Thruster Fuel Tanks
- C) Subspace Transceiver
- D) Powerpack

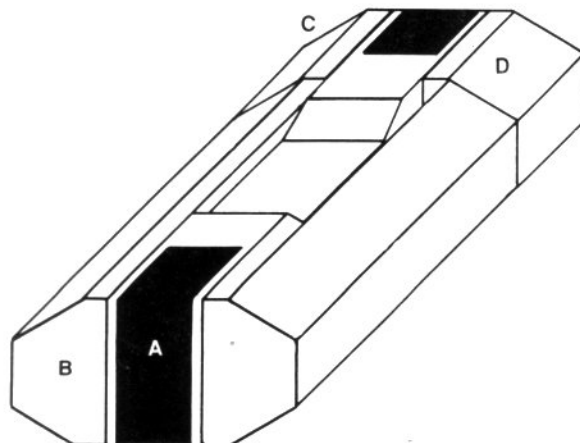

Operations Department

Phasers

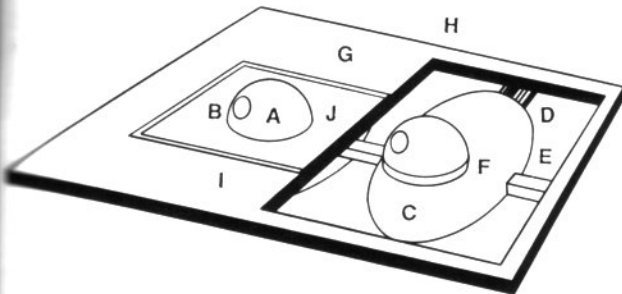

- A) Hemispheric Turret
- B) Emission Nozzle
- C) Energy Chamber
- D) Energy Micro-conduit
- E) Energy Chamber Supports
- F) Gas-tight Seal
- G) Outer Hull Plates
- H) Defense Field Grid
- I) Yellow Warning Stripe
- J) Orange Hazard Zone

Range 250,000 km
Yield 70 gigajoules

Settings:

Stun Low-power neural impact
Heat Microwave induction
Kill High-power neural impact
Disrupt Elimination of intermolecular bonds

Patterns:

Burst 0.5 second duration fire
Extended Up to 180 seconds fire
Narrow Spread ratio 1:10,000
Wide Spread ratio 1:100

Phasers are the primary offensive weaponry on all Starfleet vessels. Class 1-B starships feature the TT990X Phaser Bank Weapons System. A Phaser Bank consists of two Phaser units, composed of energy chamber and emission nozzle. The nozzles are mounted on power-driven universal bearing swivels, half exposed outside the hull, and each capable of rotating in three dimensions through a 120-degree field-of-aim. The two units are slaved and synchronized together, and the swivel's drive motors are remotely controlled by the Tactical Computer, which inputs aiming and tracking telemetry from the ship's sensors and Weapons Console.

When the ship's shields are up, the Phasers are enclosed. To fire them, a "window" is created by negating the appropriate section of shielding protecting that Bank. This is implemented automatically by the TC.

The preceding illustration shows the mounting of paired

TT990X Phaser units to comprise a Bank. All control and power systems are interlocked. Due to the intense radiation leakage potential, both energy chambers are sequestered within a shielded compartment, which is kept filled with phaser-coolant gas. This compartment can be flushed clean within ten minutes, but not while the Phasers are energized. Power is fed to each energy chamber via a micro-conduit, which draws power directly from the main reactor using the intermittent power grid (see: POWER DISTRIBUTION). Stray heavy-particle bombardment sets up extreme radioactivity in the outer hull plates directly adjacent the Banks. For this reason, a 2 x 4 meter Hazard warning (orange with yellow outside stripe) surrounds the nozzles of each Bank. This signifies EVA danger.

Megaphasers

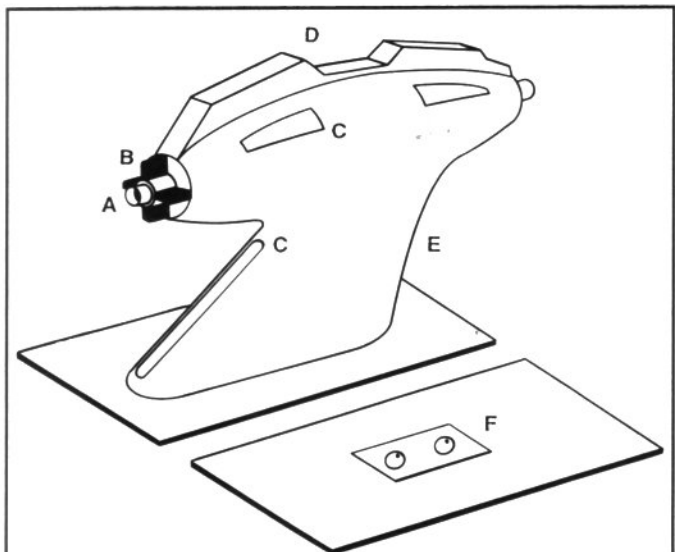

- A) Emission Nozzles (2)
- B) Cooling Vanes
- C) Flush Vents
- D) Main Intercooler
- E) Support Pylon
- F) Phaser Bank (for size comparison)

Range 1,000,000 km
Yield 2600 gigajoules

Settings:

As per TT990X

Patterns:

Burst 5.0 second fire
Extended Up to 120 seconds of fire
Narrow Spread Ratio 1:10,000
Wide Spread Ratio 1:100

Starfleet DYNAMICS

Megaphasers are considered to be the penultimate refinement of phaser technology. Power yield is so great that it rivals that of a Photon Torpedo with regard to range and target damage. The TU555X has been mounted in pairs on the Mark 11-B and Mark 12-B starships, and singly on the Mark 18-B. It is significant to note that due to the enormous fire-power inherent in the Megaphaser, the designers of the Mark 12-B felt it unnecessary to equip the vessel with Photon Torpedoes. The Megaphaser consists of two spherical energy chambers linked to two emission nozzles, any of which can be selected singly or in concert by the TC. This allows a 180-degree field-of-aim. The power demands of a Megaphaser are so large that an energy conduit equal in size and capacity to those feeding the Warp Drive Nacelles feeds each unit directly from the Intermix Shaft (see: MAIN ENGINE COMPONENTS & SUBSYSTEMS). Because of the immense energies involved the potential for destruction in the case of energy chamber overload is enormous. For this reason Megaphasers are always mounted away from the hull on a pylon, which can be detached and jettisoned via explosive bolts.

Defense Fields

The defensive ordnance on a Class 1-B starship consists of two systems: the DS814U Shields and the DB225C Screens. Both are magneto-gravitic effects, whose generators are within the vessel, but whose effectors are a grid on the outer hull surface.

Screens: (Deflector-fields) The Screens are the first line of defense, and as such try to protect the Shields. The Screen is ovoid-shaped, and envelopes the ship at an average distance of fifteen meters from the hull. Possessing a very shallow gravitational slope (almost horizontal), the Screens act as a soft barrier to any attacking matter (heavy atomic particle beams, explosive shock waves) and energy (tachyon/photon beams, solar flux, radiation). They do not attempt to stop any such attack, merely to dampen its impact upon the next line of defense, the Shields. Due to their low gravitational slope, the Screens are not a Do-Or-Die system.

Shields: (Force-fields) The Shields are the secondary line of defense, and as such protect the hull from attacking matter and energy. The Shield effect envelops the ship at a distance of between four angstroms to one meter. Because it is so close to the hull, it is sometimes called the "skin-field". Possessing an extremely steep gravitational slope (almost vertical), the Shields tries to stop-cold any attack made upon it, drawing extra power from the ship's intermittent power grid. If any Shield overwhelmed by an attack so that it is penetrated, the subsequent power feedback will backlash the generator - buckling the Shield in question. For this reason a Shield is referred to as a Do-

Or-Die system (DOD). To prevent total Defense Field loss, each section of the ship's hull is protected by a different generator, so that the failure of any one Shield will not affect the others, or the Screens.

- A) Ship
- B) Screen
- C) Shield

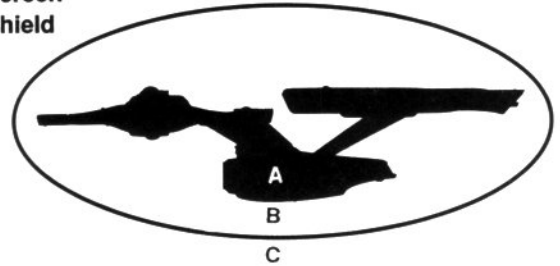

Target & Weapon Selection

When firing at an enemy vessel, the target area chosen depends upon two factors: Desired Effect & Weapon Selected.

-Photon Torpedo

The sole purpose of the Photon Torpedo warhead is to inflict maximum damage upon the enemy; hopefully overwhelming his defenses and destroying his vessel. Subsequently, target areas are limited to those most likely to accomplish this objective: Propulsion, Power Generation,

-Phaser

Destruction of the enemy vessel is rarely the purpose of a Phaser attack. Usually the desired effect is to cripple his vessel - eliminating its ability to fight or flight - while sparing it and its complement any unnecessary damage or casualties. To remove its fighting ability may involve attacking the various weapons emplacement mountings on the hull, but more frequently involves interfering with the control or power feed to these scattered weapons by taking out essential subsystems. For example: An enemy vessel cannot fire weapons if its crew cannot locate the target - thus Sensors and Computers become prime targeting areas. Likewise, a vessel cannot maneuver or escape if the flow of energy to its Warp Drive is interrupted, or if there is no directional control - thus Interconnecting Struts and the Bridge are prime targets.

The following illustration identifies the Primary Targeting Areas on a K'Tinga Class Cruiser - the principle workhorse of both the Klingon and Romulan fleets. Other Klingon and Romulan vessel classes may differ in size, but all share this relative arrangement.

Operations Department

- A) Bridge
- B) Sensors
- C) Computer Bay
- D) Interconnecting Strut
- E) Main Disruptor Banks
- F) Main Photon Torpedo Tube
- G) Main Reactor/Impulse Drive
- H) Nacelle Support Strut
- I) S-2 Graph Nacelle

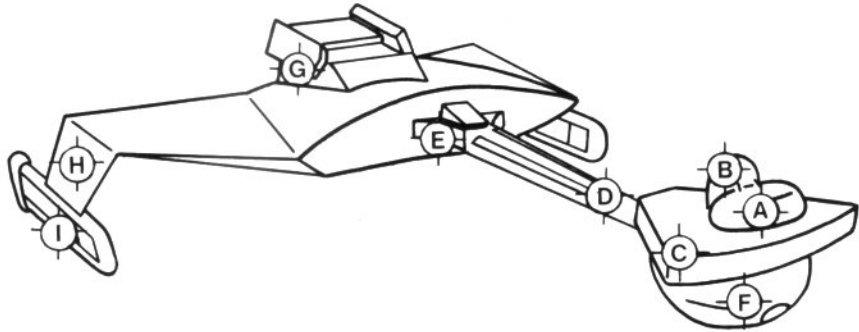

Navigation

Navigation & Helm Responsibilities

PRESENT COORDINATES:

012 334 203

DESTINATION COORDINATES:

014 336 209

COURSE:

356.8 MARK 017

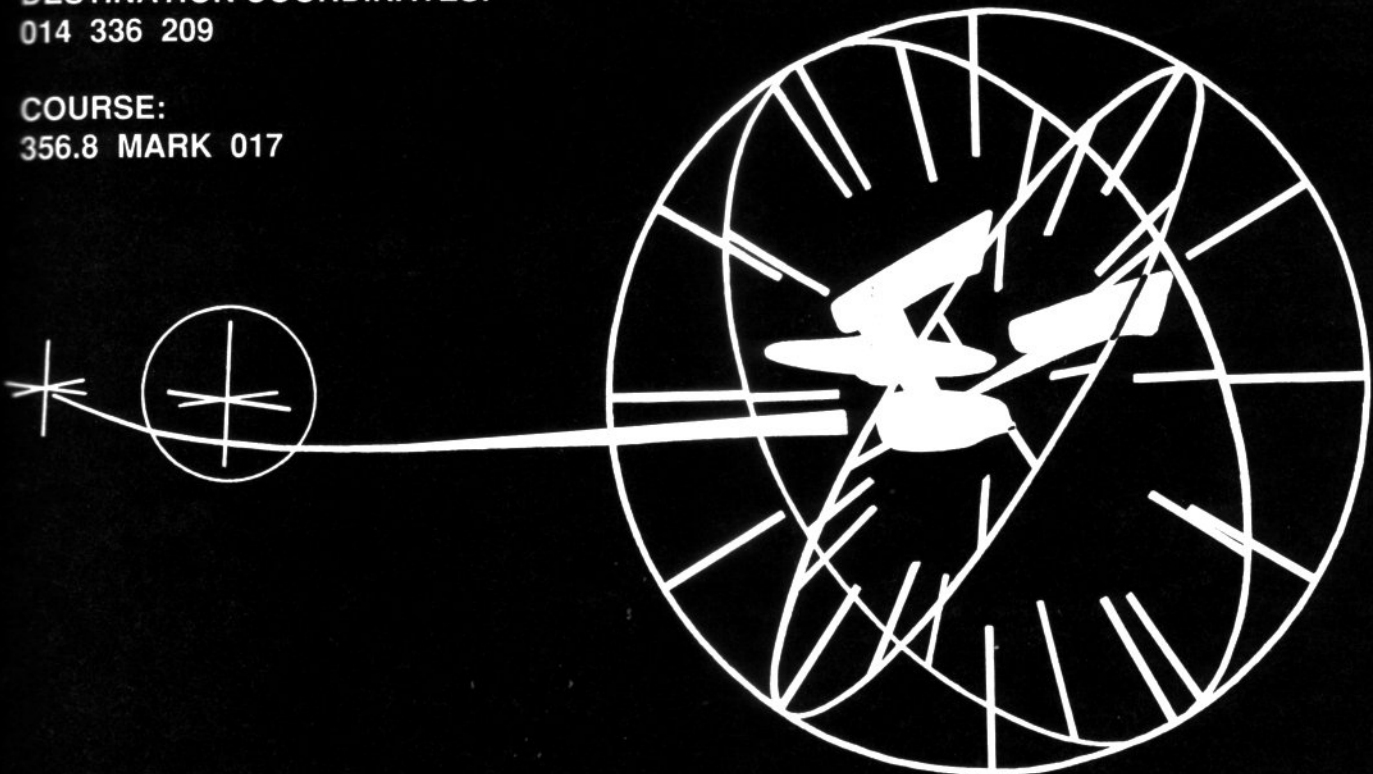

Starfleet DYNAMICS

-Navigator

The Navigator's responsibilities are three-fold.

First: To calculate and update the ship's present position with regards to velocity and maneuvers.

Second: To locate the coordinates of the Captain's designated destination, using the ship's Navigational Computer.

Third: To calculate the best course from the origin coordinates to the destination coordinates, allowing for intervening Neutral Zones and catalogued hazards to navigation. The final course, a nearly-straight line (spline) which curves to avoid hazards, is then transferred into the Console's Course Preset Panel.

-Helmsman

The Helmsman's responsibilities are four-fold.

First: To execute any courses stored in the Course Preset Memory Bank - as ordered by the Captain and at the velocity designated by the Captain.

Second: To monitor the ship's progress along its course, alerting the Captain to any uncharted objects or hazards, and to override the existing course as directed so as to either avoid said hazard or stop for investigation.

Third: To maneuver the vessel on manual control for such purposes as evasive maneuvers, intercept courses, and orbital insertions.

Fourth: To act as the auxiliary Weapon's Officer whenever the Bridge Tactical Console is unmanned using the Helm Console Fire-Control Panel.

-Maneuvering Orientation

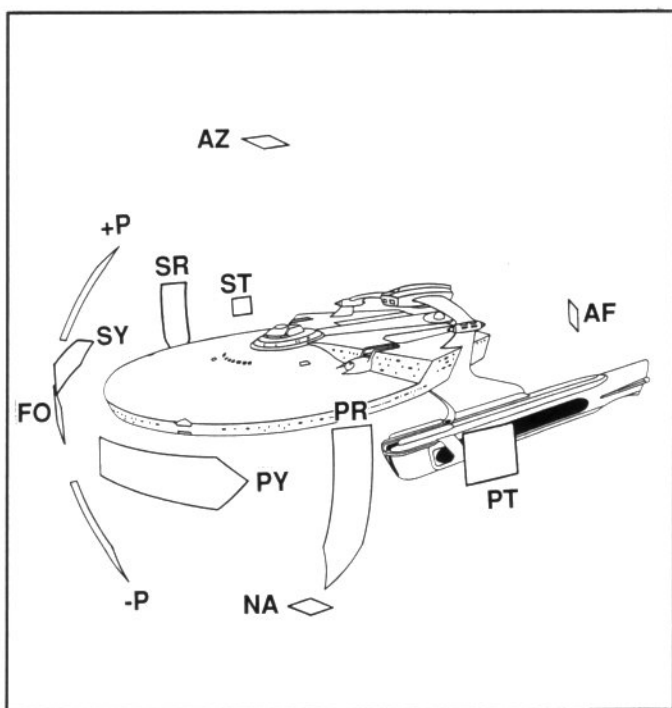

+P) Positive Pitch	FO) Fore
-P) Negative Pitch	ST) Starboard
SR) Starboard Roll	AF) Aft
PR) Port Roll	PT) Port
SY) Starboard Yaw	AZ) Azimuth
PY) Port Yaw	NA) Nadir

As shown in the preceding diagram, any maneuver can be described as a series of rotations along the X, Y, or Z Axis - alone or in combination. Such rotations are divided into three categories: Roll (rotation along the X Axis), Pitch (rotation along the Y Axis), Yaw (rotation along the Z Axis). As well, each category can be in either of two directions.

-Relative Bearings

The position of objects outside of a vessel (planets, stars, other vessels) are described by means of relative bearings. The bearings are so-called because they are relative to a line forward of the vessel's bow. A set of bearings is of two parts. The first bearing is along a great-circle running clockwise from 000 degrees (dead ahead) along the equatorial plane through 180 degrees (dead astern) to 359 degrees (just one degree short of dead ahead again). Thus the first bearing circles the vessel "horizontally", and is also known as the azimuth. The second bearing curves up to +90 degrees (zenith), or down to -90 degrees (nadir) from

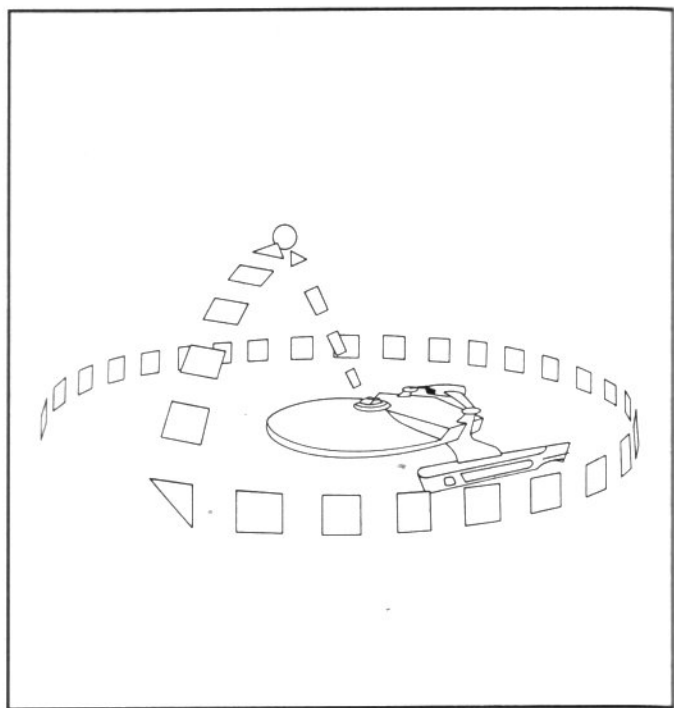

Operations Department

the azimuth, and is also known as the elevation or depression angle.

When recorded or stated, a relative bearing is listed thus: Bearing, Azimuth Angle, Mark, Elevation/Depression Angle. Therefore the illustration above would be described: Bearing 290 Mark 80.

A relative coordinate is stated: Relative Bearing, Range. An example would be: Bearing 290 Mark 80, Range 2.9 Parsecs.

Planetary Orbit

There are three types of planetary orbits used primarily by Starfleet vessels. Each has its own particular function and Type Number - for ease of Command. The examples below include Type, Description, Function, and a diagram showing the orbital path relative to the planet and its rotation (dynamics). It is an axiom that no planet is a perfect sphere - each has its own imperfections in terms of shape (mountain ranges, ocean bed trenches) and density concentrations (mascons). Such imperfections cause distortions in the theoretically smooth and symmetrical gravity well sur-

rounding a planet. For this reason, vessels in orbit must apply occasional maneuvering thrust to adjust anomalies in their orbital path - especially in close orbits, where orbital decay is never far off.

Type 1: (Standard Orbit) With the planet rotating below, the vessel travels in a low orbital path which overtakes the rotation by a factor of five or more. Thus the vessel traverses the entire equatorial belt, useful for scanning for civilizations, and allowing for frequent communication and transport with widely scattered Landing Parties at intervals.

Type 2: (Geosynchronous Orbit) Orbiting in synch with the planet's rate of rotation, the vessel remains poised over one planetary coordinate near the equator. Essential for monitoring a critical on-planet activity, remaining in constant contact with a Landing Party, or staying on alert in case of an immediate transport requirement.

Type 3: (Polar Orbit) Utilized for cartographic survey, or search-and-rescue scanning modes. Maintaining a close orbital path at right-angles to the planet's rotation, the vessel will eventually have traveled directly over every section of the planet, as the planet continues to rotate beneath it.

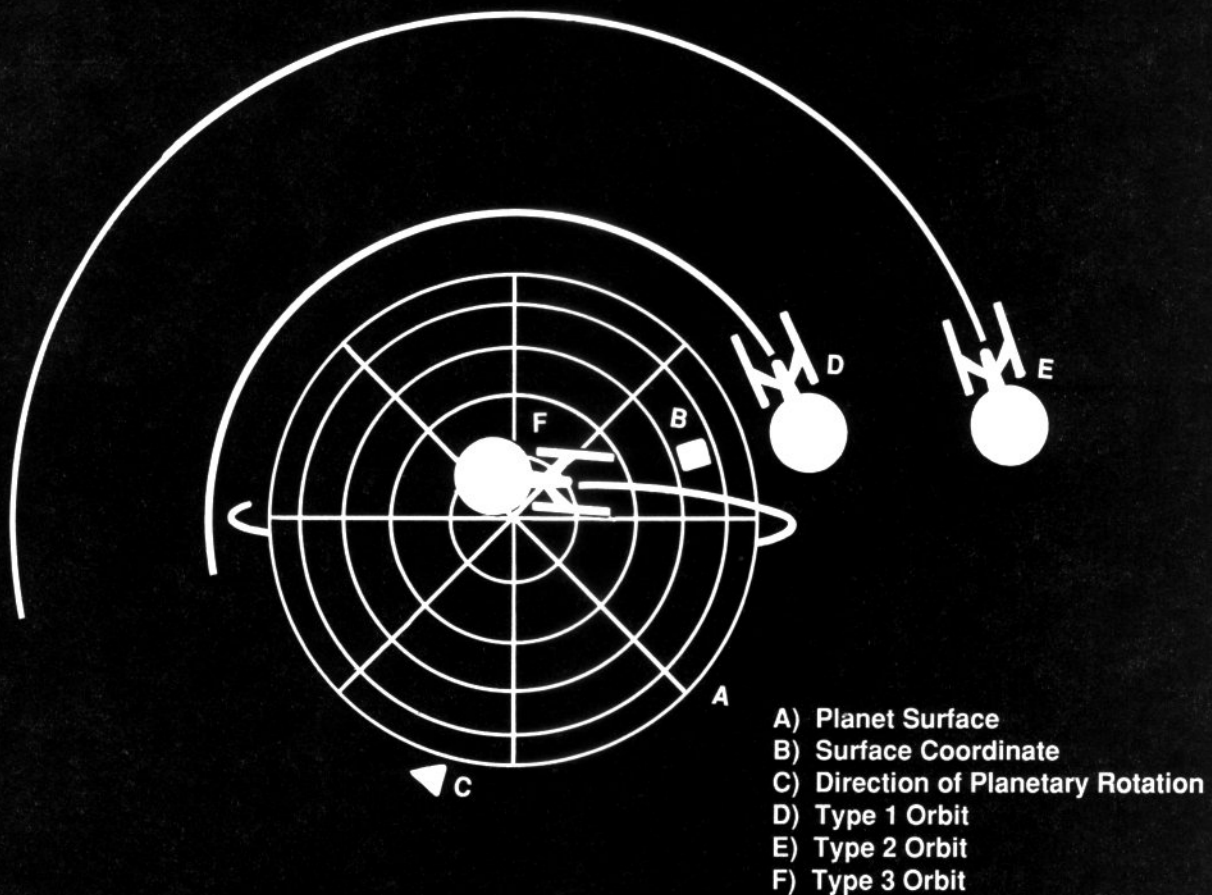

Starfleet DYNAMICS

-Navigational Hazards

Various phenomena existing in space pose serious dangers to spacecraft navigation. Some of these objects/conditions are natural, others are artificial. All are included on standard military and civilian starcharts. These hazards can be identified by their coding, which consists of two

parts: a letter designating the type of hazard, and a number denoting the danger-level the particular hazard was assigned by the discovering vessel and the Federation Bureau of Navigation (1 denoting low danger and 10 high). Thus a coding of I-4 describes a moderate Ion Storm.

Navigational Hazard Chart			
CODE	TYPE	DESCRIPTION	EXAMPLE
A	Asteroid Belt	A toroid-shaped grouping of planetoids orbiting a star - usually the debris of a broken-up planet	Sol Belt
B	Asteroid Field	A dispersed group of planetoids, collected in the trojan points of a multiple star system, or major planetary orbit	Alpha Centauri
D	Derelict	An abandoned spacecraft in free trajectory or orbit. Frequently these are emitting dangerous radiations from faulty powerplants	S.S. Botany Bay
I	Ion Storm	Interstellar cloud of ionized plasma ejected from turbulently-active stars	CY Aquarii
K	Nebula	Interstellar cloud of gases (mostly hydrogen and helium), novae debris	Coal Sack
N	Neutral Zone	A spherical forbidden zone surrounding one or more interdicted solar systems	892
Q	Quasar-like	Any radiation-emitting anomaly, possibly indicative of protostar development	Murasaki 312
R	Rogue-Planet	A frozen planet in free trajectory	Snowball
S	Nova/Supernova	The residue of an exploded star: The radiation wave-front expands as a spherical shell at light-speed, and is followed by a slightly slower wave-front comprised of gases and particle radiation	Beta Niobe
T	Black Hole	The radiation, tidal, temporal and gravitational anomalies surrounding these singularities are extremely hazardous to FTL and STL ships	X Cygni
X	Unknown	Due to as-yet unexplained causes, vessels have vanished while travelling in this vicinity	The Void

-Navigational References & Pulsars

Since man first began voyaging in wooden boats upon the seas of Terra, he has navigated by the stars. As his ocean-going vessels grew more sophisticated, so also did his navigational aids (inertial guidance, satellite reference), but always as a final check he used the "fixed" stars. As man moved into space the stars regained their primary

importance. Whether for orbital, interplanetary, or even slower-than-light interstellar travel, the stars served as readily visible points of reference. By this time "epoch" - the proper motion of stars - had been discovered, but when compared with the speeds of the vessels, epoch vectors (measured in km/sec) were of little consequence.

However, in the early twenty-first century this changed, as

Operations Department

Warp Drive was invented. Suddenly the distant stars were not so distant, and their apparent motions ever-more-so difficult to calculate as vessels out-raced the photons themselves. Also, identifying individual stars (other than those few within a few parsecs) while traveling at Warp speeds turned out to be extremely difficult. Worse yet, a vessel traveling ten or twenty parsecs could re-enter normal space to find that all but the brightest stellar benchmarks (Antares, Rigel) were now indistinguishable from the surrounding background. A need had arisen for a new type of navigational reference point, one easily located at long interstellar distances.

The solution was pulsars. These phenomena were first detected by radio astronomers in early-atomic history (Terra 1970's). Each was shown to be a distant, swiftly rotating neutron star, whose fierce magnetic field collimated its intense electromagnetic emissions into two beams - so that said emissions were only detectable on a plane perpendicular to the pulsar's axis of rotation. Extremely accurate regarding "pulse-rate" (consistent to within .000014 % per year), it was decided by the United Earth Space Probe Agency - forerunner of Starfleet - to utilize pulsars as beacons. Ten pulsars were selected. To qualify, each had to be rotating with its axis of rotation so orientated that a beam swept along the plane of the galactic disc. All information regarding these ten was extensively researched and catalogued. Thereafter, any starship with working sensors and computer could calculate its position accurately, even if it were far removed from the Federation. Since 2150, commercial and private interstellar craft have

had a far easier reference system, as Starfleet has deployed navigational buoys (see: BUOYS) at each sector corner and along spacelanes. This of course does not render the pulsar reference obsolete. First; starships traveling outside of the Federation for exploration are beyond the volume of these buoys. Second; military vessels do not utilize buoys for primary guidance, as the buoy's signals could be jammed or counterfeited.

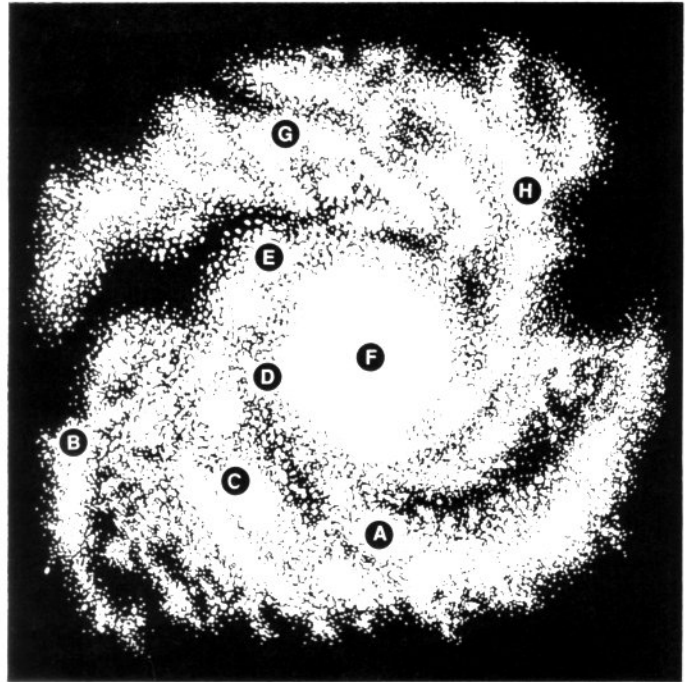

Navigational Reference Beacon Pulsars

IDENT	COORDINATES			LOCATION	PULSE RATE (PER SECOND)	SPIN DECAY RATE (%/Y)
	X	Y	Z			
A	+00120	-00140	+00117	Crab Nebula (UFP)	30.02	.000014
B	+05126	-15013	+00519	Mid-Perseus Arm	14.10	.000361
C	+03002	-07206	-00250	Inner-Orion Arm	2.77	.000019
D	+08082	-05226	+01162	Main Disc	27.03	.000044
E	+14124	-05103	-00076	Inner-Perseus Arm	61.19	.000102
F	+09011	-00019	+02314	Near Galactic Center	1.04	.000677
G	+20022	-04145	+00672	Mid-Bootis Arm	21.67	.000023
H	+17134	+08024	+01112	Mid-Sagittarius Arm	11.76	..000027

Starfleet DYNAMICS

Planetary Defense Systems

The following are some of the components of a Global Defense System. It should be noted that not all member planets of the Federation possess identical systems. Some worlds have more components than others, and thus all systems can be graded on a descending scale of effectiveness. Designing a system depends upon a number of factors. These include Threat (how attractive is the world as a target to the enemy and how badly does it require protection?), Philosophy (will the planet's government allow both Active/Offensive and Passive/Defensive weapons?), and Economics (a world must necessarily finance the majority of its own defenses - both the initial outlay and maintenance). A sample world from each tier on the scale is included in this file.

-Components

Planetary Interdiction Force-field: This is a magnetic-photic shell, surrounding the planet at a distance of one-hundred kilometers from the surface. It is produced by a powerful generator located somewhere on the surface near the equator. The energy required (megavoltage) is supplied by a dedicated Matter/Antimatter Reactor. Stand-by generators - located elsewhere along the equator - may also exist. The Interdiction Force-field is not intended to stop space vessel-based phaser and/or torpedo bombardment, although it can absorb a few shots. The primary purpose is to block or scramble low-power/high-complexity electromagnetic and tachyonic energies - such as sensor and transporter beams. This prevents an orbiting enemy craft from gaining detailed targeting information, and also prevents the enemy from beaming an armed force or Antimatter warhead directly into planetary command centers. Since the penetration of the force-field will cause generator backlash detonation (on the order of a ten-megaton nuclear blast) the generators are kept far from inhabited areas.

Individual City Force-Field: Like the Planetary Force-field, but small enough to envelop one city or military installation. Due to the much smaller field size and corresponding lower energy requirements, the City Force-field can be strengthened to the point where it can deflect/absorb several phaser salvos. The energy required can be easily supplied by a small fusion powerplant, which makes the City Force-field affordable to almost any planet. Due to the relatively small inherent potential energy of this size of force-field, the backlash caused by penetration will create only a small blast, easily contained/absorbed by the field.

Orbital Defense Stations: A series of self-contained facilities in geosynchronous orbit about the planet. Stations may be purely Passive/Defensive in nature, holding only

sensors and tachyonic jamming systems. Contrawise they may be Active/Offensive, holding the above systems plus phaser cannon, hangar facilities for interceptor attack-craft, and torpedoes.

Interceptor Fleet: A group of armed craft, all small and possessing only impulse drives. Their wartime purpose is to engage enemy vessels at a distance from the planet, trying to eliminate or weaken the enemy's capabilities. During peacetime, interceptors fulfil such roles as search & rescue, inter-system traffic control, escort duty, and orbital guard (customs). There are two classes of interceptors: one-man Killer-Bees (Hornets and Wasps), and multiple-crew Cutters, which are attack versions of Shuttlecraft. Both can be parked in a Defense Station's hangar facilities, or launched from a surface base.

-Defense System Tier & Examples

Maximum/Active: (Terra) As the home of the Human species, the Federation, and Starfleet Headquarters, it was recognized that Terra was a prime military target. As such, she has defenses equaled by few other worlds.

- Planetary Force-field
- 500+ City Force-fields
- Orbital and Lunar A/Defense Stations
- Interceptor Fleet

Maximum/Passive: (Vulcan) Reflecting an ancient heritage of non-violence, Vulcan leaders flatly rejected the concept of defense-through-force. They were convinced to accept purely passive defensive only after an appeal from other Federation worlds.

- Planetary Force-field
- 250+ City Force-fields
- Orbital P/Defense Stations

Optimum/Active: (Argelius) Possessing only moderate economic and technological strengths, Argelius elected to utilize what active defenses it could afford - manned by hired outworlders (mostly ex-marine veterans).

- 90+ City Force-fields
- Orbital A/Defense Stations

Optimum/Passive: (Colony 4) Earth Colony 4, a pacifistic culture built by Buddhist Chinese and relatively resource-poor, chose an inexpensive, passive system.

- 37 City Force-fields

Minimum/Active: (Zeta-9) Only recently admitted to the Federation, Zeta-9 has only possessed spaceflight and nuclear power for a few decades. It chose to invest in a minimum, self-built active system.

- Interceptor Fleet

Strategy & Tactics

Definitions

The purpose of this file is to familiarize the officer with some of the better-known and more useful maneuvers and tactical strategies - for use in battle and other engagements with unknown/hostile craft. Some of these maneuvers are classic stratagems, and are frequently named after of by their originator. Others simply definitions of useful practices. All objects will be represented by standard Tactical Symbols.

Tactical Advantage (TA)

Parameters: A basic principle of battle and pursuit is that each is a test of superiority. The vessel with the fastest engines and/or highest tolerance powerplant and/or strongest shields and/or best ordnance will win, depending upon the tactics used. Since no vessel is likely to possess superiority in all traits, tactics should be chosen so as to emphasize your strengths and your opponents' weak-

nesses.

Battle: In battles that vessel initiating actions (maneuvering, firing weapons) has the Tactical Advantage, and the opposing vessel is relegated to the role of reacting to the first (evasive maneuvers, raising shields). The principle axiom of battle is to establish and maintain (or regain) the Tactical Advantage. Engagement Zone/Length of Engagement: The Engagement Zone is the volume of space within each vessel's weapon's firing range.

Pursuit: When a pursuit is underway, TA actually belongs to the fleeing ship. That vessel will get to make such choices as heading and speed. So long as it maintains a large enough separation as to remain outside of the pursuers' Engagement Zone, it may alter course and speed at will - even to turning about and attacking. Pursuit is simply a test of endurance. The fleeing craft will be attempting to reach safety (its own fleet or planet). Thus it will choose whether flight or fight is better, and if the former will utilize full engine output. At such speeds one ship or the other may well suffer a set-back (structural, powerplant, or propulsion failure). If the fleeing craft fails, a battle will ensue. If the pursuer suffers a failure, the fleeing ship will decide whether to escape or turn about to attack.

Battle Scenarios

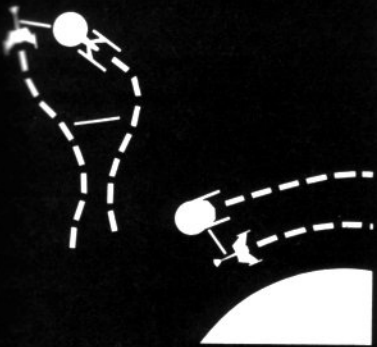

Impulse - Jockeying

At sub-light speeds, opposing vessels will remain within the Engagement Zone for minutes at a time. Therefore, each will jockey for position; maneuvering so as to best attack their opponent's sensitive areas. In orbit, the vessel in the highest orbit has the TA, as he can trap his opponent between his weapons and the planetary surface - reducing his opponent's escape directions to two dimensions.

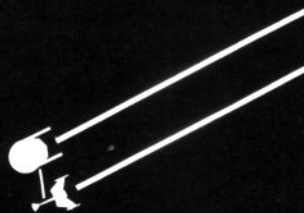

Warpspeed - Overtaking

When opposing vessels are headed along the same heading, how long they remain within the Engagement Zone depends upon the difference between their speeds. If the starship is traveling at wf 6.1 (226.98c) and the Enemy is traveling at wf 6.0 (216.0c), the starship will pass the other at 10.98c, and thus the Length of Engagement will be on the order of microseconds - unless one or the other matches speeds - and can keep them matched.

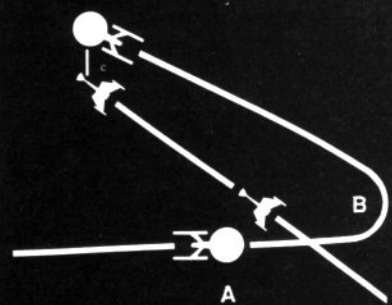

Warpspeed - Oncoming

When two oncoming vessels are approaching at FTL speeds, the Length of Engagement will be even shorter - on the order of nanoseconds [a]. Such attacks are marginal even with the best Tactical computer/weapon loop. To improve the odds, a starship can execute a conic-section (parabolic) intersection turn [b]. This will result in the two vessels being matched in heading (and speed if desired).

Starfleet DYNAMICS

Evasive Maneuvers

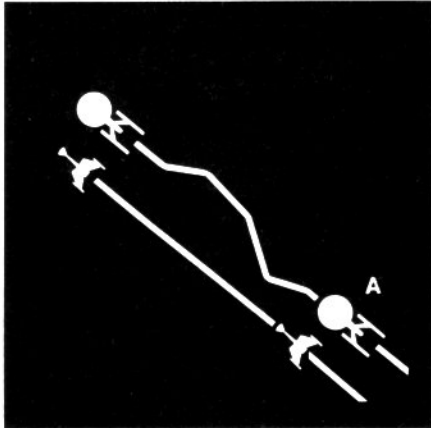

Warpspeed - Jogging

If a starship does not wish to leave the Engagement Zone, but does wish to avoid enemy fire, it must not significantly alter course or speed. Evasive maneuvers normally involve jogging: minor random thrusting to port-zenith-starboard-nadir - not enough to alter course, just enough to make the flight-path an unpredictable jagged line instead of a smooth function. Evasive jogs are pre-loaded into the Helm's Preset Panel, and can be executed instantly [a].

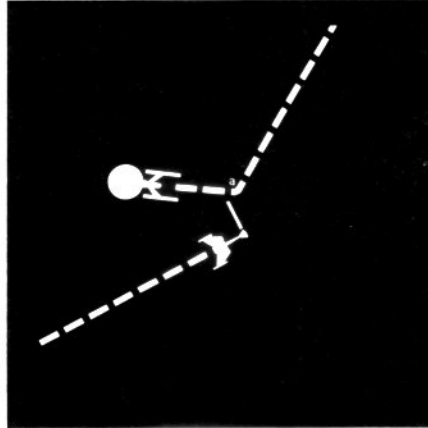

Impulse - Veer

The usual evasive maneuver at sub-light speeds is one or more sudden impulse turns along any vector in order to avoid incoming enemy fire. Since all speeds are low, this will not remove the evading ship from the Engagement Zone.

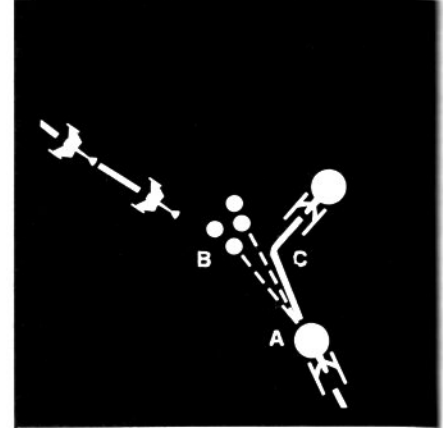

Warpspeed - Pho-Torp Screen Defense

As the starship and enemy vessel approach, the starship launches a salvo of torpedoes [a] - carefully calculated so that all detonate simultaneously between the starship and its opponent [b]. This momentarily overloads the enemy sensors, creating a screen behind which the starship can execute some unseen tactic [c] such as launching a shuttle, performing a radical evasive maneuver, etc.

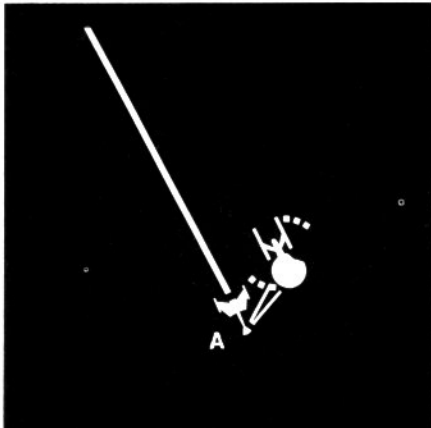

Stationary - Kirk Defense Pivot

Utilized if a starship cannot exit the Engagement Zone, and must protect a portion of its hull whose shields have failed against a mobile enemy. The starship pivots in place so that as the enemy vessel passes by on an attack run [a], the starship's damaged section is kept turned-away. Success of this tactic depends upon such factors as starship maneuverability and enemy speed and firepower.

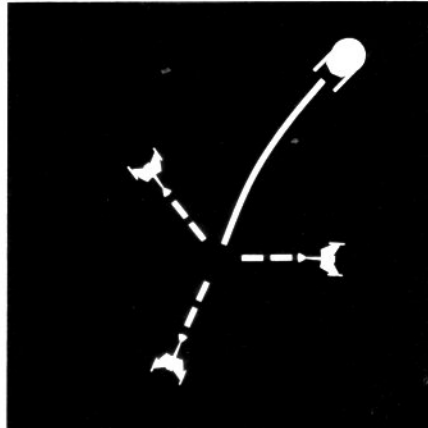

Englobement - Corbomite Escape

A vessel is englobed by becoming surrounded by four or more enemy vessels. With one enemy at each axis of a tetrahedron, all facing inwards, there is no chance for the victim to escape by warping away, as this would mean charging along an enemy's heading. The only way to escape englobement is to cause the enemy to back-up until they are not within point-blank range, and then try to out-race the one with a similar heading. This may be accomplished by bluff.

Operations Department

Re-establishing The Offensive

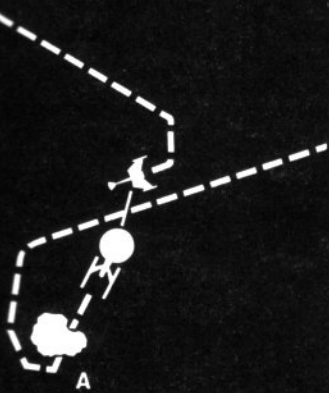

Impulse - Shadow Maneuver

Another evasive scenario requires the presence of a large inert object (planet or asteroid) behind which the fleeing starship can dart. The instant that the starship is screened from its pursuer's sensors [a], it executes an emergency impulse-pivot so that it exits the sensor shadow toward the enemy along a vector which takes the enemy by surprise.

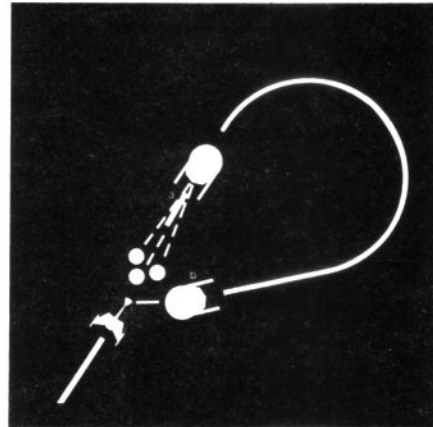

Warspeed - Pho-Torp Screen Attack

Utilized by vessels featuring rear-firing tubes. The fleeing starship launches a salvo of torpedoes, carefully timed to detonate simultaneously between the starship and enemy. This momentarily overloads the enemy's sensors, creating a screen ahead of which the starship can perform an emergency warp-pivot and attack.

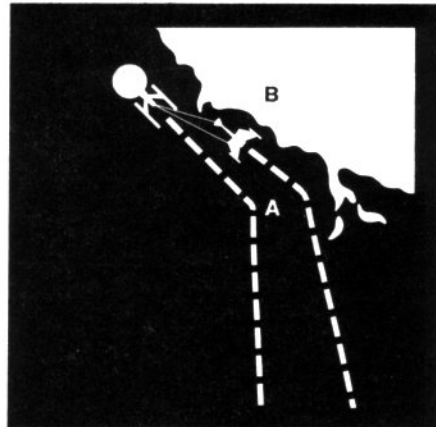

Impulse - April Maneuver

Used to escape a powerful pursuer, but only of the fleeing starship has superior shield capacity. The starship chooses a course tangent to a near-by star [a]. All shield power is focussed between the starship and star, exposing an attractive stern target to the enemy. At closest approach to the star [b] - just when the enemy's shields begin to overload and he is about to break-off pursuit - the starship locks tractor beams onto the enemy's bow, towing it to overload and destruction.

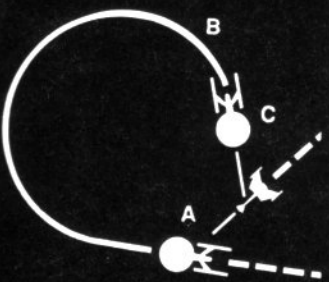

Impulse - Sulu Maneuver

Calls for split-second timing and precise reflexes on the part of the Helmsman. When the starship is fired upon [a], it shifts into warp, circles around its attacker [b], goes sub-light again and fires from its unexpected direction. To be successful, all steps must be accomplished in minimum time, before the enemy can react. The only defense against this tactic is for the enemy to warp away the instant that the starship first shifts into warp.

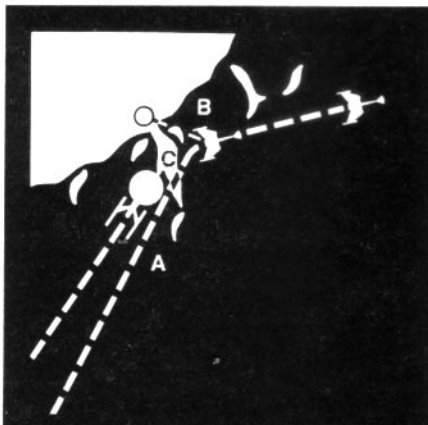

Impulse - Fire-Blossom Ploy

A Klingon maneuver. Similar in initial set-up to the April Maneuver, but not quite as close to the star [a]. At the closest approach to the star, the fleeing enemy jettisons one or more Anti-matter Containment Bottles into the star's corona, there to melt. The resultant detonation's shock-wave within the star's photosphere will engulf the pursuing vessel within a flare of ionized plasma [c], overloading it shields and destroying it.

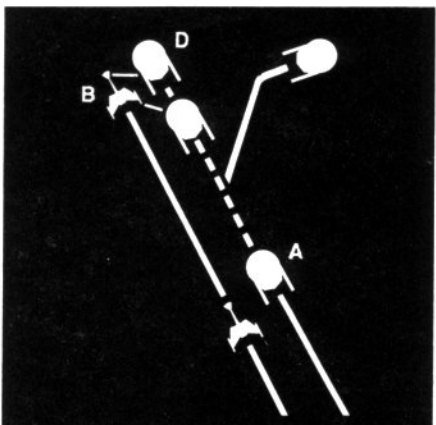

Warspeed - Cochrane De-acceleration Maneuver

If a starship is being chased by an enemy of equal or greater engine performance, it can reverse power and dump itself back to sub-light [a]. The pursuer overshoots his quarry [b]. The starship can re-engage warp and chase the enemy for a stern attack [c], interrupt the dump and parallel the enemy for a flank attack [d], or re-engage warp and veer-off at an angle, escaping the Engagement Zone before the enemy can curve back.

Starfleet DYNAMICS

Starships, Spaceships, and Civilian Vessels

Fleet Strengths & Stationing

Starfleet's collection of vessels (starships, spaceships, and auxiliary craft) are divided into 32 Sub-Fleets, each named for, centered around, and headquartered at a

Starbase. Although the component of each Sub-Fleet is unique, certain trends can be seen to further divide these 32 Sub-Fleets into 3 categories. These categories are referred to as Monitoring, Exploration, and Interdiction. (See: STARBASES).

The preceding Chart shows the Fleet distribution with regards to Class 1-B starships, Class 2 spaceships and Class 4 vessels (Support & Logistics). As well as the total Fleet strength column, a column for Sub-Fleets 1, 3, and 11 show the relative distribution for Monitor, Exploration, and Interdiction Sub-Fleets.

Fleet Strength & Stationing				
VESSEL CLASS & TYPE	MONITOR	EXPLORATION	INTERDICTION	TOTAL FLEET
CLASS 1-B				937
Dreadnought	1	1	2	40
Heavy Cruiser	1	3	7	95
Strike Cruiser	2		1	43
Battlecruiser			2	10
Cruiser	1	1	3	40
T-D Carrier			3	15
Heavy Frigate			6	30
Fast Frigate	2	1		41
Medical Frigate	1	1	1	32
Frigate	3	2	1	92
Scout	1	2	3	61
Superscout		3		57
Destroyer	7		1	87
Super Destroyer		7	6	160
Heavy Destroyer			1	5
Fast Destroyer	1	4	10	131
CLASS II				900
Corvette	30			250
Diplomatic		5	20	150
Survey	5	20	10	500
CLASS V				1300
Fuel Carriers	15	15	16	500
Hospital Ships		5	5	150
Cargo Carriers	20	20	21	650
Tenders		2	2	48
Tugs	2	1	1	40
All Classes & Types				3137

Operations Department

-Monitoring

The eight inner Sub-Fleets (1 5 9 12 17 21 25 29) fit the role of Monitoring. Surrounding the Federation as they do, their primary task is to regulate shipping (by constant patrolling of established spacelanes), to police the behavior of Federation member systems and any enclosed hostile systems, and to have rescue vessels standing-by at all times, ready to Warp out at short notice should a distress signal be received from a stricken vessel or world (see: DISTRESS SIGNAL). As such, the Monitoring Sub-Fleets tend to be comprised of numerous small vessels for patrol duties (spaceships), and a few very fast vessels. Sub-Fleet 1 is used in the Chart as an example of a typical Monitoring Sub-Fleet.

-Exploration

The majority of the outer Sub-Fleets (2 3 4 6 7 8 10 14 15 16 18 19 20 22 23 24 26 30 28) fall into the role of Exploration. Stationed near the periphery of the Federation Treaty Zone, their primary task is to survey, map, and explore new sectors outside of the Federation - but within the Treaty Zone (see: SURVEY PROCEDURES). For this reason, Exploration Sub-Fleets tend to be comprised of larger vessels (starships), self-sufficient with regards to research facilities and capable of extended solo missions, as well as several smaller research vessels (spaceships). Sub-Fleet 3 is used in the Chart as an example of a typical Exploration Sub-Fleet.

-Interdiction

A few of the outer Sub-Fleets - those nearest the Klingon and Romulan Neutral Zones - (11 12 27 31 32) have been outfitted as Interdiction Sub-Fleets. These serve a dual role, and are virtually two Sub-Fleets each. The larger component is similar to an Exploration Sub-Fleet in composition except for upgraded ordnance and tactical capacity in its starships (Heavy Cruisers instead of Cruisers, Heavy Destroyers instead of Destroyers or Scouts). The remaining portion is composed of small, very fast spaceships, intended to patrol the very edge of the Neutral Zones. Sub-Fleet 11 is used in the Chart as an example of a typical Interdiction Sub-Fleet.

One Ascension Class Dreadnought is assigned to each Starbase, and in peacetime remains stationed there as a training/rescue vessel. In wartime however, these Dreadnoughts become the flagships of their respective Sub-Fleets, each carrying an Admiral and his Tactical Staff, each capable of concerting the offensive and defensive strategy of said Sub-Fleet and all fighting within that portion of the Quadrant.

Class 1-B Starships

On Stardate 9010.3, Starfleet had 2000 vessels of various Classes and Types operating, not including auxiliary craft. Of these vessels, 400 are Class 1-B starships, the largest and most powerful Class in the Fleet.

Cruiser: Possesses both a Primary Hull, and a separate Secondary Hull connected by a dorsal pylon - along with two or more Warp Drive Nacelles. These are the largest starships, and include such Types as:

- Dreadnought
- Heavy Cruiser
- Cruiser
- Battle Cruiser
- Command Cruiser
- Light Cruiser
- Through-Deck Carrier

Frigates: Possesses a Primary Hull and an Extended Hull - which is merely an extension of the rear of the Primary Hull - along with two or more Warp Drive Nacelles.

- Heavy Frigate
- Frigate
- Fast Frigate
- Medical Frigate

Escort: Possesses merely a Primary Hull and one or more Warp Drive Nacelles connected by a dorsal pylon. These are the smallest starships.

- Scout
- Superscout
- Destroyer
- Heavy Destroyer
- Super Destroyer
- Fast Destroyer

-Models

Starships come in three distinct Models, as determined by size: Cruiser, Frigate, and Escort:

-Types and Desirable Characteristics

Starships are further divided into various Types, such as Mark 9-B Heavy Cruiser and Mark 7-B Scout. Ships possess the characteristics which are built into them. In designing a Type, many factors must be considered and weighed against each other, so that in each case the final result is a vessel which can do the job for which that Type was intended. Although all Class 1-B starships possess a certain degree of similarity with regards to capabilities and resources, each Type must be a compromise in which

Starfleet DYNAMICS

certain desirable features are stressed at the cost of de-emphasizing others. The list of desirable characteristics includes:

Spaceworthiness: All Starfleet vessels - especially starships - must be structurally strong and sturdy, capable of withstanding such conditions as ion storms, tidal strains, and the stresses associated with sudden maneuvers and battle.

Cruising Range: To varying degrees, all starships must be capable of extended missions without replenishment of provisions or fuel - quite necessary considering the vast volume of the Treaty Zone.

Speed: Whether for rescue, pursuit, or battle, high Cruising and Emergency Maximum Speeds are essential for a starship's missions. Warp Dynamics and Power Efficiency play a pivotal role in this area.

Maneuverability: Again, for rescue work, pursuit, or battle - in varying degrees, this quality is essential.

Habitability: All spacecraft are operated by lifeforms, therefore there must be space and facilities for them to live as comfortably as possible. This is especially pertinent to starships, whose missions could be of an extended nature and range.

Ordnance: Starfleet is both the police and the military arm of the Federation Council. All Starfleet vessels have fairly impressive weapons systems with which to deal with a threat to Federation security. This is especially true of starships.

Main Types

The following is a file of the ten most numerous Class 1-b starship Types, with a short summary describing each one's particular strengths and intended missions. A notable omission is the Mark 10 Dreadnought, which has been phased-out in favour of the Mark 21-B *Conquest* Class Dreadnought - and in further anticipation of the Mark 25 *Excelsior* Class Battleship coming into mass service next century.

It should be noted that although only one Class-ship per Type is shown herein, more than one can exist. The more ships within a Type are built, the more Starfleet R & D tends to play around with the design, making subtle changes. An example of this is the Heavy Frigate Type. Originally, 38 *Adventure* Class Heavy Frigates were constructed. As time went by, improvements to the design were experimented with, and the *Miranda* was rebuilt/refitted to test these changes. Starfleet was so impressed with the

improvements that they ordered 21 more *Adventure* Class Heavy Frigates converted to the *Miranda* design; and so a new Class was created, named after the first Heavy Frigate to be so modified: the *Miranda* Class. Later, modifications to the *Miranda* Class were incorporated in a new vessel: *Cyane*, which is now the first ship of the *Cyane* Class. Thus there are now two Classes within the Heavy Frigate Type (all *Adventure* Class Heavy Frigates have been converted, eliminating that Class). Of these two, only the *Miranda* Class has been shown here, as it is the most numerous.

Specializing Types

Some Class 1-B starships are designed for special functions or to fit a specific need in overall fleet logistics - as perceived by Starfleet Command. However, it is stressed that as Class 1-B starships, they are capable of fulfilling all of the various tasks which their sister Main Type ships are. But it is within their own particular specialty that they truly shine. They are proven designs, but only a few vessels of their Type are ever intended for construction.

Starship Characteristics:

- COM - Complement
- DWT - Deadweight Tonnage
- OAL - Overall Length
- OAD - Overall Draft
- OAB - Overall Beam
- CSP - Cruising Speed
- FSP - Flank Speed
- ESP - Emergency Maximum Speed
- ORD - Ordnance

Operations Department

-Mark 21-B Conquest Class Dreadnought

A built-up version of the Mark 20-B, the Mark 21-B has helped to eliminate the Mark 10. Long range coupled with truly high speed capabilities make the Mark 21-B ideal for investigating trouble spots throughout the Treaty Zone - as they happen. This makes it ideal for emergency rescue operations. Each Mark 21-B has been outfitted as a flagship, and they are dispersed throughout the Fleet, with one stationed at each Starbase.

COM= Officers - 80
= Enlisted - 450
DWT= 239,000 mt
OAL = 300.8 m
OAD= 74.1 m
OAB= 141.7 m
CSP = wf 8.5
FSP = wf 10.7
ESP = wf 13.0
ORD= Phasers - 14 [7 Banks]
= Pho-Torp - 2 Tubes

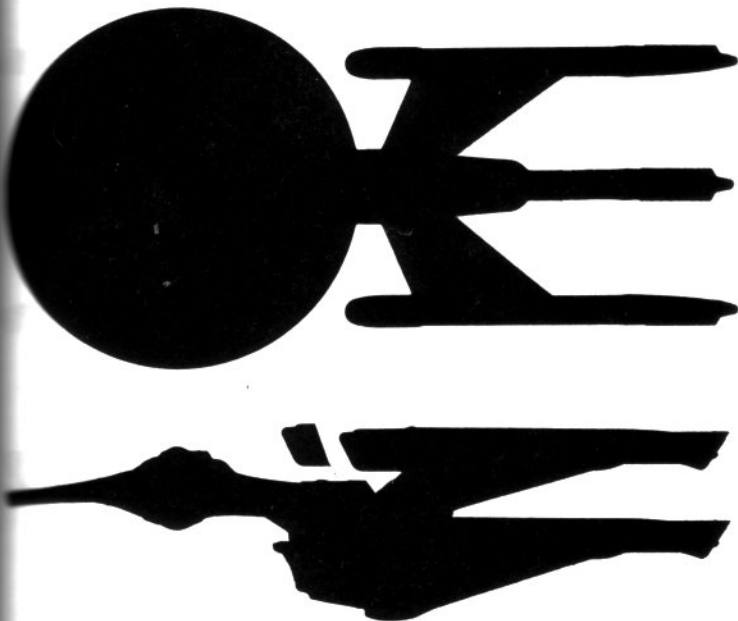
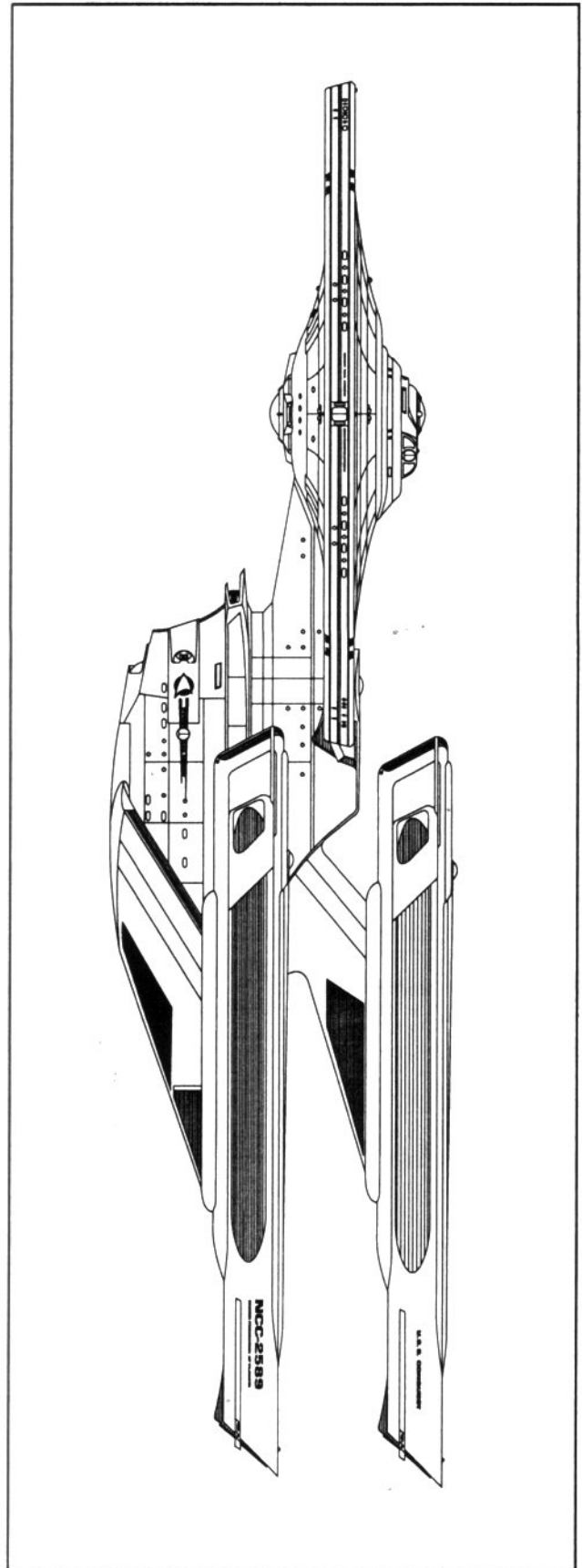

Starfleet DYNAMICS

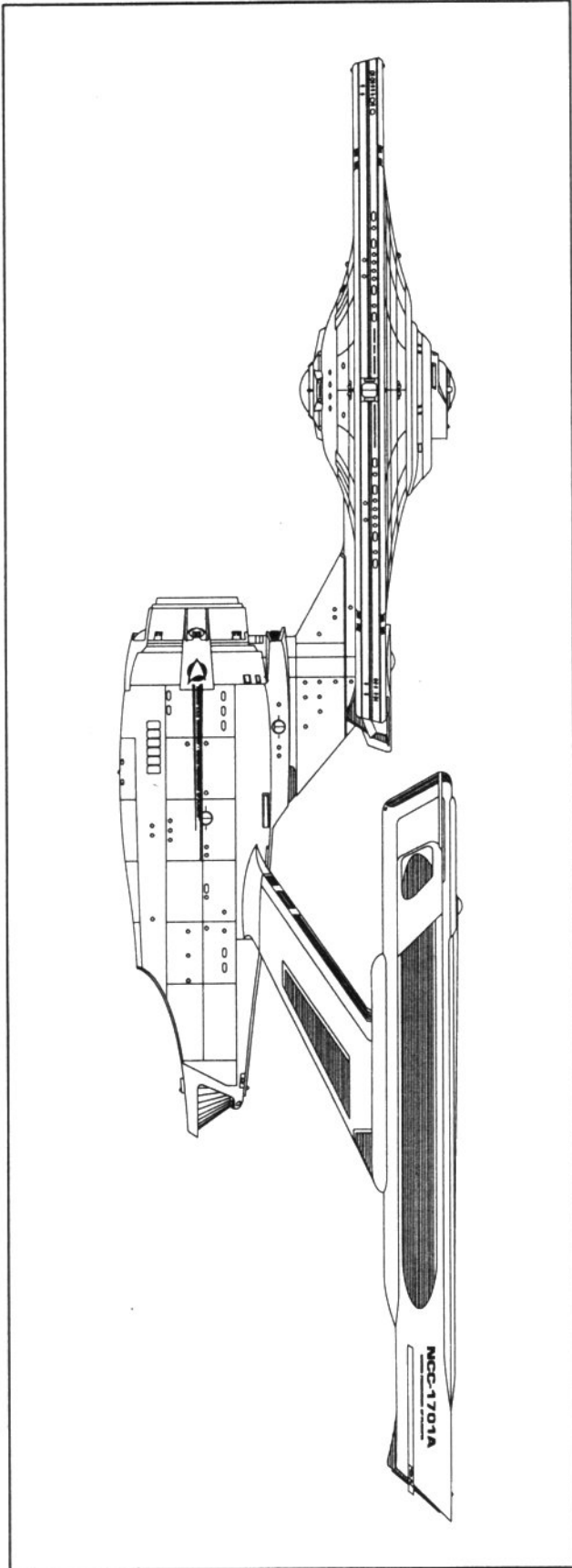

-Mark 9-B Enterprise Class Heavy Cruiser

Possessing the best Warp Dynamics yet engineered into a starship, the Mark 9-B's high Cruising Speed, long range, impressive ordnance, and habitability make it the natural choice for extended exploratory missions throughout the unknown reaches of the Treaty Zone. Like the Constitution Class it was retrofitted from, the Enterprise Class Heavy Cruiser design is most noted for its survivability.

COM= Officers - 72
= Enlisted - 428
DWT= 200,000 mt
OAL = 304.8 m
OAD= 71.3 m
OAB= 141.7 m
CSP = wf 8.0
FSP = wf 10.2
ESP = wf 12.0
ORD= Phasers - 18 [12 Banks]
= Pho-Torp - 2 Tubes

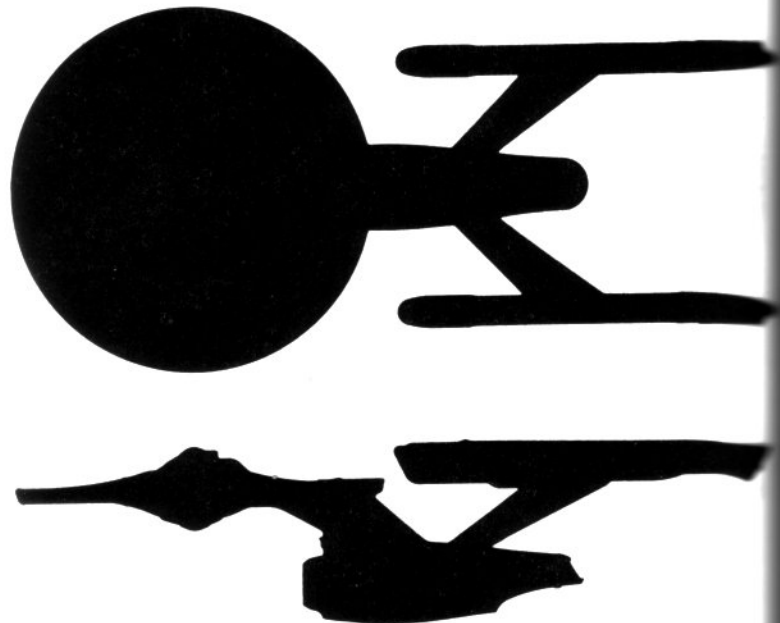

Operations Department

-Mark 20-B Dahlgren Class Cruiser

The Mark 20-B is basically a Mark 9-B with a smaller Secondary Hull. The Mark 20-B thus adds improved maneuverability to the Mark 9-B's admirable traits, with a slight penalty in range. It has been found to be ideal for patrol duties along the Klingon and Romulan Neutral Zones, as its maneuverability gives it the edge over the Klingon K'Tinga Class Battlecruiser.

COM= Officers - 68
= Enlisted - 400
DWT= 183,000 mt
OAL = 290.0 m
OAD= 65.9 m
OAB= 141.7 m
CSP = wf 8.1
FSP = wf 10.3
ESP = wf 12.0
ORD= Phasers - 15 [8 Banks]
= Pho-Torp - 2 Tubes

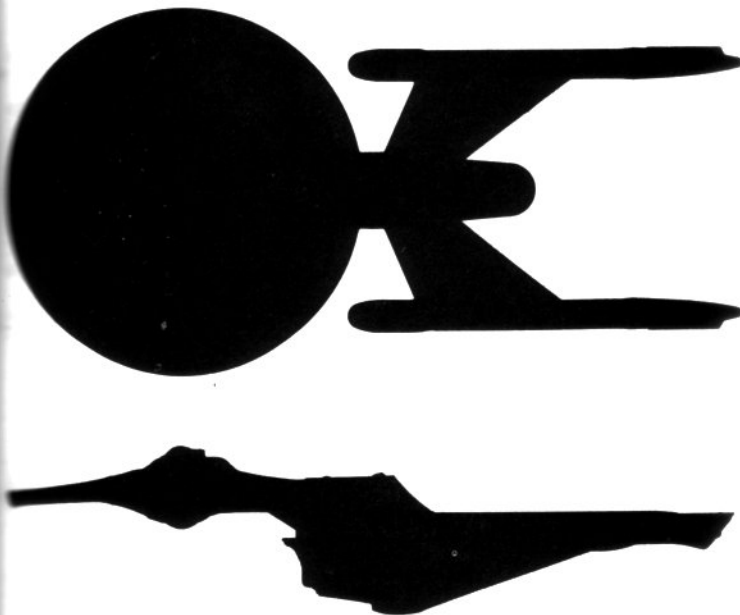
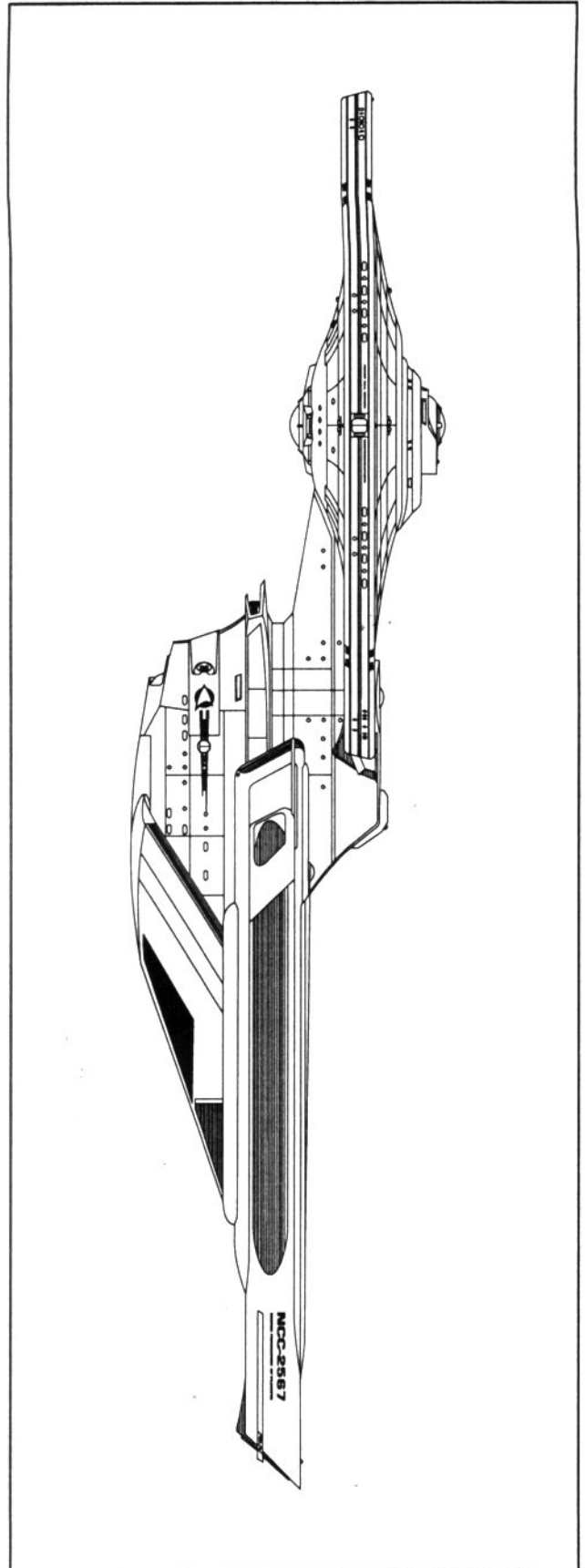

Starfleet DYNAMICS

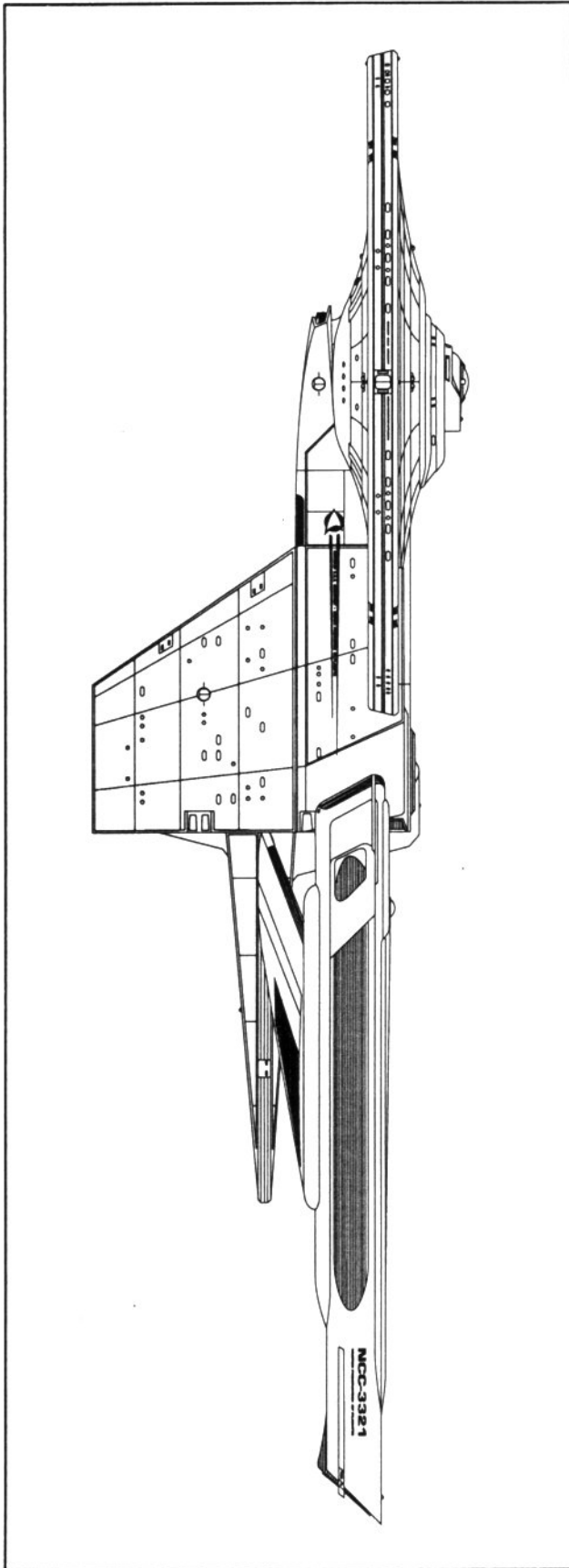

-Mark 13-B Constant Class Battlecruiser

Conceived as an answer to the new Klingon K'tommkli Class Destroyer. Similar in warp dynamics - if not appearance - to the Mark 9-B, the Mark 13-B was intended to be able to operate totally autonomously in wartime, and is specially designed to be less susceptible to enemy firepower due to its incredible maneuverability and its simplified, extensive shielding grids. The enormous Secondary Hull has two complete Hangars - one at the upper forward position for General-purpose Auxiliary Craft, and one at the lower-aft position for Marine Assault Craft. The Secondary Hull also serves as the Barracks for the Marine Company.

COM= Officers - 40
= Enlisted - 265
DWT= 173,000 mt
OAL = 307.5 m
OAD= 78.0 m
OAB = 141.7 m
CSP = wf 8.1
FSP = wf 10.1
ESP = wf 11.8
ORD= Phasers - 16 [8 Banks]
= Pho-Torp - 2 Tubes

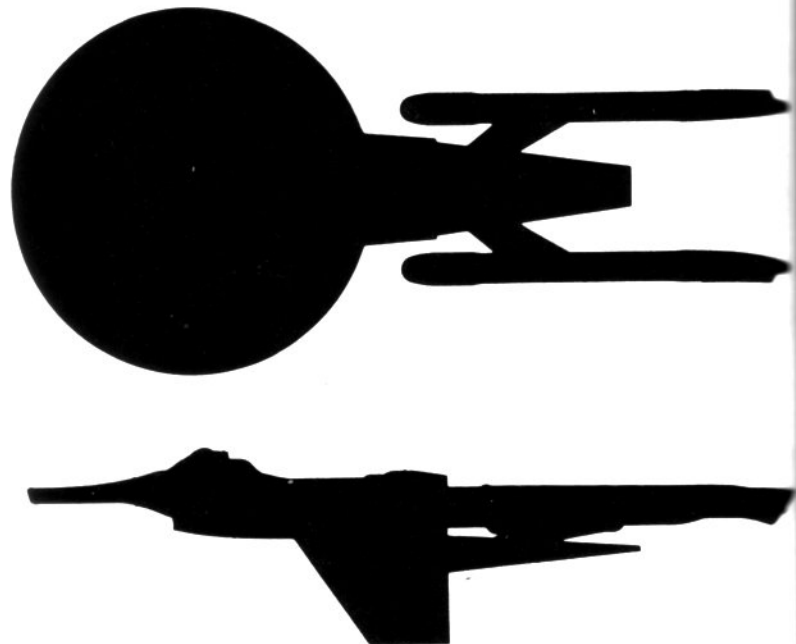

Operations Department

-Mark 22-B Valor Class Strike Cruiser

Designed to operate as a Starfleet Infantry Transport, holding and deploying 2 Companies and their Assault-landing Shuttlecraft. Like the Battlecruiser, it is intended to operate without escorts (Destroyers), and thus carries Marine Assault Fighters (Tomohawks) within its upper port Hangar, Starfleet Interceptors (Talons) within its upper starboard Hangar, and a regular complement of General-purpose Auxiliary Craft within the third Hangar at the rear of the Secondary Hull.

COM= Officers - 70
= Enlisted - 420
DWT= 193,000 mt
OAL = 290.0 m
OAD= 67.9 m
OAB= 141.7 m
CSP = wf 7.7
FSP = wf 10.0
ESP = wf 11.7
ORD= Phasers - 14 [7 Banks]
= Megaphasers - 2
= Pho-Torp - 2 Tubes

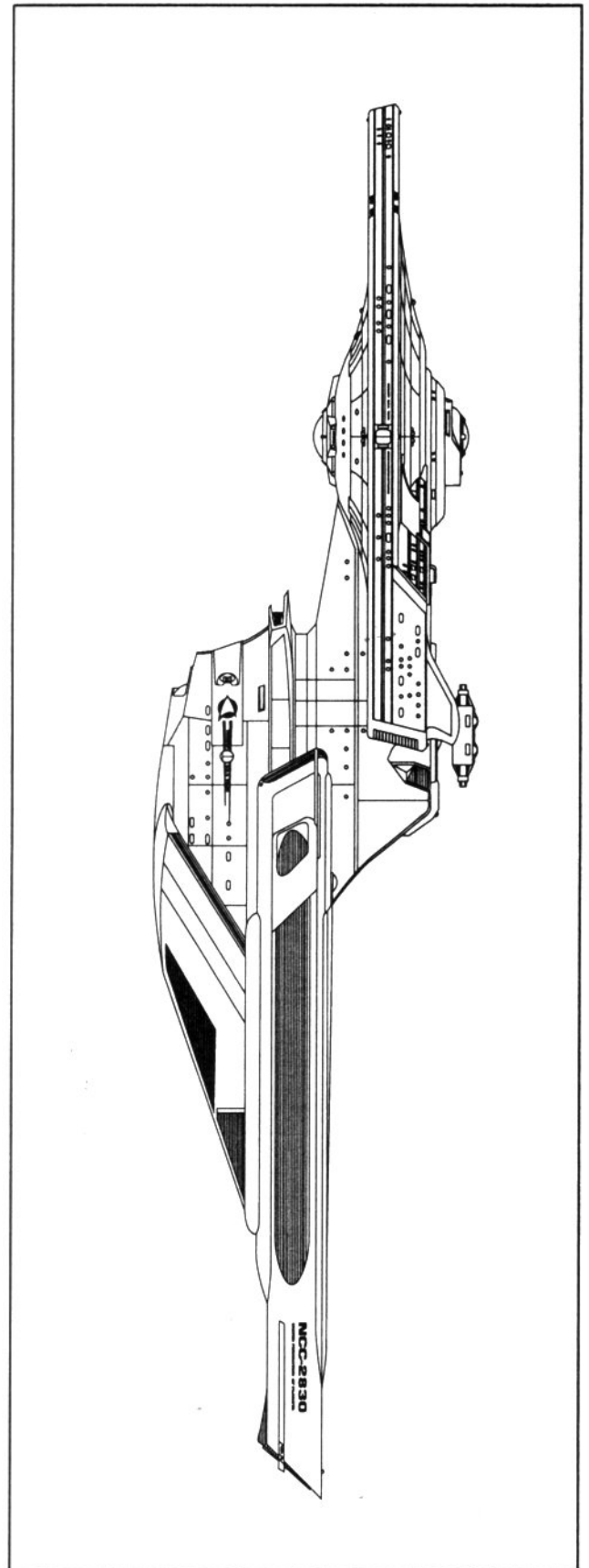
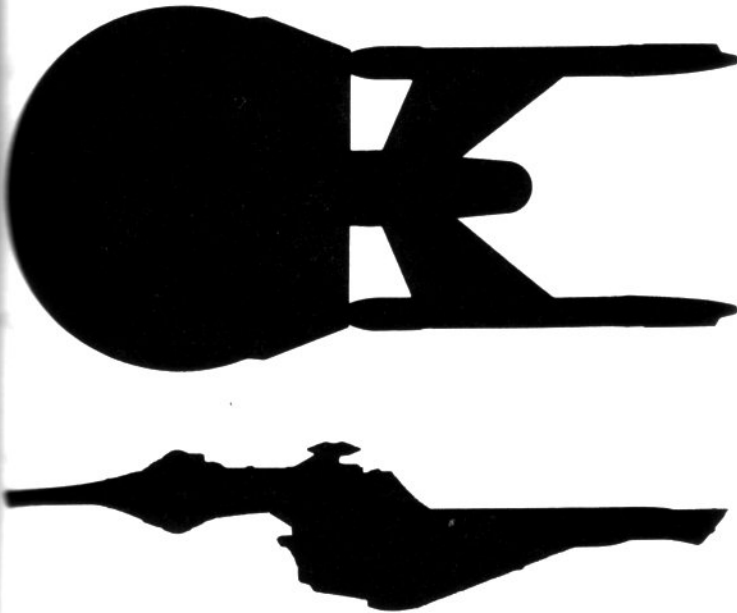

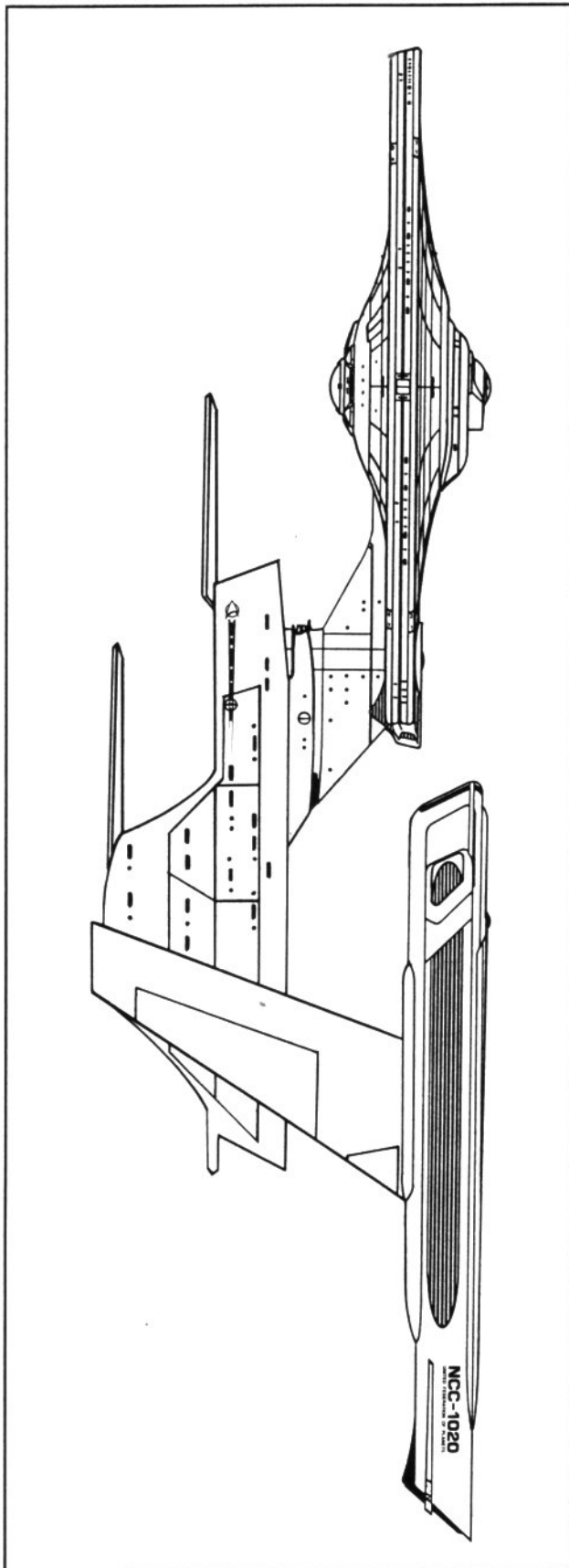

-Mark 27-B Guam Class Through-Deck Carrier

Designed to deliver two complete squadrons (25 each) of Tomohawk attack-craft to any battle zone, and then to serve same as a support base. A special feature in this design is the through-deck Hangar - built so that Tomohawk fighters can land, refuel/re-arm, and launch with minimal time away from station. The lower landing-only Hangar leads to the Parking Bay. Both Landing Bays feature outboard Landing Platforms - further decreasing turnaround time.

- COM = Officers - 90
- = Enlisted - 300
- DWT = 220,000 mt
- OAL = 304.8 m
- OAD = 81.6 m
- OAB = 141.7 m
- CSP = wf 6.5
- FSP = wf 8.8
- ESP = wf 10.3
- ORD = Phasers - 14 [7 Banks]
- = PhoTorp - 2 Tubes

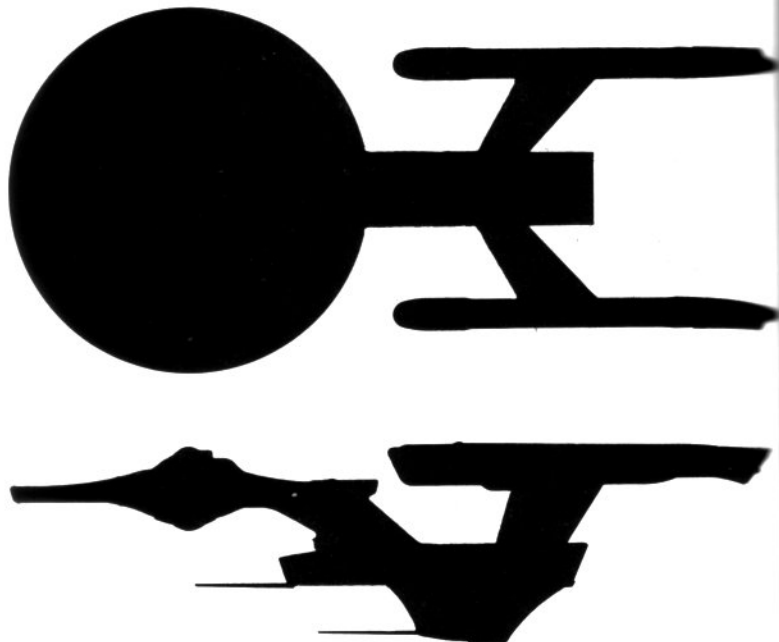

Operations Department

Mark 24-B Rickover Class Fast Frigate

Conceived as the Frigate version of a Dreadnought, this design features a third under-slung Warp Drive nacelle, achieving moderately better speeds than the Mark 11-B without sacrificing the Hangar facilities - at the cost of range (due to increased fuel expenditure due to decreased efficiency). It is possible (following extensive studies of the logistic advantages/disadvantages) that all Heavy Frigates will be modified to this design.

COM = Officers - 75
= Enlisted - 350

DWT = 191,000 mt

OAL = 236.0 m

OAD = 75.0 m

OAB = 141.7 m

CSP = wf 8.1

FSP = wf 10.3

ESP = wf 12.1

ORD = Phasers - 12 [6 Banks]
= Megaphasers - 2
= Pho-Torp - 4 Tubes

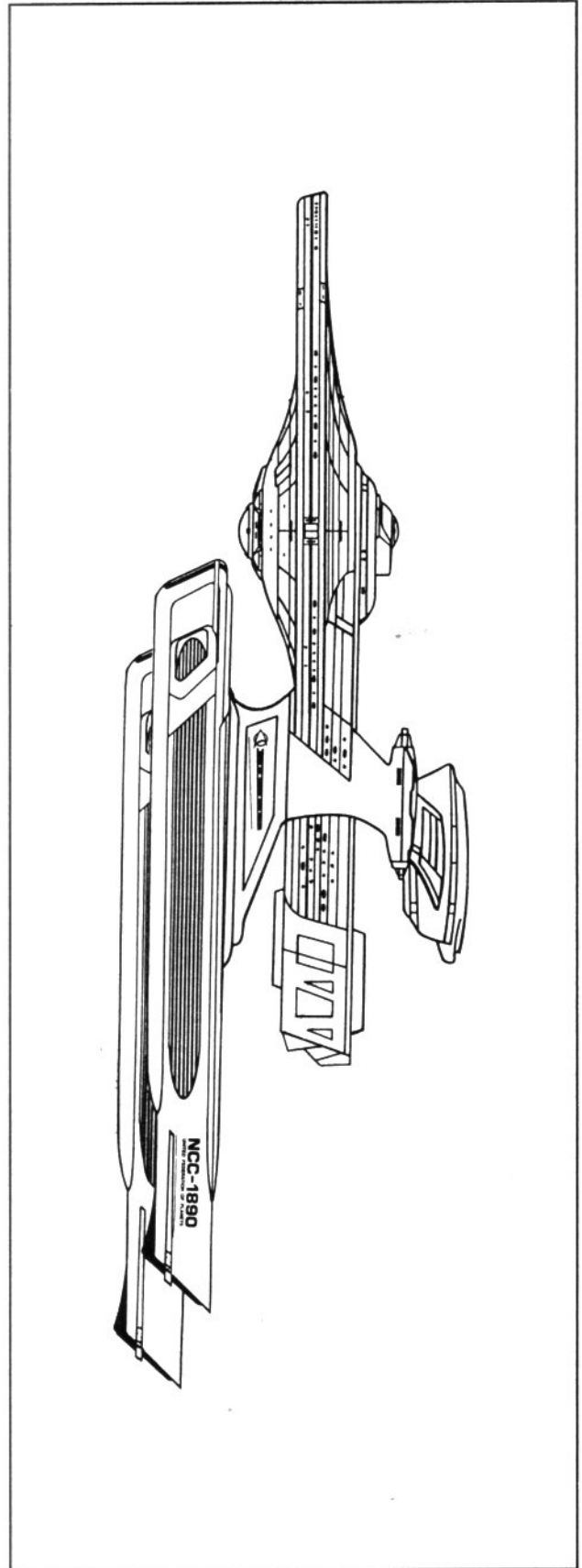
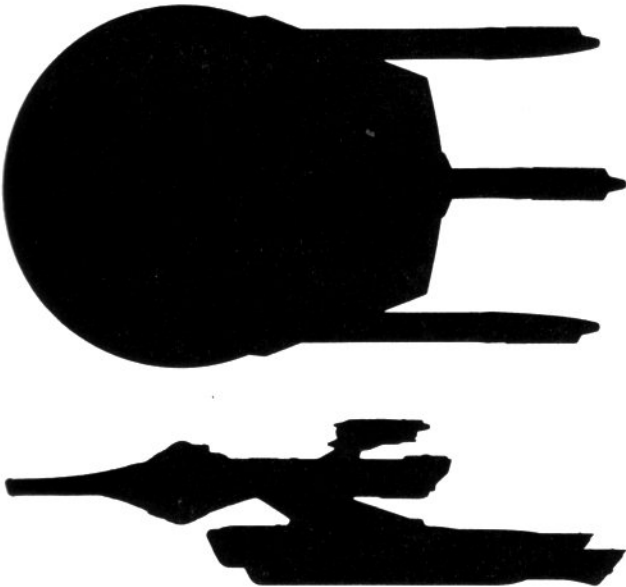

Starfleet DYNAMICS

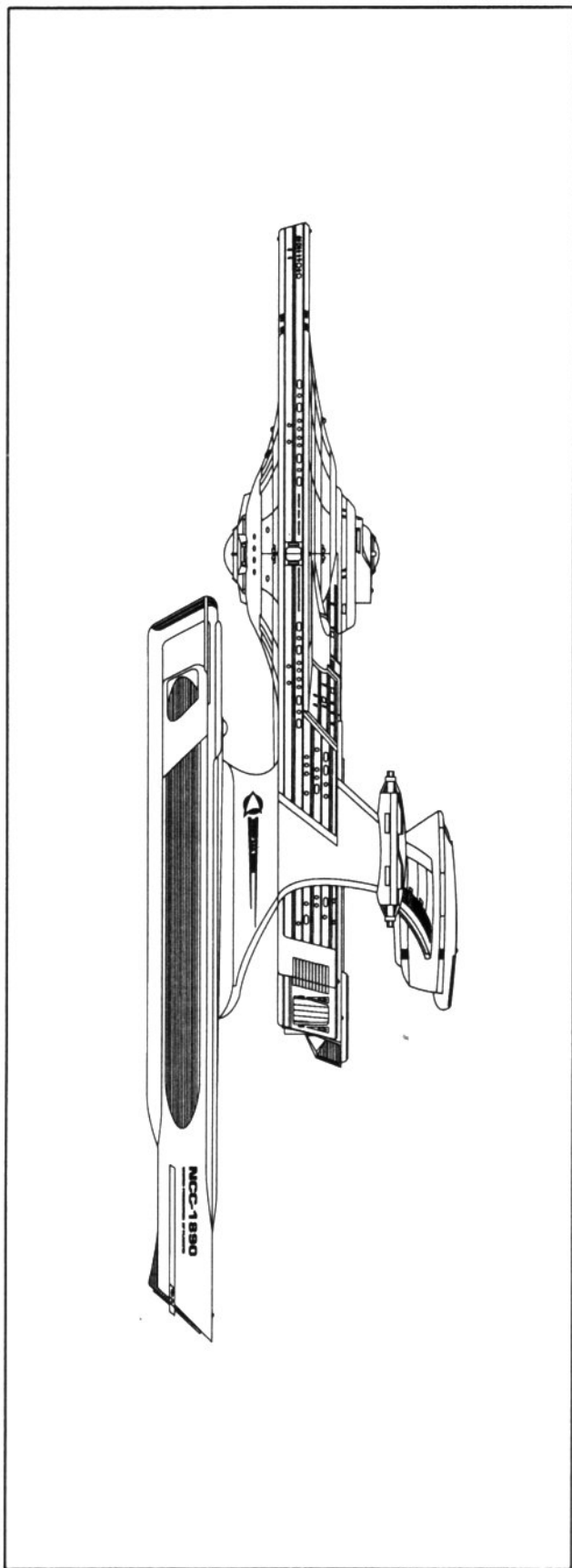

-Mark 11-B Miranda Class Heavy Frigate

Smaller but slower than the Mark 20-B, the Mark 11-B possesses increased fire-power, added to the enormous Hangar facilities (around which the vessel is designed). These Hangars allow it to carry and deploy a squadron of Killer-Bee attack-craft. Ideal for patrolling the various small Neutral Zones within the Federation Treaty Zone (there are more than 200 of these).

COM= Officers - 75
= Enlisted - 335
DWT= 165,000 mt
OAL = 236.0 m
OAD= 67.8 m
OAB= 141.7 m
CSP = wf 7.0
FSP = wf 9.2
ESP = wf 11.5
ORD= Phasers - 12 [6 Banks]
= Pho-Torp - 4 Tubes

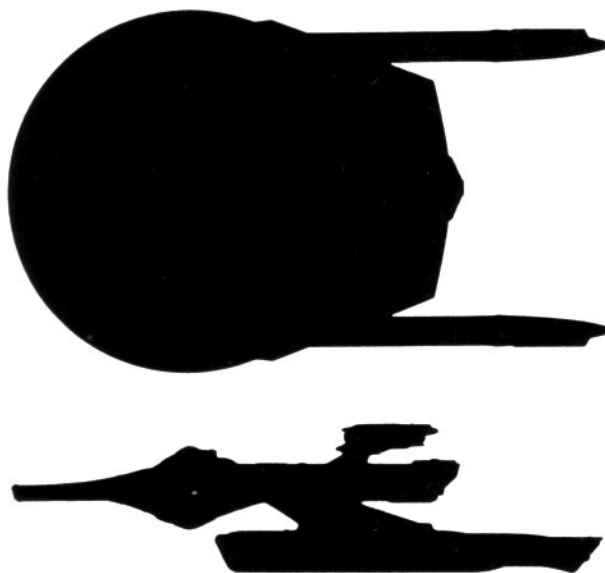

Operations Department

-Mark 12-B Exultant Class Frigate

A stripped-down Mark 11-B, the Mark 12-B has increased speed and even greater maneuverability. Although lacking Photon Torpedo Tubes, the presence of Magaphasers makes it a good launch platform for its half-squadron of Killer Bees. It is used primarily for missions similar to the Mark 11-B, but closer in towards the Federation. Some models of the Frigate feature outboard Landing Platforms - freeing parking space within the Hangar.

COM= Officers - 53
= Enlisted - 317
DWT= 142,000 mt
OAL = 258.7 m
OAD= 49.9 m
OAB= 141.7 m
CSP = wf 7.5
FSP = wf 9.7
ESP = wf 11.5
ORD= Phasers - 12 [6 Banks]
= Megaphasers - 2

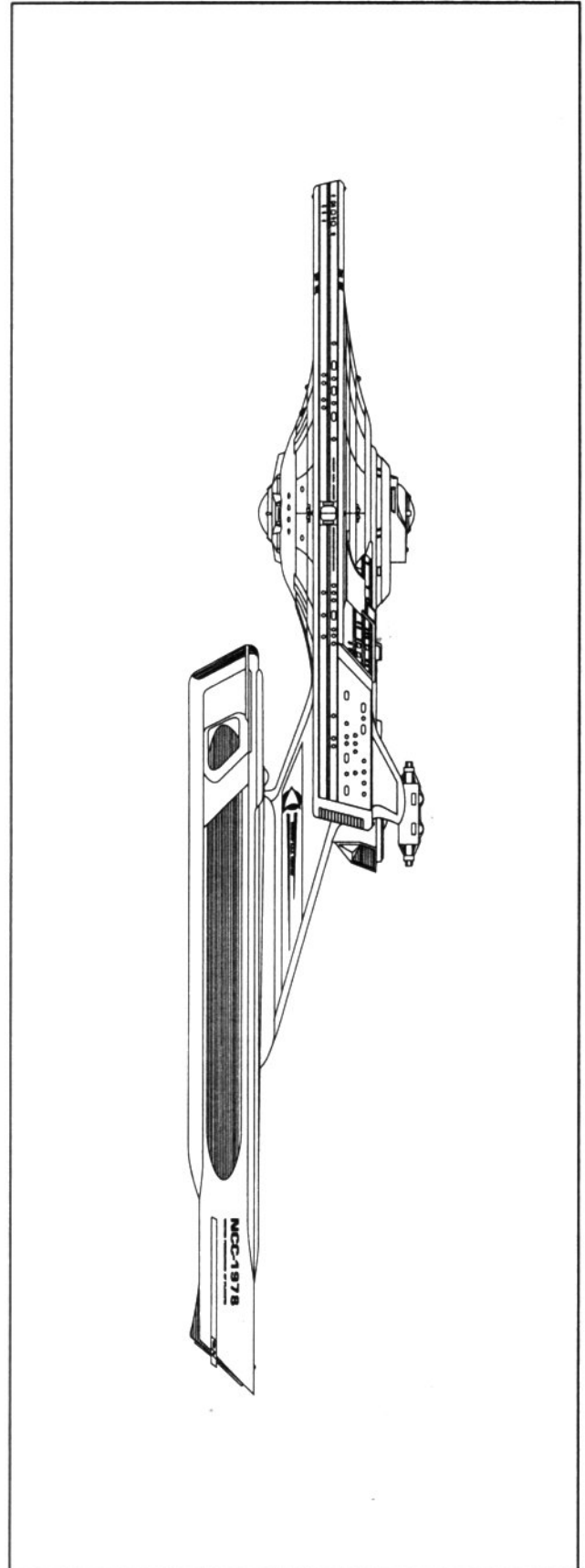
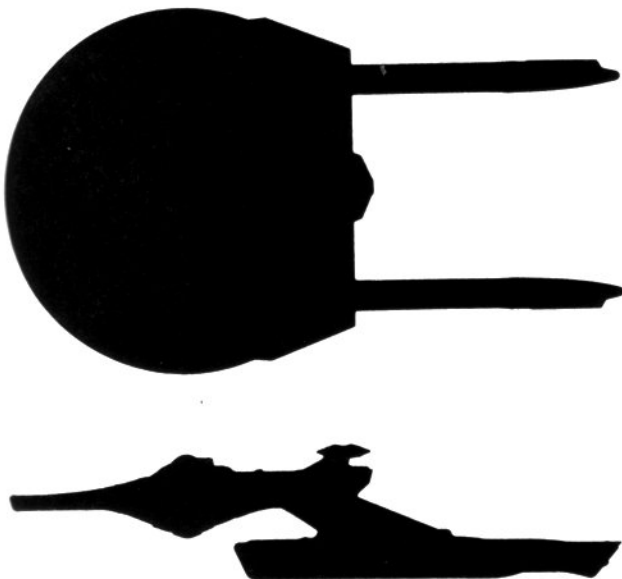

Starfleet DYNAMICS

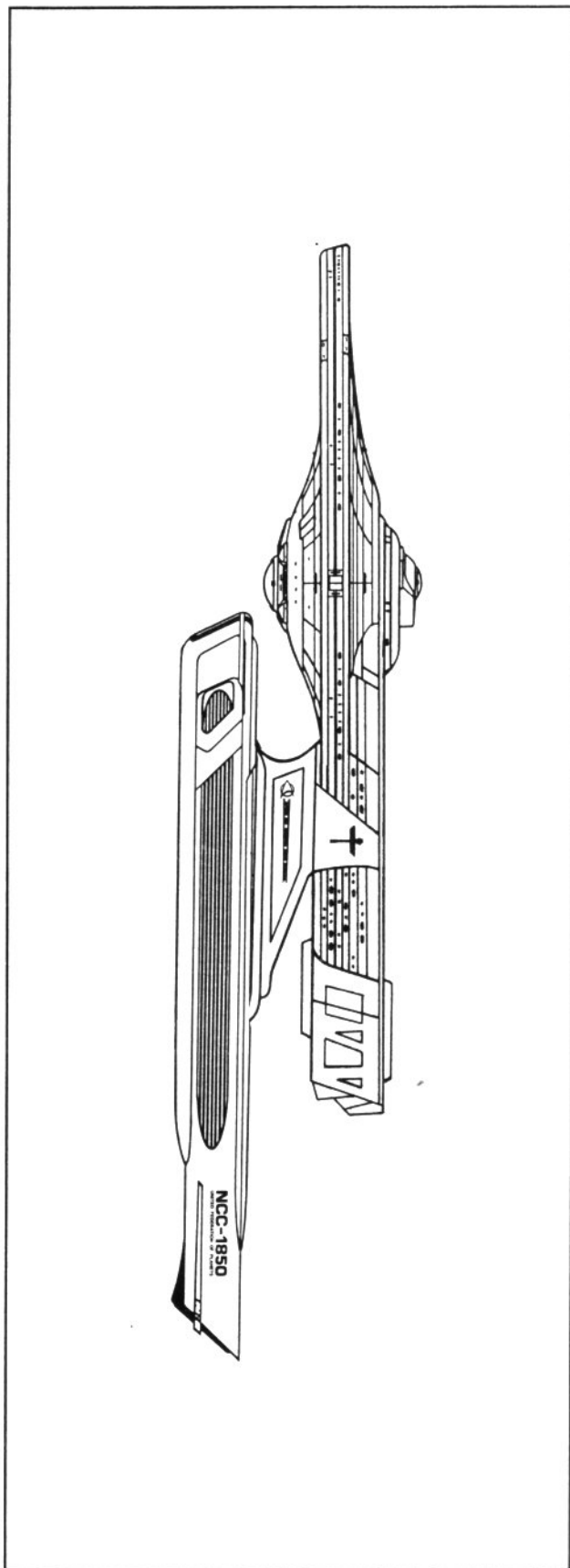

-Mark 14-B Hippocrates Class Medical Frigate

The basic structure of the Mark 14-B is similar to that of the Mark 11-B, the external differences being: removal of all outside ordnance and roll-bar, removal of starboard hangar bay. Internally the differences are more pronounced, with 25% of the internal volume being dedicated to lab facilities. As such, it is ideally suited for the rapid identification and alleviation of planet-wide plagues and epidemics. The area normally taken up by the starboard hangar has been replaced with an enormous, multi-level ward, while the remaining hangar has specially modified ambulance shuttles.

COM = Officers - 75
= Enlisted - 350
DWT = 170,000 mt
OAL = 236.0 m
OAD = 53.0 m
OAB = 141.7 m
CSP = wf 7.0
FSP = wf 9.1
ESP = wf 11.4

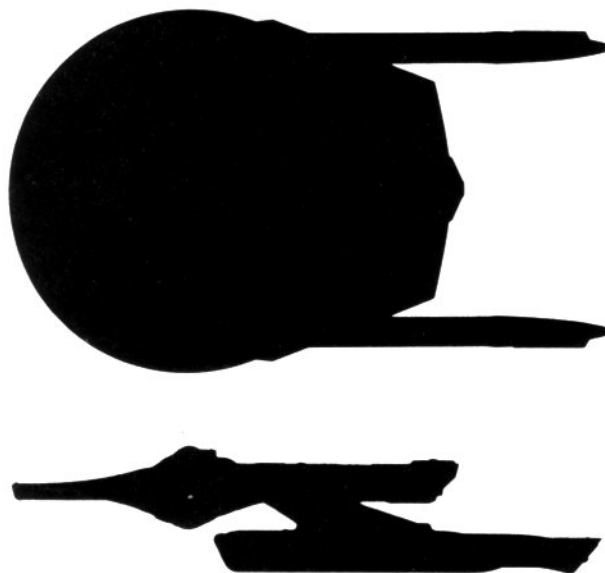

Operations Department

Mark 7-B Monoceros Class Scout

Small, extremely maneuverable, and fast, the Mark 7-B is used principally to escort diplomatic and cargo convoys traveling off the major space-lanes, and is rarely deployed on solo missions. In wartime, this vessel comes into its own. Recently refitted with the new OC5889S Sensor Array on its upper primary hull (a much larger and more powerful version of the OC4221U on the lower surface of every Starship's primary hull), at least one Mark 7-B accompanies every Flagship, acting as its ultra-long range eyes. Since the emissions of the Active Sensors are an obvious target for enemy ships seeking a convoy or Sub-Fleet, the OC5889S is normally powered-down, and the OC4221U system used..

COM = Officers - 30
= Enlisted - 250
DWT = 101,000 mt
OAL = 200.0 m
OAD = 60.1 m
OAB = 141.7 m
CSP = wf 7.4
FSP = wf 9.1
ESP = wf 10.9
ORD = Phasers - 12 [6 Banks]

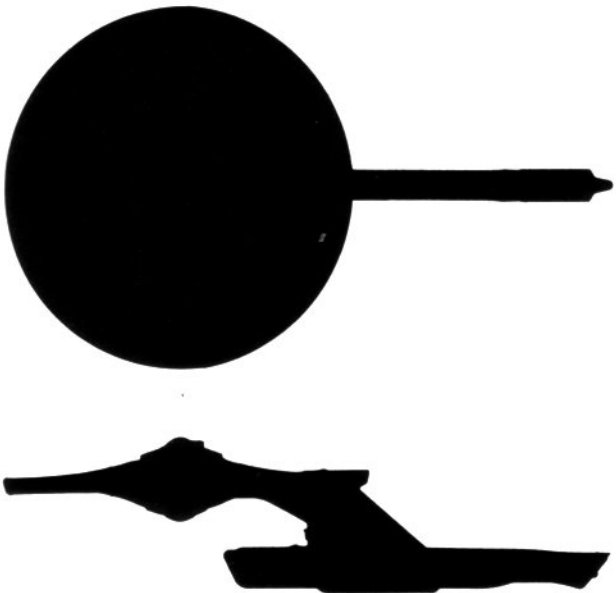
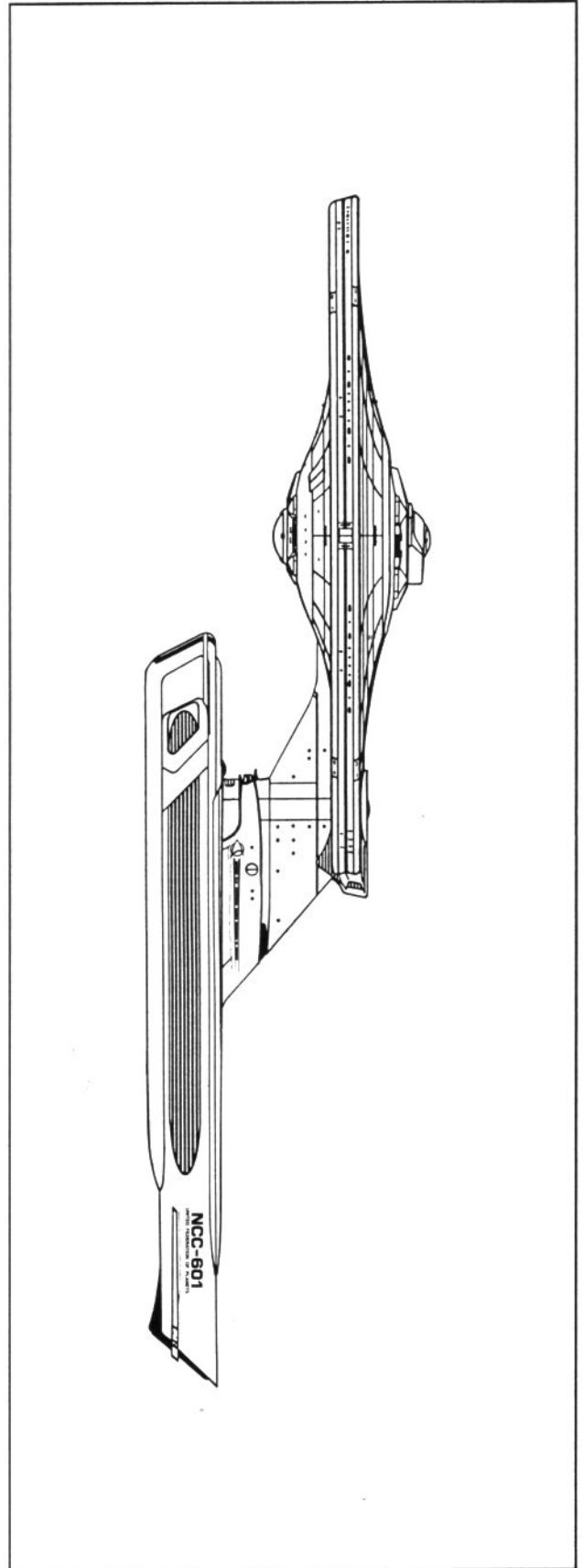

Starfleet DYNAMICS

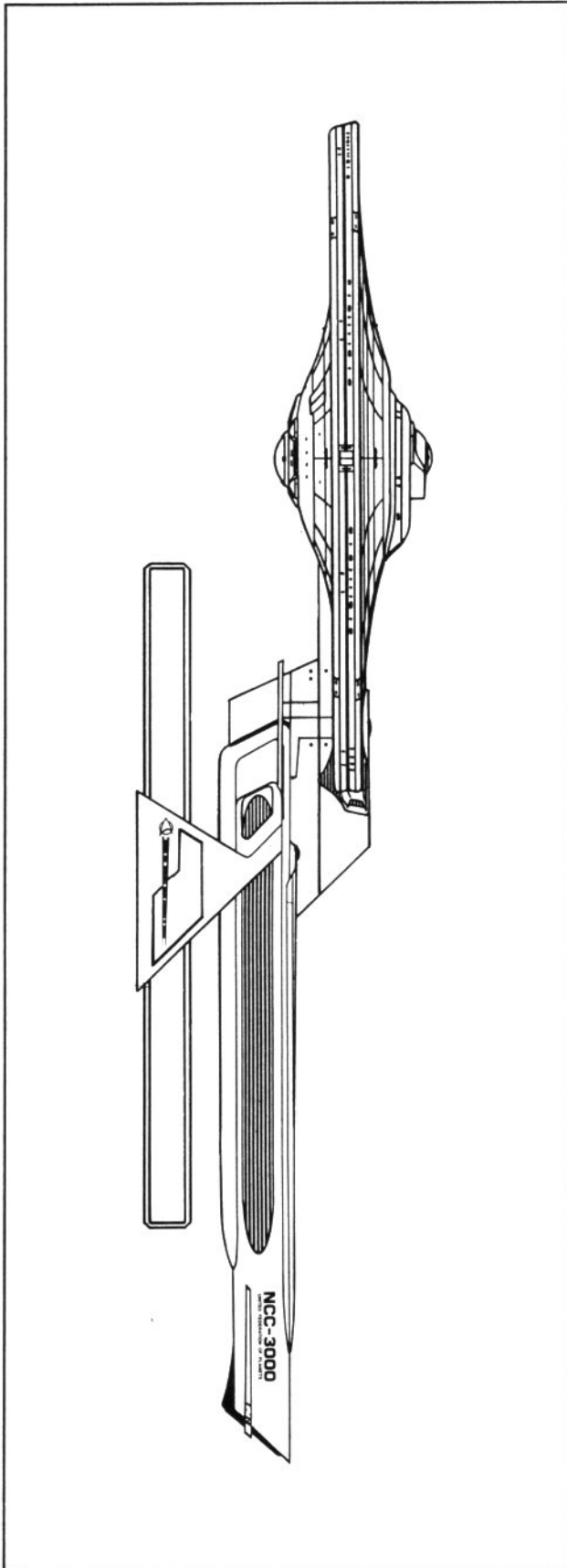

-Mark 30-B Kestral Class Superscout

Embodies the concept of the Scout - carried all the way. The revolutionary inboard-tandem twin nacelle design allows maximum emergency speeds unheard-of in so small a vessel- at the cost of maneuverability, and allows the starship to infiltrate enemy space and evade enemy patrols while gathering sensor intelligence. The Enormous OC9777W Passive "Big Ear" Sensor Nacelle enable the Superscout to detect distant enemy ships via their warp drive fields, and to eavesdrop on their communications. For this reason, the Superscout carries a large contingent of cryptographic technicians and computers.

COM = Officers - 30
= Enlisted - 260
DWT = 135,000 mt
OAL = 276.8 m
OAD = 61.4 m
OAB = 141.7 m
CSP = wf 7.8
FSP = wf 10.2
ESP = wf 11.9
ORD = Phasers - 12 [6 Banks]

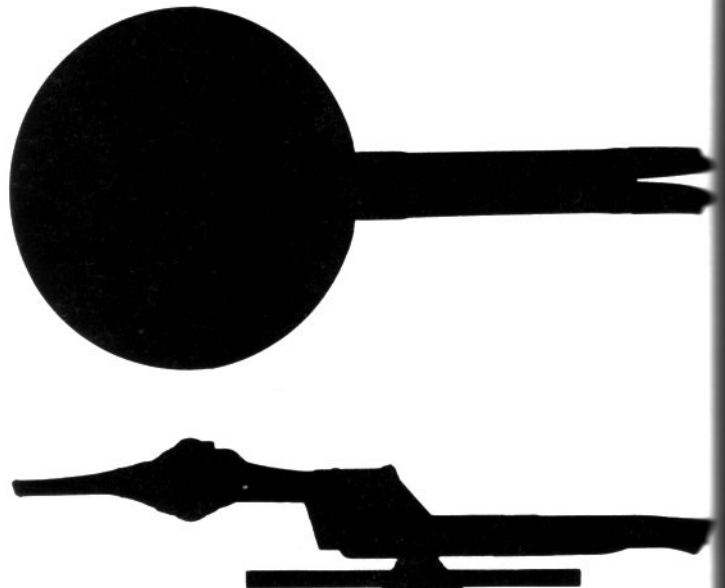

Operations Department

-Mark 8-B Siva Class Destroyer

Possessed of the same structure and characteristics as the Mark 7-B (with the exception of the massive Sensor Array), the Mark 8-B adds increased ordnance via Photon Torpedo Tubes. It is used primarily to patrol major spacelanes. In wartime, the Mark 8-B is utilized to escort Sub-Fleets, and to prosecute/kill any enemy vessels threatening other, more valuable ships.

COM = Officers - 35
= Enlisted - 265
DWT = 100,000 mt
OAL = 200.0 m
OAD = 60.9 m
OAB = 141.7 m
CSP = wf 7.5
FSP = wf 9.3
ESP = wf 11.0
ORD = Phasers - 12 [6 Banks]
= Pho-Torp - 2 Tubes

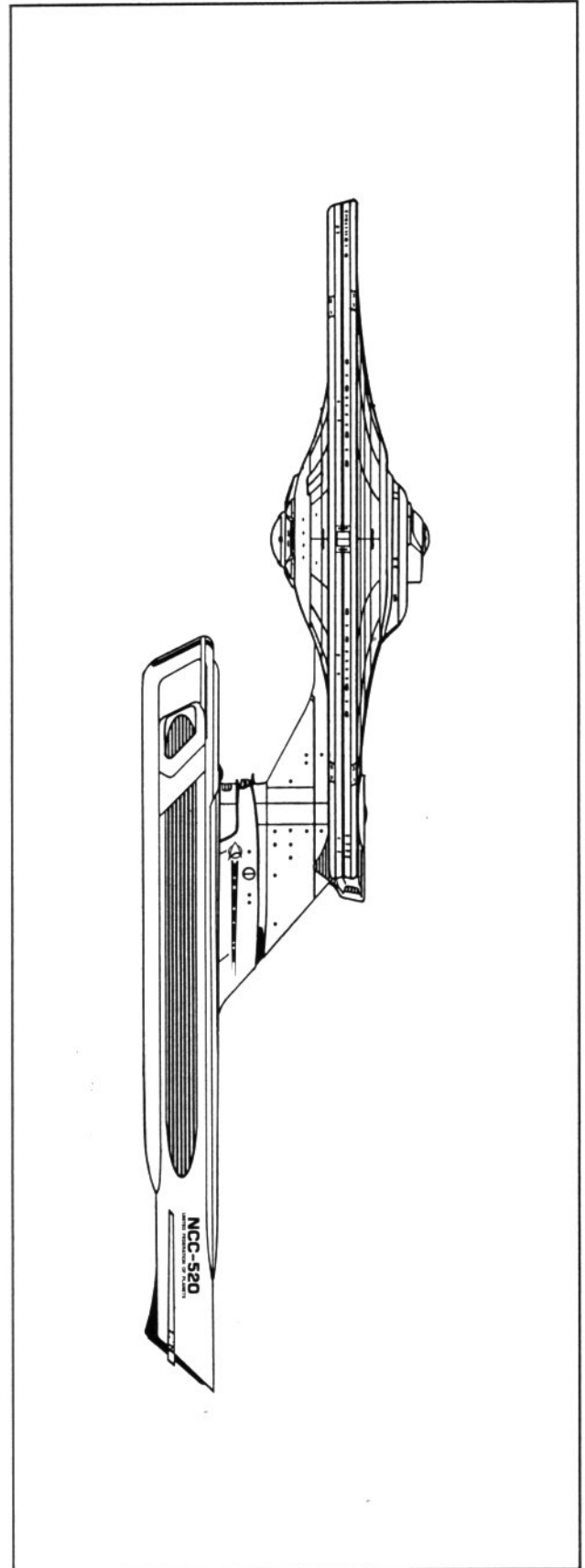
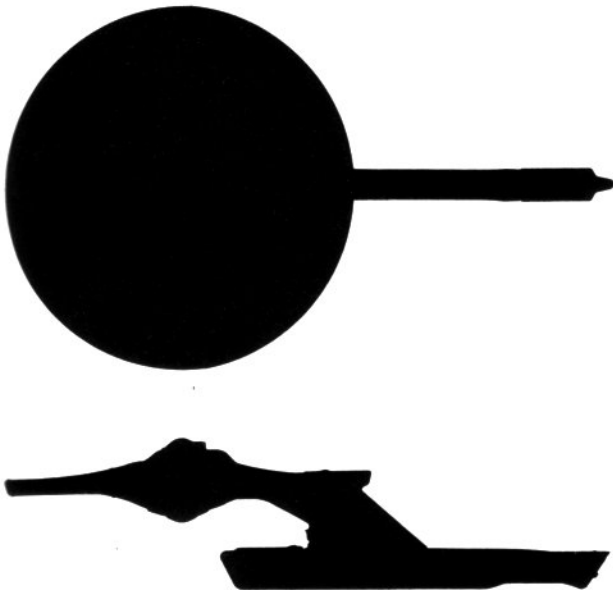

-Mark 18-B Warlord Class Heavy Destroyer

A built-up Mark 8-B, adding rear-facing Photon Torpedo Tubes and a single Megaphaser. A smaller, second Matter Antimatter Reactor within the primary hull is intended solely to power the Megaphaser. Although slightly slower than the Mark 8-B, the Mark 18-B is also used in that same role.

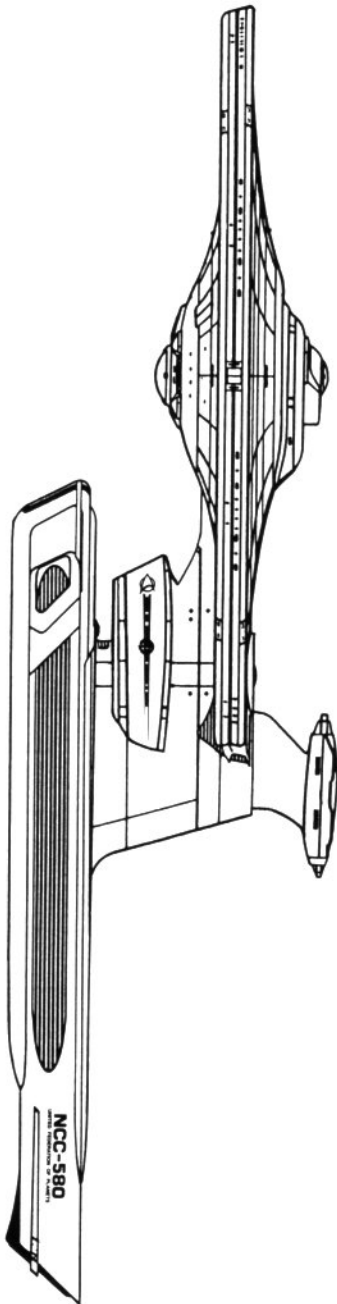

- COM = Officers - 40
= Enlisted - 285
- DWT = 130,000 mt
- OAL = 200.0 m
- OAD = 70.3 m
- OAB = 141.7 m
- CSP = wf 7.3
- FSP = wf 9.2
- ESP = wf 10.9
- ORD = Phasers - 12 [6 Banks]
= Megaphasers - 1
= Pho-Torp - 4 Tubes

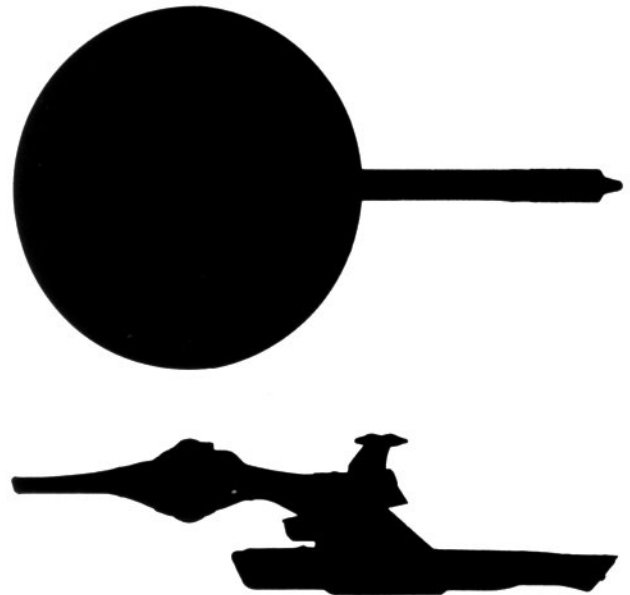

Operations Department

Mark 31-B Thunderbolt Class Fast Destroyer

Identical to the Mark 8-B except for the addition of a second Warp Drive nacelle in tandem to the first, giving a much higher Emergency Speed at the expense of lower power to ordnance and a markedly reduced range. The *Thunderbolt* Class is also sometimes known as the Quick-Response Destroyer, because of its ability to race to any trouble scene.

COM = Officers - 35
= Enlisted - 270
DWT = 125,000 mt
OAL = 200.0 m
OAD = 70.0 m
OAB = 141.7 m
CSP = wf 8.3
FSP = wf 10.5
ESP = wf 12.4
ORD = Phasers - 12 [6 Banks]
= Pho-Torp - 2 Tubes

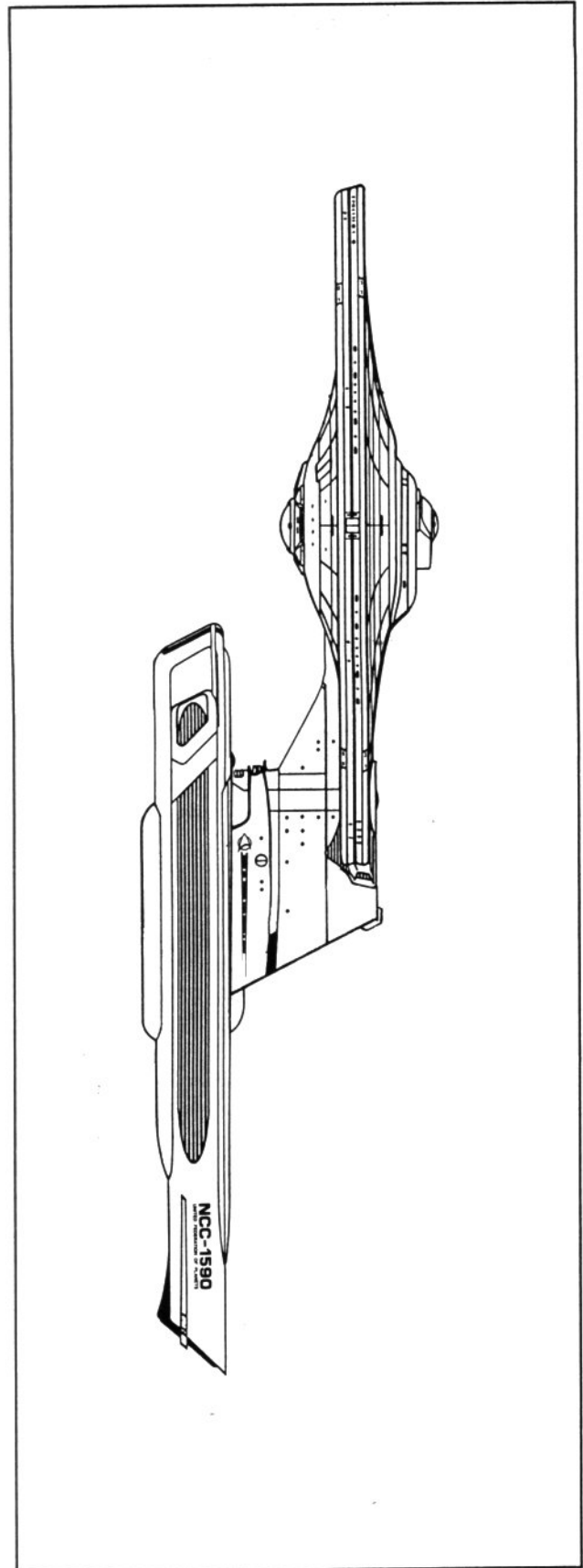
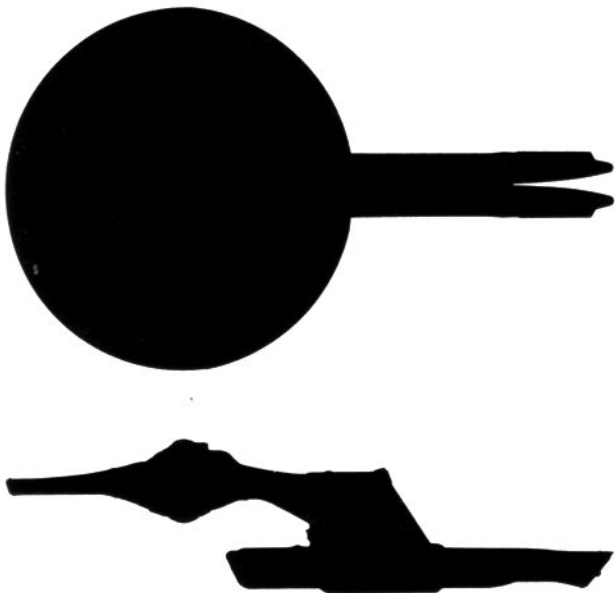

Starfleet DYNAMICS

Prototypes

In addition to the Main and Specialized Types of Class 1-B starships presently utilized by Starfleet, there are also a number of experimental designs - prototypes. Most are one-of-a-kind vessels being tested for spaceworthiness.

Every design is first conceived as a list of new payload and/or performance requirements being brought to the attention of Starfleet R & D by the Admiralty. From there, the next step is to plot the design within a Holographic Design Tank. Following this is the Phantom Test Stage. This involves creating within the R & D computers an exact - though non-existent - electronic analogue model of the newly designed craft, accurate with respect to outer hull shape, internal densities, masses, and energy flows. This Phantom is then subjected to a series of tests within the computer, to check out such characteristics as maneuverability, speed, and warp dynamics. Properly programmed, the Phantom will behave very similarly to an actual craft, and allows a design to be tested to its limits (destruction test) while the operators are in perfect safety. Moreover, if a design flaw is detected during the Phantom Test, the flaw can be redesigned and reprogrammed into the Phantom's structure. In such a way a new vessel can be perfected before it is ever built, with its parameters and maximum performance levels estimated.

Eventually a new design will have satisfied every Phantom Test possible, and the time will approach when the design must be seriously considered. The proposal will be returned to the Admiralty along with the estimated parameters, and a decision must be made on whether or not the design warrants further development, weighing desired characteristics against final specifications. Should the design meet with favor, the Starfleet Commander will get funding approval from the Federation Security Council for the building of a prototype.

The Starfleet Supra-San Francisco Orbital Yards have a large supply of moth-balled primary hulls - left over from the de-commissioning of the Tug Type. Using one of these (and updating it at the same time to a Class 1-B design), a prototype will be constructed. Prototype construction generally takes about twenty months, which includes the simultaneous refitting of the primary hull. Once completed, the new vessel is boarded by a specially-trained Test Crew comprised of engineers and personnel from the Starfleet Corps of Engineers and Research & Development. These personnel take the prototype on its shake-down cruise, which is intended to strain the vessel near the computer-predicted limits, and point-out any deviations from the Phantom-predicted performance. After a return to the Yards for final repairs, the vessel is certified.

Once a prototype has passed its shake-down, that project is fitted into Starfleet Command's priority schedule. Each successful prototype is potentially an entire new Type of

vessel, but the question will now become one of how badly that new Type is needed. Some new Types are rushed into mass production - such as the Mark 21-B. In such cases the approved design is let out to tender, and will be produced by the construction facilities of the winning vessel construction contractor(s) as a Main Type. Other designs - such as the Mark 13-B - seen as Special Types, and are intended for only limited production.

Fully tested Prototypes are not left sitting idle. They are used to fill observed gaps in overall fleet strength, such as placing a prototype Super Destroyer with Sub-Fleet 12 in lieu of another Heavy Destroyer. This affords Starfleet Command (and the Federation Security Council) a useful return on their investment, and an even more useful opportunity to observe the prototype being operated under prolonged field conditions. Often, the recommendations of a prototype's Captain - running his vessel with a regular crew - will be added to the Phantom in order to update and improve it against the day when it is put into full production. Should a prototype prove especially useful - even if not enough to warrant the production of Main Type - a second or third vessel may be constructed, and thus it will become a Special Type.

Class 2 Spaceships

A Class 1-B starship is, due to the enormous resources incorporated into its primary hull, a very adaptable vessel. Even a Mark 8-B Destroyer - while not intended primarily for such missions - is capable of fulfilling any of the Exploration duties of a Mark 9-B Heavy Cruiser in peacetime. The antithesis of this concept is the Class 2 spaceship. Each Type is a specialist, tailored for and very useful in its one pre-determined function, but completely unadaptable to any other.

Due to the small ship's complement, a spaceship's Commanding Officer does not usually hold the actual rank of Captain - even though as the CO he is addressed so. Rather he is usually a staff officer who has graduated from the Starfleet Command Training Program so that he may command a vessel in addition to running his Department. As an example, the CO of a Mark 35 Survey Vessel would be a Sciences officer, holding the rank of Lieutenant Commander - but who has earned his Command Stripe and the title of Captain.

The following is a file of the three most prevalent Class 2 Types with intended mission profile. Note that all Class 2 vessels utilize the SW27/1-4K Warp Drive nacelle and the KR/FC-3 Matter/Antimatter Reactor-Impulse Drive Package. A spaceship's powerplant is small in relation to a starship, having only three Antimatter Containment Bottles. This limits the operational range to within the Federation or - if within the Treaty Zone - within proximity of a Starbase or other refueling facility.

Starfleet DYNAMICS

Prototypes

In addition to the Main and Specialized Types of Class 1-B starships presently utilized by Starfleet, there are also a number of experimental designs - prototypes. Most are one-of-a-kind vessels being tested for spaceworthiness.

Every design is first conceived as a list of new payload and/or performance requirements being brought to the attention of Starfleet R & D by the Admiralty. From there, the next step is to plot the design within a Holographic Design Tank. Following this is the Phantom Test Stage. This involves creating within the R & D computers an exact - though non-existent - electronic analogue model of the newly designed craft, accurate with respect to outer hull shape, internal densities, masses, and energy flows. This Phantom is then subjected to a series of tests within the computer, to check out such characteristics as maneuverability, speed, and warp dynamics. Properly programmed, the Phantom will behave very similarly to an actual craft, and allows a design to be tested to its limits (destruction test) while the operators are in perfect safety. Moreover, if a design flaw is detected during the Phantom Test, the flaw can be redesigned and reprogrammed into the Phantom's structure. In such a way a new vessel can be perfected before it is ever built, with its parameters and maximum performance levels estimated.

Eventually a new design will have satisfied every Phantom Test possible, and the time will approach when the design must be seriously considered. The proposal will be returned to the Admiralty along with the estimated parameters, and a decision must be made on whether or not the design warrants further development, weighing desired characteristics against final specifications. Should the design meet with favor, the Starfleet Commander will get funding approval from the Federation Security Council for the building of a prototype.

The Starfleet Supra-San Francisco Orbital Yards have a large supply of moth-balled primary hulls - left over from the de-commissioning of the Tug Type. Using one of these (and updating it at the same time to a Class 1-B design), a prototype will be constructed. Prototype construction generally takes about twenty months, which includes the simultaneous refitting of the primary hull. Once completed, the new vessel is boarded by a specially-trained Test Crew comprised of engineers and personnel from the Starfleet Corps of Engineers and Research & Development. These personnel take the prototype on its shake-down cruise, which is intended to strain the vessel near the computer-predicted limits, and point-out any deviations from the Phantom-predicted performance. After a return to the Yards for final repairs, the vessel is certified.

Once a prototype has passed its shake-down, that project is fitted into Starfleet Command's priority schedule. Each successful prototype is potentially an entire new Type of

vessel, but the question will now become one of how badly that new Type is needed. Some new Types are rushed into mass production - such as the Mark 21-B. In such cases the approved design is let out to tender, and will be produced by the construction facilities of the winning vessel construction contractor(s) as a Main Type. Other designs - such as the Mark 13-B - seen as Special Types, and are intended for only limited production.

Fully tested Prototypes are not left sitting idle. They are used to fill observed gaps in overall fleet strength, such as placing a prototype Super Destroyer with Sub-Fleet 12 in lieu of another Heavy Destroyer. This affords Starfleet Command (and the Federation Security Council) a useful return on their investment, and an even more useful opportunity to observe the prototype being operated under prolonged field conditions. Often, the recommendations of a prototype's Captain - running his vessel with a regular crew - will be added to the Phantom in order to update and improve it against the day when it is put into full production. Should a prototype prove especially useful - even if not enough to warrant the production of Main Type - a second or third vessel may be constructed, and thus it will become a Special Type.

Class 2 Spaceships

A Class 1-B starship is, due to the enormous resources incorporated into its primary hull, a very adaptable vessel. Even a Mark 8-B Destroyer - while not intended primarily for such missions - is capable of fulfilling any of the Exploration duties of a Mark 9-B Heavy Cruiser in peacetime. The antithesis of this concept is the Class 2 spaceship. Each Type is a specialist, tailored for and very useful in its one pre-determined function, but completely unadaptable to any other.

Due to the small ship's complement, a spaceship's Commanding Officer does not usually hold the actual rank of Captain - even though as the CO he is addressed so. Rather he is usually a staff officer who has graduated from the Starfleet Command Training Program so that he may command a vessel in addition to running his Department. As an example, the CO of a Mark 35 Survey Vessel would be a Sciences officer, holding the rank of Lieutenant Commander - but who has earned his Command Stripe and the title of Captain.

The following is a file of the three most prevalent Class 2 Types with intended mission profile. Note that all Class 2 vessels utilize the SW27/1-4K Warp Drive nacelle and the KR/FC-3 Matter/Antimatter Reactor-Impulse Drive Package. A spaceship's powerplant is small in relation to a starship, having only three Antimatter Containment Bottles. This limits the operational range to within the Federation or - if within the Treaty Zone - within proximity of a Starbase or other refueling facility.

Operations Department

Mark 35 Garneau Class Survey Vessel

Intended solely as a survey vessel, the Mark 35 is designed to chart, investigate, and analyse planets located within the Treaty Zone - following in the path of the Class 1-B starships which have previously located such worlds and reported their coordinates to the nearest Starbase. The enormous Secondary Hull holds an OC3122W short-range/high resolution sensor suite - besting the short-range cartographic sensors of any Class 1-B. Lightly armed, laboratory facilities take up 70% of internal volume - excluding quarters.

COM = Officers - 16
 = Enlisted - 62
 DWT = 41,000 mt
 OAL = 148.0 m
 OAD = 59.0 m
 OAB = 103.0 m
 CSP = wf 7.0
 ESP = wf 8.0
 ORD = Phasers - 6 [3 Banks]

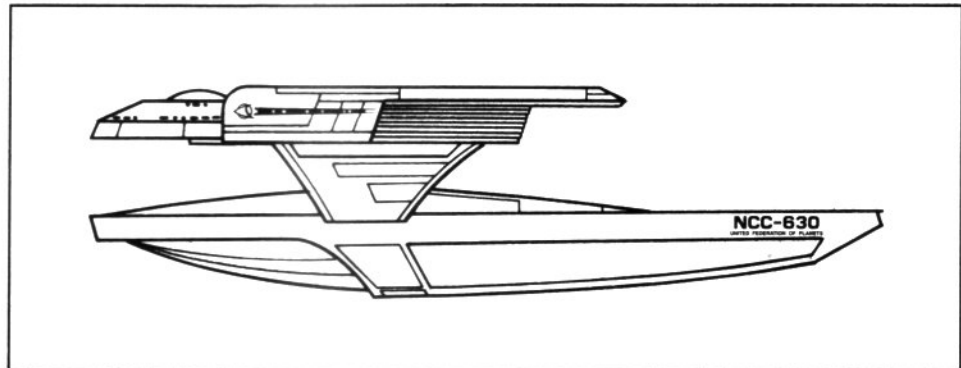

Mark 38 Asmodeus Class Corvette

Designed to patrol spacelanes well within the Federation, policing both private and commercial interstellar shipping activity - especially in those sectors troubled with extensive smuggling and Neutral Zone running. Fast and well armed for its size, the Mark 38 is virtually a Warp Drive-equipped weapons pod, with fore/aft Torpedo Tubes. However, the small powerplant of this Class does not allow for the mounting of Megaphasers..

COM = Officers - 16
 = Enlisted - 70
 DWT = 24,500 mt
 OAL = 102.0 m
 OAD = 33.0 m
 OAB = 103.0 m
 CSP = wf 7.5
 ESP = wf 8.4
 ORD = Phasers - 6 [3 Banks]
 = Pho-Torp - 4 Tubes

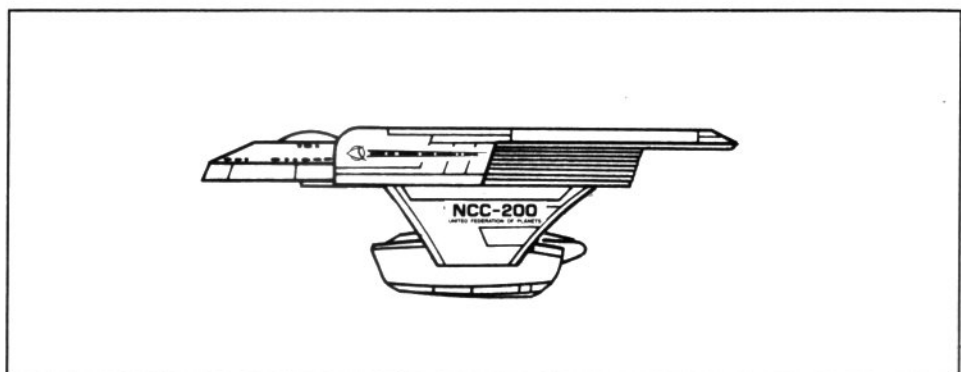

Starfleet DYNAMICS

COM = Officers - 13
 = Enlisted - 48
DWT = 31,000 mt
OAL = 115.0 m
OAD = 28.5 m
OAB = 103.0 m
CSP = wf 7.7
ESP = wf 9.4
ORD = Phasers - 6 [3 Banks]

-Mark 39 Clarke Class Diplomatic Clipper

In peacetime, the function of this stripped-down and swift vessel is to ferry Ambassadors and supporting diplomatic personnel to important meetings and contacts within the Federation and nearby Treaty Zone (see: Survey Procedures). In wartime however, the Mark 39 acts as a rapid-deployment sensor/mine launch platform. Intended to provide data for large Battle-groups and Sub-Fleets, the wartime function of the Mark 39 is to approach an enemy coordinates, launch a salvo of sensor drones (or lay a series of mines), and then retreat back to the main force at Emergency Speed, with the deployed sensor drones being monitored by the flagship.

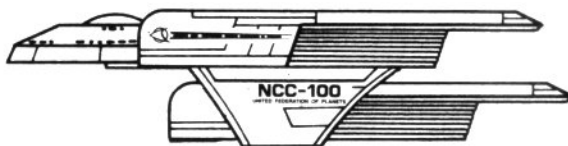

Class 3 Commercial Vessels

There are many commercial designs, representing thousands of ships operating within the Federation and the still-larger Treaty Zone. This file is included to aid in the familiarization and identification of the nine basic Types of commercial vessels.

Type A - Passenger Liner
Type B - Passenger/Gen Cargo Freighter
Type C - General Cargo Freighter
Type D - Container Cargo Freighter
Type E - Bulk Cargo Freighter
Type F - Module Freighter
Type G - Small Freighter
Type H - Tanker
Type I - Fuel Carrier

-Shipbuilders

90% of all military and commercial vessels plying the spacelanes within the Federation and Treaty Zone are designed and constructed by one of the following ten shipbuilding conglomerates. Most (such as Lockheed and Galactic) have orbital construction yards in more than a dozen Federation member systems.

-Power and Propulsion Systems

Although there are several major shipbuilding conglomerates (and a host of minor corporations), 87% of all commercial power and propulsion systems are produced by two firms. These hold contracts to construct Warp Drives, Impulse Drives, Reactors and Thrusters for each shipbuilder, leasing volume for themselves within that shipbuilder's own orbital construction yards. These two subcontractors have created a two-fold syndrome affecting commercial vessels. First; The power and propulsion systems for each model of vessel are designed for that vessel specifically - tailored to fit its size and other specifications. Warp Drive and Reactor are thus built as a pre-packaged whole. Second; All commercial vessels within a Type (there may be dozens of models within a Type)

Operations Department

possess similar capabilities and characteristics regarding the power and performance of their propulsion systems (Three different Passenger Liners - all Type A - one each built by Boeing, Nelaath, and Galactic, will have almost identical net output velocity and tolerance performance).

Although some Warp Drives are inboard and some are outboard (mounted externally in nacelles), all are detachable in the case of overload. Matter/Antimatter Reactors aboard commercial craft are relatively small, simple and automated compared to those of Class 1-B starships - even though some commercial craft are larger than their military counterparts. The powerplants possess neither the power nor the flexibility found in military designs.

-Shipping Lines

There are ten major shipping lines operating in Federation (as well as some hundred-odd minor lines) owning or controlling 72% of the commercial ships. Some specialize in one kind of trade and/or vessel, others are well diversified. All are licensed and monitored by the Federation Transportation Regulatory Agency.

Besides broadcasting navigational beacons, all commercial vessels must display the following external markings: Name of Vessel, Port of Registry, Name and/or Logo of Shipping Line. Below are listed the Logos, names, and specialization-of-trade of the ten major shipping lines, as well as the home world(s) of their headquarters.



Antares Freight

- Antares-6
- General/Bulk Cargo



Conflagration Lines

- Betelgeuse-9
- Passenger/Cargo

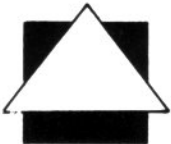

Transport, Inc.

- Rigel-5
- Passenger/Cargo



Star Lines

- Terra/Athens
- Passenger/Gen Cargo



G'Pnaatl Freight

- Tellar
- All Cargo



T'Liz Freight

- Vulcan
- Fuel/Tankage



Eclipse Lines

- Deneb-2
- All Cargo



Aalfnuul'g Lines

- Terra/Andor
- Passenger/Bulk Cargo



Corona Cargo

- Sirius-9
- Bulk Cargo



Lykes Lines

- Terra
- Bulk/Container Cargo

One sample vessel from each Type has been selected for the following file of Class 3 Commercial Vessel Types:

Starfleet DYNAMICS

One sample vessel from each Type has been selected for the following file of Class 3 Commercial Vessel Types. It should be noted that there are usually tens of vessel designs per basic Type (some manufacturers build two or three designs per Type. This file is not intended to be comprehensive, but rather is intended to familiarize the officer with the properties common to each type.

Vessel Characteristics:

CAP - Cargo Tonnage
DWT - Deadweight Tonnage
OAL - Overall Length
OAD - Overall Draft
OAB - Overall Beam
CSP - Cruising Speed
ESP - Emergency Maximum Speed

-Type A Passenger Liner

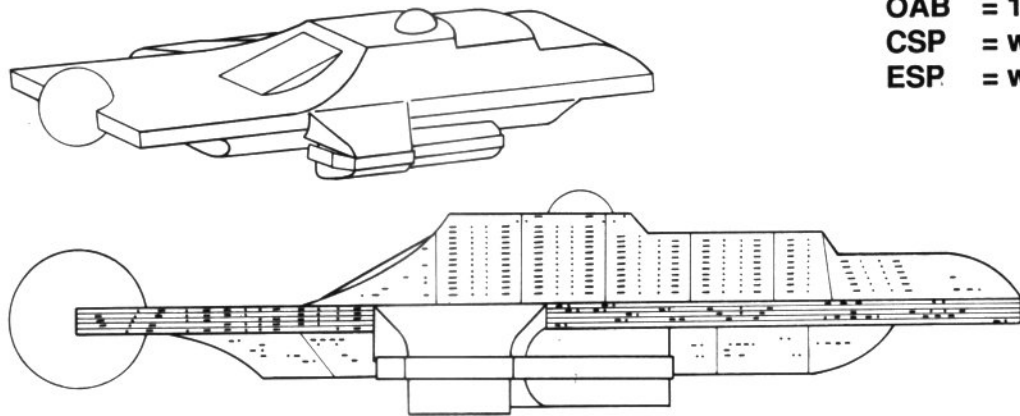

Boeing: 1447 Starliner
75 Officers/165 Crew
1250 Passengers
DWT = 197,000 mt
OAL = 300.3 m
OAD = 45.9 m
OAB = 171.8 m
CSP = wf 5.0
ESP = wf 6.0

Luxury Liners do not travel back-and-forth between two ports, but rather operate on fixed cyclic runs - usually encompassing five or more ports-of-call. A typical inner run would be Terra-Athens-Vulcan-Tellar-Andor-Terra... repeated endlessly, each cycle in this case taking sixty days, with a five day stopover at each port. There are dozens of such cyclic runs within the Federation, most touching on at least one of the afore-mentioned five inner worlds. Some reach as far as the outer periphery of the Federation at their farthest point, touching on as many as twenty-five worlds during their cycle and requiring as much as two-hundred days to make a complete run.

Passenger Liners always travel along the major spacelanes, and the stops along their runs must be members of the Federation. Such liners are the penultimate of creature comforts; providing for the privacy, dining, and recreational needs of hundreds of species. The first requires that each stateroom be fully programmable for mimicry of any Class M environment: air/heat/light/humidity/gravity. The second entails the listing of hundreds of menus within the food fabricators' memory banks. The third has taxed the combined talents of ship designer and xeno-psychologist, resulting in such wonders as zero-gravity gymnasiums, transparent-to-space dancing bubbles, and exotic sports facilities.

Operations Department

-Type B Passenger/General Cargo Liner

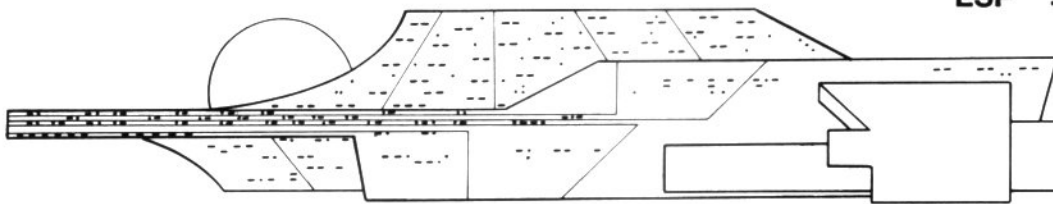
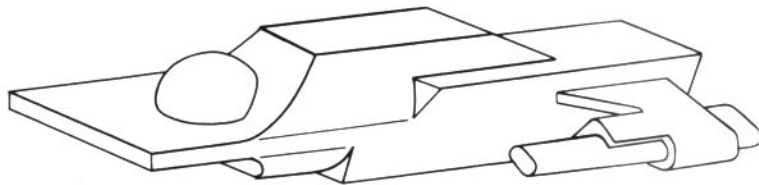

Nelaath: Splendor Model
50 Officers/110 Crew
500 Passengers
CAP = 60,000 mt *
DWT = 187,000 mt
OAL = 310.1 m
OAD = 54.5 m
OAB = 109.8 m
CSP = wf 4.6
ESP = wf 5.7

A hybrid Type, built to carry both passengers and cargo. As such, its principle role is to act as a transfer vessel, ferrying passengers and cargo from a port at which either a Type A or C vessel has dropped them off to another world not on the main cyclic runs - as a point-to-point shuttle round trip. A second purpose is to carry colonists and their equipment to a newly opened frontier world. In such cases, the vessel is chartered by the Colonial Bureau of the Federation Economic & Social Council. In either case, the passenger areas and quarters may be smaller than those on a Type A, but they are equally comfortable.

-Type C General Cargo Freighter

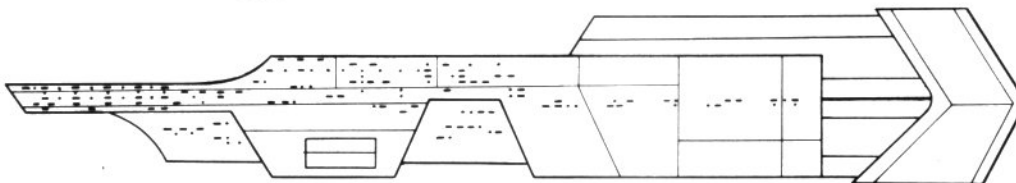
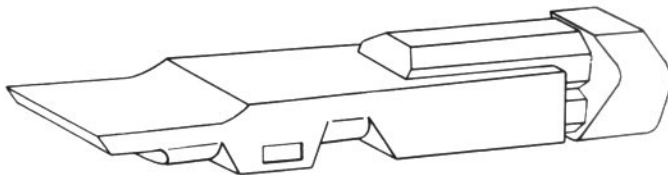

T'Sunniik: Efficiency
30 Officers/80 Crew
CAP = 90,000 mt
DWT = 180,000 mt
OAL = 297.2 m
OAD = 41.1 m
OAB = 80.9 m
CSP = wf 4.3
ESP = wf 5.5

A pure-bred freighter, the Type C transports every kind of cargo imaginable - so long as said cargo is crated and/or otherwise self-contained and not too large as a unit. Most freighters operate on regular cyclic runs similar to Type A ships, and these are known as Freightliners. Others contract at each next port-of-call for new freight and destinations, and these are known as Tramp Freighters. Although slower than Type A or B vessels, the Type C freighters are the single most important factor regarding Federation economic growth and prosperity, as they carry the life-blood of Federation commerce.

Starfleet DYNAMICS

-Type D Container Cargo Freighter

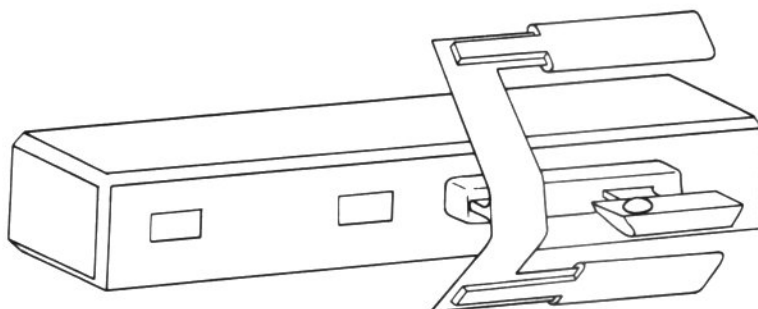

Galactic: Flying Boxcar
 25 Officers/75 Crew
 CAP = 200,000 mt
 DWT = 120,000 mt
 OAL = 341.9 m
 OAD = 114.9 m
 OAB = 137.4 m
 CSP = wf 3.7
 ESP = wf 4.9

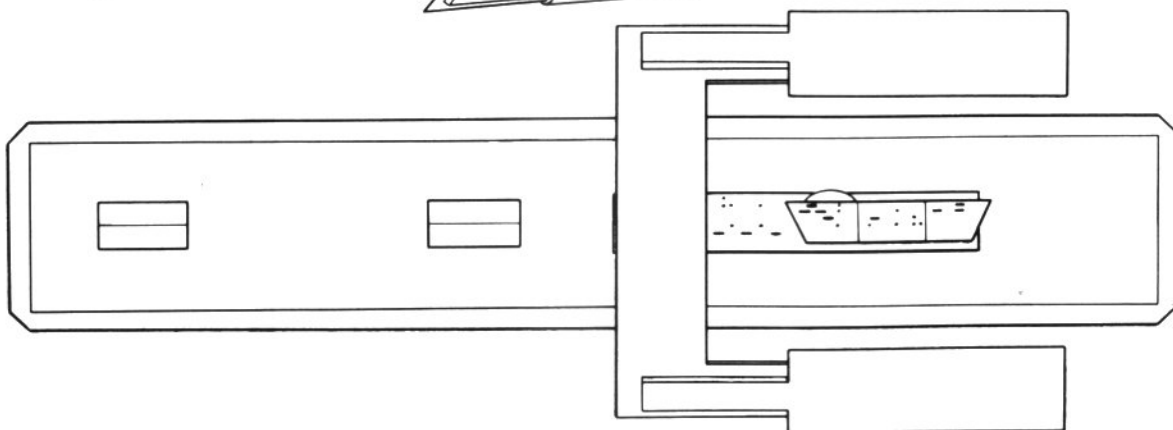

Container Freighters are used to transport large self-contained items from point-to-point. Except for rare charter missions, carriers generally travel in two-or-three port cyclic runs. The entire main hull is one enormous cargo bay, and is generally kept in vacuum. Sections of the bay can be isolated by force-field curtains and pressurized.

-Type E Bulk Cargo Freighter

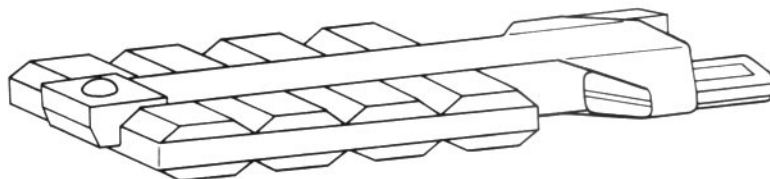

Gruuf Dynamics: Pack-beast
 20 Officers/45 Crew
 CAP = 150,000 mt
 DWT = 140,000 mt
 OAL = 338.9 m
 OAD = 25.2 m
 OAB = 111.2 m
 CSP = wf 3.8



Bulk Carriers are used to transport various unprocessed minerals and ores from their origin point (asteroid-mine, planetary ring, lunar orbit) to a world with refining and/or manufacturing facilities. They can be loaded directly via transporter-conveyor. Also called Ore Carriers, these vessels are normally contracted by a mining/refining consortium to haul point-to-point. At the end of a contract run, the ore hoppers must be extensively de-contaminated before another mineral can be hauled. Cargos can also include grain.

Operations Department

-Type F Module Freighter

FTL Engineering:
Practicality
20 Officers/70 Crew
CAP = 140,000 mt
DWT = 71,000 mt
OAL = 308.5 m
OAD = 21.8 m
OAB = 113.1 m
CSP = wf 4.0
ESP = wf 5.3

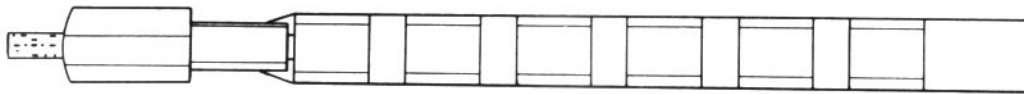
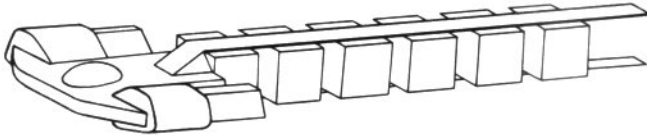

Module Freighters are used to transport various bulk cargos (ores, grains, processed metals) from source worlds to production worlds, from production worlds to consumer worlds. Actually it does the same task as the Type E, but is more efficient for smaller loads. A small commodity producer can keep a few empty modules in orbit, filling them at his own pace and sending full modules onward to their destination whenever the Type F stops by. This eliminates the need for large temporary storage and transfer facilities at each site, and allows smaller amounts to be shipped regularly, as opposed to larger amounts being shipped infrequently. Also, the turnover time of the vessel at each stop (loading/unloading) is markedly reduced. Finally, one ship can carry up to seven different cargos.

-Type G Small Freighter

GruufDynamics: Monarch
10 Officers/19 Crew
CAP = 25,000 mt
DWR = 140,000 mt
OAL = 201.3 m
OAD = 55.9 m
OAB = 125.4 m
CSP = wf 4.9
ESP = wf 6.3

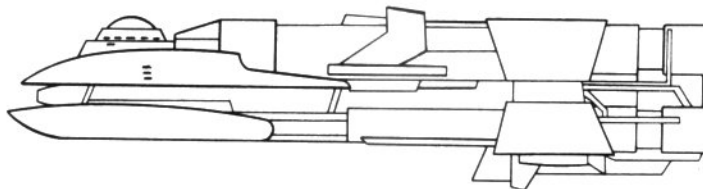
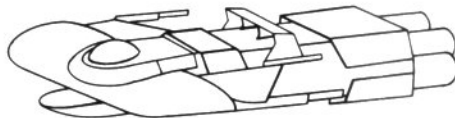

Normally privately owned, Small Freighters operate strictly on a charter basis - as Tramp Freighters. Relatively fast for Class 3 vessels, they are often contracted to carry high priority cargo, or regular cargo to high-risk destinations well off the spacelanes. This is far cheaper than diverting a Type C Freighter - loaded with several parties' goods - from its regular run.

Starfleet DYNAMICS

-Type H Tanker

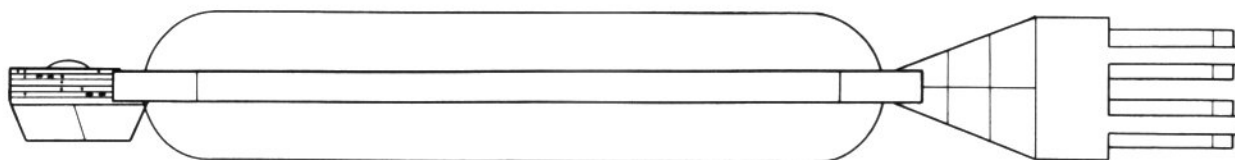
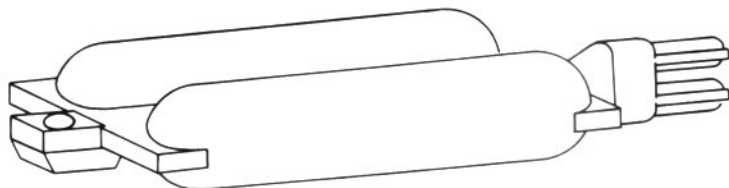

Galactic: Saggitarius
 24 Officers/50 Crew
 CAP = 400,000 mt
 = [700,000 cu m]
 DWT = 120,000 mt
 OAL = 361.9 m
 OAD = 43.1 m
 OAB = 111.2 m
 CSP = wf 3.0
 ESP = wf 4.4

Used to transport large quantities of liquids or gases (at up to 100 atmospheres pressure). A frequent user of Tankers is the Starfleet Corps of Engineers, which contracts them to haul liquid air, hydrogen, and water to terraforming projects and Starbase construction sites. Loading/unloading of the cargo is accomplished via ship-to-station pipeline. Depending upon the value of the cargo and the destination/origin, a special-cargo team may augment the regular crew, should the cargo require special attention during the loading/unloading process. Tank internal temperature can be set to any requirement. Except for those vessels involved in station re-supply runs, most Tankers operate on a charter basis.

-Type I Fuel Carrier

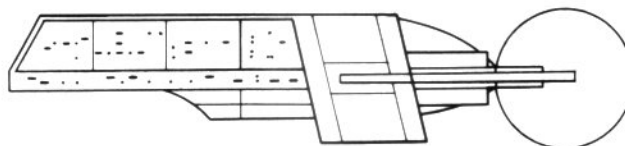

T'Sunniik: Prometheus
 20 Officers/61 Crew
 300 Passengers
 CAP = 97,000 mt
 DWT = 147,000 mt
 OAL = 184.8 m
 OAD = 42.6 m
 OAB = 115.4 m
 CSP = wf 4.0
 ESP = wf 6.0 *

Fuel Carriers operate on regular cyclic runs, transporting fuel from processing centers to military and civilian fueling stations (Starbases and Spaceports) and planetary power generators. The fuel carried is one of three: Antimatter (condensed to degenerate-matter density), Matter (condensed to neutronium density), and Deuterium (used in civilian Impulse Drives). The fuel is carried in a containment bottle, which is protected from contact with the fuel via insulating force-field. Anchored to the rear of the vessel by explosive bolts, the bottle can be jettisoned at the first sign of force-field instability. Fuel Carriers are also used to transport personnel to and from postings at the rather isolated fuel processing stations, and generally have austere but comfortable passenger quarters.

* Without Containment Bottle

Class 4 Automated Vessels

Class 4 vessels differ from their Class 3 counterparts in that they are completely automated - possessing no crew facilities whatsoever. It is seldom that a vessel is constructed with this Class in mind. Usually an older Class 3 vessel - no longer able to compete with more modern, faster, larger designs, is converted to Class 4 rather than being scrapped. The crew lifesystem and quarters are stripped-out, to make room for an autopilot/computer-guidance system - capable of running all Navigation and Engineering functions, and following strictly pre-programmed courses and schedules. Some Class 4 vessels have been in use for 75 years.

The Class 4 Types parallel the Class 3 except for the lack of Types A and B. They are used to haul low-priority and/or low value cargo throughout the Federation, including but not restricted to ores, grains, etc. The low value of the cargo reflects the lack of an onboard crew to react to such potential hazards as ion storms and hostile vessels.

In addition to pre-programmed courses, a Class 4 vessel may also be directed by remote control. Thus, instead of cruising from origin to destination by itself on autopilot, up to four Type 4 vessels can be shepherded by one Type 3 vessel of similar Type (a manned freighter escorting four unmanned ones), which guides its charges via subspace radio link. This effectively allows five vessels to be run by the crew of one, with consequent savings in manpower and life-support - at the cost of a Class 3 vessel having to hold down its speed to match that of its older and slower charges.

When a lone Class 4 vessel reaches its destination star system, the autopilot is slaved to the Spaceport Traffic Control Direction Computer via subspace radio link, whereupon it will be guided into the proper parking orbit. The pass-codes necessary to enslave a Class 4 vessel's autopilot are protected by rigorous security systems, and are only available to the authorized Spaceports or shepherding vessels.

It is a Federation offense to program a Class 4 vessel to travel on any course but along a marked spacelane, to and from registered Spaceports. It is a Federation offense to program a Class 4 vessel to deviate from its filed flight plan. It is a Federation offense for a Class 4 vessel to be programmed to ignore the authorized (pass-code) instructions of a Spaceport or Starfleet vessel.

Civilian Craft - Spacelanes & Regulations

Non-military vessels account for 80% of the traffic and ships within the Federation. Civilian craft are divided into three major categories. Each category has certain specific

permitted and proscribed activities. With the exception of Private Yachts and Prospecting Craft, all non-military craft rigidly follow predetermined "corridors" linking the various inhabited systems within the Federation. These corridors - known as Spacelanes - provide the traveling craft with several advantages; they are known to be free of natural hazards, they are patrolled by Starfleet, and they are easily located and navigated by reason of the Automatic Navigation Beacon-Buoys. These Buoys are shuttlecraft-sized un-manned stations, placed along the Spacelane routes, spaced .1 parsec apart. Equipped with an automatic navigation system and positional thrusters, each Buoy is self-stabilizing, keeping locked into its particular set of coordinates. Each Buoy transmits on the Navigational frequency of the Spacecraft Control Band of Subspace Radio, broadcasting its Coordinates, Spacelane Identification Number, and Buoy Reference Number: (24.6 , 61.9 , -1.5)...Sol-61 Cygni...Spacelane 12...Buoy 77516 in a spherical locus 2 parsecs in diameter, repeating every thirty seconds. Major Spacelane Intersection Buoys transmit to a range of five parsecs.

Category A - Commercial - Cargo & Passenger: Except as granted permission by individual planetary governments and the Federation Bureau of Transport (FBT), commercial vessels are prohibited from leaving established regular runs and/or orbiting planets not listed as regular Spaceports. A commercial vessel is defined as any vessel capable of carrying more than 20,000 metric tonnes of cargo and/or 50 paying passengers. All passengers and cargo must be listed on the ship's manifest, along with port of departure and port of destination. They may not be picked-up or dropped-off anywhere but at regular Spaceports.

Category B - Private - Cargo & Passenger: Private craft are encouraged - but by no means forced - to travel along the major Spacelanes. Naturally some charters will make this impossible. Before each voyage, all passengers and cargo must be listed on the manifest, along with the intended route and destinations. Copies of this manifest must be transmitted to the FBT prior to departure and approved, as some destinations may be under recent quarantine (see: NEUTRAL ZONES).

Category C - Private - Yachts & Prospecting: The guidelines for Yachts and Prospecting vessels are simplicity itself. Since such craft do not have scheduled routes or destinations, absolutely no paying passengers or cargo are permitted - such would be deemed smuggling contraband (see: THE AIMS & RESPONSIBILITIES OF STARFLEET). The only equipment allowable aboard a Prospecting craft are detection devices and personal claim beacons. It is imperative that all aspects of these vessels' voyages be duly recorded.

Starfleet DYNAMICS

Auxiliary Craft

Class 1-B starships utilize six basic types of auxiliary craft. The number of each carried depends upon the size of the vessel, its mission, and the hangar facilities available. Each is a highly specialized machine, intended for a particular function. All auxiliary craft are capable of landing on Class M planets, and as such complement the transporters. The hangar - and all auxiliary craft within it - are the responsibility of the Deck Officer. He is responsible for their maintenance, as well as the proper training, coordinating, and deployment of their pilots. All auxiliary craft pilots are petty officers, and are known as Command Pilots.

Auxiliary Craft Characteristics:

CCW - Command Crew
PSS - Passengers
TNN - Tonnage
LNG - Length
DRT - Draft
BEM - Beam
ORD - Ordnance
PRO - Propulsion System(s)

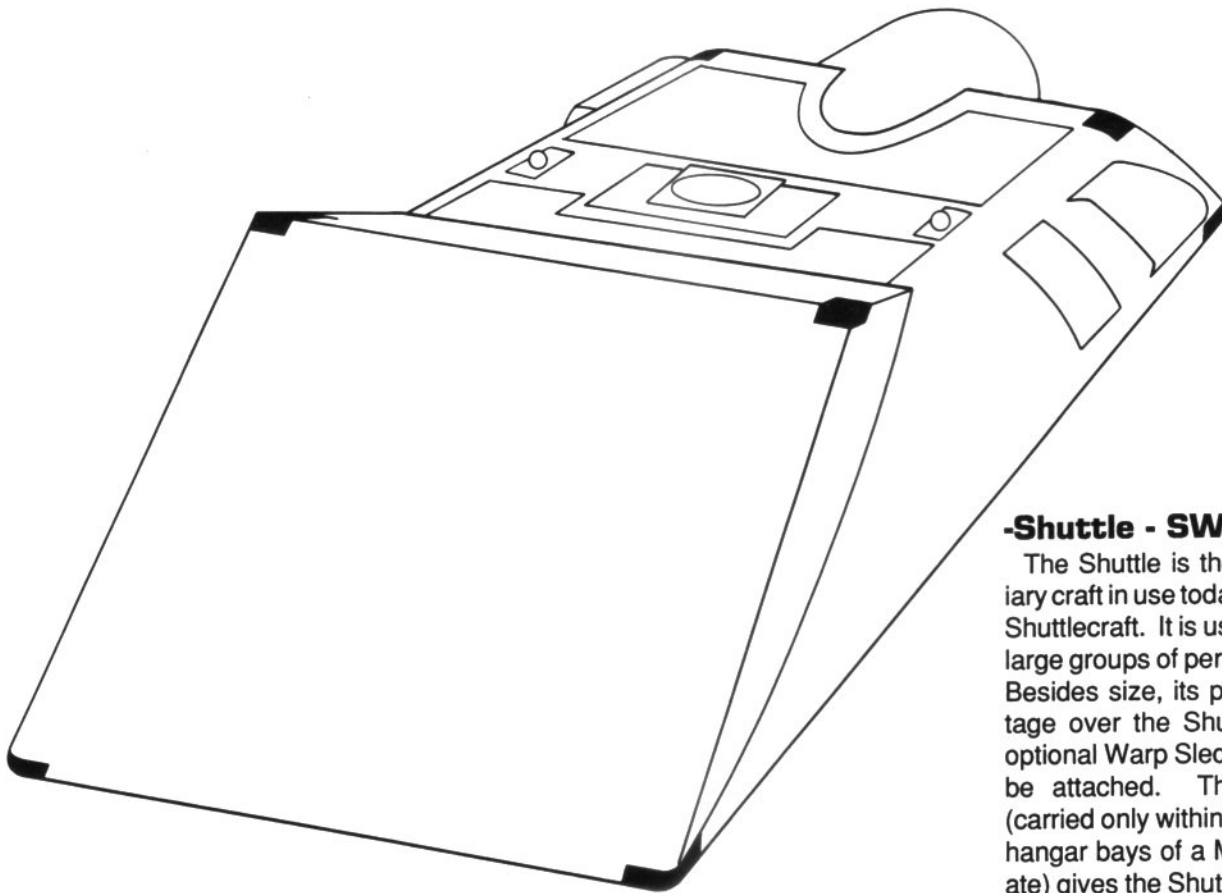

-Shuttle - SW-7

The Shuttle is the largest auxiliary craft in use today, dwarfing the Shuttlecraft. It is used to transport large groups of personnel at once. Besides size, its principle advantage over the Shuttlecraft is the optional Warp Sled to which it can be attached. This Warp Sled (carried only within the extra-large hangar bays of a Mark 11-B Frigate) gives the Shuttle limited interstellar capability.

CCW	= 2	LNG	= 13 m
PSS	= 20	DRT	= 4 m
TNN	= 35 mt	BEM	= 11 m
ORD	= Mini-Phasers - 2		
PRO	= Primary - Micro-Impulse		
	= Secondary - Thrusters		
	= Optional - Micro-Warp Sled		

Operations Department

- Assault Shuttlecraft - S-19

One of the fastest and most durable of all small vessels. An updated version of models utilized by Starfleet for 35 years, the S-19 was specifically designed for landing squad-sized Infantry, Marine, and Security units.

CCW = 2
PSS = 10
TNN = 10 mt
LNG = 6.5 m
DRT = 2.5 m
BEM = 3.5
PRO = Primary - Micro-Impulse
= Secondary - Thrusters

- Shuttlecraft - S-15

The Shuttlecraft is an updated version of the model used by Starfleet for the past forty years. Capable of interplanetary flight, it is the craft usually chosen to deliver a Landing Party when use of the transporter is contra-indicated.

CCW = 1
PSS = 7
TNN = 10 mt
LNG = 6.5 m
DRT = 2.5 m
BEM = 3.4
PRO = Primary - Micro-Impulse
= Secondary - Thrusters

- Travel Pod - S-10

The Travel Pod is carried on all Class 1-B and 2 vessels, for a variety of reasons. Being small, it can be tucked within the smallest hangar pocket. Although it is landing capable (and is often used as a Gig), its principle use is to ferry officers from ship to ship or station as a diplomatic gesture.

CCW = 1
PSS = 5
TNN = 4 mt
LNG = 4 m
DRT = 3 m
BEM = 3 m
PRO = Primary - Thrusters

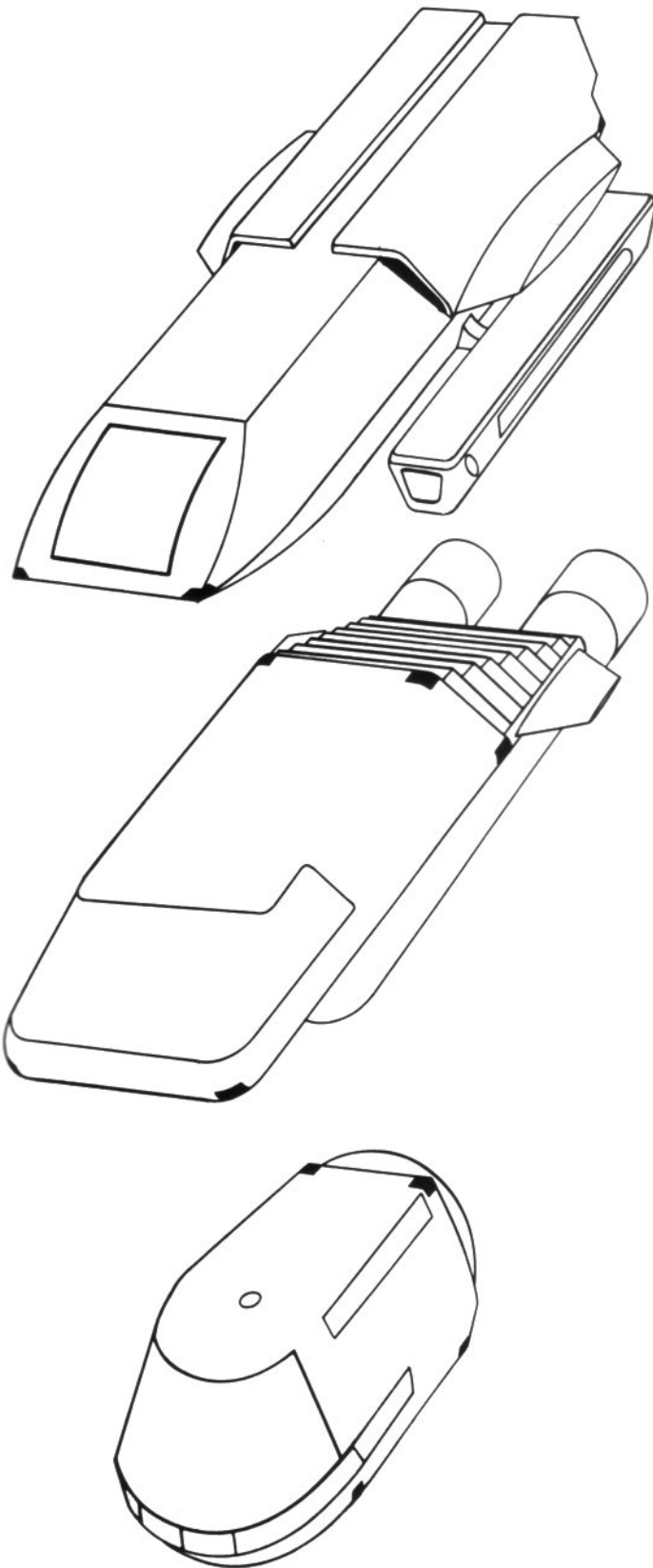

Starfleet DYNAMICS

-Bee - S-2

The Bee is by far the most versatile of auxiliary craft. Basically a stripped-down one-man spaceship, it has by itself an extremely limited operating range. Its protean utility is derived from the large assortment of adapters and sub-units which can be attached to it, transforming it into various highly specialized craft. Its uses are generally broken-down into two categories, Work-Bee and Killer-Bee, each of which has more than one subdivision. Developed over ten years ago, the Bee itself has not undergone any significant changes, although new adapters are being constantly developed.

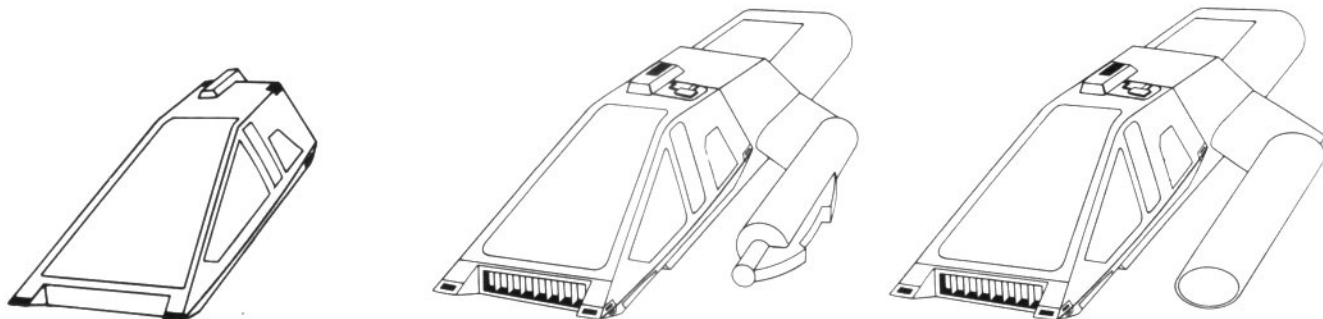

Work-Bee - S-2A: Utilizing its own built-in powerplant and thrusters, the Work-Bee can serve such functions as Cargo Train (towing eight cargo containers from planet-surface to orbit), Construction Drone (equipped with a pair of externally mounted waldoes), and Life-Boat Tender (locked onto and towing 20 Life Boats).

CCW = 1
 TNN = 2 mt
 LNG = 2.7 m
 DRT = 1.2 m
 BEM = 1.3 m
 PRO = Primary - Thrusters

Killer-Bee - S-2B/C: There are two varieties of Killer-Bee, each based upon the same Propulsion Sled. The Sled attaches to the rear and underside of any Bee, transforming it into a one-man attack-craft. The Sled provides additional power and propulsion, via a built-in Micro-Impulse Drive.

CCW = 1
 TNN = 4 mt
 LNG = 4.0 m
 DRT = 1.3 m
 BEM = 2.2 m
 ORD = Wasp - Micro-Phaser
 Hornet - Pho-Torp
 PRO = Primary - Micro-Impulse
 = Secondary - Thrusters

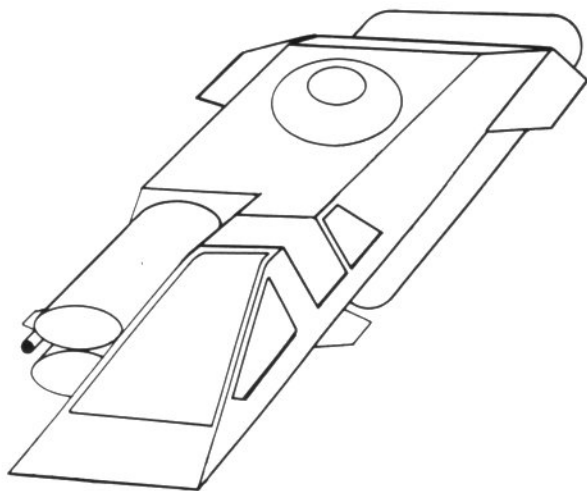

- Talon - SA-3

The Tomohawk is a two-man attack craft, armed with phaser cannon and twin torpedo tubes, which are mounted beside the cockpit. It is the principle small fighter/interceptor craft of Starfleet.

CCW = 2
 TNN = 4 mt
 LNG = 4.5 m
 DRT = 3.0 m
 BEM = 3.1 m
 ORD = Micro-Phaser & 2 Pho-Torp
 PRO = Primary - Micro-Impulse
 = Secondary - Thrusters

Operations Department

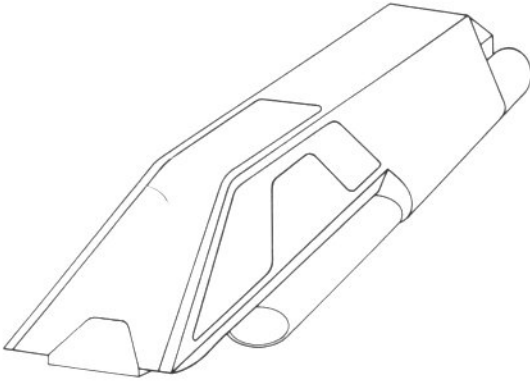

- Tomohawk - SA-4

The Tomohawk is a two-man attack craft, armed with both phaser cannon and a single torpedo tube, both of which are mounted beneath the cockpit. It is the principle ground-attack and escort craft of the Federation Marine Corps.

CCW	= 2
TNN	= 3 mt
LNG	= 4.2 m
DRT	= 2.5 m
BEM	= 2.5 m
ORD	= Micro-Phaser & Pho-Torp
PRO	= Primary - Micro-Impulse
	= Secondary - Thrusters

Auxiliary Craft Regulations

Command Pilot Authority: The Command Pilot of a passenger-carrying auxiliary craft such as a Shuttle or Travel Pod is always at least a petty officer. He is in absolute command of the craft, subject to supervision of any line officer present. He is charged with the safety of the craft, its passengers and cargo, and any surrounding structures or vessels. His orders in regard to the operation of the craft and the maintaining of proper discipline must be obeyed without question.

Docking:

- 1 - Always proceed directly to the Docking Bay assigned, slowing to 5 meters/second at 1 kilometer.
- 2 - Always power-down thrusters and powerplant at a distance of 0.25 kilometers.
- 3 - Always unlock from a vessel's docking collar before powering-up thrusters - and check visually.
- 4 - Follow the directions of the Deck Officer.

Hangar:

- 1 - Never engage powerplant until Hangar Bay is de-pressurizing.
- 2 - Never power-up thrusters until Hangar Doors are open.
- 3 - Follow the directions of the Deck Officer.

Free-flight Regulations: The Command Pilot is responsible for following these regulations pertaining to free-flight.

- 1 - Obey standing free-flight traffic guidelines.
- 2 - When operating from a base, maintain contact with base at all times, except when required to contact another station.
- 3 - Hail any vessel if course passes within twenty kilometers.
- 4 - Always proceed from launch coordinates to destination coordinates along the pre-filed flight-path. Never vary from said path without advising base of change and reason.

Passenger Regulations: All passengers should be familiar with the following regulations and obey them unflinchingly.

- 1 - Embark/disembark in a quiet orderly manner. Sit or stand as and where indicated.
- 2 - Never needlessly distract the Command Crew.
- 3 - No eating, drinking, or smoking in an auxiliary vessel.
- 4 - No passengers are allowed on board during fueling operations.
- 5 - If an auxiliary craft underway loses total or partial power, do not panic or interfere with the Command Crew.
- 6 - Obey all orders of the Command Crew.

Starfleet DYNAMICS

-Hangar Bay

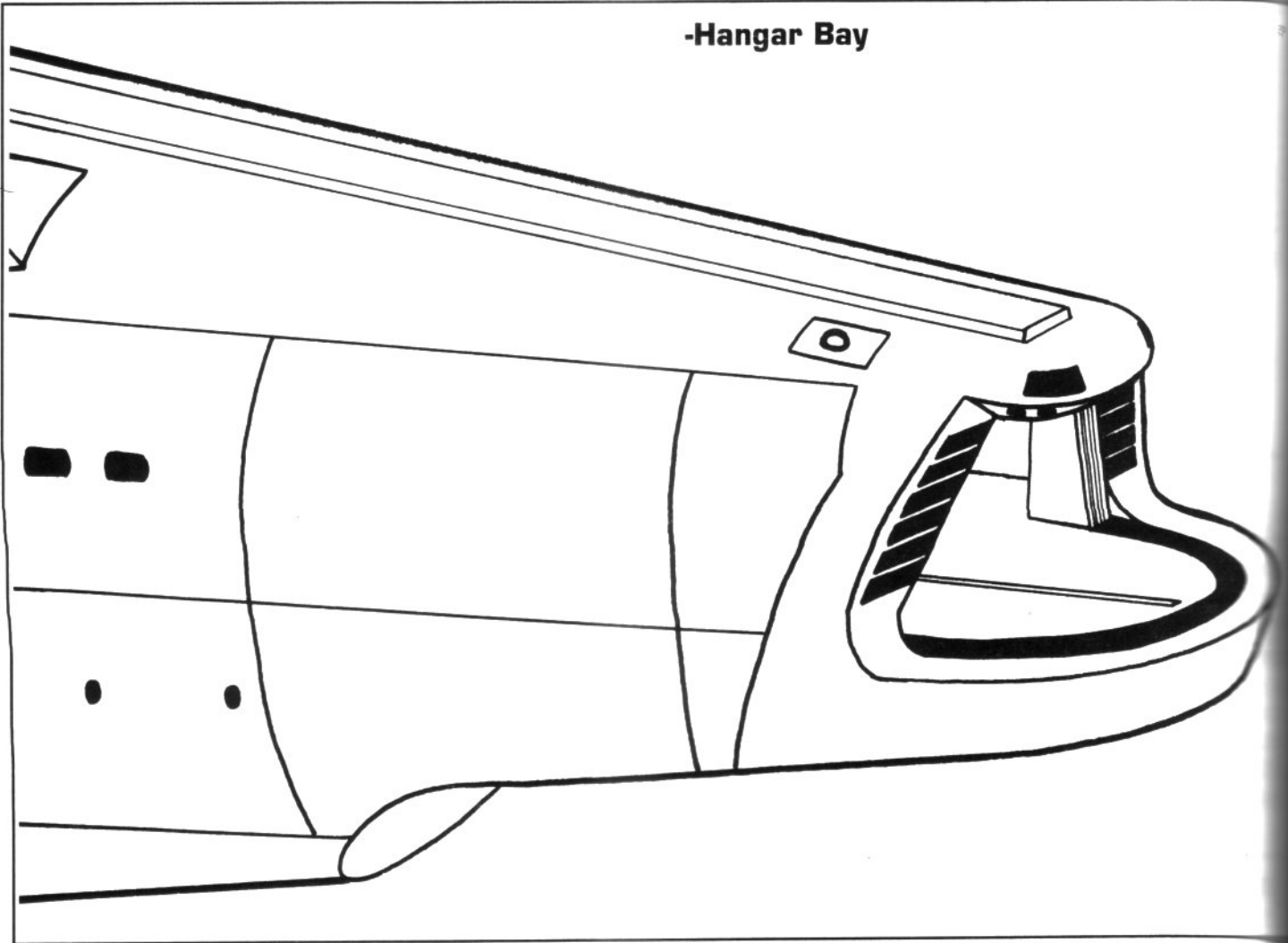

-Hangar Complex

The above diagrams shows oblique and cutaway views of the aft section of an *Enterprise* Class Heavy Cruiser's Secondary Hull, focussing on the Hangar Complex. Of special note are the twin Shuttle Elevators, each enclosed in its separate vertical Bay. Each Bay has airtight doors opening aft at the Landing Bay, Parking Bay, and Workshop Bay levels, as well as one door opening forward into the Cargo Bay (for Workbee's towing a Cargo Train). Although differing in layout, similar Hangar Complexes exist in all Class 1-B Starships.

The Hangar Complex and all Auxiliary Craft are the responsibility of the Deck Division of the Operations Department - and falls under the authority of the Deck Officer. Because of the inherent danger of collision (and exposure to particle beam thruster exhausts), all EVA personnel must also clear their activities with the Deck Officer before exiting the ship.

-Hangar Procedures

Launching: After Hangar depressurization, Flight Control will dislock the Hangar doors and power-down the Landing Deck gravity generator. At this point, the Shuttle pilot may activate his powerplant. After the doors have fully retracted, Flight Control will direct the pilot to engage thrusters and launch. The pilot will then fly out of the Hangar at a speed of 5 meters/second. Once clear of the doorway, Flight Control will give the pilot the proper vector to his intended flight-path.

Landing: Under the direction of Flight Control, the pilot will bring his Shuttle to within one kilometer of the ship, and decelerate to 10 meters/second. The Deck Officer will sound the alarm to clear the Hangar of personnel, and then will depressurize the Hangar.

Operations Department

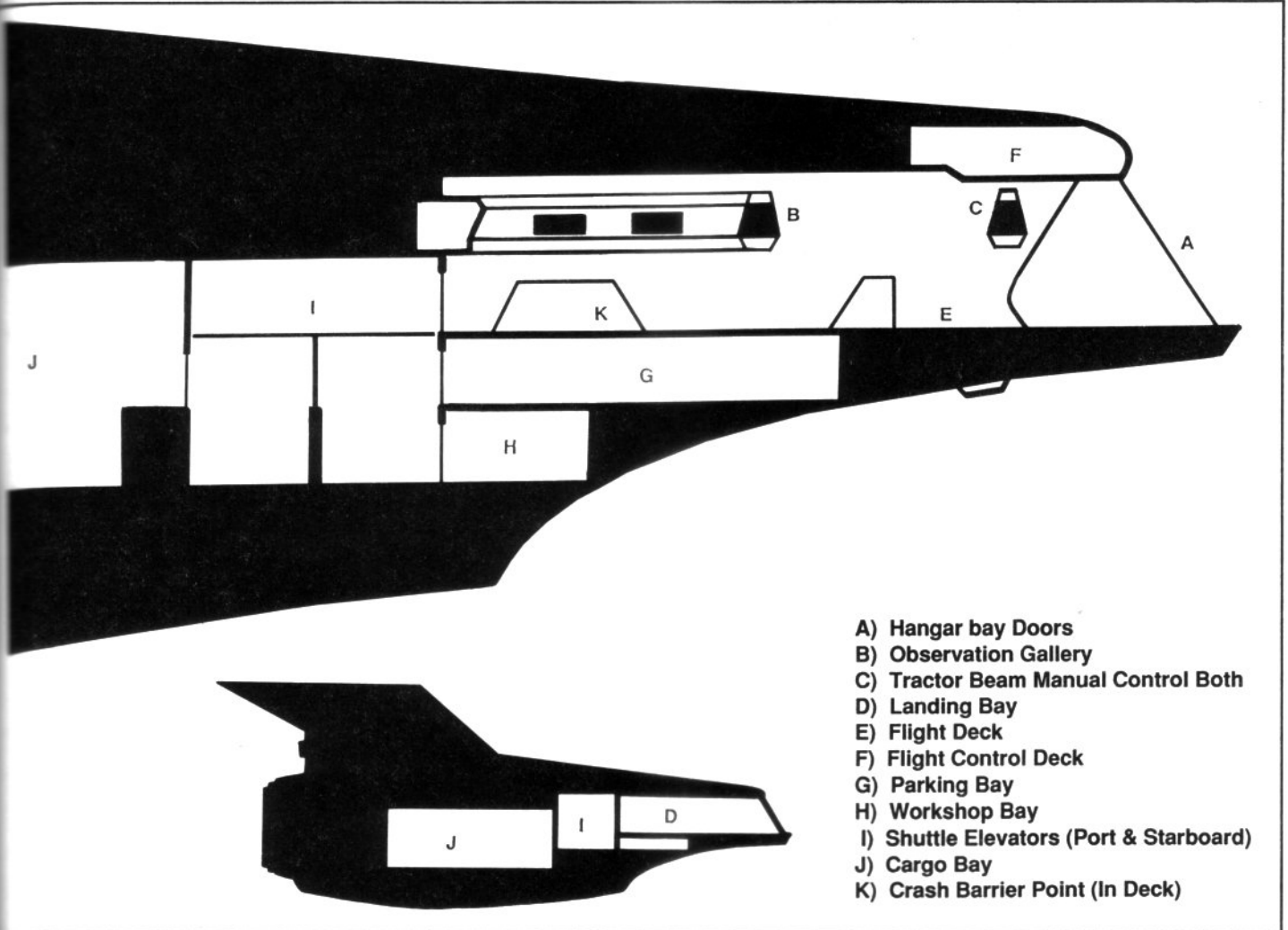

power-down the gravity generator, and open the doors. As the Shuttle approaches 0.25 kilometers (on a flight-path aimed directly into the Hangar), The pilot will be ordered to shut-down his onboard powerplant and engines. From this point, control of the Shuttle will be exercised by Flight Control, using the Hangar Tractor/Pressor Beam. The Shuttle's momentum will be gradually reduced, and the flight-path corrected, while guiding the Shuttle to touch-down on the Hangar Landing Target. Once this is accomplished, the doors will be closed, the gravity generators will power-up, and the Hangar will be repressurized.

Gravity: The internal gravity generator of a landing Shuttle is synchronized to cut-out the instant that the Hangar's field powers-up. Similarly, a launching Shuttle's generator powers-up the instant that the hangar's field cuts-out.

Crash: In the event of an incoming Shuttle coming in at excessive speed (through failure of Pressor Beam, Shuttle thruster malfunction, etc.), Emergency systems are fully automatic. Any craft which moves beyond the Landing Target activates the Crash Barrier; a terminium-fabric mesh-curtain which deploys upwards from the deck to cushion and absorb the Shuttle's momentum and prevent it from impacting the bulk-head.

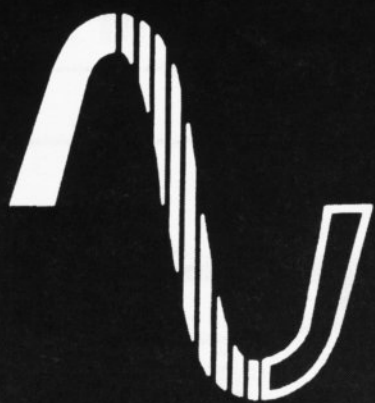

Communications Department

Communications Systems

Intercom

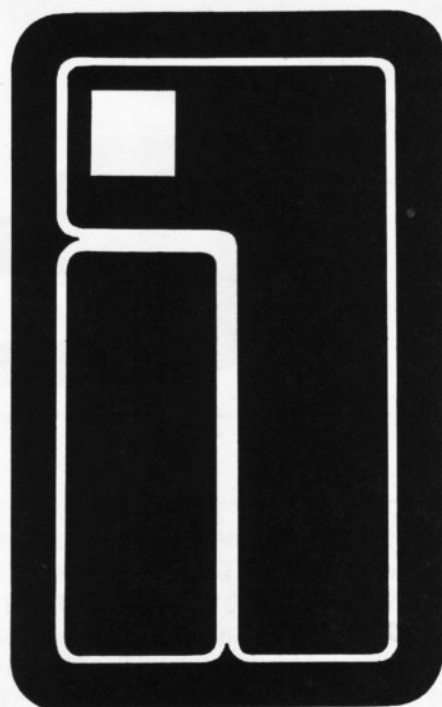

Intercoms are located throughout a starship. Each station console is so equipped. As well, bulkhead units (as shown) are mounted in every compartment and corridor - including living quarters and turbolifts. Although each intercom is connected to the nearest power supply, there is no physical connection to any other intercom. Rather, all intercoms communicate to each other via sealed & encoded electronic transceivers -SEET. There are two modes: Private and Master Circuit.

Communications Department

Private

Any intercom can reach any other one without aid from the Communications watch. The desired receiving unit is reached by stating the unit desired aloud - preferably by proper compartment designation (eg: Transporter Room Number Four). The Main Computer - monitored automatically by the Bridge Communications Console computer - links the two intercom's digital codes.

Master Circuit

Master Circuits are defined as any intercom connection linking more than two intercom units together. Some Master Circuits involve hooking several units into a common conversation for remote conferencing - such as the Bridge Weapons Console talking to all Fire-control Stations simultaneously. Others involve sending messages through overhead speakers, so that a particular person or persons may be paged or informed without needing to move to their own intercoms, or the entire crew may be addressed at one time. Regardless, the Bridge Communications Station has sole control over all Master Circuits, although the sending unit may be anywhere within the ship

Master Listing:	1MC Bridge Main Viewer
	2MC Main Reactor Compartment
	3MC Main Engineering
	4MC Secondary Engineering
	5MC Hangar Bay
	6MC Cargo Deck
	7MC Intercraft (All Units)
	8MC Damage Control
	9MC Fire-control
	10MC Transporter Rooms
	11MC Airlock/Hatchways
	12MC Sickbay
	13MC Auxiliary Bridge
	14MC Computer Core
	15MC Quarters - Alpha Section
	16MC Quarters - Beta Section
	17MC Quarters - Gamma Section
	18MC Security Communicators

-Sealed & Encoded Transceivers

The SEET first digitalizes information to be transmitted, and then encodes it in a code unique to that particular unit and no other. Thus the computer can distinguish between them. In a similar fashion, information to be transmitted to the particular unit is first encoded in the receiving unit's unique code - whereupon it will be received only by that unit.

Subspace Communications

-Tachyonic Theory

Normal-space communications utilize electronic wavicles traveling at lightspeed: photons. Subspace communications utilize gravitonic wavicles traveling at enormously greater speeds: tachyons. Photons travel at an inherent velocity of 300,000,000 meters per second. Tachyons are variable in velocity, the speed depending on the energy state of the tachyon. For Starfleet communications purposes, tachyons are excited to the maximum speed attainable in intergalactic space - warp factor 20.3 (8,365 x lightspeed). Faster tachyonic speeds can only be achieved by tachyons generated and traveling between galaxies. This speed limitation is due to the micro-gravitational "texture" of the seemingly flat Space/Time Matrix Fabric in interstellar (intergalactic) space (see: WARP DRIVE-INTRODUCTION).

As stated above, the speed of gravitational wavicles is controlled by the tachyon's energy state, and thus by the transmitter power output. The greater the available power, the faster the tachyons. Starbases, major planetary communications centers, and Class 1-B starships can broadcast at Warp Factor 20.3 due to their enormous power reserves. Minor planetary communications facilities usually broadcast at Warp Factor 19.1. Small spacecraft are usually hard-pressed to broadcast at a speed of Warp Factor 17. In fact, until the starship-refitting program of Stardate 7400, Class 1-B starships communications speeds were limited to a maximum of Warp Factor 18.6.

-Bands

The gravitational wavicles can be frequency-modulated just as are electronic wavicles. Thus, Subspace is divided into various frequencies in a similar fashion as Normal-Space. Various sections of frequencies have been set aside for private, commercial, and military usage. In particular, a universally agreed upon section of frequencies has been reserved as "Hailing Frequencies". These are off-limits except to vessels making initial contact with other ships or planetary bases.

As well, a distinct band of frequencies has been reserved as the "Distress Frequencies". spacecraft in jeopardy, planets facing catastrophe, and Recorder Marker Buoys all use these frequencies. The entire band is constantly monitored by the Communications Duty Officer aboard starships and at Starbases. Other frequency bands include:

- | | |
|------------------------------|----------------------|
| - Starfleet Operations | - Spacecraft Control |
| - Private News/Entertainment | - Private Citizens |

Starfleet DYNAMICS

-Enhancement

ENHANCEMENT ROUTINE:
0311964-7 MOD 116

POLARIZING MODULATION OF SIGNAL IN THE 90058 KS ZONE AT THE RATE OF 4504 ROTATIONS/SECOND IN ORDER TO ATTEMPT TO COMPENSATE FOR SUSPECTED GRAVITATIONAL INTERFERENCE IN SIGNAL. PROBABLE CAUSE IS A RAPIDLY ROTATING, NON-EMITTING NEUTRON STAR.

ENHANCEMENT ROUTINE:
0638499-2 MOD 003

RUNNING SIGNAL THROUGH SELECTIVE FILTER TO ATTEMPT TO DELETE VARIOUS NOISE FRAGMENTS WHICH ARE TENDING TO OBSCURE CLEAR RECEPTION. PROBABLE CAUSE IS THE TRANSMISSION TRAVELLING THROUGH AN OORT CLOUD.

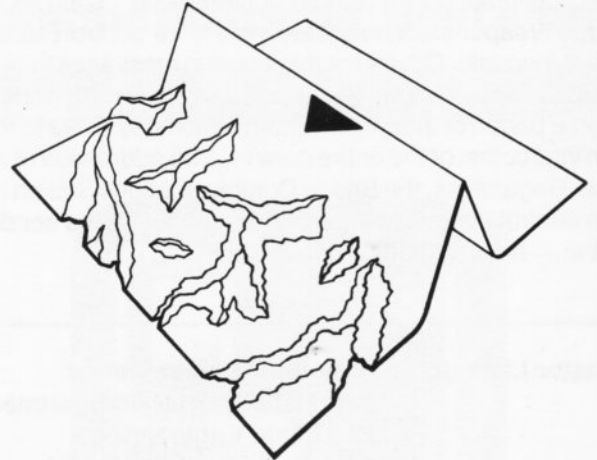
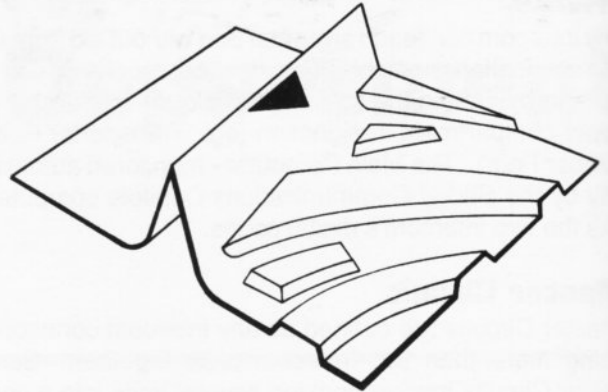

When encountering a transmission (normal-space or subspace), two tasks are faced by the Communications Department. If the signal is from an alien source, the second task will be that of translation. This is almost completely automated, relying upon a collection of concept-symbol recognition computer analog programs - known collectively as the Universal Translator (see: UNIVERSAL TRANSLATOR). However, even when the signal is in Standard English, communication cannot take place until it is legible, and transmissions are susceptible to corruption. Such factors as distance, gravitational fields, environmental radiations, enemy jamming, atmospheric conditions, etc. can cause this.

Enhancement is accomplished by running the incoming signal through a series of sub-programs which act as selectively permeable electronic filters. As shown above, this process is monitored visually, so as to ensure that the chosen sub-program does in fact improve the signal-to-noise ratio, and is in no way deleting part of the underlying message. Choice of filter and fine-tuning same calls for judgement and experience - it cannot be computer-automated

-Universal Translator

The Universal Translator exists as a sub-system within the Main Computer - comprised of its own memory and data-processing banks. As well as various cryptographic sub-routines, the majority of the memory is the Language Bank. Recorded here are the lexicons of every language from every race/species/planet that Starfleet or other Federation representatives (such as the Diplomatic Corps) have ever encountered. The Bank aboard each Starship is constantly being updated as new races are discovered by surveying Starfleet vessels. Even when an intelligent race is protected from contact by the Prime Directive, it is the surveying Captain's responsibility to acquire a lexicon of the new language, and to subsequently forward this lexicon to Starfleet Headquarters, from where it will be distributed via specially-coded Subspace channel to all Fleet vessels.

When encountering an alien transmission, the Communications Officer will - at the CO's order - hook in the Universal Translator, which will submit the incoming message to a variety of steps:

Step 1: Scan the Language Banks to see if the incoming message matches an already existing filed lexicon. If so,

Communications Department

access file and interpret it (two-way) in realtime. (eg: Vulcan).

Step 2: Scan the Language Banks to see if the incoming transmission or portion of same may be a degenerate/branch-off form of a filed lexicon. If so, analyse changes, establish pattern, create new lexicon file, access file and interpret it (two-way) in realtime. (eg: Romulan).

Step 3: Record the incoming transmission. At the end, analyse it as a unit, and correlate translation looking for logical consistencies and pattern. Create new lexicon file. Alert Communications Officer and play-back the stored translated transmission.

Once translation is possible, the Universal Translator will dub the new vocal over the original, adjusting grammar and punctuation, while attempting to match the original voice pattern. Outgoing messages will also be translated.

-Transmission Encoding

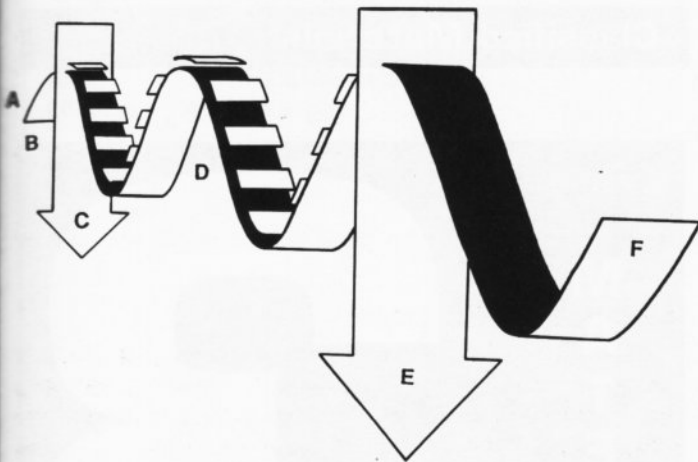

- A) Carrier Wave
- B) Signal at Transmitting End
- C) Taped Encoding/Masking Signal
- D) Encoded Transmission
- E) Taped Decoding/Unmasking Signal
- F) Signal at Receiving End

All transmissions between Starfleet vessels and facilities are encoded as a matter of course. Both sender and receiver have an identical selection of Encoding/Decoding tapes. When transmitting, the entire message - except for the prefix - will be scrambled by the Encoding Tape, which consists of a series of randomized signals. The prefix states: Sender, Intended Receiver, Priority Level, Decod-

ing Tape Necessary. Tapes C through Z are used randomly (to prevent an enemy from learning a pattern through repeated usage), and the entire C-Z set are replaced by Starfleet Logistics every five years. These are kept at the Bridge Communications Station. Tape B is kept locked-up in the Communications Officer's safe, and can be accessed only by that officer or the Captain. A B-Encoded transmission must be routed to that office to be decoded, as the tape may not be removed from that location. Likewise, Tape A is kept in the Captain's personal safe, and indicates that an incoming message is for the CO's eyes only. Tapes A and B are replaced (by hand courier) at least four times per year. All Encoding/Decoding tapes carry a minimum GRADE-2 Security Classification.

Should Starfleet Command learn - or suspect - that an enemy of the Federation has broken an Encoding/Decoding tape's pattern, they will alert the Communications Officer of every vessel and facility of this suspicion, and order them to discontinue usage of this tape at once.

-Code Phrasing

Even with the elaborate scrambling methods into modern communications systems, some circumstances still require that an officer separated from his vessel or command be able to transmit information or orders to said vessel without speaking plainly - either for fear of being overheard, or for lack of time. To resolve this, three groups of code-words are described. They consist of: Situation Codes; Transporter Identification Verification Codes; and General Orders. In the first two groups, the code-words given as examples are not to be utilized, as they have been compromised by this publication. Each vessel - while keeping their meanings intact - will replace the sample code-words [in parentheses] with its own set. In the latter group no such need for secrecy exists.

Situation Codes: If an officer is in a circumstance where he can either be overheard, or has been captured and is being forced to read a prepared, innocuous statement, but wishes to advise his vessel of the true nature of his situation without being understood by his captors, he will utilize Situation Codes. All personnel aboard a particular starship will have memorized a list of code-words. To alert the ship that he is in fact slipping these code-words into his message, the officer will use a pre-agreed code-prefix within the same sentence. This code-prefix would never be spoken by that or any other officer within a message unless one or more code-words are within that sentence. By using two or more of the appropriate code-words, the officer can state both the situation and his recommended course of action or orders.

Code-Prefix:
[Absolutely]

Starfleet DYNAMICS

Code-Word:	Meaning:
[Unlikely]	Situation Suspicious
[Surprising]	Situation Problem
[Strange]	Situation Critical
[Unusual]	Situation Captured
[Regular]	Initiate Rescue Operations
[Notice]	Go to Intruder Alert
[Whenever]	Allow no access without TIV Codes
[Repeat]	Take no Action
[Nothing]	Go to Red Alert
[Timely]	Execute General Order 3

Example Usage: Captain to Intrepid, absolutely nothing irregular or unusual.

Meaning: Go to Red Alert - We are captured - initiate rescue operations.

Transporter Identification Verification Codes: The speed and reach of the Transporter provide a real danger of unauthorized personnel boarding a ship. It is possible for an enemy to gain access to a vessel by imitation of words/manner/vocal pattern/appearance of authorized personnel using captured equipment. To prevent this, officers beaming down to a potentially dangerous location utilize a code-group consisting of a challenge and response, chosen at random from a list before the officer beams down. Subsequently, when the officer requests to be beamed-up, the Transporter Officer will issue the challenge - and await the proper response. If the officer cannot reply correctly, the Transporter Officer will not energize - and will immediately inform the Bridge and acting CO of the attempt. For memorizing, all TIVC's are tri-d chess moves, consisting of a piece name and a board-square location. here are thousands of possible combinations

Example Usage -	Challenge: [K to B - Level 3] Response: [Kt to R - Level 1]
-----------------	--

General Orders: It is possible that an officer - captured or on the run - may have momentary access to communications with his ship, such as during the forced reading of a prepared statement, and may wish to overtly order his vessel to carry out an action which he does not mind being understood, but which he would not have time to adequately describe his wishes. For such contingencies, a list of General Orders has been prepared. Unlike the Situation Codes and TIVC's, the General Order numbers and definitions do not vary from ship to ship, nor are they secret. Their publicity enables a captured officer who manages to thus signal his vessel to use said General Order as a bargaining

tool. To cancel any General Order, the issuing officer would have to give the correct TIVC, followed by "Countermand".

General Order:	Meaning:
[One]	Go to Red Alert - Raise Shields
[Two]	Do not respond to further messages
[Three]	Proceed to the Nearest Starbase
[Four]	Relay Situation and Log Entries to Starfleet Command
[Five]	Self-Destruct in One Hour
[Six]	Self-Destruct in Twenty-four Hours
[Seven]	Destroy These Coordinates in One Hour
[Eight]	Destroy These Coordinates in Twenty-four Hours
[Nine]	Destroy all Military Targets in One Hour
[Ten]	Destroy all Military Targets in Twenty-four Hours
[Eleven]	Destroy all Civilian Targets in One Hour
[Twelve]	Destroy all Civilian Targets in Twenty-four Hours

Classified Materials



Classified information is generally typed as Top Secret, Secret, or Confidential. All classified materials carry an emblem for quick identification. Standard definitions for the various classifications follow:

Communications Department

Grade 3: (Top Secret) Of such importance to the defense of the Federation that unauthorized disclosure would result in grave damage to the Federation.

Grade 2: (Secret) Unauthorized disclosure would endanger Federation security or cause serious injury to the interests or prestige of the Federation.

Grade 1: (Confidential) Unauthorized disclosure would be prejudicial to the interests or prestige of the Federation.

If any officer or crewman comes across classified material which has been left unguarded, misplaced, or improperly secured, he should not read, examine, or try to decide what to do with it. The Chief of Security should be notified at

once, whereupon the discovering person should remain with the material until it is retrieved. This material may be in the form of a booklet, a console display, or a holographic memory wafer. Its classified status will be instantly recognizable due to the emblem on one corner.

All Starfleet personnel are cleared for military and sensitive information, especially those officers above the grade of Commander. However, any item of classified data carries with it a need to know. Briefly; if an officer's duties do not require him to be familiar with a particular item of classified data, then it is in the best interests of Starfleet and himself that he does not needlessly examine it.

Equipment

-Type 2 - Field Communicator

Particulars:

Length	115 millimeters
Width	65 millimeters
Height	27 millimeters
Range	1,000,000 kilometers
Lifetime	4 hours usage

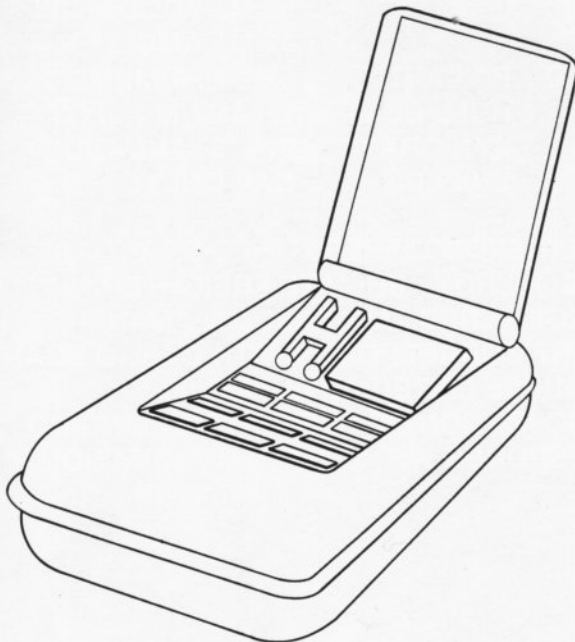

-Type 3 - Combat Communicator

Particulars:

Length	120 millimeters
Width	65 millimeters
Height	27 millimeters
Range	5,000,000 kilometers
Lifetime	24 hours usage

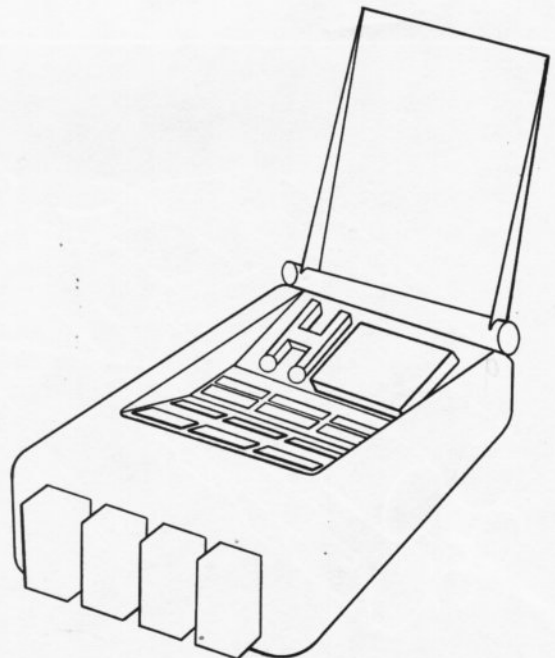

Starfleet DYNAMICS

Sensors

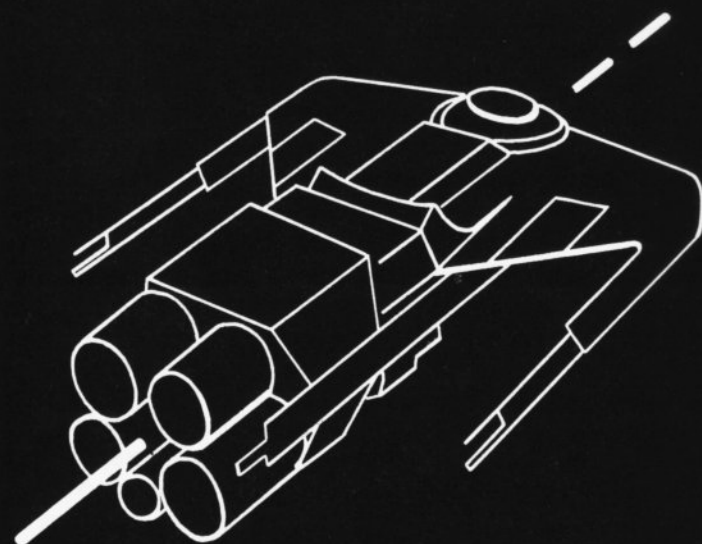
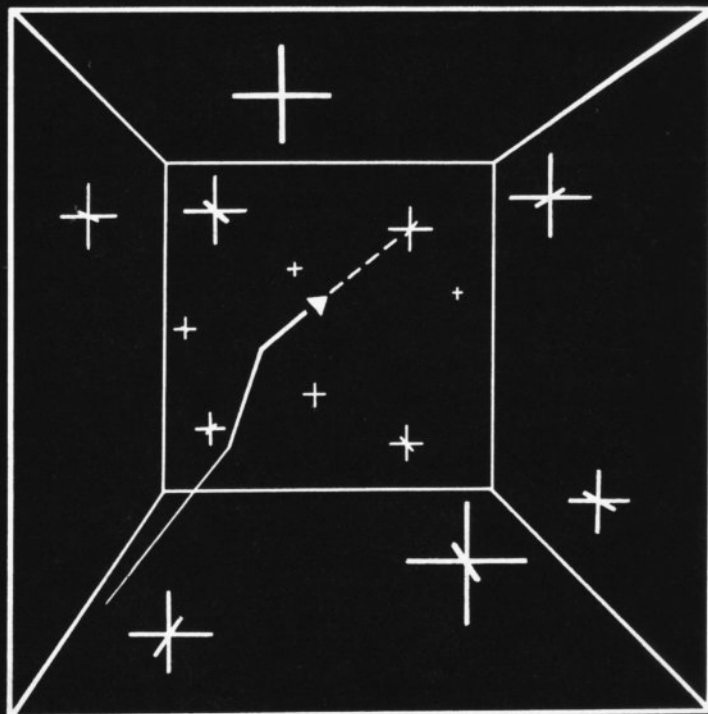

TACTICAL: SECTOR OVERLAY

TACTICAL: CLOSE-UP

SECTOR-7 COORDINATE [20/15.1/12]

SENSOR READOUTS

TE -	RANGE	= 14.7 PARSECS
	SPEED	= wf 5.3
S/E-	MASS	= 30,000 MT
	LENGTH	= 105 METERS
	DRAFT	= 37 METERS
	BEAM	= 64 METERS
DYS-	LIFEFORMS	= 47
	SPECIES	= 35 HUMAN
		= 12 TELLAR
GPE-	CARGO	= 45 MT ZENITE
		= 60 MT FOODSTUFFS
		= 12 MT AMULEEN
NED-	P/PLANT	= 89% OPTIMUM
MR -	HULL COMP	= TITANIUM ALLOY
FSF-	SYN GRAV	= 97% STANDARD
	SHIELDS	= NAV ONLY

TRANSPONDER IDENTIFIES CRAFT AS S.S. KILROY - PRIVATE FREIGHTER. REGISTERED: MARS-SOL IV. MANIFEST CORRESPONDS WITH CARGO SCAN. COURSE LISTED AS ALTAIR III. PROJECTION OF PRESENT HEADING CORRESPONDS WITH LISTED DESTINATION.

Communications Department

The term Sensor denotes any device which collects data for analysis. Operating on the frontiers of the Federation, it is imperative that Class 1-B starships have the best and latest Sensors with which to accurately analyse their surroundings.

Sensors are usually mounted in Banks, with the Sensors for a particular function mounted together. There are three types of Sensor Banks on a Class 1-B starship: Engineering, Navigation, and Science.

-Engineering Sensors

There are two types of Engineering Sensors. The Space/Energy Sensors are generally mounted on the Main or Secondary Hull of a vessel, facing forward (the Mark 9-B Heavy Cruiser has three of these mounted on the Secondary Hull, around the Navigational Deflector Dish, below and to each side). The Inlet Flow Sensors are built into the front of the Warp Drive Nacelle

Engineering Sensor Types:

- S/EM - Space/Energy Matrix Sensors
- IF - Inlet Flow Sensors

-Navigational Sensors

Navigational Sensors are mounted in two Domes, located atop and below the Primary Hull's vertical axis. They are designed to function in parallel with both the Navigational and Ordnance Computers. Each Dome actually contains two distinct Banks: One set for slower-than-light speeds, and one for faster-than-light speeds

Navigational/Ordnance Sensor Types:

- Short-Range

- WSV - Wide Spectrum Visual
- PS - Photic Sonar

- Long Range

- TVT - Tachyonic Visual & Tracking
- TER - Tachyonic Echo & Ranging
- S/ED - Space/Energy Matrix Distortion
- GS - Gravitational Strain Sensor

-Science Sensors

The Science Sensors are located in a Bank below the Primary Hull, just above the Navigational dome. The OC4221U Science Bank is divided into four bays, facing forward, aft, starboard, and port. Unlike the Engineering and Navigational Sensors, the Science Sensors are quite

flexible in usage and optimum sensitivity range. Short-Range Sensors denote those operating in the Electromagnetic Spectrum, while Long-Range Sensors denote those operating in the Tachyonic Spectrum.

Science Sensor Types:

- Short Range

- MSV - Multi-Spectrum Visual
- NED - Neutrino Emission Detector
- MR - Magnetic Resonance
- LS - Laser Spectroscopy
- DYS - Dyno-Scanner (Chemical Reaction & Organic Lifeform Detector)
- FSF - Full Spectrum Field Sensor

- Long Range

- GPE - Gravitational Pulse Penetration Echo (Deep Radar)
- TTV - Tachyonic Telescopic Visual
- TEA - Tachyonic Emission Analysis

Computer Systems

System Architecture

- Main Computer - Processing Systems
- Memory Systems
- Peripheral Systems
- Central Processing Unit

-Duotronic Theory

Duotronics is a combination of hardware and software systems developed by Dr. Richard Daystrom. It is based upon the utilization of solid circuitry, reducing the distance which data must travel while allowing three-dimensional data stacking. Data exists as magnetic quanta (monopoles) held suspended as part of an array within a section of superconducting material. The use of monopoles allows for incredible data compaction, which coupled with the short distance said data must travel while under processing manipulation within a wafer translates into ultra-fast processing speed.

A Duotronic Wafer can be either a Processor (which is designed for the rapid manipulation of data according to loaded instructions), a Monopole Memory (which is designed for the rapid recording and playback of data), or a Holographic Memory (which is designed for the permanent storage of data). The following illustration shows both the external and internal arrangement of a Duotronic Processing Wafer, as well as component basic functions.

Starfleet DYNAMICS

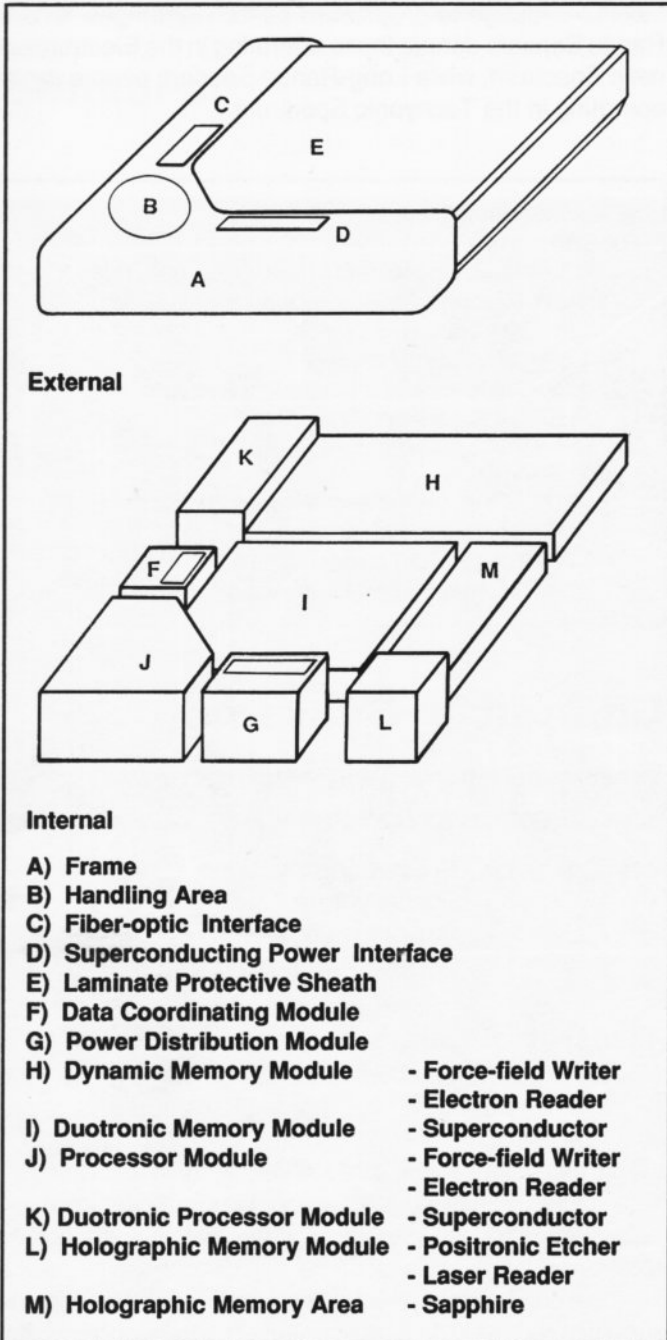

-Connections and Interfaces

All linkages within a Wafer utilize superconducting wire. Data linkages between Wafers is accomplished via fiber optic cable, while power is delivered to Wafers over superconducting cable.

Processing Systems

-Hardware

Duotronic Processing Wafer:

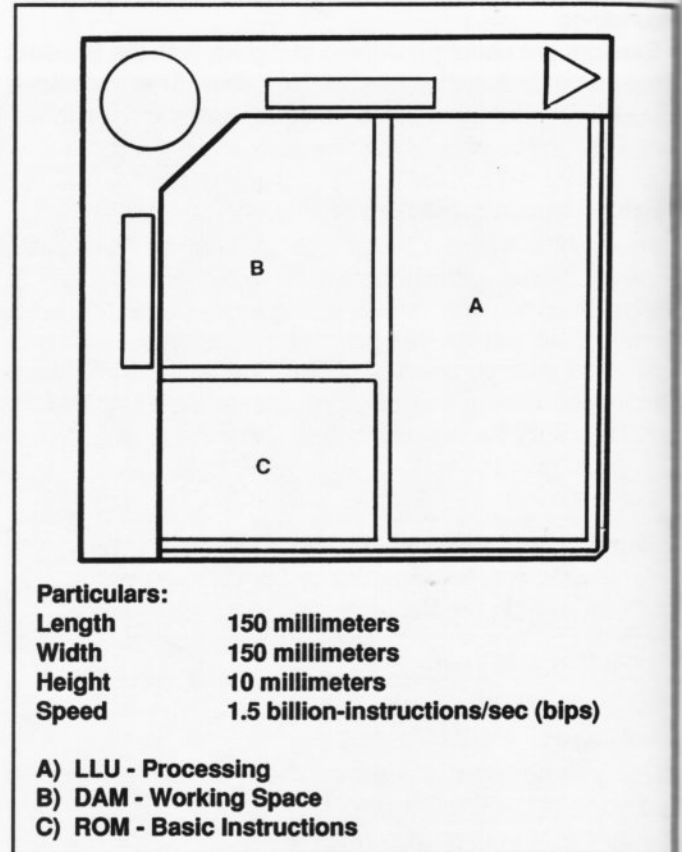

Processor Wafers contain three areas; LLU (Logarithmic Logic Area), DAM (Dynamic Access Memory), and ROM (Read-Only Memory). The LLU - a section of superconducting ceramic - is the largest and provides the space in which data is manipulated. The DAM - another section of superconducting ceramic - provide working space for the LLU, a scratchpad where sub-solutions can be parked while the LLU moves on to the next stage of calculation.

In both cases, data is written by a built-in force-field generator, which positions monopoles (magnetic quanta) within a three-dimensional array inside the superconducting section. Data is read by an electron scanner, which cascades the section and notes the distortions of the electron paths caused by the positioned monopoles.

The ROM - a section of synthetic sapphire - provides the Wafer with a permanent set of vated, the ROM re-instructs the Wafer's LLU regarding its basic functions.

In this case, data is written by a positronic etcher, which etches angstrom-sized holographic patterns on the surface of the sapphire section (not on the surface of the plastic sheath). Data is read by a microwave scanning laser.

Communications Department

Central Processing Unit:

The CPU is the nexus of the computer system, the system to which complex tasks or problems are delegated for solution. It contains 20,026 Duotronic Processing Wafers: 20,000 Primary Wafers operating in parallel, supervised by 25 Management Wafers, overseen by 1 Master Wafer. The Primary Wafers carry out the required manipulations of raw data - calculations, correlations, etc. The Management Wafers act as a switchboard for incoming and outgoing data, routing solutions to the originating console and deciding how many Primary Wafers are required to handle any particular task. The Master Wafer delegates priority treatment (if and when). Whether a Wafer acts as a Primary, Management, or Master Wafer is determined by its Basic Instructions, contained in its ROM.

The CPU also contains 15,000 Duotronic Memory Wafers. These act as working space for any portion of a problem too large for a single Processing Wafer - the Processing Wafer simply takes over the additional space of as many Memory Wafers as it requires, as directed by the Management Wafers.

Memory Systems

-Hardware Categories

Duotronic Memory Wafer:

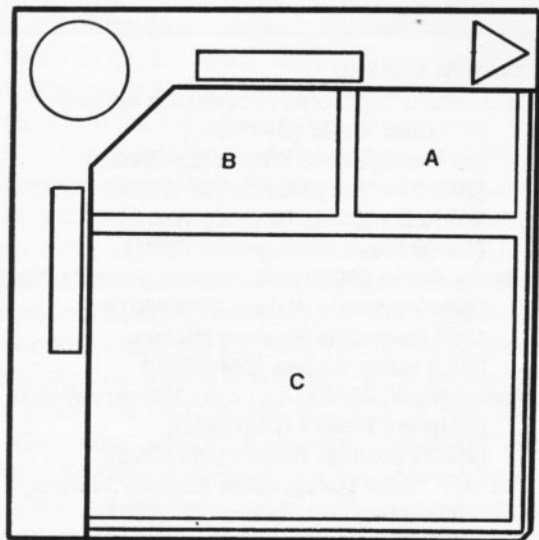

Particulars:

Capacity 1.0 gigabytes

- A) LLU - Indexing and Cross-referencing
- B) DAM - Temporary Data Storage
- C) ROM - Basic Instructions

Almost identical to the Duotronic Processor, consisting of LLU, DAM, and ROM. In this case, the LLU is very small, and only holds such information as index and cross-reference. The ROM is likewise small, and provides the LLU with a permanent set of operating instructions. The DAM takes up the majority of space, and is used for the temporary storage of data.

Since any data on the DAM will be erased when the Wafer is deactivated, the Duotronic Memory Wafer never used for permanent storage.

Holographic Memory Wafer:

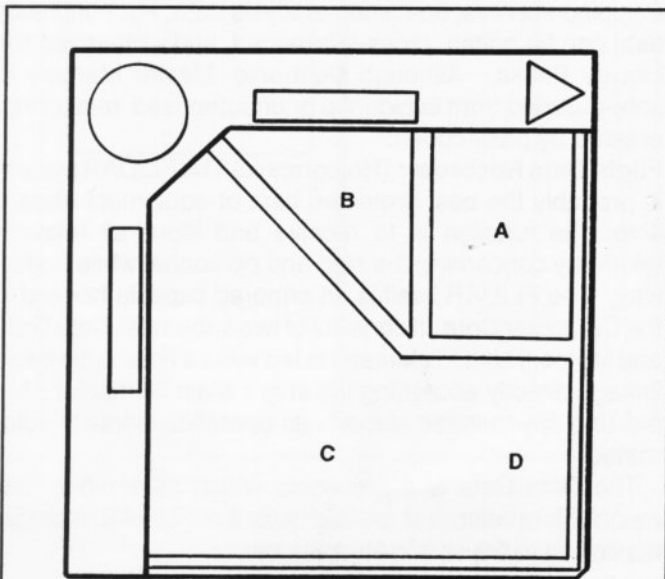

Particulars:

- Capacity 15 gigabytes
- Recording Rate 1.0 billion bytes/sec.
- A) LLU - Cross-referencing
- B) DAM - Back-up Memory Buffer
- C) ROM - Basic Instructions/Index
- D) ROM - Permanent Data Storage

Consists of four areas - LLU, DAM, and two ROM's. The LLU is very small, and holds such information as cross-reference data. The DAM is likewise small, and provides back-up memory space for data as it is fed into the Wafer. The first ROM provides both the basic operating instructions and a permanent index. The second ROM is used for the permanent storage of data. Once etched, patterns cannot be altered or erased without causing damage to the Wafer itself. For this reason, the Holographic Memory Wafer is used universally for archive-storage.

Starfleet DYNAMICS

-Memory Utilization

Memory Systems are used for a wide variety of purposes:

Library Banks: (Holographic) Contains the sum of all Federation knowledge. The volume taken up by the Library Banks comprises the largest fraction of Main Computer volume. The Library Banks are installed into a vessel upon commissioning, and are updated whenever possible, whether mid-voyage or during Starbase layover.

Working Memory: (Duotronic) Records and holds input (instructions and raw data) prior to transfer to processing. Linked in parallel with processors to increase size of problem data-base.

Master Memory: (Duotronic) Records all computer activity (input/output) intended for permanent storage (stellar mapping surveys, specimen analysis data, etc.) until said data can be edited, cross-referenced, and written into the Library Banks. Although Duotronic, Master Memory is safe-guarded from accidental or unauthorized tampering/erasure by pass-codes.

Flight Data Recorder: (Holographic) The FLIDAR system is probably the best protected item of equipment aboard ship. Its function is to receive and store all relevant telemetry concerning the ship and personnel while underway. The FLIDAR itself is an armored capsule housed in the Computer Core. It consists of two sub-units: Data Gate and Memory Unit. Telemetry is fed in via a fiber-optic cable linkage directly accessing the ship's Main Computer - bypassing any manned station. Its operation is totally automated.

The Data Gate is a processor which determines how much information will be fed into the FLIDAR memory according to the ship's Alert Status:

Normal Status	- Helm/Nav Console Telemetry - Engine Performance - Navigational Sensor Scans - Log Entries
Yellow Alert	- As above plus complete audio/video scans of Bridge and Engineering
Red Alert	- As above plus complete audio/video scans from all intership intercom units, all Computer activity, all Sensor Telemetry

The Memory Unit of the FLIDAR is a one-shot recording bank. As data is recorded it is unreachable, and cannot be edited, erased, or otherwise altered without opening the FLIDAR housing - which would have catastrophic results. This feature was added due to the recommendations of the Leading Admiral of the Court-Martial of Captain James T. Kirk on Stardate 2949. It was made apparent at this trial

that Flight Data Recorders must be made absolutely tamper-proof. The system in current usage (MM908Y) was designed in light of these recommendations by Lt. Cmdr. Benjamin Finney (rtd) - presently employed by Daystrom Duotronics.

In the event of an impending crisis, a Captain will order the contents of the FLIDAR speed-loaded into the Recorder-Marker Buoy - for jettison.

Main Computer

-Computer Core

The aggregate of CPU, Library Memory Banks, Master Memory Banks, and FLIDAR is known as the Main Computer, and is located in the Computer Core. The Computer Core runs from the Main Bridge to the Science Sensor Bank, along the vertical axis of the Primary Hull - the most protected area of the ship. Access to the Computer Core (which also holds the Emergency Bridge) is strictly controlled, and is limited to Bridge personnel and Computer Specialists.

The Main Computer is the central nervous system of the ship, and in an emergency can handle most essential functions. Although not sentient, a Starship's Main Computer is one of the largest and most powerful information manipulation and retrieval systems in existence. It has the capacity to process two billion operations per second, with a datum-size of one hundred

Component Listing:

CPU: 20026 Duotronic Processing Wafers
[1 Master Wafer (DPW401)]
[25 Management Wafers (DPW402)]
[20000 Primary Wafers (DPW403)]
15000 Duotronic Memory Wafers
[15000 Slave Wafers (DMW501)]
Library Bank: 30000 Holographic Memory Wafers
[30000 Primary Wafers (HMW601)]
1000 Duotronic Memory Wafers
[1000 Index Wafers (DMW502)]
Master Bank: 25020 Duotronic Memory Wafers
[20 Index Wafers (DMW502)]
[25000 Storage Wafers (DMW503)]
FLIDAR: 10000 Holographic Memory Wafers
[10000 Primary Wafers (HMW601)]

-Archival Stores

A specially-protected and armored portion of the Computer Core contains the Archival-Memory Stores. This comprises the sum total of all data within the computer system: both programs and data. In the event of computer

Communications Department

damage resulting in partial or total erasure/distortion of stored information from the Memory and Processor Systems, all Computer Systems can be restored to full operating status (after hardware damage is repaired/replaced) by reloading from the Archival Memory Stores. Said Archives are routinely updated at the end of each 8 hour Watch.

-Prioritization

CPU processing time and space is assigned to incoming tasks on a first-come, first-serve basis, according to the complexity of the task, as determined by the Management Wafers. Every peripheral possesses its own channel into the Main Computer, and the CPU is normally capable of handling any workload with negligible delays. However, in the case of an urgent and immensely complex problem, priority treatment for that problem can be requested. Any officer may request Priority Access from the Master Wafer, giving his name and rank. This will result in a sizable fraction of the CPU being brought on-line to solve that task (up to 50%). All such Priority Accesses are recorded in the Computer Activity Log, and are flagged for review by the Exec, who checks to see that the requests were warranted. Total Priority Access (up to 97%) can only be requested by the Computer Officer, who will identify such a problem as "Class A".

Peripheral Systems

Peripherals are the equipment not within the Main Computer with which it exchanges data. Peripherals are divided into Work Stations, Action Stations, and Remotes.

Work Stations: Refers to equipment an operator uses to interface with the Main Computer. These can be consoles (such as the Helm Console) or remotes (such as the DCU or Intercom). Each Work Station possesses its own collection of built-in Duotronic Processing and Memory Wafers known as the Dedicated Applications Unit - DAU. The task of the DAU is to take data from the operator (via keyboard or microphone) and pre-process it. If the task is within the DAU's capabilities, the DAU will then display the solution to the operator via screen or speaker. If the task is beyond its capabilities, the DAU routes the task as raw data to the Main Computer, wherein a Management Wafer will assign as many Primary and Slave Wafers as are needed to the task. Once solved, the solution will be re-routed back to the originating DAU, which will act as a repository for said processed data or display it for the operator.

Action Stations: Refers to unmanned equipment operated remotely from a Work Station (such as an Airlock Door, an Air Recycling Unit, or a Sensor). Action Stations usually have a DAU which carries out most of the routine functions autonomously, reducing the demand on both the operator and the Main Computer.

Remotes -Data Coordinating Unit:

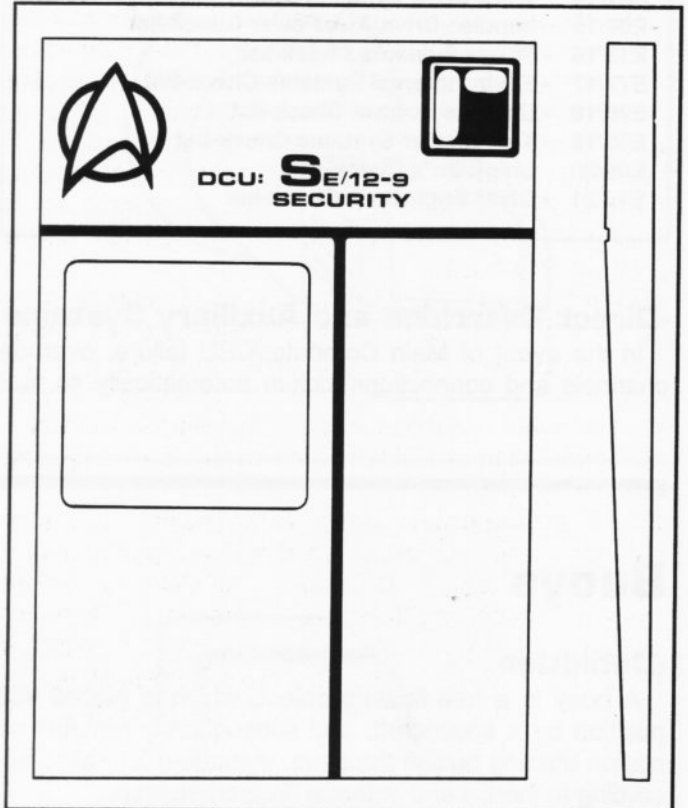

Every Department and Division utilizes the DCU, also known as the Electronic Clipboard. The DCU is a portable computer terminal, which is linked to the Main Computer via an encoded transceiver such as that used in the Intercom network. The DCU allows the operator freedom to access the Main Computer during any activity, and is particularly useful during walking inspections and check-lists. All have built-in data screens coupled with microphone/speakers, as well as a DAU. There are twenty-two varieties of DCU utilized aboard ship:

- 093/1 - Captain's
- 042/2 - Executive Officer's
- 063/3 - Auxiliary Craft Check-list
- 011/4 - Personnel Duty Roster
- C32/5 - Cryptography Notepad
- C21/6 - Electronics Check-list
- Q54/7 - Maintenance Check-list
- Q55/8 - Quartermaster's Inventory
- S12/9 - Security Officer of the Watch
- S14/6 - Life Boat Officer's Muster
- M66/10 - Medical
- A79/11 - Navigational Almanac

Starfleet DYNAMICS

- A81/12 - Ordnance Check-list
- A83/13 - Yeomans's Forms
- E01/14 - Warp Drive Systems Check-list
- E09/15 - Impulse Drive/Aux Power Check-list
- E13/16 - Power Systems Check-list
- E77/17 - Environmental Systems Check-list
- E99/18 - Damage Control Check-list
- E68/19 - Transporter Systems Check-list
- E05/20 - Shipfitter's Check-list
- E15/21 - Chief Engineer's Check-list

-Direct Overrides and Auxiliary Systems

In the event of Main Computer/CPU failure, override channels and connections kick-in automatically so that

Work Stations and Action Stations are not isolated from each other. For example, a secondary fiber-optic cable links the Bridge Environmental Work Station directly to all Action Stations under it (Air Recycling Units, etc.). On the other hand, the Bridge Science Station has direct access via link to the Library Banks - never going through the CPU (as would any other Work Station requesting information from the Library Banks). This assures the Captain instant access to any information he requires, even if the Main Computer is down. In the case of the Weapon's Console, its DAU is so large that it is autonomous of the Main Computer, and has been designated the Fire-Control Computer. Similarly, both the Engineering and Navigation Departments have separate auxiliary computers, so that failure of the Main Computer will not result in a crippling loss of power, propulsion, or environment.

Buoys

-Definition

A buoy is a free-floating object, which is placed into position by a spacecraft, and subsequently remains on station utilizing built-in thrusters, computer-controlled according to inertial and external (Pulsar) sensors.

-Types

Different types of buoys are used for different functions,

depending upon why and where they are stationed. Obviously, the further a buoy is positioned from major spacelanes or Starfleet patrol routes, the larger its onboard powerplant must be, since it must function longer between refuelings. Due to powerplant characteristics and computer requirements, the average buoy is shuttlecraft-sized.

Most buoys have three types of transmissions: Subspace Radio, Real-space Radio, and Visual Beacon. Strength of these transmissions depends again upon position and purpose. All spacecraft carry starcharts which list the coordinates and types of most buoys.

Civilian Types

-NA-1 Sector Corner-Marker:

Stationed at the corner coordinates of Sectors (each buoy is the corner-marker for eight Sectors). It transmits two signals, each of which is its identity-code and its coordinates. The first signal is transmitted along six tight beams toward the six adjoining corner-marker buoys with a range of eleven parsecs. The second signal is broadcast omni-directionally, with a range of twenty parsecs.

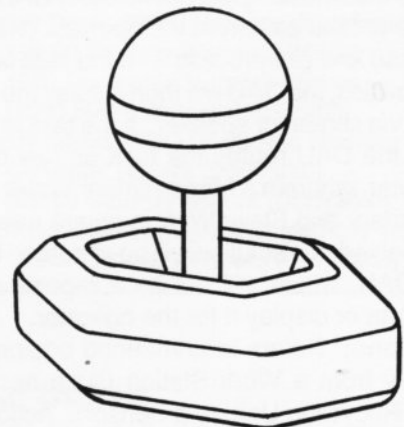

Communications Department

-NA-2 Navigational Spacelane Marker Buoy:

Stationed along the major spacelanes at 0.10 parsec intervals, as well as at spacelane intersections. It transmits two signals, each of which contains its identity-code and its coordinates. The first signal is transmitted along two or more tight beams towards the adjoining buoys (along the spacelanes) with a range of 0.15 parsecs. The second signal is broadcast omni-directionally, with a range of three parsecs.

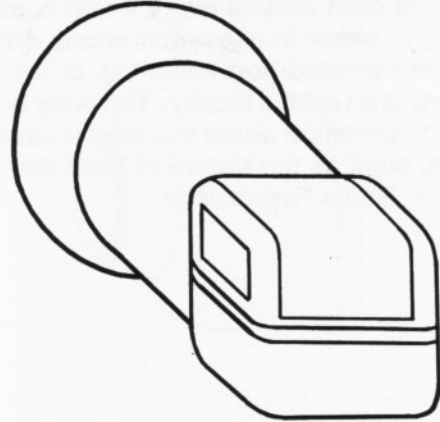

-NA-3 System Traffic Buoy:

Stationed in a cubic array around most Federation member solar systems, at a distance of 0.10 from the principal star. Its primary purpose is to sense incoming and outgoing spacecraft - relaying all telemetry to Spacecraft Control. A secondary purpose is to relay navigational and system meteorological reports and warnings.

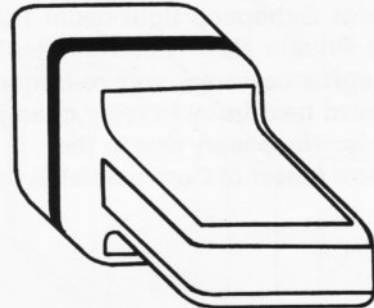

-NA-4 Hazard Buoy:

Place near (or anchored to) any hazard to interstellar or interplanetary navigation, such as a rogue planet, derelict vessel, or asteroid field. The purpose of the buoy is to warn oncoming spacecraft of the presence, coordinates, and type of hazard in its vicinity, so that the vessel will have ample time to steer clear. It is similar to the NA-2, the difference being that the sensor antennae has been replaced with a subspace signal booster.

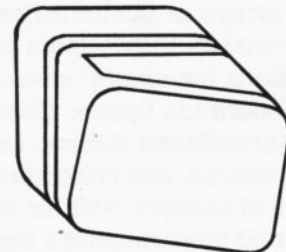

-NA-5 Spaceport Buoy:

Placed in orbit around every world possessing a spaceport - either in geosynchronous orbit (above the surface-located port facilities), or tractor-beam anchored to an orbital facility. The buoy broadcasts various information about the spacecraft to incoming craft, such as the Nature of Facilities Available and Local Traffic Regulations.

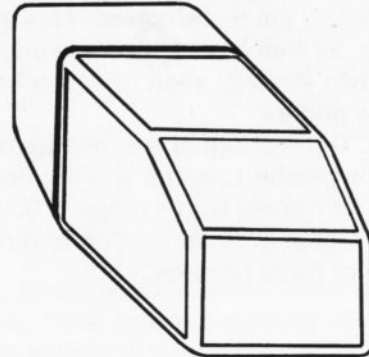

-CO-6 Communications Relay Buoy:

Scattered throughout the Federation, making-up the Civilian Communications Network. Designed to pick-up faint Subspace tight-beam transmissions within the Private News/Entertainment Band, amplify and enhance same, and re-transmit as tight-beam (toward next buoy in relay chain) and broadcast signals. Necessary due to the relatively low power of Commercial Subspace transmitters.

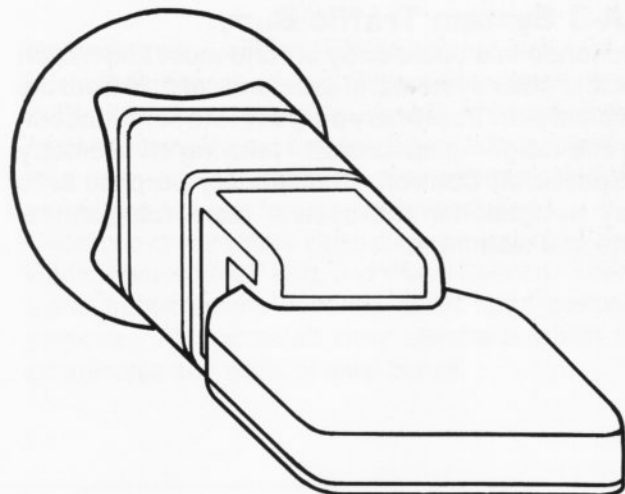

Military Types

-MI-8 Surveillance Buoy:

Placed in arrays or scattered separately, surveillance buoys are set-up in Sectors suspected of being traffic corridors for enemy vessels making incursions into Federation Space. Should a vessel pass through a surveillance Sector, the buoy will note vessel type, course, and characteristics (all on passive sensors of course), wait for the vessel to leave the vicinity, and then transmit a signal to the nearest Starbase along a tight subspace beam. The buoys are designed to be almost undetectable to sensors, and will self-destruct should any unauthorized vessel (without a pass-code) attempt to close in.

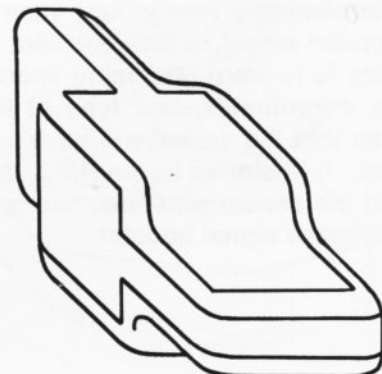

Communications Department

-MI-9 Interdiction Buoy:

Stationed in groups surrounding secret or sensitive Federation projects (such as Space-station Labs, Research & Development Proving Grounds, etc.). Should an unauthorized vessel approach, the beacon will activate - warning-off the would-be visitor. For obvious security reasons, the beacons are of relatively short range.

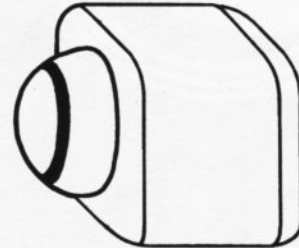

-MI-10 Guardian Buoy

Stationed in orbit around any planet which the Federation Council has declared requires isolation and protection from outside contact and interference. The buoy broadcasts a distinct warning to any vessel approaching within 0.50 parsecs. Should that vessel close to within 0.10 parsecs, the buoy will send an emergency signal to the nearest Starbase. Starfleet vessels possess the override pass-codes necessary to temporarily deactivate the guardian system.

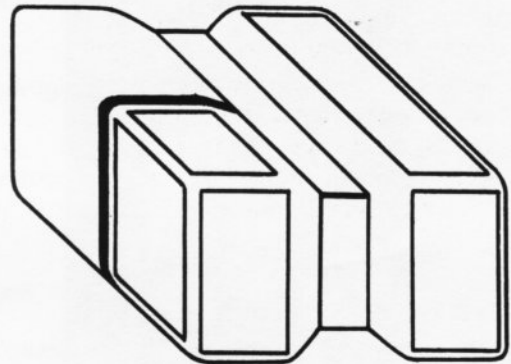



Stellar Sciences Department

Stellar Survey Procedures

Survey Stages

-Stage 1 - Exploration & Mapping

A Class 1-B starship passes through the Sector, along pre-programmed Stellar Mapping Route. All stars within the Sector are located and typed.

1 - Should a Class M planet be detected, the starship will break-off Route and investigate. Orbital and landing party examination will determine status, and whether or not contact will be made with any intelligent life discovered.

2 - The starship will resume Route at break-off point and continue. As it leaves each Sector, it will transmit all data acquired to Starfleet Operations.

-Stage 2 - Intensive Survey

A Task Force of Class 2 spaceships (Survey Vessels) will be dispatched by Starfleet Operations to survey the Sector in concert.

1 - Proceed to unmarked corners of Sector and position Corner Marker Buoys.

2 - As deemed by the Federation Council, Guardian Buoys will be placed around any star systems needing the protection of the Prime Directive.

3 - All stars within the Sector will be visited, and all interstellar objects (nebulae, etc.) will be extensively scanned. All planets within the Sector will undergo geophysical and cartographical study.

-Stage 3 - Diplomatic Liaison

Diplomatic Cruisers will visit each Class M world whose inhabitants are deemed ready for Federation contact. Systems which meet the ethical standards of the Federation will be invited to join. Exchange of diplomats and the setting-up of embassies will be arranged, with ambassadors from the planet given passage to the Federation Council.

Stellar Types

Stars are divided into Types according to color, which denotes such qualities as Temperature, Internal Composition, and Dynamics. Most Types cover a wide range of sizes, from Supergiant down to Dwarf. Of the Stars listed in the 2290 Stellar Survey, over 99% fell into the Main Sequence (Types O-B-A-F-G-K-M). It should be noted that this is a spectra sequence only, stars do not change from one Type into another (unless it is to neutron star or black hole).

Stellar Types						
TYPE	SEQUENCE	EMISSION COLOR	TEMP °C	COMPOSITION	COMMENTS	
WC	UV Seq	White/UV	50000	Carbon/Hydrogen Extremely Hot	Short-lived	Baal [Dwarf]
WN		White/UV	45000	Nitrogen/Hydrogen Very Hot	Short-lived	Hancefi [Giant]
O	Main Seq	Blue	30000	Ionized Hydrogen	Not Suitable for Class M	Iota Orionis [Giant]
B		Blue-White	20000	Neutral Hydrogen/ Helium	Brightest in Main Sequence	Rigel [Giant]
A		White	11000	Hydrogen Predominant	Very Bright	Altair [Giant]
F		Yellow/Green	8000	Hydrogen Decreasing Metals Increasing	Fairly Rare	Procyon [Med]
G		Yellow	5500	Hydrogen With Prominent Metals	Majority of Class M	Sol [Medium]
K		Orange	4300	Metals Predominant Over Hydrogen	Fair Proportion of Class M	40 Eridani A [Medium]
M		Red	3300	Metals/Hydrogen & Titanium Oxide	80%+ of All Stars (Dwarves)	Betelgeuse [Supergiant]
C	IR Seq	Red/IR	3000	Type M With Carbon Corona	Variable as Soot Outgasses	L97-12 [Dwarf]
S		Infrared	2500	Type C With Zirconium Oxide	Sooty Shell Absorbs Light	L11654-32 [Dwarf]
X		X-Ray	500000	Neutronium	Neutron Star or Pulsar	L11654-33
Z		Variable	?	?	Black Hole	Galactic Core [11 km/s]

Starfleet DYNAMICS

Planetary Classification

The following is a Planetary Classification Chart, listing the fourteen basic planet types to be found within stellar systems. It is important to note that in some cases the classification into which a planet falls depends upon many factors. For example, a gas giant may fall into classification A, B, or L depending upon its size and temperature. Likewise, the only factor separating I and J is orbital situation.

Planets are identified by the Star Name followed by a number denoting its orbital position. Moons are identified by their Planet's identity followed by a letter denoting their orbital position.

Planetary Classification

IDENT	DESCRIPTION	COMPOSITION	ATMOSPHERE	COMMENTS
A	Gas Supergiant	Metallic Hydrogen	Gaseous Hydrogen & Compounds	Failed Star Sol V [Jupiter]
B	Gas Giant	Liquid Methane & Hydrogen	Gaseous Hydrogen & Compounds	Less dense than GSG Sol VI [Saturn]
C	Reducing	Iron/Silicate	Carbon Dioxide [Very hot & Dense]	Greenhouse Effect Sol II [Venus]
D	Geo-plastic	Magma Surface	Rock Vapour & Chlorine	Extremely Young L224-8 II [Excalabia]
E	Geo-metallic	Heavy Elements & Silicates	Ammonia	Heavy Metal Rich Janus VI [Motherlode]
F	Geo-Crystalline	Light Elements & Silicates	Oxygen/Nitrogen & Trace Toxins	Light Crystal Rich Delta-Vega II
G	Desert	Metals/Silicates	Oxygen/Nitrogen & Metal Vapor	Heavy Crystal Rich Rigel XII [Hell]
H	Geo-thermal	Silicates	Toxic Complex Hydrocarbons	Forming A. Centauri V [Rhodes]
I	Asteroid/Moon	Metals/Silicates	Types 1-3 None Types 4-6 Faint	Barren & Cratered Sol III -A [Luna]
J	Geo-mortuus	Light Elements & Silicates	Tenuous Halogens	Sun-baked Inner World Sol I [Mercury]
K	Sub-terrestrial	Iron/Silicate	Toxic	Small, Dome Adaptable Sol IV [Mars]
L	Outer Gas Giant	Silicates	Layered Frozen Gases	Tectonically Unstable Sol X [Persephone]
M	Terrestrial	Iron/Silicates	Oxygen/Nitrogen	Carbo/Oxy Life Cycle Sol III [Terra]
N	Pelagic	Iron/Silicates	Oxygen/Nitrogen	Class M But 97%+ Water Delta Pavonis I

-Class M Characteristics

Planets judged as capable of supporting humanoid life-forms are classified as Class M. This classification is broken-down into nine sub-classifications, which serve to identify the degree to which a tested planet varies from the standard norm (Earth has been classified as Class M-5, and as such is considered to fit squarely into the median of

the curve - and so is used as the standard). There are many different characteristics utilized in measuring a planet's habitability, so that the ideal range fits within a narrow set of parameters, designed to eliminate obvious and subtle potential risks to colonization and visitation.

The adjoining illustration is an example of a Geophysical/Cartographical Close-Range Scan.

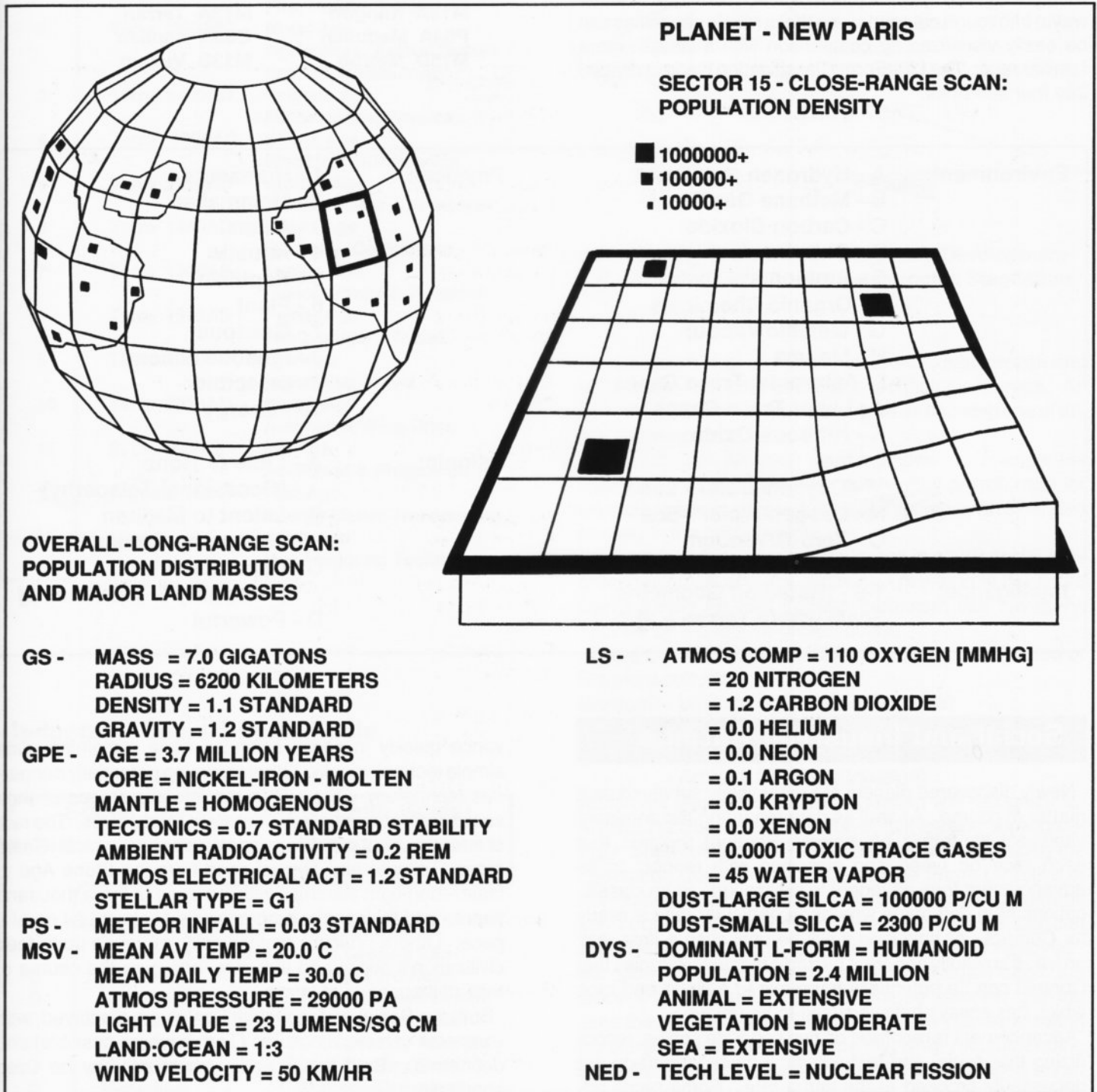

Starfleet DYNAMICS

Life-Form Classification

For purposes of filing and reference identification, each newly discovered race must be characterized and given a Life-Form Classification Code. This Code is not specific enough - nor intended - to serve as an exact description of a particular species (such a description would be volumes in length). Rather it serves as a method of grouping various widely scattered species (each of which is unique in some ways) into rough categories, so that a race's capacities can be easily visualized by comparison with a similar, more familiar race. The Life-Form Classification Code is divided into four sub-units:

Examples:

The following samples of well-known races displays how Life-Form Classification Codes are assigned:

M13A Andorian	P09D Organian
D84B Excalabian	M13A Orion
M53A Gorn	M13C Platonian
E83A Horta	M15B Talosian
B28A Kelvan	M23A Tellarite
M13A Klingon	M13A Terran
P04A Medusan	C83A Tholian
M15D Metron	M13B Vulcan

Environment:	A - Hydrogen Gas Giant
	B - Methane Gas Giant
	C - Carbon Dioxide
	D - Chlorine
	E - Ammonia
	F - Organic Chemicals
	G - Metallic Vapour
	H - Magma
	I - Asteroidal Trace Gases
	J - Lunar Trace Gases
	K - Nitrous Oxide
	L - Ice
	M - Oxygen/Water - Land
N - Oxygen/Water - Sea	
O - Zero-G/Vacuum	
P - No Requirements	
Intelligence:	1-9 - [Rated on Geometric Scale where Terran = 3]

Physical:	1 - Humanoid
	2 - Mammalian
	3 - Avian
	4 - Aquatic
	5 - Reptilian
	6 - Plant
	7 - Gaseous
	8 - Igneous Mineral
	9 - Insectoid
	10 - Energy

Psionic:	A - Little or None [Occasional Telepathy]
	B - Latent to Medium [Telepathy Common]
	C - Dependable [Telepathy & Telekinesis]
	D - Powerful

Social and Industrial Ratings

Newly discovered planets are extensively surveyed as a matter of course. As well as data regarding the dominant intelligent life-form's physiology, Starfleet requires that each race be typed and classified with respect to its advancement from savagery to civilization. Such classifications help determine whether a particular race is ready for Contact - or how long it will be until such a time may arrive. It is readily apparent by tragic historic examples that Contact can be potentially traumatic to a world and race which has always believed itself to be unique.

Advancement is recorded on two separate scales, recognizing that social and technological development do not necessarily proceed at the same rate. Some races ad-

vance quickly in social sciences while remaining quite simple technologically. Others develop potentially dangerous technology while still in the infantile stages of their social development, often damaging themselves. The rate of advancement over time varies from race to race. Some races (Tellarite and Terran) sped from the Stone Age to faster-than-light starships within a span of three thousand years - and their social progress was at almost as great a pace. Others (Vulcan) methodically improved upon their civilization's social and industrial arts over the course of tens of thousands of years.

Both the Social and Industrial Scales are displayed, with examples of historic cultures (Terran where possible) and definitions. Both the + and - modifiers may be used sparingly.

Social

Ind
RATING

1

2

3

4

5

6

7

8

9

10

11

12

13

- Indu

RATING

A

B

C

D

E

F

G

H

Sciences Department

- Social Development Scale

Industrial Development [Masters Scale]		
RATING	DEFINITION	HISTORICAL EXAMPLE Sample Technology
1	Terra 10000BC	Stone Age Fire, Hunter Gatherer
2	Terra 2000BC	Metal Age Agriculture, Animal Domestication, Metallurgy
3	Terra 1400AD	Science Age Mathematics, Physics
4	Terra 1900AD	Steam Age Electricity, Electronics
5	Terra 1950AD	Atomic Age Fission power & Weapons
6	Terra 1960AD	Space Age Rocketry, Computers
7	Terra 1990AD	Fusion Age Fusion Power & Weapons
8	Terra 1995AD	Planet Age Interplanetary Travel
9	Terra 2020AD	Star Age Interstellar Travel
10	Terra 2030AD	Power Age Antimatter/Warp Drive
11	S. Draconis 6	Ion Age Ion Power & Propulsion
12	Armand 552-6	Flux Age Energy-Matter Transmuting
13	Organia	Adult Age Non-corporeal Technology

-Anomalies

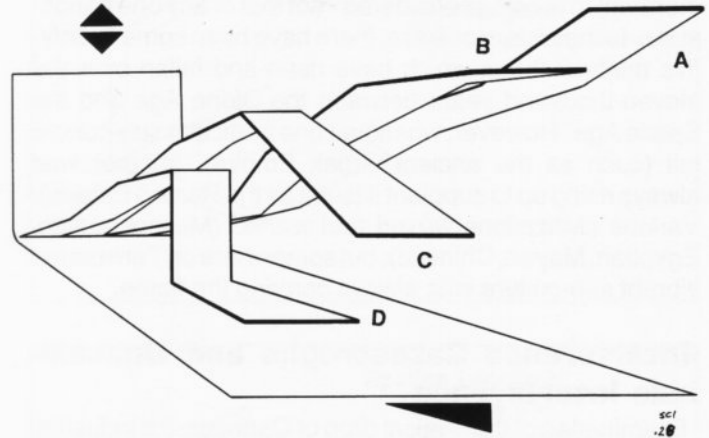

A - Healthy Growth C - Stagnated Development
B - Arrested Growth D - Catastrophic Stagnation

It is a truism that all healthy cultures exhibit growth and advancement in both social and technological areas. An unhealthy culture can be categorized as showing one of the two following traits:

Arrested: An Arrested culture shows no change (as opposed to even a very slow but healthy growth rate) for extended periods of time (millenia). Typified by an extended plateau in the growth curve.

Stagnant: A Stagnant culture is one in which social and/or technological arts are decaying - resulting in the entire planet slowly slipping through barbarism into savagery. Typified by a negative growth curve.

There are a variety of possible causes for an Arrested or Stagnant culture:

- Gradual:** - Intentional (Religious Doctrine)
- Accidental (Depletion of Resources)
- Catastrophic:** - Natural (Ice Age, Disease)
- Artificial (Warfare, Invasion)

Remedial Measures: A wise Captain will recognize an Arrested or Stagnant culture for what it is - and act accordingly. Such cultures are - by the definitions accepted by the Federation Council - not subject to the Prime Directive of Non-Interference, which protects living, growing cultures from contamination. With his Science teams, a Captain can often identify the one or more factors which - if removed - will allow an anomalous culture to once again begin the process of progress, in its own unique manner. Having done this, the Captain will then vacate the planet, allowing the planet to develop independently, while recommending to the Federation Council that the planet be placed under the protection of the Prime Directive, so that a watch can

- Industrial Development Scale

Social Development [Richter Scale]		
RATING	DEFINITION	HISTORICAL EXAMPLE
A	Isolation/City-State	Athens, Greece
B	Theocracy/Monarchy	20th Century Iran
C	Fascism	German 3rd Reich
D	Imperialism	Roman/British Empire
E	Totalitarianism	20th Century USSR
F	Democracy	20th Century America
G	Technocracy	21st Century Terra
H	Mentalism	Metrons/Organians

Starfleet DYNAMICS

made of its progress at intervals.

Note: It is important to remember that when referring about Social and Industrial development, it is the Global development which is being considered - not that of any one nation-state. In the history of Terra, there have been some twenty-five major cultures which have risen and fallen over the eleven-thousand years between the Stone Age and the Space Age. However, whenever one particular sub-culture fell (such as the ancient Greek Empire), another was always rising up to supplant it (such as the Roman Empire). Various civilizations waxed and waned (Mesopotamian, Egyptian, Mayan, Chinese), but somewhere on Terra some vibrant sub-culture was always carrying the flame.

-Interference Catastrophe and Unavoidable Interference

Examination of the vertical drop of Canopus-3's Industrial Development shows one type of catastrophic disaster. However, it is possible for a culture to show the reverse effect - a vertical rise in Industrial Development (such as from Metal Age to Atomic Age) virtually overnight. This may be caused by internal means (imagine the vertical rise which would have taken place if Terra's Aristotle, Einstein, and Newton had been contemporaries), but it is much more likely to have been caused by outside interference. There are documented cases in which Starfleet or Federation personnel contacted planets before the imposition of the Prime Directive (or in violation of it). The results are always tragic: the innocent exposed culture gains technology and/or new philosophical/governmental patterns of force without having the stability or resilience to properly handle them. In their rush to adopt "better" ways of doing things, they often sacrifice their own unique - and valuable - cultural heritage. Worse yet, they may gain access to weapons technology which far out-strips their own wisdom - and damage or extinguish themselves irreparably. Should a starship encounter such a culture - whose technology has been artificially advanced so far of its social system that the world is a danger to itself and its neighbor planets, it is the duty of a starship Captain to educate the crippled culture in the proper usage of its new-found power.

Examples: Lotia - Suffered catastrophic upward adjustment in both Technology and Society, resulting in a parody of Terran 1920's gang-land Chicago Illinois.

Ekos - Suffered a climatic upward adjustment in Societal pattern, resulting in a planet-wide parody of Terran 1930's Nazi Germany.

It is due to such dangers of interference that private and commercial craft are forbidden by regulations from visiting any/all quarantined planets, and specifically proscribed from contacting any newly-found race themselves.

-Cultural Dynamicism Chart

The Cultural Dynamicism Chart (developed by Dr. John Gill in the mid-2250's) is a three-dimensional graph showing a planet's rate of development - with Social and Industrial development on two different axes, both plotted against Time on a third axis, and the overall development appearing as a three-dimensional line (spline). The Time scale does not correspond to the subject planet's year, rather it divides the planet's past (from its Stone Age to present) into ten equal periods. Graphs such as this enable a Captain to identify anomalous trends. The sample graph above shows a planet with normal Social and Industrial growth. Note that the rate of change need not be smooth or constant to be healthy - so long as it is indeed growing. The following examples show eight textbook anomalous cultures - Arrested or Stagnant or both.

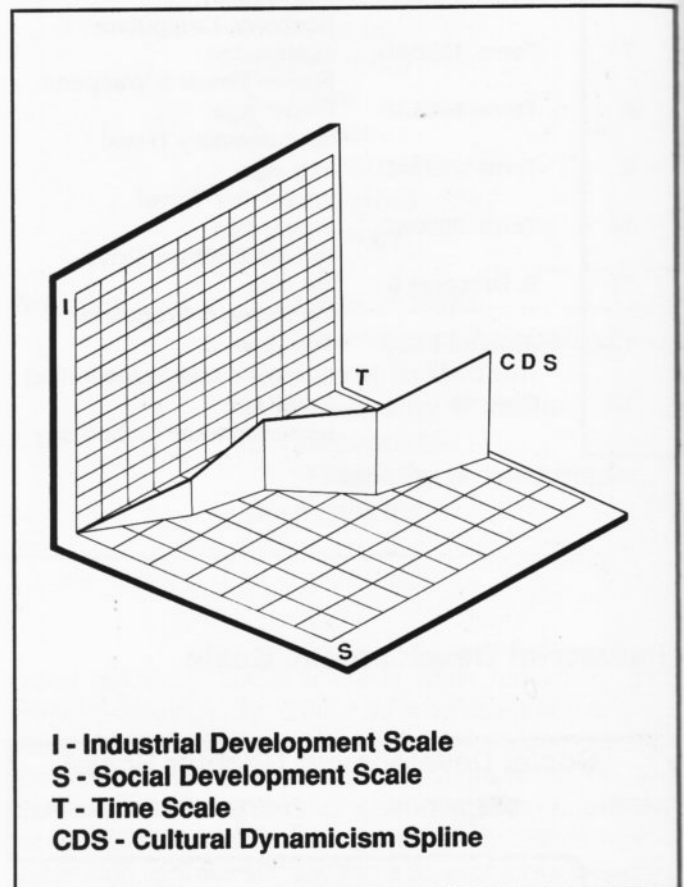

Sciences Department

Gamma Lyrae-2:
Rating = F3
SD = Normal
ID = Arrested
Reason = Theocracy

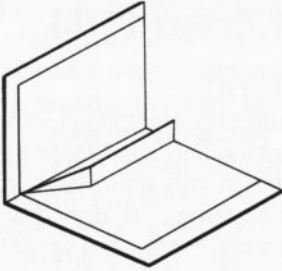

Phi Macron-3:
Rating = E2+
SD = Arrested
ID = Stagnant
Reason = Computer-run
Society

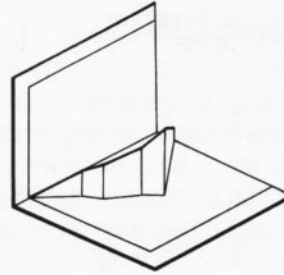

892-4:
Rating = D5
SD = Arrested
ID = Normal
Reason = Imperialism

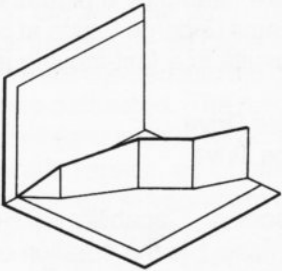

Epsilon Leonis-2:
Rating = C4-
SD = Stagnant
ID = Arrested
Reason = Invasion

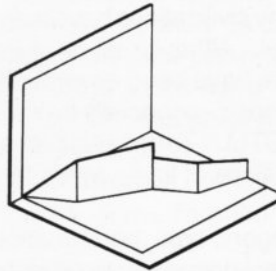

Kappa Cygni-2:
Rating = B4
SD = Stagnant
ID = Normal
Reason = Plague

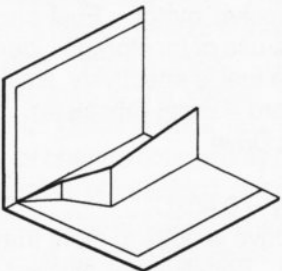

Gamma Trianguli-4:
Rating = A1
SD = Arrested
ID = Arrested
Reason = Computer-run
Society

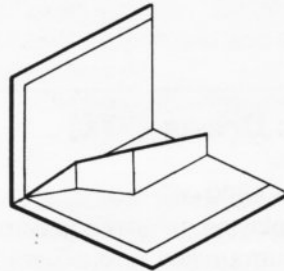

Canopus-3:
Rating = B1
SD = Normal
ID = Stagnant
Reason = Meteor Impact

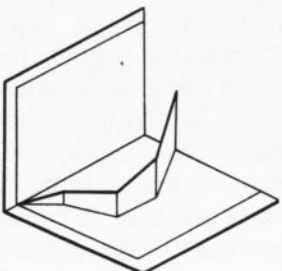

Omega-4:
Rating = A2
SD = Stagnant
ID = Stagnant
Reason = Nuclear War

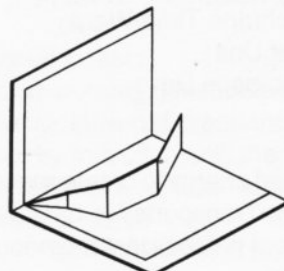

Spacecraft Analysis

An important task of the acting Bridge Science Officer is the location, analysis, and identification of any spacecraft which a starship may encounter. Using Sensor-acquired data - as correlated by the Main Computer - said Science Officer must rapidly familiarize himself with all aspects of the subject craft, so that he can instantly answer any questions his CO may put forth regarding weapons capacity, propulsion system, or origin.

Propulsion Systems

Throughout the galaxy, many civilizations have independently developed space travel. Although all have had the same end goal in mind, there have been several different styles and techniques developed - especially in the field of Slower-Than-Light drives (STL). These variations have doubtless been repeated millions of times within the vastness of the galaxy.

The following lists the category, type, performance, and description of the various space drives yet encountered. As well, some important and unique variations of types are included, along with the identification of their inventors.

-Faster-Than-Light Drives (FTL)

Warp Drive: Capability = $1800 \times C$

An intricate system employing polarized gravitronic fields to manipulate the surrounding Space/Time Matrix fabric of space, so as to envelop the vessel in a private bubble of hyper-space, which can be made asymmetrical, creating FTL momentum. Most FTL drives ever encountered function along similar principles, with similar capabilities.

Federation = Cochrane Time-Warp

Klingon = S2 Graf Unit

Romulan = Hyperspace Drive

Mega-Transporter:

Using externally generated energy to create a wrinkle in Space/Time, the Mega-Transporter is capable of hurling a vessel hundreds of parsecs instantaneously, though at considerable risk.

Kaladan = Molecular Transporter

-Slower-Than-Light Drives (STL)

Ion Drive: Capability = $0.97 \times C$

A high-power system utilizing electrically charged pods to thrust against surrounding interstellar hydrogen ions (protons), resulting in truly enormous velocities, but with light accelerations. A draw-back is extremely limited maneuverability once the vessel has achieved an appreciable fraction of C .

S Draconis 6 = Builder's Drive

Hydrogen-Fusion Drive: Capability = $0.88 \times C$

Within a spherical pressure chamber, a diffuse fog of deuterium/tritium atoms are heated by a high-energy photon beam until said atoms undergo fusion at 5000 degrees Celsius. This results in a fast-moving jet of monatomic helium ions.

Federation = Impulse Drive

S. Draconis = Space Drive

Hydrogen-Fusion Ramscoop: Capability = $0.64 \times C$

A two-phase system. Phase 1 is the creation of an enormous cone-shaped magnetic field ahead of the vessel (with the vessel at the aft point) - the outer rim of which is thousands of kilometers across. This magnetic cone acts as a non-material scoop, guiding interstellar hydrogen to an on-board fuel tank. Phase 2 is a hydrogen-fusion rocket motor. Fuel can be scooped-up for immediate use or for storage. Ideal as a military STL drive, since fuel is effectively limitless.

Federation = Bussard Ramjet (obsolete)

Klingon = Sub-light Drive

Photon Drive: Capability = $0.43 \times C$

Essentially, the photon drive is nothing more than an immense laser aimed aft. Primitive yet efficient, the laser is usually of carbon-dioxide medium enclosed within a synthetic sapphire tube.

Vegan = Light-Pressure Drive

Particle Beam Drive: Capability = $0.90 \times C$

A very inefficient/high-thrust system requiring enormous energy expenditure and an onboard hydrogen fuel tank, the system uses electrical fields to strip the hydrogen atoms into protons, and fire these charged particles aft. Ideal for weapon's propulsion systems (due to relatively low weight), the system is too inherently inefficient to drive any vessel over 50 tonnes. It is however used on larger craft in the capacity of reaction-control thrusters.

Federation = Thrusters

Nuclear Fission Rockets: Capability = 0.12xC

Also known as Steam Kettles, these drives function by passing an inert reaction mass (water, hydrogen, or zinc) through a high-temperature fission reactor (plutonium), and then venting the vaporized reaction mass aft through a rocket nozzle. Not in wide-spread usage in Federation space; although the reaction mass does not pick-up any secondary radiation, the reactor itself soon becomes highly toxic.

Terran = NERVA (obsolete)

Romulan = Secondary Drive (obsolete)

Hydrogen-Fusion Pulse Drive: Capability = 0.11xC

A brute-force approach, this system employs one or more large and thick hemispherical shells (open end facing aft) with the payload/vessel mounted atop on shock absorbers. At close intervals, hydrogen-fusion bombs are injected into the center of the shells, where they are detonated. The resultant shock-wave pushes the shell (and vessel) forward. This system is illegal in Federation space, as it creates enormous damage to any planetary environment during landing/lift-off, and leaves deadly trails of toxic debris in its wake.

Terran = ORION (obsolete)

Fabrini = Yonada Drive

Light Sail: Capability = 0.10xC

Probably the most efficient STL drive yet invented, but with relatively low yield. The main portion consists of silvered fabric - tens or hundreds of kilometers across, but only microns thick. This sail is connected by shroud-lines to the vessel, which acts as a counter-weight. Utilizing solar flux (these vessels can stop, start, or change course only near a star), such a vessel is capable of reaching speeds of 0.07xC. With the addition of lunar-based laser launching cannon, higher velocities can be achieved, without the vessel itself having to carry the weight of these lasers.

Federation = Pleasure Yacht Sails

Chemical Rockets: Capability = 0.05xC

The first drive system any race invents, utilizing chemical reactions to create heat - and thus thrust by propelling the waste gases aft through a rocket nozzle. Although useful for orbital and interplanetary exploration, it is usually discarded within fifty years in favor of one of the preceding systems.

Ordnance Types

Although various technological races employ independently designed weapons systems, by and large these can be grouped into a few general categories, listed next. Also listed are some unique weapons systems encountered

-Offensive Systems

Matter-Antimatter Warhead:

A high-yield weapon consisting of antimatter plasma contained in a force-field envelope, delivered to target by a computer-guided drone with independent power and propulsion (a torpedo). When the force-field is canceled in proximity to the target, the antimatter contacts the matter comprising the torpedo systems. The resultant shock-wave - coupled with an intense bath of particle and electromagnetic radiation - then impacts the target.

Federation = Photon Torpedo

Klingon = Torpedo

Phased Tachyonic Particle Beam:

A variable-yield weapon capable of great flexibility. Width of field, intensity, and beam frequency may all be adjusted for desired effect, ranging from disintegration of the target to stunning personnel within a ship or upon a planetary surface. Matter-cohesive in nature, the beam tends to splash and envelop its target unless tuned otherwise.

Federation = Phaser

Klingon = Disruptor

Thermonuclear Warhead:

A medium-yield weapon consisting of a hydrogen-fusion mechanism, delivered by torpedo or transporter, or installed within a vessel as a scuttle charge.

Romulan = Self-destruct Device

Klingon = Hell Bomb

Ekos = Thermonuclear Missile

Eminar-7 = Fusion Bomb/Tricobalt

Thermal Laser:

A slow-working but effective weapon, utilizing lasers tuned to infra-red frequencies to heat-up a target vessel by induction until the vessel's life-support systems fail from overload - killing the crew while leaving the vessel intact.

Eminar-7 = Heat Beam

Starfleet DYNAMICS

Antimatter Plasma:

A high-yield weapon which utilizes magnetic field-coils to hurl an expanding cloud of anti-protons and positrons toward the target vessel - at speeds equal to the launch vessel's plus 0.90xC. On contact with the target vessel, the cloud acts to de-stabilize the molecular alignment and integrity of the hull-metal, rendering even such ultra-hard substances as trititanium and cast-rodinium brittle.

Romulan = Torpedo

Nomad = Sterilizer

-Defensive Systems

Force-Field Shields:

A magneto-gravitic shell generated close around a vessel as a protective screen. Capable of absorbing the energy of attacking weaponry to a limit set by the generator capacity and energy available.

Federation = Shields

Force-Field Screens:

Similar to Shields, but at a greater distance to the hull, and meant to deflect oncoming energy.

Federation = Screens

Energy-Damping Field:

An energy leaching field, draining any/all electromagnetic energy at the source, and simultaneously deactivating antimatter in containment by so strengthening its matter-repulsing properties that it will not react with matter.

Berserker = Unknown

Shoreleave = Recharger

Anti-Missiles:

Used by primitive space-going craft to stop attacking missiles/torpedoes by intercepting same with homing attack missiles. Useless on any torpedo with a speed over 0.09xC.

Eminar-7 = Anti-Missile

-Unique Systems

Tractor Web:

A matrix of tractor-stasis threads, woven into a hollow sphere around a stationary starship. When completed, the web is contracted - crushing the target vessel. The only escape is for the target vessel to exit the web before it is completed.

Tholia = Tractor Web

Hyper-Tractor:

A mega-powered tractor beam so strong that it can be used to immobilize spacecraft, or pull them down from orbit.

Vaal = Unknown

Beta-3 = Unknown

Force-field Containment:

A sufficiently high-powered force-field generator is used to englobe a near-by vessel, thus imprisoning it. The only escape is for the captured vessel to generate more energy - in random directions - than the force-field can absorb.

Pyris-7 = Transmuter

Stasis Field:

A field capable of neutralizing a spacecraft by encasing it within a bubble of zero-entropy for as much external time is desired, after which it can be released unharmed into the time flow.

Holberg 917G = Suspension Field

Integrator:

A uniquely dual-function weapon. Essentially an energy/plasma combination globe, it has the property of completely annihilating its target - while at the same time recording every detail of the target and occupants down to the sub-atomic level, and relaying this telemetry back to the launch vessel for data storage.

V-Ger = Whip-lash Bolt

Anti-Proton Beam:

An absolutely-pure coherent beam of anti-protons, used to slice planets into asteroid-sized chunks.

Berserker = Unknown

Mega-Transporter:

Uses a power-surge to wrinkle space at the coordinates of the target vessel, the net effect is to instantly transport a vessel hundreds of parsecs distant. A side-effect is that the vessel's overall magnetic field polarity is reversed. Although an impressive weapon, it was probably designed as an interstellar travel mode.

Kaladan = Molecular Transporter

Cloaking Device:

Utilizes the shields of a vessel to shunt all energies around the vessel as if it were never there, thereby rendering it effectively invisible to active/passive sensors.

Romulan = Cloaking Device

**Warp Field Envelope - Analysis
& Identification**

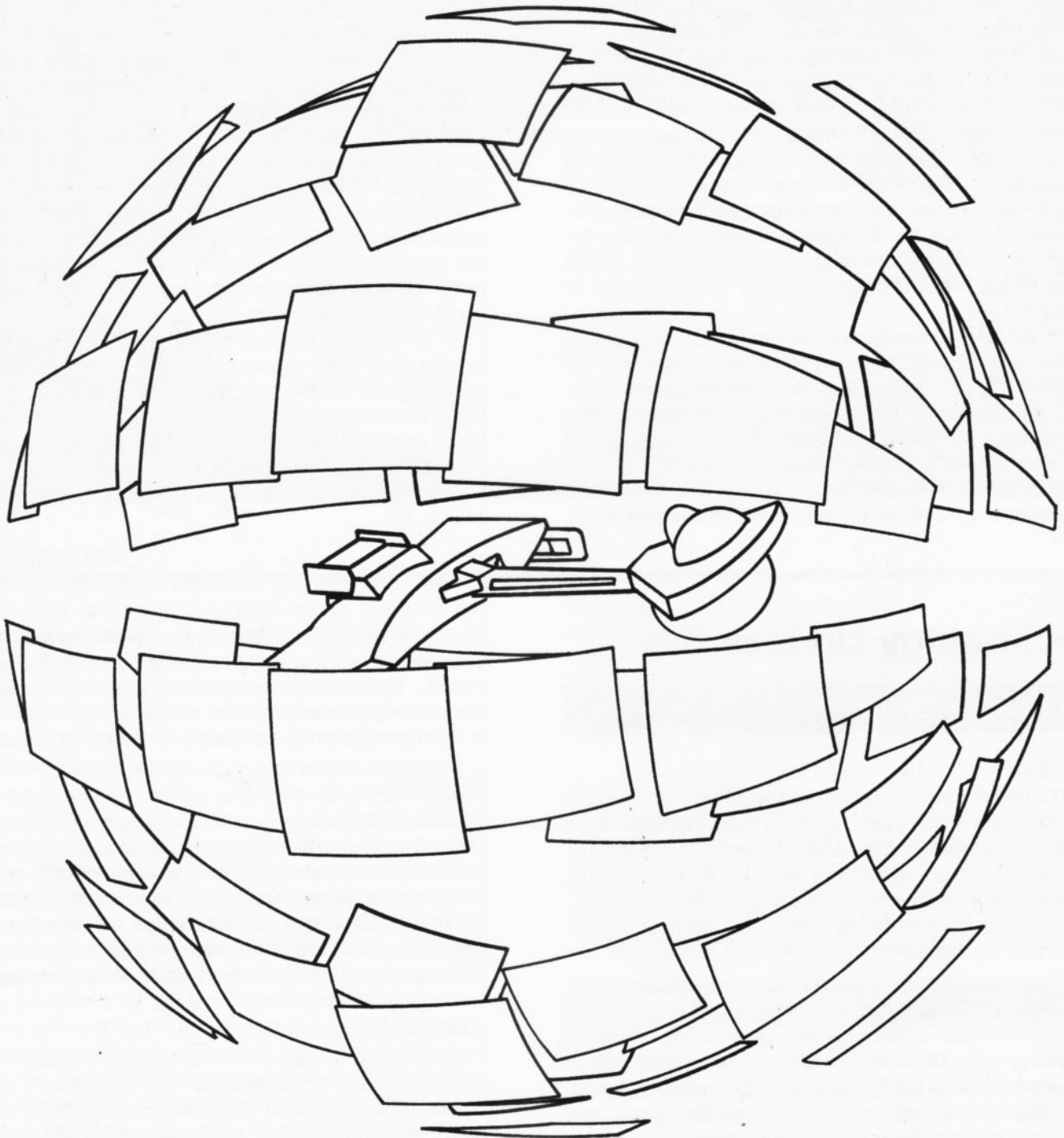

**VIFEAC READ-OUT:
ANALYSIS OF INPUT SENSOR READINGS YIELDS
POSITIVE CORRELATION MATCH WITH VESSEL-
FILE A17213.**

**ORIGIN = KLINGON
DESIGN = BATTLECRUISER
CLASS = K'TINGA
NAME = K'LOSSAR**

-Envelope Geometry

The shape and flow of the warp field envelope is a product of many inherent factors: nacelle design, reactor design, exterior hull design, intermix formula, vessel speed, etc. Therefore one would expect Klingon and Federation vessels to have differing envelopes. However, what few persons outside the military know is that no two vessels ever have identical warp fields. Even with a vessel Type (such as the Mark 9-B Heavy Cruiser), the starships Constitution II and Enterprise II each have their own uniquely configured warp field envelope (although of course these two similar starship's warp field envelopes do not differ by much). Furthermore, these envelope geometries are individual - meaning that a vessel's envelope remains the same throughout its operating lifetime unless the vessel undergoes a major change - such as an engine refit or redesign.

On Stardate 4893 Lieutenant Commander Uhura (a Class-5 Information Sensor/Communications Specialist) and Commander Spock (a Class-6 Computer/Information Specialist) - respectively the Communications and Science Officers aboard the U.S.S. Enterprise - collaborated on the development of a system which could identify FTL craft on long-range sensors, exploiting the fact that warp field envelopes are as unique and individualistic as retina-prints.

-VIFEAC System

The result was the VIFEAC (Vessel Identification through Field-Envelope Analysis and Correlation) System. It exists as a supplementary set of programs and memory files stored within the Main Computer's Strategy Bank. When a distant warp field envelope is detected by a starship's S/ED Sensors (Space/Energy Matrix Distortion), the telemetry readings are fed into the VIFEAC sub-program. Here those readings are compared with the filed readings of every vessel known - be they Starfleet (as filed by the Starfleet Corps of Engineers during launchings and shake-downs), friendly (as filed by commercial manufacturers and spaceports), or enemy (as recorded by covert craft, chance encounters with Starfleet vessels, surveillance buoys, and the Epsilon series listening posts). If the VIFEAC finds a match between its files and the incoming data, it will alert the Navigation/Helm Console.

The VIFEAC has significantly improved long-range tracking of enemy craft - especially Klingon warships operating on their side of the Neutral Zone, allowing listening stations to more accurately monitor individual and fleet movements. Since mounted in Treaty Zone Navigational Buoys, this system has also aided Starfleet Operations in monitoring civilian traffic along spacelanes, and preventing proscribed activity.

Technology Update File**Cloaking Device****-History**

The Cloaking Device was invented by the Romulan Empire an estimated thirty years ago. It was captured by a Federation vessel, but the analysis proved unpromising. As part of a trade agreement with the Klingon Empire, several sealed units were installed aboard Klingon vessels. These were safe-guarded by anti-tamper destruct devices to prevent their analysis by their Klingon operators.

-Function

The device was installed in the Engine Room, hooked in parallel with the Deflector Screen field generators. When activated, it utilizes this field to shunt any impinging electromagnetic or tachyonic energies around the vessel, and past it along the radiation's original heading.

-Effect

The net effect is that a cloaked vessel is effectively invisible to sensors using said radiations. The radiations

effectively pass through the volume occupied by the cloaked ship, and no radiation can be reflected or occluded by said vessel. This effect is so effective that - when a vessel is cloaked - a grounded craft cannot be seen by the naked eye or instrument even at a distance of one meter.

-Detection

The Cloaking Device does not eliminate a vessel's weight. Thus, the effect of its mass upon the space/energy matrix fabric remains as always, and can be detected by a Matrix Distortion Sensor - which would not detect the vessel but rather the distorted space it occupies. However, such a scan is limited in regards to weapon's targeting, providing little more than the target's approximate location and speed.

-Limitations

The Cloaking Device is an enormous energy drain when activated - often requiring up to 70% of a vessel's reactor output. Thus, a cloaked vessel will not be capable of firing heavy weapons without first disengaging the Cloaking Device. As well, a cloaked vessel's sensors are partially inhibited by the very shunting effect protecting the ship. However, since some parts of the Deflector Screen can be lessened selectively, it is possible for a cloaked vessel to transport personnel.

Energy Barrier

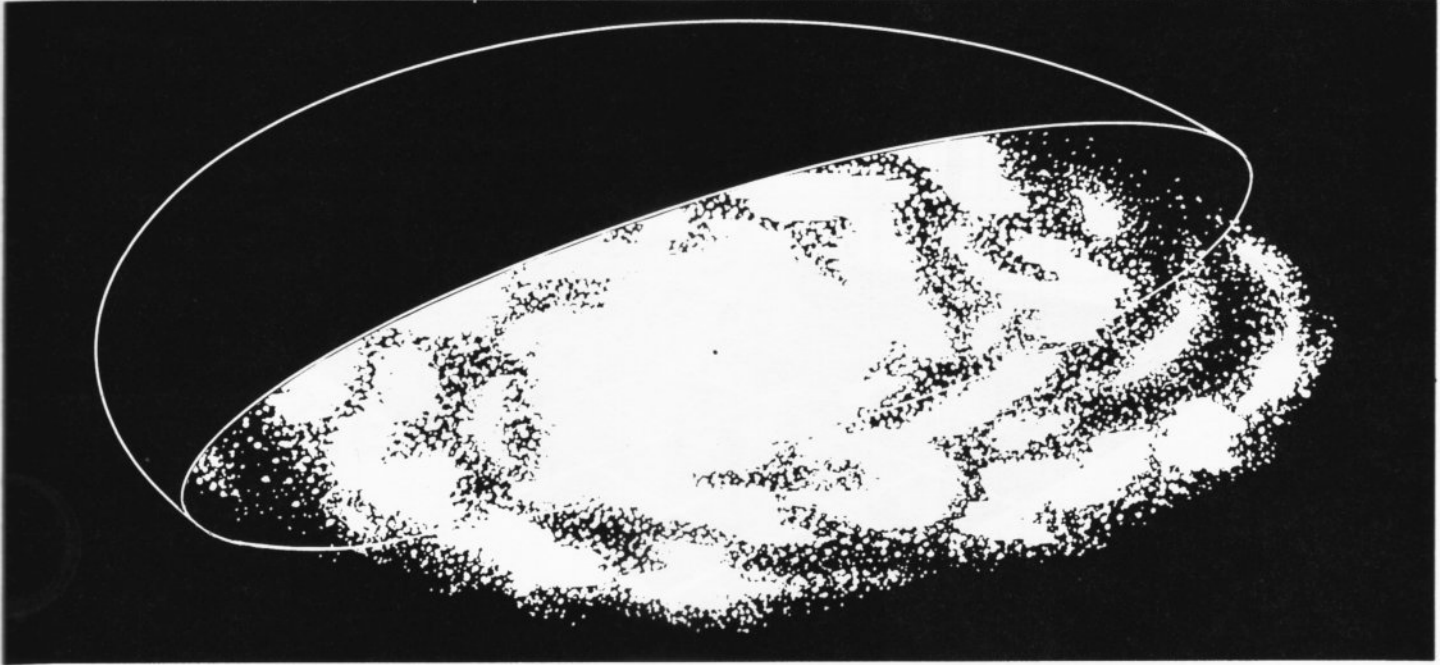

-Description

In 2164, it was discovered that our galaxy is surrounded by a force-field, composed of negative energy (positron flux) and christened the Energy Barrier. It is conjectured (as evidenced by remotely operated probes) that this barrier is an oblate spheroid, enclosing the entire galaxy.

-Effect

The effect of the barrier upon any vessel attempting to penetrate it are dramatic - and rather diverse. Vessels encountering it at speeds lower than Warp Factor 6 are reflected back along their previous trajectory, into the galaxy. The energy fields of the barrier (some of them Kirlian in nature) can have serious effects on a vessel's crew, killing some and causing a severe geometric augmentation of psychic powers in latent psychics (although not in actual psychics such as Vulcans). Vessels encountering the barrier at speeds higher than Warp Factor 6 suffer a different fate. Upon penetrating the barrier, they find much of their instrumentation shorted-out; computer memories scrambled and navigational systems disoriented. Theoretically, the faster a vessel is traveling when it impinges the barrier, the easier its passage will be.

-Origin/Cause

The origin of the Energy Barrier is unknown, and has been cause for much conjecture on behalf of Federation and Klingon scientists. It is unexplainable by any stretch of

conventional physics, and as such cannot easily be accepted as a natural phenomenon. It is known that our neighbouring galaxy (M31 in Andromeda) does not possess such a barrier. This has led to speculation that the barrier is an artifact; a bottle surrounding the galaxy, either to quarantine the inhabitants from outside dangers, or the reverse.

-Inner Barrier

Automated long-distance remote probes sent to the center of the galaxy have discovered a second barrier, a parsec-diameter sphere. Manned exploration later proved this to be an artifact, enclosing a single world orbiting the black hole at the galactic hub. It is believed that this was erected as a cage to lock up a single dangerous life form.

Project *Excelsior*

-Proposal

The *Excelsior* Class Battleship was constructed with a variety of purposes. Firstly, it is to be the test-bed for the next generation of Warp Drives - referred to as Transwarp Drive. Secondly, when this new system is perfected, the *Excelsior* is intended to be the first starship to safely pierce the Energy Barrier, and explore the Lesser Megallantic Cloud. Lastly, the Battleship is seen as the eventual successor to the *Enterprise* Class Heavy Cruiser.

Starfleet DYNAMICS

Time Travel

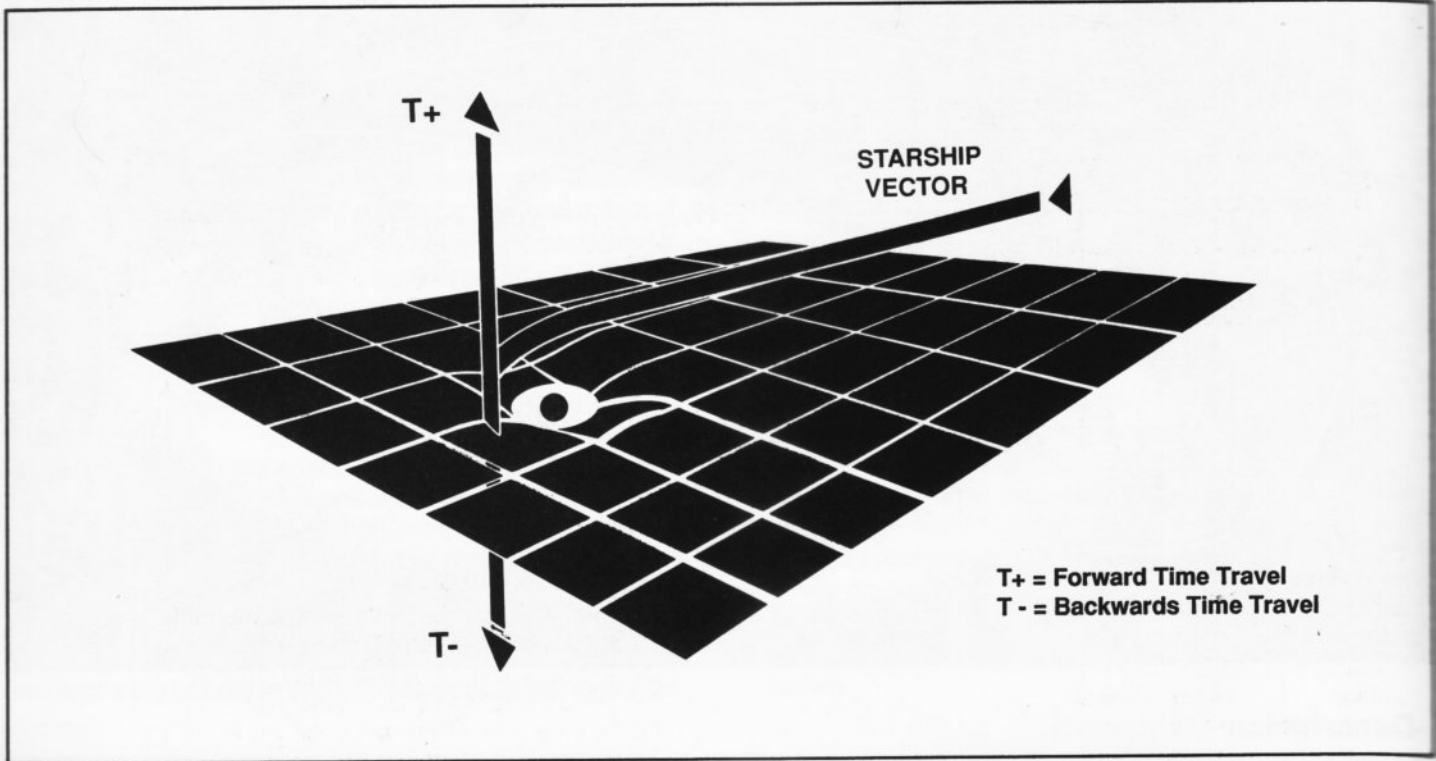

-Theory

The key to controlled time travel was discovered accidentally by the U.S.S. Enterprise, and was subsequently perfected into a working system by her Science and Engineering Officers. The method was tested by that same vessel in 2165 - via temporal displacement 200 years into the past and back. The method involves an obscure theoretical relationship between time and antimatter, which states that particles of antimatter in fact flow backward along time's arrow.

Any vessel travelling at FTL speeds is actually not in real-space. but is enveloped within a Warp Field, which functions as a bubble of sub-space surrounding the vessel and insulating it from real-space. This allows tachyonic speeds through (but not in) the real-space framework. The Spock/Scott Temporal Displacement process involves the inducement of a measured and controlled Warp Drive Implosion while accelerating past Warp 9 within the gravitational field of a stellar-sized mass during a grazing parabolic trajectory around said mass. As suggested by the term, Implosion occurs when the Warp Drive goes into antimatter imbalance. This, in close proximity to the multi-gigaton mass, will result in the sub-space bubble of the Warp Field Envelope actually inverting - turning itself inside-out. The result is that - for a brief instant - the vessel is travelling at FTL speeds

while actually in real-space. Since the universe will tolerate such a condition, a Time Warp will be generated.

The Time warp will fling the vessel either forwards or backwards in time, spanning centuries in a few minutes of subjective duration. To halt the vessel at the desired temporal destination, braking thrust is applied. As soon as the vessel slows to sub-light speeds and dumps out of Warp Drive, the Time warp is negated. Forward/Backward displacement is chosen via polarizing the imbalance.

Actual fuel, trajectory, and timing formulae - involving such variables as stellar mass, vessel's mass and vessel's warp dynamics - are classified GRADE 3: TOP SECRET.

Genesis Device

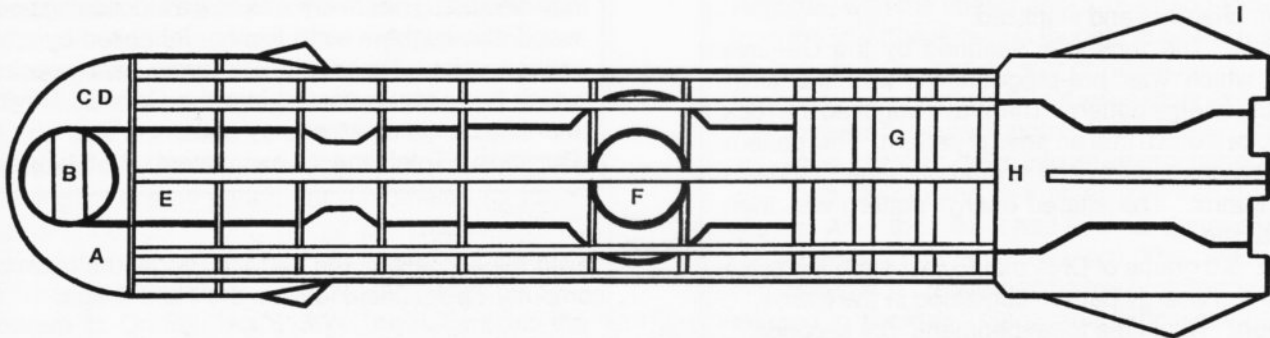

GENESIS DEVICE

Particulars:

Length 175 centimeters
Width 45 centimeters
Weight 153 centimeters
Duration Unpredictable
Torpedo Speed 0.13 Lightspeed
Designers Drs. Marcus
Laboratory Regula 1

A) Sensor Suite Sphere
B) Internal Guidance [Reference & Inertial]
C) Subspace Telemetry Transceiver
D) Onboard Computer and Memory Bank
E) Linear Accelerator/Quark Initiator
F) Genesis Wave Resonance Chamber
G) Powerplant [Dilithium Storage Cells]
H) Propulsion Chamber [Particle Beam Thrusters]
I) Atmospheric Stabilizing Fins [8]

-Modality

Basic Programming for the Genesis Device - including Parameter Adjustments, Subject Description, and Intended Biospheric Patterns (life-form types) are contained in a second, re-usable console. Sub-space telemetry between the Torpedo and the console's computer allows the Torpedo's sensors to scan the up-coming target and feed these into the console's computer, which can then choose the appropriate Biospheric Pattern for the Torpedo and transmit these instructions to the Torpedo's onboard computer in real-time. A remote-memory and computer was chosen because of the sheer size of memory required (5 petabytes). This memory, while essential to the task, was deemed to be too large to place within the Torpedo housing.

The Genesis Wave is generated as quarks within the Quark Initiator, and then built-up as a controlled and tuned function of interference patterns within the Resonance Chamber. Once initiated, detonation cannot be canceled, since the Genesis Waves cannot be damped by external means.

Status: Classified Grade 1 Stardate 7803.00. Reclassified Grade 2 Stardate 8601.00. The following encompasses events from Stardate 8000.00 through 8130.00 inclusive.

Proposal: Complete re-editing of matter in mass quantities from inorganic to organic state through controlled and accelerated transmuting and subsequent life-form development.

Objective: Instant terraforming of suitable life-less planets.

Function: The Genesis Device was intended as a tertiary development of the matter/energy scrambler process - even as the Transporter and Fabricator were the primary and secondary developments. However, instead of moving pre-existing molecules, the Genesis effect was to go one step further, transmuting the molecules present into new molecules according to a stored pre-program (matrix). The project was to encompass three stages of experiments.

Starfleet DYNAMICS

-Stage One: Spontaneous creation of DNA molecules from inorganic matter

Test Subject: 5.0 grams of granite, sealed in a vacuum chamber and sterilized.

Process: The rock was scanned by the Genesis Wave, which was pre-programmed with the DNA molecule energy pattern. The Wave engulfed the rock and broke it down into an energy pattern. This pattern was then changed by the pre-programmed Genesis Wave Matrix. The altered energy pattern was then materialized

Result: 5.0 grams of DNA molecules, each a precise copy of the energy pattern contained in the Matrix.

Duration: Total time for experiment: 0.4 seconds.

With the success of Stage One, the lab team coordinating Project Genesis dramatically increased the scale, without actually altering the basic process.

-Stage Two: Spontaneous creation of a pocket independent environment - including vegetation

Test Subject: Regula - a Class D planetoid orbiting the star Regulus at a distance of 900000000 kilometers, and totally devoid of life. The planetoid was prepared by the Starfleet Corps of Engineers. A series of tunnels were bored two kilometers below the surface, ending in a small chamber (twenty-seven cubic meters), separated from the tunnels by a pressure-door. The Genesis Device was placed within the sealed chamber, pre-programmed with the desired Matrix, and then detonated by remote control.

Process: A sphere of rock (radius one kilometers) with the closest curve touching - but not passing - the pressure door was engulfed in the Genesis Effect and broken-down into an energy pattern. This pattern was then changed according to the Matrix. The altered energy pattern was then materialized.

Result: A spherical bubble two kilometers across - with the upper pole one kilometer below the planetoid's surface. The bubble contained an atmosphere typical to a Class M world. The internal surface of the bubble was coated with an organic compost "soil" heavily laden with DNA and other organic molecules. At this point the Corps re-entered the bubble (in protective anti-contamination suits) and installed a fusion power-plant rigged to act as an artificial sun, mounting it on the bubble's concave ceiling. With the light available, the DNA - under the influence of the still-reverberating

Genesis Wave Matrix - began an incredibly accelerated, controlled evolutionary process. At the end of thirty-six hours post-detonation, the Genesis Wave had died out. The cavern was now a functioning pocket world, thoroughly - even lushly - inhabited by an immense variety of vegetation life-forms, each species of which had been recorded into the Genesis Device's memory banks as an energy pattern.

Duration: Total time for experiment: 72.6 hours.

With the success of the Second Stage, the team began computer-design inquiries into the Third Stage.

-Stage Three: Spontaneous creation of a Class M planetary ecological system

Test Subject: (Intended) A sterile planet - Terra-sized or smaller - orbiting a Type G2 star at a distance of 15 million kilometers. Sole preparation involved ascertaining with absolute certainty that the subject contained no indigenous life-forms (a matter of professional ethics) since any such life-forms would be exterminated by the detonation of the Genesis Device.

Process: (Intended) The Genesis Device was to be delivered as a torpedo, launched from the tubes of the assigned Starfleet vessel U.S.S. Reliant - Captain Clark Terrel commanding. A proximity fuse would detonate the Device one kilometer above the surface. The Genesis effect would engulf the entire planetary surface, to a uniform depth of fifty kilometers. These 11.2 million cubic kilometers of rock would be broken-down into an energy pattern. This pattern would then be altered and materialized as in Stage Two.

Result: (Intended) A living, breathing planet, lushly inhabited by an immense variety of vegetation - as evolved by the still-reverberating Genesis Wave Matrix during the first forty-eight hours - capable of sustaining whatever land and sea animal life-forms were seen fit to be deposited upon it.

Duration: (Intended) Total time for experiment: 7.1 days.

-Variation from Predicted Results

Problem 1: Unknown to the Project Head (Dr. Carol Marcus) or the other team researchers, the scientist charged with the evolutionary process after planetary surface materialization had run into a snag. He had

Sciences Department

found that it was impossible to keep the Genesis Wave Matrix actively reverberating for the full forty-eight hours necessary. Due to the scale of Project Three, computer simulations showed him that the Matrix tended to dampen and phase-out after only seven hours - permitting evolution on the planet's surface to proceed no further than basic algae. Dr. David Marcus' secret solution was to include an instability factor within the Genesis Wave Generator, which he accomplished by including an energy pattern for protomatter (phloem-plasma under conditions similar to those thought to have existed during the first three femtoseconds after the creation of the universe by the big bang).

Problem 2: On Stardate 8130.4, the Reliant and the Genesis Device were hi-jacked. The hi-jacker (Khan Noonian Singh) detonated the Device inside the Reliant, which was then situated within the Mutara Nebula. Khan - described as extremely intelligent - had reprogrammed the Device so that the detonation wave-front would expand to engulf the entire nebula (in order to destroy the *Enterprise*).

Subject: The Mutara Nebula - an immense cloud of ionized hydrogen and helium gases. Diameter 13 million kilometers. The nebula was near the star Regulus, with the vessel about 16 million kilo-meters from the star (the nebula is thought to be the residue of an exploded companion star of Regulus).

Process: The Genesis Effect wave-front expanded at lightspeed to the outer fringes of the nebula. The entire nebula was broken-down into an energy pattern, which was then altered and re-materialized into a Class M planet. After the planet had formed, the evolutionary cycle began - and never ceased. The reverberating Genesis Wave - reinforced by the protomatter Matrix, refused to dampen. Geological processes began to quicken, until the newly-formed planet blew itself apart - just days after the original detonation.

Result: As matters stand, the future of Project Genesis is uncertain - in the words of Starfleet Commander Admiral Harold Morrow: "Genesis is still an unknown quality."

Duration: Nebula-to-nebula cycle: 8 days.

Equipment

Type 1C - Tricorder

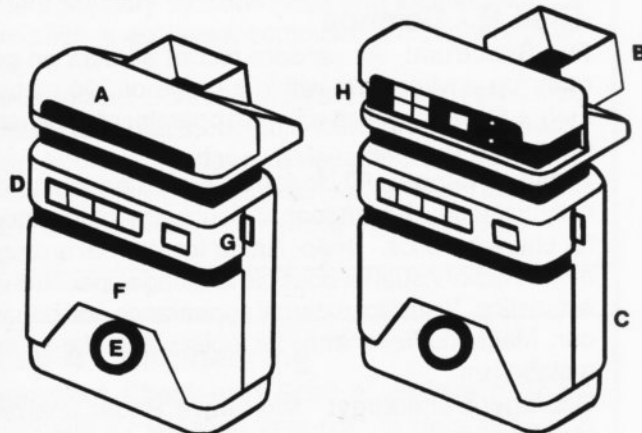

Sensor Head

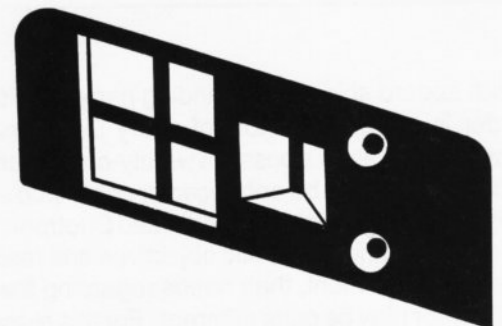

Particulars:

Open:

Length 161 millimeters
Width 100 millimeters
Depth 65 millimeters

Closed:

Length 142 millimeters
Width 100 millimeters
Depth 50 millimeters

- A) Sensor Array Head
- B) Data-plate Hood
- C) Disc Storage Bay
- D) Control Touchpads
 - Sensor Selection
 - Channel Selection
 - Disc Selection
 - Record/Playback/Correlate Selection
 - On/Off

- E) Dilithium Powerpack
- F) Microprocessor Bay
- G) Carry-strap Ring
- H) Sensor Array Platform
 - Energy
 - Field
 - Structural
 - Molecular Composition
 - Full-range Audio
 - Full-spectrum Visual

Starfleet DYNAMICS

The Type 1C - Tricorder is a smaller and more flexible version of the Type 1. Improvements include: enlarged range of both Energy and Field Sensors, greater processing power due to the expanded Microprocessor Bay, wider spectrum of sensitivity in the Visual Scanners, less leakage of energy during scanning, easier control operations, and - most important - pre-programmed Discs for the responsibilities of each Department.

-Sensors and Scanning Mode

Structural	= Microwave Radar = Gravitronic Pulse
Molecular	= Magnetic Resonance = Laser Spectroscopy
Field	= Magnetic = Gravitronic = Kirlian = Electrical
Energy	= Neutrino Emission = Electromagnetic = Sub-atomic Particle
Visual	= 3-D video = Telescopic = Microscopic = Infra-red = Ultra-violet = Enhanced
Audio	= Sound Recording = Voice-activated Log = Deep Radar = Translator = Sound Output

Both aboard ship and on landing party missions, the Tricorder is an essential tool of every Department. Its six sensor arrays allow a possible twenty-one scanning modes, each of which may be enhanced or correlated according to programming built into the Dedicated Duotronic Processor.

Due to the various specific objectives and responsibilities of each Department, their needs regarding the function of a Tricorder may be quite different. For this reason, a series of specialized Programming Discs have been developed by the Starfleet Academy in conjunction with Daystrom Duotronics - the manufacturers of the Type 1C. The purpose was to include in each Disc a repertoire of scanning modes and combinations of sensor/correlation sequences which would be of direct and essential value to each Department of Starfleet - transforming the Tricorder into a specialized tool for that Department.

Every Type 1C has in its Disc Storage facility five of these Departmental Storage Discs and four blanks. Thus one type 1C may be used by each Department, simply by

selection of the proper Disc. The following is a read-out of each Disc's sub-routines (Channels), which can be accessed by touchpad or voice command.

-Disc 1 - Security

Interdiction: Omnidirectional. Identifies all objects in a radius of 1000 meters and correlates these with artifacts and natural phenomena in Permanent Storage via Microwave Radar. Identifies all lifeforms within 1000 meters and correlates via Kirlian Scan.

Alarm: As above, but pre-set to ignore any movement by landing party personnel. Placed in the center of a bivouac, it will warn of approaching life-forms via audio and/or visual alarm.

Telescopic: Directional. Screen shows an enlarged view of Visual Scanner pick-up. Magnification variable.

Enhanced: Directional. Computer enhances view on-screen.

Infra-red: Directional. As with telescopic, but screen shows view of infra-red light stepped-down to visual.

Surveillance: Screen shows a view relayed from a remote pick-up (bug).

Note: Sub-routines above may be integrated due to the digital nature of the sensors and data processor (eg: combination of Telescopic, Infra-red, and Enhanced routines).

-Disc 2 - Science

Full Spectrum: All sensors record all data on surrounding environment within a range of 200 meters. Fully automatic. Alarm will warn operator of unusual or dangerous readings.

Botany/Biology: All life-forms in area are automatically located via Kirlian scan and subsequently scanned for characteristics. Deep- Radar for internal arrangement. Audio/Visual for possible language/speech characteristics. Visual for external appearance and behaviour. Magnetic Resonance for molecular make-up and metabolism.

Geology/Archeology: Microwave Radar analyses planetary crust structure. Magnetic Resonance and Laser Spectrography for molecular make-up of any specimens. Gravitic Pulse for planetary core scan. Sub-atomic Particle scan allows Carbon-14 dating.

Chemistry/Physics: Neutrino Emission Detection identifies and locates atomic powerplants and/or spacecraft. Field and Energy Sensors analyse advanced technology.

Sciences Department

-Disc 3 - Medical/Ship's Services

Deepscan: Screen shows a sectional view of internal body structure as seen from any imaginary vantage point and angle. Can be set to edit-out particular structures, or to enhance others, or to identify foreign objects.

Microscopic: Screen shows a magnified view of any object or area before Visual Scanner.

Pathological: Using Kirlian Scanner, Screen shows readout and visual representation of any pathological organisms either in the patient or in the surrounding environment.

Chemical: Screen shows the molecular make-up of all chemical compounds within range of the Molecular Sensor, using Magnetic Resonance Mode. Can be set to edit-out known compounds, or to display only those within a specific area or type.

Diagnostic: Directional. Using Kirlian, Audio, Magnetic Resonance, and Electromagnetic Scans, screen shows and measures pulse, respiration, Kirlian aura, endocrine balance, metabolic rate, temperature, neural activity, and blood pressure on a standardized diagnostic display.

Remote Diagnostic: The Tricorder can also be set to accept telemetry from one or more Remote Diagnostic Pick-ups, and to either display same or to record incoming data, alerting the user if the readings change.

Correlation: Computer analysis of all data received in above sub-routines, and comparison with data in Permanent Memory for correlation and identification. If correlation is achieved, computer can suggest treatment.

Contaminant: Screen can be set to display presence of chemical, radiation, or radioactive debris contamination as a colored overlay on a visual display of any compartment, allowing a Decontamination Team to rapidly locate and eliminate any harmful contamination.

-Disc 4 - Engineering

Equipment Check-up: Scan of an item of ship's equipment for variation from normal state as filed in Permanent Storage. Of especial usefulness is the Ultrasonic Deep Radar and the Ultra-violet fault-finding sub-routine, as well as the Sub-atomic Particle leakage scan.

Alien Technology: Scan of unknown technological artifact using all Sensors running parallel for details of internal and external operation. Correlation with Permanent Records may suggest possible method of operation and purpose.

-Disc 5 - Command/Operations

Log: Each person in a landing party may keep a separate log on the same Tricorder, updating it as necessary. The computer will edit, catalogue, file, and append Stardate reference automatically.

Recording: The Type 1C can be worn with the Sensor Array Cover closed but with the on-off switch overridden, to allow covert and candid recording of diplomatic or social events. Visual and Audio Sensors will record on-goings and wearer's quiet comments automatically.

Translator: Audio and Energy Sensors analyse verbal and neural patterns of both parties and compare them for correlation and concept identification until language equivalents are identified (see: UNIVERSAL TRANSLATOR).

Veriscan: During a Field Court-Martial, the Tricorder will scan every witness during testimony for evidence of rapid physiological changes - indicating perjury. An alarm can be visual or audible.



Medical Department

Shipboard Systems

Contameter

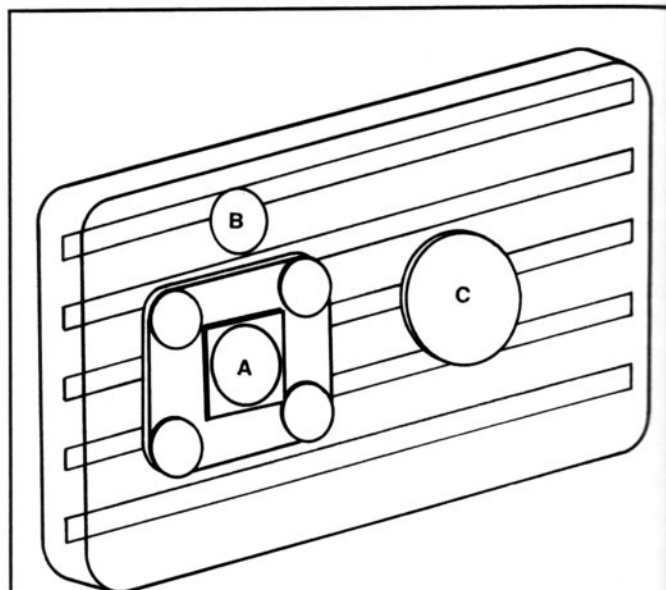

- A) Sensor Suite: Radiation
Chemical Trace
Biological Trace
Unrecognized Energy Type
- B) Vital Signs Monitor
- C) Status Indicator

Particulars:

Width	10.5 centimeters
Height	7.0 centimeters
Depth	1.5 centimeters
Weight	0.50 kilograms
Colors	Transparent and Silver

Medical Department

-Regulations

All personnel - whether Staff Officer, Enlisted Technician, or attached civilian - are required to affix a Contameter to their clothing whenever entering any Starfleet laboratory facility - shipboard or planetary. The Contameter must remain affixed for the duration of the duty shift or visit. A sensor/transceiver unit, its function is to continuously monitor the wearer's vital signs and environment, scanning the latter for any residual, gradual, or sudden contamination. Its functions can be divided into 4 categories:

-Function

1-Scans for the presence of contamination, classified under the following four basic headings:

Radiation: All listed types, all spectra.

Chemical: Airborne dust/gas to one part in 100 million.

Biological: Any known or unknown but identifiable pathogenic organism.

Unrecognized Energy: Any previously unclassified wave or field.

2-Records and calibrates presence of contaminants on two scales:

Intensity: Strength of contamination.

Accumulation: Total dosage of contamination over elapsed time.

3-Scans vital signs of wearer for deterioration/change:

Circulatory: Pulse rate and blood pressure. White and red blood cell count.

Nervous System: Brain electrical patterns and waves, synapse speed.

Kirlian: Strength and pattern of body aura.

Metabolic: Cell synthesis and function rate.

4-Transmits on-going telemetry to Sickbay's Medical Computer via sealed circuit. In the event of any readings exceeding preset parameters, one or more of the following sequences will be actioned:

Isolation: All doors and isolation fields will close-off the area, all life support systems will switch to local - sealing-off the area.

Decontam: The Quartermaster will be advised to muster a Decontam Team.

Alarm: The situation will be reported to the Bridge.

Diagnostic Bed

-Stretcher Mode

Any Diagnostic Bed becomes a stretcher by keying the command into the control pad. This separates the bed from its pedestal and activates the bed's built-in AG-9 Anti-Grav generator.

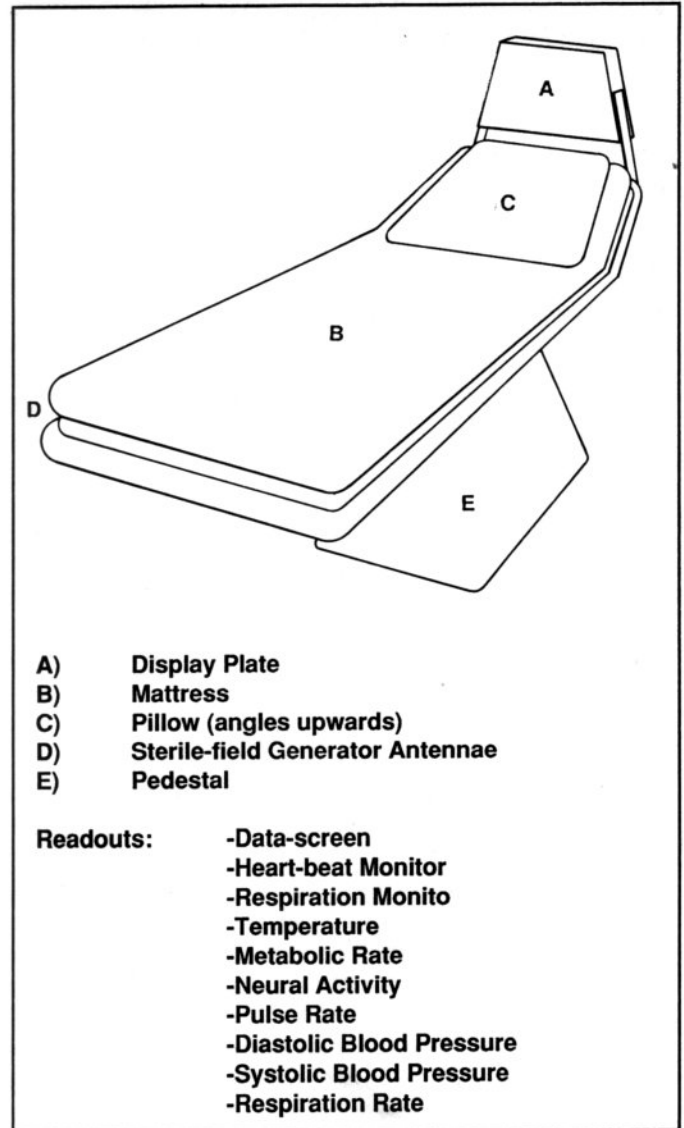

-Sickbay Mode

Except for external appearance, the similar to those incorporated in starships for 25 years. The Display plate normally shows vital functions - as shown. The data-screen portion can show visual telemetry (such as X-ray imaging), or can be used to access the patient's medical file. Sensors are built-in, mounted beneath the mattress. Both bed and patient are kept sterile by a sterile-field, generated by a belt-antennae surrounding the bed just below the mattress. This field kills all pathogenic organisms (virus, bacteria, germ), on all surfaces within range of the field, including skin and clothing of patient, physician, and visitor, as well as any instruments brought near the patient. The Diagnostic Bed can be remotely-controlled from the Sickbay Nurses Station, or can be directly-controlled by attaching a control pad to the connection-point on the right side.

Starfleet DYNAMICS

Recreation

Starfleet vessels - especially Class 1-B starships on long-range exploration duty - must remain on station or patrol for extended periods of time. Sometimes months pass between friendly ports-of-call and opportunities for shore-leave (see: LEAVE, SHORELEAVE, AND LIBERTY). With hundreds of personnel confined within a vessel for prolonged durations, it is of paramount importance that the ship become as pleasant an environment as possible. Among other amenities provided the crew (excellent food, comfortable, private quarters), care must be taken to provide relaxing and fulfilling ways to fill a crewmember's off-duty time. This field of endeavor has been entitled Recreation.

Starfleet plans a comprehensive program of recreation for its personnel. On each vessel, this is the responsibility of the Recreation Officer (a Division of the Medical Department), headed by the Recreation Officer. His duty is to maintain the morale of all personnel, keeping them contented, amused, and healthy. Such duties cover a wide variety of areas, activities, and projects.

-Games

All forms of games are encouraged - be they mental or physical - and the Recreation Officer must maintain a well-varied mixture of same, as individual and racial tastes in same are incredibly diverse. The main categories include Computer Game Programs (Tactical Simulations, Chess), Table Games (Poker and other more esoteric card games), and Athletics (Fencing, Martial Arts, O-Gee Soccer). The Recreation Officer works in close contact with the Chief Medical Officer to ensure that all personnel, regardless of rank, are involved in healthful activities and kept in prime condition. This may have to include prescribed exercises.

-Entertainment

Various forms of entertainment are provided to Starfleet personnel. Large vessels have a Theater - in which live plays can be performed by off-duty personnel, or holomovies can be shown large-scale. These can be "piped" around the ship and viewed on any intercom screen. Most vessels have their own news station, which broadcasts several times a day with high-lights from Federation current events, cultural items from the home worlds of some crewmen, and interviews with various officers and crewmen. As well, the ship's workshops can be made available to hobbyists and artists. At each stop, the Recreation Officer will scour the Library banks available at a port-of-call for new materials and ideas.

-Libraries

Stored within the Main Computer Core, the Library banks are available to any crewmember or passenger, and contain an immense variety and quantity of information, including technical works, fiction, non-fiction, and periodicals.

-Training

Training falls into two broad categories: Required and Additional. Additional Training is divided into Recommended and Personal.

Required: Training in subjects related to a crewman's Divisional duties are coordinated by said crewman's Chief Petty Officer

Recommended: Recommended Training is available for all personnel, in a wide variety of subjects. The Recreational Officer coordinates all such training. He does not teach, but rather serves to find suitable teachers and study materials. The courses can be quite rewarding. One such course is Landing Party Procedures. After successfully completing this course, a crewman is rated for Landing Party Duty, and can be placed on the duty list from which the Captain chooses personnel for Landing Party missions.

Personal: If a crewman states a desire to learn about any subject - eg: Vulcan Harp Playing - the Rec Officer will access ship's files through the Personnel Officer, note which crewpersons have said expertise, and then inquire of said experts whether they would wish to teach. A wide variety of Starfleet Correspondence Courses, Civilian Graduate, and Civilian Doctorate-level work can also be acquired.

Note: While Required Training takes place during duty time, Additional Training takes place during off-duty time.

Field Equipment

Type 5 Medikit

Particulars:

Width	16 centimeters
Height	10 centimeters
Depth	4 centimeters
Weight	2 kilograms
Colors	Black with Green Markings



-Definition

The Medikit-5 is the latest in a series of Medical Emergency Field Surgery Kits provided by the Surgeon General for use by military medical personnel. Compact and unobtrusive, it is designed to be worn by all medics while away from their vessel, and is worn clipped to the belt, or within the pocket of a Survival Jacket. Fitted within are a number of small but effective devices which combine to make up a practical, portable Sickbay, complete with diagnostic equipment, surgery instruments, and pharmacy.

The casing is comprised of a non-toxic plastic, and has been selected because of its being transparent to most forms of radiation. Being non-opaque to sensor scans, with the contents easily verified, the Medikit is as non-threatening as possible.

Starfleet DYNAMICS

-Content

Mylar Blanket: 3 m x 3 m x 0.00002 m (open). 6 cm x 5 cm x 2 cm (folded). A monolayer plastic sheet, silvered on one side, flat black on the other.

Laser Scalpel: 5 cm x 4 cm x 2 cm. Emits a variable-intensity, variable-width cutting laser beam from the emission cone. The Activation touch-pad is on the dorsal surface. Beam Intensity and Width are controlled by touch-pad LED scales on one ventral surface, while the battery recharge jack is on the other ventral surface. Settings vary from 1-5 Watts Intensity, and from 1-4 Angstroms Width.

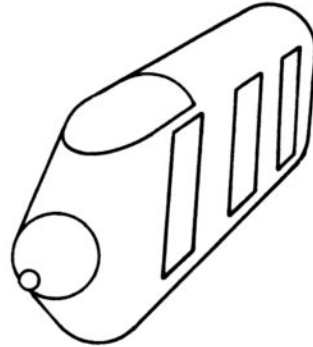

Remote Diagnostic Sensor: 8 cm x 5 cm x 2 cm. Basically a Tricorder's sensor head mated to a small sealed-circuit transceiver. The Sensor can be left activated and aimed at the patient while the medic is busy at other duties, with patient's vital signs relayed to the Scanner. 2 Sensors are carried.

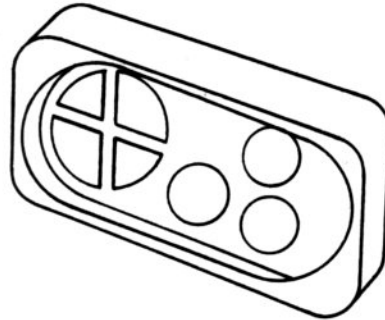

Scanner: 16 cm x 3.5 cm. Similar to Medical Scanners of twenty years ago, but adding such features as increased sensitivity, and a sealed circuit to the Remote Diagnostic Sensors. The Scanner's telemetry can be read from its own small circular display screen, or can be remotely to a nearby Tricorder. As well it can display the vital signs from any Remote Diagnostic Sensor. The enormous power-pack within the unit allows it to recharge other equipment via the standard jack.

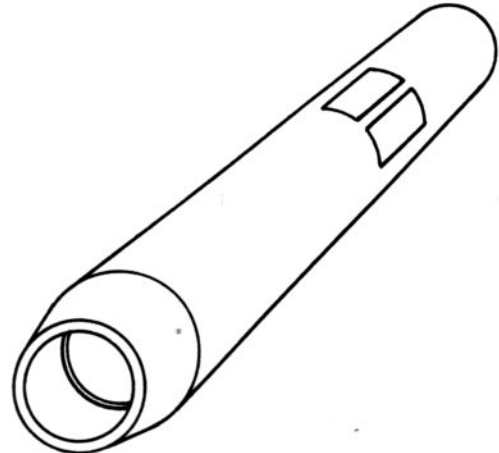

Medical Department

Anabolic Protoplaser: 15 cm x 7.5 cm x 2.5 cm (flat). The function of the Protoplaser is to heal internal and external bodily damage without requiring direct internal access to trauma - eliminating the need to open up the patient simply to effect repairs. It emits polarized magnetic fields and pulsed ultraviolet, oscillating in direct feedback to the selected damaged cell's metabolic rate and frequency - as sensed by a built-in Kirlian scanner - for a synergistic effect. The process must be closely monitored to prevent the onset of irregular cell development (cancer).

- A) Scanner/Sensor Head
- B) Magnetic Di-pole Module
- C) Ultraviolet Laser Module
- D) Powerpack/Computer Module
- E) Activation LED

The process can be monitored on the Remote Readout.

Protoplasers can only be used to repair recent damage, accelerating the body's inherent and on-going repair process. Thus a recently broken leg will be slowly healing on its own (lacerations to skin and muscle closing, bone knitting), but can be mended faster by encouraging the skin, muscle, nerve, and bone cells to temporarily speed up their activities. Similarly, a broken artery within the brain might heal naturally - but not before death or irreversible brain damage due to internal bleeding.

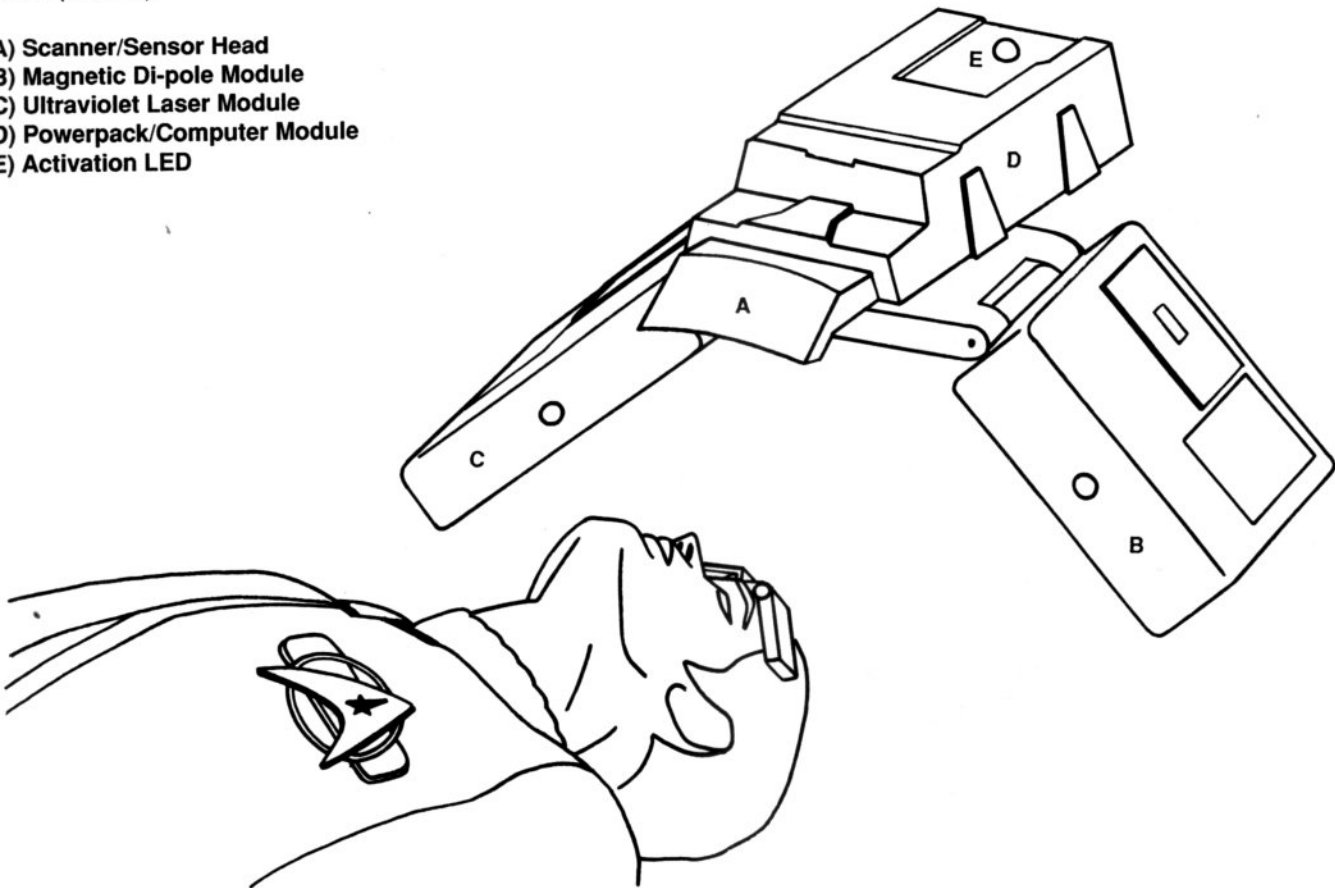

Scalpel: 15cm x 1.5 cm. To be used in case of energy depletion of more modern surgical aids..

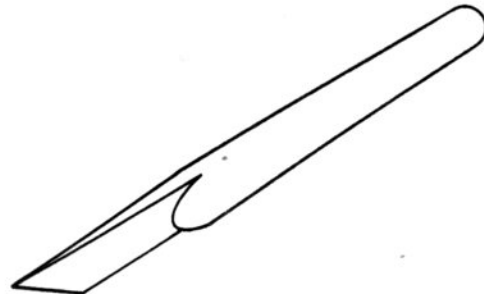

Starfleet DYNAMICS

Hypogun and Vials: 10 cm x 5 cm x 2.5 cm (unit). When fitted to a vial (which acts as the handle), this unit is intended to fit the humanoid hand like a pistol, and to be activated by depressing the thumb-trigger. This forces air through a capillary network, drawing-out a pre-determined dosage of drug from the vial and forcing the drug through the skin at high velocity - and almost no physical sensation. By holding the nozzle 20 centimeters from the patients skin, the unit can also be used to spray. Dosage is controlled by rotating the nozzle, and adjusts to 0.5 - 5 cc.

Eight drugs were selected by the Surgeon General as the most generally useful to an isolated medico. Vials are of standard size, fit all older-model hypos, and have 10 cc capacity. Space is left within the Medikit-5 for two other vials - at the medicos choosing.

Sterilization in the field can be effected by spraying a surgeon's hands and instruments with a fine mist of Sterilite (1 cc).

Medikit Drug-Vial Listing

USAGE CODE	NAME	DOSAGE	DESCRIPTION
C	Cordrazine	1cc	Stimulant
M	Masiform D	5cc	Antitoxin
T	Tri-Ox	5cc	Oxygen Binder
S	Sterilite	1cc	Antibacterial
H	Hyperena	2cc	Metabolic Accelerator
L	Lexorin	.5cc	Neural Tranquilizer
D	Dalpomine	5cc	Analgesic
A	Melanex	1cc	Aenesthetic

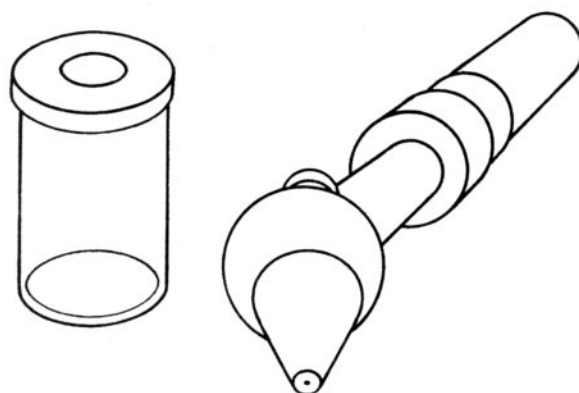

Type 6 Medical Emergency Case

-Definition

The Medical Emergency Case (MEC) is a compromise between a fully-stocked Sickbay and the basic Medikit-5. Stored in every Transporter Room's Equipment Locker, and every Shuttlecraft, it contains every conceivable Diagnostic, Surgical, and Pharmaceutical aid a Medical Team is likely to need in the field.

-Contents

The Case contains six Medikit-5s, a vial bank over 200 different drugs, two Tricorders, a portable heater, a hard-copy of the Starfleet medical Reference, and 20 liters of neutral-saline solution.

-Frame

Once the contents have been removed, the MEC is easily unfolded into a Cryosurgical Frame. This allows such thoracic surgical procedures as open-heart surgery to be

performed safely in the field. Fully self-contained and powered, the Frame includes an assistant monitoring console, which oversees such life-support functions as: cryogenic field generator, built-in cardiostimulator, sterile-field generator, auto-respirator and transfusion pump/filter processor.

-Stretcher

The unfolded MEC can function as a field stretcher, via its built-in AG-9 Anti-Grav generator. Because of power-pack drain, usage of the Anti-Grav may not be possible, and so a series of hand-grips have been built into the unit.

-Telemetry & Computer

A built-in transceiver (equal in range to the Type 2 Communicator) can be utilized to transmit all sensor readings directly to an orbiting starship's Sickbay. The MEC's inboard Medical Computer (which can be slaved to a medic's Medical Tricorder), can also be hooked-in, and data can thus be uplinked and downlinked.

Medical Department

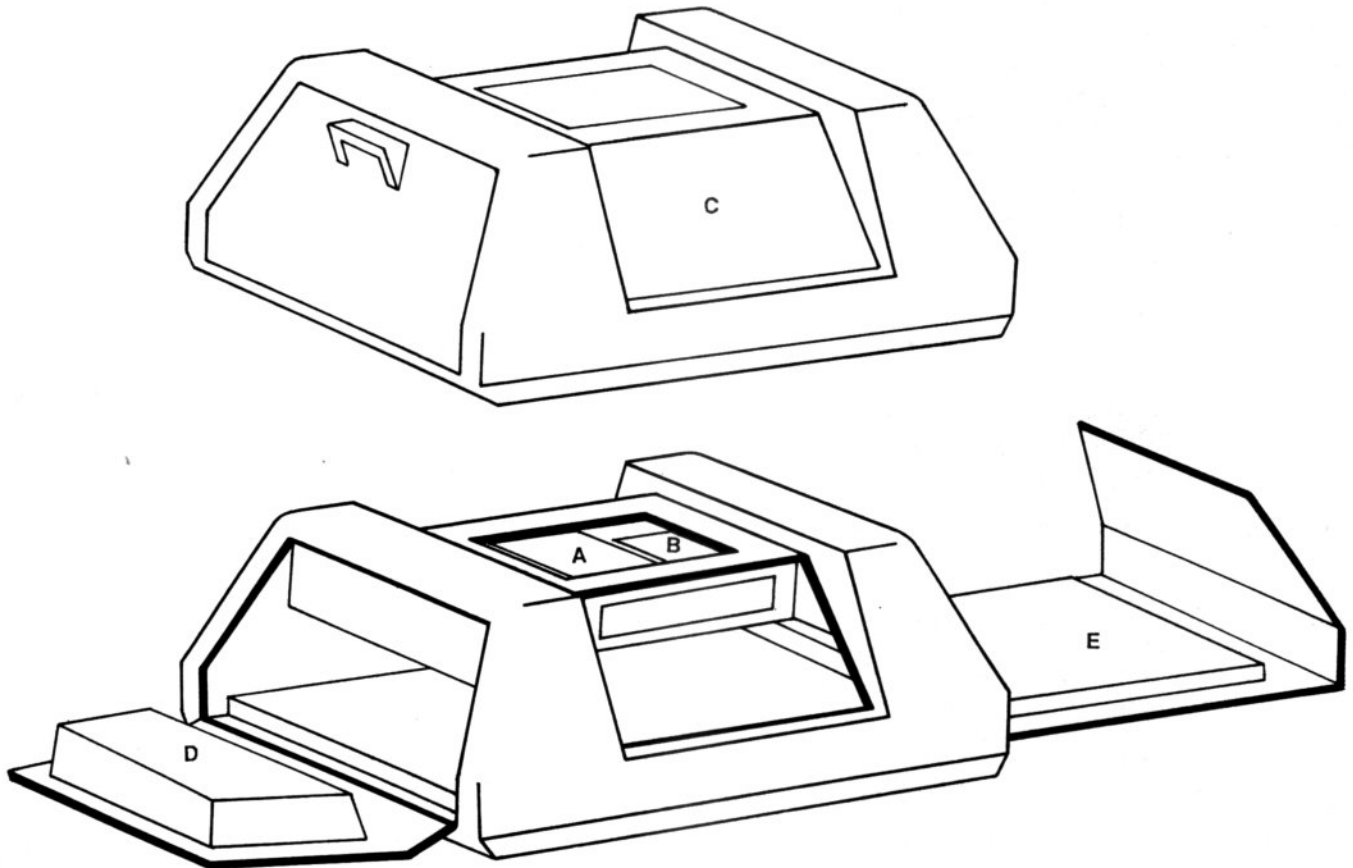

Particulars:

Width	100 centimeters
Height	50 centimeters
Depth	66 centimeters
Weight	80 kilograms
Colors	White with Green Markings

- A) Dataplate
- B) Controls
- C) Removable Thoracic Surgery Panels
- D) Fold-down Head Support
- E) Fold-down Leg Support

-Life-Support

Just as with the Sickbay Diagnostic Bed, the MEC can be used to provide total life-support to a patient whose own autonomic functions have ceased. With the attachment of flexible transparent hoods enclosing the head and foot areas, the MEC can maintain normal conditions should the external environment turn hostile. In fact, in a tight spot, MEC's have served as safe havens for healthy personnel caught out in cataclysmic weather. In such a case, the occupant (or external physician) can activate the MEC's low-powered defensive shield generator via the code-words: "MEC Shield Def On".

-Transporter Beacon & Platform

Due to the built-in transceiver, a MEC's coordinates are easily located by ship's sensors, and this can aid the transport of injured personnel when transporter lock-on is otherwise difficult to achieve.



Ship's Services Department

Shipboard Responsibilities

Decontamination Procedures

-Contamination Classification/Condition Code

Contamination is an all-inclusive term used to indicate the unwanted presence of a foreign substance in an otherwise clean environment. The causes can be accidental or battle-related, and may include a wide variety of problems. These are classified according to the following tables.

- | | |
|----------------------|--|
| Containment: | a) Local
b) Controlled
c) Shipwide
d) Expanding
e) Unknown
f) Solved |
| Danger Level: | 1) Harmless
2) Moderate
3) Severe
4) Critical |
| Type: | 1) Corrosive gas fumes
2) Corrosive liquid
3) Poisonous gas fumes
4) Poisonous liquid
5) Poisonous solid
6) Bacteriological
7) Radioactive gas fumes
8) Radioactive liquid
9) Radioactive solid
10) Unidentified Hazard |

Thus, if Compartment L-3-1-C is reported with D41 Contamination, the situation is: Expanding, a critical leakage of a corrosive gas (phaser coolant).

Ship's Services Department

-Procedures

When a crewmember or Medical Computer reports a Contamination Alert to the Bridge Damage Control Station, the affected compartments and corridors of the ship are immediately sealed-off. The Bridge Security Station activates all isolation doors and force-fields on the periphery, and remote-locks all compartment doors. Likewise, the Bridge Environmental Station quickly switches all life-support functions within that area from Intership to Isolated-Local, so that the contaminants do not spread into the remainder of the ship via the air-food-waste delivery and recycling systems and ducts. All on-duty Maintenance personnel will report to the affected area, and will then be briefed by the Quartermaster. After the situation is assessed, they will don air-masks (hoses mated to the chest-reservoir outlet on their Decontam Suits) and gloves, deploy their wands, and enter the area. Protected from contamination by the suits and collar fields (force-field and sterile field), they will then meticulously sterilize or collect all foreign substances from the air and surfaces, checking their progress via Tricorder. After securing the compartment, they will aid any trapped crewmembers, call the waiting Sickbay personnel in, and signal the Bridge that the area has been decontaminated.

Cargo Storage and Handling

-Container Handling

Aboard a Class1b starship, cargo is stored in modular Cargo Containers. Large vessels have special multi-deck Cargo Bays, wherein these Cargo Containers are stowed for maximum efficiency. When stowed, they are fitted and locked into Holds - in groups of four, each fitted into its own Hold Pocket. They are removed one at a time. The Ship's Services Technician simply identifies which Container he wishes, and instructs Main Computer with his DCU (Q55/8) to move that specific Container to the deck. The Computer will activate the built-in generators and float the Container to an empty floor unloading spot. Replacing the Container is similarly simple.

-Container Onboard Systems

Movement of the Containers from pocket to the deck for opening is accomplished via the built-in AG-3 Anti-Grav generator and Tractor Beam Generators. The contents are kept from shifting within the Container during said movement (and during any violent maneuvers of the starship) by a built-in inertial-damping and synthetic gravity field. As well, such internal environmental factors as temperature

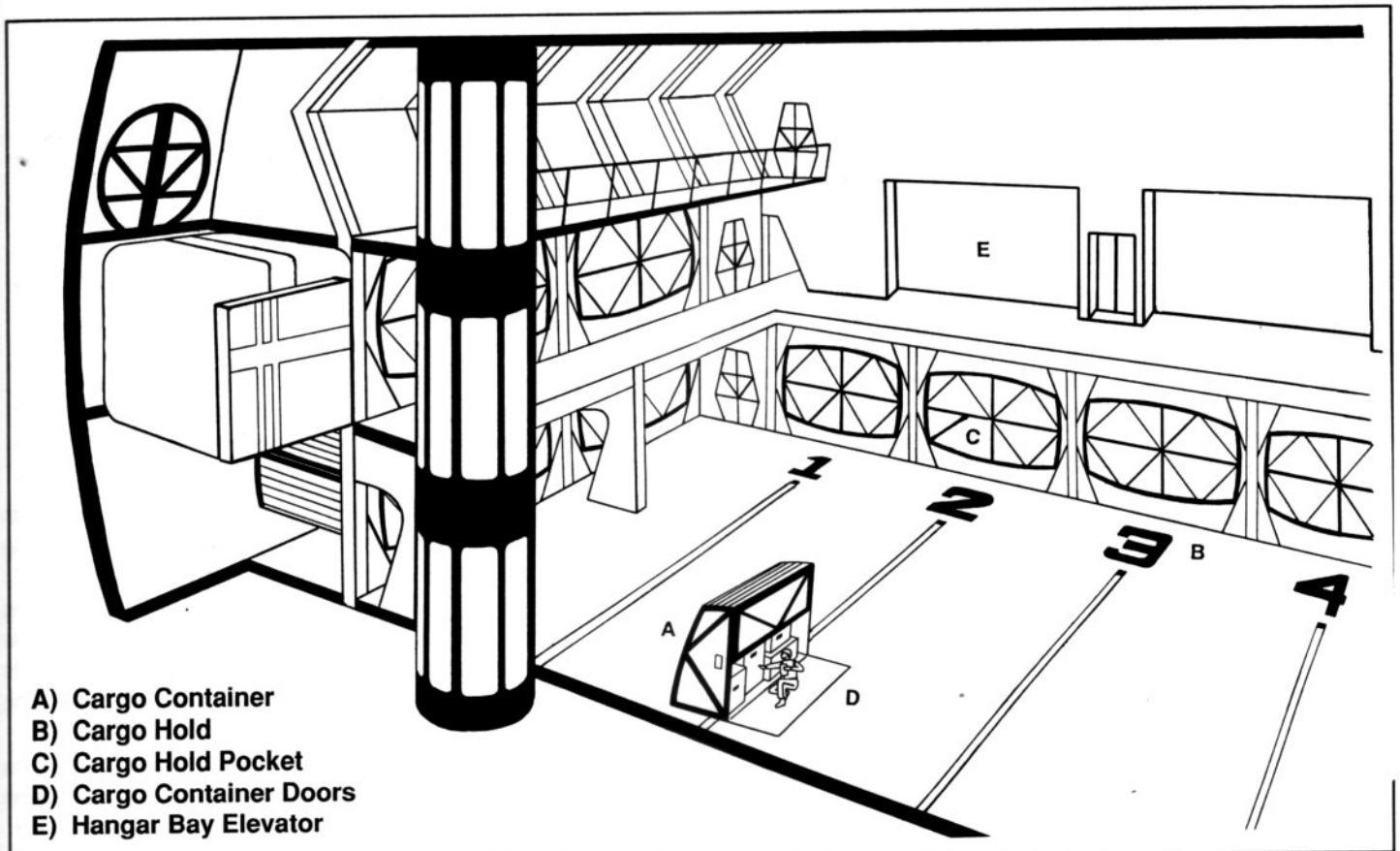

Starfleet DYNAMICS

are similarly stabilized with built-in systems.

-Manifest Coding

CODING	DEFINITION & DEFINITION	
	Future/Destination	
A	To be used aboard ship: Infrequent Access	
B	To be used aboard ship: Frequent Access	
C	To be transferred to a vessel at rendezvous	
D	To be transferred to a planet/station	
	Environmental Requirements	
1	No Specific Environmental Requirements	
2	Specific Environmental Conditions	
3	Unique Environmental Conditions	
	Department & Type	
1A	Medical	Drugs
1B	Medical	Equipment
1C	Medical	Samples
2A	Command	Discretionary
2B	Command	Field Equipment
3A	Security	Weaponry & Armor
4A	Engineering	Components & Spares
4B	Engineering	Assemblies & Sub-units
4C	Engineering	Tools
4D	Engineering	Damage Control
4E	Engineering	Hazard
5A	Services	Foodstuffs & Potables
5B	Services	Wardrobe & Materials
5C	Services	Personal Luggage
5D	Services	Valuables
5E	Services	Raw Materials: Metals
5F	Services	Raw materials: Ceramics
5G	Services	Raw Materials: Platics
5H	Services	Raw materials: Organics
6A	Sciences	Lab Equipment
6B	Sciences	Specimens
6C	Sciences	Software
7A	Communications	Software
7B	Communications	Equipment
8A	Operations	Discretionary

Every single item brought aboard ship has a Manifest Code, and is listed on the Quartermaster's Cargo Manifest. The Manifest is in two parts: Particulars Code (comprised of four symbols) and Item Number (composed of four digits). The Particulars Code exactly describes the cargo according to four criteria: Future, Environment, Department, and Type. The Item Number is sequential, defines which of thousands of cargo items a specific piece is. No

two cargo items (even if identical and therefore having identical Particulars Codes) ever possess the same Item Number. The listing below shows the various Particulars Codes:

The following is a simple example of a Manifest Listing:

D21A - 0001	Amphidextrine [Antiparanoia vaccine].
45 - D4	100 x 50ml vials
	Time-perishable
	Cryogenic conditions (-100C)

With the use of the Manifest coding, the particular storage requirements of a specific cargo item can be dealt with. Some items must be accessed frequently. Others are rarely if ever used, and some are not intended for ship use at all, but are meant to be delivered at a rendezvous or planet destination. Thus each item is stored in the Container which best fits its specific profile, along with other items with matching requirements.

-Item Tag

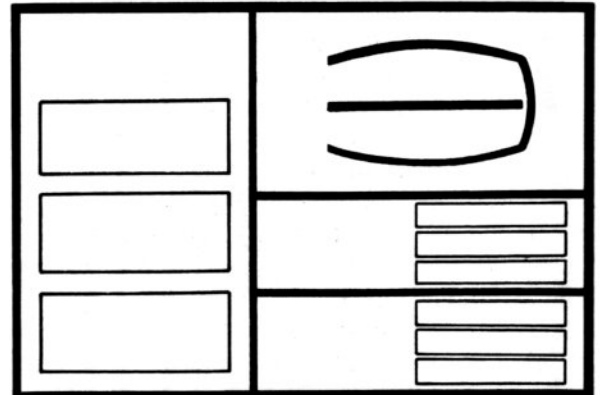

Each individual cargo item (box, tube, envelope) bears an Item tag, which records all information available regarding it. Item Tags are printed from a slot on the Q55/8 DCU (electronic clipboard), and are self-adhesive. If anything about that specific cargo item is changed (some of the contents removed, the destination is changed, the item is moved to a different Cargo Container), a new Item Tag must be affixed. A typical sample of a Tag is given:

Note: The Item tag not only describes the contents of the cargo item, it also states the storage requirements and location: Cargo Container and Hold Location Indicator.

Ship's Services Department

-Cargo Container Data-Plaque

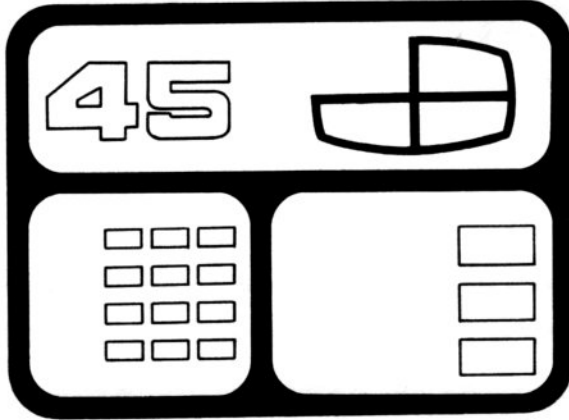

Each Cargo Container bears a Data-Plaque, mounted so as to be readable when the Container is locked into its Hold Pocket. The Data-Plaque displays the Cargo Container

Number, the Hold Location Indicator, and read-outs of the Container's built-in systems and internal environment status. Although all of these read-outs are remoted to the Main Computer (and are available on any Q55/8 DCU), they are visually checked once per watch.

-Standing Orders

The following orders apply to all personnel in the Quartermaster's Division of the Ship's Services Department:

- 1) No Cargo Container may be accessed without being logged via Q55/8.
- 2) Any addition/removal of cargo items must be logged on the Manifest. Any such changes must be appended via a new Item tag.
- 3) No more than 4 Cargo Containers may occupy the Cargo Deck simultaneously.
- 4) In the event of an Alert, all Cargo Containers must be returned to their proper Hold Pockets at once and locked into place.
- 5) No unauthorized personnel are allowed on the Cargo Deck.

Anti-Grav Units

-Operation

The Anti-Grav Unit is a standard utility aboard ship. Although functions are similar, the Units come in a variety of shapes and capabilities, each designed with a particular task in mind. Operation is simple, although the more specialized Units require some training prior to use. They can be divided into three basic categories: Built-in, Platform, and Grappling. To activate any Anti-Grav Unit, touch the red octagonal touch-pad. Following this, load the Anti-Grav, or attach it to the object desired. To raise a loaded Unit to a desired height-above deck/ground depends upon the model. The AG-3 is generally computer controlled. The AG-4 is elevated by grasping the handle and guiding the Unit manually to the desired height. It is moved about by pulling laterally on the same handle. The AG-8, AG-9, and AG-10 models are elevated by the operator sliding the gravistat setting on the controls to the desired level. Once the desired height has been achieved, all Units can lock the gravistat, which instructs the built-in computer to maintain elevation.

-Functions and Parameters

AG-3: The AG-3 is a built-in Unit, and as such is usually situated at the center of another piece of equipment. Examples of its utilization include the Cargo Container. Relatively high-powered, the Unit has a rated lifting capac-

ity of 8 metric tonnes (8,000,000 gtm).

AG-4: The AG-4 is designed to lift rigid objects by grappling onto the outer surface with a magnetomic adhesion surface. If the object's mass exceeds the rated capacity of the Unit, other Units can be grappled onto opposing surfaces. The rated capacity of a single Unit is 57 kilograms (57,000 gtm).

AG-8: The AG-8 is a circular, 50 centimeter-diameter platform, designed to lift and support a single crewman standing on it. It is utilized whenever a crewman must inspect, reach, or repair equipment located overhead and out of reach. A hand-held remote control gives the crewman elevation control up to 3 meters, and limited lateral control. The unit has a rated capacity of 150 kilograms (150,000 gtm).

AG-9: The AG-9 is a rectangular platform, 150 x 75 centimeters. It is designed to lift and transport any object(s) placed upon its upper surface, and is used to move anything too heavy for personnel to carry. The operator moves the Unit laterally by holding the hand-grips at one narrow end of the Unit. The controls are beside the hand-grips. The Unit has a rated capacity of 300 kilograms (300,000 gtm).



Security Department

Organization & Procedures

Department Deployment

-Make-up

The Security Department aboard a Mark 9-B starship consists of ninety Marines - six officers and eighty-four enlisted men. This is equally divided into three Sections, each of which is further broken-down into five Squads. Normally, only one Section is on duty during any watch - in rotation. The Section on-duty at any time is referred-to as First Section, the one which will relieve it is Second Section, with the one which will relieve Second (and which was just relieved by First) referred-to as Third Section.

The usual officer division is one Lieutenant Commander and five Lieutenants. The senior officer is the Chief Security Officer, and as such is responsible to the Captain for his Department. He is also in charge of a Duty Section, with one Lieutenant working under him. As such, they coordinate the activities of their Security Section for every watch, assigning patrol and sentry duties. Likewise there are two officers assigned to head the Second and Third Sections.

-Officer Duties

During Condition 1 (analogous to Green Status for non-Security personnel), each Shift will see two officers and twenty-eight Security specialists on duty. One of the officers will be designated as the Security Watch Officer. He is responsible for coordinating the duties and functions of his Section smoothly and efficiently in real-time - handling any problems which may come up. Normally he sits at the Bridge Internal Security Station. From here he has access to all special intelligence and remote controls. Also, he can interact and relay orders from the CO to his Section via intercom/communicator circuit. The other on-duty officer is usually stationed in the Security Office Complex, where he can monitor the Armory and Brig. As Assistant Security Watch Officer he is also Armorer of the Watch, signing out and receiving all weapons at the start and end

Security Department

of his shift.

-Squads

When acting as either an Escort or Task Force on a planet, or as an Honor Guard aboard ship, Security personnel are deployed in Squads. A Squad is comprised of six men, one of whom is the Squad Leader. The Squad Leader is a petty officer, referred to and addressed as "Chief". Most landing parties are comprised of three Security specialists (half a Squad) escorting three officers from other Departments. In the case of a Task Force, standard procedure calls for a full Squad. If enough Squads are needed for a job, and all Security personnel are deployed, the Chief of Security and five Lieutenants all act as Squad Leaders themselves, thus allowing for a full strength turn-out of three Sections - ninety men divided into fifteen Squads.

-Condition Status

Just as other officers and crewmen are controlled by the Alert Status, the Security Department is controlled by the Condition Status. This is entirely independent of the Alert Status, and any Condition Status may co-exist with almost any Alert Status.

Condition 1: (Normal) First Section on-duty, Second and Third Sections off-duty. Second Section reports to the Security Office Complex one half-hour before change-of watch (going on-duty) for briefing. Members of the First Section patrol or stand at sentry posts singly as ordered.

Condition 2: Second Section joins First on-duty. All patrols and sentry posts double-up to two-man teams. Third Section reports for duty one hour before change-of watch.

Condition 3: Third Section dons Armor and goes on-duty immediately. First and Second Sections - in two-man teams - are directed by the Chief of Security to take-up positions at the sensitive sentry posts. Phasers are drawn and set for STUN. Third Section begins an extensive sweep patrol of the entire vessel, checking-in at each sentry post.

Condition 4: (Isolation) The Chief of Security activates the Isolation force-field doors, effectively cutting the ship into twenty to thirty isolated areas (depending upon the Type of ship). The Third Section - which is patrolling the ship in armored two-man Teams - can pass through the Isolation fields due to the force-field neutralizers built-into their armor. All other personnel must request permission from the Bridge - said request to be relayed by the sentries posted at the Isolation force-field doors. The Isolation fields can only be canceled by from the Bridge Internal Security Station. Phasers are drawn and set for KILL. Any order given to a sentry by any superior officer must be relayed to the Bridge for confirmation by the Captain.

Condition 5: (Evacuation) When all or part of the ship must be evacuated, Security specialists will begin a thorough sweep for personnel, removing same to safety.

Duty Classification

The types of duty listed may be divided into three classifications:

1 - General

2 - Special

3 - Ceremonial

Classifications 1 and 2 may take place regardless of the Condition Status - the only difference being the amount of Sections placed on-duty. Classification 3 may only take place during Condition 1.

-Class 1: General Duty

Patrol: During Condition 1, all but the two Life Boat Officers will be on patrol duty. These men will patrol throughout the ship. They will receive their routes from the Assistant Security Watch Officer at the beginning of their shift in the Security Office Complex. Each route will be computer-generated, striving for both random pattern and minimum redundancy. There are two basic reasons for this: it reduces the element of boredom inherent in patrolling (and thus decreases errors caused by fatigue), and it eliminates the possibility of a saboteur scheduling his activities safely according to an observed pattern.

Of the men patrolling the ship during Condition 1, six will be in full Security Armor. These men comprise the Armor Squad. If a Security specialist on patrol reports that he needs back-up (or fails to check-in), the Armor Squad will be directed by the Bridge Station to rendezvous at his last known location and investigate - being advised of his projected route.

Armory: The Assistant Security Watch Officer of each Section is Armorer of the Watch. He is responsible for issuing and receiving weapons from the Armory, making sure all are fully-charged, and tagging those in need of repair. If a visitor or passenger boards the ship armed, the weapons in question will be placed in the Armory vault, and a receipt made (except as exempted by the CO). The Assistant Chief of Security is the ships real Armorer. During his duty period he is responsible for repairing any weapons which have been damaged in the previous two shifts.

-Class 2: Special Duty

Landing Party: A Security Team usually accompanies any scientific parties exploring unknown territory.

Scouting Party: An entire Section is usually deployed to scout dangerous territory.

Boarding Party: One or more Squads are usually the first

Starfleet DYNAMICS

to beam aboard a captured or incommunicative vessel. Upon establishing that there is no threat, they will signal the all-clear to their ship, so that senior officers may follow.

Brig/Prisoner: If a prisoner is to be detained, the Chief of Security will assign a guard. This may be in the Brig, in Sickbay, or in the prisoner's own cabin. The guard will remain just outside the prisoner's door until relieved by his replacement, the Chief of Security, or the CO.

Locking: On the orders of the Chief of Security, a Security Team may be dispatched to a given compartment to apply Security Seals to all doors/access points. Seals are acquired from the Armory.

Arrest: On the orders of the Chief of Security, a Security Team will be dispatched to a given location to physically arrest an individual and conduct him to a detention area.

Sentry: On the orders of the Chief of Security, a Security personnel will be posted to a sentry post. A sentry post is any designated area of a ship which the Security Watch Officer desires a Security specialist to guard (restrict access), maintain order, or observe. The following is a list of the sentry posts automatically stood during various Conditions. Additional posts may be assigned as needed.

- Condition 1** - Life Boat Stations
- Condition 2** - Life Boat Stations
- Airlocks
- Docking Ports
- Main Computer Core Access
- Emergency Bridge
- Transporter Rooms
- Security Office Complex
- Hangar Bay
- Fire-control Stations

Search: There are two types of searches:

- Phase 1** - Missing Personnel. Full deck-by-deck sweep-search of the entire ship, with Security at Condition Two. Sickbay standing-by to receive possibly injured crewman.
- Phase 2** - Intruder Alert. Full deck-by-deck search of the entire ship, with Security at Condition 4.

Abandon Ship: On the order of the CO, all Security personnel will assume their pre-arranged Evacuation duties.

-Class 3 - Ceremonial Duty

Bodyguard: A Security specialist may be assigned to act as guide for a VIP while the latter is visiting the ship. The Security specialist will accompany the VIP wherever he wishes to go, except for restricted or controlled areas. When the VIP returns to his assigned quarters (or leaves the ship), the Security specialist will report same to Bridge

and request permission to be relieved.

Escort: A Security specialist may be assigned to act as a guide or assistant for a visiting flag officer aboard ship, or as escort to one of his own officers on non-Starfleet vessel or on a planet. Number and ordnance depend upon the situation, or as ordered by the Chief of Security.

Honor Guard: When a VIP comes aboard, an honor guard comprised of a half or full Squad of Security specialists may be deployed to the Airlock, Transporter Room, or Shuttlecraft Bay to greet him as a measure of respect. If the VIP is the representative of a planetary government, he will be accorded Presidential Honors and the anthem of his planet played. If the VIP is a flag officer, he will be piped aboard.

Security Host: During a banquet or celebration aboard ship, with non-Starfleet persons attending, Security specialists may be assigned to attend the function. They will wear concealed Type 1 hand phasers only.

Communication

The key to any Security operation running smoothly is communication. Communication between Teams or Squads and the Security Watch Officer allows the Security Section to act as a well-orchestrated unit. A communicator is an essential part of Security equipment.

-Routine Check-ins and Multi-channeling

While on-duty, a Security specialist is required to check-in with the Bridge Station every fifteen minutes. Furthermore, any change in the status of a sentry's post or patrol route must be reported at once - before action is taken. This ensures that - should the man be incapacitated before he can call for help - back-up will be on the way quickly. The Bridge Internal Security Station is capable of handling fifty communicator channels - with the computer taking the various incoming check-ins and only passing-on urgent ones to the Security Watch Officer. Because the computer will be taking the incoming call, normal check-in should be short and concise - preferably under fifteen seconds:

Patrol Check-in: "Smith, 10:00 check-in. M-Deck station 7. Proceeding to N-Deck Station 1. All quiet. Over."

Sentry Check-in: "Jones, 09:45 check-in. M-Deck Station 5. All quiet. Over."

-Preliminary and Follow-up Calls

In the event of trouble, the Security specialist is to keep calm and rational - and to report-in before acting. A preliminary report should be made if something seems suspicious - promising a follow-up in five minutes or less. The computer buffer can be by-passed (allowing the Security specialist to speak directly to the Security Watch Officer by saying the override code-phrase "Armageddon". If further investigation reveals that nothing was wrong, no harm will

Security Department

have come from making the preliminary report. If a Security specialist investigates a suspicious incident without making a preliminary report - and if his suspicions were correct to the point of his being overpowered, the Security Watch Officer would not know that anything was amiss until fifteen minutes after the last routine check-in. If the investigation proves that the suspicions were unwarranted, the follow-up will take care of the situation. If the situation is bad, and the Security specialist can make a trouble call, he should override the computer and report directly to the Security Watch Officer by saying the code-word "Ragnarok", which will override all other calls. Preliminary Call: "Armageddon - Smith, 10:02 Prelim. N-Deck Corridor 2. Believe I just heard phaser-fire in the next corridor - N-Deck Corridor 3. Will advise in two minutes - out."

Follow-up Call: "Armageddon - Smith, 10:04 Follow-up. N-Deck Corridor 3. Sound was a target simulation being used by some Cadets who thought the Rec-Deck was too crowded. Recommend that we alter the sound-effect for variance. Proceeding to Station 1. Out."

Trouble Call: "Ragnarok - Smith, 10:04 Follow-up. N-Deck Corridor 3. Confirming phaser-fire, two officers dead, no sign of weapon or attacker. Condition 4 now. Out."

Intruder Control

The Intruder Control System is built into every Starfleet vessel. Its task is to prevent armed invaders from gaining control of a vessel, or to aid the officers in recapturing their vessel. Its main features are humanity (in that it can neutralize such a threat without casualties), flexibility (since it can be programmed to fit a wide variety of scenarios), and speed. It is controlled from the Internal Security Station in the Bridge and Auxiliary Bridge, and has two functional categories: Isolation and Anaesthesia.

-Isolation

The Internal Security Station can lock/activate and door, isolation force-field, turbolift station, and hatch within a ship. This allows the Security Watch Officer to quickly seal-off as much or as little of the vessel as is warranted:

- 1 - Any selected compartment(s).
- 2 - Any selected stretch of corridor (Segment).
- 3 - Any deck(s).
- 4 - The entire ship.

-Anaesthesia

The Internal Security Station can close-off the air recycling ducts from any compartment, segment, or deck, and feed Anaesthesia gas through the vents instead. The gas (absorbed through the lungs) causes unconsciousness in a concentration of one part per thousand, acts rapidly (five

to ten seconds after initial respiration), and poses minimal risk to personnel through overdose. Once affected personnel are removed to pure air (or after the gas is blown clear) conscienceness returns within twenty minutes. The Security Watch Officer can gas:

- 1 - Any selected compartment(s).
- 2 - All compartments except the Bridge.
- 3 - All compartments/corridors except selected.

Total exposure to Anaesthesia gas must be less than five hours duration. Prolonged exposure (6+ hours) is hazardous, leading to cardiac palpitations and death. Since the gas is potentially deadly, while the Security Watch Officer can isolate any part of the ship on his own authority, he must have direct orders from the Captain or acting CO to gas any area.

-Override

Somewhere in every Starfleet vessel - in a location known only to the Captain and First Officer - is another simplified Intruder Control Initiator. A small concealed niche, it holds a pair of air masks, a Type 2 phaser, and the Intruder Control Override. In the event that both Bridges are captured but the Captain or First Officer have managed to evade capture, they can open the niche, don the mask, and key-in the override-code. This will instantly flood the entire vessel (including both Bridges) with Anaesthesia gas.

Two additional overrides can be keyed from this niche. The second is the Destruct Override, from which the vessel's Destruct Sequences can be keyed directly into the Main Computer. The third is the computer Override, which if triggered will disrupt all computer activity within the ship (and so disrupt all but auxiliary-powered systems). The location of said Initiator appears on no blueprint or technical manual - solely in the Command Packet.

Restricted, Controlled & Sealed

-Restricted

In every ship there are some areas to which access is restricted to authorized personnel. The reason may be the presence of classified materials, or vital equipment, so that special care must be taken against espionage and sabotage. These areas will be closed-off, their doors clearly marked with a special emblem.

Depending upon the Alert Status or Condition, sentries may be posted to prevent forced access. Regardless, computer-monitored voice recognition scan is automatically carried out. Examples of Restricted Areas include:

Starfleet DYNAMICS

- Main Computer Core
- Airlocks
- Docking Bays
- Transporter Rooms
- Security Office Complex
- Main Engineering
- Phaser Fire-control
- Pho-torp Fire-control
- Hangar Bay
- Auxiliary Bridge
- Sensor Platforms

-Controlled

In every ship there are areas to which access - while not restricted to authorized personnel - is none-the-less closely monitored. These are areas which are relatively open to the entire ship's complement, but which must be watched for the safety of the ship. These areas are not marked. Examples of Controlled Areas include:

- Bridge
- Communications
- Sickbay
- Cargo Bay

-Sealed

On the order of the Captain, any compartment in the ship may have its doors sealed, to prevent access by all personnel - such as the protection of a crime scene. The door's motor will be disconnected, and sealing tape will be run across it several times from door-frame to door-frame. To one of the frames - over a tape end - a seal monitor will be attached. The tape acts as a warning not to enter, as well as an antennae for the monitor. Should the door be forced open, the breaking of the tape will alert the monitor, which will send a violation alert to the Bridge Internal Security Station

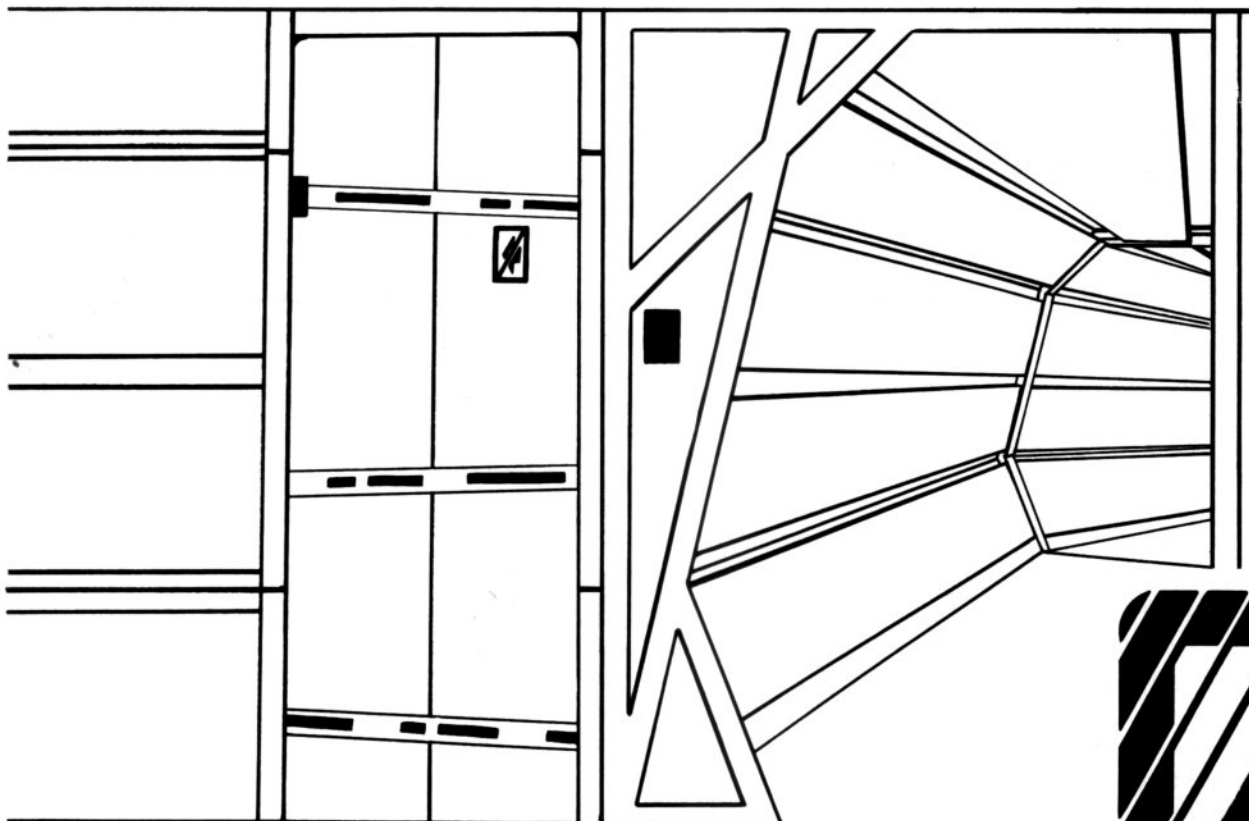

Equipment

-Phaser - Technical Evolution

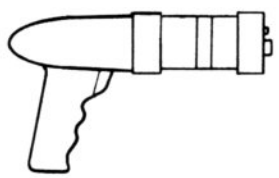

2180
Type 1 - Hand Laser



2210
Type 2B - Hand Phaser

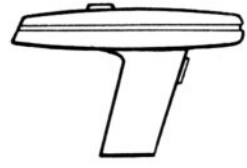

2260
Type 2 - Hand Phaser

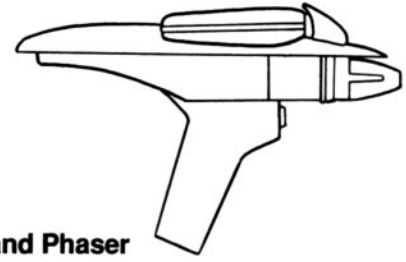

2280
Type 2C - Hand Phaser

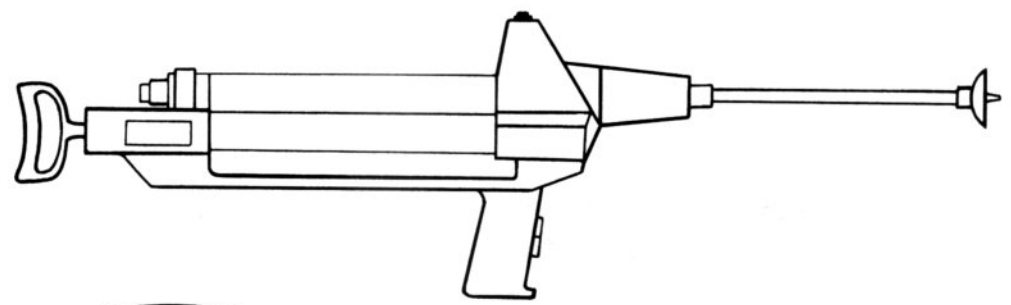

2250
Type 4 - Phaser Rifle

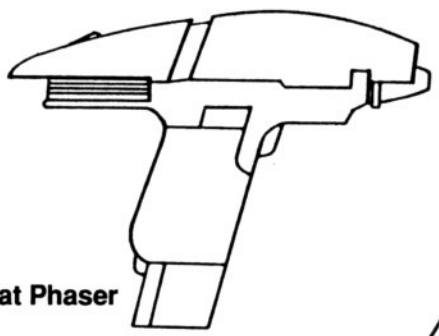

2290
Type 4D - Combat Phaser

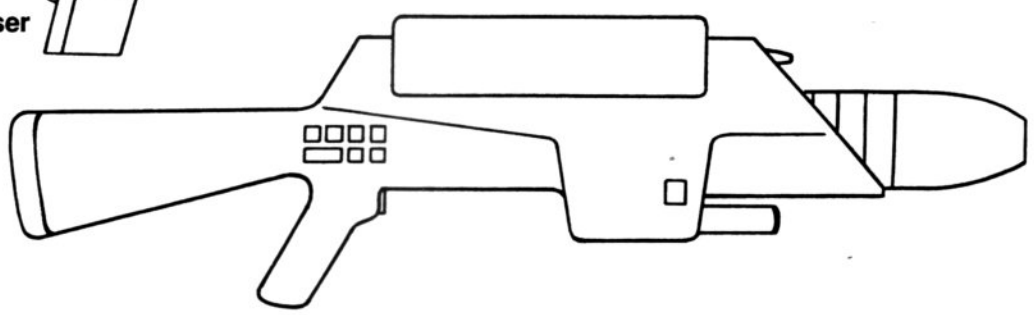

2285
Type 10 - Phaser/Grenade Assault Cannon

Starfleet DYNAMICS

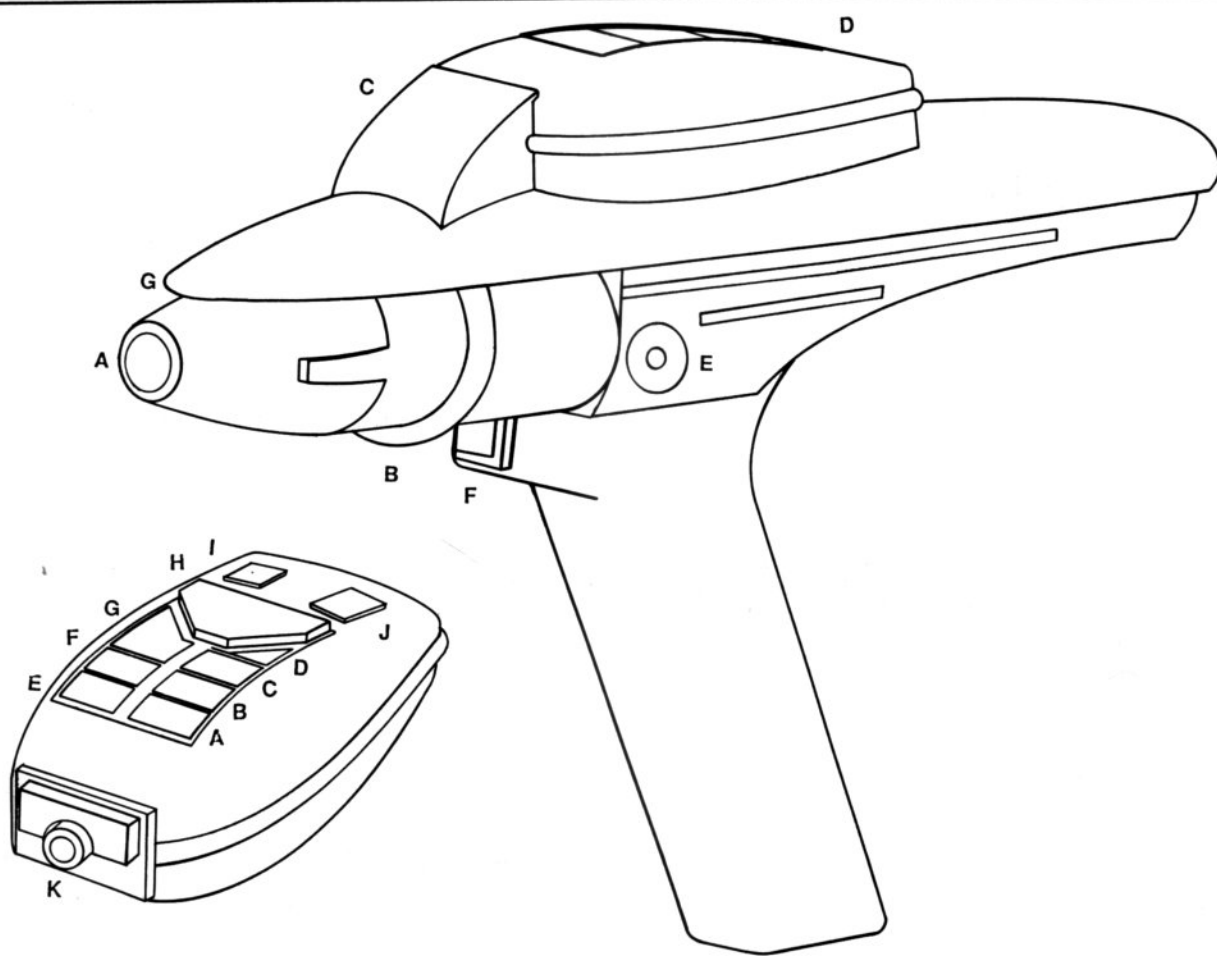

Type 1C - Hand Phaser

Particulars:

Length	105 millimeters
Width	50 millimeters
Height	25 millimeters
Stun	50 meter range
Heat	5 meter range
Disrupt	30 meter range
Dematerialize	15 meter range
Overload Blast	60 meter radius

- A) Stun
- B) Heat
- C) Disrupt
- D) Dematerialize
- E) Narrow Beam
- F) Wide Beam
- G) Power Level Indicator
- H) Trigger
- I) Arm
- J) Lock Release
- K) Nozzle

Type 2C - Phaser

Particulars:

Length	285 millimeters
Width	50 millimeters
Height	185 millimeters
Stun	150 meter range
Heat	10 meter range
Disrupt	100 meter range
Dematerialize	50 meter range
Overload Blast	200 meter radius

- A) Nozzle
- B) Beam-width Setting Ring
- C) Forward Lock-plate
- D) Type 1C - Hand Phaser
- E) Recharging Jack
- F) Trigger
- G) Parallel Beam Indicator Laser

Security Department

-Description

The Type 2C Phaser is the principle hand weapon used by Starfleet. It has the virtue of being almost endlessly adaptable to any situation. It is comprised of two parts: the Type 1C Hand Phaser, and the pistol-grip/powerpack. The Type 2C is a dilithium energized weapon, emitting a variable photon/sub-atomic particle beam. The beam is highly matter-cohesive in behavior: If fired at a material object, it will envelop the entire outer surface of the said target unless set otherwise. The Type 2C has no sighting mechanism. Accurate aiming is achieved via Parallel Beam Indicator.

-Operation

Loading: The Type 2C pistol mount has an integral

dilithium crystal within the grip. Recharging is achieved via the jack. If fully depleted the crystal will decay and require replacement.

Arm/Disarm: The Type 2C must be kept disarmed until the holder is prepared to shoot. To arm, touch the ARM control atop the Type 1C - which will light-up. To disarm, touch the ARM control again. The trigger of the Type 2C will remain inert so long as the weapon is not armed.

Lock/Dislock: To lock the Type 1C and the pistol grip together, the Type 1C is placed in the niche atop the grip. A monatomic adhesion surface in the niche will activate, mating the two pieces together, and deactivating the Type 1C's trigger in favor of the pistol's. All other Type 1C controls remain active. To dislock, press the lock release control.

Type 4D - Combat Phaser

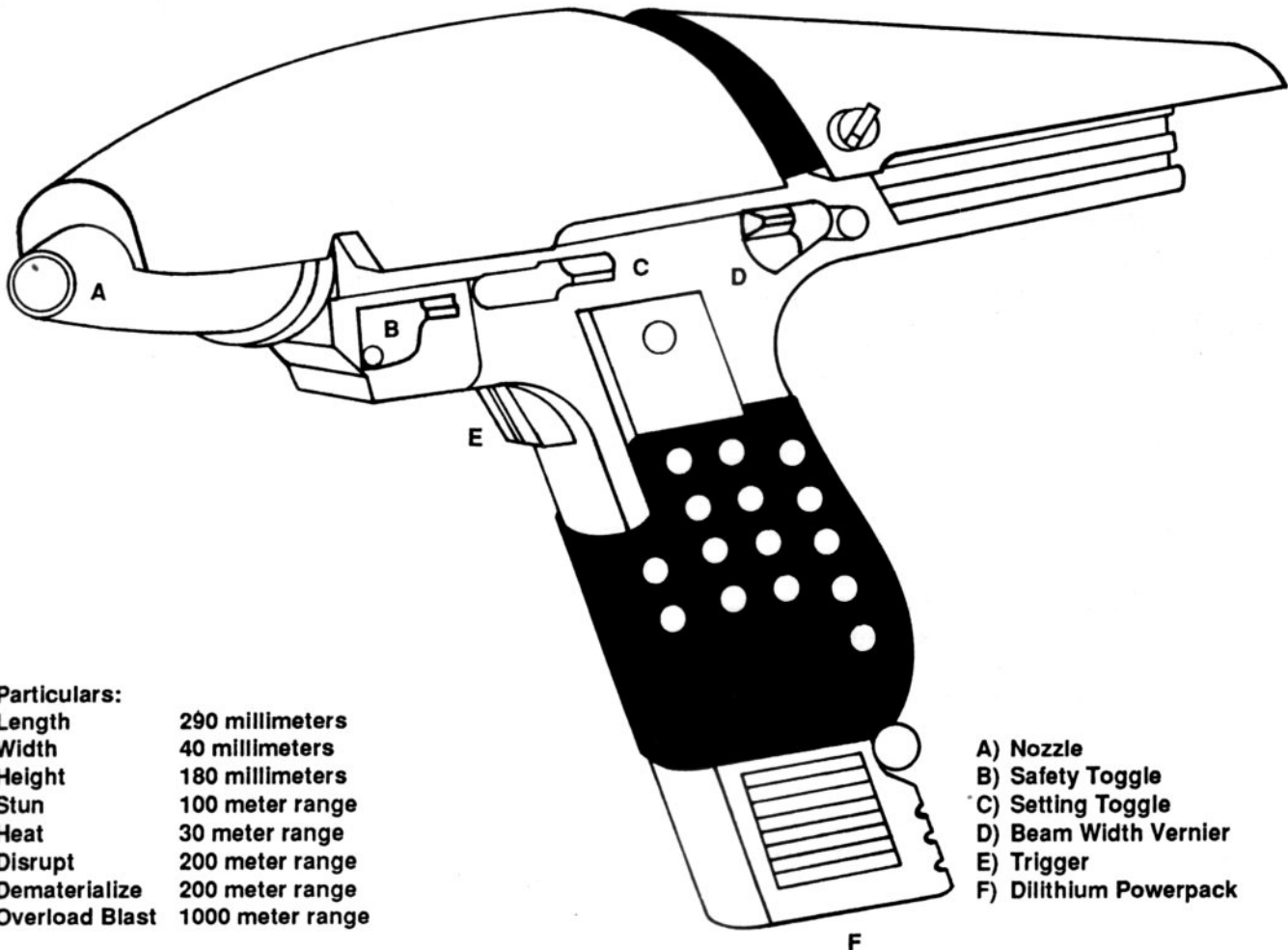

Particulars:

Length	290 millimeters
Width	40 millimeters
Height	180 millimeters
Stun	100 meter range
Heat	30 meter range
Disrupt	200 meter range
Dematerialize	200 meter range
Overload Blast	1000 meter range

- A) Nozzle
- B) Safety Toggle
- C) Setting Toggle
- D) Beam Width Vernier
- E) Trigger
- F) Dilithium Powerpack

Starfleet DYNAMICS

-Description

The Type 4D - Combat Phaser is a light-weight, dilithium energized weapon, meant to be used by a trained Marine or Security Specialist. Because this weapon is intended solely for combat usage (as opposed to the Type 2C, which can be carried during Landing Party missions) the Type 4D is much more rugged. There is no detachable hand-sized module which can be concealed under the tunic for ceremonial visits. The controls are different from most Starfleet ordnance in that they consist of moving parts - toggles and thumb verniers. This allows a trained operator to adjust his weapon's settings with the thumb and forefinger of his right hand (while holding it in the same hand), freeing his left hand (and eyes) for other tasks. This weapon can be set for continuous beam or half-second burst.

-Operation

Because of the necessity of rapid recharge during combat conditions, the Type 4D does not feature a normal Recharge jack. Rather, the powerpack is slid out of the handle, and replaced with a fresh one. If sufficient time for normal recharge exists, a Recharge Jack is mounted on the outside end of the powerpack.

Type 4D Phasers are not kept in the armory, as they are never intended to be used aboard ship. Rather they are stored in the Marine Ready Room and the arms cabinet aboard Assault Shuttlecraft.

Type 10 - Assault Cannon

-Description

The Type 10 - Assault Cannon is standard ordnance issued to Starfleet Marines for EVA duty. For planet surface infantry, one Specialist always carries the Type 10 as a back-up to his mates' Type 4D. It features both Phaser Cannon and Grenade Launcher.

-Features

The most praised feature of this weapon is its low weight:power ratio. This has been accomplished by incorporating only a relatively small powerpack into the cannon itself, with the launcher only holding four grenades. When used with the Mark 8 - Battle Suit, both the powerpack and the launcher are recharged-reloaded every time the weapon is returned to its storage rack. When used without the Mark 8 (such as on surface missions to a Class M world), a special grenade magazine (holding eight grenades) is attached to the launcher, while an umbilical power cable connects the cannon to a backpack powerpack.

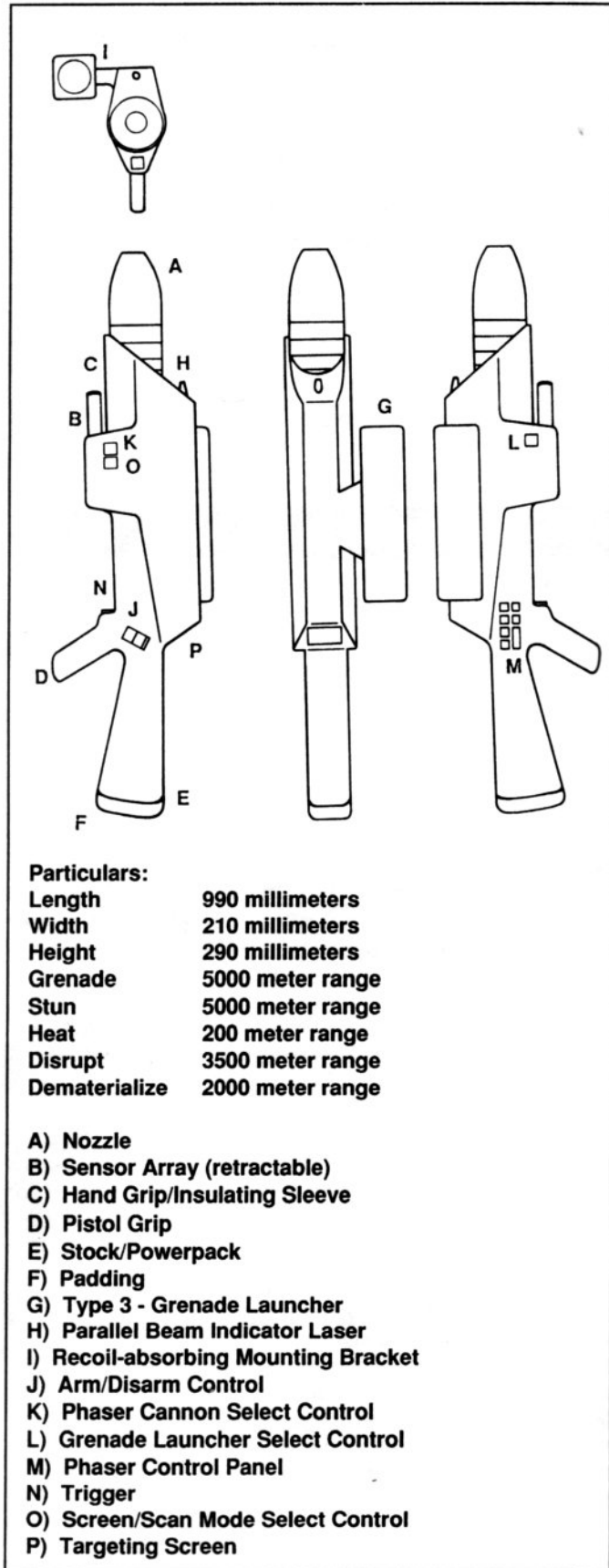

Particulars:

Length	990 millimeters
Width	210 millimeters
Height	290 millimeters
Grenade	5000 meter range
Stun	5000 meter range
Heat	200 meter range
Disrupt	3500 meter range
Dematerialize	2000 meter range

Security Department

-Fire-selection and Targeting

The most appreciated qualities from a Marine view-point are the simplified Fire-selection controls, which allow him to choose between the cannon or launcher, and select the setting or range quickly. This is aided by the Targeting system, which displays all functions and settings - as well as the sensor readouts. Targeting modes include:

Parallel Beam Indicator: Fires a harmless laser beam at the exact point cannon beam will hit.

Grenade Laser Aiming: The Type 3 - Projectile Grenade is a smart weapon, and can seek out and impact the indicator spot. The targeting screen will also advise the operator on the precise angle required for ballistic trajectory.

Laser Relay Targeting:

1 - One Type X can be utilized to illuminate a target with an indicator spot, whereupon several other launchers can fire grenades at the same spot, allowing extreme accuracy for multiple-fire missions.

2 - Using Sensors, an orbiting starship's phaser banks or photon torpedoes can be locked-onto a target illuminated by a Type 10.

Patch-in Display: Any EVA Marine can relay his Type 10's sensor data directly to his helmet faceplate HUD (Head's Up Display), and/or can relay this telemetry to other Section members

Targeting Enhancement: Greater onboard processing power improves the Visual data.

Caution: Due to the enormous danger such a weapon would pose to a vessel, it is never used or armed aboard ship. All Assault Cannon are kept locked within the Marine Equipment Lockers adjacent to a vessel's Airlocks and Transporter Rooms, and within the Marine Shuttle. Because of the relatively small powerpack, there is no overload option

-Description

A short-range artillery weapon used to destroy targets which are out-of-range of effective phaser fire, or are behind intervening hills or other obstacles. Can be fired on a ballistic trajectory, or home in on an indicator spot. Fusing is by impact. The warhead is a dilithium chamber, which is triggered to near-overload just before firing.

Type 3B - Sonic Grenade

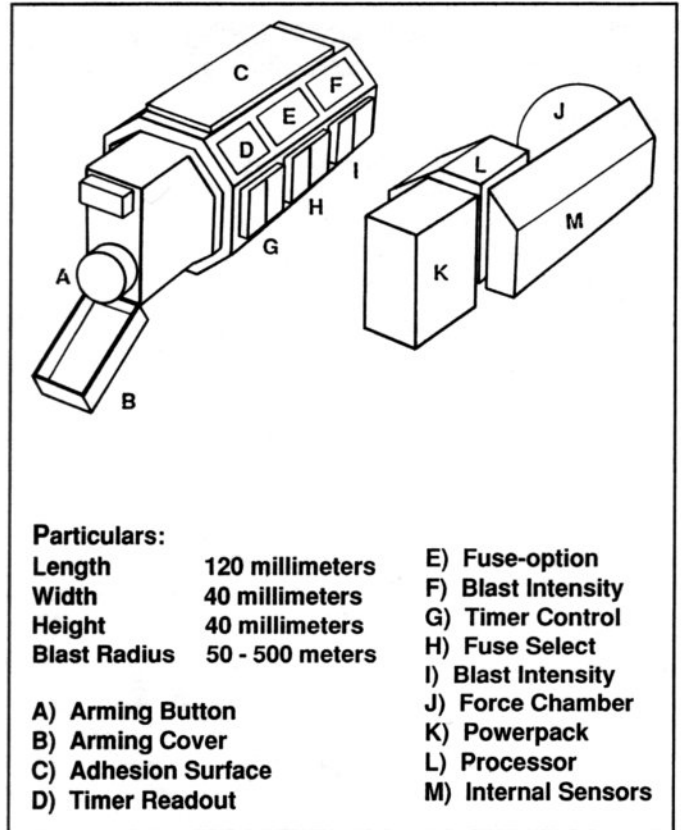

Particulars:

Length 120 millimeters
 Width 40 millimeters
 Height 40 millimeters
 Blast Radius 50 - 500 meters

E) Fuse-option
 F) Blast Intensity
 G) Timer Control
 H) Fuse Select
 I) Blast Intensity
 J) Force Chamber
 K) Powerpack
 L) Processor
 M) Internal Sensors

A) Arming Button
 B) Arming Cover
 C) Adhesion Surface
 D) Timer Readout

Type 3 - Projectile Grenade

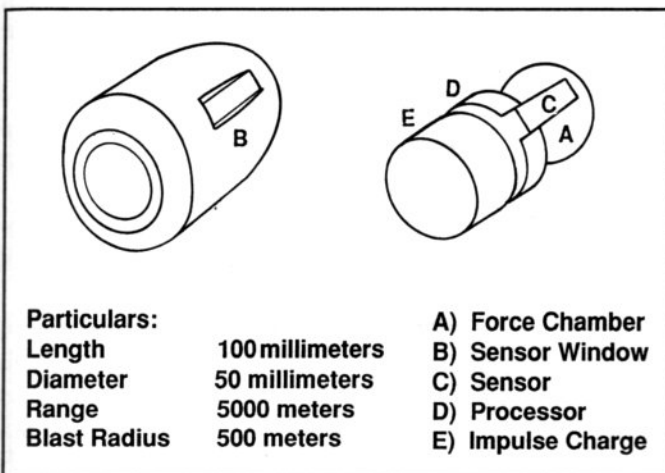

Particulars:

Length 100 millimeters
 Diameter 50 millimeters
 Range 5000 meters
 Blast Radius 500 meters

A) Force Chamber
 B) Sensor Window
 C) Sensor
 D) Processor
 E) Impulse Charge

-Description

A man-portable explosive device, delivered by hand-throwing or placement. The explosion is caused by a force chamber overload, which allows the operator to select blast intensity by choosing how much power to feed the chamber from the powerpack. The Type 3B can be used in the following modes:

Hand Grenade: Open Cover, depress Arming Button, and throw. Automatic minimal detonation in fifteen seconds.

Satchel Charge: Set timer to desired duration, activate magnetomic adhesion strip with Fuse Select Control, attach to target object, open Cover and depress Arming Button.

Proximity Mine: Activate Sensors with use Select Con-

Starfleet DYNAMICS

trol, activate magnatonic adhesion strip as above, attach to target area, open Cover and depress Arming Button. After a ten second delay period to allow operator to get clear, Grenade will detonate at the next approach of a large mass.

Remote Mine: Activate communicator channel with Fuse Select Control, open Cover and depress Arming Button. Grenade will detonate when the correct code-word is transmitted from a communicator on the proper channel (6).

Disarming: A set Grenade can be disarmed by the transmission of the correct code-word.

Boatswains's Call

-History

The origin of the Boatswains's Call or Whistle dates back to the ocean-going navies of thirteenth century Old-Earth. The Boatswain was the officer in charge of rigging the sails of wind-powered ships. As such, he had to simultaneously coordinate the activities of dozens of men aloft in the rigging. These men had to be able to hear his commands

in all sorts of weather conditions. To this end, the men were rigidly trained so as to instantly recognize and respond to different Whistle calls - ten in all - covering a wide spectrum of orders.

-Present-day

Today, the Call is kept for traditional reasons as a ceremonial aid. It is used as a mark of respect to "pipe" the Captain, visiting flag officers, or VIP's aboard, as they enter the ship via Airlock or Transporter. At such receptions, the Call is worn by the senior Security person present, who is designated as honorary Boatswain. The Call is worn at the end of a one-meter white lanyard, one end shackled to the Call, and the other looped about the operator's shoulder.

-Operation

The Call is capable of only two notes (High and Low), both synthesized electronically. It is not a wind instrument, although it is activated by being blown-into. It is held between the index finger and thumb of the right hand, with the thumb over the shackle, the index finger atop, and the other three fingers curving over the unit. When the mouth-

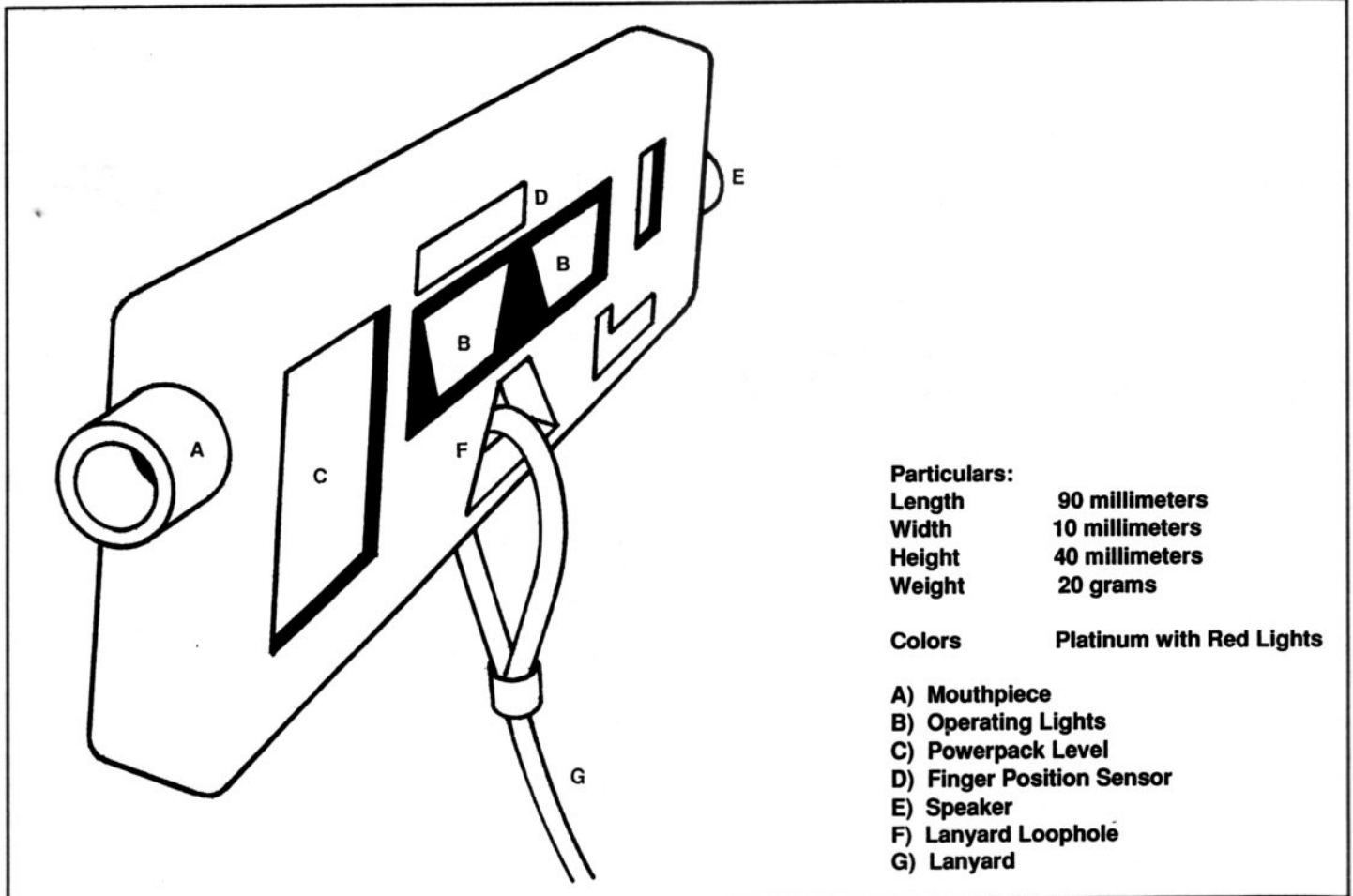

Particulars:

Length	90 millimeters
Width	10 millimeters
Height	40 millimeters
Weight	20 grams

Colors Platinum with Red Lights

- A) Mouthpiece
- B) Operating Lights
- C) Powerpack Level
- D) Finger Position Sensor
- E) Speaker
- F) Lanyard Loophole
- G) Lanyard

Security Department

piece is blown into, the Low tone will sound unless the three fingers approach the sensor, which will engage the High note.

Piping flag officers:

0.5 seconds 2.75 seconds 0.5 seconds
[Low] [High] [Low]

Abandoning Ship

When a ship is so badly damaged that all or part of her must be evacuated, it is the Security Department which is assigned the task of coordinating the evacuation, and minimizing the threat to the crew. Going to Condition 5 (Evacuation Alert), they will conduct a Phase 1 Sweep-search through the affected portion or entire vessel searching for stragglers. There are five Abandon-Ship Scenarios. Which one the Captain chooses will be dictated by:

- Extent of damage (Must the entire vessel be abandoned? How much power is still available? Which propulsion systems are still available?)
- Type of vessel (Is there more than one hull?)
- Location (Proximity to nearest inhabited world, and/or Class M world? Distance from nearest Starbase?)

Scenarios 1 through 5

-Scenario 1 - Evacuation Transporters

Built into the Primary Hull of every Class 1-B starship are a series of Emergency Evacuation Transporters. Each of these is capable of transporting twenty-two persons at a time. If the entire vessel must be abandoned (there is no undamaged hull left), if the doomed vessel is within range of a Class M world or other habitat, and if there is power available, the Captain will announce: "All Hands, Abandon ship: To the Emergency Evacuation Transporters!" on the intership intercom circuit. Each crewman will make his way to his pre-assigned Emergency Transporter. There are three such Transporters on H-Deck of every Class 1-B starship.

-Scenario 2 - Evacuation to Secondary Hull and Separation *

If the Primary Hull has suffered such severe damage that it must be abandoned, the Captain announce: "All Hands - Evacuate the Primary Hull! Prepare for Separation!" All personnel in the Primary Hull will immediately proceed to the Secondary Hull. Once the Captain is in the Control Room, and after getting the okay from the Security Watch

Officer coordinating the evacuation sweep, the Captain will order the Chief Engineer to blow the explosive bolts at the hulls' connection point, separating them. The Secondary Hull will then proceed at a moderate warp speed to the nearest Starbase.

-Scenario 3 - Evacuation to Primary Hull and Separation

As above, but involving evacuation from the damaged Secondary Hull to the Primary Hull. If the Primary Hull is completely intact, and if there is sufficient power, the Captain may elect to wait for rescue within the Primary Hull, which can then easily support the requirements of all personnel for several months. If there is a Class M world within Impulse Drive range, and if there is sufficient power for Transporters, the Captain may utilize Scenario 1 later upon reaching orbit.

-Scenario 4 - Primary Hull Separation and Subsequent Landing

Involving either evacuation from the damaged Secondary Hull to the Primary Hull, or total and irreversible loss of Warp Drive to a vessel without a Secondary Hull. If the Primary Hull will not be able to maintain life-support until rescue arrives, the Primary Hull is within Impulse Drive range of a Class M world, but there is insufficient power to utilize the Evacuation Transporters, the Captain may then elect to enter the planet's atmosphere and land the Primary Hull. Using the Impulse Drive, Thrusters, and the built-in aerobraking effect of the Primary Hull's undersurface (which was shaped for just such a contingency), the Primary Hull can be safely landed on its four folding landing legs.

* Obviously this option are only available to a starship possessing more than one hull. For ships possessing only one hull, abandoning ship is actually less likely. In the case of a Scout, separation of the Nacelle and Interconnecting Dorsal, a one-step evacuation and ejection, eliminates both the Nacelle (which could be unstable) and the Matter/Antimatter Reactor. This advantage is seen to outweigh the possible risk entailed in not having a Secondary Hull Life Boat Refuge. In the case of a Frigate of course, ejection is not accomplished as easily.

Starfleet DYNAMICS

-Scenario 5 - Life Boats

If the entire vessel must be evacuated, and the vessel cannot use Scenarios 1 through 4, the Captain will announce: "All Hands - Abandon Ship! To the Life Boats!" The following is a listing of the auxiliary craft and Life Boats making up the Evacuation Flotilla of starships and spaceships:

* Spaceships and smaller starships do not possess Hangar Bays. Instead, a Hangar Pocket on the starboard/forward underside of the Primary Hull (opposite the Airlock) holds and launches all craft.

Life Boat Boarding and Launch: Non Command Pilot crewmembers will immediately make for the nearest Life Boat Stations. At each, one or two persons will open the door, open the Life Boat's hatch beyond, and board. After sealing both door and hatch behind them, they will sit and fasten the seat restraints, and state "Code 1" or Code 2". The Life Boat's internal systems will have been armed by the opening of the hatch. At the code command, the selected ejection scenario will commence:

Auxiliary Craft Warm-up: As the Life Boats begin leaving the ship in a loose, expanding spherical cloud, the

Starship Auxiliary Craft & Evacuation Fleets							
VESSEL CLASS & TYPE	SHUTTLES	SHUTTLE CRAFT	TRAVEL PODS	TOMO-HAWKS	TALONS	BEES	LIFE BOATS
CRUISER CLASS							
Dreadnought	2	6	2	4		10	200
Heavy Cruiser	2	6	2	4		10	200
Strike Cruiser	2	8	2	8	5	10	200
Battlecruiser	2	6	2	10	5	10	200
Cruiser	2	6	2	4		10	200
T-D Carrier	4	10	2	10	7	10	200
FRIGATE CLASS							
Heavy Frigate	4	4	2	2	5	6	120
Fast Frigate	4	4	2	2		6	120
Medical Frigate	2	4				10	200
Frigate	2	4	2	2		6	120
ESCORT CLASS							
Scout		2	1	2		6	120
Destroyer		2		4		6	120
Super Destroyer		2		4		6	120
Heavy Destroyer		2		4		6	120
Fast Destroyer		2		4		6	120
CLASS II							
Corvette		2	2			3	60
Diplomatic		2	2			3	60
Survey		2	2			3	60

In the case of the Bees, each tows a 20-life boat train as part of the Evacuation Fleet. As an assault craft, each Bee is either a Wasp or Hornet

Security Department

Bees start collecting them. Each Bee can link-up to 20 Life Boats, and will tow the finished "Life Boat Train" to the rendezvous point..

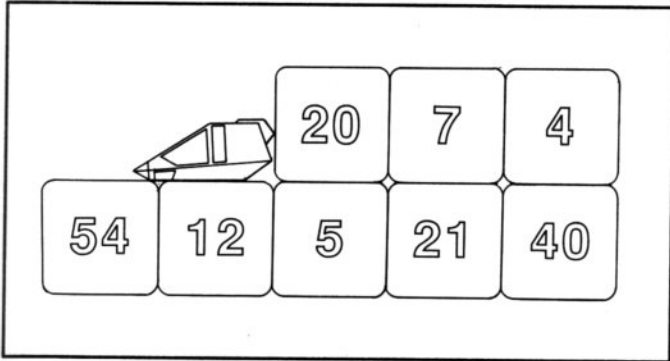

Auxiliary Craft Warm-up: At the call to Abandon Ship, the on-duty Command Pilots will proceed to their auxiliary craft and warm-up the Bees, Travel Pods, Shuttles, and Shuttlecraft. All but one Shuttlecraft will exit the ship and take-up station ten kilometers from the ship, activating their rendezvous transponders. Shuttle One will proceed to the Bridge docking port and pick-up the on-duty Bridge Crew. Shuttle Two will proceed to the Primary Hull Airlock and pick-up the on-duty Medical Staff and any Sickbay patients. Both will then proceed to the rendezvous point.

Evacuation Sweep: At the call to Abandon Ship, the on-duty Security Section (thirty men in most starships) will divide into their five Squads. Squad 5 will proceed to the Brig and Sickbay, removing all occupants to the awaiting Shuttle Two. Squads 1 through 4 will begin a rapid but thorough Phase 1 Sweep-search of the entire ship, removing any personnel they find to the Flight Deck. Within twenty minutes from the first call to Abandon Ship, they must all have arrived at the Flight Deck. They and anyone they have found will then board the last Shuttlecraft, which will have been waiting for them along with Squad 5.

Thruster Suits: Any personnel unable to reach a Life Boat or the last Shuttlecraft in time may still exit the ship via an thruster suit. This is a short-duration (6 hours) pressure suit, with a thruster/control unit backpack. The thruster is capable of producing speeds of 5 meters/second, and can be steered to the rendezvous point.

Check-Off: As each Life Boat Train arrives at the rendezvous point, the Bee Command Pilot will transmit a list of all personnel to Shuttle One. The Command Pilots of all other auxiliary craft do likewise. The Captain will examine the lists, compare them to the ship's muster, and decide if the number of unaccounted-for persons (if any) warrants the further

risk inherent in sending a Shuttle back to search.

Flotilla Disposition: Once all auxiliary craft and Life Boat Trains have achieved rendezvous, the Captain will decide which option to pursue:

- Send a subspace distress call from the Shuttles' low-powered transmitters and await retrieval from a Starfleet or commercial vessel.
- Negotiate with non-Federation vessels for retrieval and delivery to a Federation-member world. This includes most hostile forces. With the notable exception of Klingons, most enemy ships which destroy a vessel will still rescue an Evacuation Flotilla.
- Land on a nearby Class M world. Bee Thrusters, powered by a Life Boat's powerpack, are capable of safely lowering a Life Boat through an atmosphere to a landing.

Life Boat

-ELSE-6

The ELSE-6 (Emergency Life-Support Environment) is the latest Life Boat on all Class 1-B and Class 2 vessels, and can sustain one humanoid for 2 months (or 2 humanoids for 1 month). Each is a self-contained miniature spaceship, complete with environmental, waste elimination, food, power, and propulsion systems. The hull is terminium, with four attitude thruster-packages at the equator and one main thruster. Control is via a small console, which folds out from the wall in over the port seat. Although intended to be attached to a Bee as part of a Life Boat Train and landed as part of said unit, if necessary each Life Boat can make individual planet-fall, using the built-in parachute. The onboard systems include:

- **Powerpack:** Holds three five-megawatt dilithium crystals, and powers all modules. Energy from the powerpack can be tapped by the Bee if required (eg: landing thrust).
- **Environment:** Circulates and refreshes air. Scavenges water vapor from crew exhalations and Sanitary Unit, and returns same to a reservoir.
- **Sanitary:** Beneath the starboard seat is the toilet seat, the Environment air inlet, and a waterless cleansing unit.
- **Rations:** Holds 60 FS9-4 Food Pouches, each supplying all the nutritional requirements of one humanoid in a zero-G environment for one day, plus assorted supplemental pouches to tailor the FS9-2 to more esoteric alien biochemistries.
- **Equipment:** Holds two Phasers, two Tricorders, ten Combat Communicators, a Medikit, various entertainment tapes and players, and a hard-copy of the Starfleet Medical Reference.

Starfleet DYNAMICS

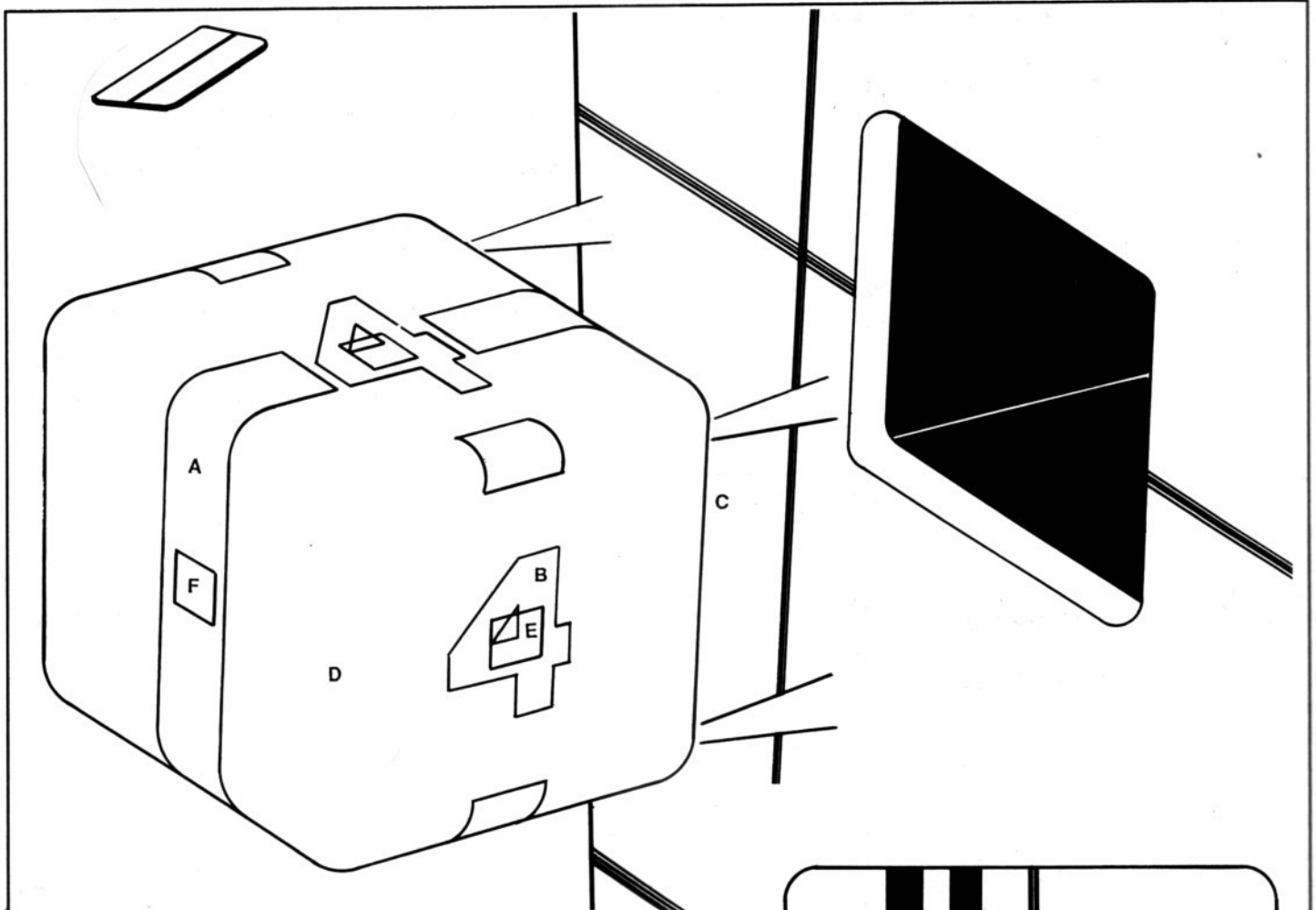

Particulars:

Length 2.5 meters
Width 2.5 meters
Height 2.5 meters
Weight 200 kilograms
Colors Orange with Yellow Markings

- A) Equatorial Stripe
- B) Identification Number
- C) Entry Hatch
- D) Terminusium Casing
- E) Umbilical Connections
- F) Bee Lock-on Attachments

-Life Boat Stations & Lockers

Life Boats are located throughout the ship, on every deck. They are mounted within their own airtight compartments (Lockers), just inside and against the hull. The hull plates covering the Life Boat Lockers are attached via explosive bolts, and can be jettisoned for Life Boat ejection. Life Boat Station doors are plainly marked, and are aluminium-colored with orange markings.

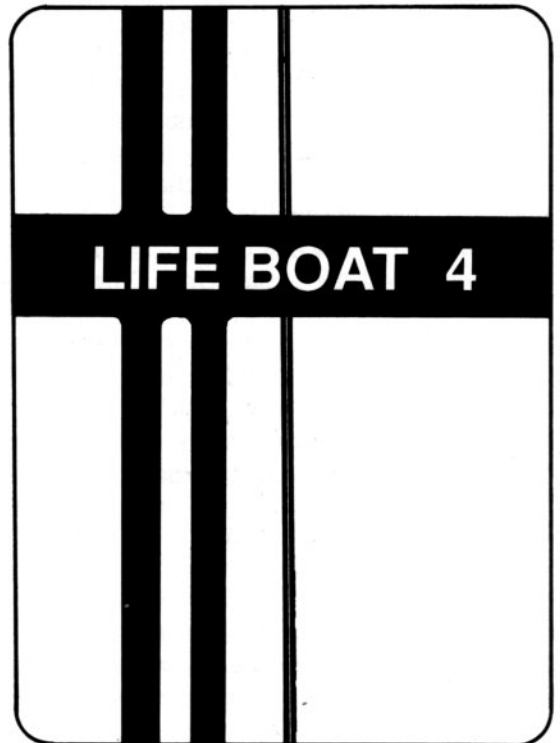

Extra-Vehicular Activity Procedures

Before any EVA - whether for working on the ship's hull, search duty, or any other purpose - authorization must be obtained from the CO. Before such authorization, the CO will order all Departments to "Secure for EVA", which entails the following necessary steps:

Ordnance: All ship's defense fields are deactivated - preventing exposure of EVA personnel to high intensity oscillating gravitronic fields.

Communications: A radio check is made with EVA personnel before they are cycled through the Airlock. All

transmitters except the low-powered ship-to-suit system are disconnected to protect EVA personnel from exposure to electromagnetic and tachyonic emissions.

Sciences: All external sensors are powered-down and locked-off to protect EVA personnel from powerful and complex fields and radiations.

Engineering: All maneuvering thrusters are disarmed, to protect EVA personnel from accidental discharge of highly-ionized particle beams. Both Impulse and Warp Drives are powered-down, to protect EVA personnel from stray emissions of esoteric radiations, particles, and fields. Likewise the Main Reactor is reduced to a low-output level, to reduce leakage of antimatter particles from flush vents.

Spacesuits

-Mark 7 Space Suit

Particulars:
Weight 55 kilograms

- A) Helmet
- B) Faceplate (Polarizing)
- C) Communications Module
- D) Torso Unit (2 halves)
- E) Thruster Packages (4)
- F) Thruster Controls
- G) Electronics Module
- H) Power and Life-support
- I) Fabric Suit

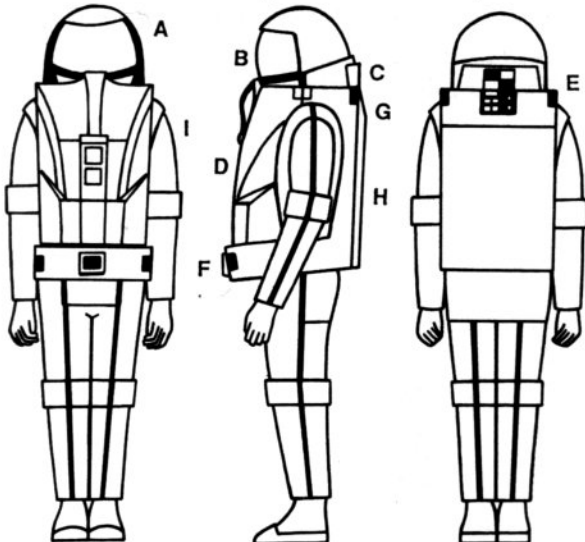

-Mark 8 Battle Suit

Particulars:
Weight 65 kilograms

- A) Helmet
- B) Faceplate (HUD)
- C) Communications Module
- D) Torso Armor (2 halves)
- E) Thruster Packages (4)
- F) Thruster Controls
- G) Electronics Module
- H) Power and Life-support
- I) Armor Segments
- J) Fabric Suit
- K) Armored Adhesion Boots
- L) Assault Cannon Rack

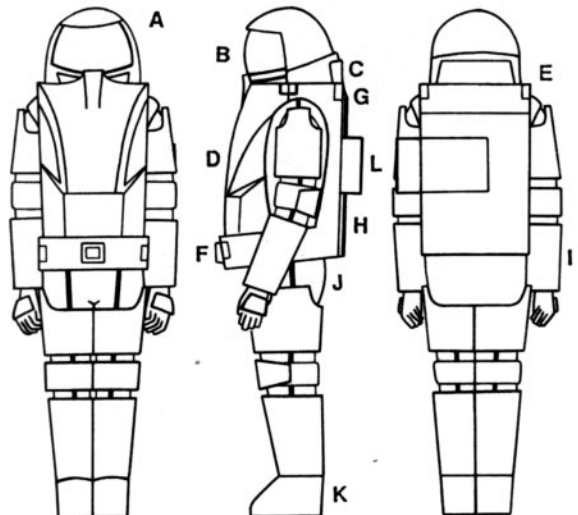

The Mark 8 is issue armor used by the Starfleet Marine Corps Armor Platoons on EVA. It is an enhanced version of the Mark 7. Added features include:

- Xenokevlar armor segments on extremities
- Xenokevlar laminate on Torso Unit, Helmet, and Boots.
- Heads-Up Display for intelligence and suit-data readout (via Chromatic Liquid Crystal laminated to the faceplate's inner surface.
- Retractable rack for Assault Cannon, which fully recharges/reloads weapon each time it is racked.



Engineering Department

Power Systems

Power Distribution

-Main Power Systems Board - Heavy Cruiser

The illustration shows the Main Power Systems Board, monitored by the Engineering Watch Officer at all times. This displays all Power Sources, Fuel Storage Facilities, Power Distribution Systems, Power Grids, and Propulsion Systems.

There are three Power Sources aboard a starship, and five Major Distribution Networks to carry said power to the usage points or Power Grids. When not running on the Mains, it is the duty of the Power Division to balance the demand for power within one or more of the Power Grids so as to match the power output available. This may entail the temporary shut-down of various non-essential Systems within a Grid. Contrawise, a particular System (such as Sickbay) may order that it be given priority treatment. The Power Sources, Distribution Networks, Power Grids, and Systems are listed below according to capacity and power demands:

-Power Sources

Mains: (Matter/Antimatter Reactor-Intermix Shaft coupled with Main Energizer)

- Maximum Output 2.4 petajoules/second (2,400,000,000,000,000 joules/second).
- Capable of supplying all Power Grids and Systems at 100% full-power.

Auxiliary: (Deuterium/Tritium Fusion Reactor coupled with Secondary Energizer)

- Maximum Output: 1.4 terajoule/second (1,400,000,000,000 joules/second).
- Capable of maintaining all but the Warp Drive

Engineering Department

Propulsion System at nominal power levels. Some Stand-by and Constant Systems may require temporary power reduction in order to power-up an Intermittent System.

Battery: (Cold-fusion Storage Cells throughout ship)

- Maximum Output: 10 gigajoules/second (10,000,000,000 joules/second).
- Capable of maintaining Stand-By and Constant Systems at various reduced levels. Some of these may require shutting-down to guarantee power to others.

-Power Grids and Systems

Warp Drive: (High-demand - requires top priority)

- Various internal Sub-systems.

Impulse Drive: (Medium-demand)

- Various internal Sub-systems.

Megaphasers: (Medium-demand)

- Various internal Sub-systems.

Intermittent: (Moderate-demand)

- Phasers
- Deflector Screens
- Force-Field Shields
- Propulsion Thrusters
- Maneuvering Thrusters
- Tractor Beam

Stand-by Power Grid: (Moderate-demand, all Systems not normally powered-up simultaneously)

- Transporters
- Long-Range Sensors
- Navigational Sensors
- Photon Torpedo Launch Bays
- Subspace Transceivers
- Real-space Transceivers

Constant Power Grid: (Low-demand, all Systems normally running simultaneously).

- Bridge and Override Systems
- Antimatter Containment Bottles
- Life-support Systems
- Computer Core and Peripheral Systems
- Fabricators and Defabricators
- Sickbay Complex
- Hangar Bar Systems
- Intercom System
- Turbolift Systems

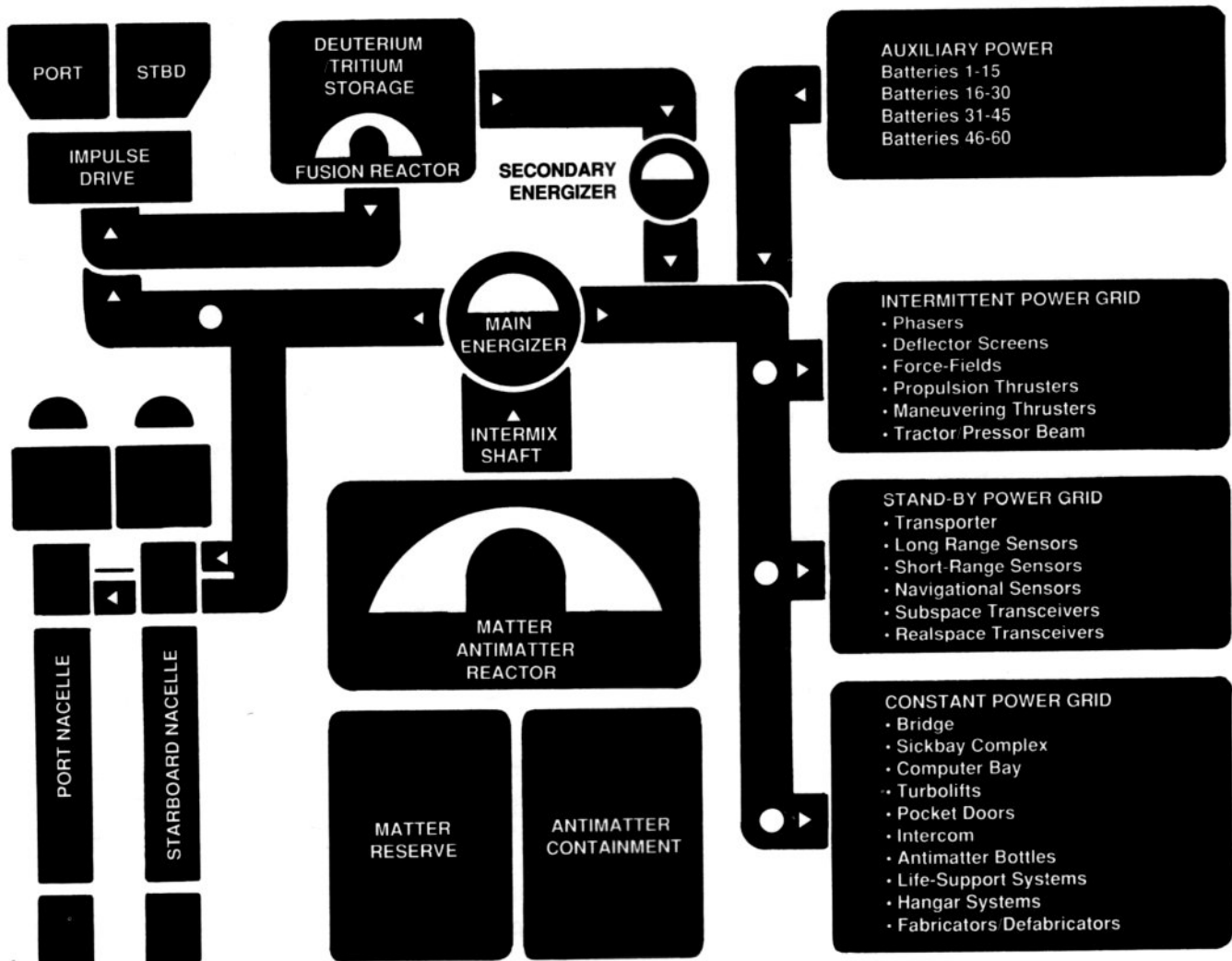

Starfleet DYNAMICS

-Power Distribution Networks

Energy Conduits: Carry pure energy at high intensity to high/medium-demand Grids.

Energy Micro-conduits: Carry pure energy at lower intensity to moderate-demand Systems.

Cables: Carry electrical power over superconducting lines to low-demand Systems.

Main Reactors - Components & Subsystems

The powerplant of a starship is second in potential only to that of a Starbase. It is divided into three main components: Matter/Antimatter Reactor, Antimatter Containment Bottles, and Linear Intermix Shaft.

-Antimatter Containment Bottles

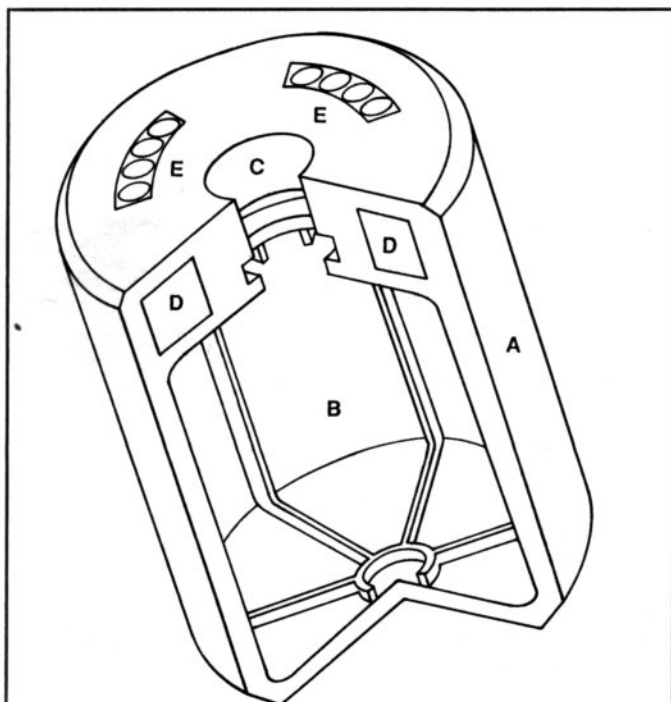

Particulars:

Length	5.0 meters
Diameter	3.0 meters
Weight (empty)	2.0 metric tonnes
Capacity	10.0 cubic meters (52 mt)

- A) Cast Rodinium Shell
- B) Containment Compartment
- C) Bottleneck
- D) Onboard Systems Bay
- E) Ejection Thrusters

Mounted with their inner ends opening into the Reactor, and with their outer ends flush with the skin of the outer hull. The Bottles' inner surface is insulated with a protective force-field, which prevents contact with the antimatter. Antimatter is stored within the Bottles until required by the Reactor. Storage temperature is usually 50 degrees Kelvin - to decrease brownian motion and ease the load on the containment field. Antimatter fuel is drawn from one Bottle at a time. When a Bottle must be tapped, the enclosed antimatter must first be pre-heated within the Bottle to a temperature of 5000 degrees.

Bottle Ejection Sequences: Antimatter Containment Bottles are attached to the Reactor via explosive bolts, (as are the hull skin panels surrounding them - called blow-away panels.) An equipment bay within each Bottle holds the onboard systems, including force-field generator/back-up generator, dilithium powerpack, computer, and ejection thrusters. The powerpack feeds the force-field generator, and is kept charged via a power cable jacked directly into the ship's grid. The computer maintains a constant status check of all internal systems, and relays the telemetry to the Engineering Computer. In the event of a potential problem (such as imminent generator failure, powerpack destabilization, etc.), the onboard computer and Engineering Computer will both initiate the Bottle Ejection Sequences - which requires faster-than-human reflexes to avoid vessel destruction - and will jettison the unstable Bottle in question. The sequences are totally automatic and simultaneous:

Bottle Computer Sequences:

- Assess problem.
- Relay assessment to Engineering Computer
- Seal Bottleneck.
- Blow Bottle's explosive bolts.
- Ignite Bottle ejection thrusters.
- Shut-down Bottle's force-field generator after 20 seconds of thrust (1000 kilometers), resulting in Bottle detonation.

Engineering Computer Sequence:

- Seal affected Reactor fueling port.
- Blow panel's explosive bolts.
- Alert Bridge and Engineering.

After the residual radiation and shockwave have dispersed, Workbees can be sent to chase-down the jettisoned blow-away panels and re-attach same to the vessel.

-Reactor

The Matter/Antimatter Reactor is comprised of the Reactor proper, and an collection of Antimatter Containment

Engineering Department

Bottles. Arrangement differs from type to type. Generally, the Reactor is mounted within the ship's Secondary Hull (if it has such). Inflow rate of antimatter from the Bottles is controlled by the Engineering Computer, which adjusts same to match speed required. The inner surfaces of the Reactor are insulated with a protective force-field to protect them from contact with the antimatter. Within the Reactor, pre-heated gaseous antimatter encounters microscopic pellets of subatomic matter fuel fed into the Reactor via the Neutronic Fuel Injection Sequence (which uses a tiny Transporter to remove the pellets of neutronium from their storage facility, disassociate the neutronium into protons and electrons, and place them within the Reactor). Upon encountering each other, the matter and antimatter dissolve into a turbulent plasma. This plasma - just starting to annihilate itself into energy - is then fed into the Linear Intermix Shaft.

Matter Fuel Storage: For space efficiency, matter fuel is stored within the Reactor as neutronium, and kept from contact with the fuel storage tank walls via force-fields. Separate Gravatronic-insulating fields serve to protect the Reactor and ship from the savage tidal effects caused by the 1000 tonnes of neutronium.

Radiation Hazard: While operating, the Reactor creates tremendous levels of radiation, most of which is safely channeled by the force-fields to the intended destinations. However, there are always stray energy and particle radiations, which form a background field filling the Engineering spaces. The intensity varies from barely detectable (when the Reactor is throttled-down to a maintenance-level just active enough to power the ship's internal grid), to lethal (when the Reactor is throttled-up to full power-level to provide energy to the Warp Drive). Because of the hazard this radiation poses to all organic life-forms, all personnel on-duty within the Engineering spaces must wear Radiation Suits for the duration of each watch, to protect them from the accumulative effects. When the Reactor is throttled-down, visitors merely passing through the Engineering spaces need not don Radiation Suits as long as the duration of their stay does not exceed ten minutes. However, suits must be donned if their stay will exceed this length of time, or if Reactor is at a high-output level.

Normally, the force-field screen built-into the Suit's collar will protect the wearer's head. Helmets are stored in the Engineering spaces for use during maximum Reactor output.

-Linear Intermix Shaft

The Linear Intermix Shaft is a vast hollow tube of synthetic diamond, leading from the Reactor. It is composed of multiple segments, interrupted by generator housing rings at regular intervals - which produce the protective insulating force-field. It is within the Linear Intermix Shaft that the super-heated matter/antimatter plasma from the Reactor

finally annihilate each other to result in a flux of pure, raw energy. This energy is "tuned" to the qualities desired, and then fed into the Energy Conduits and Energizers.

Intermix Formula: The rate and course of the annihilation process is strictly controlled by fluctuating internal-mix-adjustment force-fields according to a complex intermix formula. This formula is arrived at by calculations taking into account the Warp Dynamics of that starship, and is applied to such variables as desired speed and space/time matrix (the structure of space ahead of the ship as picked-up by the Space/Energy Sensors on the vessel's hull). This formula differs for every ship in the fleet - even among a type (such as Ascension Class Dreadnoughts) no two Dreadnoughts share precisely the same formula.

-Energy Conduits

Narrower versions of the Intermix Shaft, intended to guide massive amounts of pure energy from the Intermix Tube to any location requiring a massive energy supply. Standard Energy Conduits feed the Impulse Drive, the Megaphasers (if mounted) and the Warp Drive Nacelle(s). Even smaller versions called Energy Micro-conduits feed such systems as Phasers.

-Auxiliary Fusion Reactor

Built-into the Impulse Drive is a secondary powerplant, which is normally completely shut-down. The Auxiliary Reactor utilizes a phaser-heating system firing into a containment area to induce the fusion of deuterium/tritium mix into hydrogen- for an immensely efficient and high-energy reaction. Fuel is drawn from the Impulse Fuel Tank. In the event of Main Reactor failure, this fusion Reactor can supply most internal power requirements, and can also power the Impulse Drive. It is incapable of powering the Warp Drive Nacelles. (See: IMPULSE DRIVE SYSTEM).

Battlecruiser: As an experiment, the *S'Harien*-Class Battlecruiser was designed with five of these fusion reactors. Thus, in the event of Main Reactor failure, all systems except Warp Drive could be fully powered-up and operated simultaneously - exponentially increasing the vessel's survivability in the event of severe battle damage. Starfleet is considering incorporating this feature into upcoming designs. It is unlikely however that multiple fusion reactors will be retrofitted into existing craft. Each reactor (an parallel service equipment and fuel storage) takes up an enormous volume within the ship, and few vessel classes except the Battlecruiser can afford the space penalty.

-KR13-N Secondary Hull Main Reactor System

The KR13-N is intended to be installed within the Secondary Hull of larger starships, with the outer ends of the Bottles flush against the curve of the hull's underside. The Linear Intermix Tube rises to Main Engineering, where it branches into two Energy Conduits - one extending aft to feed the Warp Drive Nacelles, the other rising to feed the Impulse Drive.

Types Utilizing KR13-N:

- Heavy Cruiser
- Dreadnought
- Cruiser
- Light Cruiser
- Command Cruiser

Particulars:

- A) Antimatter Containment Bottles (24)
- B) Reactor Chamber
- C) Intermix Shaft
- D) Energy Conduit to Impulse Drive
- E) Energy Conduit to Warp Drive

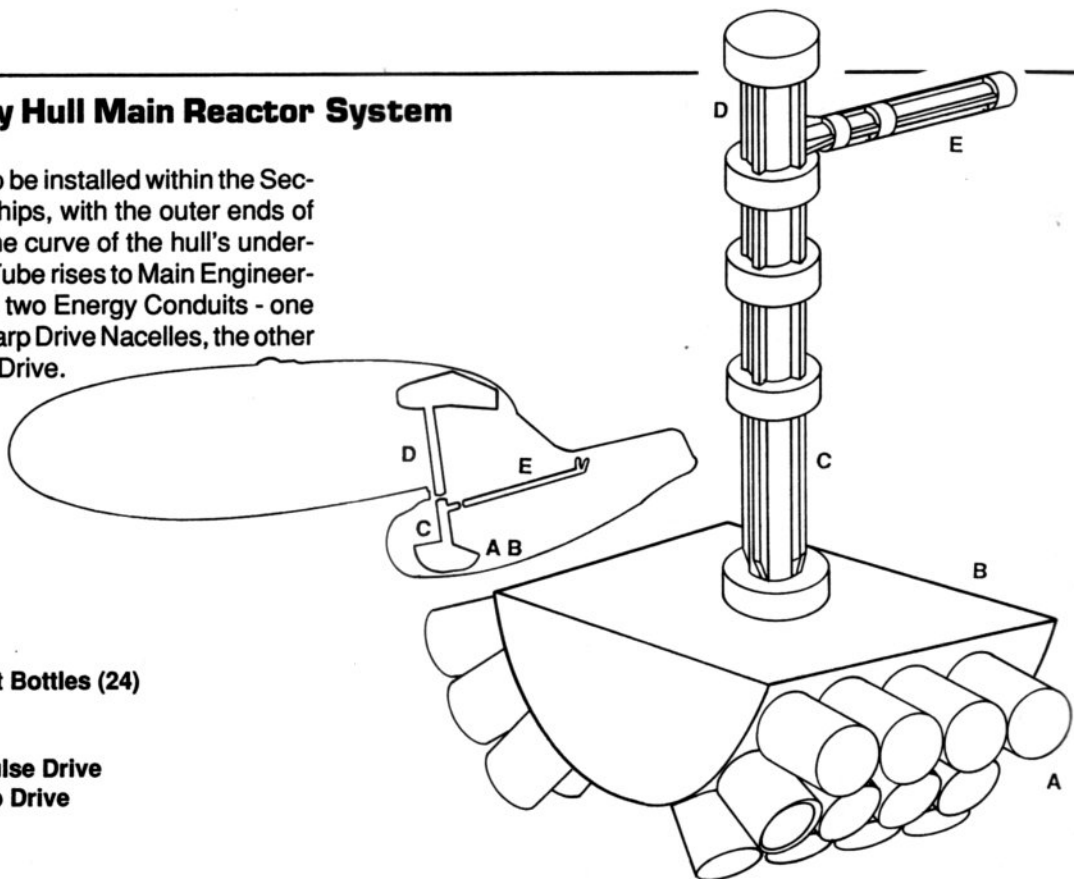

-KR13-M Extended Hull Main Reactor System

The KR13-M is mounted forward and below the Impulse Drive of medium-sized starships, with the outer ends of the Bottles flush with the flat hull's underside. A short Linear Intermix Shaft rises to Main Engineering, where it connects with the Primary Energy Shaft leading aft, which branches off to feed the Warp Drive Nacelles, the Impulse Drive, and in some models the Megaphasers.

Types Utilizing KR13-M:

- Heavy Frigate
- Frigate
- Fast Frigate
- Medical Frigate
- Twin Through-Deck Carrier

Particulars:

- A) Antimatter Containment Bottles (16)
- B) Reactor Chamber
- C) Intermix Shaft
- D) Primary Energy Conduit
- E) Energy Conduit to Warp Drive
- F) Energy Conduit to Impulse Drive

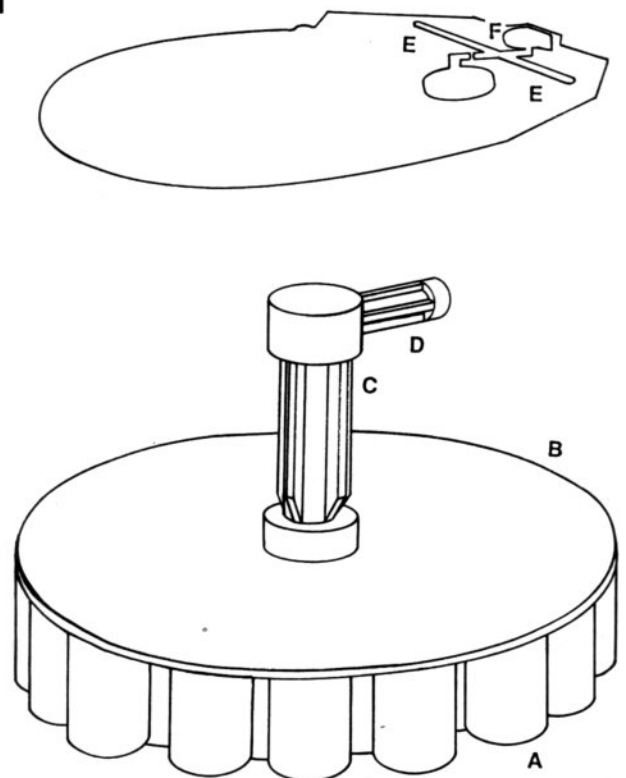

-KR13-L Dorsal Pylon Main Reactor System

The K13-L is mounted in the Dorsal Pylon of smaller starships, with the outer ends of the Bottles flush with the Pylon's aft hull. A short Linear Intermix Shaft leads forward to Main Engineering, where it branches into two Energy Conduits - one dropping to feed the Warp Drive Nacelle, the other rising to feed the Impulse Drive, and in some cases the Megaphasers.

Types Utilizing KR13-L:

- Scout
- Destroyer
- Heavy Destroyer
- Fast Destroyer
- Heavy Destroyer*

Particulars:

- A) Antimatter Containment Bottles (8)
- B) Reactor Chamber
- C) Intermix Shaft
- D) Energy Conduit to Impulse Drive
- E) Energy Conduit to Warp Drive

* In conjunction with KR05-P

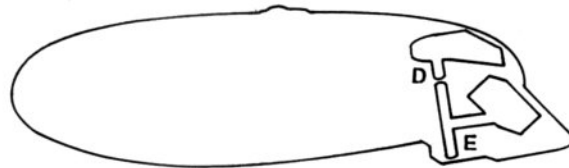
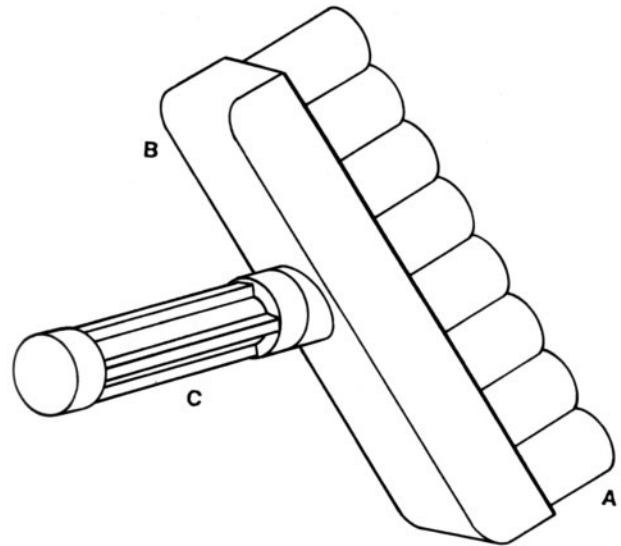

-KR13-O Flattened-Secondary Hull Main Reactor System

Mounted in the Secondary Hull of medium-large starships, with the outer ends of the Bottles flush with the flat hull's flat topside. The Linear Intermix Shaft extends forward into Main Engineering, where it connects with the Primary Energy Conduit leading forward, which branches off to feed the Warp Drive Nacelles, the Impulse Drive, and in some cases the Megaphasers.

Types Utilizing KR13-O:

- Battle Cruiser

Particulars:

- A) Antimatter Containment Bottles (24)
- B) Reactor Chamber
- C) Intermix Shaft
- D) Primary Energy Conduit
- E) Energy Conduit to Warp Drive
- F) Energy Conduit to Impulse Drive

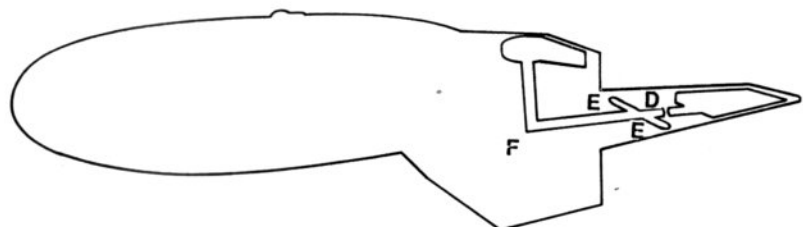
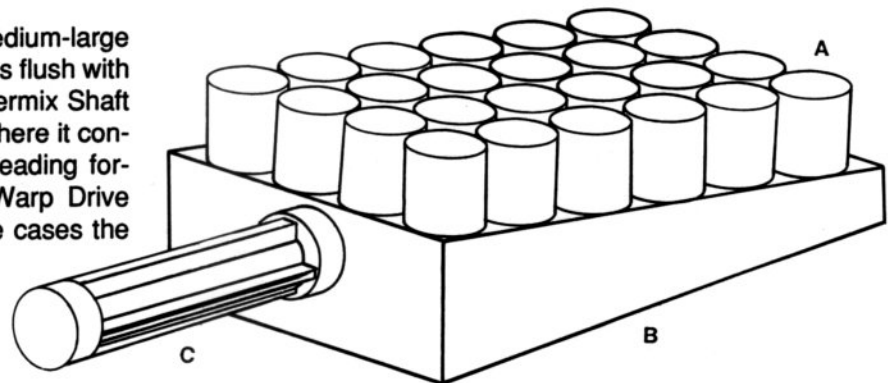

Starfleet DYNAMICS

-KR05-P Spacecraft Main Reactor System

Mounted in the Primary Hull of spaceships, with the outer ends of the Bottles flush with the hull's topside. The Linear Intermix Shaft leads aft to Main Engineering, where it connects with the Primary Energy Conduit leading aft, which branches off to feed the Warp Drive Nacelles and Impulse Drive.

Types Utilizing KR05-P:

- Survey Vessel
- Corvette
- Diplomatic Cruiser

Particulars:

- A) Antimatter Containment Bottles (3)
- B) Reactor Chamber
- C) Intermix Shaft
- D) Primary Energy Conduit
- E) Energy Conduit to Warp Drive
- F) Energy Conduit to Impulse Drive

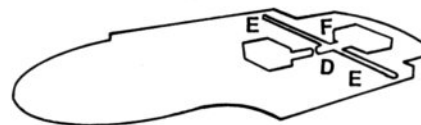
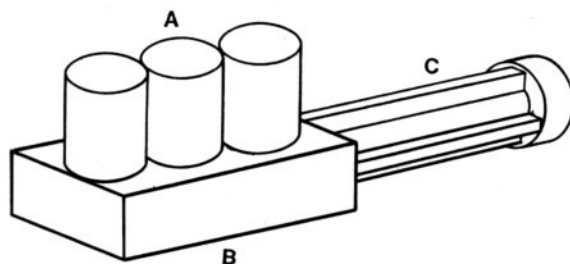

Electrical Power Generation

-Transtating Theory

Dilithium crystals possess the unique quality to transtate - or change one form of energy into another. Smaller examples of transtators exist within the Transporter (which utilizes them to alter matter into energy patterns for beaming) and the Communicator (which utilizes them to alter electrical signals from the microphone into electromagnetic energy). In the case of the Main Energizer, an array of large dilithium crystals are exposed to the energy bled-off from the Intermix Shaft. The crystals transtate this energy into electrical power - and feed it into the ship's internal power grids (networks).

-Main Energizer

The power converted by the Main Energizer (Mains) is essential to the operation of the vessel, as it powers such systems as life-support and the maneuvering thrusters. As well, it energizes the Neutronic Fuel Injection Sequence and the various generators producing the insulating force-fields for the Bottles, Reactor, Intermix Shaft, and Energy Conduits. Both systems are an enormous drain, and the Main Energizer's power is required for their continuous operation. The Emergency Batteries are capable of powering the force-field generators insulating the Bottles indefinitely, but can only insulate the other parts of the system and power the Neutronic Fuel Injection Sequence for a few minutes until the Main Energizer can take over. Due to the

drain on Battery Power that such a Cold-Start entails, the Main Reactor is seldom completely shut-down, but rather is simply reduced to a maintenance-level power-output. However, the Reactor must be shut-down occasionally, since the Main Energizer does require maintenance, and the the Radiation Chamber enclosing the Main Energizer (located in Main Engineering) cannot be entered even by Suited personnel unless the Main Reactor is completely shut-down due to intense radiation leakage.

-Secondary Energizer

A Secondary Energizer is located in Secondary Engineering, just below and forward of the Auxiliary Reactor. The function of the Secondary Energizer is to draw energy bled-off from the Auxiliary Fusion Reactor in the event of Main Reactor Failure, and feed same into the ship's internal power grids.

-Dilithium Structure & Recrystallization

As stated in MAIN ENERGIZER, dilithium crystals are the very heart of a vessel's power system - channeling, focussing, and transtating the raw generated energy into useful forms.

Theoretically, the dilithium crystals within a vessel's energizer should last forever, and in actual fact some commercial ships are still using the crystals installed when they were first launched. The hard reality however is that military ships - most notably starships - have a tendency to wear out their crystals at a frequent rate. While commercial vessels can husband their expensive crystals by the careful

Engineering Department

and conservative usage of power, starships are frequently required to expend energy prodigiously on such purposes as Maximum Emergency Warp Speed, Full Force-field Protection, Evasive Maneuvers, Continued Phaser Strikes, etc. This prolonged abuse of the energizer has the effect of decrystallizing the dilithium, which begins to show flaws in its structure as the complex, perfect crystalline matrix fractures. Finally the crystal is irretrievably flawed to the point of uselessness, and must be discarded.

Recently, a research team headed by Captains Spock and Scott began investigating the possibility of refining a system of regenerating dilithium. This was to be based upon an emergency last-ditch scheme they had tried on 20th Century Terra, in an event to repair crystals depleted

by Time Travel. With the alternative being the complete destruction of Terra's biosphere, they had risked Captain Spock's idea of collecting high-energy photons from a plutonium fission reaction, and then bombarding their depleted crystals with same, oscillating the radiation so as to attempt to fine-tune it to the crystal's original structure. The result was complete regeneration of the crystals - flawless and better than their original state.

The Federation Research Team is presently seeking a method of refining this crude effort into a fool-proof, safe, and standardized procedure. When completed, the resulting apparatus will be installed as an auxiliary system in all Starfleet vessels.

Propulsion Systems

Warp Drive System

-Warp Drive Theory

Federation starships utilize a faster-than-light propulsion system invented in 2051 by Dr. Zephram Cochrane at the Alpha Centauri Scientific Institute. This system has be-

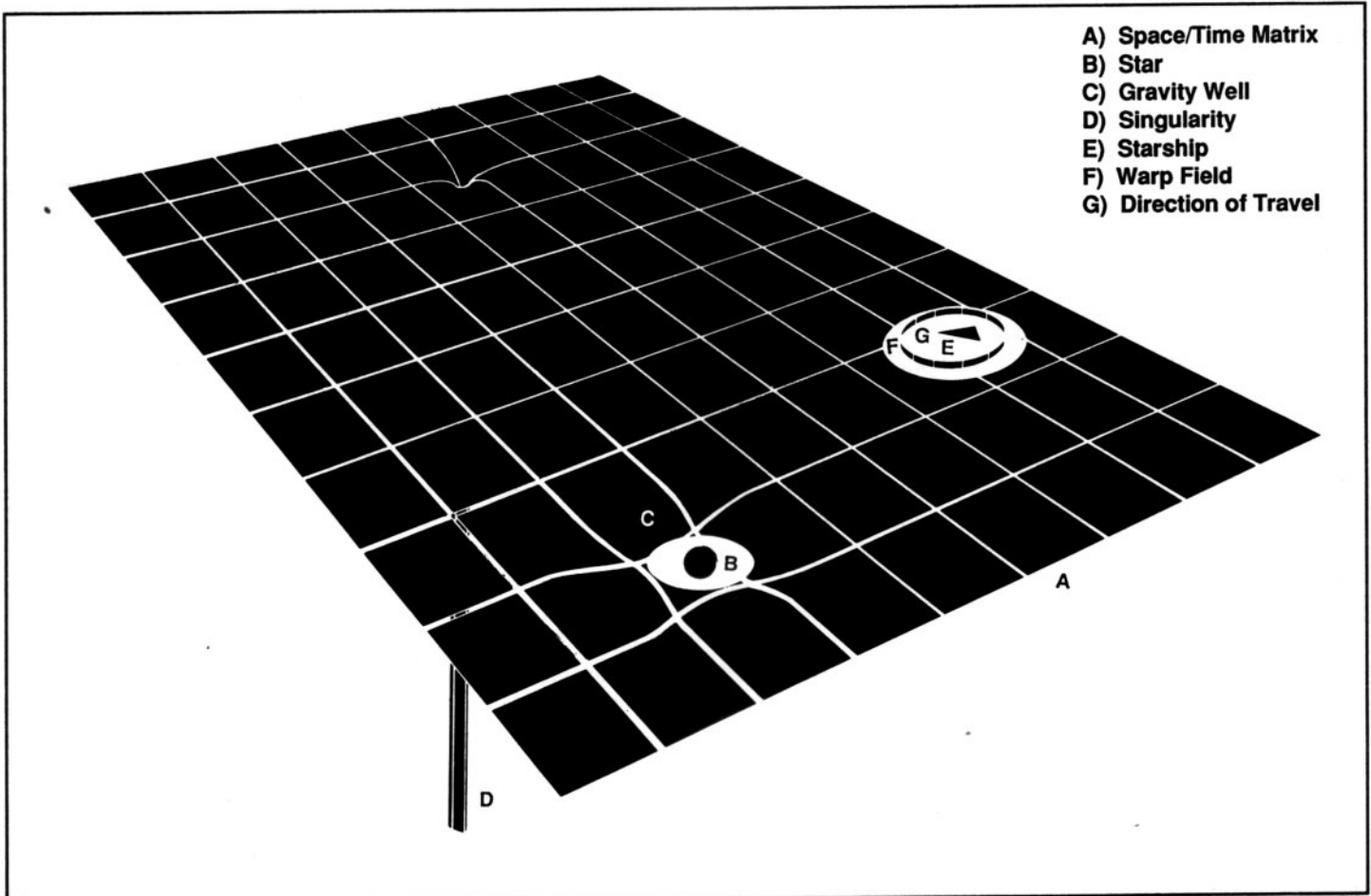

Starfleet DYNAMICS

come known as the Warp Drive.

The accompanying illustration shows the distortions which an both an object's mass and a Warp Drive can induce upon the normally flat fabric of space - known as the space/time matrix, and displayed in two dimensions for convenience. The matrix is fairly flexible. As can be seen, a mass causes a "dimple" or gravity well in the fabric surrounding it. The more massive/dense the object the deeper the gravity well, until the upper limit is reached when a hypermass such as a black hole exceeds the "tensile strength" or stability factor of the matrix, and rips through into another universe - causing a singularity. If an object attempts to exceed lightspeed, it also destroys the stability factor, and vanishes down a wormhole - a self-created singularity.

A Warp Drive functions by surrounding itself with a self-generated "bubble" of hyperspace. This "bubble" - known as the warp field - grasps at the very fabric of space itself - the space/time matrix - and manipulates that matrix. Because of the asymmetrical nature of the warp field, the distorted matrix precipitates motion on the field, which carries the ship along inside it. Since the vessel is not actually within the normal universe, but is insulated by its warp field, faster-than-light speeds can be achieved without violating Einstein's Law of Relativity and exceeding the stability factor.

The matrix does not resist the motion of objects with slower-than-light velocities - it acts as a frictionless surface to them, allowing them to "coast" along forever. However, it does resist objects traveling at the faster-than-light velocities. Once a vessel has achieved supra-light speeds, it must keep its drive system active. Should the power to the drive system be deactivated, matrix "friction" will slow it down and dump it back into real-space within seconds.

-Starship Warp Dynamics

Warp Dynamics refers to the relationship between a faster-than-light spacecraft and its effect upon the space/time matrix. It also refers to that discipline of Engineering which studies said relationship. A vessel which offers low resistance to the matrix is said to be warp dynamic.

Warp Dynamics is a critical consideration in the design of any starship. As stated before, there is a tendency in the space/time matrix to resist the faster-than-light motion of any object. Engineers have tried to minimize this resistance by designing starships so that they will achieve a maximum velocity in hyperspace for a given energy expenditure. This process vaguely reflects the ancient concept of "streamlining" ocean-going vessel's hulls so as to minimize drag from the water, but goes several factors beyond. The actual external shape of a starship is only the beginning of a design. Also important to its warp dynamics are such factors as mass placements, structural density patterns, and specific torque vectors. These will govern such fea-

tures as the placement of the Warp Drive Nacelles in relation to a starship's center-of-gravity, and the internal location of the Main Reactor (by far the heaviest single item onboard).

Class 1-B Starship Design: Insofar as Federation engineering is concerned, the optimum warp dynamic shape is a flattened disc, with one or more outboard nacelles. This can be said to have the effect of slicing through the matrix cleanly and smoothly - much like the wings of a glider through an atmosphere. This design philosophy is seen in most starship design Types, with the few differences being quantity and relative placement of nacelles, and the possible addition of Secondary Hulls to the standardized Primary Hull. Starships are the most warp dynamic of all Starfleet vessels, having the edge on acceleration, maneuverability, and maximum velocity. The *Enterprise* Class Heavy Cruiser is superior in this respect, followed closely by the *Belknap* Class Cruiser, *Ascension* Class Dreadnought, and *S'Harien* Class Battlecruiser. The extra Warp Drive Nacelle on the Dreadnought does not appreciably alter its warp dynamics from those of the Cruiser, but it does give a higher velocity range limit.

Other Vessel Designs: Civilian and other military powers have tended to use different warp dynamicism philosophies in designing their vessels. In civilian craft this is of little consequence, as most can only achieve moderate speeds anyway. Klingon/Romulan designs feature dagger-like hulls, which pierce rather than slice through the matrix - increasing maneuverability while sacrificing speed. Gorn and First Federation vessels feature brick-like masses, which shove their way through the matrix with all the elegance and smoothness of a Syrian Lump through the forest.

-Warp Drive Power Efficiency

Warp Factors: Using a Warp Drive, energy requirements rise geometrically while at the same time speed rises exponentially, as can be explained by the following example: If a starship uses X amount of energy per second to travel at 1C (lightspeed), then it will require 2X per second to travel at 8C (Warp Factor 2), 3X to travel at 27C (Warp Factor 3), etc. Thus the Warp Factor Number designates the energy usage in multiples of X for any starship. This unit X differs for different Types of starships, and is referred-to as the Power Consumption Indice. The Power Consumption Indice is measured in multiples of tenths of petajoules/sec (100,000,000,000,000 joules per second).

Power and Fuel Consumption: While not the fastest, the *Enterprise* Class Heavy Cruiser is the most warp dynamic starship Type. The Mark 9-B uses 2 grams of antimatter plus 2 grams of neutronium matter per second (generating 0.1003 petajoules/sec) to maintain a speed of wf 1. Thus her Indice is 1.003. At her Maximum Emergency Speed of wf 12, the Main Reactor annihilates 24 grams of antimatter

Engineering Department

and 24 grams of matter per second (generating 2.4 petajoules/sec) - 12 times the power consumption for 1728 times the speed. Cruising, Flank and Emergency Maximum **Speeds**: Theoretically, since higher velocities are obviously more energy efficient, a starship would be always be expected to travel at its Main Reactor's peak output. Practically, all starships have a Cruising Speed which denotes the maximum safe output of the Main Reactor - coupled with no stress damage to the ship's hull - over a prolonged duration. The Cruising Speed of a vessel is determined by its design Type, per warp dynamics. Also different for each Type is its Flank Speed which denotes the maximum velocity which can be kept up for an extended period of time (hours) while causing only minor structural damage to the ship. Finally the Emergency Speed denotes emergency-full output of the Main Reactor, and can only be maintained for a few hours before faults and buckling in the ship's structure and Reactor become critical.

-Starship Power Consumption Indice Co-efficient

The accompanying diagram is an example of an Energy Consumption Indice Coefficient Chart. The angle of Power Coefficient corresponds to the ratio of energy expended:velocity achieved. The better a starship's warp dynamics (and thus the more efficient its propulsion system) the steeper the Power Coefficient Slope. Three velocity ranges are included within the Power Coefficient Slope, with the ceiling speed for each stated.

The following Charts are specific for Starship Type only: not the individual Starship. Within a Type, there will be unique, minor differences between Starships.

- M/T - Type and Name**
- PCI - Power Consumption Indice**
- ESP - Emergency-Maximum Speed**
- FSP - Flank Speed**
- CSP - Cruising Speed**
- PCS - Power Coefficient Slope**

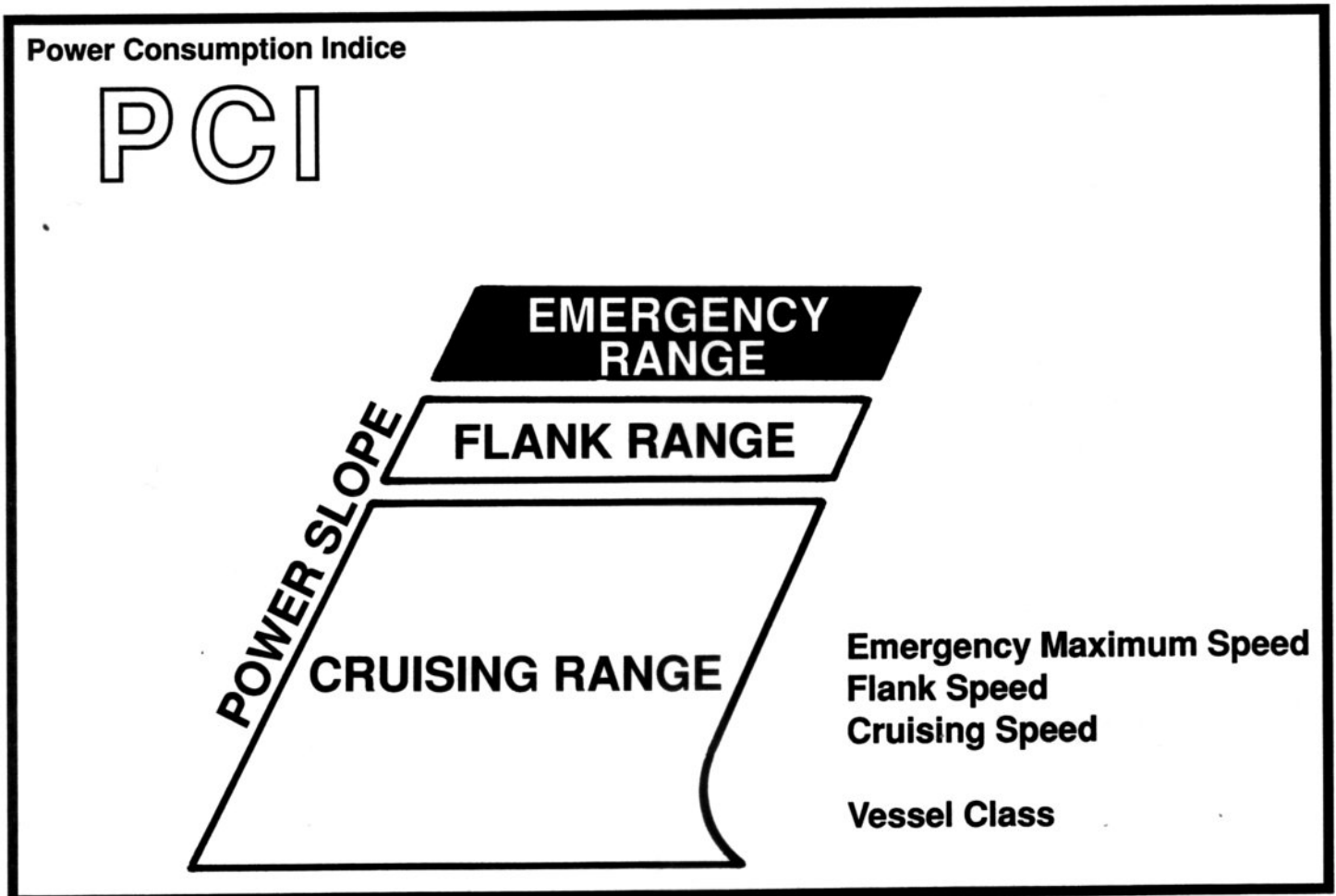

Starfleet DYNAMICS

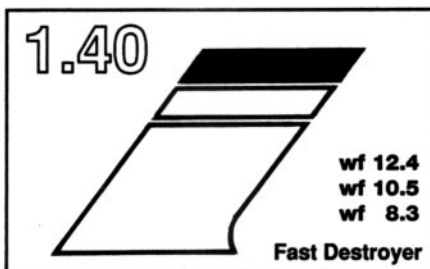
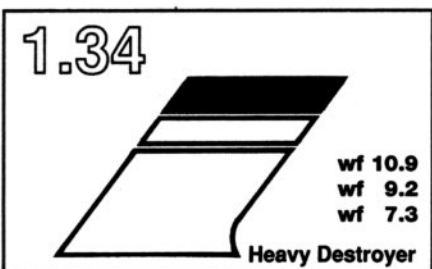
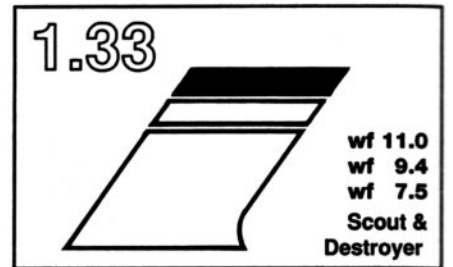
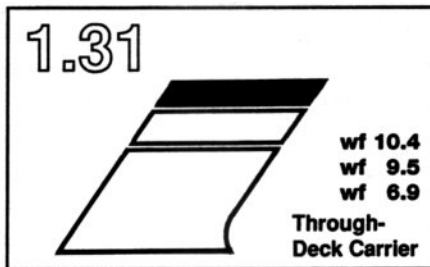
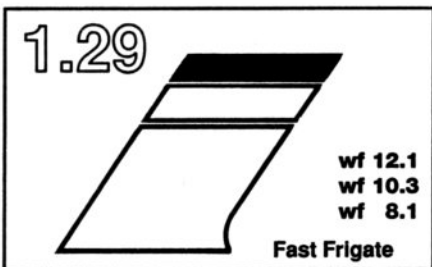
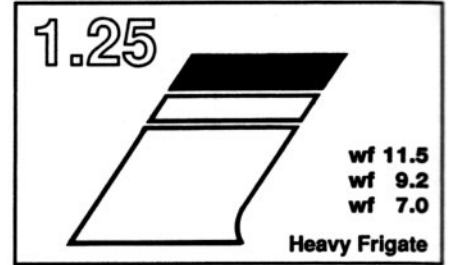
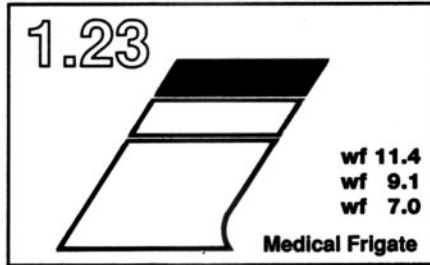
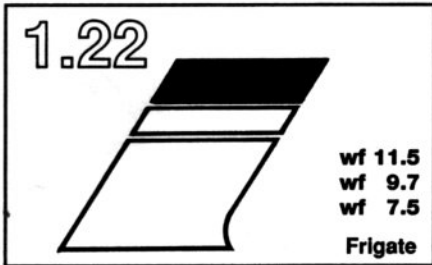
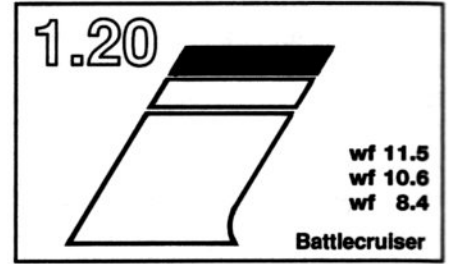
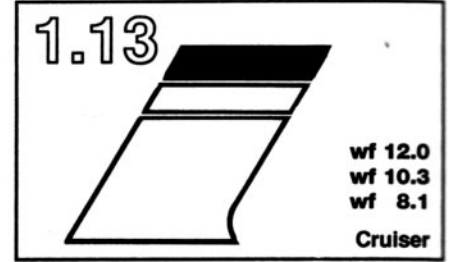
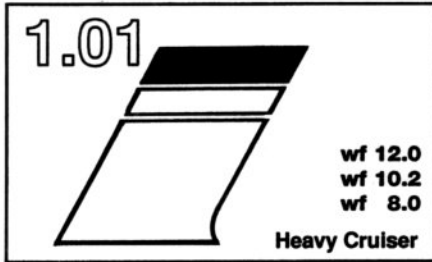

Warp Drive Nacelle

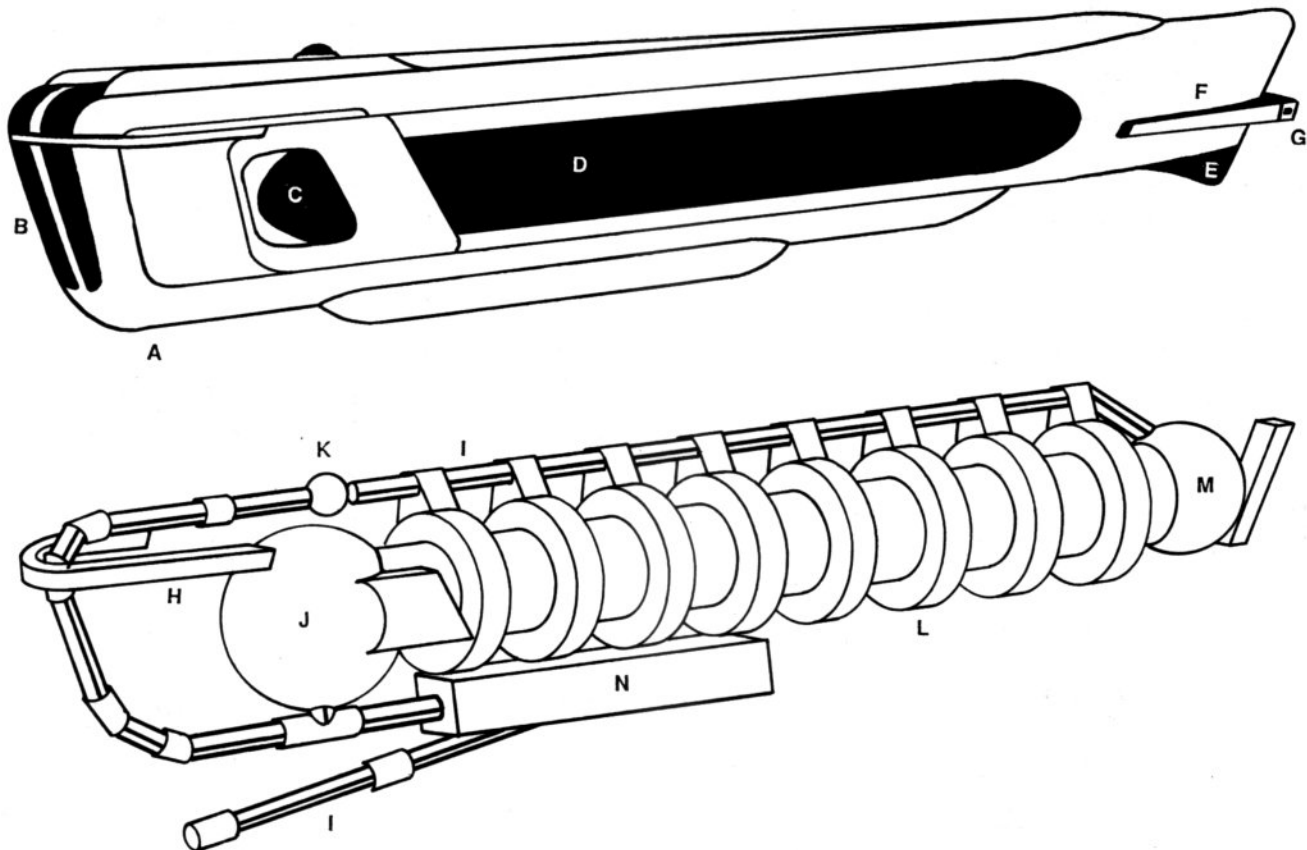

Particulars:

Length 154.8 meters
 Width 12.8 meters
 Height 18.6 meters
 Weight 25000 metric tonnes

A) Tritanium Shell
 B) Defensive Shutters
 C) Primary-Stage Magnatonic Flux Chiller
 D) Power-Stage Magnatonic Flux Chiller

E) Final-Stage Magnatonic Flux Chiller
 F) Intercooler
 G) Maneuvering Thruster Package
 H) Inlet Flow Sensor
 I) Energy Conduit (from Main Reactor)
 J) Primary-Stage Magnatonic Flux Chamber
 K) Magnatonic Amplification Crystal
 L) Secondary-Stage Magnatonic Fluxation Toroids (8)
 M) Final-Stage Magnatonic Flux Chamber
 N) Control Reactor

-Specifications

Operation is based on Field Space/Energy Matrix Warp Postulate (Advanced Fourth Generation). This system is reversible with moderate power capability and minimum Space/Energy degradation. Support/power pylon may be attached at various positions. Control Reactor will always be between pylon and nacelle proper. The SW45/1-5 nacelle is standard for all Class 1-B starships.

-Function

The Warp Drive Nacelle functions by using powerful gravitronic fields to so stress the space/time matrix of space as to create a hyperspace "bubble" warp field which propels the vessel through space.

Starfleet DYNAMICS

-Main Components

Primary-Stage Magnatomic Fluxation Chamber:

Stresses the matrix in a spherical locus around the ship (along the X, Y, and Z axis) using powerful gravitronic force-fields, thus creating the warp field. Regardless of speed is desired, the amount of power used by this stage remains constant.

Secondary-Stage Magnatomic Fluxation Toroids: Over-stresses the warp field to give an asymmetrical shape to the original perfect spherical locus. Greater power input at this stage yields greater asymmetry, and thus greater speed. Turning the vessel in mid-flight is achieved by temporarily rotating the warp field about the craft in the direction of desired.

Final-Stage Magnatomic Fluxation Chamber: Restores the stressed and over-stressed matrix, thus forming the rear "hemisphere" of the original spherical locus. Power draw is constant.

Inlet Flow Sensor: Analyses the structure and texture of the theoretically "flat" matrix ahead of the vessel, and passes this data on to the Control Reactor.

Control Reactor: Modulates the energy from the Main Reactor according to telemetry from the Inlet Flow and Space/Energy Sensors. Channels appropriate power to the Fluxation Chambers and Toroids.

Magnatomic Amplification Crystal: Aids the Secondary-Stage Fluxation Toroids in achieving the temporary rotation necessary for mid-flight turns.

Magnatomic Flux Chillers: Enormous heat-sinks which radiate excess parasitic heat from the nacelle into space, keeping the nacelle at an optimum operating temperature range of between 5000 to 8000 degrees.

Intercoolers: Low-powered heat-sinks which cool the Flux Chillers.

Impulse Drive System

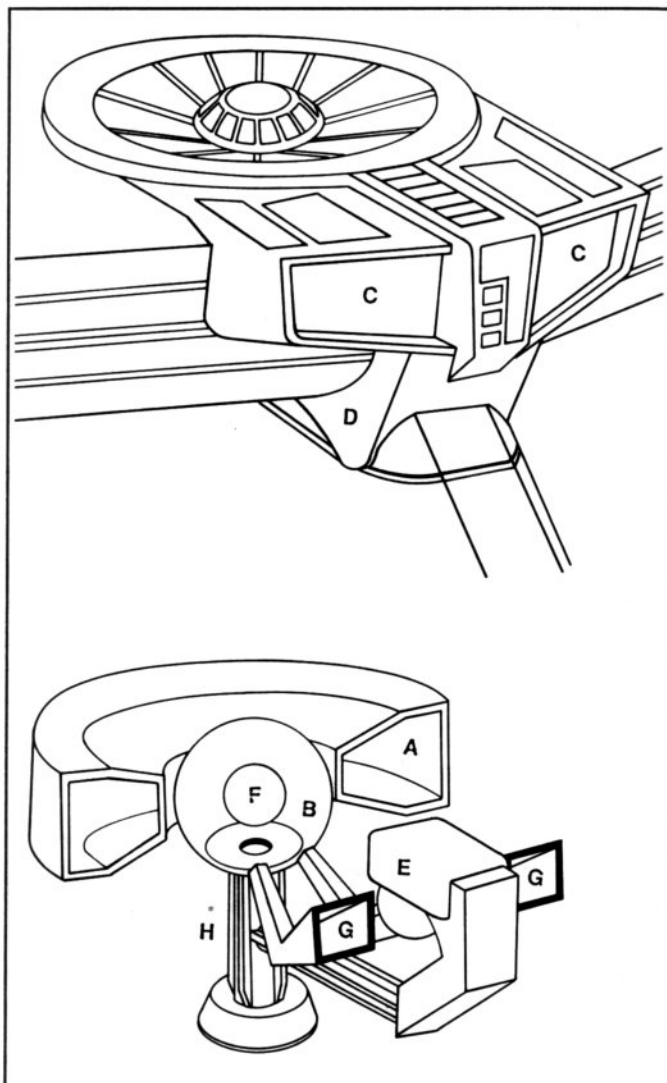
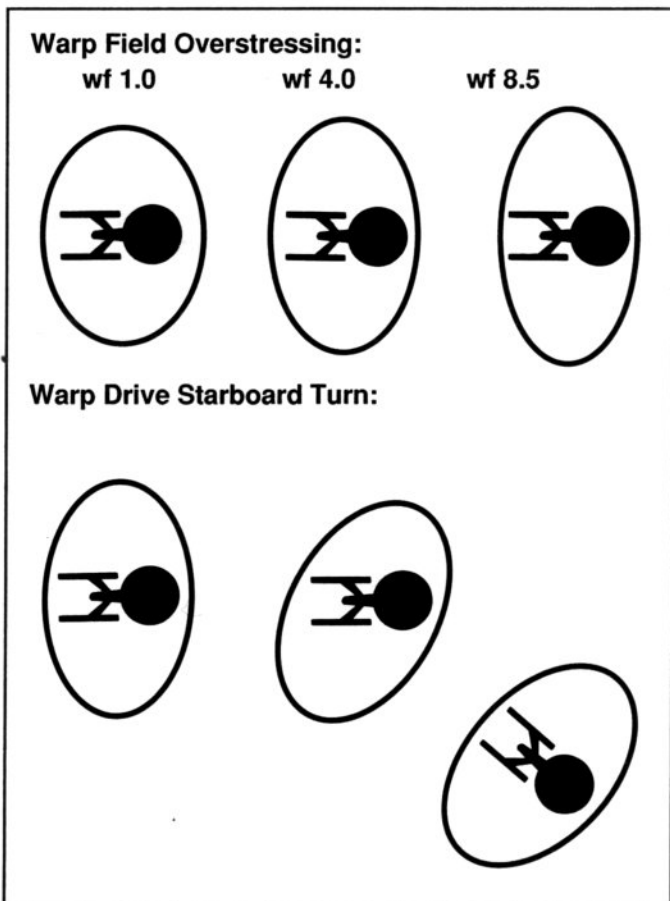

-Secondary Components

The Secondary Components are sub-systems designed to augment and support the Main Components:

Particulars:

Thrust 15 Gravities

- A) Deuterium/Tritium Mix Fuel Tank Toroid
- B) Reaction Chamber
- C) Thrust Chamber
- D) Impulse Intercooler
- E) Auxiliary Fusion Reactor
- F) Impulse Deflector Crystal
- G) Thrust Guides
- H) Energy Conduit

-Specifications

Operation is based upon the principle of action/reaction (thrust). This system is reversible by using thrust-deflectors. Unit is always mounted at the upper-rear of a Primary Hull. The only variations in design are modification of the Thrust Guides and Thrust Chambers to better suit some craft. The FC90 Impulse Drive is standard for all Class 1-B starships.

-Normal Operation

Under normal operation, the FC90 uses the Main Matter/Antimatter Reactor as a power source. Energy is fed up through the Impulse Drive-Feed Energy Conduit to the Deflection Crystal. Under this bombardment, the crystal heats-up until the interior of the Reaction Chamber is at an operational temperature of 5000 degrees. After operational temperature is achieved, the Fuel Injection Nozzles feed deuterium/tritium plasma from the Impulse Fuel Toroid into the Reaction Chamber, where the plasma undergoes fusion. The expanding shockwaves of fusing hydrogen/helium plasma escape the Reaction Chamber via the Thrust Guides, and are vented into space through the Thrust Chamber as a high-speed rocket exhaust.

-Auxiliary Operation

In the case of Main Reactor failure, the Auxiliary Fusion Reactor can be utilized to heat the Impulse Deflection Crystal through a Secondary Energy Conduit feeding into the Impulse Drive-Feed Energy Conduit.

-Capability

The Impulse Drive System is a slower-than-light drive, and can be used to achieve a maximum of 0.78C.

Particle Beam Thrusters

-History

The history of the Thruster goes back to 1990's Terra, when the two nuclear superpowers placed orbital weapons into orbit as part of a Strategic Defense Initiative Program.

Each of these orbital weapons generated and fired a beam of negative hydrogen ions (hydrogen nuclei with an extra electron), intended to knock-out the guidance systems of nuclear missiles fired at the weapons' owners. Today's Thrusters are refined versions of these.

-Principle

Hydrogen fuel is fed into an Ionizing Chamber, where a bevatron bombards the hydrogen with alpha particles (high-speed electrons). The electrons attach to the hydrogen, making ions. These ions are then accelerated through a Radio-frequency Quintuple Accelerator, and fired through a Magnetic Straight-away, which aims them in the direction required. The result is a high-speed particle beam (-H at just below lightspeed), which emerges from an Emission Port as a "rocket exhaust".

-Propulsion Thrusters

Thrusters are used by every Federation vessel in one capacity or another. Small auxiliary craft utilize Thrusters as their primary propulsion system. As such it has an advantage over other forms of thrust-propulsion in that the exhaust is non-polluting. Even starships - which utilize Warp and Impulse Drives as their primary and secondary propulsion systems utilize Thrusters as a tertiary propulsion system for low-speed, close-in operations. These are usually mounted below the hull surface, with the Emission Ports showing as small niches facing fore and aft.

-Maneuvering Thrusters

In addition, every ship from Dreadnought to Bee uses smaller Thrusters deployed in clusters known as maneuvering Thruster Packages. A vessel may have up to twenty of these Packages located at widely scattered points on the hull. Each Package consists of two or three small Thrusters, aimed 90 degrees apart. These are computer-controlled, firing in five-second pulses in order to orient the vessel as desired by the Helmsman. Like the Phaser Banks, the hull plates surrounding Maneuvering Thruster Packages is marked with warning colors to prevent EVA personnel from approaching.

Transwarp Drive

The Transwarp Drive is an experimental propulsion system based upon harnessing the reduction of space/time matrix resistance experienced by a vessel trapped in a wormhole.

-Wormhole Distortion

Any faster-than-light spacecraft going into antimatter imbalance outside of a gravity well (in flat space) will precipitate a wormhole distortion. Instead of a smoothly-

Starfleet DYNAMICS

formed warp field "bubble" of hyperspace surrounding it, hyperspace will be distorted into a "tunnel" reaching out ahead of the vessel. The vessel will plummet out-of-control down this tunnel until the Warp Drive is shut-down, and the resistance of the matrix to FTL speeds slows the vessel to sub-light speeds - dumping it into real-space. This condition can be caused by an improperly calculated intermix formula and is very dangerous: a vessel caught in a wormhole is unable to maneuver and could easily be damaged by the turbulence within the wormhole.

-Speed Advantages

One attractive facet of this accidental condition is that the resistance of the matrix to FTL speeds is so markedly reduced that a spacecraft so entrapped gains exponentially increased velocities per unit of energy expended (see: WARP DRIVE - POWER EFFICIENCY). Thus, if the Power Indice of a starship is X , and a Starship's speed using normal Warp Drive is normally X -to the third power \times lightspeed ($X=C$, $2X=8C$, $3X=27C$, etc. - up to a theoretical limit of $15.2X=3511C$ [Warp Factor 15.2]), using a Transwarp Drive the speed acquired should be X -to the fifth power \times lightspeed ($X=C$, $2X=32C$, $3X=273C$, etc. - up to a theoretical limit of $10X=100000C$ [Transwarp Factor 10, beyond which reality may well cease to exist in a one-to-one relationship with time and space).

-Harnessing the Wormhole

Ever since the wormhole effect was discovered by the earliest FTL vessels, Federation scientists have hypothesized that it might well be possible to harness this condition as a practical and safe propulsion system - using a Warp Drive which was built to go into imbalance.

-Expected Yields

Once the drive system is perfected - expected in the near future - all present-day Warp Drives will be retro-fitted and modified to serve as Transwarp Drives. The reductions in travel time, and the impact this will have on exploration are enormous. At her present Cruising Speed of Warp Factor 6, an *Enterprise* Class Heavy Cruiser is capable of traversing one lightyear every 40.6 hours (1.7 standard days). At Transwarp Factor 6, with no extra power expenditure, it will traverse that same lightyear in 1.2 hours. Said retro-fitting will require only a few weeks in drydock, and will consist of the installation of a Transwarp computer, and the enhancement of various Navigational and Helm systems.

-The Great Experiment

The starship *Excelsior* - first of the Battleships - was designed and constructed as a test-bed for the as-yet unperfected Transwarp Drive. She has been specially constructed, every feature strengthened so as to be able to

withstand the predicted turbulence and stresses of the as-yet unperfected drive.

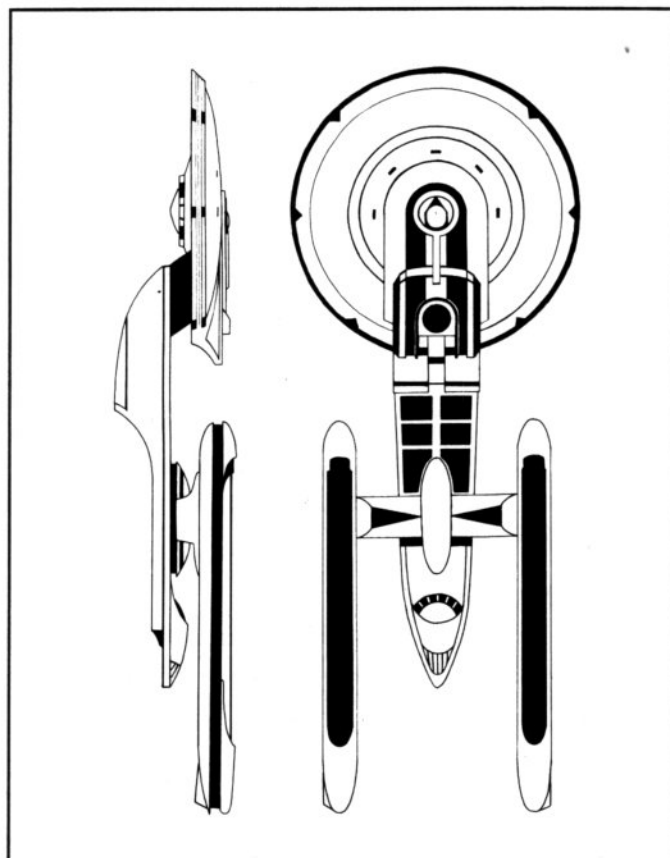

S-2 Graf Unit

Klingon and Romulan warships utilize an FTL drive system developed by the Klingon's circa 1800 (Terran dating) and known as the S-2 Graf Unit.

-Function

In function and theory, the S-2 Graf Unit is similar to the Federation Warp Drive. Both operate through the manipulation of the matrix via a surrounding warp field, which insulates the vessel from the surrounding real-space. However the Klingon design - while slower than its Federation counterpart per energy unit expended - is moderately more maneuverable, making it a worthy adversary. The adjoining illustration shows the degree to which Klingon engineers have traded-off power efficiency for maneuverability. In this illustration, both vessels' propulsion systems are consuming identical amounts of energy. For that same amount of energy, the Federation starship is measurably faster. However, the Klingon vessel can both out-turn and out-accelerate the Starship.

Engineering Department

- A) Warp Drive
- B) S-2 Graf Unit

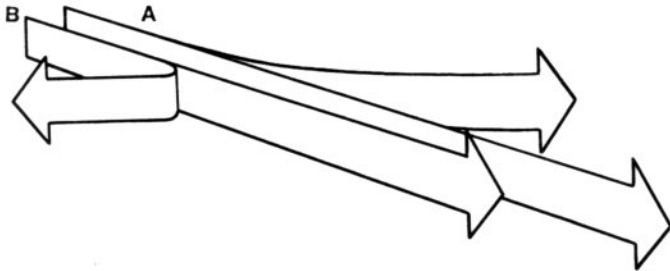

-Approach

A major departure from Federation engineering principles lies in the area of Klingon upgrading and improvement. The Federation Warp Drive has at present reached its fifth incarnation with the Advanced Fourth Generation design. This has meant five distinctly different designs over the centuries culminating in the Advanced Fourth, and yet a sixth (Transwarp) is waiting in the wings. The Klingon process of design evolution is far different. The S-2 Graf Unit is presently in its ninth incarnation - yet this ninth design is almost identical to the original. Rather than re-designing each new improvement, Klingon engineers have preferred to "add-on" new improvements as modules to already existing Units (such as replacing intercoolers one century, and adding better energy ducts the next - to the same Unit). As a result, some Klingon vessels (and their S-2 Graf Units!) are over three-hundred years old, with improvements having been added to their existing propulsion and power units throughout the centuries. This process of adding improvements by either adding or replacing some modules and sub-systems with others is known as "retro-fitting".

-Specifications

Operation is similar in function and design to Federation Advanced Fourth Generation Warp Drive. This system is highly maneuverable - more so than Federation starships - but both slower and less energy efficient. Support pylon may be attached along the upper or lower ridge, midway back. This retro-fitted version of the S-2 Graf Unit (KWE9024) Unit is standard for all Klingon and Romulan Class A Warships.

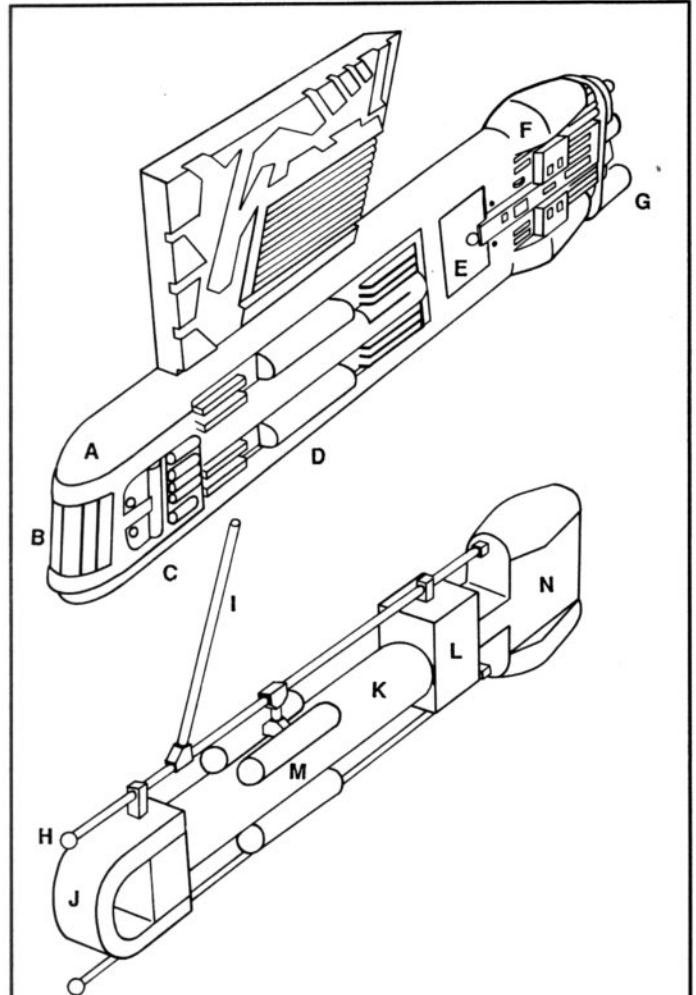

Particulars:

Length	74.7 meters
Width	6.8 meters
Height	17.4 meters
Weight	21500 metric tonnes
Capability (est)	0.998C to 1790C

External Internal

- A) K'rrlmth Shell
- B) Defensive Shutters
- C) First Flux Chiller
- D) Second Flux Chiller
- E) Final Flux Chiller
- F) Maneuvering Thrusters
- G) Stabilizing Auxiliaries
- H) Flow Sensors/Crystals
- I) Energy Ducts
- J) First Fluxation Chamber
- K) Second Flux Chamber
- L) Final Flux Chamber
- M) Control Reactors (4)
- N) Flux Focussing Core

Ship Construction

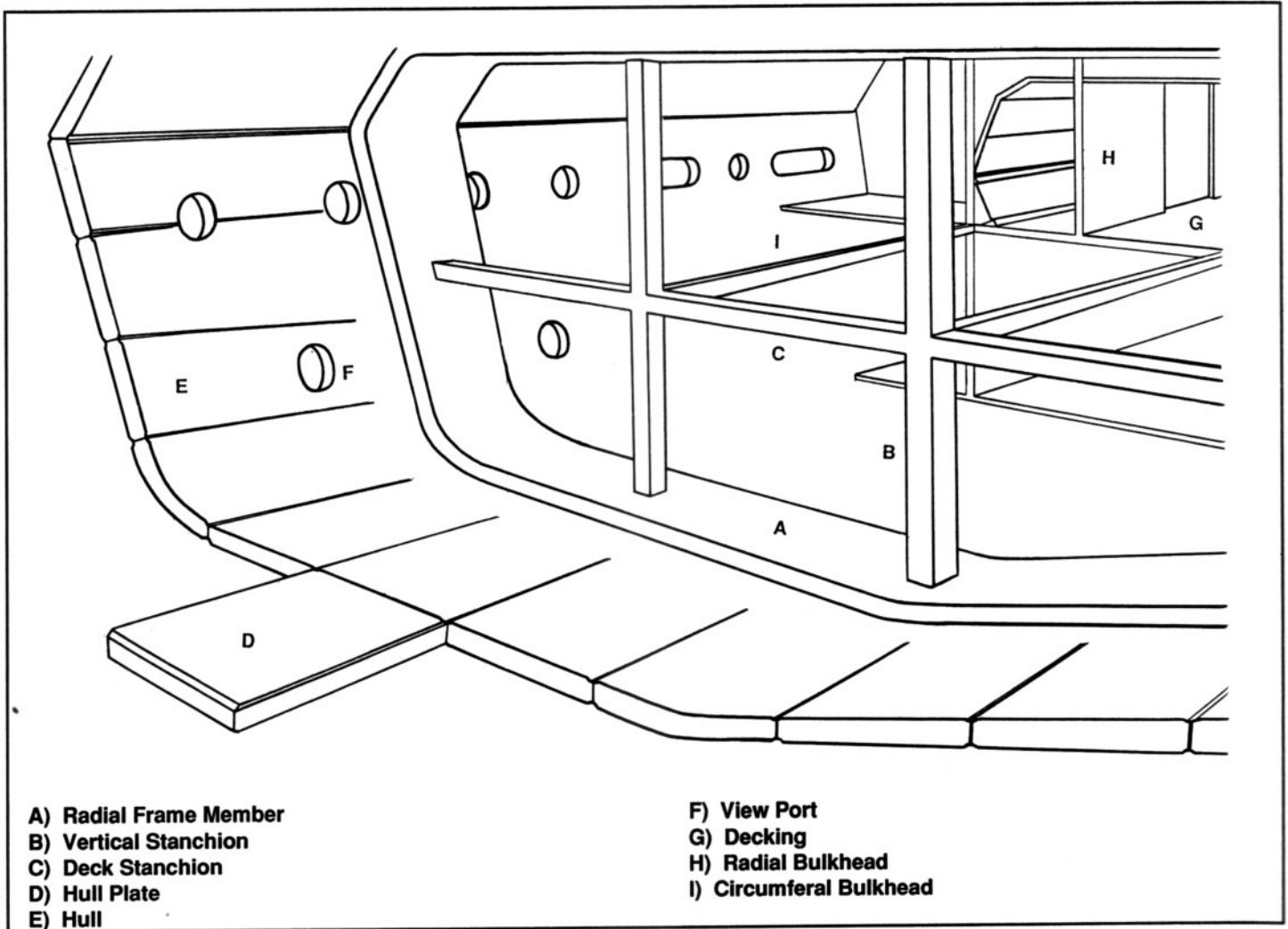

Hull Structure

The illustration above shows the basic structure of a segment of a Class 1-B Primary Hull, cut-away to show both a completed portion and the underlying structural members, and showing the relative positioning of all such structural members.

Hull: The supporting and surrounding portion of the ship, the armored outer envelope which contains the environment and protects it from external hazards.

Frames: The main structural members of the ship, which align, anchor, and strengthen the hull from within, support-

ing it much as the skeleton of a humanoid supports the muscles and skin.

Stanchions: The secondary structural members of the ship, which support and anchor all internal partitions and structures.

Decks: The internal horizontal partitions of a ship, analogous to its floors, and serve to divide it into a series of vertical levels.

Bulkheads: The internal vertical partitions of a ship, analogous to its inner walls, and which with the decks divide the volume of the ship into various compartments.

Compartments: The basic volume unit within a ship, analogous to its rooms; any volume enclosed between two decks and surrounding bulkheads.

-Frames and Frame Designation

A ship is a collection of interlocking parts. When a starship is constructed, the first operation is the alignment and anchoring of the frames. This is the most critical stage of construction, as misalignment or weakness here will have disastrous consequences later

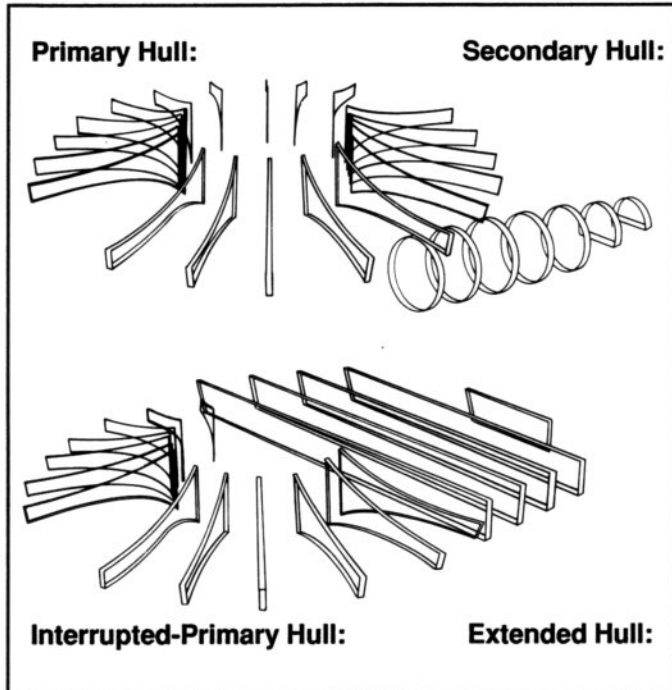

In overall configuration, starship frames come in three basic designs. Primary Hulls have their frames radiating from a common central axis. Secondary Hulls are aligned transversely as cross-sections extending aft. Extended Hulls interrupt and replace the rear of a Primary Hull, and again are aligned transversely as cross-sections extending aft. Each frame within a vessel is numbered. For Primary Hulls, the bow frame is Frame 1, the frame 18 degrees to starboard is Frame 2, and so on around to the frame 18 degrees to port of Frame 1, which is Frame 20. For Secondary Hulls, the foremost is Frame 21, increasing to sternward. For Extended Hulls, that frame connected to the last of the interrupted radial frames is Frame 8, increasing to sternward. The port radial frame connected to frame eight is Frame 15, and so on around to the frame 18 degrees to port of Frame 1, which is Frame 20. For a visual reference on Frame Numbering, see the following illustration.

-Superstructure

Although obviously counted as part of the ship, some modules are not mounted within the frame proper. These

are referred to as Superstructures. Examples include the Bridge/Command Module atop the Primary Hull, the Sensor Module, the Warp Drive Nacelles, and various support pylons. These superstructures contain their own frames.

-Hardpoints

Of necessity, ordnance is mounted to the most rigid hull positions. Phasers and Megaphasers are mounted on specially-reinforced hull plates, directly anchored to underlying frames. Such reinforced hull positions are called Hardpoints. They allow any thrust or damage caused by a weapon's operation or overload to be absorbed by the strongest part of the ship: the frames. Similarly, Photon Launch Tubes - although within the hull - are braced to the frames by an internal network of interconnecting, shock-absorbing thrust members. The Defense Field Grids, which create the Deflector Screens and Force-field Shields defending the ship, and which run along the hull surface, do so directly over the frames. This again allows the shock from absorbed enemy weaponry to be taken by the frames, and not be a non-reinforced hull plate.

Compartment Identification

-Deck Designation

As stated, the interior volume of a starship is divided by bulkheads and decks into compartments. These partitions are all reinforced, so that in the event of a hull breach venting a compartment, neighbouring compartments will not lose their integrity. Decks are designated alphabetically, from upper to lower. On a Class 1-B starship, The Bridge is A-Deck, that below it is B-Deck, and so on down to the lowermost deck. In the event of there being more than 26 decks, that following z-Deck is designated AA-Deck, followed by BB-Deck and so on.

-Compartment Designation

Each compartment within a ship has its own Compartment Designation Symbol (CDS). This symbol is marked on a label plate secured to the door(s), hatch, and/or bulkhead of the compartment. A CDS consists of four digits, representing Deck Letter, Closest Frame Number, Closest Stanchion Number, and Usage Code Letter. When a compartment extends through one or more decks (such as the Rec-Deck and Cargo Deck), the lower Deck Letter is used. The Frame Number refers to the frame nearest to the most forward bulkhead of the compartment. The Stanchion Number indicates how far the compartment is from the centerline or central axis of the hull - odd numbers for port-side and even numbers for starboard-side in a Secondary or Extended Hull. The following illustration shows the ascending digit direction for Deck Letter, Frame Number, and Stanchion Number within a Primary Hull,

Starfleet DYNAMICS

Secondary Hull, and Interrupted-Primary with Extended.

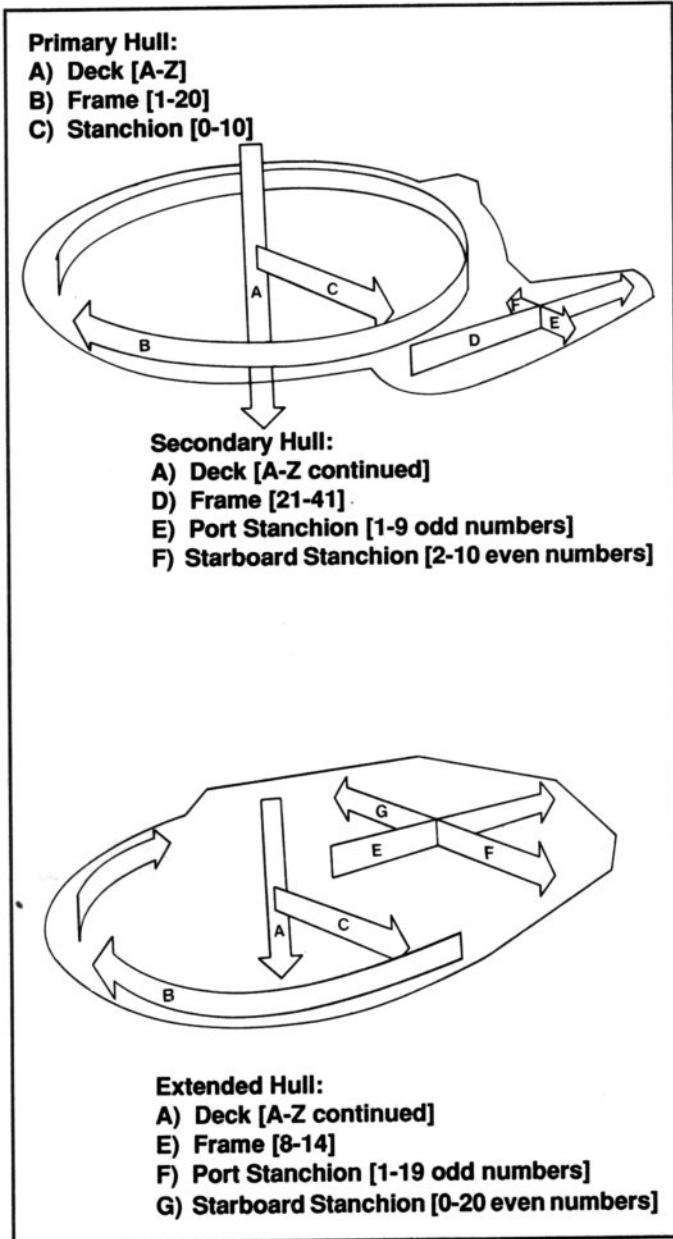

The following is an example of a CDS for a compartment within an Enterprise Class Heavy Cruiser - the Rec-Deck. The Usage Code designates the primary purpose of a compartment.

G-8-9-L

G: G-Deck
8: Frame 8 (Primary Hull, Starboard-aft)
9: 9th Compartment Ring from central axis
L: Living Compartment

Compartment Usage Code

USAGE CODE	TYPE	DESCRIPTION
A	Stowage	Lockers & Raw Materials Bins
B	Cargo	Holds & Container Spaces
C	Control	Bridge & Fire-Control
D	Computer	Computer & Electronics Spaces
E	Engin.	Engineering & Propulsion
F	Fuel	Antimatter Containment
G	Fuel/2	Impulse Fuel Tankage
H	Hangar	Parking & Landing Bays
I	Fuel/3	Auxiliary Craft Fuel Stores
K	Hazard	Phaser Banks & Torpedo Bays
L	Living	Quarters & Recreation
M	Medical	Sickbay Facilities
O	Science	Research Laboratories
P	Security	Armory, Offices & Brig
Q	Misc.	Fabricators & Jeffries Tubes
T	Access	Corridors & Turboshafes
W	Water	Tankage

Shipboard Systems

Tractor Beam

The Tractor Beam utilizes polarized gravitronic fields (collimated into a beam) to attract objects towards it. A Pressor Beam has the opposite effect of repelling objects.

The Tractor Beam Unit is normally kept retracted within a special bay, behind protective shutters. When deployed, the Unit extended at the end of a 30-meter telescoping boom, allowing a wide field-of-aim. To support the enormous strains involved when the Unit is operating, the boom is firmly anchored to the ship's frame members. In addition, all starship's possess smaller Tractor Beam Units within their Hangar Bays, to facilitate docking.

Engineering Department

Each Unit is actually a dual Tractor/Pressor combination, which functions can be used singly or in concert:

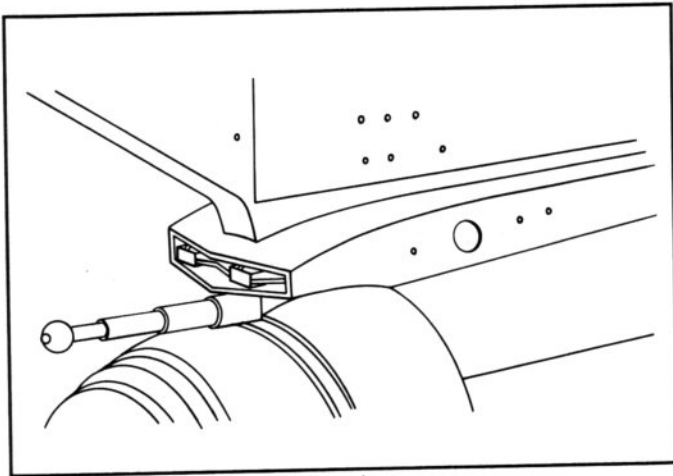

Tractor:

- To pull smaller spacecraft or objects within Transporter Range.
- To pull auxiliary craft into the Hangar Bay.

Pressor:

- To repel hazardous materials from the ship's vicinity.
- To boost auxiliary craft from the Hangar.
- To launch un-powered probes.

Tractor/Pressor Combination:

- To anchor the ship to a larger body (Spacedock).
- To place a smaller spacecraft under tow.
- To stabilize the position of a drifting buoy and replace it in position.

Various Types of Starships have their Tractor Beam Unit Bay mounted in different locations. For vessels possessing a dorsal pylon such as in the *Enterprise* Class Heavy Cruiser), the location is as shown.

Transporter

-Definition and Function

A Transporter is a matter/energy scrambler. It functions by transtating a material object (physical pattern) into an energy pattern, projecting that energy pattern to a desired destination coordinate, and then transtating the energy pattern back into its original physical pattern. Transporters are the primary mode of transportation to and from vessels. Each Class 1-B starship has four different models of Transporter built into it (usually more than one of each model). These models are rated in sequence of function and capability

Standard: 6 Personnel - high priority
Evacuation: 22 personnel - top priority

Medical: 1 patient (supine) - high priority
Cargo: 5 tonnes of cargo - medium priority

Despite functional and capacity differences, all Transporters have some alike features. Each has a control console, which is shielded from the Transporter Chamber. Within said Chamber are one or more scanning plates bed-shaped in the case of the Medical Transporter), and a high priority feed from both the Science Sensors and the Engineering Stand-by Power Grid.

-Operation

The following scenario refers to a Beam-down: transporting personnel from the ship to a planetary surface.

Warm-Up: The system is activated, and runs through a lengthy series of self-diagnostic checks - including Sensor and Power availability.

Entrance: The subject steps onto the scanning plate.

Lock-on: The destination coordinates are entered into the Transporter Console Computer. This is a complex process, as the computer must Scan the destination with the Science Sensors, calculate and synchronize with the relative separation of the destination coordinates (distance, vector and rate-of motion, plane of rotation, plane of orientation) in a moving three-dimensional framework. Once the computer has locked-onto the destination coordinates and is tracking them, it will signal Lock-on.

Scanning: The scanning plate envelops the subject in the transporter beam as it scans and records the exact physical pattern of the subject within the console computer.

Energize 1: (Dematerialize) The computer uses the transporter beam to transtate the subject from a physical pattern (a material object) into an energy pattern (a tachyonic pulse).

Transmission: The energy pattern is synchronized with the destination coordinates.

Energize 2: (Materialization) At the preset nano-second, the transporter beam will transtate the subject's energy pattern back into its original physical pattern. Once complete, the transporter beam will fade. While it still envelops the newly materialized subject, the process is still being monitored via Science Sensors from the ship. If for some reason the energy pattern is not precise through variation caused by some external factor, it can be fine-tuned during materialization by referring to the pattern stored in the console computer memory. This process is known as Matter-gain.

Starfleet DYNAMICS

-Variations and Options

Beam-up: Transporting an object from a distant origin coordinate to the ship's Transporter Chamber. Identical process to Beam-down, except that the ship's Science Sensors are used for the original scanning process, and aid the console in enveloping the distant subject in the transporter beam. The scanning plates are the destination coordinates.

Matter-gain: A weakened or imprecise energy pattern can be fine-tuned using the pattern stored in the console computer memory as a reference. This process requires manual fine-tuning, it cannot be automated.

Delay Mode: Materialization is usually simultaneous with Dematerialization, but need not be. A subject can be held in the transporter beam within the console computer memory (effectively in stasis) for up to one hour.

Scatter: A transporter beam can be set to Dematerialize an object and then scatter its component atoms throughout a nearby volume of space in a loose dispersal pattern setting.

Sterilization: Personnel Beaming-up from a pathogen-contaminated environment can be decontaminated by a medium-strength sterile-field built into the Chamber.

Pressor-Field: The transporter beam will remove atmosphere at the destination coordinates within the volume to be occupied by the subject by pushing the air away from the locus. If other environmental conditions exist which would interfere with the subject's materialization, they can be moved out/down by an optional expanding pressor-field (high grass, dust particles).

Duo-Station: The process of transporting can be simplified if, instead of inert decking or landscape, the destination or origin coordinates are scanning plates within another ship's Transporter Chamber. Slaving the two consoles together for a link allows for easy repeated usage without recalibration for synchronization.

Disassemble: A transporter beam can be set to Dematerialize an object, and then edit the energy pattern prior to Materialization. For example; a mixed pile of sugar and salt could be Dematerialized, edited, and then Materialized as two piles - one of sugar, one of salt. This editing process is the basic principle behind the Fabricator and Defabricator.

-Hazards

Any conditions existing in the space between the origin and destination coordinates, which in any way affect the transporter beam so as to scramble the energy pattern therein, will have fatal results to any living subjects. A Transporter operator must at all times scan for these hazards, and be prepared to either boost Matter-gain or retrieve the subject. Hazards include:

- Intervening force-fields
- Intervening Rock

Fabricator & Defabricator

-Fabricator, Definition and Function

The Fabricator is a secondary matter/energy scrambler, and is based upon the Transporter. It is the mainstay of twenty-third century mass-production, as it can duplicate any material object - so long as an energy pattern of the object is stored within the memory bank, and the proper raw materials are available. It cannot manufacture items from pure energy, nor can it build molecules by attaching atoms together. Its function is to Dematerialize various molecules in one location area (assorted raw materials bins), and then Rematerialize these as an edited physical pattern in a second location - a delivery hopper. There are four types of Fabricator onboard a starship.

High-resolution Organic: (Foods and Beverages)

- Located in the officer and crew messrooms.

Low-resolution Organic: (Laundry)

- Located in individual washroom facilities.

High-resolution Inorganic: (Microcircuitry)

- Located in the Engineering workshops.

Low-resolution Inorganic: (Metals and Ceramics)

- Located in the Engineering workshops.

-Requirements

For a Fabricator to Materialize something, two things are necessary: Original Recording on File: There must be an energy pattern of the desired product on-file within its memory bank. This is done by placing an original object to be duplicated within the Delivery Chamber and activating the Recording System. This is a one-time operation (since the energy pattern is now on file). It can only be done by the Quartermaster and Chief Engineer. Raw Materials Available: There must be an adequate supply of raw materials accessible to the Fabricator. Each molecule for every item a Fabricator can duplicate must be stored in the Raw Materials Bins nearby. Each Fabricator has attached to it a complete set of the appropriate Raw Materials Bins. High-

resolution Organic Fabricators have many bins, containing such raw material molecules as lecithin, maltose, water, etc. Low-Resolution Organic Fabricators have only a few bins, containing such raw materials as textile plastic molecules. Inorganic Fabricators have various bins containing various metals, ceramics, and esoteric molecules.

-Operation

The following scenario refers to the operation of a High-resolution Organic Fabricator within a messroom:

Selection: Diner reads the menuscreen and voices an order for a cup-of-coffee and a doughnut.

Engage: The Fabricator accesses the stored energy patterns filed under cup-of-coffee and doughnut and transfers same to its working memory.

Energize 1: (Dematerialize) As listed with the energy pattern file, the Fabricator Dematerializes needed molecules from their Raw Materials Bins via transporter beam and places these on delay mode (sugar, various proteins, water, etc.). The Fabricator only energizes precisely as much of each molecule as is needed. It also Dematerializes a cup, plate, and tray. **Integrate:** The energized energy patterns of the raw materials and utensils - held in stasis within their transporter beams - are integrated according to the stored energy pattern, intermingled so that each molecule's pattern is placed precisely where the original's was.

Energize 2: (Materialize) All molecules Materialize within the Fabricator's Delivery Chamber. The coffee will Materialize at the exact temperature as the original - as all molecules have been given the original's energy-state - and will be within the cup. The doughnut will also be an exact copy (molecule-for-molecule) of the original from which the pattern was recorded. Elapsed time: 5 seconds.

-Requirements

For a Fabricator to Materialize something, two things are necessary: **Original Recording on File:** There must be an energy pattern of the desired product on-file within its memory bank. This is done by placing an original object to be duplicated within the Delivery Chamber and activating the Recording System. This is a one-time operation (since the energy pattern is now on file). It can only be done by the Quartermaster and Chief Engineer. **Raw Materials Available:** There must be an adequate supply of raw materials accessible to the Fabricator. Each molecule for every item a Fabricator can duplicate must be stored in the Raw Ma-

terials Bins nearby. Each Fabricator has attached to it a complete set of the appropriate Raw Materials Bins. High-resolution Organic Fabricators have many bins, containing such raw material molecules as lecithin, maltose, water, etc. Low-Resolution Organic Fabricators have only a few bins, containing such raw materials as textile plastic molecules. Inorganic Fabricators have various bins containing various metals, ceramics, and esoteric molecules.

-Defabricators

For each type of Fabricator, there is an attached Defabricator, which keeps the Raw Materials Bins filled. Defabricators function by Dematerializing unwanted items placed therein via transporter beam, editing the energy pattern into the component energy patterns, and then replacing these energy patterns into their respective Raw Materials Bins, where they are Materialized. There are three types of Defabricators:

Inorganic Defabricators: Fed from the refuse chutes in the Engineering, where broken or unneeded devices are deposited rather than being fixed or stored. Separated energy patterns are returned to the Raw Materials Bins of the Inorganic Fabricators.

Low-resolution Organic Defabricators: Take soiled or torn uniforms, Dematerialize them, and then duplicate a fresh one from the filed energy pattern for that crewman. Together with the Low-resolution Fabricator, this is known as the Laundry System. Clothing not on file will not be Dematerialized. In this case only the foreign substances on them (dirt and body excretions) will be Dematerialized, and the original item will be just as worn as it was when placed inside, but clean.

High-Resolution Organic Defabricators: Fed from the waste disposal system on each deck. Wastes are sterilized, Dematerialized, and their edited raw materials returned to the bins.

-Foreign Substances

The Defabricator cannot store a molecule for which it has no bin. For example, thalium-oxide stains on a uniform cannot be stored in a specific bin. For this reason, each Defabricator has a Foreign Substances Bin, which acts as a repository for molecules which could otherwise not be stored.

-Safeguards

Every Defabricator has a built-in Kirlian Scanner. If the item within the Chamber shows the presence of pathogens, the Defabricator will ignore these, as they will be automatically irradiated by the sterile-field cycle. If however the Kirlian Scanner detects the presence of a life-form (0.1 liter bulk or greater), an alarm will sound and the Defabricator will disengage. This safeguard is intended to prevent the

Starfleet DYNAMICS

accidental disintegration of laboratory specimens and passenger's pets which may somehow find their way into the Defabricator Chamber.

Life-Support

Arguably the most important task aboard any vessel is the maintaining of a stable artificial environment. There are two Bridge Stations devoted to this task: Environment, and Artificial Gravity. The proper setting-up and up-keep of a closed life-cycle (such as that aboard a starship) is complex, involving equipment and facilities throughout the vessel, and equally wide-ranging in functions. Food/Waste Processing Systems, Atmospheric Recycling Systems, and Gravity Synthesis Systems all work in concert to simulate a Class M habitat as closely as possible.

-Environmental Control

Environmental Control is subdivided into three levels:

General: In theory, the two Bridge Stations control and monitor the internal environment of every compartment and corridor within a vessel, so that all experience an identical environment (known as Standard Conditions). In actuality this varies considerably. The Bridge Stations control and monitor the Environmental Systems and conditions via sensors built-into the intercoms. These two Stations are normally unmanned - being Standing Stations. Should a compartment's conditions exceed tolerable parameters (fire, flood, poison gas, etc.) the computer will sound an alert. Both Stations are manned during Battle Stations.

Single: Staterooms and other compartments possess limited control over internal environmental conditions. Such factors as temperature, light-level, and humidity may be individually tailored or temporarily adjusted via voice control - using the compartment's intercom linking to the Bridge Station's internal computer.

Independent: Some areas of the ship must have total control of their individual environment, so as to effect changes vital to the area's usefulness (such as Airlocks, the Hangar Bay, and the Gymnasium). These are equipped with Control/Monitoring Stations (a small console), and their own Environmental Systems. Control of these Stations and Systems is normally slaved to the Bridge Station (General), but can be overridden whenever the areas' conditions must be altered (such as phasing-out gravity and evacuating air from the Hangar Bay).

-Environmental System 1 - Synthetic Gravity

Gravity is manufactured aboard ship using a two-part system, consisting of generators and grids. These emit a polarized gravitronic flux, aligned towards the deck (down). Each deck has at least one generator, controlling a network

of grids. Larger decks have more generators. Those areas requiring Independent Environmental Control (Airlock, Hangar Bay, Gymnasium) will have their own generators and grids. The generators draw power from the Constant Power Network. The synthetic gravity grids are a 0.5 millimeter superconducting mesh bonded to the deck-plates, and protected by the covering walking surfaces such as carpeting. All grids connected to a particular generator will create a gravity field with identical potential. The usual field-strength is 980 gals (Terran Standard).

A second product of the generators and grids is the maintenance of the inertia-damping field. This field - maintaining a force-field flux throughout the volume of the ship - prevents personnel and equipment from being affected during sudden vessel maneuvers - absorbing the momentum. Operation is totally automatic. Especially violent maneuvers - such as jump-accelerations, veering turns, and weapon's impacts, may temporarily exceed the field's ability to compensate, and the personnel may be shaken-up mildly.

-Environmental System 2 - Atmospheric Recycling

Particulars:

Model	ARS 4C
Mass	5 metric tonnes
Capacity	2500 cubic meters
Length	10.0 meters
Width	2.0 meters
Height	2.5 meters

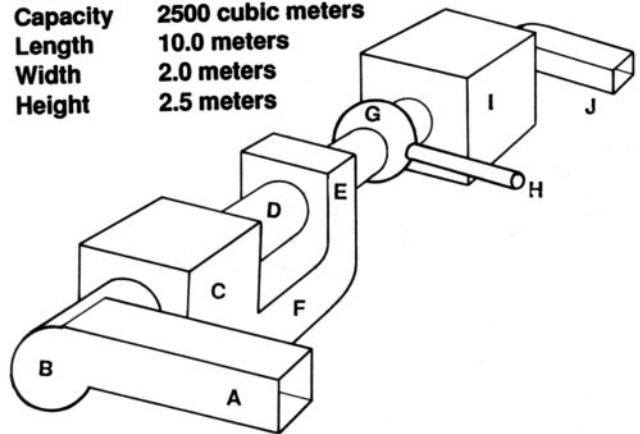

- A) Air Inlet (from ducts)
- B) Turbine Pump (2)
- C) Topaline Catalytic Chamber
- D) Interconnecting Tubes
- E) Heat Extractor
- F) Heat Pump
- G) Filter Chamber
- H) Contaminant Out-flow
- I) Conditioning Chamber
- J) Air Outlet (to ducts)

The function of the Atmospheric Recycling System is to recycle the vessel's air supply: circulating it, converting carbon dioxide to oxygen, removing contaminants, and conditioning. With a rated capacity of 2500 cubic meters, one unit usually processes 4 to 8 small decks. In the case of larger decks (such as F- and G-Deck aboard starships), three ARS 4C units operate in tandem for both. Hangar Bays usually have their own ARS, coupled to a high-pressure storage tank. This allows the Bay to be pressurized or de-pressurized without additional load upon other units. Time duration to depressurize the Hangar Bay of a Enterprise Class Heavy Cruiser (8000 cubic meters) is three minutes.

Function is divided into four chambers, strung together via insulated interconnecting tubes, with various support machinery incorporated: **Turbine Pump:** Draws air from the exhaust ducts from the ship's compartments and blows it into the unit.

Topaline Catalytic Chamber: Filled with a sponge-like mass of topaline crystals, and heated to a temperature of 3000 degrees. As carbon dioxide is forced through the sponge passages, the molecules are split into oxygen ions and carbon vapor.

Heat Extractor: The air-flow passes through a heat-absorbing field, which cools it to a temperature of 20 degrees. The absorbed heat is not wasted, but rather is pumped back into the Topaline Catalytic Chamber - with 97% efficiency.

Filter Chamber: Selectively-permeable force-fields allow oxygen and nitrogen molecules to pass, but filter all other contaminants (carbon atoms, dust, odor-causing ketones, poisonous gases) out to a Defabricator.

Conditioning Chamber: As preset, such factors as humidity, temperature, scents, and ionization are modified.

Turbine Pump: Blows the refreshed air back into the supply ducts to the ship's compartments.

Turbolift

-Definition

As a starship's internal transportation system, the Turbolift provides rapid access to virtually all parts of a vessel. The system is comprised of three parts:

Turbosh shafts: The turbosh shafts comprise a network of hollow tube, extending horizontally and vertically throughout a vessel. Normally, Turbosh shafts run between compartment bulkheads. However in some multi-level compartments (such as the Rec-Deck and Cargo Bay), the Turbosh shafts are free-standing, looking like cylindrical translucent-white pillars, through whose surface cars can be seen rising and descending.

Turbolift Stations: From the main Turbosh shafts, shorter tubes branch-off - each ending at a Turbolift Station (a door providing access to a ship's corridor), so that stationary

cars do not block the Turbosh shaft. Some decks possess several Turbolift Stations, and most vessels have upwards of forty Stations. Each destination has been assigned a two-digit Station ID - the deck letter followed by a sequential number. Thus the two Turbolift Stations on the Bridge are designated Stations A-1 and A-2. The illustration shows a Turbolift Station Label.

Turbolift Cars: A self-contained capsule 2.5 meters in diameter and height, traveling through the Turbosh shaft network via air-driven impellers, and stopping at Turbolift Stations to pick-up and deliver personnel. There is one Turbolift car for every Turbolift Station. All operate under the constant guidance of the Main Computer, which shunts vacant cars out-of-the-way so that no Station is without a car (if one car is enroute from the Bridge to the Rec-Deck, the car at the Rec-Deck will make its way along a different path to the Bridge, so that the destination Station is cleared, and the Bridge Station is filled).

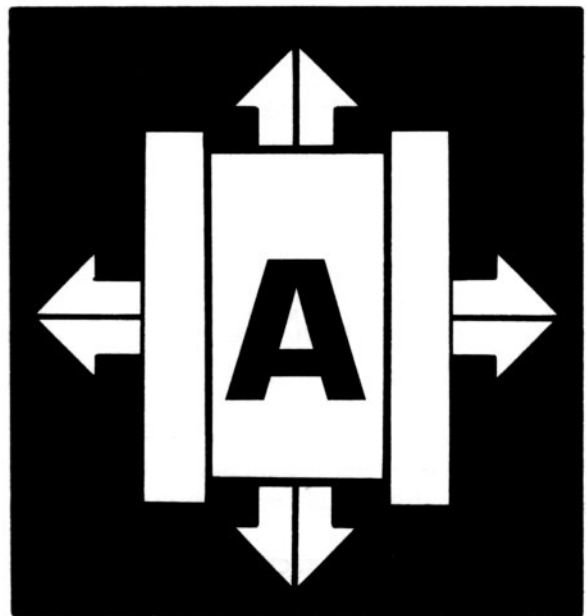

-Operation

Upon entering, the passenger states his destination-code verbally to the intercom, which passes it to the Main Computer (such as "Bridge"). For confirmation, this destination will appear written on the graphic display at the rear of the car. This display shows a plan and elevation view of the entire Turbosh shaft network, and the progress of a car's travel can be seen as a red dot moving along the green pathways. In the case of multiple passengers going to different destinations, the car will chose a route tangent to all desired destinations.

Destination Code: A passenger can state his destination-code as either the Station ID (such as "A-2"), or the compartment or corridor name ("Bridge").

Damage Control

-Definition

Damage Control is the process by which a ship is kept in, or returned to peak operating condition. Keeping it thus requires the efforts of all ship's personnel, through their vigilance in maintaining maximum safety conditions at all times. Returning a ship to peak operating condition (after damage) is the responsibility of the Damage Control Division.

Damage Control/Airlock Division

-Damage Control Teams

Using an Enterprise Class Heavy Cruiser as an example, a starship's Damage Control/Airlock Division numbers nineteen - one officer and eighteen enlisted men. Under normal conditions (Condition Normal), the Division personnel stand watch at the Airlocks - operating same and doing maintenance for such systems as spacesuits and seals - six per shift. During Red Alert, all DCA personnel report to their respective Airlocks, where their Damage Control Lockers are located. They don their orange Anti-radiation Suits and wait to be directed from the Bridge Station, where the Damage Control Division Head Officer will coordinate their efforts and direct three-man teams to any damage requiring repair.

-Damage Control Equipment

As stated, the Damage Control Lockers are located at each Airlock. It holds three of the orange suits, and a Damage Control Case. This case holds any and all equipment needed to effect nominal (temporary) battle repairs at the damage site. Contents include:

- FE41 Fire Extinguishers (2)
- Neutrino-welder
- Phaser Cutting-torch
- Epoxy-foam Sprayer
- Tricorder
- Wiring/Fiber-optic Repair Kit

Some Damage Control equipment can be found at various locations throughout the hull. Fire extinguishers for example, are strategically mounted in various compart-

ments and corridors within the vessel, so that one is never more than 25 meters away. The FE41 is the standard fire extinguisher carried aboard Starships. The FE41 contains Halon-5 fire-suppressant. Unlike carbon-dioxide, Halon-5 does not smother a fire by excluding oxygen from the point of combustion. Rather it acts as an oxygen-binder, capturing all free oxygen molecules within reach and leaving a white mist. The Halon-5 can be inhaled, and will release its oxygen cargo to haemoglobin within the lungs. The residual Halon-5 will be collected by the kidneys, and will be harmlessly filtered out of the body, causing no side-effects.

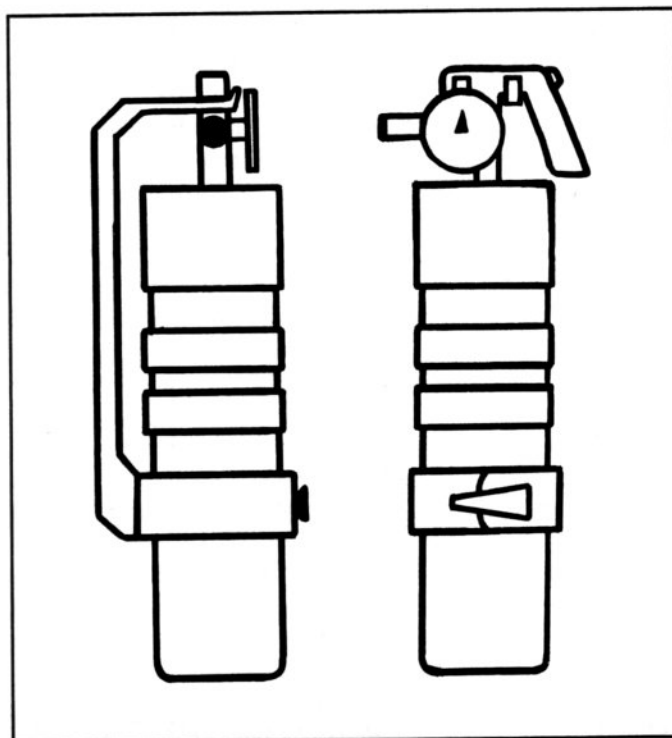

-Damage Control Operations

Stabilization: The primary goal and mission of a Damage Control Team is to quickly stabilize any situation. The secondary goal is to restore to nominal operation of any damaged systems. Final repairs are left for when the ship is out of danger, and Condition Normal is restored. As an example: If the hull protecting a Photon Torpedo Launch Bay is ruptured by enemy fire - evacuating the compartment to vacuum - Fire-control personnel will be unable to use the launch tubes until an atmosphere is returned, thus crippling the vessel's ability to fight. The Damage Control Team will quickly provide a temporary repair by sealing any cracks or small holes in the hull with quick drying epoxy-foam. This will allow the Bay to hold pressure.

Engineering Department

Nominal Operations: After the situation has been stabilized, the Damage Control Team will fix any essential systems necessary to the vital operation of the damaged compartment. In this example, they would check the Fire-control computers and linkages, and check that the tube hatch was still functional. Destroyed wiring and fiber-optic cable would be quickly spliced, and consoles jury-rigged, so that nominal operation was restored, and the tube could be used.

Repairs: After the ship's Alert Status has been returned to Normal Condition and the vessel is out of immediate danger, extensive repairs are carried-out. Jury-rigged consoles are overhauled, tested, and tidied-up, environmental systems are fine-tuned, scorched bulkheads are repainted. Damage to the hull - previously quick-fixed with epoxy-foam - is more permanently repaired, with EVA personnel neutrino-welding patches of hull-plate to the holes and cracks. Any damage to the Defense-field antennae will be spliced. Larger hull-plate patches will be brought to the damage site by Workbees (Bees with waldo manipulators), which will collect the patches from their storage locker under the Hangar Deck and hold them against the hull. Only after all these repairs are completed is the Damage Control Officer able to announce to the Captain that the vessel is "Ship-shape". More extensive repairs will then be able to wait until the vessel can undergo a refit in a Starfleet drydock.

-Bridge Damage Control Station

The Bridge Damage Control Station is normally unmanned. During Normal Conditions, the Damage Control Officer is stationed in the Main Airlock, where he repairs and maintains spacesuits and other related gear during his duty-shift. During Battle Stations, he makes for the Bridge, where he has an intercom master circuit to his Teams, allowing him to direct their movements without tying-up the regular channels or the Communications Officer. This console is powered by its own dilithium powerpack, so that it can remain active even when many essential systems are down (which is the whole point). The screens can display any deck, and show damage - as reported by Damage Assessment Sensors built into the ship, and by personnel over the intercom - overlaid in red.

-Damage Control Auxiliaries

Obviously, certain personnel and Divisions are not required to man their regular duty stations during a Red Alert (eg: Commissary, Sciences, Recreation). For this reason, these personnel are assigned other non-Divisional duties during a Red Alert - when they are known as Damage Control Auxiliaries. As a matter of course, all Starfleet personnel have been trained in basic Damage Control procedures. At the order to "Man Battle Stations", said Auxiliaries will immediately report to their individual Battle Stations

throughout the ship. These posts have been selected as being well-distributed so as to evenly fill the entire volume of the ship. In the event of battle damage, these on-the-spot Auxiliaries can markedly reduce the response time to such critical situations as fires and injuries, and can report the seriousness of any damage to the Bridge Station, who will send Damage Control Specialists to the areas where they are most needed. No matter what the rank of an Auxiliary during normal conditions, during Battle Stations an Auxiliary is responsible to the Damage Control Officer, and will obey all orders given by him or any of his personnel.

Training: In addition to the basic cadet course, on assignment to a Starship all new personnel will be briefed with any special design problems (pertaining to DC) inherent to their ship. Training Includes:

- Fire Extinguisher Locations and Use
- Environmental Systems Manual Overrides
- Rapid Evaluation & Reporting of Damage
- Assisting in Basic Repairs
- Basic First-Aid

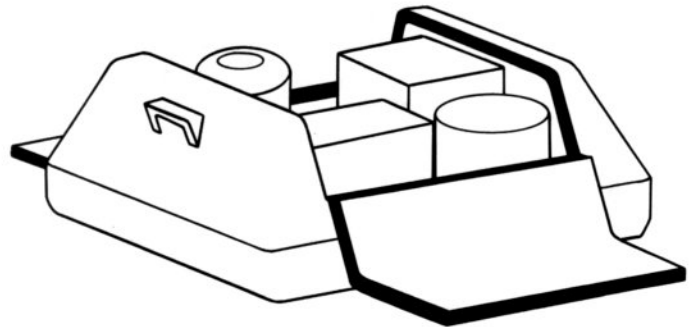



Appendix

Lexicon

Like all professions, Starfleet possesses a vocabulary unique to itself. This lexicon is included to familiarize the cadet. It is not meant to be all-inclusive.

Abaft - Farther aft

Aboard - Within a ship

Adrift - Loose from moorings without power. Out of control or lost

Aft - Toward the stern

After - That which is farthest aft

Amidships - Indefinite area midway between bow and stern

Armament - Ship's weaponry

Astern - Directly behind a ship: Bearing 180 Mark 0

Athwart - Across, at right angles to

Auxiliary - Extra or secondary

Aye Aye - Reply to a command meaning I understand and will comply

Azimuth - See Bearing

Back - To go backwards

Band - Pair (or larger group) or similar weapons, fired as a unit

Beam - The extreme breadth of a ship

Bearing - The direction of an object from an observer; first measured in degrees clockwise from dead-ahead along the ship's X-Y plane. Second measured in degrees upward or downward from said X-Y plane

Belay - To countermand or cancel a previous order or action

Below - Downward from a position

Berth - Mooring space assigned to a ship

Billet - Place or duty to which one is assigned

Board - The act of going aboard a ship. A group of persons meeting for a specific purpose

Bow - The forward end of a vessel

Bridge - Area in the superstructure from which the ship is controlled

Brig - Jail cell

Broad - Wide

Bulkhead - A vertical partition (wall)

Buoy - A free-floating object sometimes used as an aid to navigation

Burdened Vessel - That vessel which does not have right-of-way

A p p e n d i x

Cabin - Living quarters aboard a ship
Cadet - Student officer at Academy
Chart - Usually holographic map of a volume of space, showing stellar positions and traffic lanes
Colors - Federation of Planetary flag. Command to raise or lower same
Combat Information Center - Compartment used by tacticians to analyse enemy strategy and tactics (CIC)
Communicator - Personal transceiver
Companionway - Deck opening giving access to a ladder
Compartment - Interior space of a ship (room)
Conn - Station on the Bridge from which the ship is controlled. The act of so controlling
Course - A ship's desired direction and path of travel, not to be confused with heading

Dead-Ahead - Directly ahead of a ship: Bearing 000 Mark 0

Deck - Horizontal partition in a ship (floor)
Department - Main subdivision of a ship's crew
Division - Minor subdivision of a ship's crew
Dock - Any structure which serves as a mooring point for a vessel. The act of so mooring
Draft - The extreme height of a vessel
Drift - The deviation of a ship from its plotted course or position
Drydock - A dock which is equipped to refit or rebuild ships

Energizer - The apparatus which converts raw energy from the reactor into electrical power for the vessel
Engines - All-inclusive term meaning a ship's powerplant and all propulsion systems

Fabricator - Matter/Energy scrambler used for manufacture/disassembly of foodstuffs and artifacts
Fantail - The after end of a Hangar deck
Flag Officer - An officer above the rank of Captain
Flat - Grating or partial deck to provide walking and working surfaces, used extensively in engineering spaces
Fleet - An organization of ships and structures, all under one command
Fore - Toward the bow
Frame - The secondary structural members of a ship's hull

Galley - Space where foodstuffs are manually prepared
General Quarters - Battle Stations
Gig - Auxiliary Craft assigned to the captain's use

Hangar - Space used for landing, launching, and parking auxiliary craft
Hard-Over - Extreme turn to one side
Hatch - Removable cover to a gangway
Head - Compartment containing refreshing facilities
Heading - The direction a ship is facing while underway

Helm - Station from which a ship is maneuvered
Helmsman - Person who maneuvers the ship
Hold - Large cargo space aboard ship
Hull - The outer shell of a ship

Inboard - Toward the centerline

Jury Rig - Any makeshift device or repair

Keel - The main strength members of a ship, from which the frames and hull plates depend

Launch - To maneuver a vessel from dock or planet surface

Liberty - Permission to be absent from ship or duty for a pre-determined duration

Log - Record in which data or events that occurred during a watch are stored

Mess - Compartment where meals are eaten

Midshipman - Student officer aboard ship

Moor - To anchor or make fast to a dock

Nadir - Directly below: Bearing 000 Mark -90

Ordnance - General term meaning weapons systems

Outboard - Away from centerline

Overhaul - To overtake another ship. To undertake massive repairs to a ship

Phaser - General term applying to phased tachyonic particle beam weapons

Pitch - Rotation of a ship on Y axis

Port - To left of centerline when facing forward, Bearing 270 Mark 0. A major spaceship landing field or orbital station

Quartermaster - Head of the Ship's Services Department

Quarters - Living spaces aboard ship

Range - The distance between observer and object

Relieve - To take the place (duties) of another

Rig - To set up any piece of equipment

Roll - Rotation of a ship on X axis

Running Lights - Navigational lights mounted on ship's exterior

Scuttle - Round air-tight hatch. To self-destruct a vessel

Sensor - General term for a device which gathers data

Shake Down - The training of a new crew. The trial run of a prototype, or a vessel having finished refit

Ship - Any large, independantly operating spacegoing vessel

Shipshape - Neat, clean, taut

Shoreleave - Extended liberty on a civilian planet or station

Starfleet DYNAMICS

Sickbay - Ship's medical spaces and facilities
Side Boy - Member of the honour guard welcoming V.I.P.'s
Skylark - To engage in irresponsible behaviour
Small Craft - General term for any less-than-ship-sized vessel
Spaceship - General term applied to smaller ships
Spanner - A tool used to decouple and fasten equipment
Spline - Straight, curved, or crooked line representing a ship's course in three-dimensions on a chart
Squadron - A fighting unit composed of 15-20 attack craft
Stanchions - Girders used to support bulkheads, attached to frames
Stand By - Prepare for
Starboard - To right of centerline when facing forward, Bearing 090 Mark 0
Stateroom - A living compartment for an officer or passenger
Station - A crewmember's place of duty. Position of a ship in a formation
Stern - The aftermost part of a ship
Stow - To pack articles of cargo in a space or container
Superstructure - Ship modules not mounted within the main frame members

Tender - A vessel which acts as a support ship for other ships
Transporter - Matter/Energy scrambler used for point-to-point relocation
Transverse Frame - Structural member which extends outwards from the centerline of a vessel
Tricorder - A hand-held multiple channel sensor/recorder/analysis instrument
Turbolift - Elevator aboard ship capable of vertical and horizontal travel within a vessel's turboshafts
Turn In - Retire to quarters. Return articles to storage
Turn Out - Get out of bed. Order out a work party
Turn To - Start work

Veer - To swerve suddenly from a previous heading
Void - An empty container. Outer space

Watch - One of the eight hour periods into which a day is divided

Yaw - Rotation of a ship on Z axis

Zenith - Directly above. Bearing 000 Mark +90

About the Design Team

Commander David John Schmidt

Commander Schmidt served for five years in the Federation Marine Corps before transferring to Starfleet Tactical. In 2288 he was posted to the position of First Officer of the starship U.S.S. *Repulse* - an *Athabaska*-Class Strike Cruiser, presently assigned to the Klingon Neutral Zone Patrol Squadron. His accomplishments include the design of the Tomohawk and Talon Assault Craft, and the conceptualization of the Photon Torpedo Variable Payload Module.

Commodore Robert Earl Day

Commodore Day heads the Astrophysics Department of the Starfleet Research & Development Division. He is presently assigned to the High-Energy Chaos-Physics Laboratory Facility at Spacedock. His accomplishments include co-chairing the Transwarp design team for Project *Excelsior*, and designing the sensor array for the *Kestral*-Class Superscout.

Appendix



Tricorder Image Courtesy Cptn. Lisa Atkinson & Commodore Barbara Dryer

*Left to right -
(standing): Cdre. Day,
Cmdr. Atkinson, Lt. Reeves;
(seated): Cmdr. Schmidt,
Cptn. Wright*

Captain Roger Wright

Captain Wright has held many positions within Starfleet, including Special Intelligence, Logistics Analyst, and command of the starship U.S.S. *S'Harien* - a *Menagha*-Class Battlecruiser variant prototype. In 2290 he was transferred to command of the starship U.S.S. *Repulse*, a Tactical Deployment vessel.

Commander Kevin Blair Atkinson

Commander Atkinson worked six years in the Federation Merchant Marine before joining the Starfleet Corps of Engineers. In 2285 he was loaned to Starfleet Tactical to aid in the development of the Megaphaser Cannon. He presently serves as the Chief Engineer of the starship U.S.S. *Kestral*.

Lieutenant Janet Patricia Reeves

Lieutenant Reeves has served for years as a Marine Combat/Assault Shuttlecraft pilot, and an Auxiliary Craft test pilot. She is recognized as an expert in small-craft design and performance. Her present assignment is as the Deck Officer of the U.S.S. *Repulse*.

The 23rd Century Officer's Bible

Technical Information updated to Stardate 9100.00

All-New Format and Layout - Easy to Access Files

Thorough and Complete Articles - Over 150 Illustrations

“A must-read textbook for all Starfleet Cadets and Midshipmen in any Training Program.”

*-Commodore M. Thurlow
Federation Marine Corps*

“...invaluable reference volume to any Starfleet Officer-worthy successor to the Tech Manual.”

*-V. Adm. J. Horowitz
Flagship U.S.S. Nimitz*

“Starfleet has kept the peace for over 100 years. Without question, the key to this performance has been the training given its Officers. This manual carries on that fine tradition.”

*-R. Adm. E. Rogers (ret.)
Starfleet Academy*

**PUBLISHED BY THE STARFLEET
ACADEMY TRAINING COMMAND**