

# STAR FLEET

## STARSHIP RECOGNITION MANUAL

REPORT:

HORIZON HEAVY CRUISER

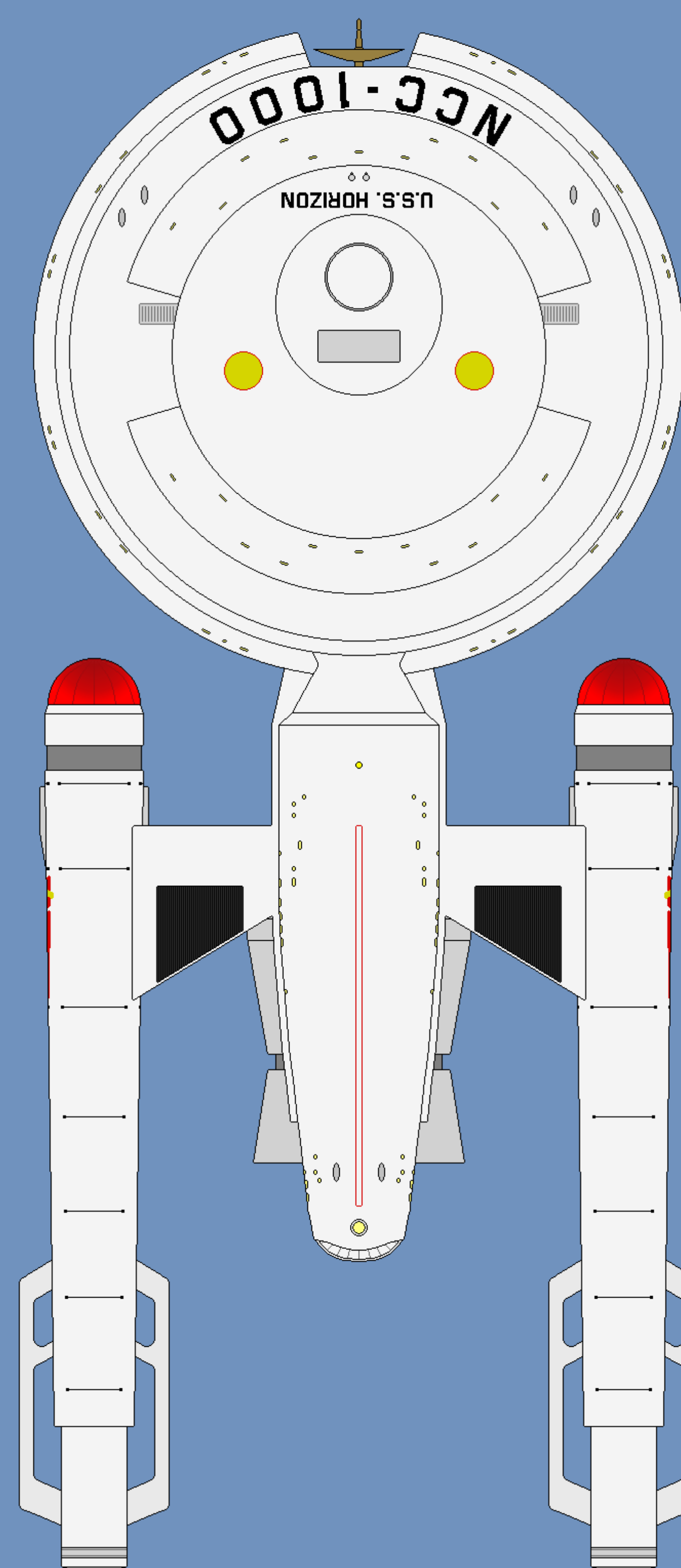



## FORWARD

My contribution to this project would not have been possible without those who came before me. Mainly, CaptShade, whose original drawings laid the foundation for my work by providing me the figurative and literal tools for my own creative output. Nichodo, who was a big help in creating aft and ventral views of various components. RevancheRM, whose ideas and drive helped me get a little more creative and better at something I really enjoy. And, most definitely, Neale "Vance" Davidson, whose enormous volume of work got me interested in doing this in the first place, and for inspiring us all.

- Adrasil

First, as always, thanks to Adrasil. Since partnering with him, I've taken some great artwork and added some context to it. He's really allowed me to scratch my writing itch, to the point it sometimes bleeds, but still feels Oh-So-Good. Next up, of course, is Timo Saloniemi, who's work I've been following for around two decades and I greatly respect. The artwork in these "Starship Recognition Manuals" are 97% based upon the ones he describes textually in his grand opus, the "Hobbyist's Guide to the UFP Starfleet and Its History," and 3% derived from what he has inspired in us.

- RevancheRM

Additional reports may be found at: [starshiptracker.com/deltadynamics](http://starshiptracker.com/deltadynamics)

## CREDITS

ADRASIL: All imagery (unless otherwise credited)  
[www.DeviantArt.com/Adrasil](http://www.DeviantArt.com/Adrasil)

REVANCHERM: All writing (unless otherwise credited)  
[www.DeviantArt.com/RevancheRM](http://www.DeviantArt.com/RevancheRM)

NEALE 'VANCE' DAVIDSON/JAYNZ: Project & cover concepts  
[www.DeviantArt.com/TFVanguard](http://www.DeviantArt.com/TFVanguard)  
[Jaynz.Trekships.org](http://Jaynz.Trekships.org)

STAR TREK DESIGN PROJECT: Source of sponsor icons  
[www.StarTrekDesignProject.com](http://www.StarTrekDesignProject.com)

TIMO SALONIEMI: Author of "Hobbyist's Guide to the UFP Starfleet", the inspiration for these SRMs. A direct link to his Google Drive may be found on most deviations in RevancheRM's gallery.

VIPERAVIATOR: Source of adapted cover starburst  
[www.DeviantArt.com/ViperAviator](http://www.DeviantArt.com/ViperAviator)

HORIZON CLASS:

- Original Inspiration from: Spaceflight Chronology, Star Trek: Legacy

## NOTE FROM THE WRITING EDITOR

These ships do not always exactly match the specifications Timo provides in his technical section for each class, as I've adapted them in ways that allowed them to fit a bit better with the guidance provided by the starship construction rules in Steven Long's "Spacedock". I've also changed some dates around when I found them in conflict with other information Timo has provided. These two books greatly inform my own alpha-canon and I urge you to look up both online, as offered free by their respective authors. (Links to both are provided on the Delta Dynamics site.)

Delta Dynamics' Starship Recognition Manual, along with the Reports and all other similar publications released under that branding, are released as a public service to familiarize interested beings with the historic starship designs and technical developments of the United Federation of Planets Star Fleet, its member and preceding services, and those services of regional galactic neighbors. Despite the occasional presence of a sensitive nature of both those historic events and technical matters discussed herein, the distribution and handling of this publication has been ruled Security Grade O (Unclassified) by Star Fleet Support Operations, Office of Security.

Copyright 2419 by Delta Dynamics, Wellington, Earth.

Memory Terra/Memory Alpha Cataloging Data: UFP ITP/TE 7259381460296

Under the laws of the United Federation of Planets and its members, use or reproduction (in whole or in part) of the information contained in this publication—along with proper attribution of its source—is granted. This edition is authorized for distribution only in member star systems of the UFP its territories and possessions, affiliated star systems, and select independent or neutral star systems. "Star Trek" and all related likenesses are copyrights and trademarks of CBS Television Studios and Paramount Pictures. This publication has been established for informational and entertainment purposes only. No infringement of copyright nor trademark is intended.



## CONTENTS

HORIZON	HEAVY CRUISER	PG 02:01
ADVANCE	BATTLE CRUISER	PG 02:05
WHORFIN	BATTLE CRUISER	PG 02:09
INDOMITABLE	BATTLE CRUISER TESTBED	PG 02:13
HORIZON FLIGHT II	HEAVY CRUISER	PG 02:17
ADVANCE FLIGHT II	BATTLE CRUISER	PG 02:21
ESSEX	BATTLE CRUISER	PG 02:25
ARCHON	HEAVY CRUISER	PG 02:29
CLASS TIMELINE		PG 03:01
STARSHIP COMPARISON GUIDE		PG 03:05
GLOSSARY		PG 03:06
SPONSORS		PG 03:09
OTHER PUBLICATIONS		PG 03:10



HORIZON CLASS

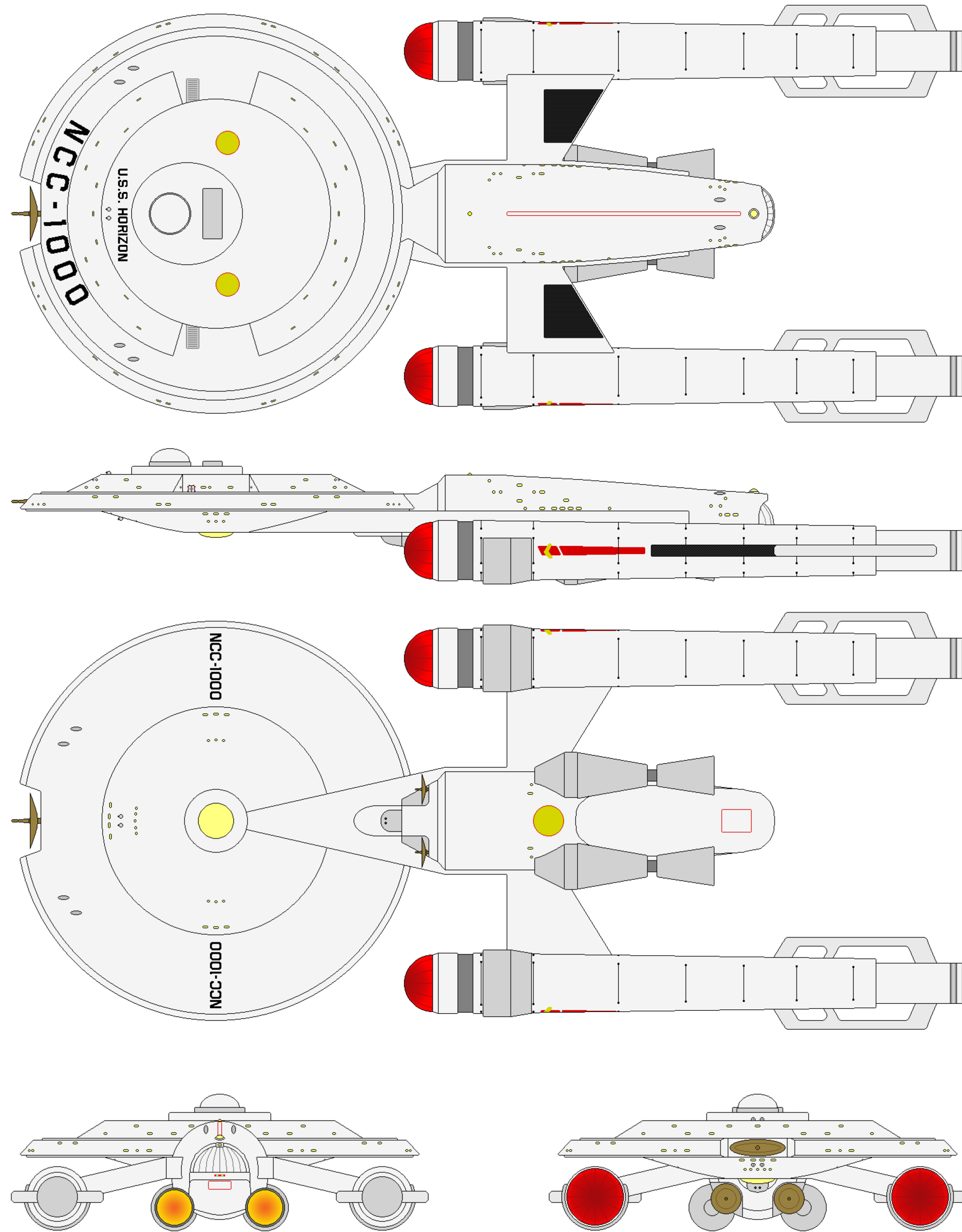

CATEGORY: HEAVY CRUISER  
 OPERATIONAL: 2193 - 2219 (UPGRADED)  
 CONSTRUCTED: 13

DIMENESIONS:  
 LENGTH: 294.1 M  
 BEAM: 117.1 M  
 HEIGHT: 46.0 M  
 MASS: 562,000 MT

PERFORMANCE:  
 CRUISE: WARP 3 (OCU)  
 MAX: WARP 5.3 (OCU)  
 ENDURANCE: 4 YEARS

COMPLEMENT:  
 OFFICERS: 35  
 ENLISTED: 278

TACTICAL:  
 - 4X 1.2 GW LASER EMITTERS  
 - 8X TYPE I (900 GW) PHASE CANNONS  
 - 2X TYPE H (700 GW) PHASE CANNONS  
 - 2X TORPEDO TUBES  
 (W/ 80 PHOTONIC TORPEDOES)  
 - 1-LAYER CONFORMAL FORCEFIELD  
 - NAVIGATIONAL DEFLECTOR  
 - 2X AUXILIARY DEFLECTORS

AUXILIARIES:  
 - 4X HEAVY SHUTTLES  
 - 10X LIGHT SHUTTLES  
 - 6X SHUTTLEPODS



## HORIZON CLASS AUTHORIZED CONSTRUCTION

THE FOLLOWING SHIPS OF THE ABOVE CLASS WERE AUTHORIZED AS PART OF THE FEDERATION STAR FLEET BY FEDERATION COUNCIL APPROPRIATION.

USS HORIZON	NCC-1000	USS BOND	NCC-1007
USS DISCOVERY	NCC-1001	USS NIMROD	NCC-1009
USS SANTA MARIA	NCC-1002	USS METEOR	NCC-1012
USS MATHEW	NCC-1003	USS VICTORIA	NCC-1013
USS GAUSS	NCC-1004	USS NORGE	NCC-1015
USS SAN RAPHAEL	NCC-1005	USS EENDRACHT	NCC-1018
USS SCOTIA	NCC-1006		

---

### GENERAL INFORMATION

In the 2180s, capital ships from the Romulan War—comprised of myriad designs from the founding states—entered periods of inspection and surveys, with expected results: they were tried, tired, and increasingly out-of-date. Star Fleet responded with a call for a new heavy cruiser design. While "quantity" was a constant demand for the expanding service, the requirement for destroyers, tenders, and transports meant that this new generation capital ship had to stress "quality" foremost.

Chiokis Corporation of Andor, a sub-contractor on previous designs, introduced as its first ever primary submission what was immediately declared to be an updated Yorktown battle cruiser. A monster of a ship (at 562,000 metric tons), it was comprised of two hulls and bracketed by nacelles of significance, the PB-18s. The ship's length was an impressive 294.1 meters, with a beam of 117.1 and a height of 46 meters. The primary saucer hull, the broadest part of the ship, had a thickness of 8 meters at the rim, allowing not only quarters and weapon emplacements in the impressive 10 decks, but also six high-tech laboratories. The secondary hull had a clear lineage with that of the Yorktown, though it was enlarged both in depth and length, providing a sense of streamlining with its curving shapes and the undercut stern. The two outriggered pylons slightly sloped downward in order to provide improved positioning for the nacelles. The PB-18s allowed the ship to cruise at warp 3 and attain a maximum velocity of 5.3. The massive Scarbak GPM impulse engines cowed onto the lower secondary hull avoided all the complications and compromises of the two-stage Enterprise/Columbia arrangement.

The ship itself was equipped to sustain its crew of 35 officers and 278 enlisted on 4-year missions over 400 light-years, protecting them with 2 banks of dual laser emitters in the 1.2 gigawatt range, 8 Type I phased particle cannons (900 gigawatts), and 2 Type H (700 gigawatts) covering the aft. Eighty photonic torpedoes were also carried in the primary hull, fired from the battery on the ventral side. The Horizon was Star Fleet's first capital ship to go out sans any armor, fully confident in the ship's reliance on two shield generators to wrap the crew with a blanket of subspace/graviton fields.

Thirteen cruisers of this initial design were fielded, with more planned. The ships were respected for their capacity for independent exploratory deployments outside known space, as well as their various military duties. The Horizon herself had a distinguished career of exploration under the command of Captains Mann, Gatulla and Broderick. The three-year expedition under Captain Mann established first contact with no less than 12 civilizations, a feat no longer believed to be possible after the early days of the Enterprise exploits. However, shortcomings were identified, especially in regards to "hearth world defense," which would be addressed with the follow-on Advance subclass battle cruiser.

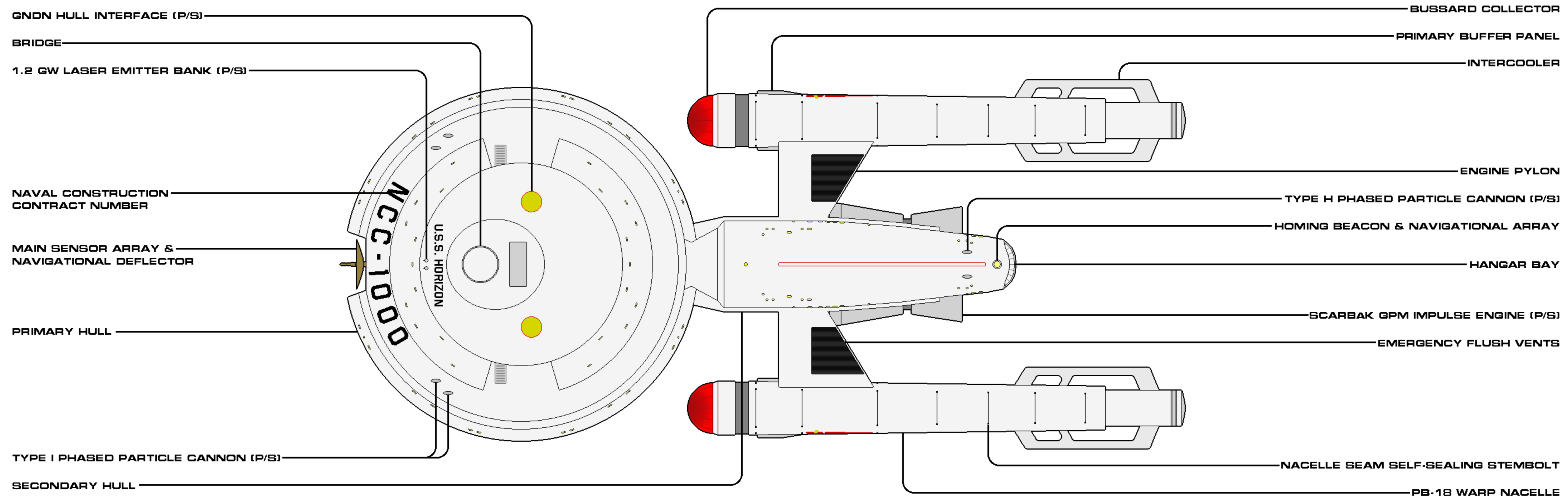
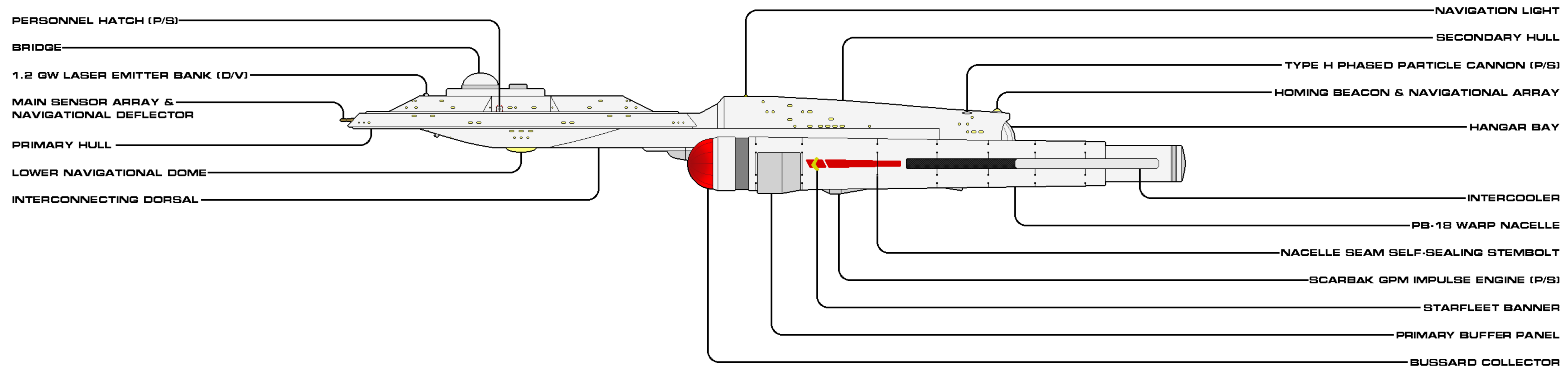

SHEET 1 OF 2

CLASS	HORIZON	CATEGORY	HEAVY CRUISER
VARIANT	NA	CONSTRUCTED	2193
LENGTH	234.1 M	BEAM	111.1 M
HEIGHT	46.0 M	MASS	562,000 MT
OPERATIONAL	13/40	RELEASE DATE	1904.01

Authorized for release by Star Fleet Bureau of Starship Construction

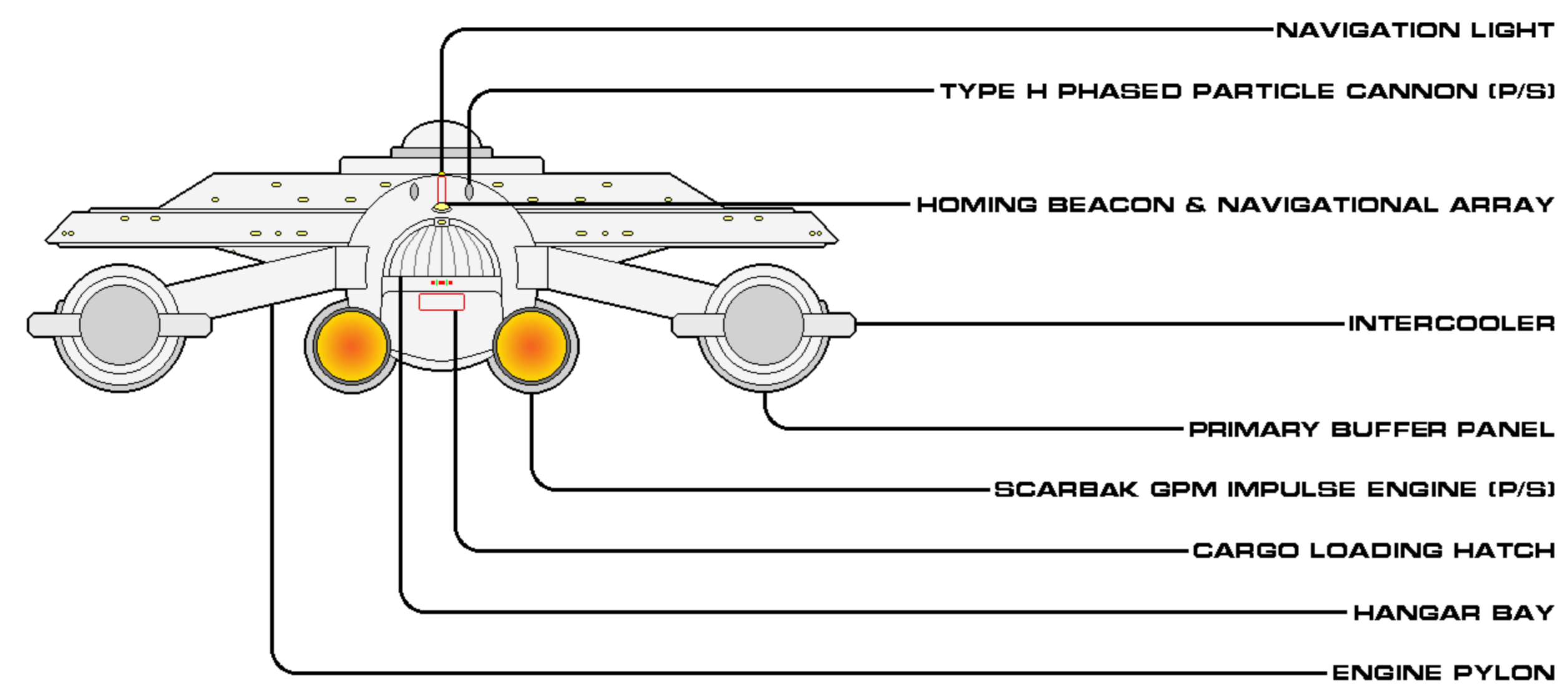
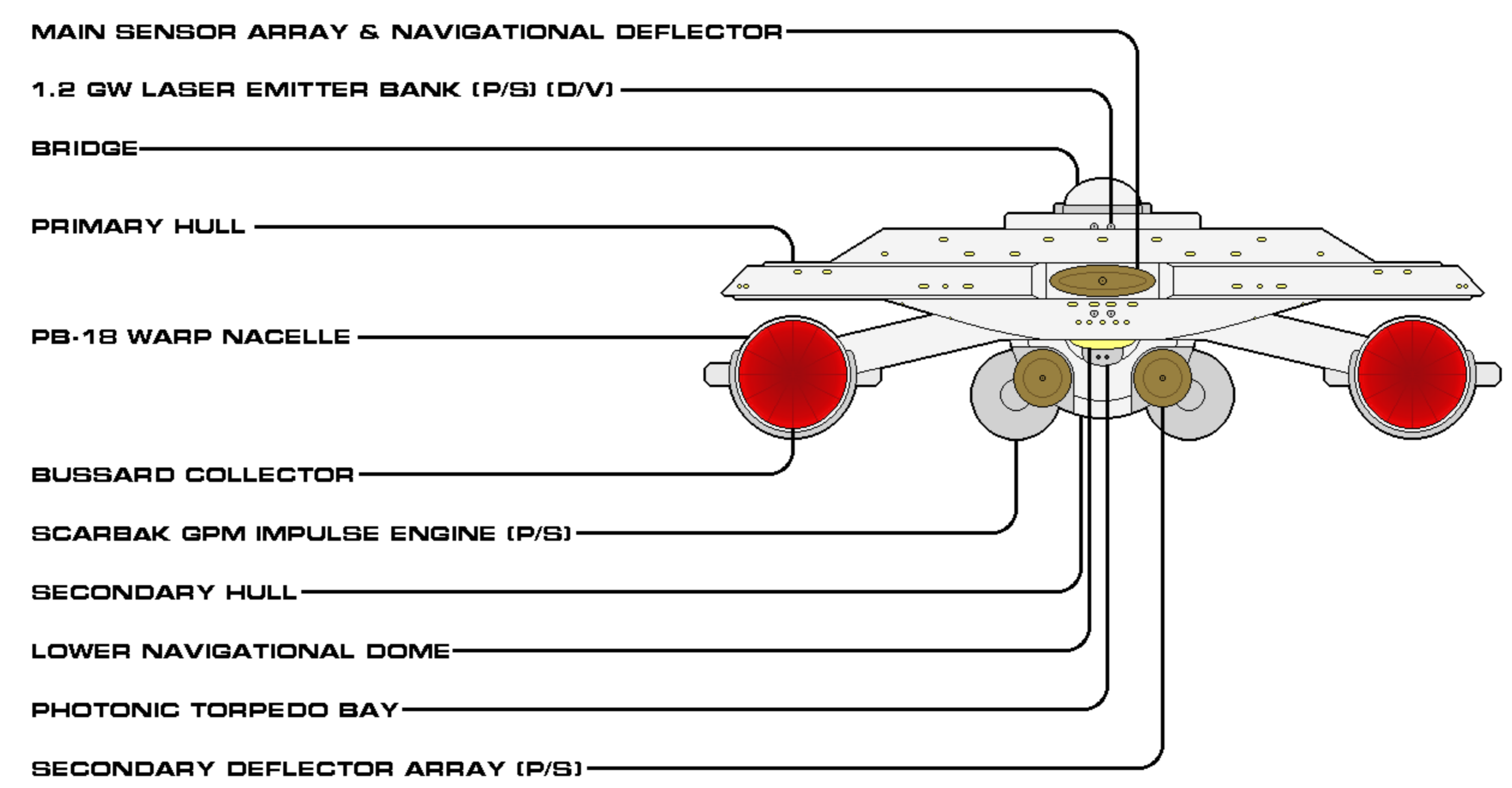
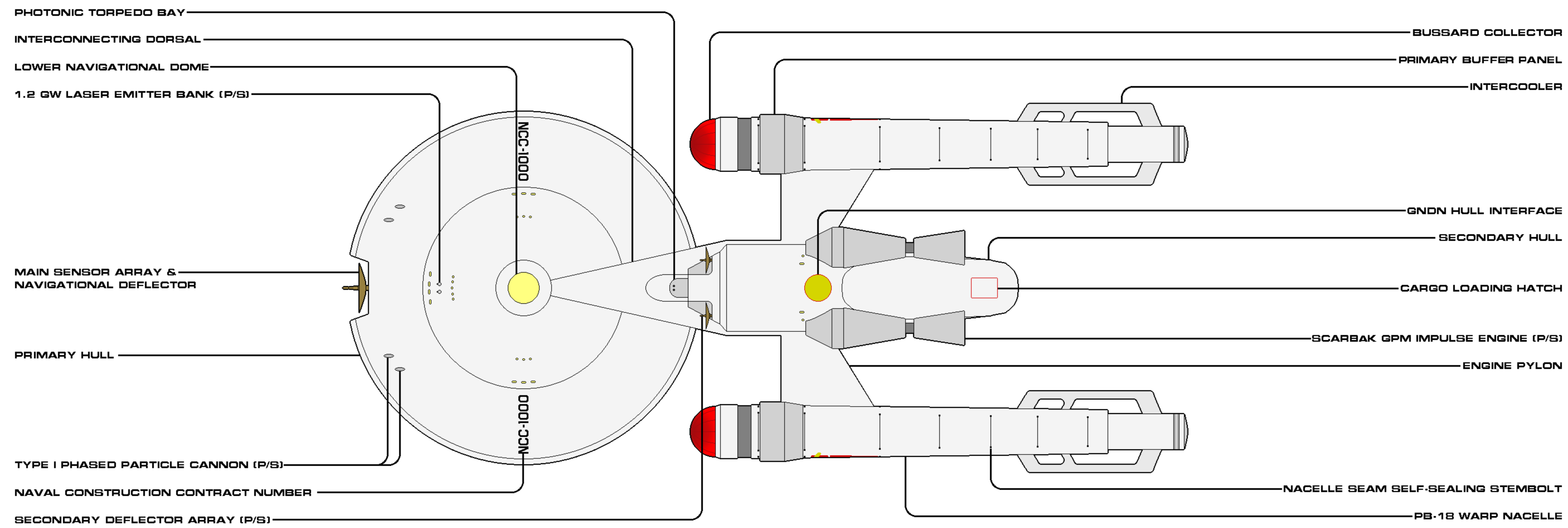

SHEET 2 OF 2

CLASS	HORIZON	CATEGORY	HEAVY CRUISER
VARIANT	N/A	CONSTRUCTED	2193
LENGTH	294.1 M	BEAM	111.1 M
HEIGHT	46.0 M	MASS	562,000 MT
OPERATIONAL	13/40	RELEASE DATE	1904.01

Authorized for release by Star Fleet Bureau of Starship Construction



ADVANCE SUBCLASS

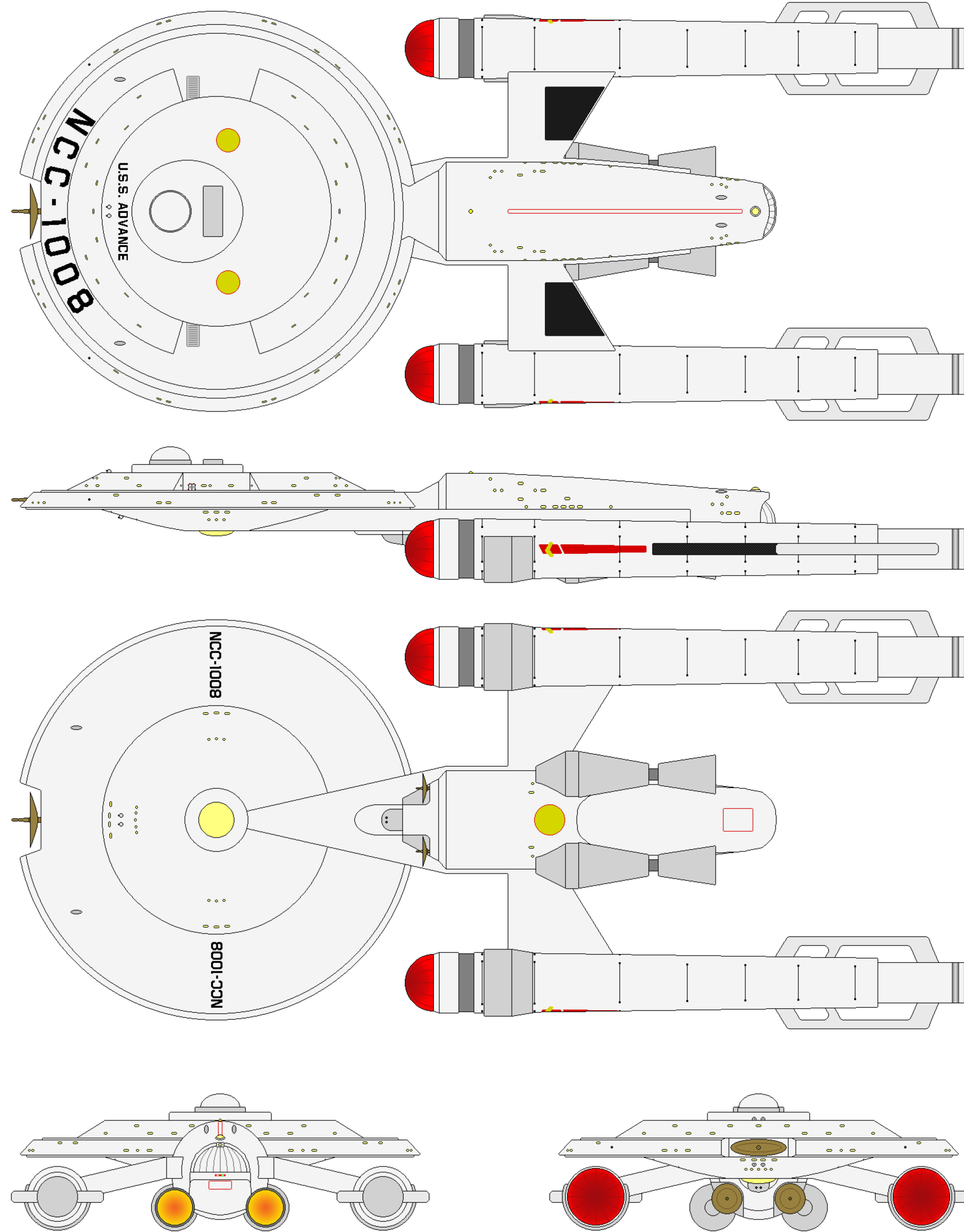

CATEGORY: BATTLE CRUISER  
 OPERATIONAL: 2198 - 2219 (UPGRADED)  
 CONSTRUCTED: 10

DIMENESIONS:  
 LENGTH: 294.1 M  
 BEAM: 117.1 M  
 HEIGHT: 46.0 M  
 MASS: 566,800 MT

PERFORMANCE:  
 CRUISE: WARP 3 (OCU)  
 MAX: WARP 5.5 (OCU)  
 ENDURANCE: 2 YEARS

COMPLEMENT:  
 OFFICERS: 32  
 ENLISTED: 268

TACTICAL:  
 - 4X 1.2 GW LASER EMITTERS  
 - 6X TYPE I (900 GW) PHASE CANNONS  
 - 4X TORPEDO TUBES  
 (W/ 240 PHOTONIC TORPEDOES)  
 - 1-LAYER CONFORMAL FORCEFIELD  
 - NAVIGATIONAL DEFLECTOR  
 - 2X AUXILIARY DEFLECTORS

AUXILIARIES:  
 - 5X LIGHT SHUTTLES  
 - 6X SUBLIGHT TACTICAL CRAFT





## ADVANCE SUBCLASS AUTHORIZED CONSTRUCTION

THE FOLLOWING SHIPS OF THE ABOVE CLASS WERE AUTHORIZED AS PART OF THE FEDERATION STAR FLEET BY FEDERATION COUNCIL APPROPRIATION.

USS ADVANCE	NCC-1008	USS CONSTELLATION	NCC-1017
USS SENTRY	NCC-1010	USS GUARDIAN	NCC-1019
USS GLADIATOR	NCC-1011	USS ARDENT	NCC-1020
USS GOLDEN HIND	NCC-1014	USS DEXTROUS	NCC-1021
USS HALF MOON	NCC-1016	USS WARRIOR	NCC-1022

---

### GENERAL INFORMATION

The Horizon class heavy cruiser was immediately respected for the exploratory capacity provided to Star Fleet, but there was, no doubt, acknowledgment of some shortfalls that needed to be addressed as the ships ventured forth. The class had been designed in a holistic sense to be a cruiser; however, the design that sailed from the rails to the border addressed the exploratory nature of a cruiser over that of the defensive role. The defensive needs of the Federation had to be addressed (as highlighted by the feline Xindi unrest of 2196-97) and rather than design a brand new battle cruiser, it was decided to adapt the Horizon and build this subclass alongside. The Federation Council released additional funds to increase the total number of cruiser hulls to twenty-six, evenly divided between exploratory and defensive types.

The Advance battle cruiser maintained the dimensions of her matriarch, but internal changes were significant. The tactical suite was rethought, with upgraded targeting systems, aft phased particle cannons swapped out to match the strength of the forward suite, and four of the forward cannon replaced by two additional photonic torpedo launchers on the dorsal saucer rim. Very little of the scientific nature of the original was retained, as most laboratories were ripped out to make space for the heavier tactical package. The shuttlebay was also re-designed to accommodate a small flight of tactical craft.

While the addition of the Advance was appreciated for the strength it provided to the "hearth world defense," there was a notable amount of disappointment with its actual battle prowess. Though military threats receded a touch in the design's initial years, when USS Sentry (NCC-1010) engaged the newly belligerent Klingons in 2209, it struggled against the aggressors and lost. The final three hulls were put on hold until the shortfalls could be addressed. Therefore, the class was limited to only ten named Advances (the hull for NCC-1023 was deemed flawed well before completion, and would be commissioned in a different subclass in 2210).

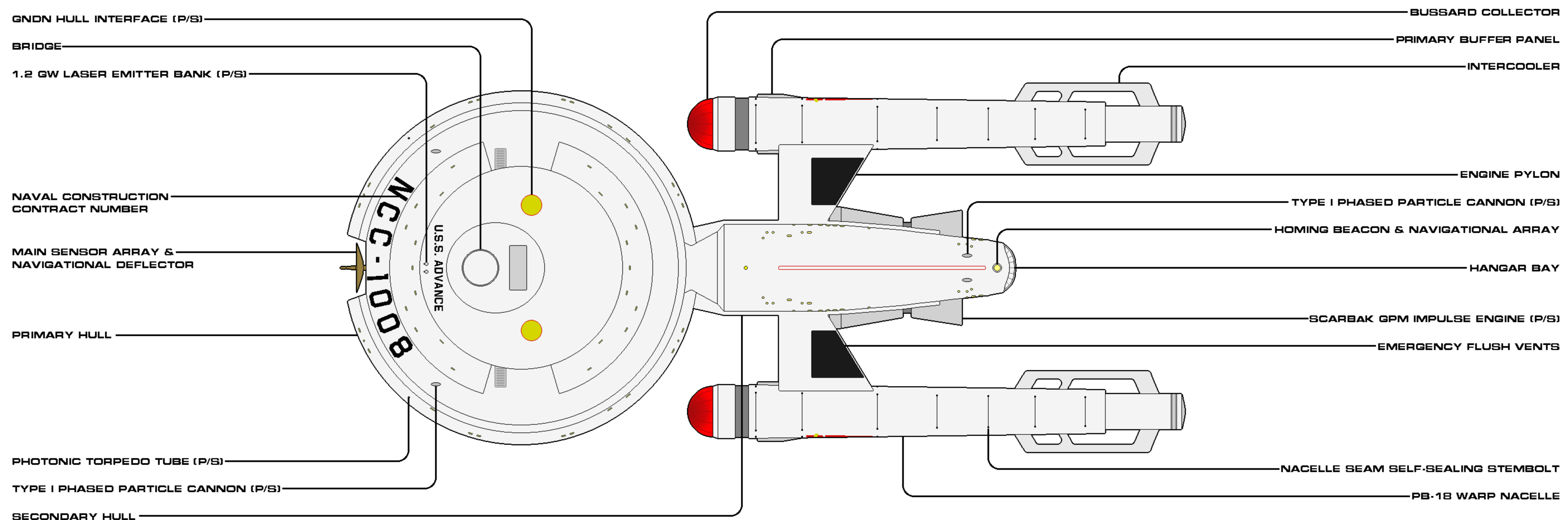
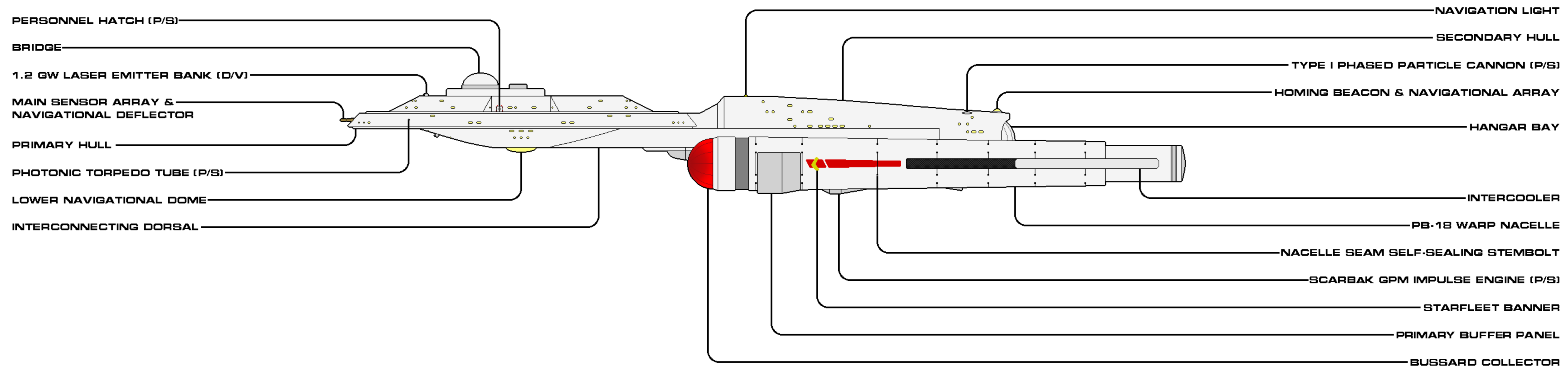

SHEET 1 OF 2

CLASS	HORIZON	CATEGORY	BATTLE CRUISER
VARIANT	ADVANCE	CONSTRUCTED	2198
LENGTH	234.1 M	BEAM	111.1 M
HEIGHT	46.0 M	MASS	566,800 MT
OPERATIONAL	9/40	RELEASE DATE	1904.01

Authorized for release by Star Fleet Bureau of Starship Construction

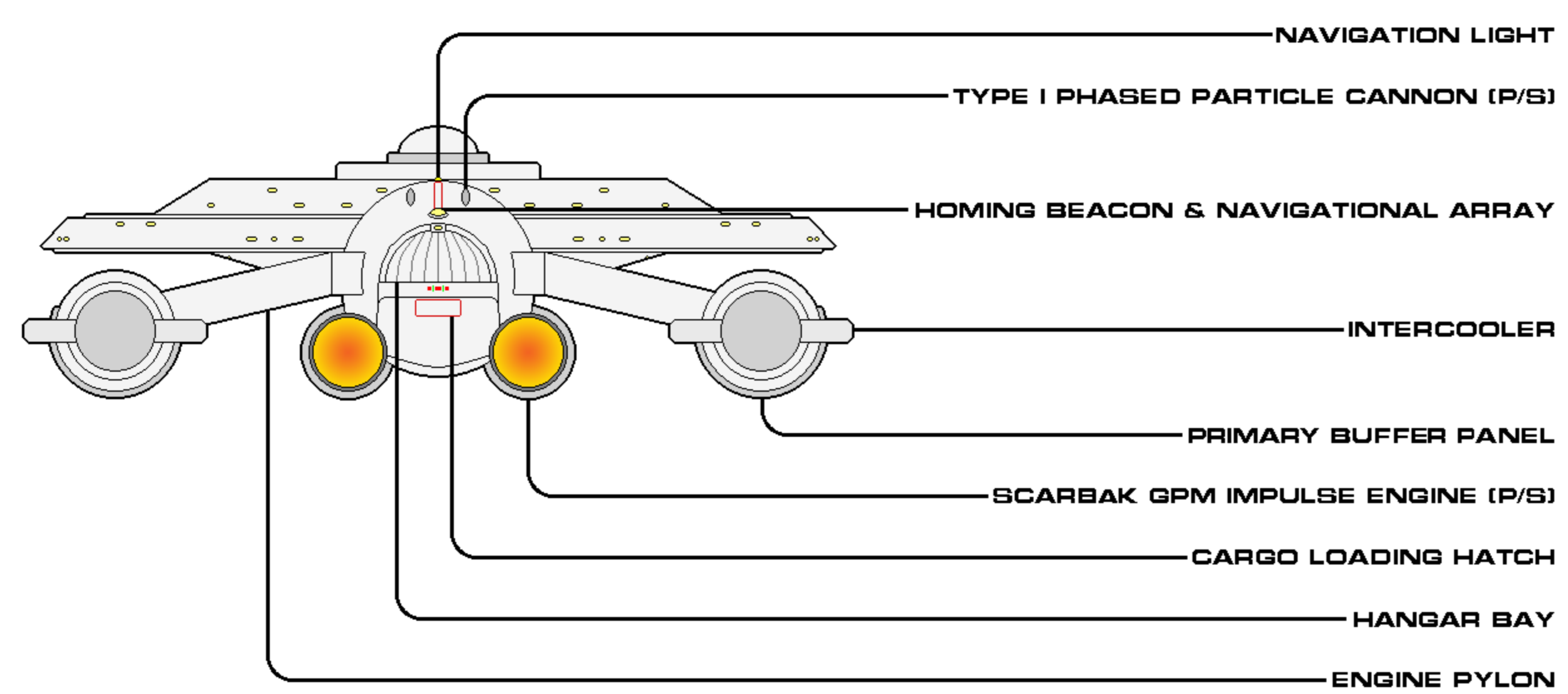
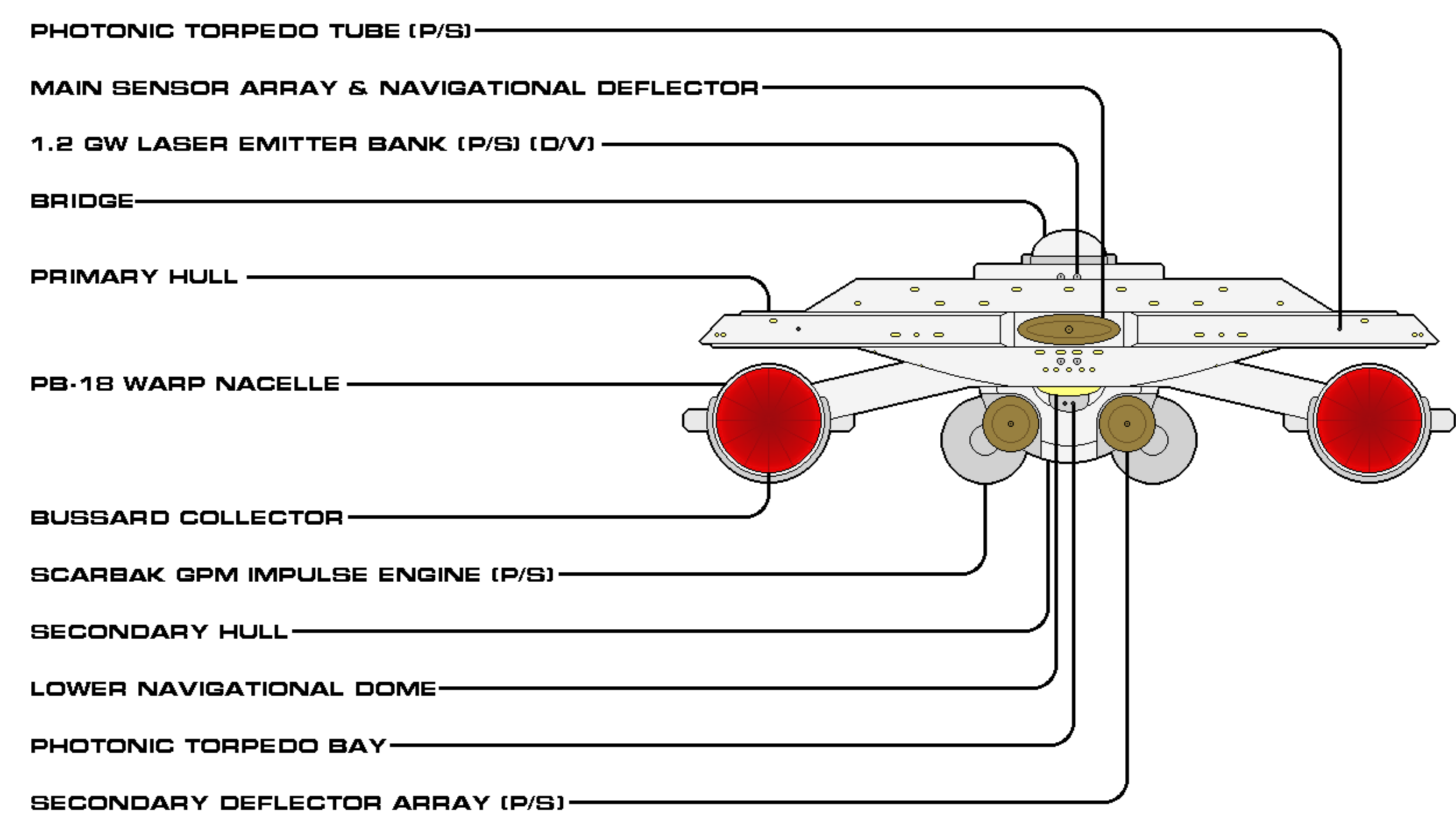
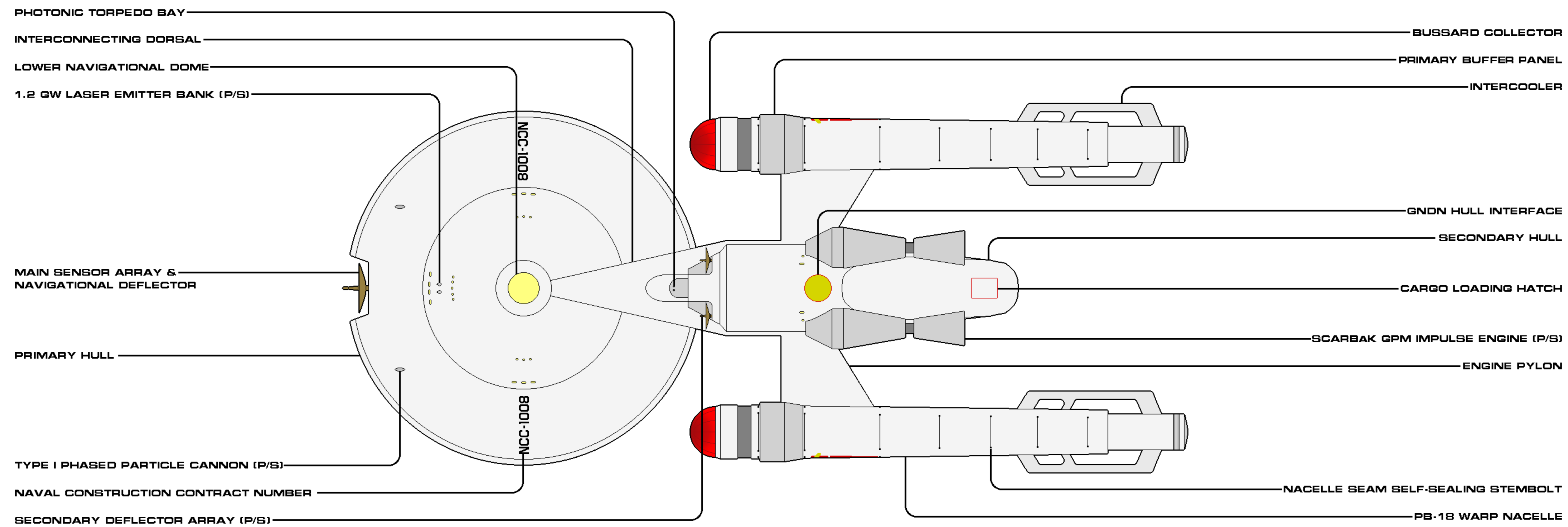

SHEET 2 OF 2

CLASS	HORIZON	CATEGORY	BATTLE CRUISER
VARIANT	ADVANCE	CONSTRUCTED	2198
LENGTH	294.1 M	BEAM	111.1 M
HEIGHT	46.0 M	MASS	566,800 MT
OPERATIONAL	9/40	RELEASE DATE	1904.01

Authorized for release by Star Fleet Bureau of Starship Construction



WHORFIN SUBCLASS

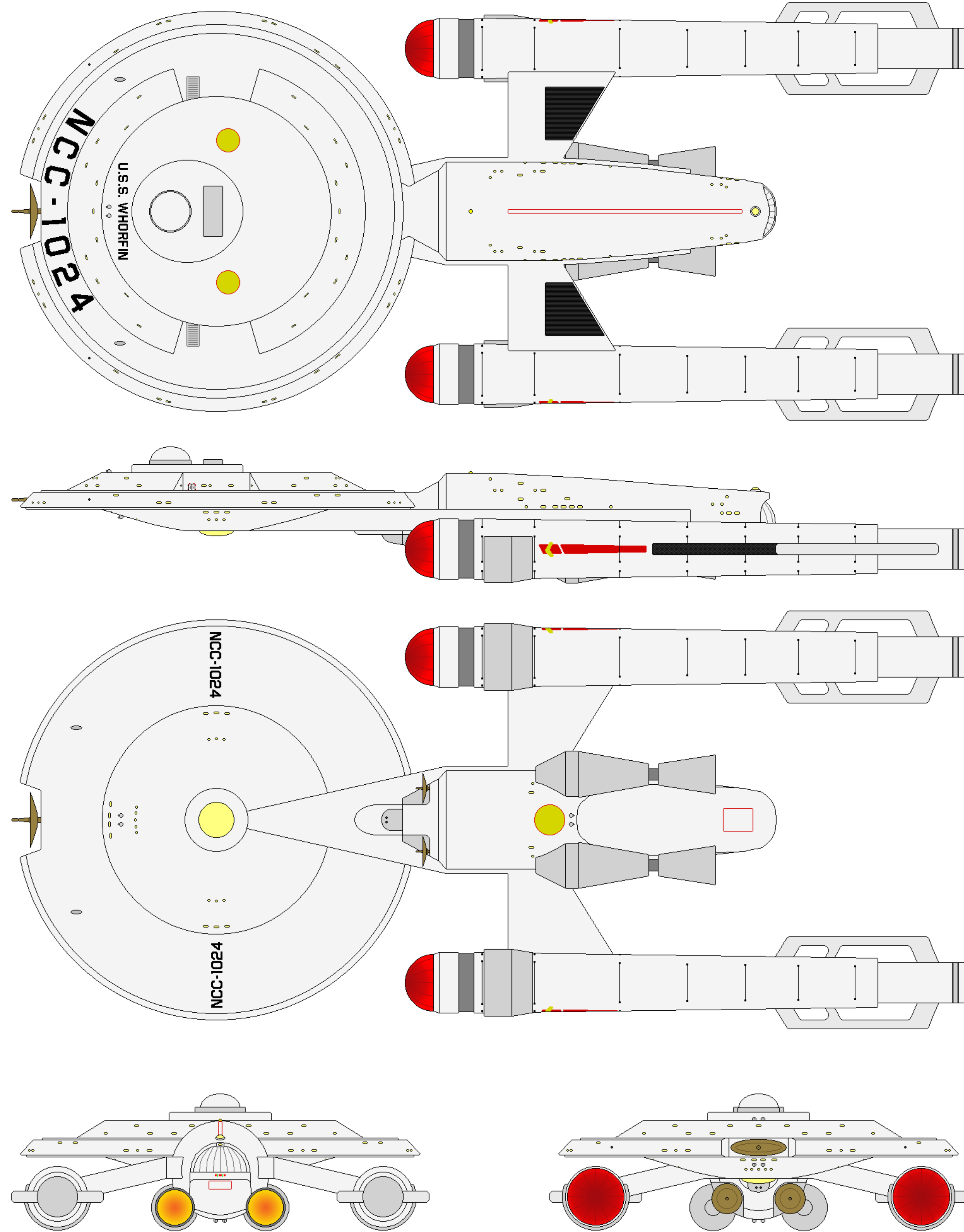

CATEGORY: BATTLE CRUISER  
 OPERATIONAL: 2210 - 2297  
 CONSTRUCTED: 3

DIMENESIONS:  
 LENGTH: 294.1 M  
 BEAM: 117.1 M  
 HEIGHT: 46.0 M  
 MASS: 569,200 MT

PERFORMANCE:  
 CRUISE: WARP 3 (OCU)  
 MAX: WARP 5.5 (OCU)  
 ENDURANCE: 2 YEARS

COMPLEMENT:  
 OFFICERS: 32  
 ENLISTED: 268

TACTICAL:  
 - 4X 1.2 GW LASER EMITTERS  
 - 2X 750 MW LASER EMITTERS  
 - 8X TYPE I (900 GW) PHASE CANNONS  
 - 4X TORPEDO TUBES  
 (W/ 240 PHOTONIC TORPEDOES)  
 - 1-LAYER CONFORMAL FORCEFIELD  
 - NAVIGATIONAL DEFLECTOR  
 - 2X AUXILIARY DEFLECTORS

AUXILIARIES:  
 - 5X LIGHT SHUTTLES  
 - 6X SUBLIGHT TACTICAL CRAFT



**WHORFIN SUBCLASS**  
AUTHORIZED CONSTRUCTION

THE FOLLOWING SHIPS OF THE ABOVE CLASS WERE AUTHORIZED AS PART OF THE FEDERATION STAR FLEET BY FEDERATION COUNCIL APPROPRIATION.

USS WHORFIN	NCC-1024	USS CAVALIER	NCC-1029
USS BIGBOOTÉ	NCC-1025		

---

GENERAL INFORMATION

The Whorfin subclass battle cruiser was the result of the resumed construction of the Advance subclass, of which further production had ceased following the analysis of the loss of USS Sentry to Klingons in 2209. The external changes were limited; visual inspection of one (of only three) of the variants would often result in mistaken identification as an Advance or even an Horizon. Internally, however, the chance to improve upon the tactical effectiveness of the battle cruiser led to changes in the power routing (specifically the energy weapons), protection (shielding and electronic warfare systems), and sturdier internal structures. The aft-facing phased particle cannons were removed, with two laser emplacements added to the ventral side of the secondary hull.

While the original nine Advances would not see the same changes provided retroactively (they would receive technological overhauls in 2218), they were retained in their original "hearth world defense" role, with their three younger sisters joining them. The upgrades proved the meddling's expense in 2229, when the USS Whorfin herself survived a Kshatriyan ambush with only light casualties, continuing on in service to the Federation (as a deep space survey cruiser over three tours), until 2297.

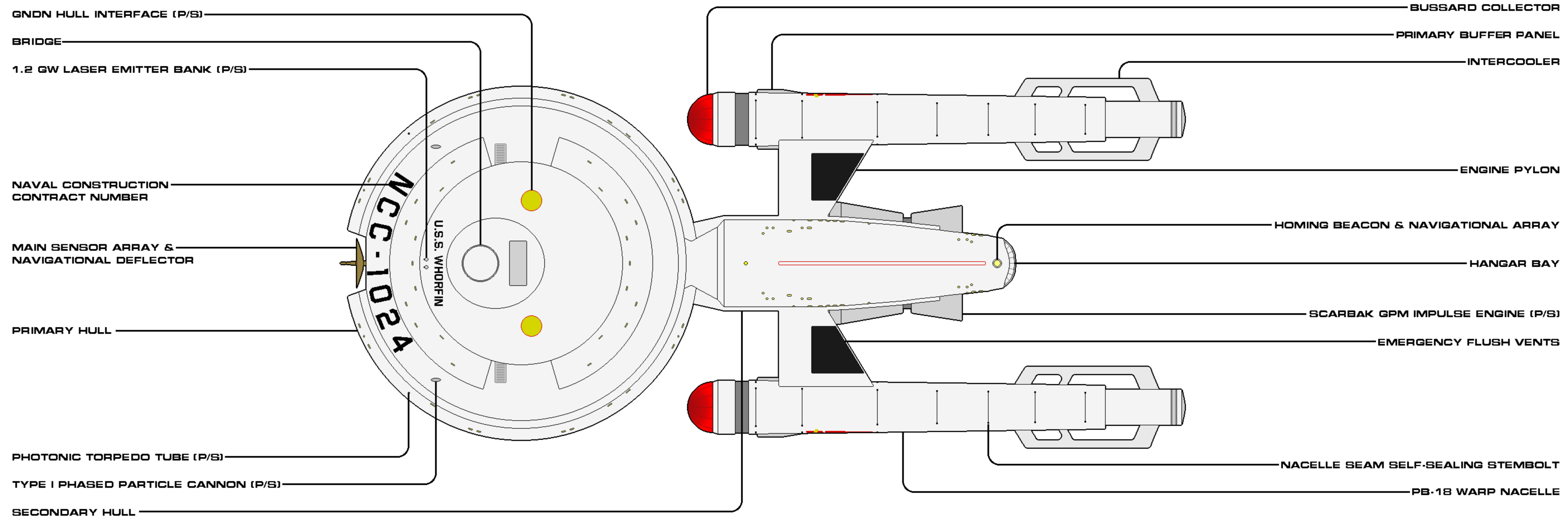
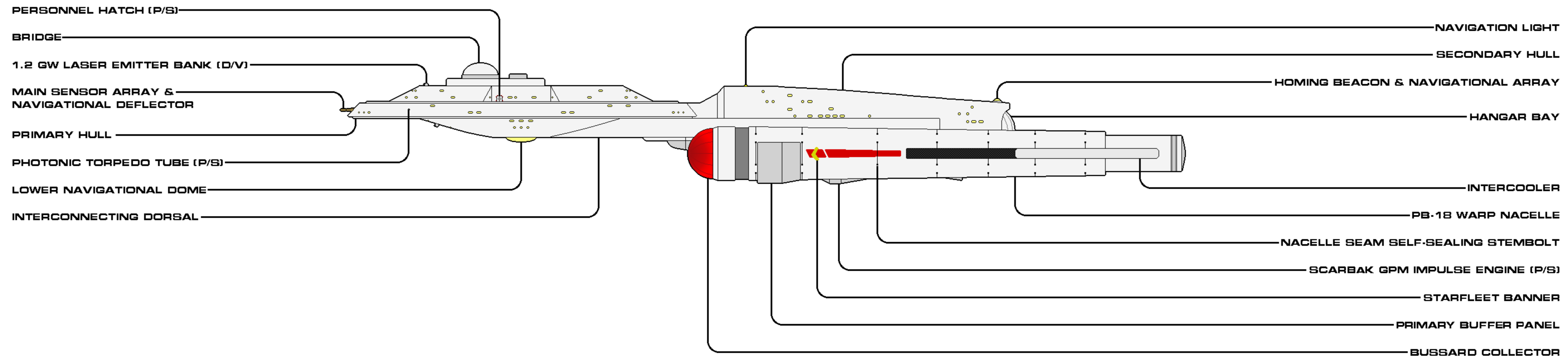

SHEET 1 OF 2

CLASS	HORIZON	CATEGORY	BATTLE CRUISER
VARIANT	WHORFIN	CONSTRUCTED	2210
LENGTH	234.1 M	BEAM	111.1 M
HEIGHT	46.0 M	MASS	500,200 MT
OPERATIONAL	3/40	RELEASE DATE	1904.01

Authorized for release by Star Fleet Bureau of Starship Construction

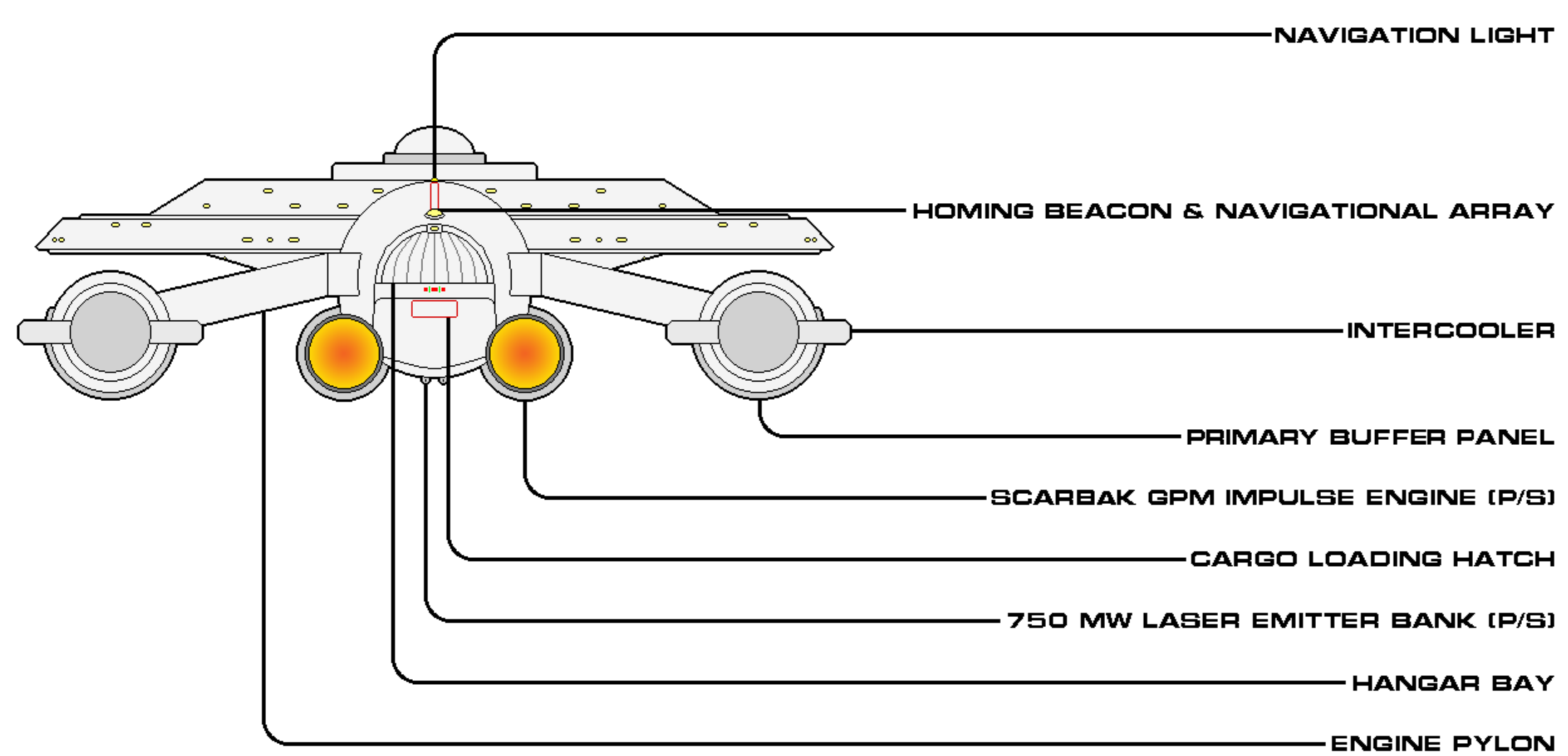
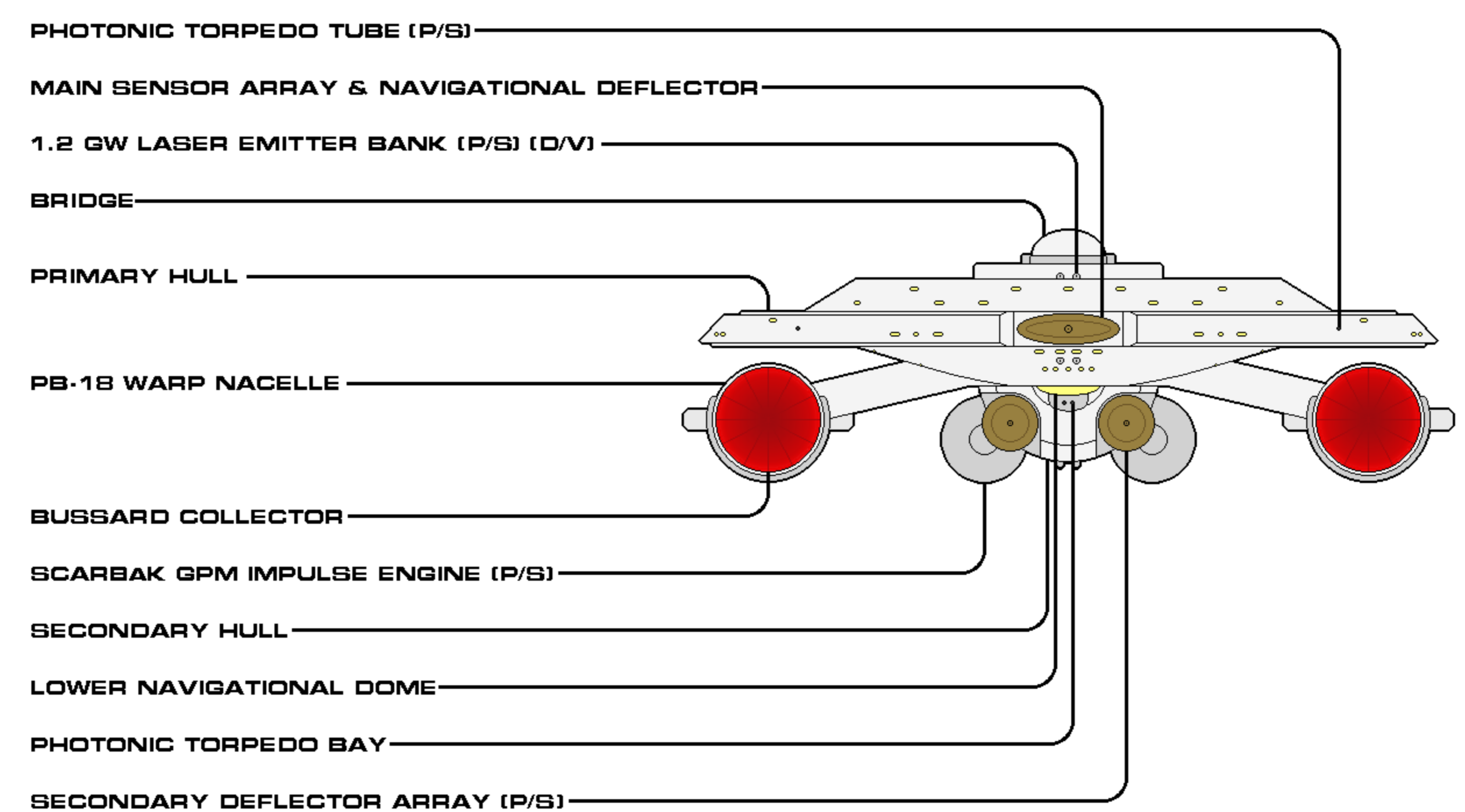
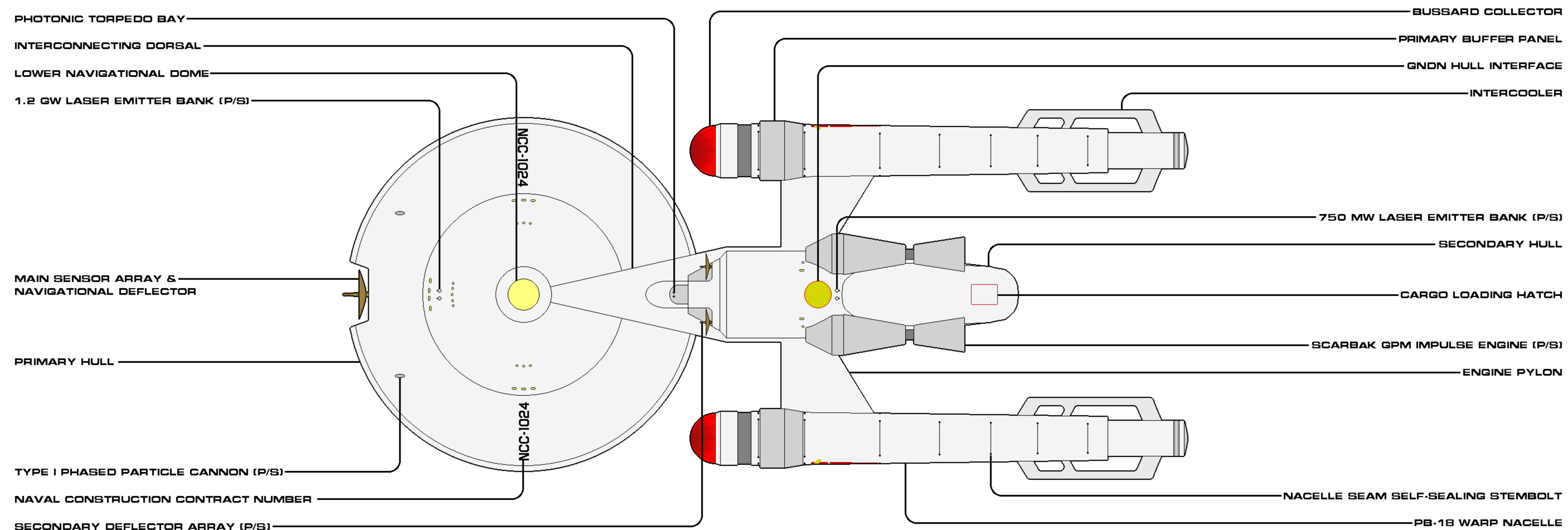

SHEET 2 OF 2

CLASS	HORIZON	CATEGORY	BATTLE CRUISER
VARIANT	WHORFIN	CONSTRUCTED	2210
LENGTH	294.1 M	BEAM	111.1 M
HEIGHT	46.0 M	MASS	569,200 MT
OPERATIONAL	3/40	RELEASE DATE	1904.01

Authorized for release by Star Fleet Bureau of Starship Construction



INDOMITABLE TESTBED

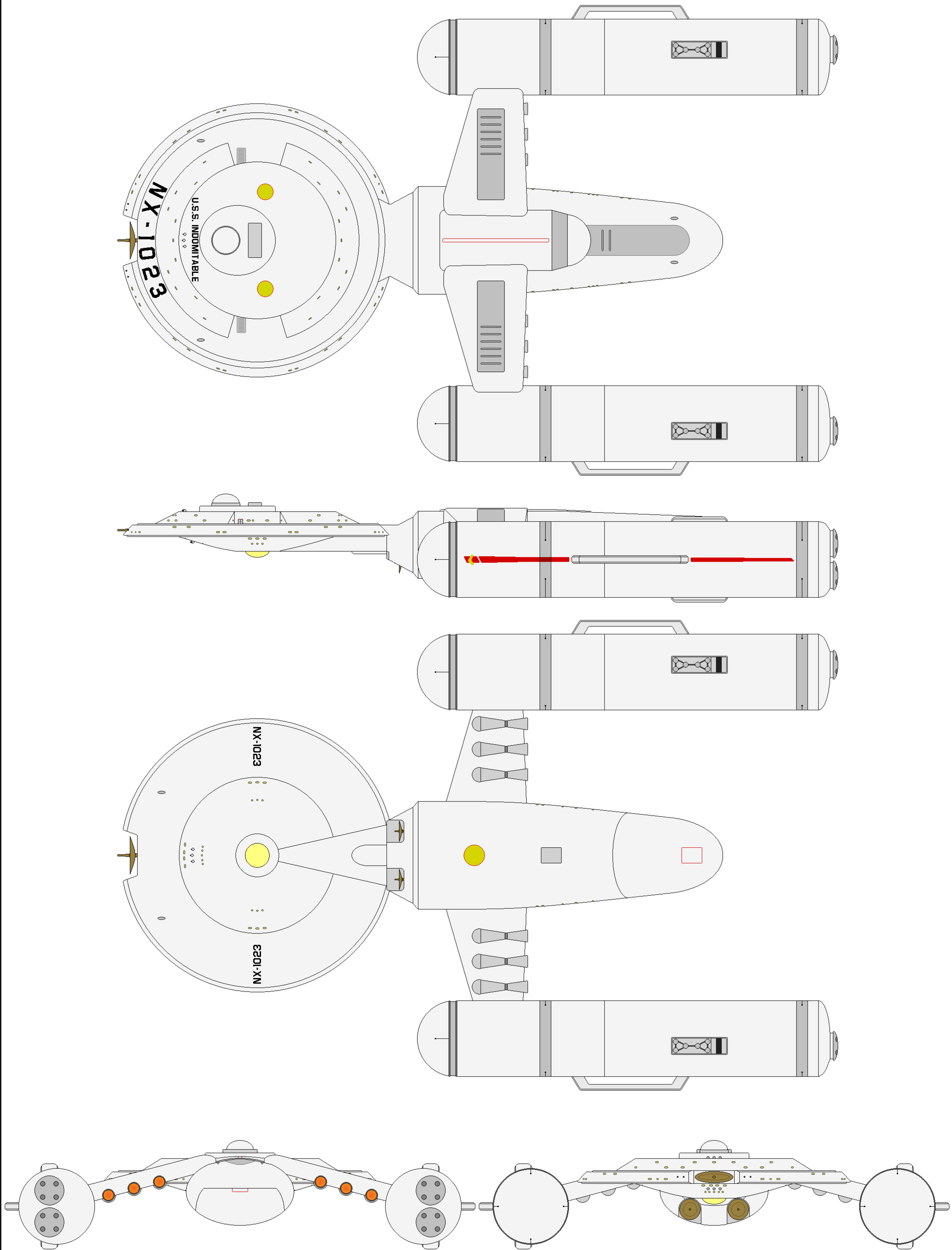





## INDOMITABLE TESTBED

CATEGORY: BATTLE CRUISER TESTBED  
OPERATIONAL: 2210 - 2212  
CONSTRUCTED: 1

### DIMENSIONS:

LENGTH: 311.8 M  
BEAM: 193.9 M  
HEIGHT: 53.2 M  
MASS: 771,000 MT

### TACTICAL:

- 6X 1.2 GW LASER EMITTERS
- 6X TYPE J (900 GW) PHASE CANNONS
- 4X TORPEDO TUBES (W/ 110 PHOTONIC TORPEDOES, 20 PROBES)
- 1-LAYER CONFORMAL FORCEFIELD
- NAVIGATIONAL DEFLECTOR
- 2X AUXILIARY DEFLECTORS

### PERFORMANCE:

CRUISE: WARP 4 (OCU)  
MAX: WARP 5.1 (OCU)  
ENDURANCE: 2 YEARS

### COMPLEMENT:

CREW: VARIED FOR TESTING

### AUXILIARIES:

- 2X LIGHT SHUTTLES
- 2X HEAVY SHUTTLES
- 4X WORKPODS

## AUTHORIZED CONSTRUCTION

THE FOLLOWING SHIPS OF THE ABOVE CLASS WERE AUTHORIZED AS PART OF THE FEDERATION STAR FLEET BY FEDERATION COUNCIL APPROPRIATION.

USS INDOMITABLE NX-1023

## GENERAL INFORMATION

The USS Indomitable battle cruiser was the one-off experimental continuation of an Advance hull that was tremendously overdue because of flaws that had gone undetected until late in the hull construction process. When USS Sentry (NCC-1010) lost its battle to the three Klingon aggressors in 2209, construction on the remaining Advance hulls was halted, and only resumed when the Whorfin subclass plans were released. The hull on NCC-1023, however, was set aside for a special purpose: an experimental upgunning intended to specifically address the emergent Klingon threat. The Indomitable hull was a fleet-management godsend, after all: an existing design could be used to rapidly develop this new battle cruiser concept without hauling an active ship off the tip of the spear, when it would be needed the most. The hull's advanced stage of construction also meant that critical shipbuilding assets would not be tied up, right when Star Fleet was considering how to pivot.

The key to this upgraded heavy cruiser design was the enormous PB-19. The 180-meter long nacelle was envisioned to push the ship to supercruise speeds. The pylons to support the nacelles were made longer and stronger, and far outside the breadth of the primary saucer. The Scarbak impulse engines of the preceding sister ships were miniaturized, with all six staggered along the two pylons, while not providing redundancy so much as impulse-capable survivability. Often lost because of and behind the massive scope of the nacelles was the significantly-lengthened secondary hull; its 140-meter length was intentional, to allow for the installation of two Mann-class SSWR-IX reactors in parallel. The tremendous amount of power provided by the two reactors meant that not only would the nacelles see the required amounts necessary for supercruise, but that enhanced shielding and an increase in the number of main lasers would also be well-supported. All the critical spaces that typically reside in the engineering hull needed to be accounted for, and that required an extension.

The weapon upgrade was seen as an unqualified success: where most Star Fleet ships sported single or dual-bank energy weapon emplacements, the Indomitable was prepared to put six 1.2 GW lasers (in two triple-banks) on any vessel "crossing the t", managed by an advanced fire control system. Those same aggressors would also have to deal with four 900 GW phased particle cannons and four forward-embedded torpedo tubes; two additional Type J cannons covered the aft quarter.

Unfortunately, the ship could not pass its warp trials: the fluctuating output of the temperamental reactors threatened to overload the electroplasma conduits that fed the thirsty nacelles. As so much hope was being placed on the upgraded cruiser, its frequent emergency down-warping was a common end result of any one trial, as witnessed plenty of times by the tailing Texas-class USS Altay (NCC-911). Star Fleet could not risk fielding the class with such an unreliable power system.

While the ship itself would not proceed to commissioned status, much less to subclass production, the weapons integration proved useful in succeeding military ship construction and in upgrade programs, including that of the various Horizon subclasses. The elongated secondary hull would also be adopted and adapted by the follow-on Essex battle and Archon heavy cruiser subclasses.

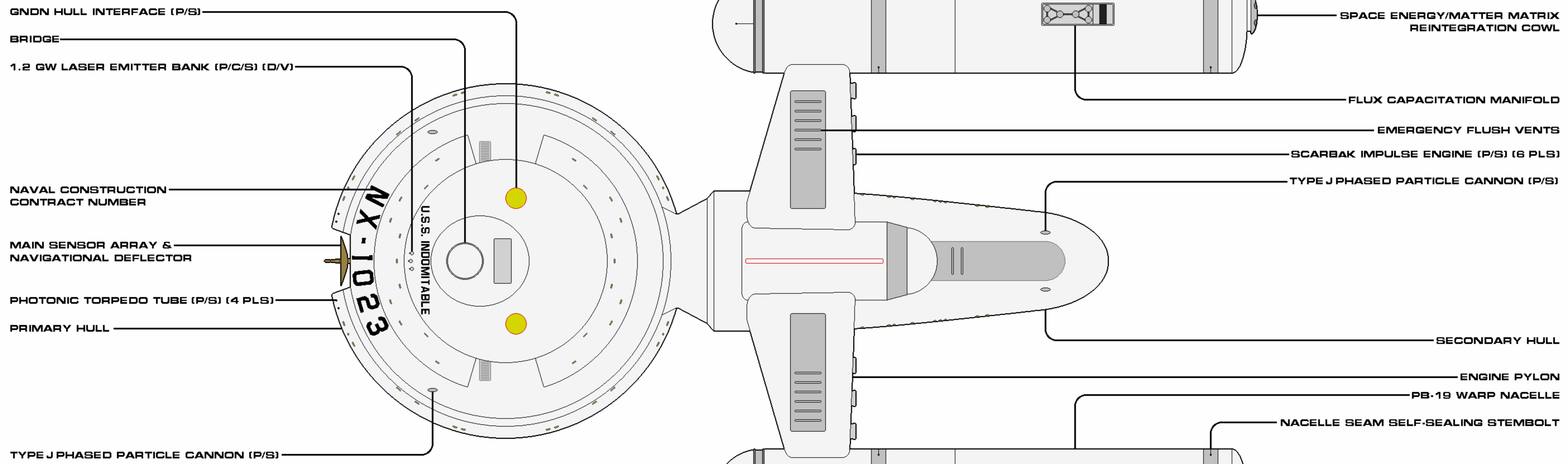
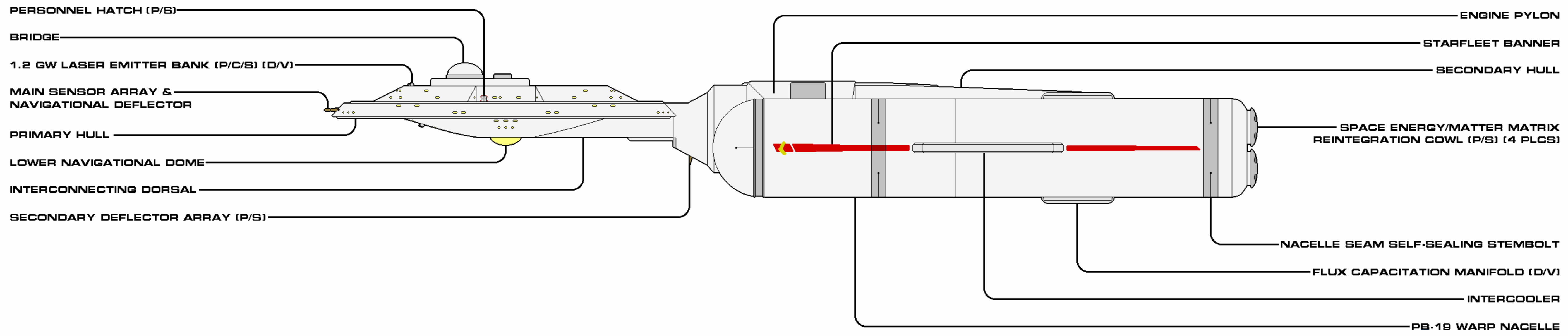

SHEET 1 OF 2

CLASS	HORIZON	CATEGORY	EXPERIMENTAL CRUISER
VARIANT	INDOMITABLE	CONSTRUCTED	2210
LENGTH	311.8 M	BEAM	133.9 M
HEIGHT	53.2 M	MASS	71,000 MT
OPERATIONAL	1/40	RELEASE DATE	1904.01

Authorized for release by Star Fleet Bureau of Starship Construction



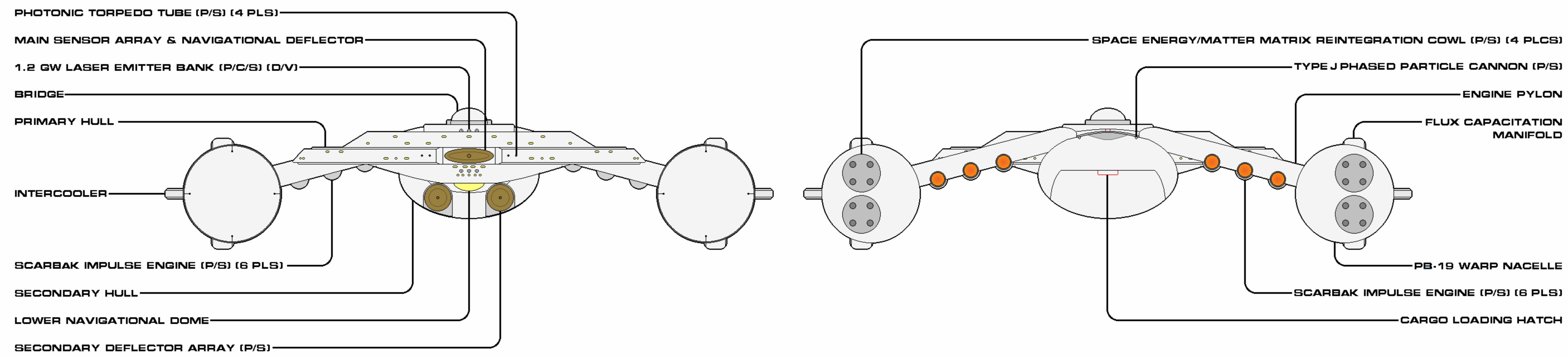
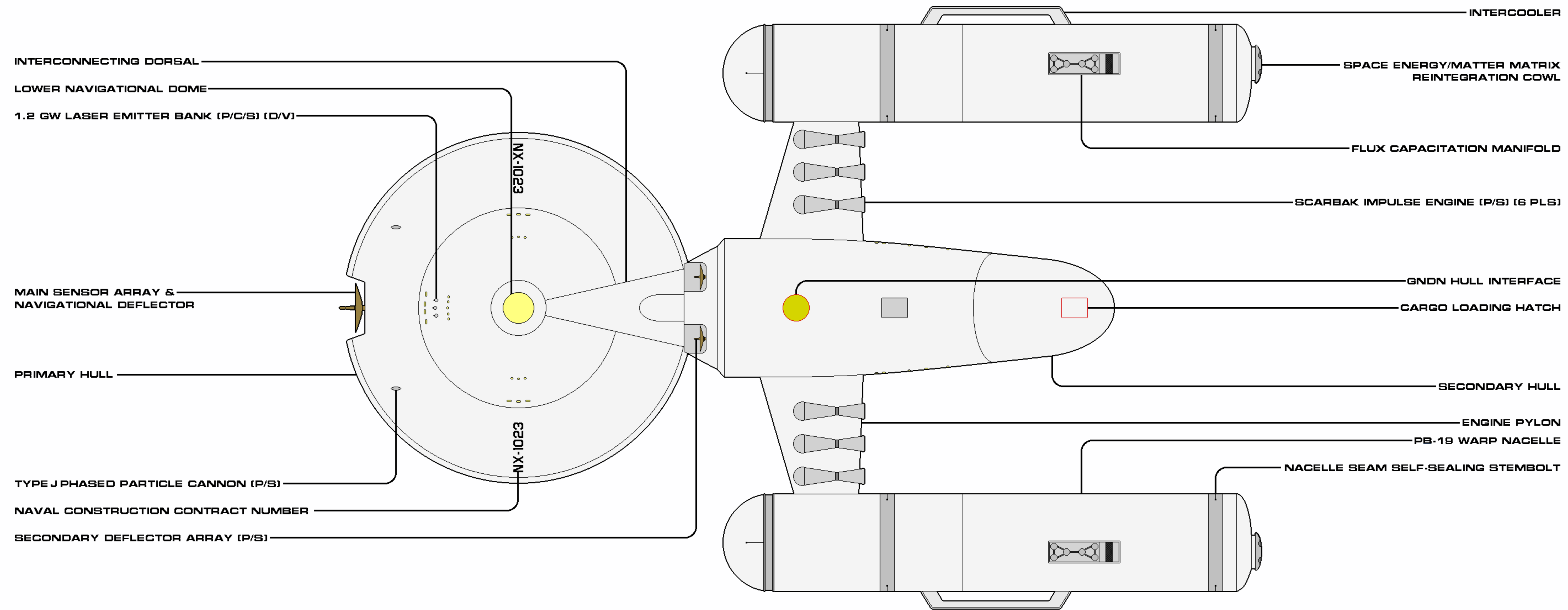

SHEET 2 OF 2

CLASS	HORIZON	CATEGORY	EXPERIMENTAL CRUISER
VARIANT	INDOMITABLE	CONSTRUCTED	2210
LENGTH	311.8 M	BEAM	193.9 M
HEIGHT	53.2 M	MASS	11,000 MT
OPERATIONAL	1/40	RELEASE DATE	1904.01

Authorized for release by Star Fleet Bureau of Starship Construction



HORIZON FLIGHT II

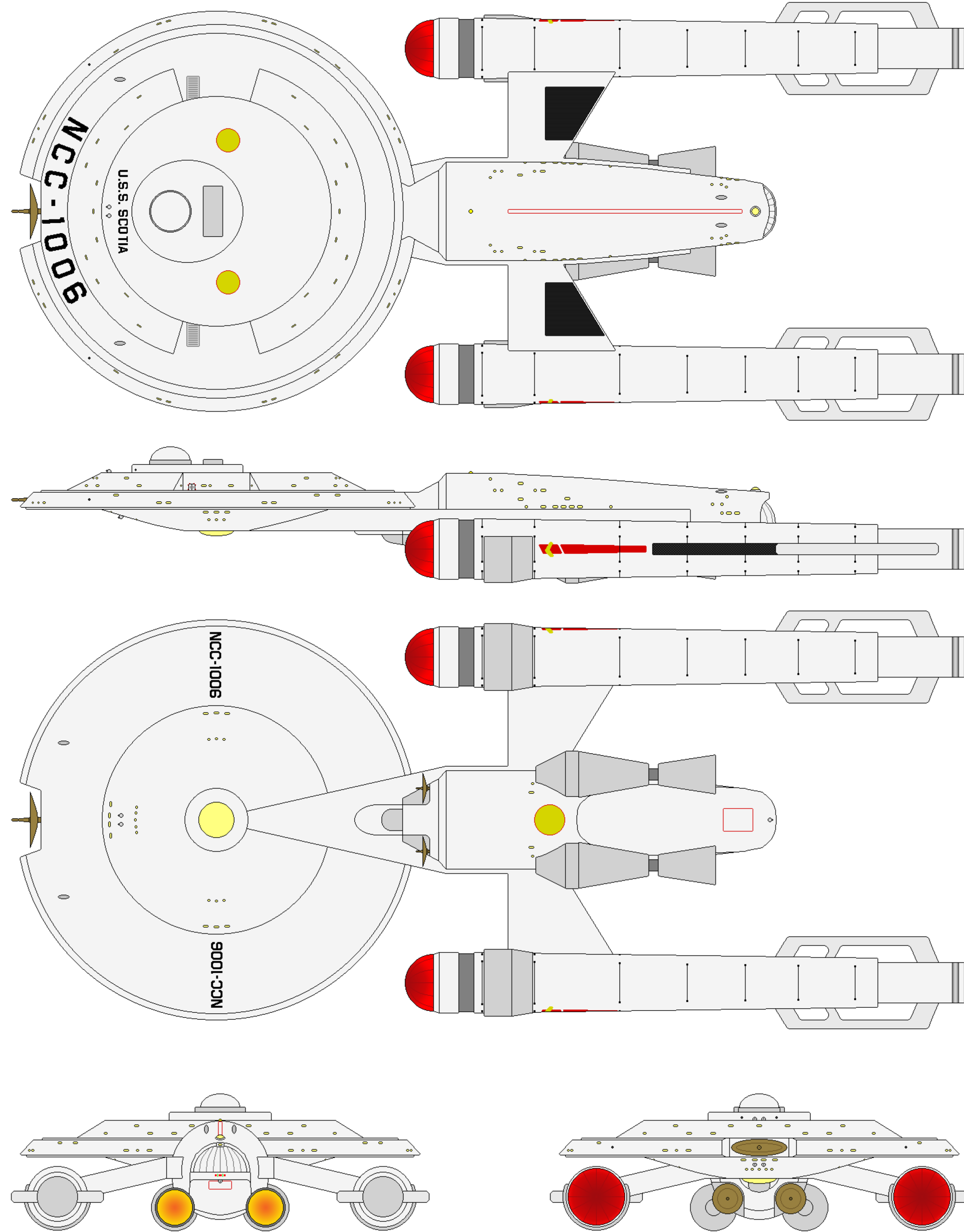

CATEGORY: HEAVY CRUISER  
 OPERATIONAL: 2218 - 2249  
 CONSTRUCTED: 13

DIMENESIONS:  
 LENGTH: 294.1 M  
 BEAM: 117.1 M  
 HEIGHT: 46.0 M  
 MASS: 563,750 MT

PERFORMANCE:  
 CRUISE: WARP 3 (OCU)  
 MAX: WARP 5.3 (OCU)  
 ENDURANCE: 4 YEARS

COMPLEMENT:  
 OFFICERS: 35  
 ENLISTED: 278

TACTICAL:  
 - 4X 1.0 GW LASER EMITTERS  
 - 1X 950 MW LASER EMITTER  
 - 6X TYPE J (900 GW) PHASE CANNONS  
 - 4X TORPEDO TUBES (W/ 110 PHOTONIC TORPEDOES, 20 PROBES)  
 - 1-LAYER CONFORMAL FORCEFIELD  
 - NAVIGATIONAL DEFLECTOR  
 - 2X AUXILIARY DEFLECTORS

AUXILIARIES:  
 - 4X HEAVY SHUTTLES  
 - 10X LIGHT SHUTTLES  
 - 6X SHUTTLEPODS



## HORIZON FLIGHT II AUTHORIZED CONSTRUCTION

THE FOLLOWING SHIPS OF THE ABOVE CLASS WERE AUTHORIZED AS PART OF THE FEDERATION STAR FLEET BY FEDERATION COUNCIL APPROPRIATION. ALL VESSELS WERE UPGRADED FROM PREVIOUS HORIZON CONFIGURATION.

USS HORIZON	NCC-1000	USS BOND	NCC-1007
USS DISCOVERY	NCC-1001	USS NIMROD	NCC-1009
USS SANTA MARIA	NCC-1002	USS METEOR	NCC-1012
USS MATHEW	NCC-1003	USS VICTORIA	NCC-1013
USS GAUSS	NCC-1004	USS NORGE	NCC-1015
USS SAN RAPHAEL	NCC-1005	USS EENDRACHT	NCC-1018
USS SCOTIA	NCC-1006		

---

### GENERAL INFORMATION

In 2193, the USS Horizon sailed from the rails, ushering in an era of serious contemplation by Star Fleet on the role of the heavy cruiser in both defense and exploration. Twenty-five years later, Star Fleet firmly understood the continuing importance the Horizon class (and its subclasses) had as a core component of the fleet. While not advancing as quickly as it would later in the century nor as fast as the Federation would have preferred, technological progress continued forward and the fleet captains for these heavy cruisers were able to successfully advocate for enhancing the capabilities of their ships. Specifically, this refit would focus on the weaponry of the original Horizon class, as well as the Advances.

Priority Number One was upgrading the hard-hitting torpedo systems. In the Horizons, the launch assemblies located in the neck bay were ripped out and replaced with an auxiliary control room (the previous, smaller, one located centrally in the neck was turned into a medical quarantine space). Now, instead of two co-located tubes, four additional ones were embedded into the primary saucer: two comprising one wide bay on the central command island and two additional ones on the forward rim of the hull. The introduction of modern forced-intermix warheads allowed for these separated locations to make use of specialized antimatter storage, rather than utilize the AM conduit that fed directly into the matter/antimatter reaction assembly in the engineering spaces. To make some room for these rim-embedded launchers, four phased particle cannons were removed; the remaining six were given better surge suppressors, for 20% overcharging (Type J). An additional 950 MW laser emitter was placed on the ventral side of the secondary hull, right below the hanger bay; the entire laser fire control was upgraded to the Indomitable standard.

To help the fleet managers differentiate the capabilities of the modified ships over those awaiting the refit, they were designated as Flight II Horizons.

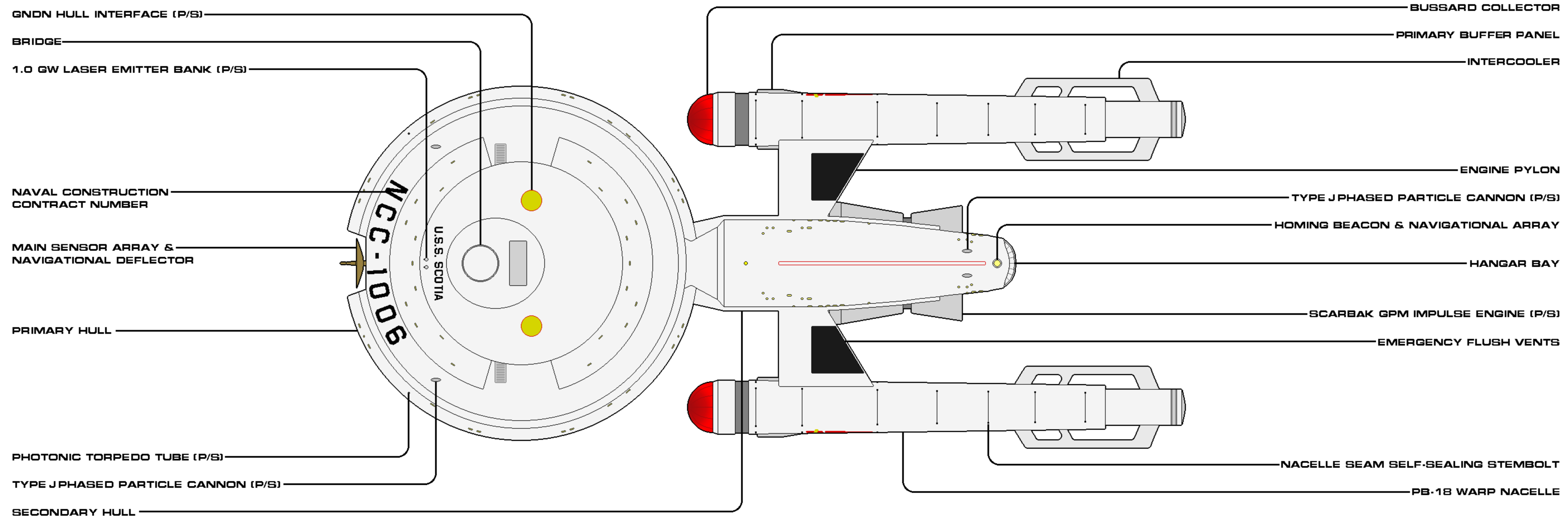
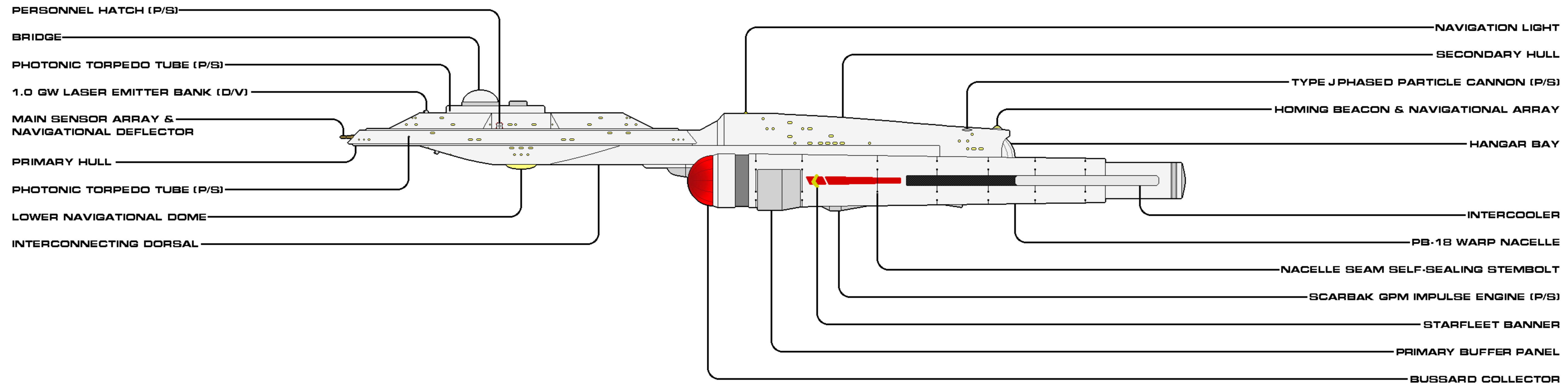

SHEET 1 OF 2

CLASS	HORIZON	CATEGORY	HEAVY CRUISER
VARIANT	FLIGHT II	CONSTRUCTED	2218
LENGTH	234.1 M	BEAM	111.1 M
HEIGHT	46.0 M	MASS	563,750 MT
OPERATIONAL	13/40	RELEASE DATE	1904.01

Authorized for release by Star Fleet Bureau of Starship Construction

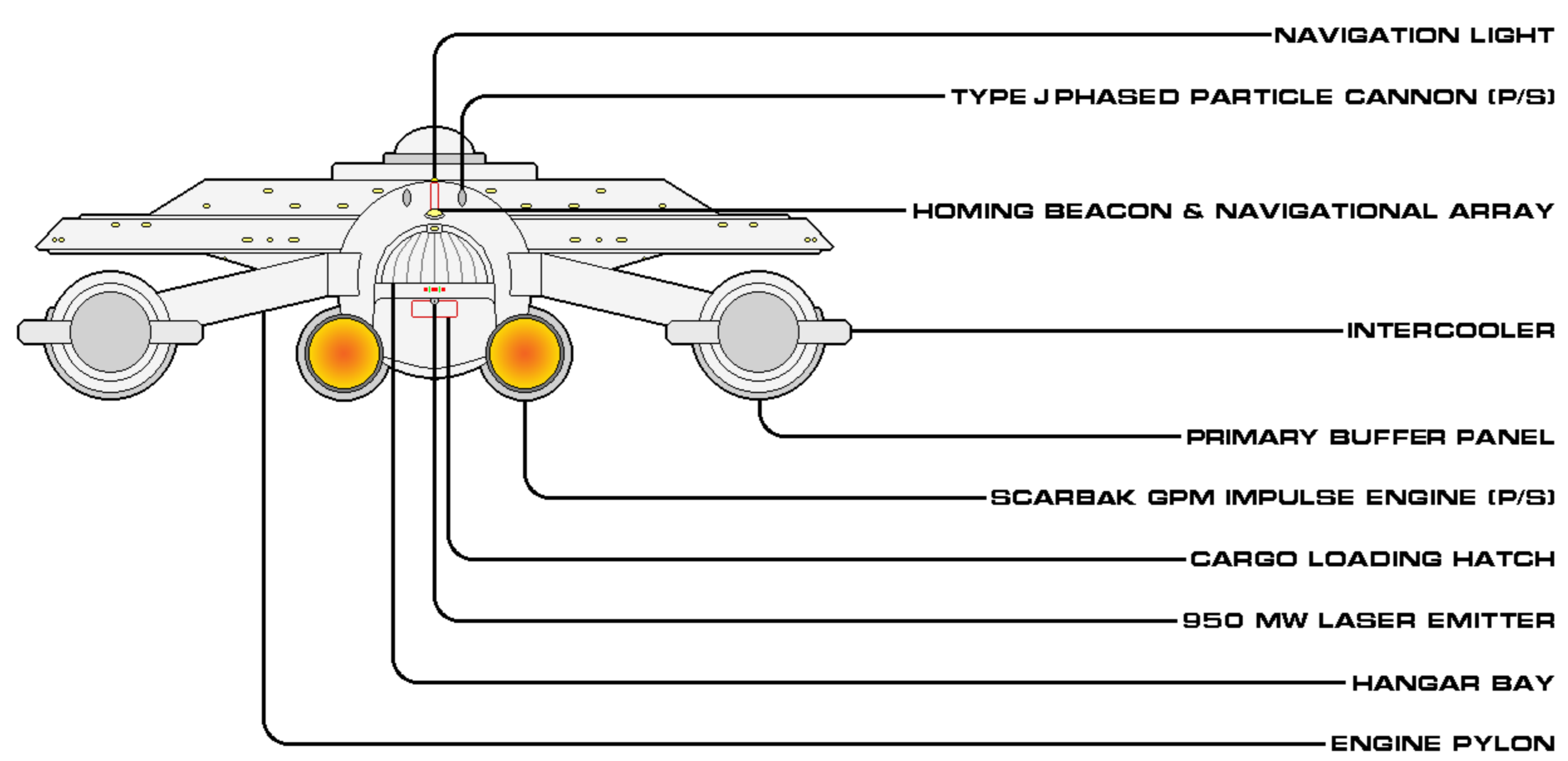
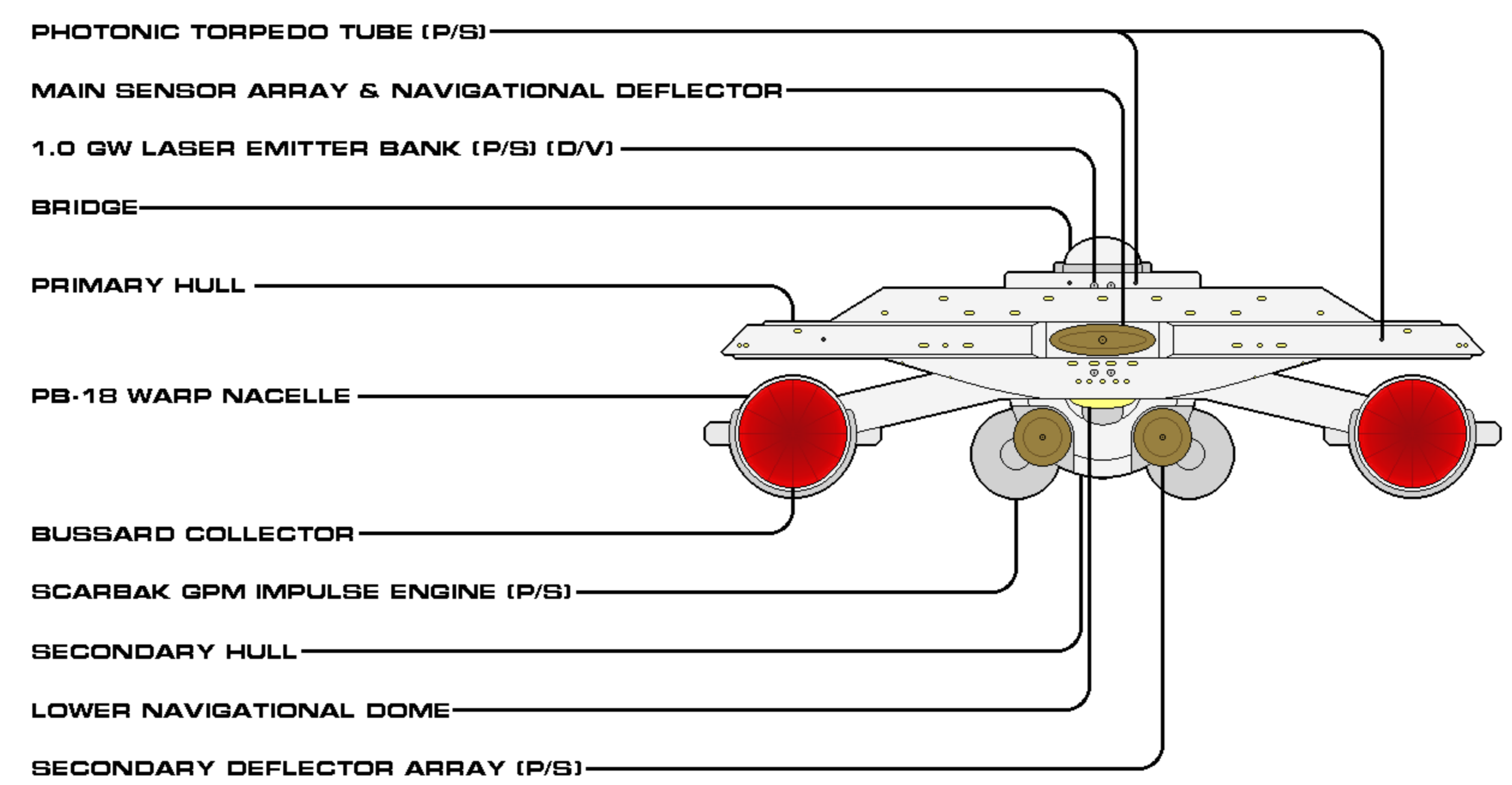
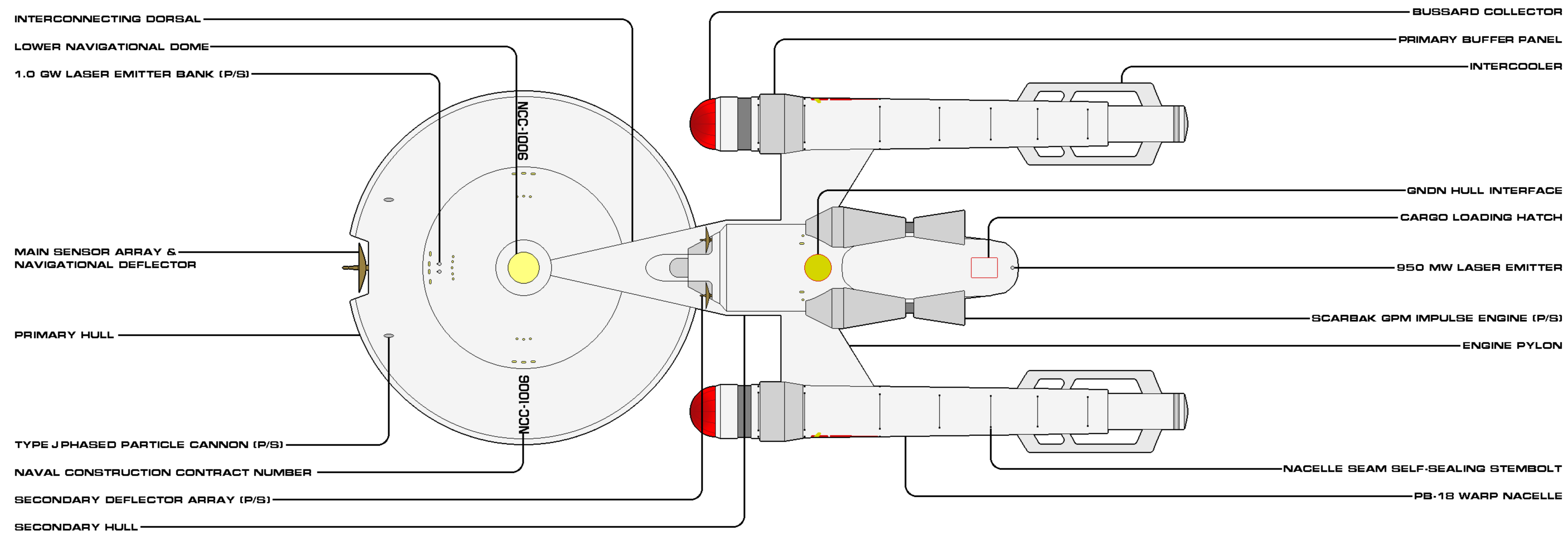

SHEET 2 OF 2

CLASS	HORIZON	CATEGORY	HEAVY CRUISER
VARIANT	FLIGHT II	CONSTRUCTED	2218
LENGTH	294.1 M	BEAM	111.1 M
HEIGHT	46.0 M	MASS	563,750 MT
OPERATIONAL	13/40	RELEASE DATE	1904.01

Authorized for release by Star Fleet Bureau of Starship Construction





ADVANCE FLIGHT II

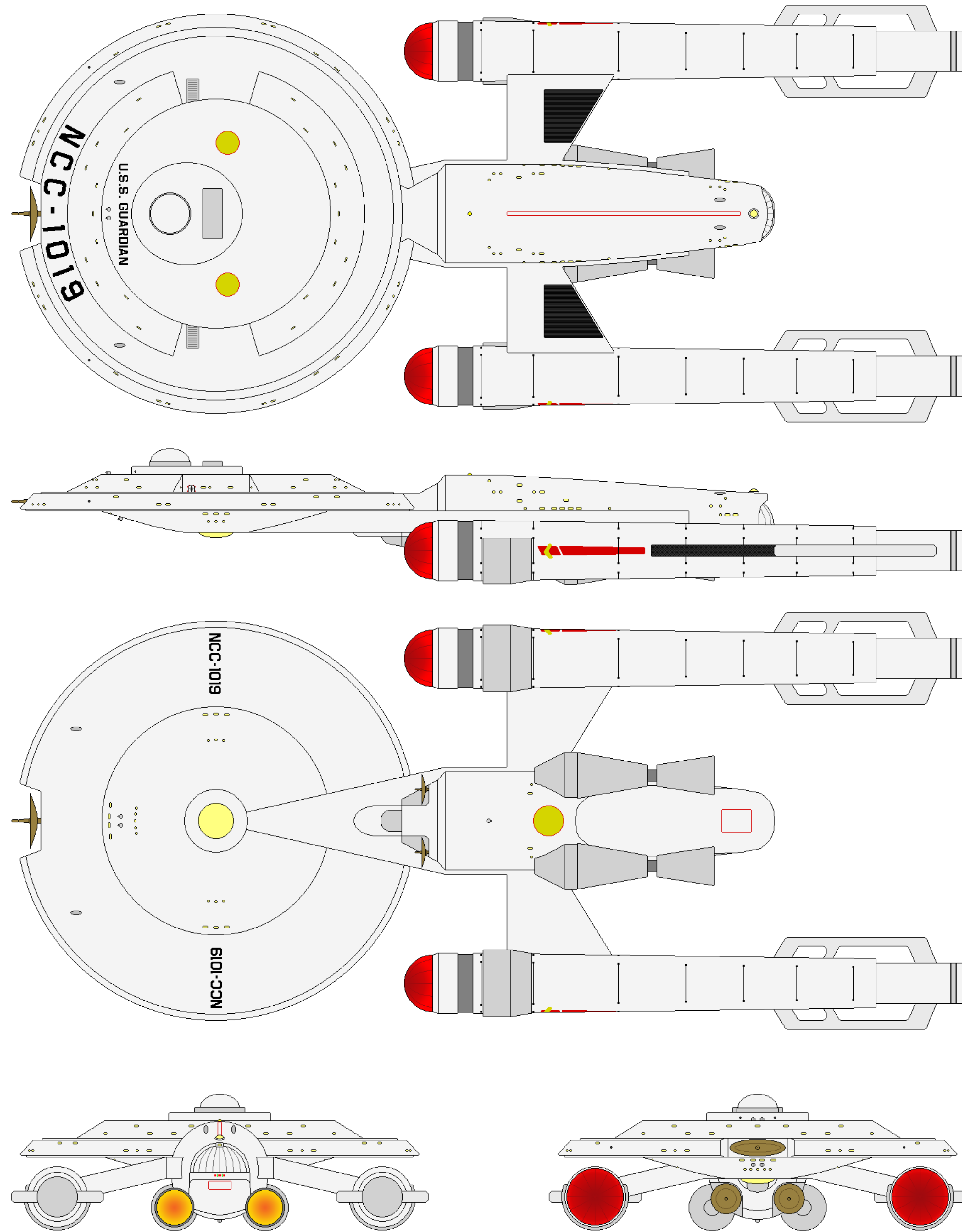

CATEGORY: BATTLE CRUISER  
 OPERATIONAL: 2218 - 2258  
 MODIFIED: 9

DIMENESIONS:  
 LENGTH: 294.1 M  
 BEAM: 117.1 M  
 HEIGHT: 46.0 M  
 MASS: 567,750 MT

PERFORMANCE:  
 CRUISE: WARP 3 (OCU)  
 MAX: WARP 5.5 (OCU)  
 ENDURANCE: 2 YEARS

COMPLEMENT:  
 OFFICERS: 32  
 ENLISTED: 268

TACTICAL:  
 - 4X 1.0 GW LASER EMITTERS  
 - 1X 950 MW LASER EMITTER  
 - 6X TYPE J (900 GW) PHASE CANNONS  
 - 4X TORPEDO TUBES (W/ 110 PHOTONIC TORPEDOES, 20 PROBES)  
 - 1-LAYER CONFORMAL FORCEFIELD  
 - NAVIGATIONAL DEFLECTOR  
 - 2X AUXILIARY DEFLECTORS

AUXILIARIES:  
 - 5X LIGHT SHUTTLES  
 - 6X SUBLIGHT TACTICAL CRAFT





**ADVANCE FLIGHT II**  
AUTHORIZED CONSTRUCTION

THE FOLLOWING SHIPS OF THE ABOVE CLASS WERE AUTHORIZED AS PART OF THE FEDERATION STAR FLEET BY FEDERATION COUNCIL APPROPRIATION. ALL VESSELS WERE UPGRADED FROM PREVIOUS ADVANCE CONFIGURATION.

USS ADVANCE	NCC-1008	USS GUARDIAN	NCC-1019
USS GLADIATOR	NCC-1011	USS ARDENT	NCC-1020
USS GOLDEN HIND	NCC-1014	USS DEXTROUS	NCC-1021
USS HALF MOON	NCC-1016	USS WARRIOR	NCC-1022
USS CONSTELLATION	NCC-1017		

In 2218, the Advance subclass battlecruiser, along with the primary Horizon class, entered drydocks for an upgrade period focused specifically on enhancing the tactical suite. For the Advances, that meant replacing the torpedo bay located in the 'neck' of the ship with an auxiliary control room (the previous, smaller one located centrally in the neck was turned into a trauma ward). Space was cleared out of the command island for a newer torpedo bay designed around modern forced-intermix warheads, and the two individual bays already present on the saucer rim were also upgraded. The phased particle cannons were replaced by newer models (Type J) that made use of better surge suppressors for 20% overcharging. An additional 950 MW laser emitter was placed on the ventral side of the secondary hull, forward of the GNDN interface; the entire laser fire control was upgraded to the Indomitable standard. Interestingly enough, the main battery of lasers (forward saucer, dorsal and ventral) were downgraded from 1.2 GW to 1.0 GW, for better heat management (which had been impacting the life span of the emitter coils and lenses).

To help the fleet managers differentiate the capabilities of the modified ships over those awaiting the refit, the ships were designated as Flight II Advances. This would be the last major upgrade before this subclass was fully decommissioned in 2258 (11 years after the last Horizon Flt II was retired).

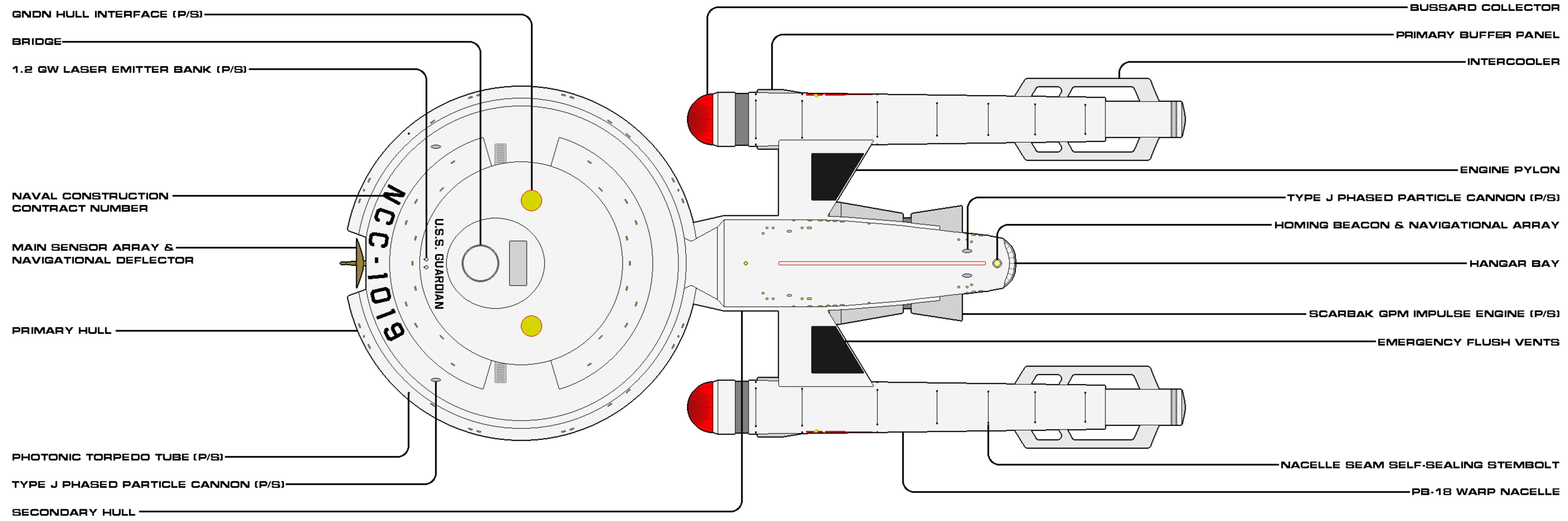
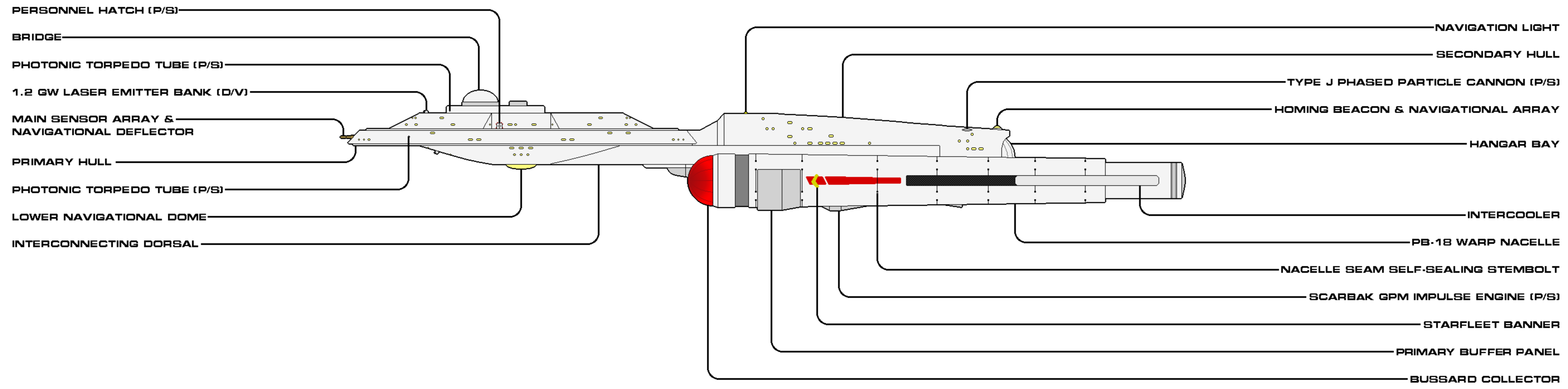

SHEET 1 OF 2

CLASS	HORIZON	CATEGORY	BATTLE CRUISER
VARIANT	ADVANCE FLT II	CONSTRUCTED	2218
LENGTH	234.1 M	BEAM	111.1 M
HEIGHT	46.0 M	MASS	561,750 MT
OPERATIONAL	9/40	RELEASE DATE	1904.01

Authorized for release by Star Fleet Bureau of Starship Construction

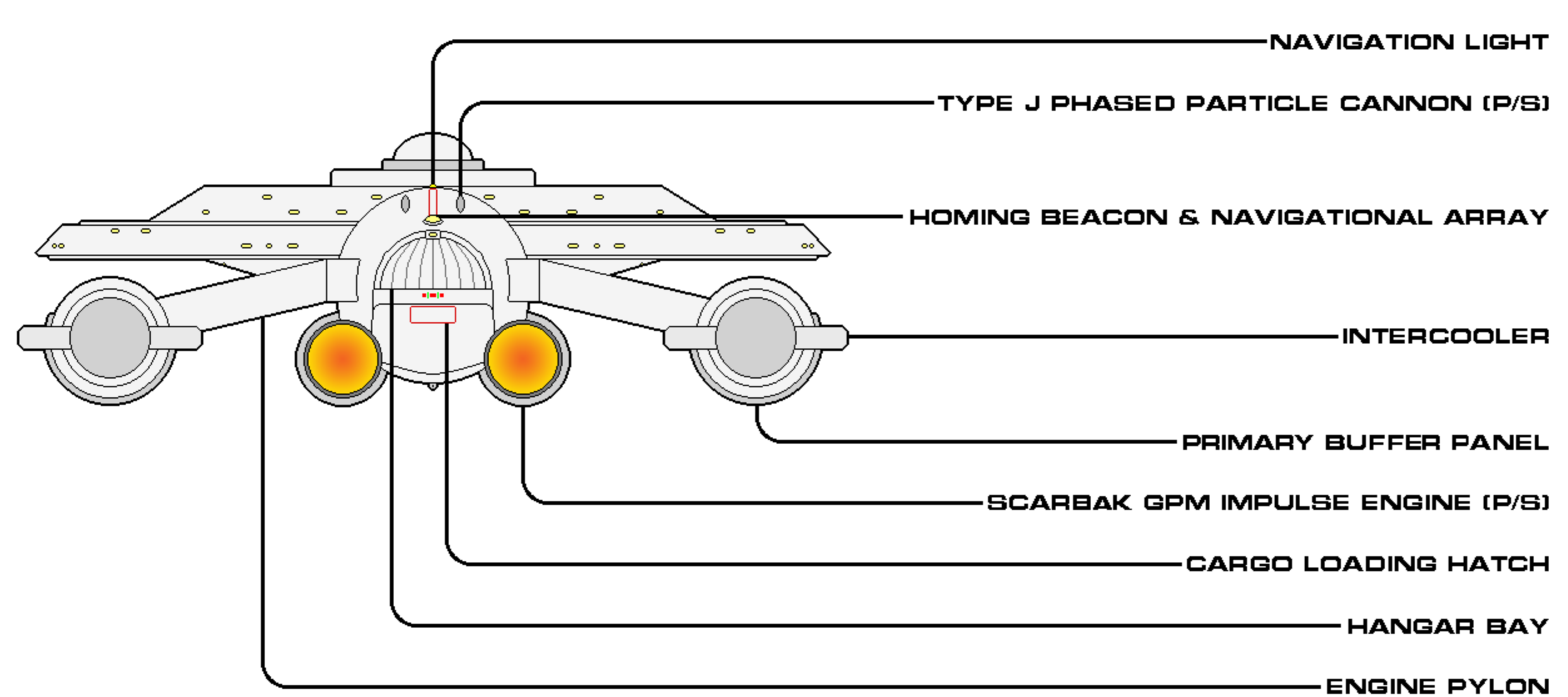
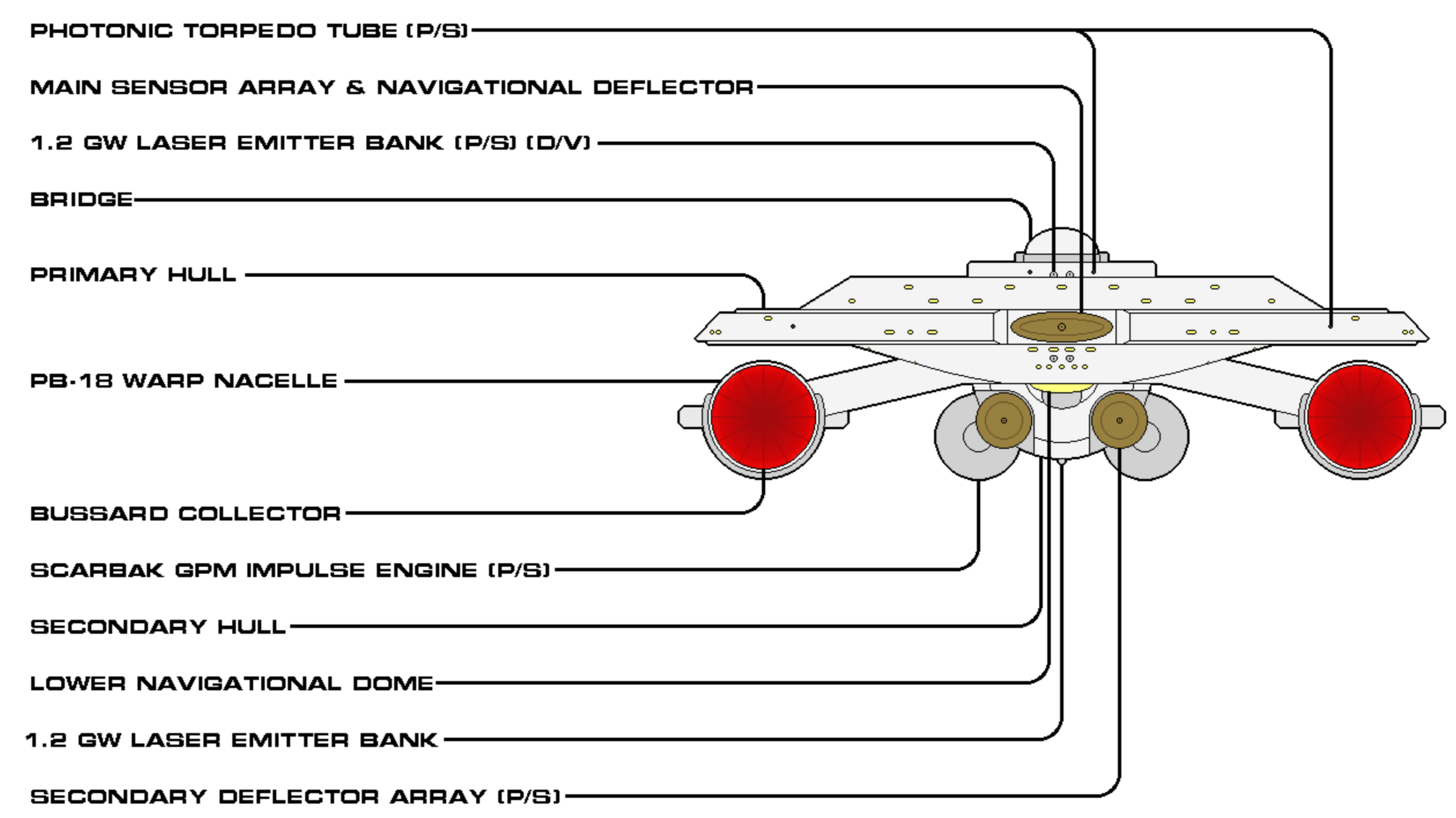
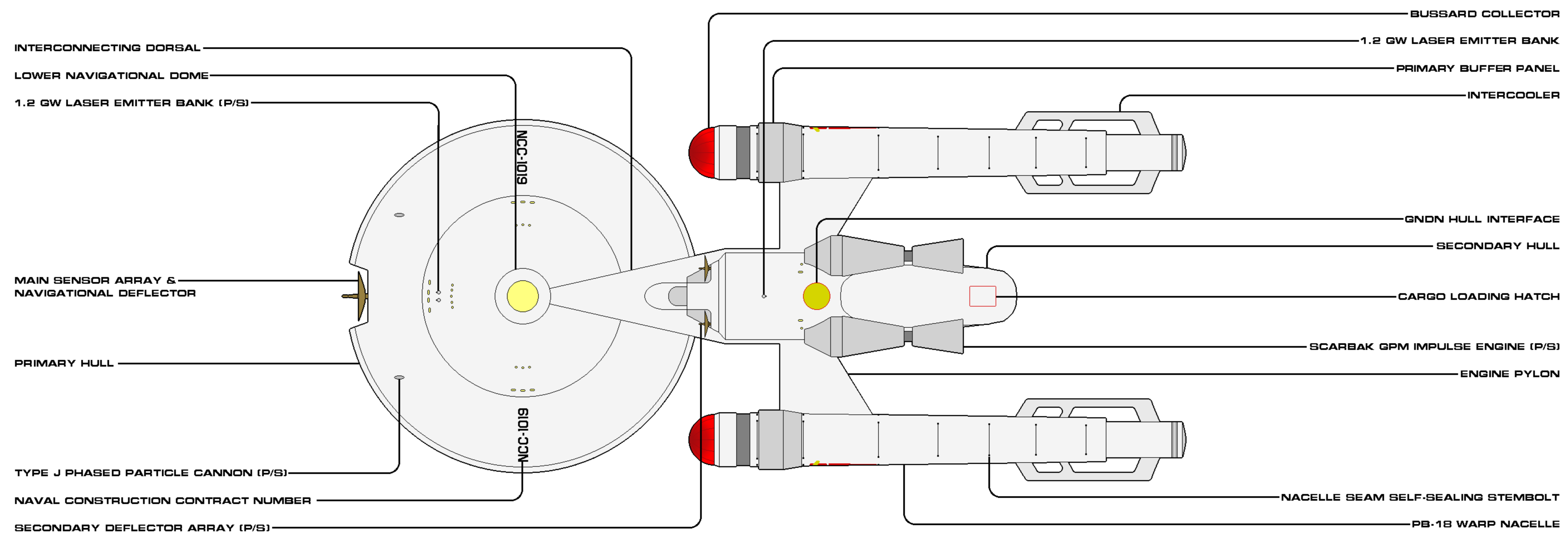

SHEET 2 OF 2

CLASS	HORIZON	CATEGORY	BATTLE CRUISER
VARIANT	ADVANCE FLT II	CONSTRUCTED	2218
LENGTH	294.1 M	BEAM	111.1 M
HEIGHT	46.0 M	MASS	561,150 MT
OPERATIONAL	9/40	RELEASE DATE	1904.01

Authorized for release by Star Fleet Bureau of Starship Construction





ESSEX SUBCLASS

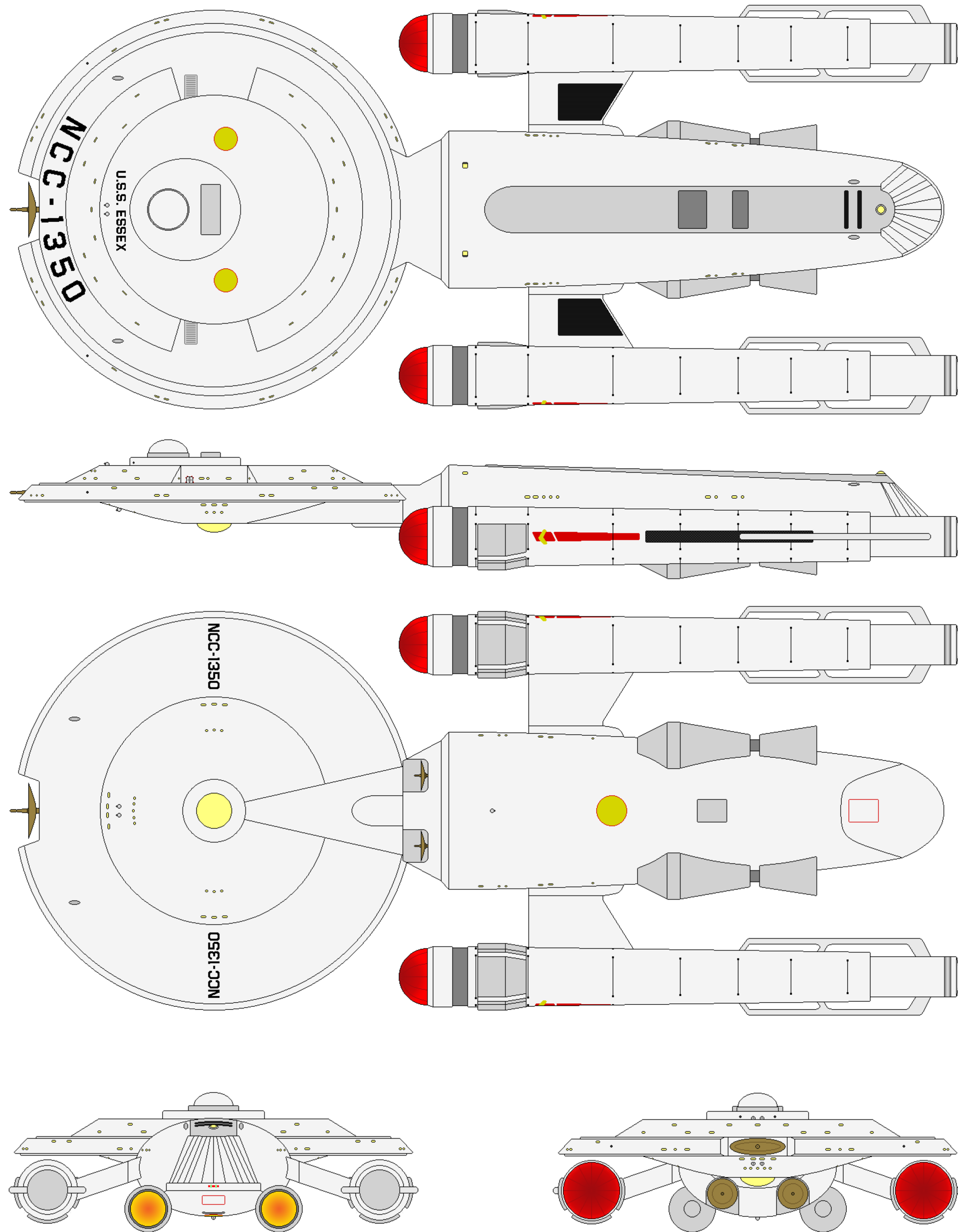

CATEGORY: BATTLE CRUISER  
 OPERATIONAL: 2222 - 2251  
 CONSTRUCTED: 7

DIMENESIONS:  
 LENGTH: 294.1 M  
 BEAM: 117.1 M  
 HEIGHT: 46.0 M  
 MASS: 578,500 MT

PERFORMANCE:  
 CRUISE: WARP 3 (OCU)  
 MAX: WARP 5.5 (OCU)  
 ENDURANCE: 3 YEARS

COMPLEMENT:  
 OFFICERS: 32  
 ENLISTED: 289

TACTICAL:  
 - 4X 1.0 GW LASER EMITTERS  
 - 1X 950 MW LASER EMITTER  
 - 6X TYPE J (900 GW) PHASE CANNONS  
 - 4X TORPEDO TUBES (W/ 110 PHOTONIC TORPEDOES, 20 PROBES)  
 - 1-LAYER CONFORMAL FORCEFIELD  
 - NAVIGATIONAL DEFLECTOR  
 - 2X AUXILIARY DEFLECTORS

AUXILIARIES:  
 - 5X LIGHT SHUTTLES  
 - 6X SUBLIGHT TACTICAL CRAFT



**ESSEX SUBCLASS**  
AUTHORIZED CONSTRUCTION

THE FOLLOWING SHIPS OF THE ABOVE CLASS WERE AUTHORIZED AS PART OF THE FEDERATION STAR FLEET BY FEDERATION COUNCIL APPROPRIATION.

USS ESSEX	NCC-1350	USS REPRISAL	NCC-1354
USS PRINCETON	NCC-1351	USS CABOT	NCC-1355
USS SABLE	NCC-1352	USS MONTEREY	NCC-1356
USS WOLVERINE	NCC-1353		

---

**GENERAL INFORMATION**

Four years after the first of the veteran Horizon subclass heavy cruisers and Advance subclass battle cruisers received their Flight II upratings, newbuilds of even greater advancement were commissioned into frontline service with Star Fleet. The battle cruiser variant continued the homage to the hero vessels of the Daedalus class of the preceding generation with the U.S.S. Essex (NCC-1350), the first in this latest subclass. With the same weapons loadout of the Advance Flt IIs, as well as the same overall dimensions, a position paper about the ship would not appear to do it justice: the ship had a secondary hull design borrowed and modified from the failed Indomitable experiment, providing it an immense internal volume unavailable to its predecessors. This increased the ship's range and endurance, due to the enormous increase in fuel and supplies carried (when compared to the older, converted cruisers). The higher standard of accommodation was also appreciated by her crew. The PB-22 warp nacelle was a slight improvement on the PB-18, decreasing individual unit mass for the same performance characteristics, through more advanced (but smaller) primary buffer panels and an intercooler that maximized efficiency with increased length (but less of a physical footprint).

While the Baton Rouge class was also first commissioned in the same year (2222), the operational history of the Advance subclass allowed for instant familiarity for the Essex and her sisters, meaning the ships were at the forefront of Star Fleet's strategic defense policy for a few of their early years. However, as the more modern heavy cruisers increased their numbers and operational responsibilities, the production of the subclass was quickly slashed to seven (from the envisioned twenty). In the end, these newest of the Horizon series still failed to provide the expectations of acceleration, agility, speed, or range to meet modern military standards or ambitions. Hence, Star Fleet would consider how additional upgrades could provide boosts in power and propulsive performance, in a direct impact to what would eventually result in the Constitution class heavy cruiser of the 2240s. The last Essex would be decommissioned in 2251.

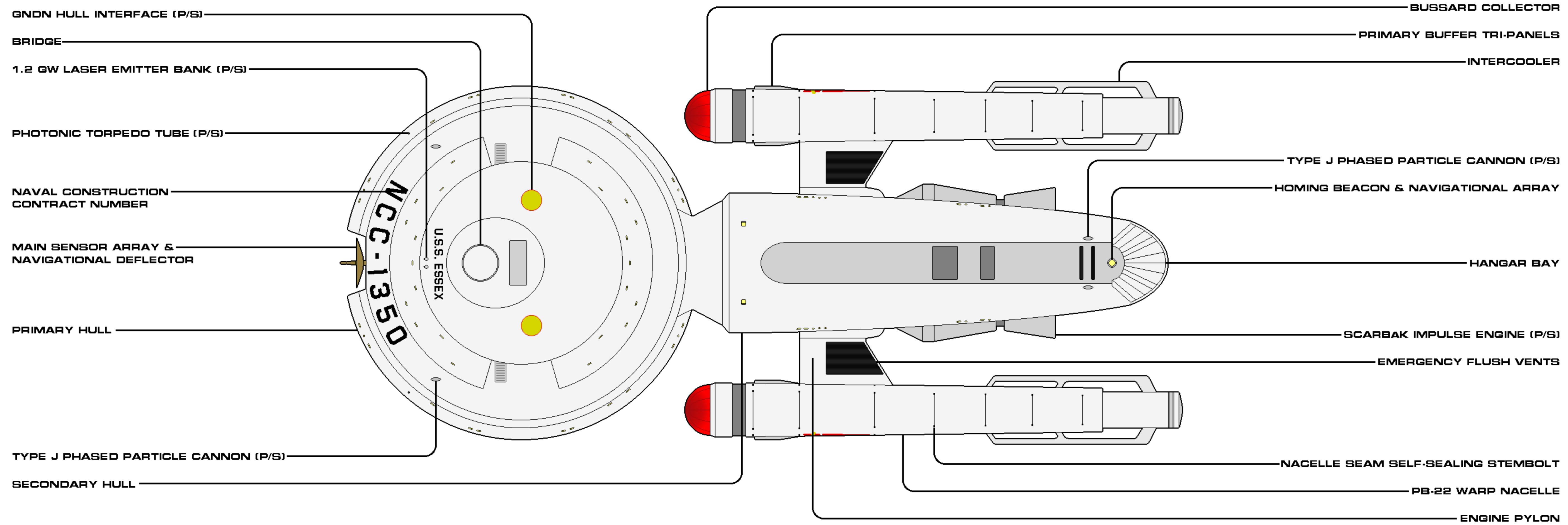
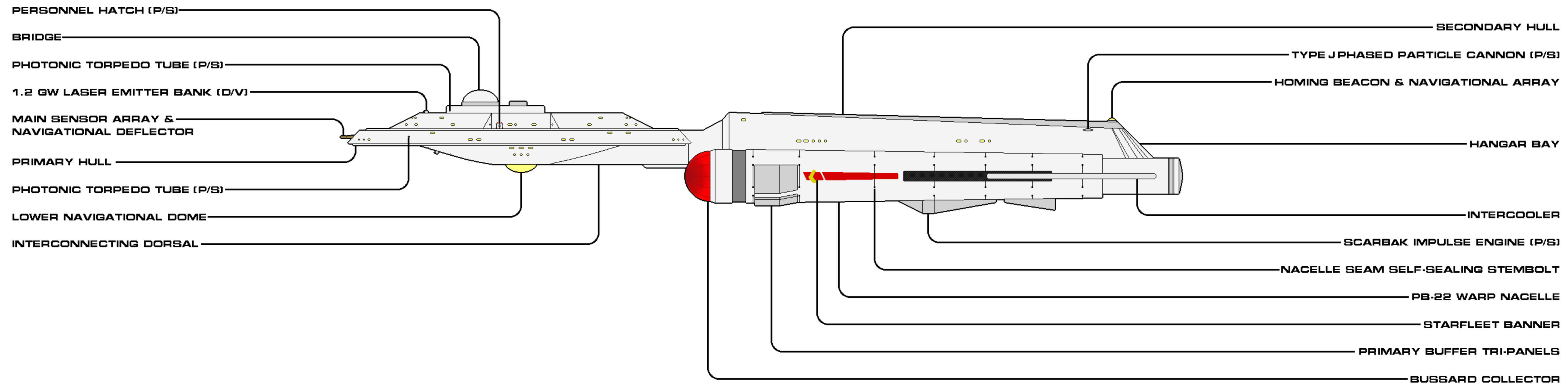

SHEET 1 OF 2

CLASS	HORIZON	CATEGORY	BATTLE CRUISER
VARIANT	ESSEX	CONSTRUCTED	2222
LENGTH	234.1 M	BEAM	111.1 M
HEIGHT	46.0 M	MASS	576,500 MT
OPERATIONAL	1/40	RELEASE DATE	1904.01

Authorized for release by Star Fleet Bureau of Starship Construction

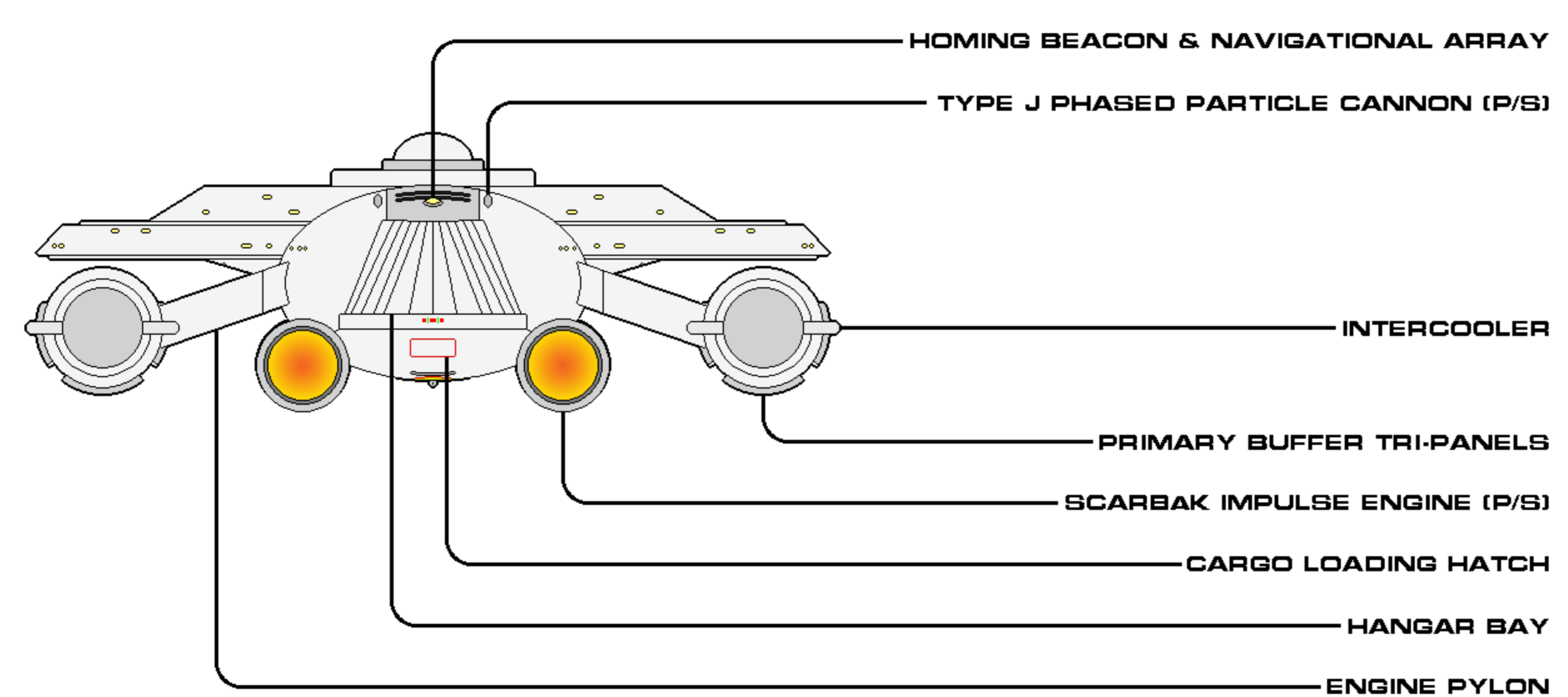
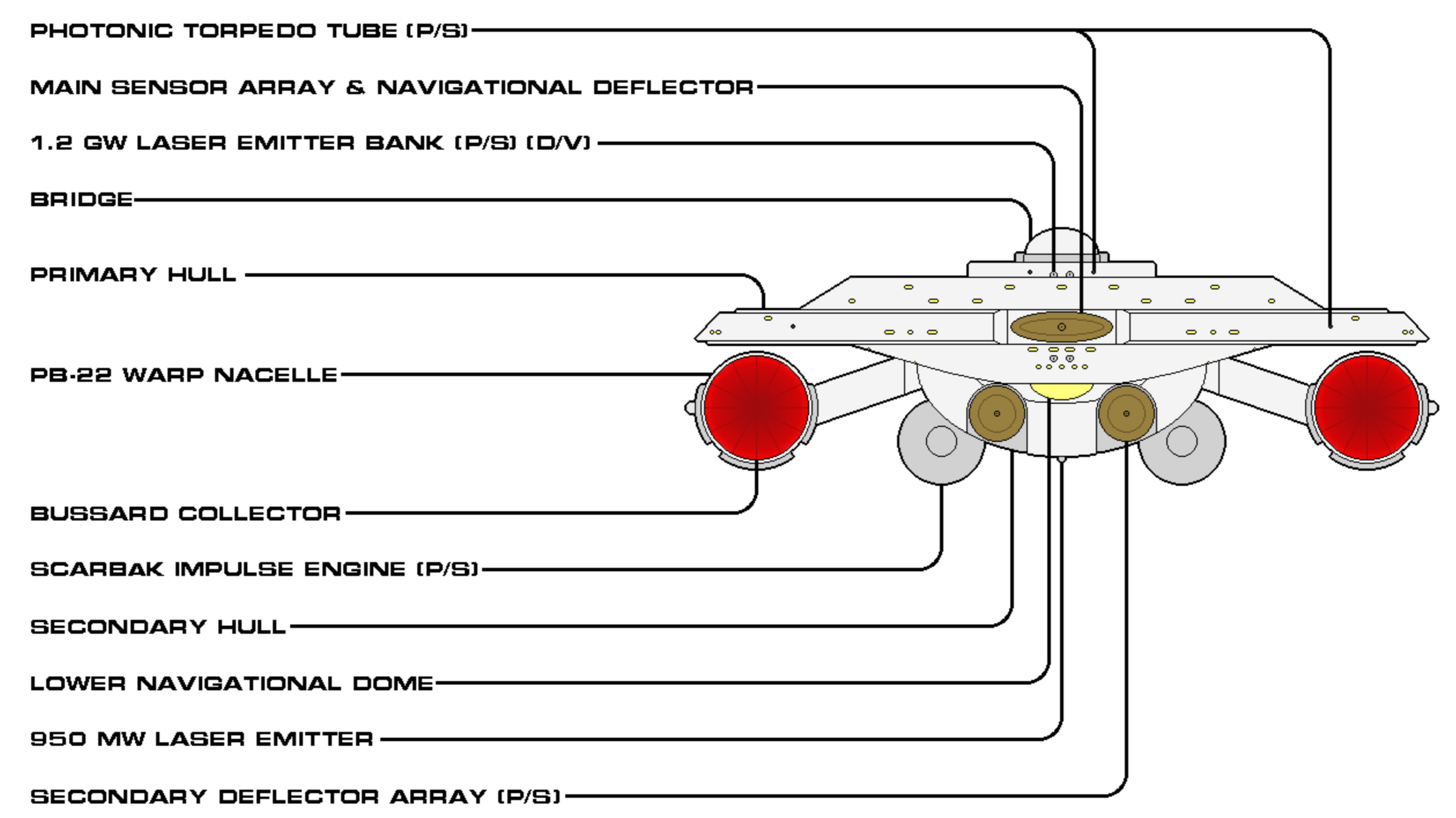
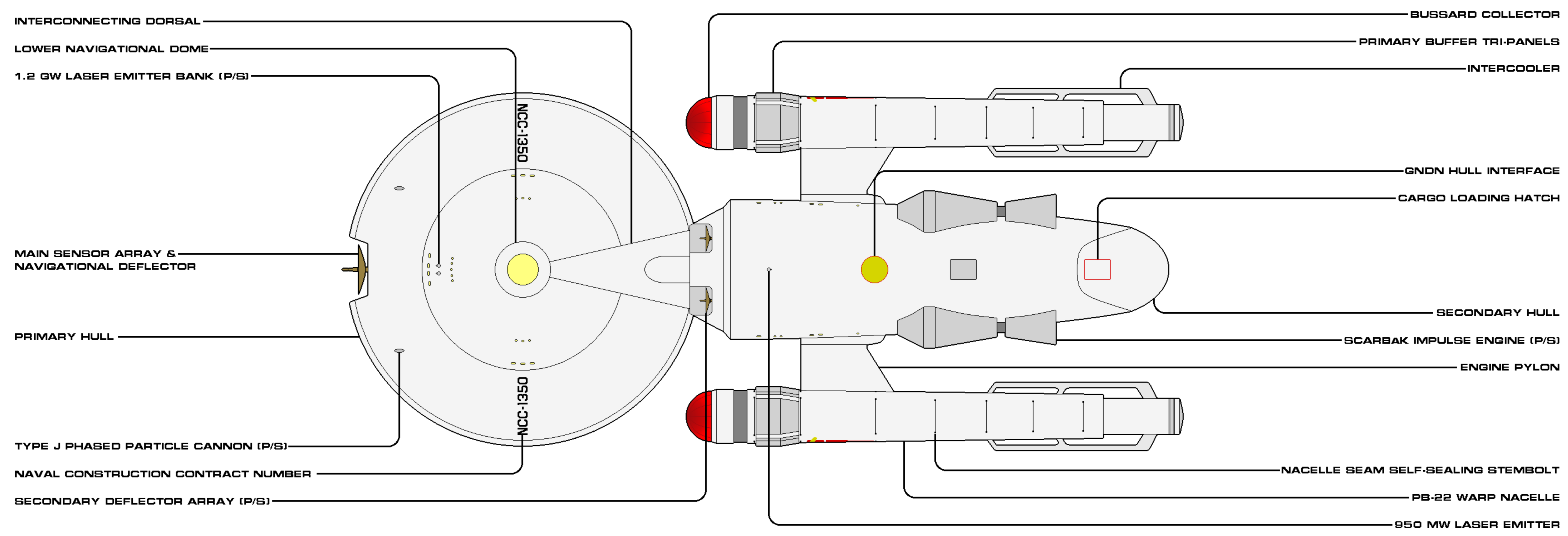

SHEET 2 OF 2

CLASS	HORIZON	CATEGORY	BATTLE CRUISER
VARIANT	ESSEX	CONSTRUCTED	2222
LENGTH	294.1 M	BEAM	111.1 M
HEIGHT	46.0 M	MASS	518,500 MT
OPERATIONAL	1/40	RELEASE DATE	1904.01

Authorized for release by Star Fleet Bureau of Starship Construction





ARCHON SUBCLASS

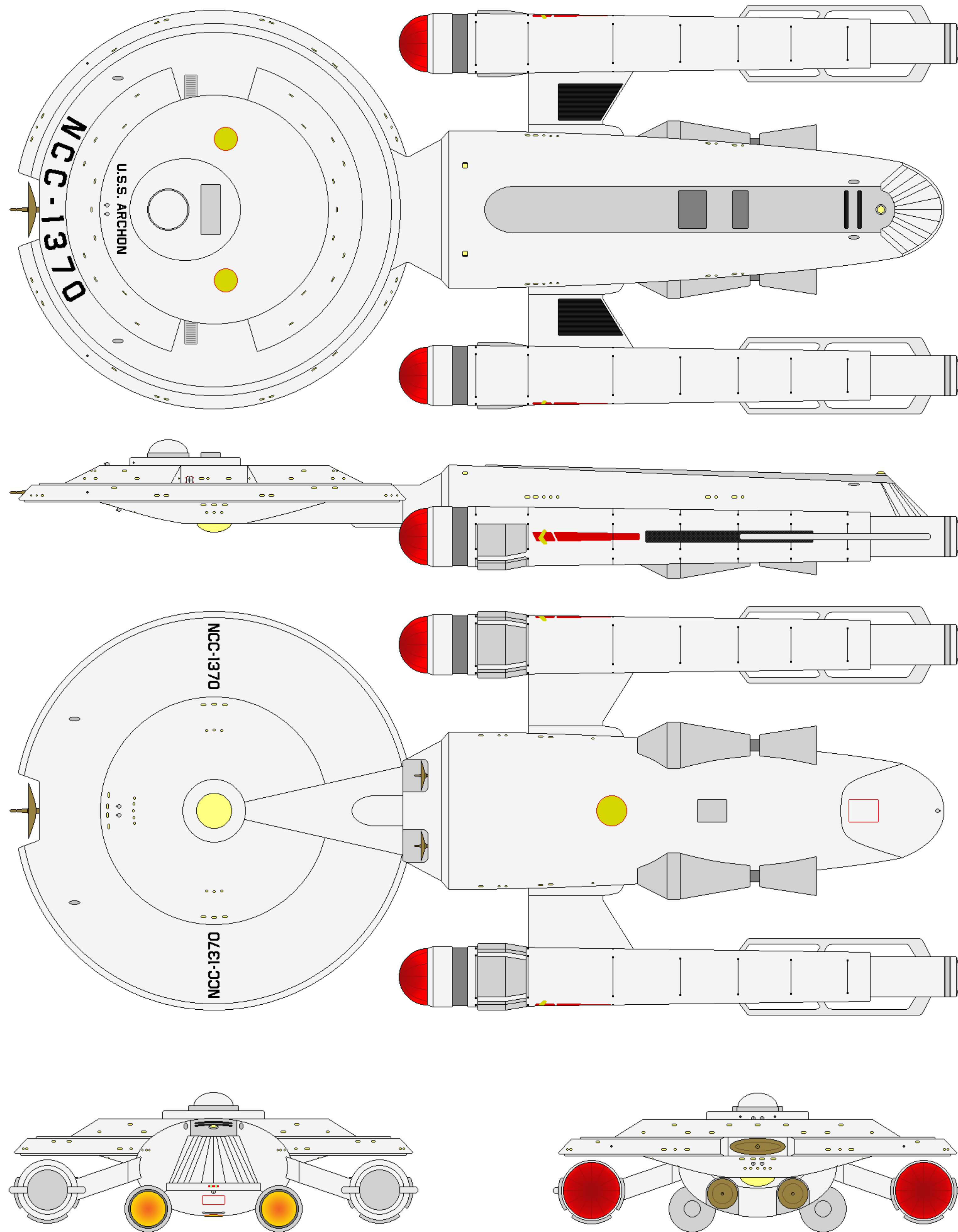

CATEGORY: HEAVY CRUISER  
 OPERATIONAL: 2222 - 2263  
 CONSTRUCTED: 7

DIMENESIONS:  
 LENGTH: 294.1 M  
 BEAM: 117.1 M  
 HEIGHT: 46.0 M  
 MASS: 574,500 MT

PERFORMANCE:  
 CRUISE: WARP 3 (OCU)  
 MAX: WARP 5.5 (OCU)  
 ENDURANCE: 6 YEARS

COMPLEMENT:  
 OFFICERS: 32  
 ENLISTED: 294

TACTICAL:  
 - 4X 1.0 GW LASER EMITTERS  
 - 1X 950 MW LASER EMITTER  
 - 6X TYPE J (900 GW) PHASE CANNONS  
 - 4X TORPEDO TUBES (W/ 110 PHOTONIC TORPEDOES, 20 PROBES)  
 - 1-LAYER CONFORMAL FORCEFIELD  
 - NAVIGATIONAL DEFLECTOR  
 - 2X AUXILIARY DEFLECTORS

AUXILIARIES:  
 - 5X LIGHT SHUTTLES  
 - 6X SUBLIGHT TACTICAL CRAFT





## ARCHON SUBCLASS AUTHORIZED CONSTRUCTION

THE FOLLOWING SHIPS OF THE ABOVE CLASS WERE AUTHORIZED AS PART OF THE FEDERATION STAR FLEET BY FEDERATION COUNCIL APPROPRIATION.

USS ARCHON	NCC-1370	USS FEARLESS	NCC-1374
USS REPUBLIC	NCC-1371	USS ROEBUCK	NCC-1375
USS INDEPENDENCE	NCC-1372	USS SOUTHERN CROSS	NCC-1376
USS ADVENTURE	NCC-1374		

---

### GENERAL INFORMATION

Four years after the first of the veteran Horizon subclass heavy cruisers and Advance subclass battle cruisers received their Flight II upratings, newbuilds of even greater advancement were commissioned into frontline service with Star Fleet. The heavy cruiser variant, like the concurrent battle cruiser variant, continued the homage to the hero vessels of the Daedalus class of the preceding generation with the USS Archon (NCC-1370), the first in the final Horizon subclasses. With the same weapons loadout of the Horizon Flt IIs, as well as the same overall dimensions, a position paper about the ship would not appear to do it justice: the ship had a secondary hull design borrowed and modified from the failed Indomitable experiment, providing it an immense internal volume unavailable to its predecessors. This increased the ship's range and endurance (6 years, specifically), due to the enormous increase in fuel and supplies carried (when compared to the older, converted cruisers). The higher standard of accommodation was also appreciated by her crew. The PB-22 warp nacelle was a slight improvement on the PB-18, decreasing individual unit mass for the same performance characteristics, through more advanced (but smaller) primary buffer panels and an intercooler that maximized efficiency with increased length (but less of a physical footprint).

While the Baton Rouge class was also first commissioned in the same year (2222), the operational history of the Horizon subclasses allowed for instant familiarity for the Archon and her sisters, meaning the ships were at the forefront of Star Fleet's strategic forward defense policy for a few of their early years. However, as the more modern heavy cruisers increased their numbers and operational responsibilities, the production of the subclass was quickly slashed to seven (from the envisioned twenty). In the end, these newest of the Horizon series still failed to provide the expectations of acceleration, agility, speed, or range to meet modern military standards or ambitions. Hence, Star Fleet would consider how additional upgrades could provide boosts in power and propulsive performance, in a direct impact to what would eventually result in the Constitution class heavy cruiser of the 2240s. The last Archon would be decommissioned in 2263.

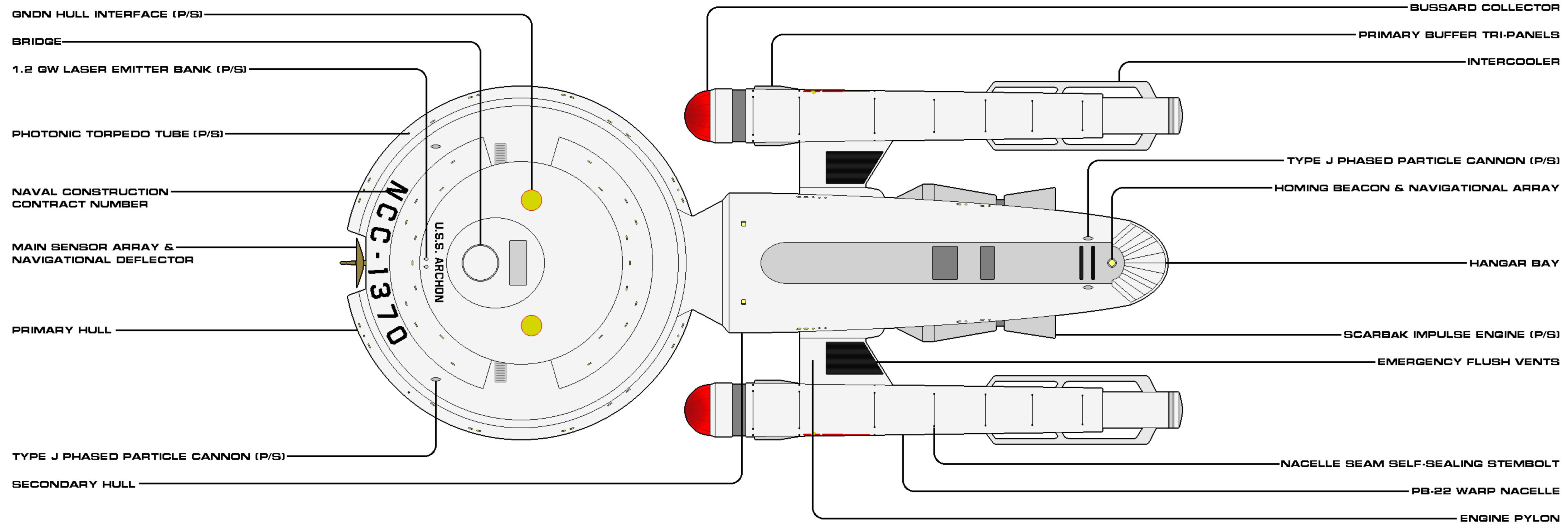
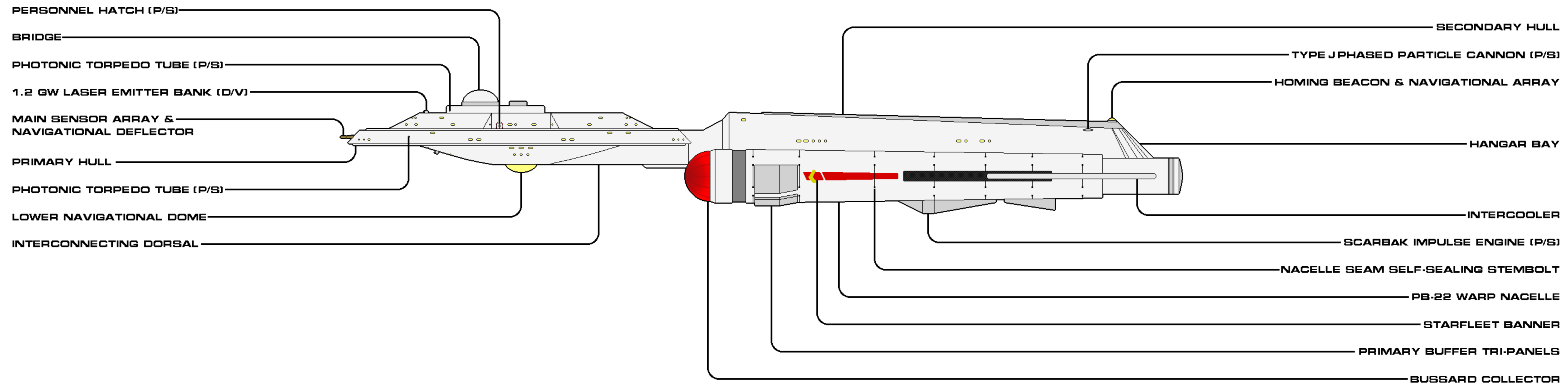

SHEET 1 OF 2

CLASS	HORIZON	CATEGORY	HEAVY CRUISER
VARIANT	ARCHON	CONSTRUCTED	2222
LENGTH	234.1 M	BEAM	111.1 M
HEIGHT	46.0 M	MASS	574,500 MT
OPERATIONAL	740	RELEASE DATE	1904.01

Authorized for release by Star Fleet Bureau of Starship Construction

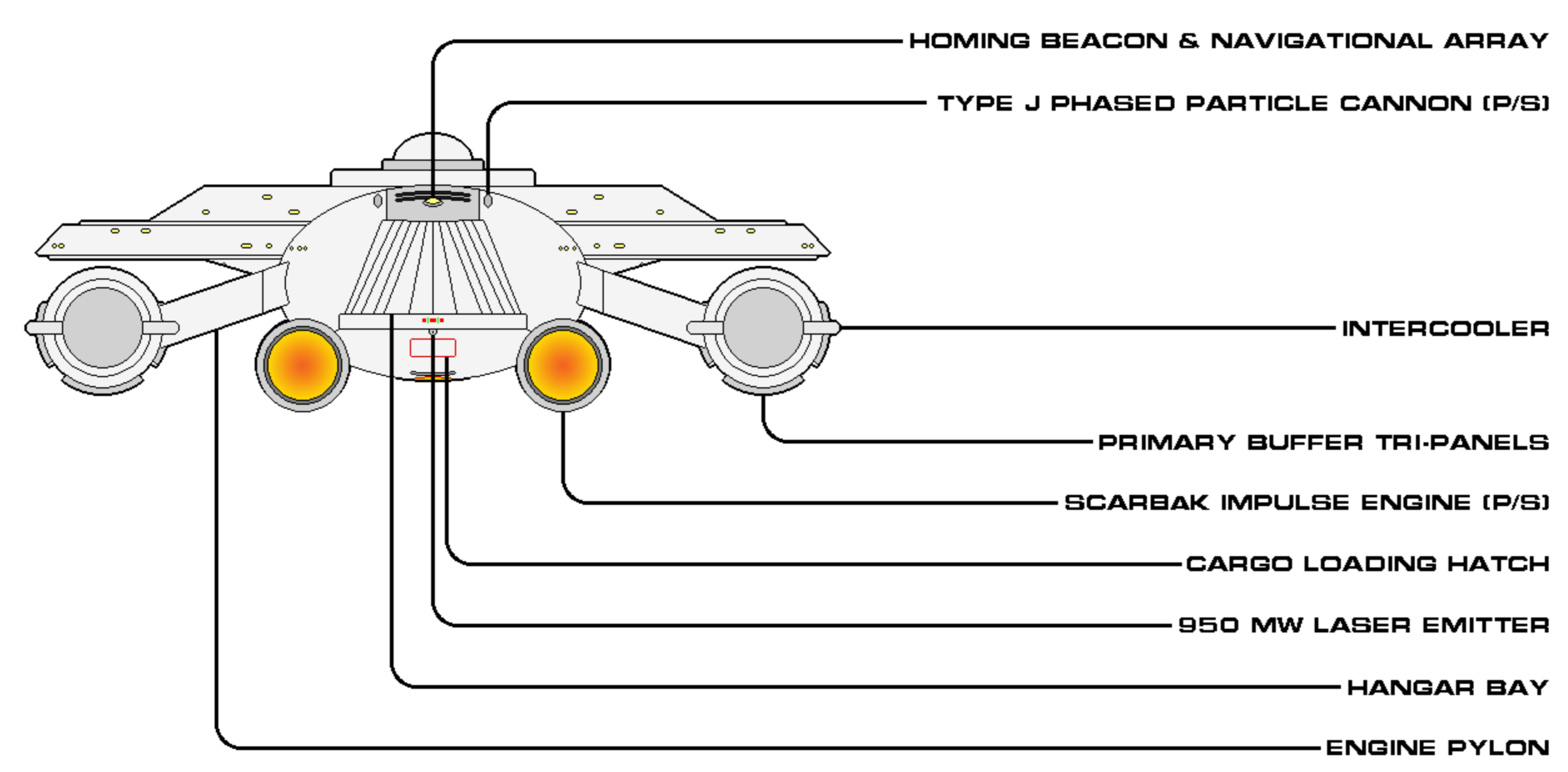
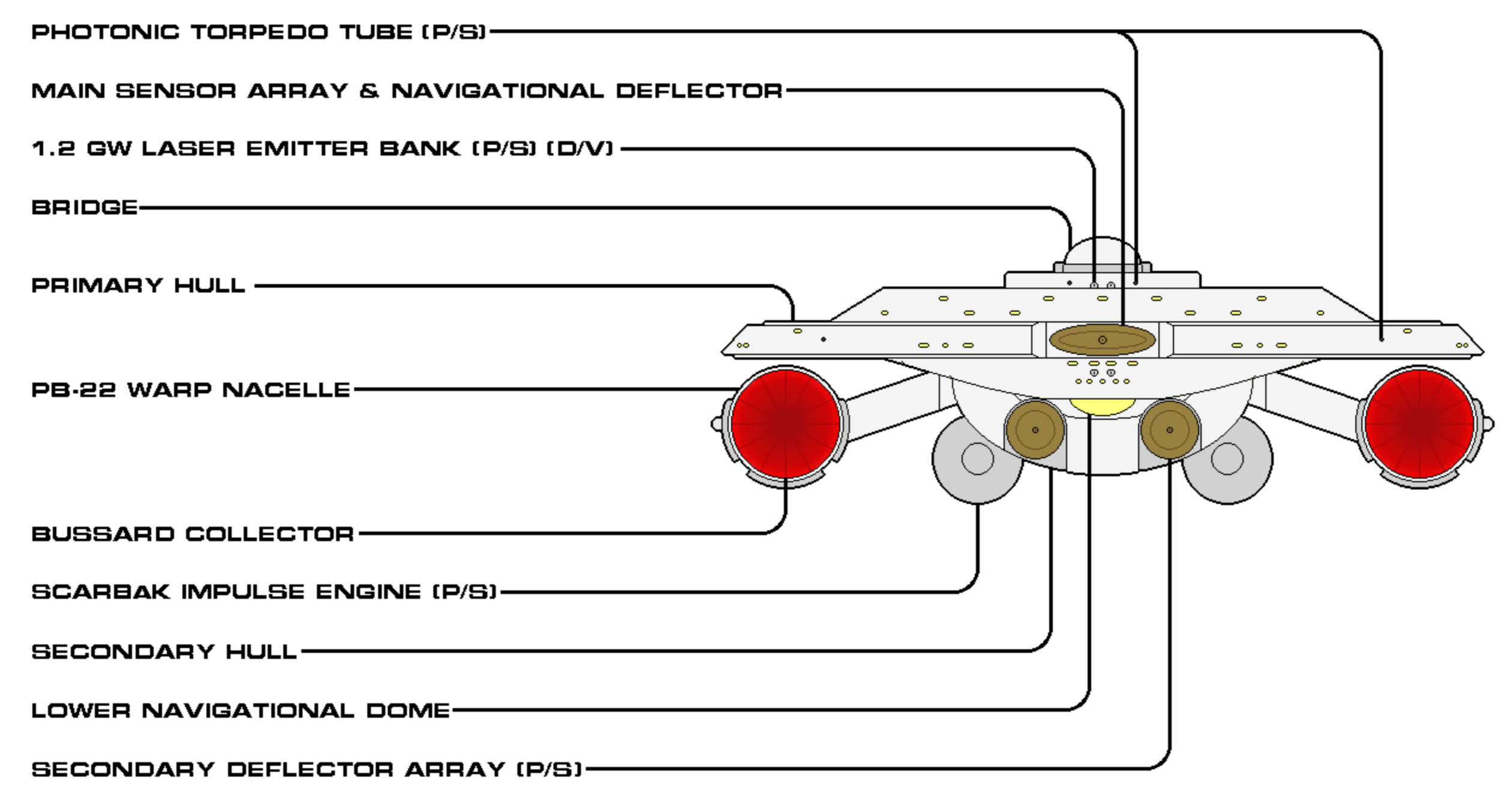
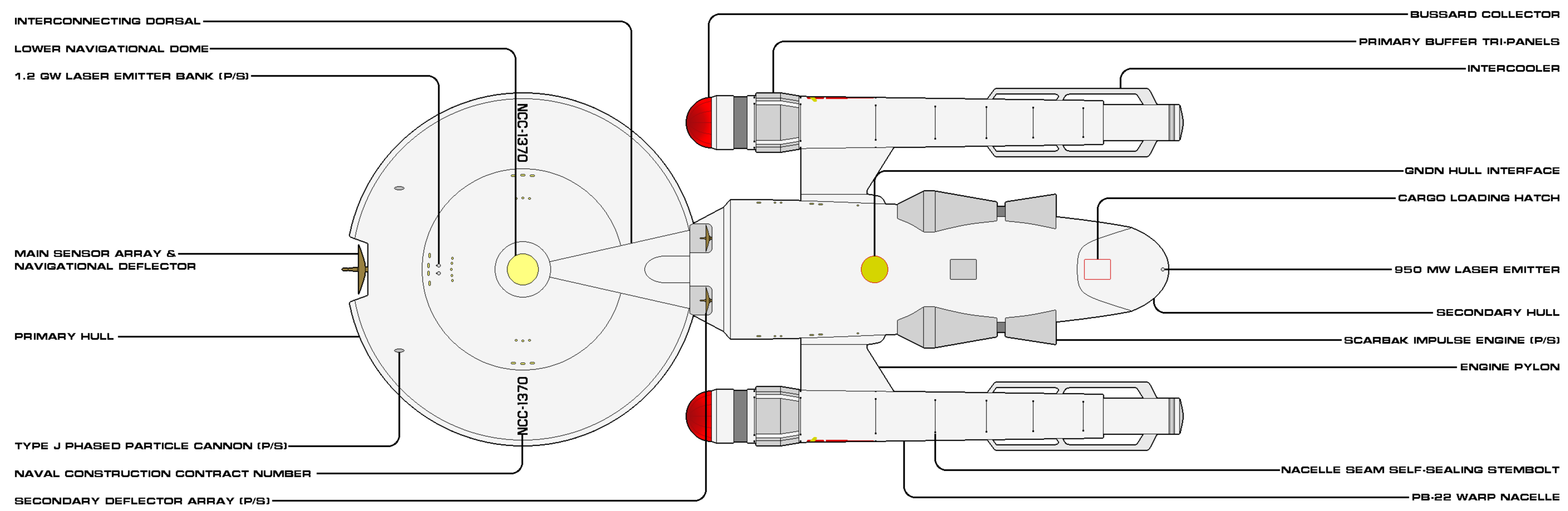

SHEET 2 OF 2

CLASS	HORIZON	CATEGORY	HEAVY CRUISER
VARIANT	ARCHON	CONSTRUCTED	2222
LENGTH	294.1 M	BEAM	111.1 M
HEIGHT	46.0 M	MASS	514,500 MT
OPERATIONAL	1/40	RELEASE DATE	1904.01

Authorized for release by Star Fleet Bureau of Starship Construction





## CLASS TIMELINE

2180s

Star Fleet performs the last one-stroke large colonization attempt for around 60 years.

Star Fleet begins considering requirements for a new doctrine of logistics scaled towards medium transports.

Noting the careers of the wartime capital ship classes are beginning their inevitable downturn, Star Fleet starts to develop requirements for a new heavy cruiser design.

Star Fleet tasks independent deep space missions solely on top-of-the-line cruisers.

With Vulcan decommissioning its old warfleet and with the anticipation of Andoria doing the same, Star Fleet significantly downscales its operations again, hoping to provide time and resources for its own reorganization.

2190

USS Alert (NCC-283, Castor survey cruiser) reveals the outbreak of internal unrest in Romulan space with the detection of a brief battle near Beta Cersus. The incident is enough to convince the UFP Council to allocate more funds for the completion of the Caracal class multi-mission cruisers and other ambitious Star Fleet programs.

The first recorded attempt of piracy on a Watt class fleet tanker/transport occurs, and is foiled.

The reemergence of the possible Romulan threat guarantees the full funding of the Caracal class.

Construction begins on the prototype of the Horizon class heavy cruiser.

The Luna Shipyards are opened, in orbit of Luna.

2193

USS Icarus (NCC-263, Placido surveyor) is the first to establish contact with a winged - and, indeed, truly airborne - sentient humanoid species on Alpha Virginis II.

Heavy cruiser USS Horizon (NCC-1000), first of its class, enters service with Star Fleet. Seventeen more are ordered and funded, with the first ones to be completed in 2196.

The Engineering Division is now planning ship classes two generations ahead of the current Fleet assets.

Spacedock One is completed and operationally replaces Earthbase One above Earth.

2196

Star Fleet retires the last of the Daedalus ships from exploration use. (Three will be reactivated by the Star Fleet Corps of Engineers in 2264).

The succeeding ships of the Horizon heavy cruiser class start entering service.

A period of feline Xindi (Kzinthi) 'unrest' flares up, forcing Star Fleet to reconsider the slowing down of the heavy cruiser development policy, in favor of time-critical 'hearthworld' defense assets. This results in all Horizon construction for contracts above NCC-1007 to be (temporarily) suspended.

2197

USS Chiu Degong (NCC-S121, Watt transport) is attacked by Nausicaan raiders, but is able to scare them off.

The Kzinti unrest climaxes and then dies down.

Star Fleet makes up for the slowing down of new Horizon construction by increasing funding for 26 hulls (from 18), now with 13 of them being built towards the new Advance battle cruiser subclass specifications.

The UFP extends membership to Edos.

2198

The construction of the Horizons and the new Advance subclass restarts, with some of the impartially-completed Horizons re-designated for Advances.

The Advance battle cruiser subclass (of the Horizon class) enters service.

2199

USS Clara Barton (NCC-287, Castor survey cruiser) helps fight the Rigelian fever at its outbreak by providing both laboratory facilities, database services and quarantine enforcement that initially limits the plague to Rigel V.

During acceptance trials, USS Scotia (NCC-1006, Horizon heavy cruiser) achieves warp 5.9 for two minutes (though it was much later realized warp 6 had actually been 'touched').

The final ships (of the finally 13 ordered) of the Horizon heavy cruiser class are completed and enter service.

Civilian transport Bleg-Ra, distressed in a free asteroid cloud near Delta IV, is rescued by USS McKenna (NCC-L53, Pointer corvette).

Tranquility Base Shipyard is opened over Tranquility Base, Luna.

2209

USS Sentry (NCC-1010, Advance battle cruiser) is lost in an engagement with Klingons during the refugee crisis of Gamma Demetrius (also known as Boreth). This incident leads to the development of the Prime Directive.

The Klingons become newly belligerent, though logistically utterly unprepared for war.

The final three vessels of the Advance class are suspended, until weaknesses unveiled with the loss of USS Sentry are addressed; the result is the Whorfin subclass. The remainder of the initial 9 Advances are completed and enter service.



## CLASS TIMELINE

2210

The construction of the three interrupted Advance subclass battle cruisers is reauthorized. Two are designated as Whorfin subclass battle cruisers and shortly enter service, while the hull of NCC-1023 is re-tasked to become the prototype of a prospective Indomitable subclass of the Horizon heavy cruiser. Testing of USS Indomitable (NX-1023) begins shortly after final completion.

The trailing sensors of USS Siding Springs (NCC-1356, Lowell scout) intercept the signals of a high velocity probe passing through the galactic plane at an estimated speed of warp 430.

The basis for a new type of heavy cruiser with significant warp performance increases is suggested by several classified studies.

2212

Battle cruiser testbed USS Indomitable (NX-1023) passes most weapons tests, but consistently fails drive tests. She is decommissioned shortly thereafter.

A third and final battle cruiser of the Whorfin subclass is ordered (NCC-1029), to be delivered in 2215.

USS Leonides (NCC-772, Mann light cruiser) intercepts a group of pirates ransacking the armed Klingon transport Flying Fortress, and thus unknowingly throws a challenge to the Sta Mura dynasty, plunging the secular elements of the Klingon Empire into a heated conflict with the Federation as well.

Star Fleet shunts almost 40% of its maintenance budget into the development of a mass-producible supercruising light cruiser.

2215

In an early test of a forthcoming torpedo upgrade, USS Allegany (NCC-754, Caracal command cruiser) is lost in an explosion, claiming 86 lives and ripping open a spacedock above Arcturus. The event is downplayed and the truth classified.

The final Whorfin battle cruiser class is completed and enters service.

2218

The final recorded attempt of piracy on a Watt class fleet tanker/transport occurs, and is foiled. Seventy-eight attempts have now been made (all failed), though four Watts are lost by this year to technical failure, two to natural phenomena, and one to a game of go.

The real events of the 2215 Allegany incident are revealed and the backlash does significant damage to public relations.

The Horizon and Advance class vessels begin a weapons upgrade.

The "Klingon Offensive" takes place.

A multi-ship conflict occurs between the Klingon Empire and Star Fleet. Light cruiser USS Ranger (NCC-781) is boarded and captured.

The Earth First movement gains new support and spawns similar groups across the UFP, including on Andor, Tellar and Vulcan.

Due to the loss of USS Ranger to the Klingon Empire, Star Fleet develops an intense interest in developing an all-new cruiser class, utilizing the so-called 'third generation' warp propulsion technology.

2219

Texas class light cruiser USS Oklahoma (NCC-945) engages marauders intent on pillaging the settlements on Agnihotra.

The evacuation of 10 million inhabitants of Bayard's Planet is completed.

Ten hulls of the Essex battle cruiser subclass are ordered.

Ten hulls of the Archon heavy cruiser subclass are ordered.

USS Enderbury (NCC-480, Kovaris phase gun destroyer) is effectively destroyed when a defective pulse wave warhead (Vulcan technology) detonates right after leaving the launcher. The explosion rips open the pressure hull of the destroyer and kills most of the test crew immediately; radiation takes a further death toll.

Paradise planet Hydra II in sector 16C is discovered by USS Poseidon (NCC-780, Mann light cruiser).

USS Constellation (NCC-1017, Advance battle cruiser) suffers major battle damage to her bow structures.

The Caitian species is encountered by the Federation when a Star Fleet ship is accidentally destroyed by them while making first contact. However, the arrival of the first aliens encountered by these felines short-circuits a long civil war between the various planets.

2222

The Essex battle cruiser subclass enters service.

The Archon heavy cruiser subclass enters service.

Funding for the Essex and Archon subclasses is cut, limiting both to seven hulls each due to expectations for the Baton Rouge class heavy cruisers meeting demands.

USS Republic (NCC-1371, Archon heavy cruiser) is the victim of a rampant internal fire and extensive contamination from fire suppressants, shortly after her commissioning.



## CLASS TIMELINE

USS Targa (NCC-467, Kovaris phase gun destroyer) manages to disperse a magnetic storm threatening Balaka III by using her experimental pulse wave warheads - a Vulcan technology.

Star Fleet grants Chiokis the use of two relatively low-fatigue vessels of the Horizon series: USS Constellation (NCC-1017, Advance Flight II battle cruiser) and USS Republic (NCC-1371, Archon heavy cruiser).

Dilithium is discovered to be a naturally-occurring element, on the colony planet Deneva.

2224

The final ships (of the ordered 7) of the Archon heavy cruiser class are completed and enter service. Further progress of the USS Gjõa in the Rapier yards above New Aberdeen is cancelled.

Star Fleet decides to crank up cruiser production by any means necessary and available.

Following two years of iterative design effort, Chiokis manages to make significant progress on connecting the two hulls of the future heavy cruiser.

2225

The final ships (of the ordered 7) of the Essex battle cruiser class are completed and enter service.

Star Fleet's initial plans had Project Starship producing the first high-tech starships this year.

The Osceola disaster costs the lives of 277 colonists when a brief stasis synchronization fails.

Star Fleet adopts a new uniform.

2229

In an emergency meeting, the Chiokis Corporation announces Project Starship will be delayed by at least five more years, moving the projected delivery date to 2239 or later. They offer (along with fellow Andorian shipyard, Salazar Fleet Builders) to build a stop-gap run of 12 light cruisers (of a new design) to help fill the defense requirements.

Battle cruiser USS Whorfin (NCC-1024) survives a Kshatriyan ambush with light casualties.

Star Fleet begins constructing USS Bonaventure (NX-B1), the dilithium power testbed.

There is an escalation of threats from Klingon long range raiders.

A minor raid by three Klingon Raptor corvettes easily cripples USS Hercules (NCC-454), a Titan carrier, conducting maneuvers near Donatu, with more than 130 lives lost. The ship will be mothballed.

2240s

The repeated delays on Project Starship have become such a serious issue that secrecy on the project is on the verge of breaking down.

Star Fleet begins the transition from the spooled warp coil to solid-state technology.

Sorting out meek Imperial reconnoitering missions from reckless privateer raids or the frequent yet futile invasion attempts by weak Klingon factions is a constant pain for Star Fleet border defense forces.

This decade is the first of two that represents the height of perimeter ship combat on Klingon borders.

The decade is remembered as the Great Awakening, with significant numbers of scientific results from deep space exploration.

All the variants of the Horizon class receive new auxiliary craft assignments.

The significance of the Willall challenge upon Klingon politicians and scientists is uncovered.

2249

The final Horizon class heavy cruiser is stricken from Star Fleet's registry.

The UFP brings the Humans of Polar City (and other colonies on Rigel IV) into its jurisdiction (but not membership), in order to provide protection.

The UFP extends membership to Risa.

USS Cassegrain (NCC-1429, Hale scout) is hijacked by renegade Andorians, who set the crew adrift and disappear to parts unknown with cargo holds full of various weapons components. USS Bodiri (NCC-2717, Loknar frigate) sees action against Lesser Orion pirates, thwarting an invasion of a prime directive-protected class L world in the Secundi Bahia system.

2251

The final Essex class battle cruiser is stricken from Star Fleet's registry.

2258

USS Inuit (NCC-747, Cahuya survey cruiser) is lost at Azha to consumption by a spaceborne lifeform of a type common in the region (though, at the time, it was presumed to be due to an encounter with Klingons).

The final Advance class battle cruiser is stricken from Star Fleet's registry.

USS New America (NCC-2706, Loknar frigate) tractors to safety a Federation starliner that had suffered an impulse drive malfunction on approach of Procyon and was in danger of plunging into the cromosphere of the star with 400 people aboard.

USS Sverdlov (NCC-1238, Coventry strike frigate) fails to return from a test run of the new PB-51 series engines.



## CLASS TIMELINE

2263

The UFP recognizes Orion sovereignty and neutrality on issues that had formerly been considered criminal activity.

The final Archon class heavy cruiser is stricken from Star Fleet's registry.

Having completed a multi-year refit, USS Read (Byrd galactic survey cruiser) launches on her second galactic survey, a 13-year voyage.

Construction begins in Earth orbit on the Ournal class Earth Spacedock.

A five-ship expedition is lost in contested space near Romulan territory; only the severed warp nacelle of USS Alesia (NCC-4454, Larson destroyer) remaining to tell of its demise.

The Orion cartels are provoked by the Atlanta operation and attack the dilithium-rich world of Ghioghe. Heavy cruiser USS Levant (NCC-1442, Baton Rouge class), commanded by Commodore Sieren, and light cruiser USS Sutherland (NCC-1010, Texas Flight II), commanded by Commander James Kirk, are both lost in the Battle of Ghioghe.

2297

The Klingon Empire abandons attempts to develop the improved Chang type cloak altogether.

The final Horizon class heavy cruiser, USS Whorfin (NCC-1024), completes her third deep space survey and is stricken from Star Fleet's registry.

The United Federation of Planets extends membership to Rigel V (the 'Vulcan' Rigelians).

2322

A non-mobile Frankenstein 'vessel', made up of Horizon, Achernar and other various parts is finally retired from 'deep space special repair and maintenance' with the SCE.

Star Fleet ceases use of channeled phasers on its new classes, as phaser arrays enter service.



# STARSHIP COMPARISON GUIDE

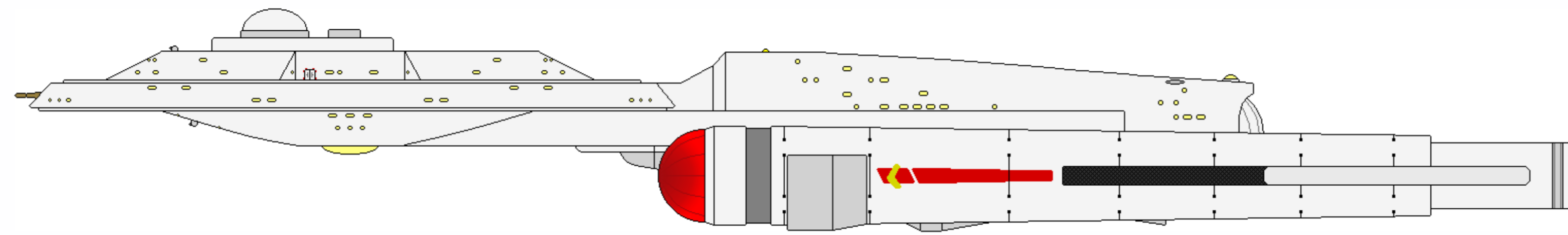

HORIZON  
HEAVY CRUISER

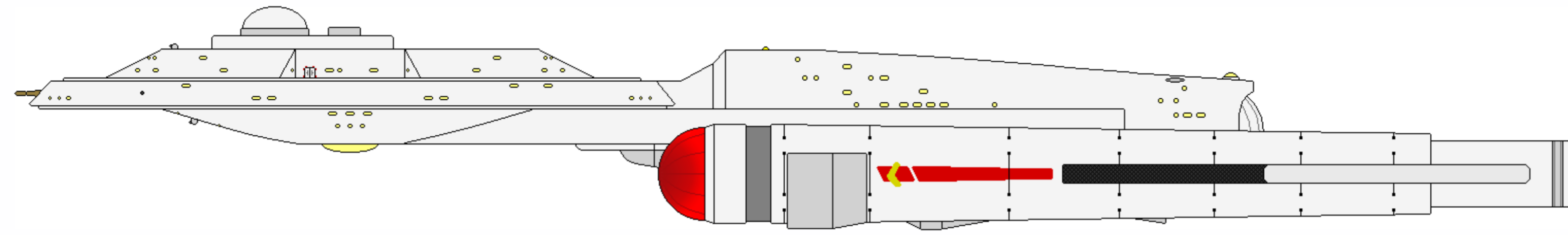

ADVANCE  
BATTLE CRUISER

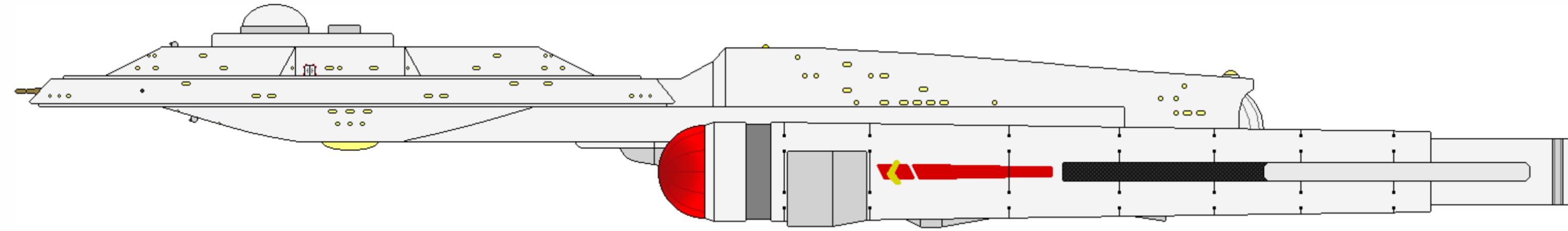

WHORFIN  
BATTLE CRUISER

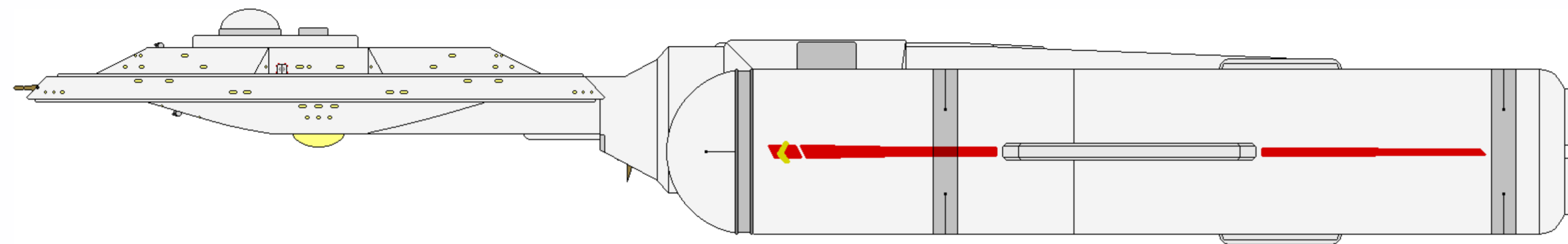

INDOMITABLE  
BATTLE CRUISER  
TESTBED

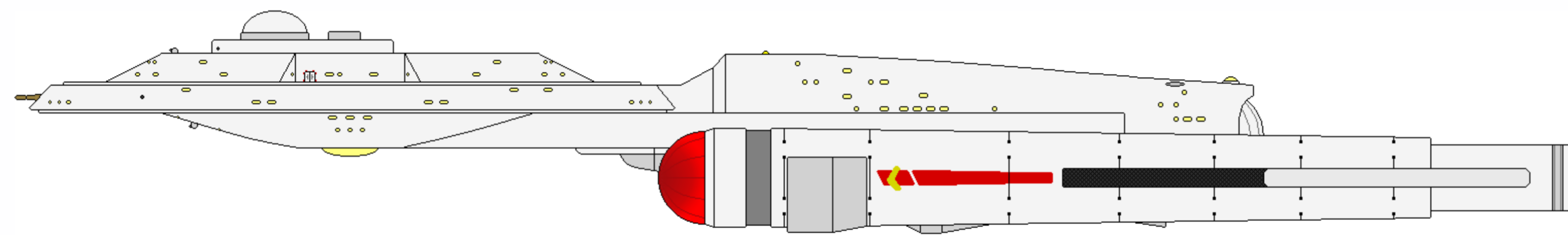

HORIZON FLT II  
HEAVY CRUISER

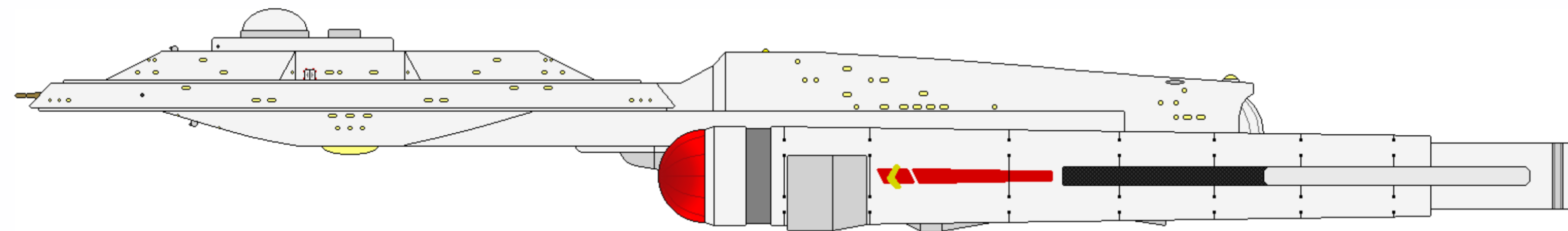

ADVANCE FLT II  
BATTLE CRUISER

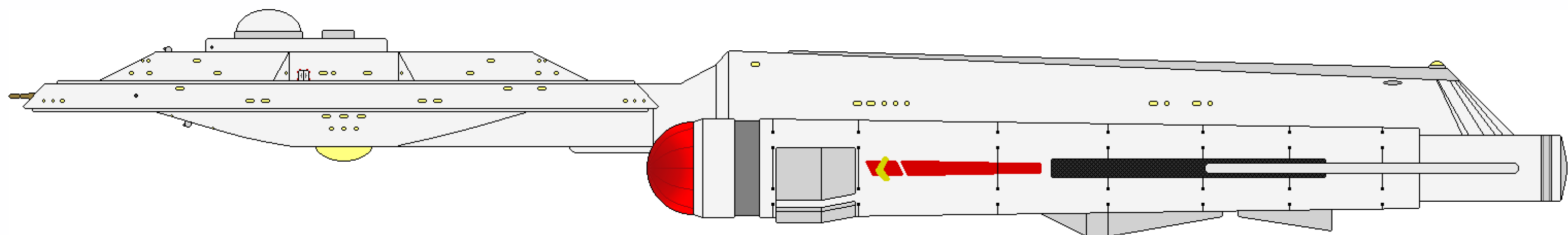

ESSEX  
BATTLE CRUISER

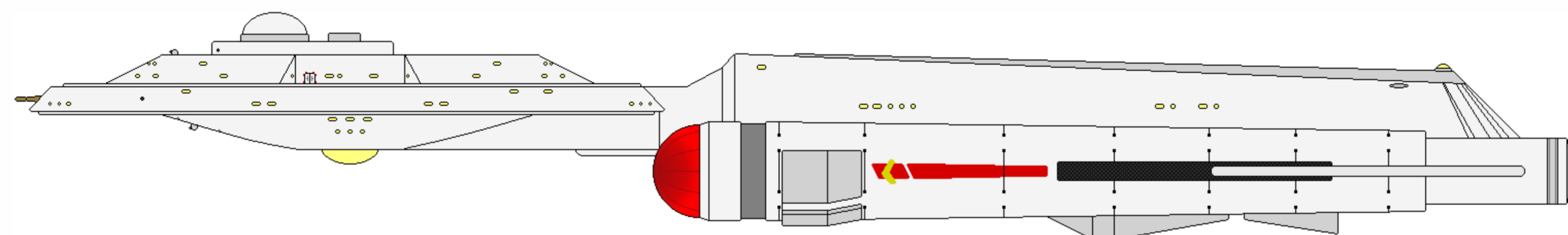

ARCHON  
HEAVY CRUISER





## GLOSSARY

**Array:** Generally, a combination of identical sensors, weapons, or other equipment operating in conjunction.

**Barge:** one of several differing types of vessels, including 1) a low-warp bulk carrier designed to transport unpackaged bulk cargo; 2) an orbital-to-atmosphere combat lander, usually heavily armored and lightly armed, to transport large troop formations into defended surface areas.

**C/P/S:** Centerline/Port/Starboard (see P/S).

**Class:** a production run of vessels all to identical (or nearly identical) standards. Ex: the Constitution class

**Corvette:** Small warp-capable ship dedicated to local patrol, law enforcement and community service missions. Sometimes landing-capable, not dependent on starbase facilities for support.

**Cruiser:** A medium multi-purpose starship. The largest exploration vessels until the early 24th century, when relegated to other duties with the introduction of large Explorer starships.

**Deep space:** The region near or beyond the recognized borders of the Federation, often uncharted in any considerable detail.

**Destroyer:** A medium offense starship intended for destroying enemy capital ships and installations, as well as conducting fleet escorts.

**ECS:** Earth Cargo Ship, a prefix for vessels flagged under the governing authority of the Earth Cargo Service.

**ELRS:** Extreme Long Range Sensor

**Flight:** A modification to a class of ship intended to be incorporated by most or all members of that class.

**Flitter:** an extremely low-altitude planetary personnel and freight vehicle, utilizing anti-grav hover equipment. Larger vehicles might resemble wheel-less trucks, with the smallest analogues to one- or two-person motorcycles.

**Frigate:** Until the late 22nd century, a dedicated medium defense and escort starship, larger than corvette but smaller than destroyer, often capable of trans-atmospheric operations. In the 23rd century and into the early 24th century, often used to designate defense and escort starships ranging from small patrol and escort ships typically lacking torpedo armament to versatile multipurpose ships similar to light cruisers.

**FTL:** abbreviation for Faster Than Light.

**GW:** GigaWatt

**Hopper:** a small vehicle designed for atmospheric flight. While some may have limited aerospace capabilities, they are generally utilized for intra- and intercity transport of personnel.

**ISA:** International Space Agency. Formed by the NUN in 2018 in an effort to coordinate international space exploration missions. Succeeded by both the UESPA and UESN in 2067 and 2069, respectively.

**Ishakawa-Dell Barrier:** The exponential growth in the power required by early warp nacelles as FTL speeds approached warp factor 6 (on the OCU scale).

**Laser:** Typically, a secondary weapon on early space vessels. Current shielding technology has largely negated the threat posed by the coherent electromagnetic beam.

**M:** Meters

**M/AM:** Matter/Antimatter

**MT:** Metric Tons

**Navigation Light:** Yellow in color; these lights are generally located on or near major points of superstructure of a space vessel. They often provide low-emission positioning signals for specific locations on and within the vessel for the purposes of proximity maneuvering by another vessel and relative destination positions for transporters. Not to be confused with red or green running lights.

**NCC:** Letter prefix in UFP Starfleet vessel registries, anecdotally said to come from the term Naval Construction Contract. Current usage has letter N signifying UFP registry, and CC signifying active Star Fleet forces.

**Nearspace:** The region of the Federation considered to be internal, fully charted, and uncontested.

**NUN:** New United Nations. Formed in 2011, first dissolved in 2053 (during the Third World War), re-formed in 2065 (two years following First Contact), then finally dissolved in 2079. Authorized the formation of the ISA (2018), UESPA (2067), UEDP and UESN (both 2069). Succeeded by the UEDP



## GLOSSARY (CONTINUED)

OCU: Original Cochrane Units, representing the original warp scale, where the warp factor cubed was the velocity in c, the speed of light.

Operational Standard: the description and designation for a previous testbed or prototype vessel that has been made operational, though not necessarily to the standards of the official class. Ex: USS Constellation (operational standard)

P/S: Port/Starboard; left & right side, respectively, in naval parlance.

Particle Cannon: A primary or secondary weapon on some early space vessels, though generally replaced by phaser technology. The weapon accelerated charged or neutral matter (or antimatter) particles to relativistic speeds. Also commonly known as phase cannons.

Phase Cannon: (see Particle Cannon)

Phaser: A directed-energy/particle weapon in common use aboard Star Fleet vessels, as well as other UFP and foreign fleets. Based upon rapid radion effect, it generates a wide-band particle beam utilizing both electromagnetic and subspace components.

Plasma Cannon: A projectile weapon in common use aboard early space vessels. A sublight weapon, the cannon generates, contains, and directs the release of ionized matter. The weapon is often complemented by particle and/or laser weapon systems.

Prototype: a vessel constructed (or modified) to perform tests and trials of a potential new class (or subclass) of ship.

Running Light: Red (port/left) and green (starboard/right) lights traditionally denoting the observed side of a water vessel under low light conditions. Utilized for similar purposes by space vessels of the UFP though generally for rapid orientation by the pilots/helms of other vessels maneuvering in close proximity. Not to be confused with yellow navigation lights.

SCE: (see Star Fleet Corps of Engineers)

Scout: A small to medium, fast research and/or reconnaissance space vessel, equipped with extensive sensor and research equipment. Though protected by defensive energy weapons, most substitute probe launchers for torpedoes.

Series: a succession of vessels all deriving from one standard, comprised of the original class, subclasses, flights, and types. Ex: the Constitution series

Shuttle: An auxiliary craft carried by larger vessels for orbit-to-ground transportation or detached operations. Also used for starbase liaison duties.

Shuttlepod: Very small auxiliary craft used for ship-to-ship or orbit-to-ground transportation, free-space maintenance, and repair work, and detached operations of a very limited nature. Usually not equipped with a warp drive.

Star Fleet: The primary exploration and defense organization of the UFP. Formed in 2161 to protect the integrity of the Federation and the safety of its members and to expand the knowledge of the member cultures.

Star Fleet Corps of Engineers: the special construction, maintenance, repair, and public engineering management agency (an echelon of Star Fleet Engineering) for both Star Fleet and the Federation. The SCE is often tasked with building and maintaining facilities both standard and exotic, as well as providing rapid response to engineering problems that occur far from Federation resources.

Starfleet: Short-hand name for the United Earth Starfleet (UESF), the primary exploration and defense organization of United Earth 2033-2161. Not to be confused with the UFP Star Fleet. Renamed Earth Fleet upon the formation of the United Federation of Planets.

STL: abbreviation for Slower Than Light.

Subclass: A significant variant of a given class of ship, usually newbuilds, though sometimes including important modifications to existing ships, that are not intended to replace the existing ships of the original class. Often named for the first ship to reach that final intended production standard.

Tender: An auxiliary vessel specifically designed for deep space replenishment and support of starships and other vessels. While often equipped with a tractor device, the inability to efficiently tow another vessel in warp distinguishes the tender from a tug.

Testbed: a vessel constructed (or modified) as a platform to test new technologies, with the vessel not necessarily transitioning to an operational status.

TNG: Terrance-Nelorr Graduated scale where upon each full warp factor is achieved when a certain number of cochranes were met in output, resulting in more efficient engine plateaus. In this scale, Warp 10 is unattainable.

Torpedo: The general designation for warp-capable guided projectile weapons, in contrast to sublight-only guided missiles.



## GLOSSARY (CONTINUED)

**Transport:** A Starship or other vessel dedicated to transporting passengers or cargo. They range in size from small two- or three-crew ships to huge starships and freighters.

**Transwarp Drive:** The common name for drive systems capable of higher speeds and efficiencies than the warp drive currently in use throughout the Federation. Promising venues of research include deep subspace immersion, new power regulation methods, dimensional rift techniques, and time manipulation. No practical drives of these types are yet available at this time.

**Tug:** 1) A warp-powered ship specifically designed to extend her warp field around objects that can thereafter be towed at warp speeds. Primarily used for the carriage of transport pods and towing of disabled starships or other equipment lacking appropriate motive capabilities. 2) A craft designed to propel ships or equipment lacking motive power about a limited area of operation, such as a space dock or construction site. May also refer to such a vessel intended to assist ships maneuvering within and in the vicinity of docking facilities.

**TW:** TerraWatt

**Tyme Barrier:** The exponential growth in the power required by early warp nacelles as FTL speeds approached warp factor 7 (on the OCU scale).

**Type:** a variant to a class, subclass, or flight that is extremely limited in numbers and not intended to supplant the origin category. Oftentimes used to explore potential variations for future upgrades. Ex: the Bonhomme Richard subclass (Type 2)

**UEDP:** United Earth Defense Pact. Formed by the NUN in 2069 to put the "Earth's ascendancy and safety ahead of national goals". Tasked with the combined command and control of the planet's various armed forces, it became the de facto world government upon the NUN's second dissolution in 2079, until superseded by the United Earth government in 2130.

**UES:** United Earth Ship. Ship prefix for the names of vessels of the UESN.

**UESF:** (see Starfleet)

**UESN:** United Earth Stellar Navy. Predecessor to the UESF. Formed under the authority of the United Earth Defense Pact in 2069.

**UESPA:** United Earth Space Probe Agency. Formed by the NUN in 2067, relieving the ISA of the coordination and development of human presence in interstellar space. Re-purposed as the exploration arm of the NUN in 2069.

**UESS:** United Earth Space Ship. Ship prefix for the names of vessels of the United Earth Starfleet.

**UFP:** United Federation of Planets. Formed in 2161 by a coalition of United Earth, the Andorian Empire, Tellar, Alpha Centauri, and the Confederacy of Vulcan, following the Romulan War.

**UFP SF:** (see Star Fleet)

**USS:** UFP Star Fleet Starship. Ship prefix for the names of Star Fleet vessels, emblazoned on ship hulls (along with the ship's registry number). Commonly abbreviated as "United Starship" in verbal communication, although the expressions "United Spaceship" and "Federation Starship" are also frequently used.

**Work Pod:** The general name for manned, sub-impulse craft used for construction, maintenance, repair, and other service tasks in space. A variety of external tools and modules are attached to the work pods to facilitate a multitude of tasks.



Delta Dynamics appreciates the sponsorship of the following:



Tigan Pergium Mining



Federation News Network (FNN)



Earth Sciences Institute



Plexicorp



The Anbo-iyutsu Society



Utopia Planitia Shipyards



Vulcan Science Academy



Starfleet Academy

...and Members like you.



THE FOLLOWING ARE OTHER STARSHIP RECOGNITION MANUALS  
PUBLISHED BY DELTA DYNAMICS:

## **REPORTS**

- BONAVENTURE survey cruiser
- BONAVENTURE dilithium power testbed
- BURKE frigates
- CONSTITUTION heavy cruisers
- DURANCE cargo tugs
- HORIZON heavy cruisers
- SYRACUSE destroyers
- TRENT destroyers

