

# STAR FLEET

## STARSHIP RECOGNITION MANUAL

*REPORT:*

*BURKE FRIGATES*

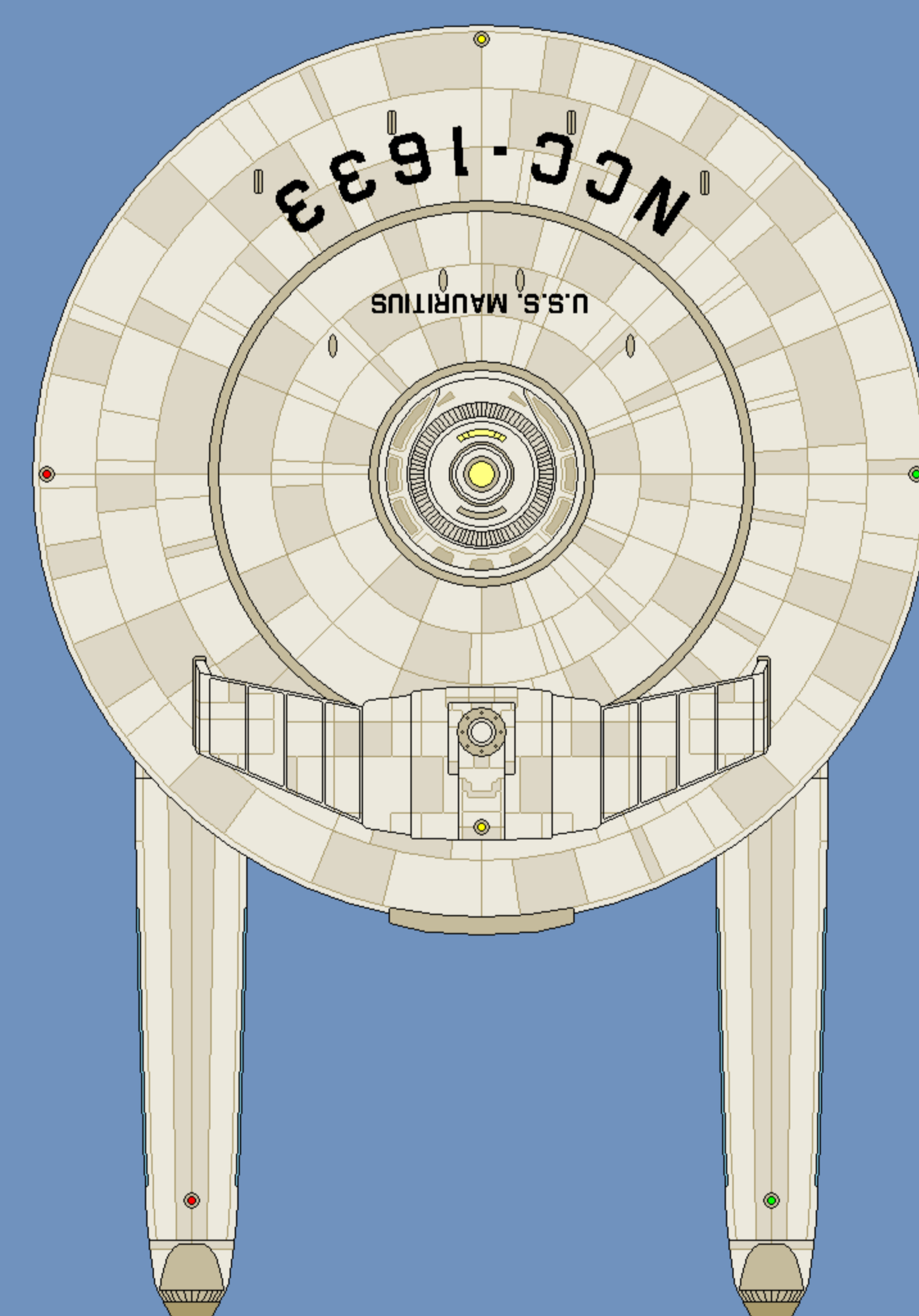



## FORWARD

My contribution to this project would not have been possible without those who came before me. Mainly CaptShade, whose original drawings laid the foundation for my work by providing me the figurative and literal tools for my own creative output. Nichodo, who was a big help in creating aft and ventral views of various components. RevancheRM, whose ideas and drive helped me get a little more creative and better at something I really enjoy. And, most definitely Neale "Vance" Davidson, whose enormous volume of work got me interested in doing this in the first place, and for inspiring us all.

- Adrasil

First, as always, thanks to Adrasil. Since partnering with him, I've taken some great artwork and added some context to it. He's really allowed me to scratch my writing itch, to the point it sometimes bleeds, but still feels Oh-So-Good. Next up, of course, is Timo Saloniemi, who's work I've been following for around two decades and I greatly respect. The artwork in these "Starship Recognition Manuals" are 97% based upon the ones he describes textually in his grand opus, the "Hobbyist's Guide to the UFP Starfleet and Its History," and 3% derived from what he has inspired in us.

- RevancheRM

Additional reports may be found at: [starshiptracker.com/deltadynamics](http://starshiptracker.com/deltadynamics)

## CREDITS

ADRASIL: All imagery (unless otherwise credited)

[www.DeviantArt.com/Adrasil](http://www.DeviantArt.com/Adrasil)

REVANCHERM: All writing (unless otherwise credited)

[www.DeviantArt.com/RevancheRM](http://www.DeviantArt.com/RevancheRM)

NEALE 'VANCE' DAVIDSON/JAYNZ: Project & cover concepts

[www.DeviantArt.com/TFVanguard](http://www.DeviantArt.com/TFVanguard)

[Jaynz.Trekships.org](http://Jaynz.Trekships.org)

TIMO SALONIEMI: Author of "Hobbyist's Guide to the UFP Starfleet", the inspiration for these

SRMs. A direct link to his Google Drive may be found on most deviations in

RevancheRM's gallery.

VIPERAVIATOR: Source of adapted cover starburst

[www.DeviantArt.com/ViperAviator](http://www.DeviantArt.com/ViperAviator)

BURKE CLASS:

-Original inspiration from: Star Trek (2009), Star Fleet Battles, Star Trek: Axanar & Tobias Richter

-Incorporated parts from: CaptShade & Nichodo

## NOTE FROM THE WRITING EDITOR

These ships do not always exactly match the specifications Timo provides in his technical section for each class, as I've adapted them in ways that allowed them to fit a bit better with the guidance provided by the starship construction rules in Steven Long's "Spacedock". I've also changed some dates around when I found them in conflict with other information Timo has provided. These two books greatly inform my own alpha-canon and I urge you to look up both online, as offered free by their respective authors. (Links to both are provided on the Delta Dynamics site.)

Delta Dynamics' Starship Recognition Manual, along with the Reports and all other similar publications released under that branding, are released as a public service to familiarize interested beings with the historic starship designs and technical developments of the United Federation of Planets Star Fleet, its member and preceding services, and those services of regional galactic neighbors. Despite the occasional presence of a sensitive nature of both those historic events and technical matters discussed herein, the distribution and handling of this publication has been ruled Security Grade O (Unclassified) by Star Fleet Support Operations, Office of Security.

Copyright 2419 by Delta Dynamics, Wellington, Earth.

Memory Terra/Memory Alpha Cataloging Data: UFP ITP/TE 7259381460291

Under the laws of the United Federation of Planets and its members, use or reproduction (in whole or in part) of the information contained in this publication—along with proper attribution of its source—is granted. This edition is authorized for distribution only in member star systems of the UFP its territories and possessions, affiliated star systems, and select independent or neutral star systems. "Star Trek" and all related likenesses are copyrights and trademarks of CBS Television Studios and Paramount Pictures. This publication has been established for informational and entertainment purposes only. No infringement of copyright nor trademark is intended.



## CONTENTS

BURKE	NEARSPACE FRIGATE	PG 02:01
ALDRIN	DEEP SPACE FRIGATE	PG 02:05
BURKE FLIGHT II	NEARSPACE FRIGATE	PG 02:09
ALDRIN FLIGHT II	DEEP SPACE FRIGATE	PG 02:16
BURKE FLIGHT III	NEARSPACE FRIGATE	PG 02:22
ALDRIN FLIGHT III	DEEP SPACE FRIGATE	PG 02:26
MAGELLAN	SCOUT CRUISER	PG 02:30
BURKE FLIGHT IV	NEARSPACE FRIGATE	PG 02:34
ALDRIN FLIGHT IV	DEEP SPACE FRIGATE	PG 02:43
CLASS TIMELINE		PG 03:01
STARSHIP COMPARISON GUIDE		PG 03:04
GLOSSARY		PG 03:06
IN MEMORY		PG 03:09
OTHER PUBLICATIONS		PG 03:10

### BURKE CLASS

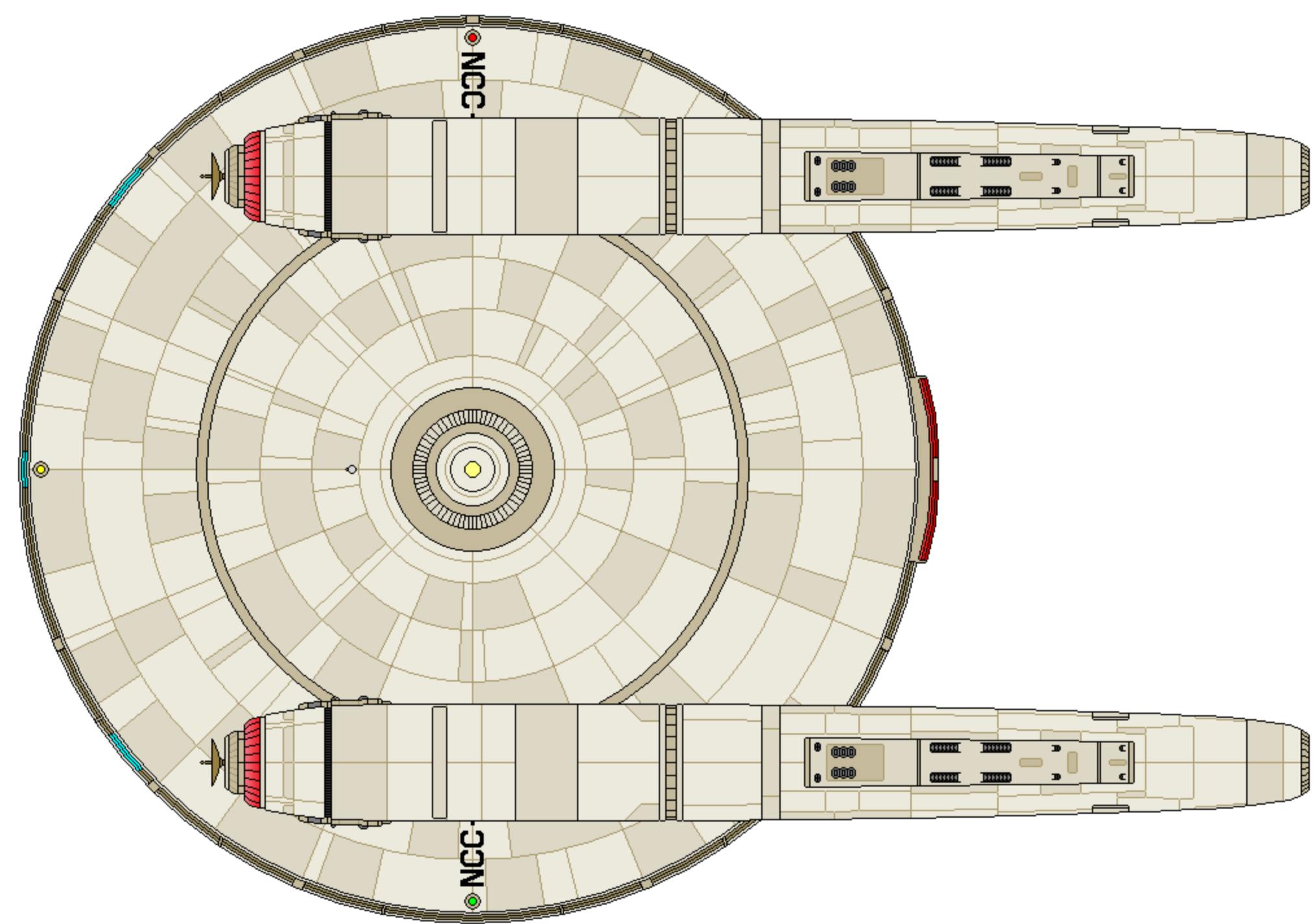
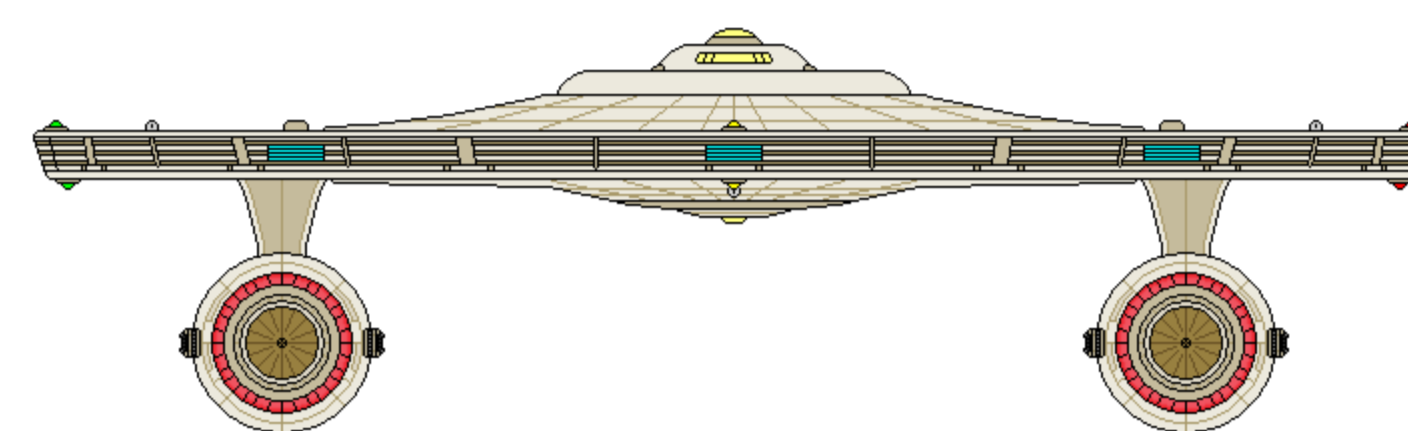
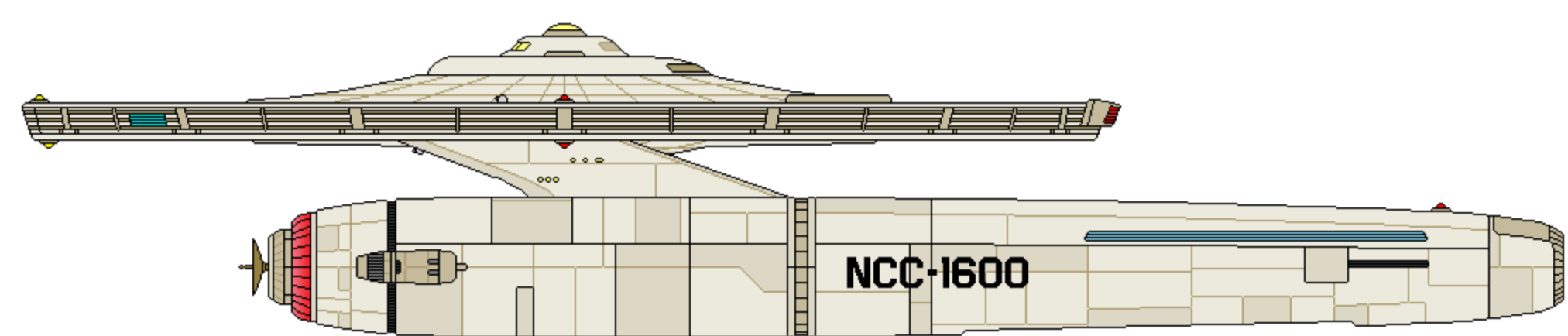
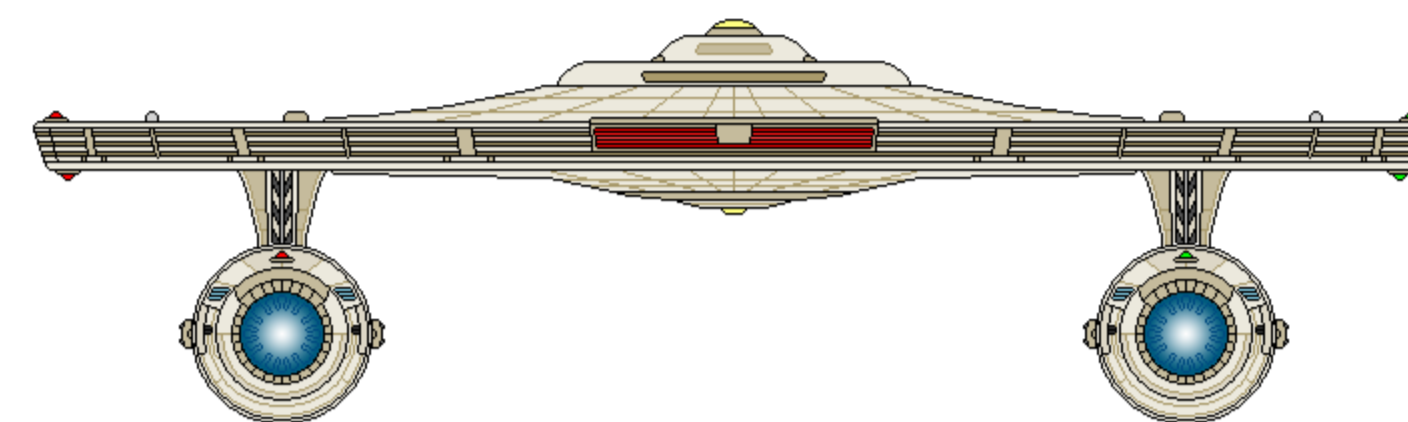
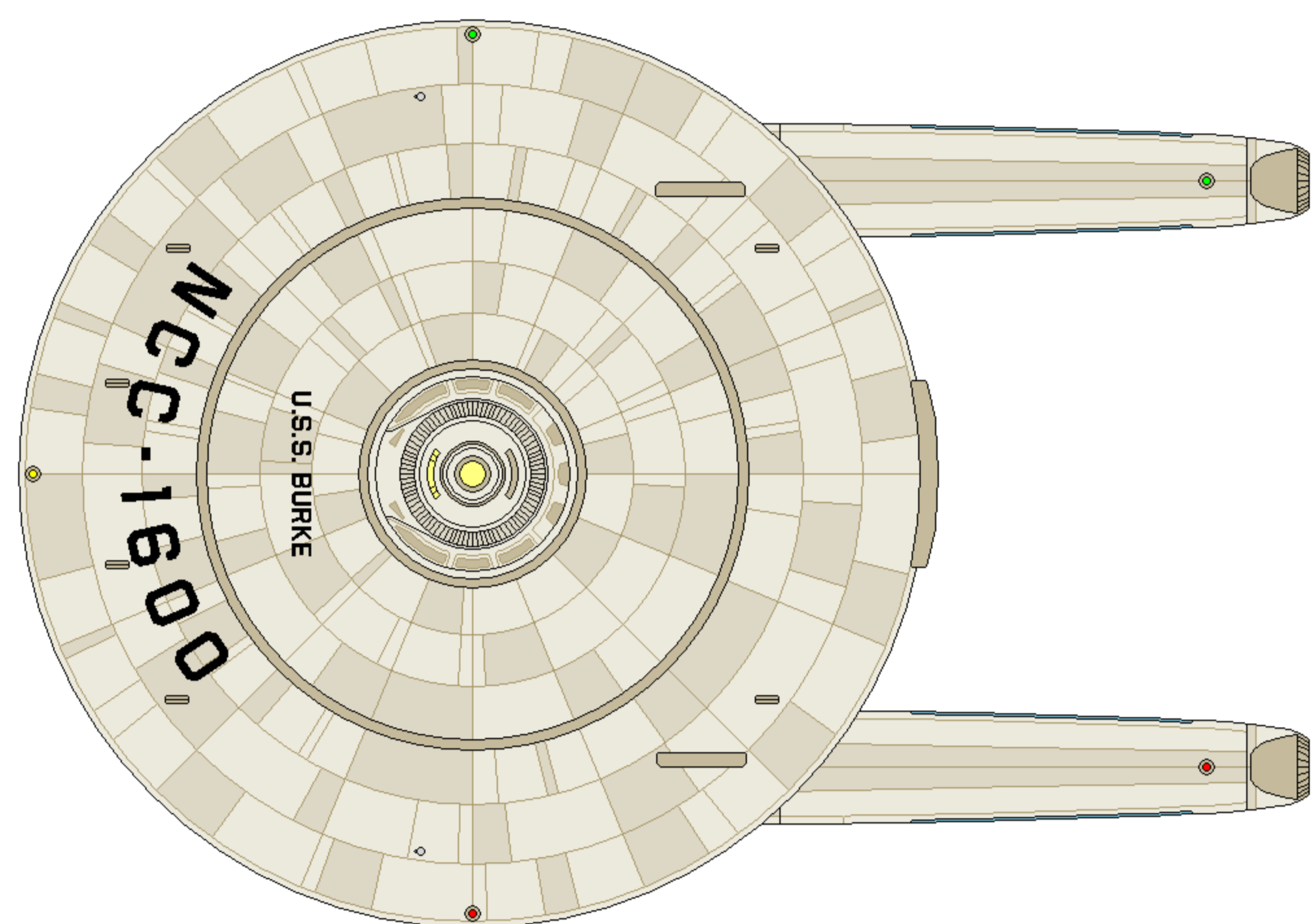

CATEGORY: NEARSPACE FRIGATE  
 OPERATIONAL: 2221 - 2237 (UPGRADED)  
 CONSTRUCTED: 43 (2221 - 2226)

DIMENESIONS:  
 LENGTH: 183.0 M  
 BEAM: 122.0 M  
 HEIGHT: 35.5 M  
 MASS: 320,000 MT

TACTICAL:  
 - 6X 2.0 GW PLASMA CANNONS  
 - 3X 1.0 GW LASER EMITTERS  
 - 2-LAYER CONFORMAL FORCEFIELD  
 - 2X PRIMARY NAVIGATIONAL DEFLECTORS  
 - 3X AUXILIARY DEFLECTOR EMITTERS

PERFORMANCE:  
 CRUISE: WARP 4 (OCU)  
 MAX: WARP 6.5 (OCU)  
 ENDURANCE: 2 YEARS

COMPLEMENT:  
 OFFICERS: 25  
 ENLISTED: 214

AUXILIARIES: NONE





## BURKE CLASS AUTHORIZED CONSTRUCTION

THE FOLLOWING SHIPS OF THE ABOVE CLASS WERE AUTHORIZED AS PART OF THE FEDERATION STAR FLEET BY FEDERATION COUNCIL APPROPRIATION.

USS BURKE	NCC-1600	USS VANGUARD	NCC-1622
USS FIREFLY	NCC-1601	USS NIGHTHAWK	NCC-1623
USS CLAYTON	NCC-1602	USS FIREBRAND	NCC-1624
USS QUILEUTE	NCC-1603	USS ECHO	NCC-1625
USS DRAGON	NCC-1604	USS SCIMITAR	NCC-1626
USS INTERCEPTOR	NCC-1605	USS GREYHOUND	NCC-1627
USS BULWARK	NCC-1606	USS ASTUTE	NCC-1628
USS ABUNDANCE	NCC-1607	USS AQUITAINE	NCC-1629
USS EMDEN	NCC-1608	USS FREYA	NCC-1630
USS THYHLEL	NCC-1609	USS TRENCHANT	NCC-1631
USS BILLINGS	NCC-1610	USS CALDER	NCC-1632
USS MAGPIE	NCC-1611	USS MAURITIUS	NCC-1633
USS PAILLES	NCC-1612	USS ARGYLL	NCC-1634
USS SABRE	NCC-1613	USS ACACIA	NCC-1635
USS IROQUOIS	NCC-1614	USS LANCASTER	NCC-1636
USS DARING	NCC-1615	USS ALBION	NCC-1637
USS ABYSSINIA	NCC-1616	USS PROTECTOR	NCC-1638
USS RAMSEY	NCC-1617	USS MANTIS	NCC-1639
USS MAROON	NCC-1618	USS AGAMEMNON	NCC-1640
USS TRACKER	NCC-1619	USS AOTEAROA	NCC-1641
USS RAIDER	NCC-1620	USS ARTFUL	NCC-1642
USS MAYFLOWER	NCC-1621		

### GENERAL INFORMATION

In 2219, Geering (of Earth) was granted the contract for a new combatant to patrol the internal spacelanes of the Federation, now almost sixty years old. Along with the ship's mission, it was already conceptualized and visualized...just not yet designed. Geering had no issues jumping to this later development phase.

In 2221, the Burke class nearspace frigate was unveiled: comprised of two underslung nacelles and one thin but large saucer, the vessel was ready not only for immediate production, but also variation. The saucer held the entire crew complement, all of the weapons systems, computers, fuel and impulse propulsion systems, in precise modularized sections. The SAA impulse drive appeared to be an attachment to the aft centerline, extending just a slight amount above the widest deck. Within the saucer, fuel tanks rimmed the two sides, with then crew and support systems successively inboard. Two single 1.0 GW laser emitters were installed dorsally, with one on the ventral centerline, as offensive weaponry. Six dorsal berths, covered by protective portals, housed the defensive 2.0 GW plasma cannons. The contract specifically excluded torpedo weaponry, but Geering was thinking ahead by including two powered attachment points for a future weapons pod.

The dual PB-21 warp nacelles were attached by stubby support pylons to the ventral hull of the saucer. The nacelle had built-in power systems, accounting for the larger-than-expected bulk. Additionally, the nacelle's power systems also supported an integrated navigational deflector ahead of the (obstructed) Bussard collectors. These two dishes served as the primary deflection capability of the ship, supported by three auxiliary deflectors built into the saucer's forward rim.

Despite the complex nature of the nacelles, they were not considered to be super-performers; quite the contrary, they were fuel hogs and were capable only of propelling the ship's up to warp 6.5, with an endurance of 2 years. Geering was adamant they were necessary to properly equipping the saucer with all of the combat and support services that would otherwise be in space competition with an internal warp core.

The ships set sail with 239 crew (25 officers, 214 enlisted). Dimensions for the Burkes were 183 meters of length, 122 along the saucer's beam, and a height of 35.5, and massed 320,000 metric tons. Primary forcefields were of the 2-layer conformal type, with the extendable support of the two primary and three auxiliary deflectors. Two 6-person Mk general purpose and two 22-person emergency transporters were installed, and no auxiliary craft were provided. A total of 43 (original) Burkes were constructed by 2226.

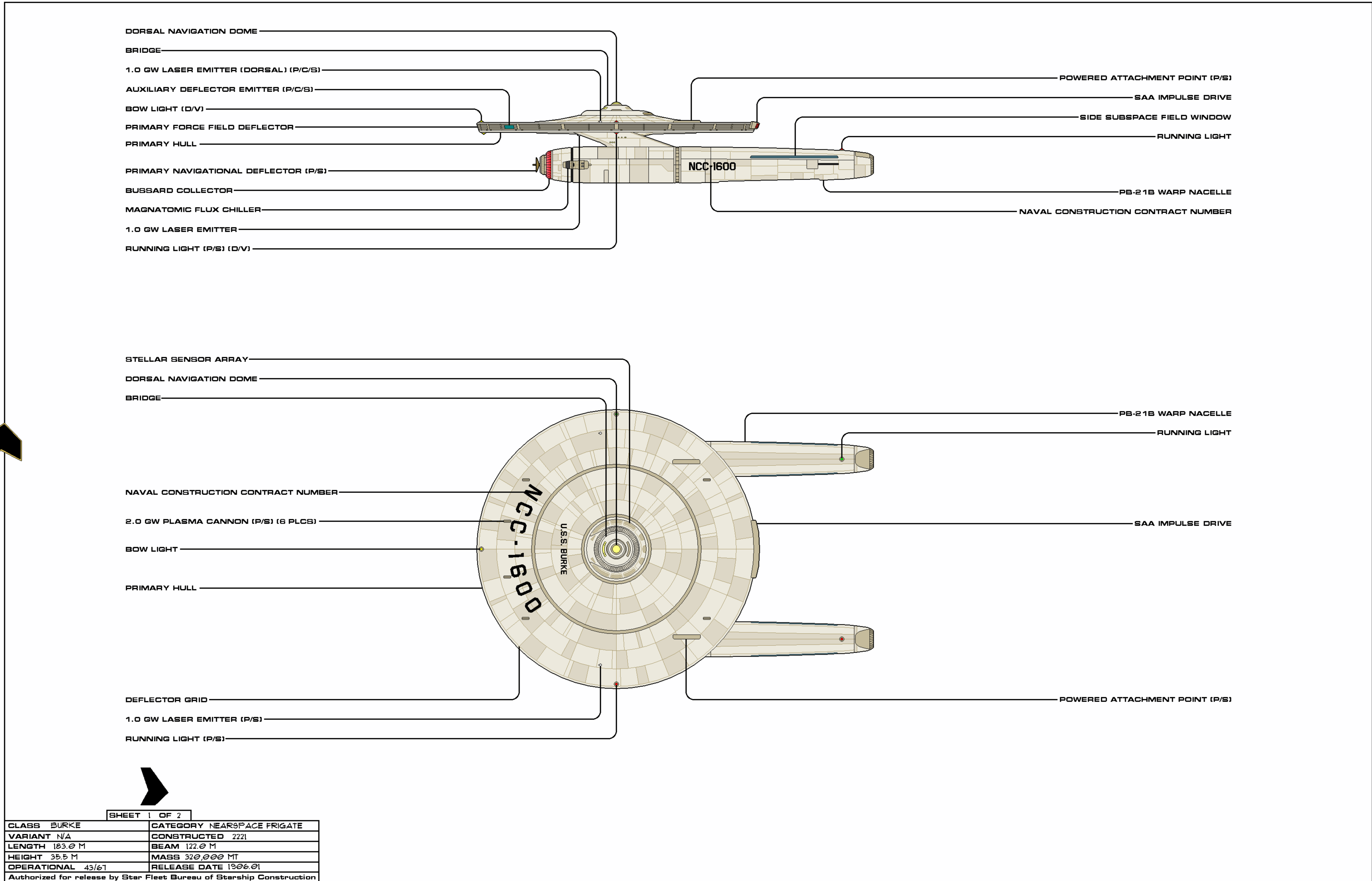

SHEET 1 OF 2

CLASS	BURKE	CATEGORY	NEARSPACE FRIGATE
VARIANT	NA	CONSTRUCTED	2221
LENGTH	183.0 M	BEAM	122.0 M
HEIGHT	35.5 M	MASS	320,000 MT
OPERATIONAL	43/67	RELEASE DATE	1900.01

Authorized for release by Star Fleet Bureau of Starship Construction

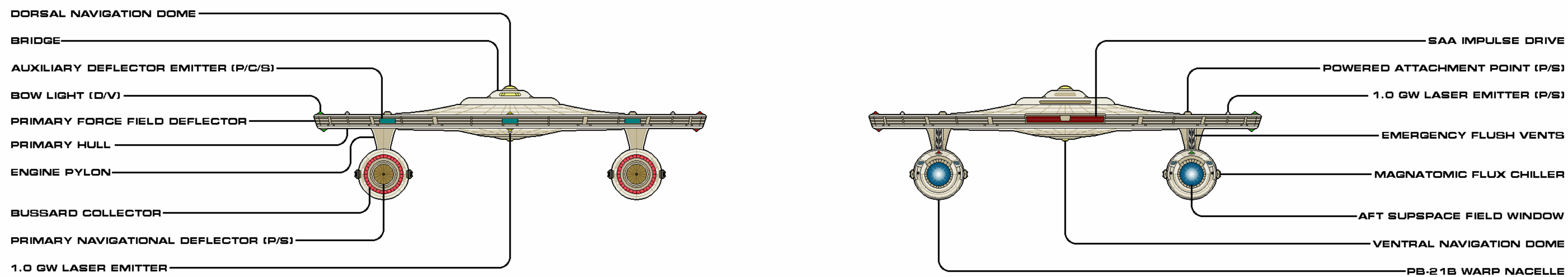
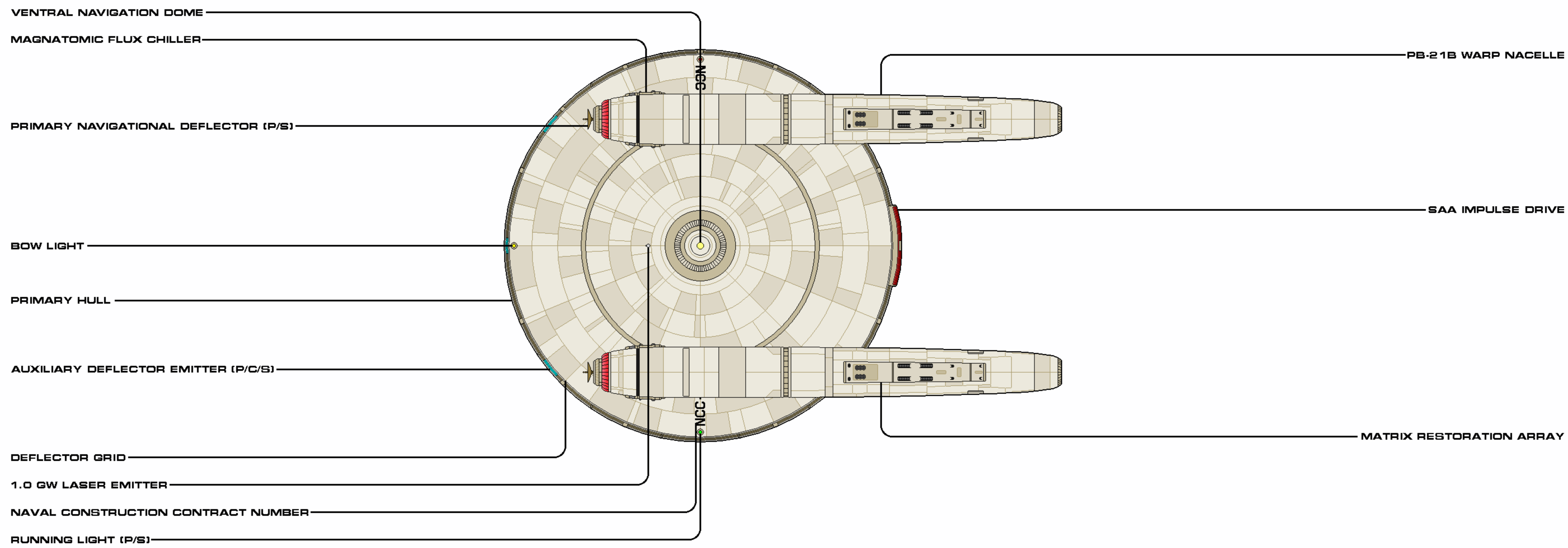

SHEET 2 OF 2

CLASS	BURKE	CATEGORY	NEARSPACE FRIGATE
VARIANT	N/A	CONSTRUCTED	2221
LENGTH	183.0 M	BEAM	122.0 M
HEIGHT	35.5 M	MASS	320,000 MT
OPERATIONAL	43/01	RELEASE DATE	1906.01

Authorized for release by Star Fleet Bureau of Starship Construction



ALDRIN SUBCLASS

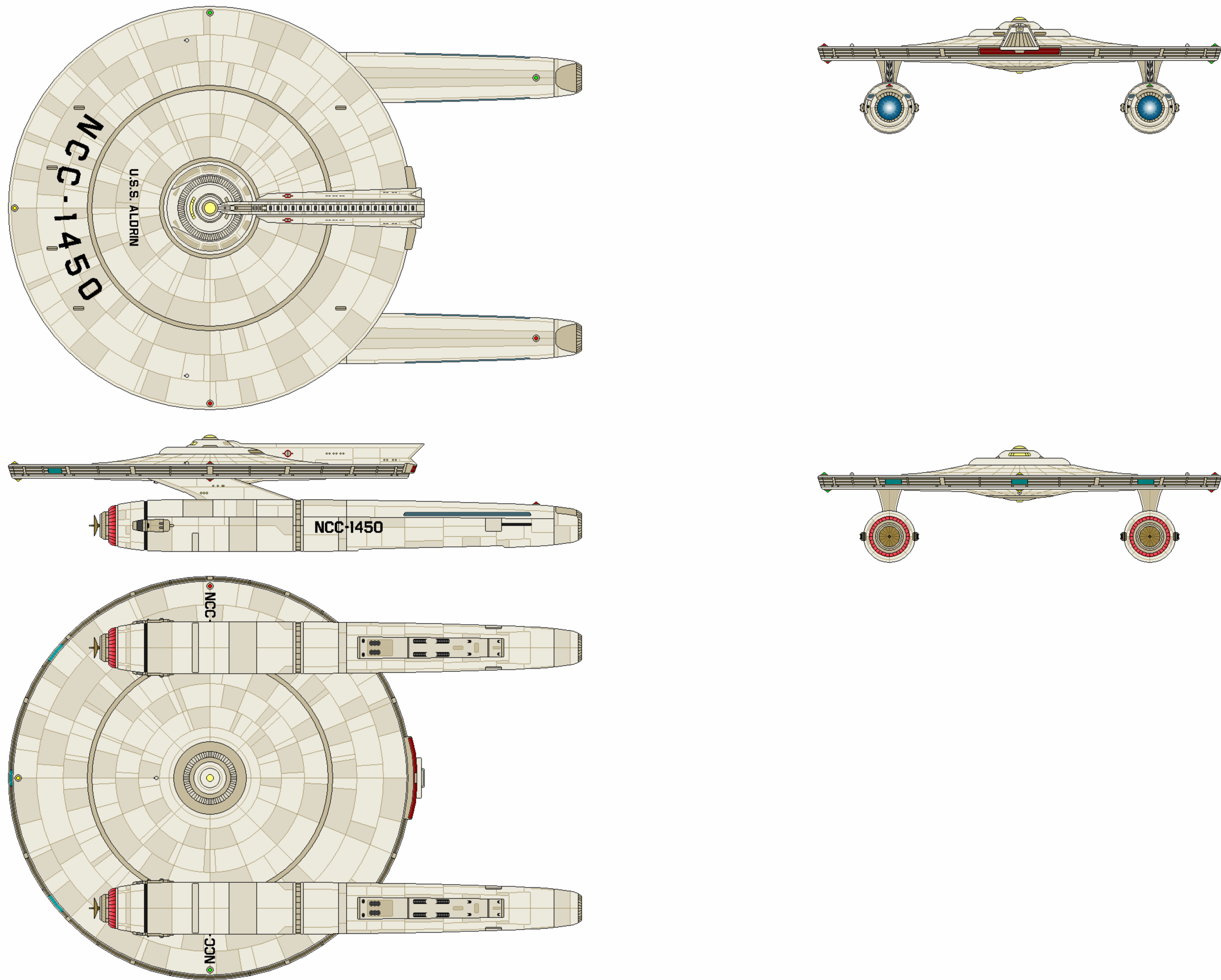

CATEGORY: DEEP SPACE FRIGATE  
 OPERATIONAL: 2222 - 2237 (UPGRADE)  
 CONSTRUCTED: 24 (2222-2225)

DIMENESIONS:  
 LENGTH: 183.0 M  
 BEAM: 122.0 M  
 HEIGHT: 35.5 M  
 MASS: 325,000 MT

PERFORMANCE:  
 CRUISE: WARP 4 (OCU)  
 MAX: WARP 6.5 (OCU)  
 ENDURANCE: 3 YEARS

COMPLEMENT:  
 OFFICERS: 25  
 ENLISTED: 214

TACTICAL:  
 - 6X 2.0 GW PLASMA CANNONS  
 - 3X 1.0 GW LASER EMITTERS  
 - 2-LAYER CONFORMAL FORCEFIELD  
 - 2X PRIMARY NAVIGATIONAL DEFLECTORS  
 - 3X AUXILIARY DEFLECTOR EMITTERS

AUXILIARIES:  
 - 4X WORK PODS





## ALDRIN SUBCLASS AUTHORIZED CONSTRUCTION

THE FOLLOWING SHIPS OF THE ABOVE CLASS WERE AUTHORIZED AS PART OF THE FEDERATION STAR FLEET BY FEDERATION COUNCIL APPROPRIATION.

USS ALDRIN	NCC-1450	USS MAGELLAN	NCC-1462
USS MOGENSEN	NCC-1451	USS RELENTLESS	NCC-1463
USS IRWIN	NCC-1452	USS ZHAI	NCC-1464
USS DYOMIN	NCC-1453	USS ZHANG	NCC-1465
USS MITCHELL	NCC-1454	USS SHACKLETON	NCC-1466
USS BEAN	NCC-1455	USS CHRETIEN	NCC-1467
USS SHARMAN	NCC-1456	USS SCHMITT	NCC-1468
USS DUKE	NCC-1457	USS FRIMOUT	NCC-1469
USS FEI	NCC-1458	USS JAHN	NCC-1470
USS ZHENG HE	NCC-1459	USS VESPUCCI	NCC-1471
USS HADFIELD	NCC-1460	USS VASCO DA GAMA	NCC-1472
USS ATKOV	NCC-1461	USS KOTOV	NCC-1473

---

### GENERAL INFORMATION

With the first ships of the Burke class slipping the rails, Star Fleet gave the go-ahead to Geering to produce a Mark II version, one intended to have a longer endurance and patrol the areas of the Federation not normally visited by the charted spacelanes. Adding 5,000 metric tons to the design was an extension aft of the bridge, along the saucer's spine. The interior provided extended fuel tanks, storage for consumables, a workshop, and a small hanger ("hangerette") to house a small number of repair pods. On either side, closer to the pilot house and one deck below, were docking ports. The powered attachment points on the Burke's saucer were left off, for the attachment rail along the top of the spinal extension would allow optional equipment to be quickly installed to these Aldrins, equipment that would preclude the type of weapon pods being planned for the Burkes.

The extension did increase the operational range of the class by 50%, which wasn't saying much, since the increase was only an additional year (from two). The PB-21B warp nacelles were not the workhorses necessary to take advantage of the extra fuel, so the frigates did not so much push the boundaries of the Federation than allow the cruisers and other explorers the freedom to not linger in the nether areas of semi-explored space. However, the subclass did benefit from minor improvements in sensors, targeting and computing power.

A total of 24 Aldrins were constructed by 2225.

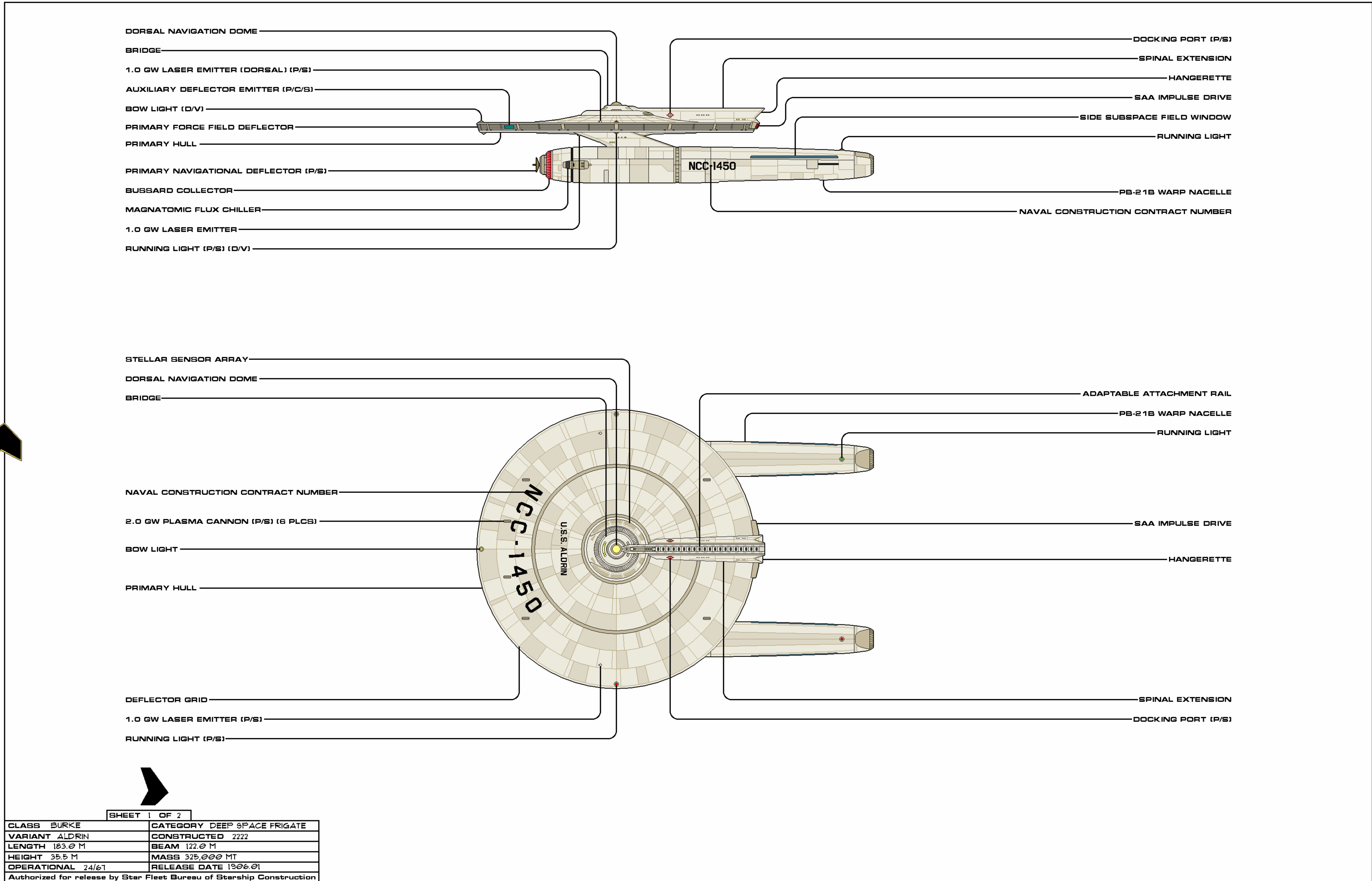

SHEET 1 OF 2

CLASS	BURKE	CATEGORY	DEEP SPACE FRIGATE
VARIANT	ALDRIN	CONSTRUCTED	2222
LENGTH	183.0 M	BEAM	122.0 M
HEIGHT	35.5 M	MASS	325,000 MT
OPERATIONAL	24/61	RELEASE DATE	1906.01

Authorized for release by Star Fleet Bureau of Starship Construction

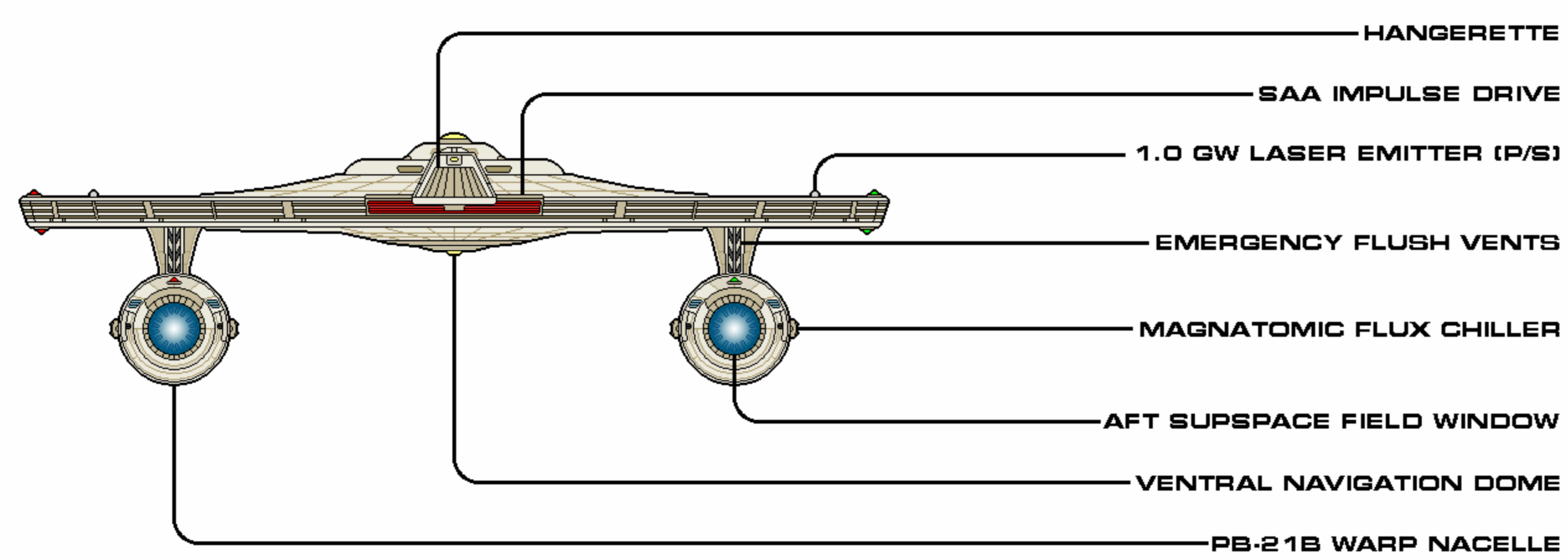
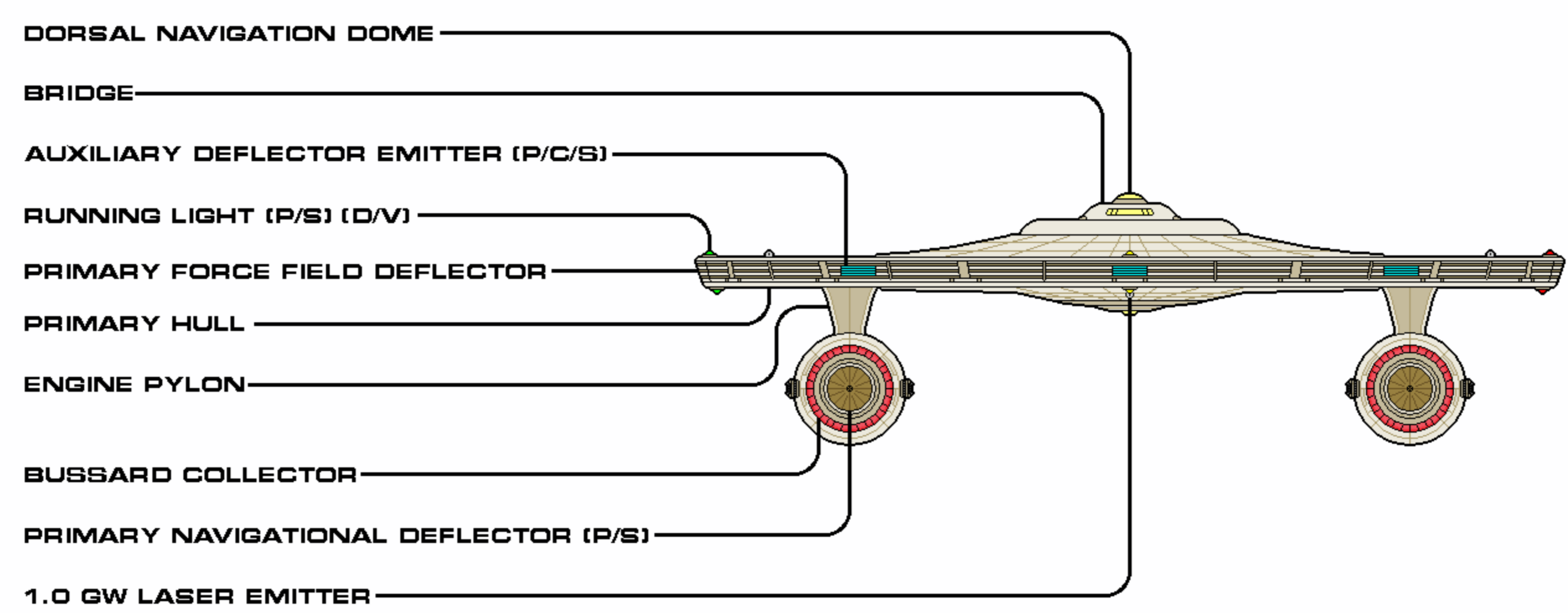
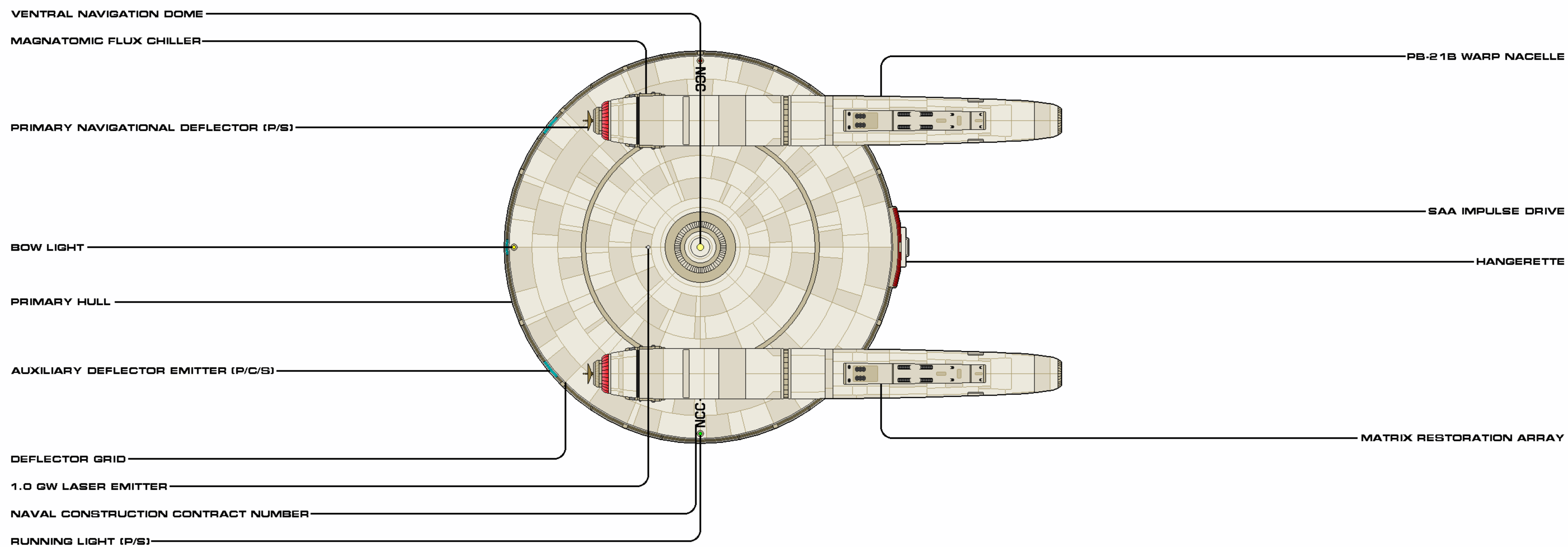

SHEET 2 OF 2

CLASS	BURKE	CATEGORY	DEEP SPACE FRIGATE
VARIANT	ALDRIN	CONSTRUCTED	2222
LENGTH	183.0 M	BEAM	122.0 M
HEIGHT	35.5 M	MASS	325,000 MT
OPERATIONAL	24/61	RELEASE DATE	1906.01

Authorized for release by Star Fleet Bureau of Starship Construction



BURKE FLIGHT II

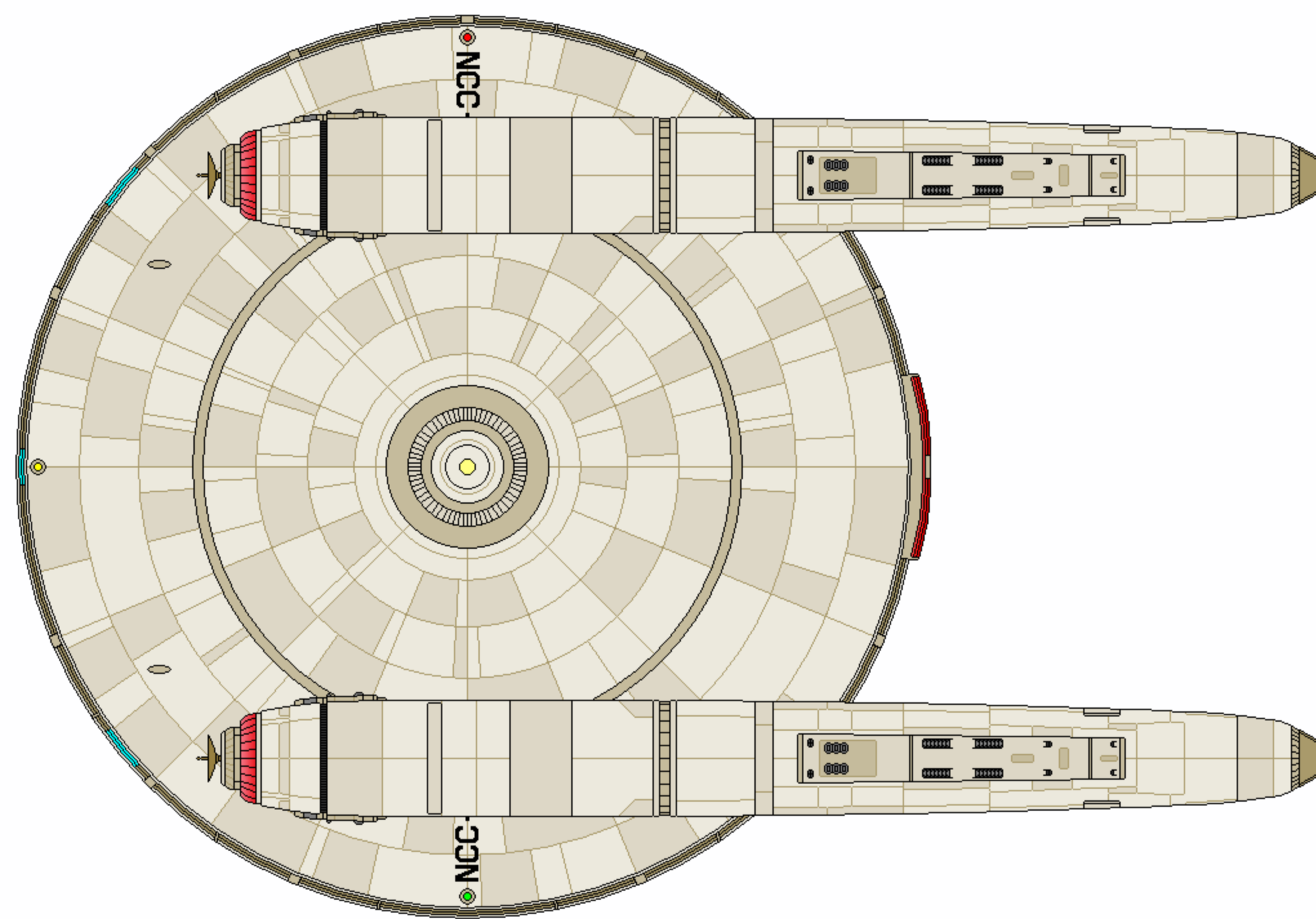
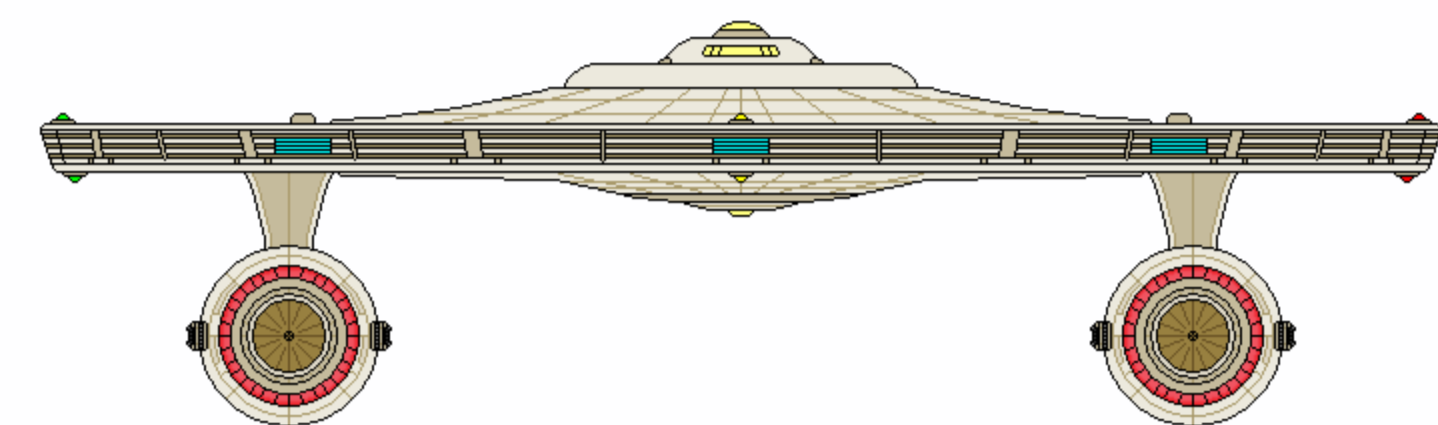
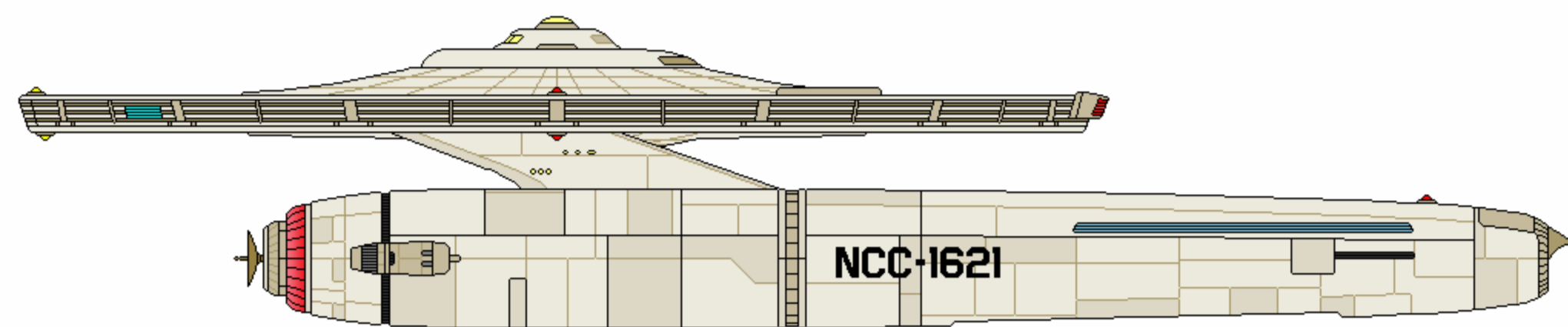
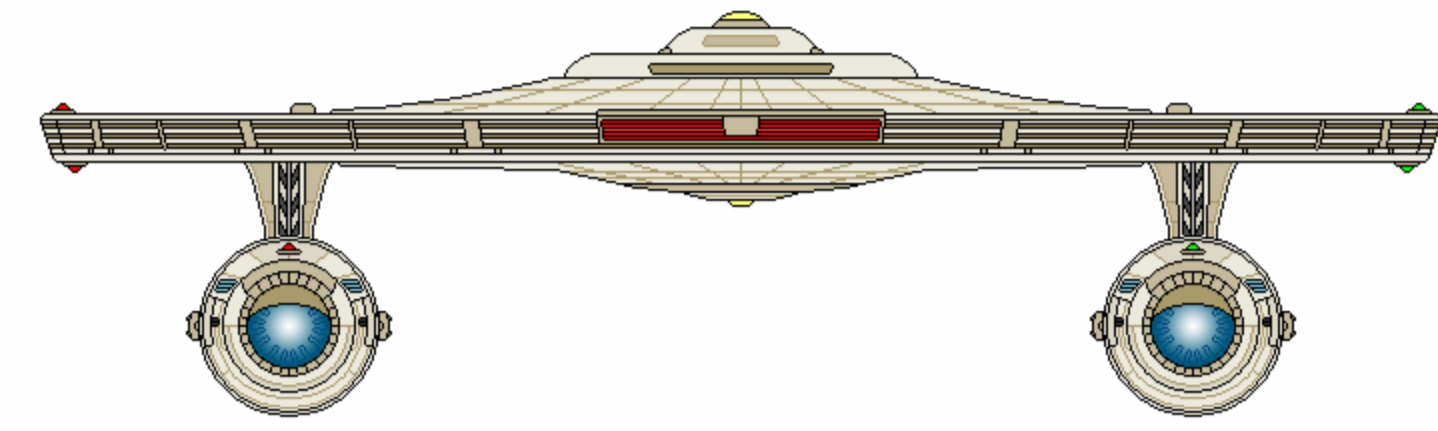
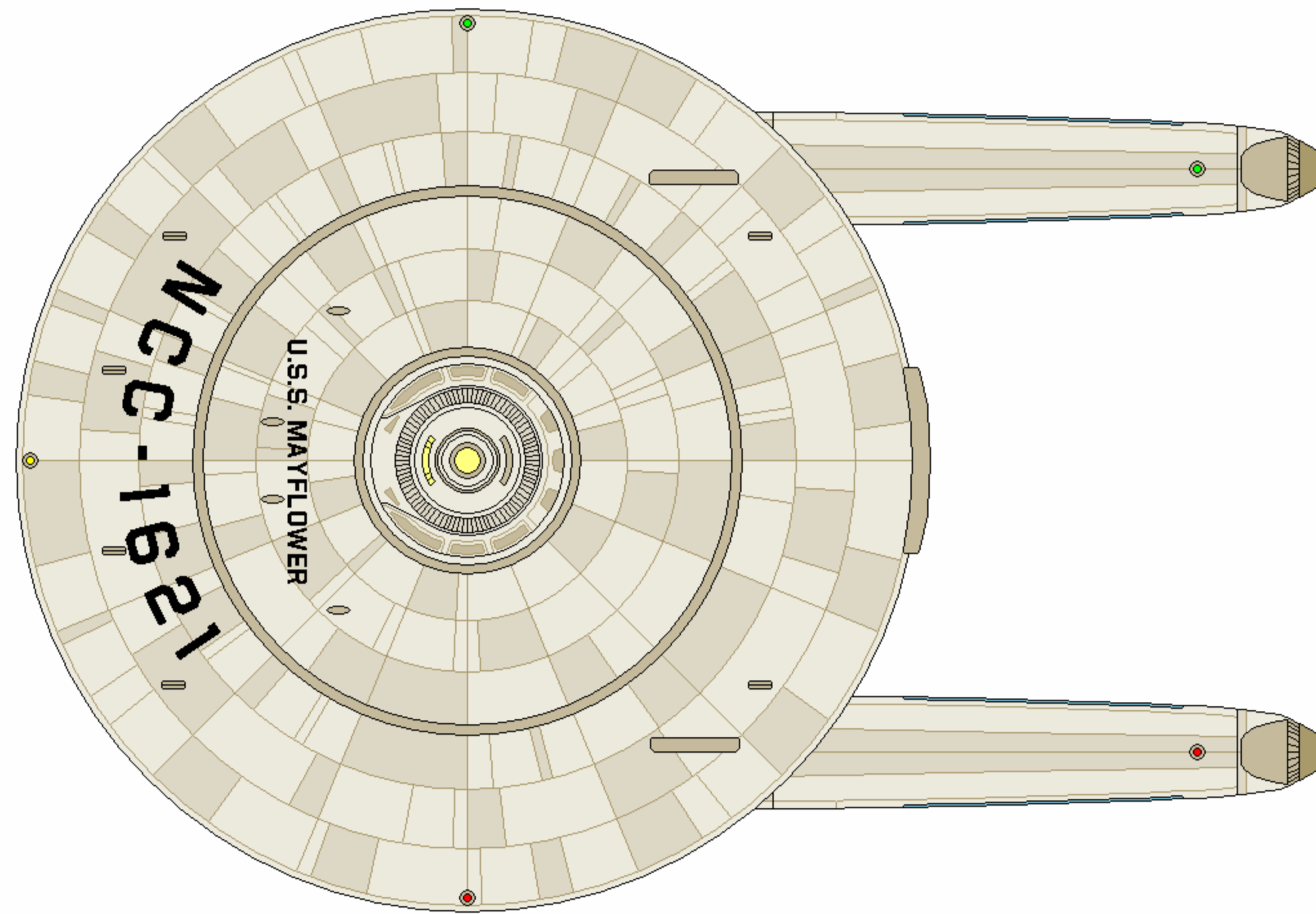

CATEGORY: NEARSPACE FRIGATE  
 OPERATIONAL: 2235 - 2254 (UPGRADED)  
 MODIFIED: 43 (2235 - 2237)

DIMENESIONS:  
 LENGTH: 186.4 M  
 BEAM: 122.0 M  
 HEIGHT: 35.5 M (39.9 POD)  
 MASS: 320,000 MT

TACTICAL:  
 - 6X 2.0 GW PLASMA CANNONS  
 - 6X 1.2 TW TYPE L PHASED PARTICLE CANNONS  
 - 2-LAYER CONFORMAL FORCEFIELD  
 - 2X PRIMARY NAVIGATIONAL DEFLECTORS  
 - 3X AUXILIARY DEFLECTOR EMITTERS  
 - OPTIONAL: 2X-4X MEDIUM TORPEDO TUBES  
 (W/ 40 TORPEDOES)

PERFORMANCE:  
 CRUISE: WARP 4 (OCU)  
 MAX: WARP 6.5 (OCU)  
 ENDURANCE: 2 YEARS

COMPLEMENT:  
 OFFICERS: 25  
 ENLISTED: 214

AUXILIARIES: NONE





## BURKE FLIGHT II AUTHORIZED CONSTRUCTION

THE FOLLOWING SHIPS OF THE ABOVE CLASS WERE AUTHORIZED AS PART OF THE FEDERATION STAR FLEET BY FEDERATION COUNCIL APPROPRIATION.

USS BURKE	NCC-1600	USS VANGUARD	NCC-1622
USS FIREFLY	NCC-1601	USS NIGHTHAWK	NCC-1623
USS CLAYTON	NCC-1602	USS FIREBRAND	NCC-1624
USS QUILEUTE	NCC-1603	USS ECHO	NCC-1625
USS DRAGON	NCC-1604	USS SCIMITAR	NCC-1626
USS INTERCEPTOR	NCC-1605	USS GREYHOUND	NCC-1627
USS BULWARK	NCC-1606	USS ASTUTE	NCC-1628
USS ABUNDANCE	NCC-1607	USS AQUITAINE	NCC-1629
USS EMDEN	NCC-1608	USS FREYA	NCC-1630
USS THYHLEL	NCC-1609	USS TRENCHANT	NCC-1631
USS BILLINGS	NCC-1610	USS CALDER	NCC-1632
USS MAGPIE	NCC-1611	USS MAURITIUS	NCC-1633
USS PAILLES	NCC-1612	USS ARGYLL	NCC-1634
USS SABRE	NCC-1613	USS ACACIA	NCC-1635
USS IROQUOIS	NCC-1614	USS LANCASTER	NCC-1636
USS DARING	NCC-1615	USS ALBION	NCC-1637
USS ABYSSINIA	NCC-1616	USS PROTECTOR	NCC-1638
USS RAMSEY	NCC-1617	USS MANTIS	NCC-1639
USS MAROON	NCC-1618	USS AGAMEMNON	NCC-1640
USS TRACKER	NCC-1619	USS AOTEAROA	NCC-1641
USS RAIDER	NCC-1620	USS ARTFUL	NCC-1642
USS MAYFLOWER	NCC-1621		

### GENERAL INFORMATION

Between 2235 and 2237, all 67 vessels of the overall Burke class entered drydocks and spacedocks for their standard refit periods. The most important tactical upgrade they each received was having the three laser emitters removed and replaced with six Type L phased particle cannons of 1.2 terrawatt capacity, secured by spacetight hatches. Four were provided on the dorsal saucer, with the remaining two on the ventral side.

A lack of satisfaction with the PB-21B nacelle crafted to the mission profile of the frigates was primarily focused on the range capacity afforded the ship, which was limited to a cruise limit of warp 4, and a maximum speed of warp 6.5. Modelling suggested that a reflux of the warp field, focused on the immediate aft, along with a few other longevity and internal maintenance tweaks, might tip the scales of efficiency a bit in the ships' favor; a subspace field visor coupled on to the extreme end of the nacelles, however, did not support the results of the modelling. They were not removed, as they seemed to have no effect one way or the other, other than somewhat restricting the light emissions from that particular field window.

A versatile ship is a valuable ship. This concept was not unknown in Star Fleet in the 2210s, but practicality must outweigh lofty ideas; frigates were easy to pigeon-hole into the function of patrollers. Before Geering was selected to design and assemble the Burkes (in 2219), the idea of a torpedo-capable frigate was discarded as far from as important as getting responsive and capable patrollers into the spacelanes. Numbers were proving critical to assuring the mercantile fleets that they could and would be protected when they raised the alarm. Complicating a design with torpedo bays and launchers would not only lengthen the amount of time to produce each individual frigate, but would come at the expense of something else that was deemed critical. Crew? Range? Neither of these were worth torpedo capability. The simple answer was to get a capable energy-armed ship out there and out there now.

Geering had the foresight to suggest that there could be a time that a torpedo-capable ship might be required in great numbers and that time might not be on the Federation's side to design and produce such a combatant in the numbers required to handle the threat. The company was able to convince Star Fleet's Office of Support Operations that by adding only two powered attachment points to the dorsal hull now, there would be plenty of time to develop an optional sled with a weapons mount. The Burkes could hit the spacelanes in the short term but be quickly upgraded with torpedo capability, when called to do so. The attachment points required so little maintenance, claimed Geering, that it would be a wise investment. The office agreed and directed Star Fleet Engineering to assist in preliminary planning for such a system.



## BURKE FLIGHT II

### GENERAL INFORMATION (CONTINUED)

The weapons sled and 4 torpedo module variants were ready well before the class' 2235 refit yard period was to begin. However, it was decided to go into full production of the pods only in preparation for the ships' tech upgrade. The four variants were produced in limited numbers each, so as to try each of the combinations equally. Torpedo launch venting was a serious concern in the cramped compartments of the modules, but venting was known to interfere with both heat build-up of the launching equipment and launch-phase targeting sensors co-located on the pods. For this reason, weapons exercises--and eventually operational combat use--were to be considered and recorded rather closely, to find which configuration was the most efficient and dependable. Of course, the ship's commanding and weapons officers would provide feedback and opinions critical to the decision makers.

The four variants were never used in any fleet operational actions. While there was certainly the opportunity, in reality operational area commanders only had the modules installed on their assigned Burke assets for the directed weapons exercises and rarely for scheduled patrols; the reason was that the other versatility of the vessel--diplomacy--was deemed far more important than the overt militarization of a respected response vessel. However, Star Fleet did not abandon the idea of the weapons pod, easily recognizing the need for such a capacity, and settled on a final configuration that was unveiled with the fourth flight of the Burkes, in 2252.

The four torpedo module variants released with the Flight II are:

- Module A: 2 forward launchers, large aft venting
- Module B: 2 forward launchers, 1 aft launcher, forward and aft venting
- Module C: 2 forward launchers, 2 aft launchers, forward and minimalized aft venting
- Module D: 3 forward launchers, 1 aft launcher, restricted forward and standard aft venting

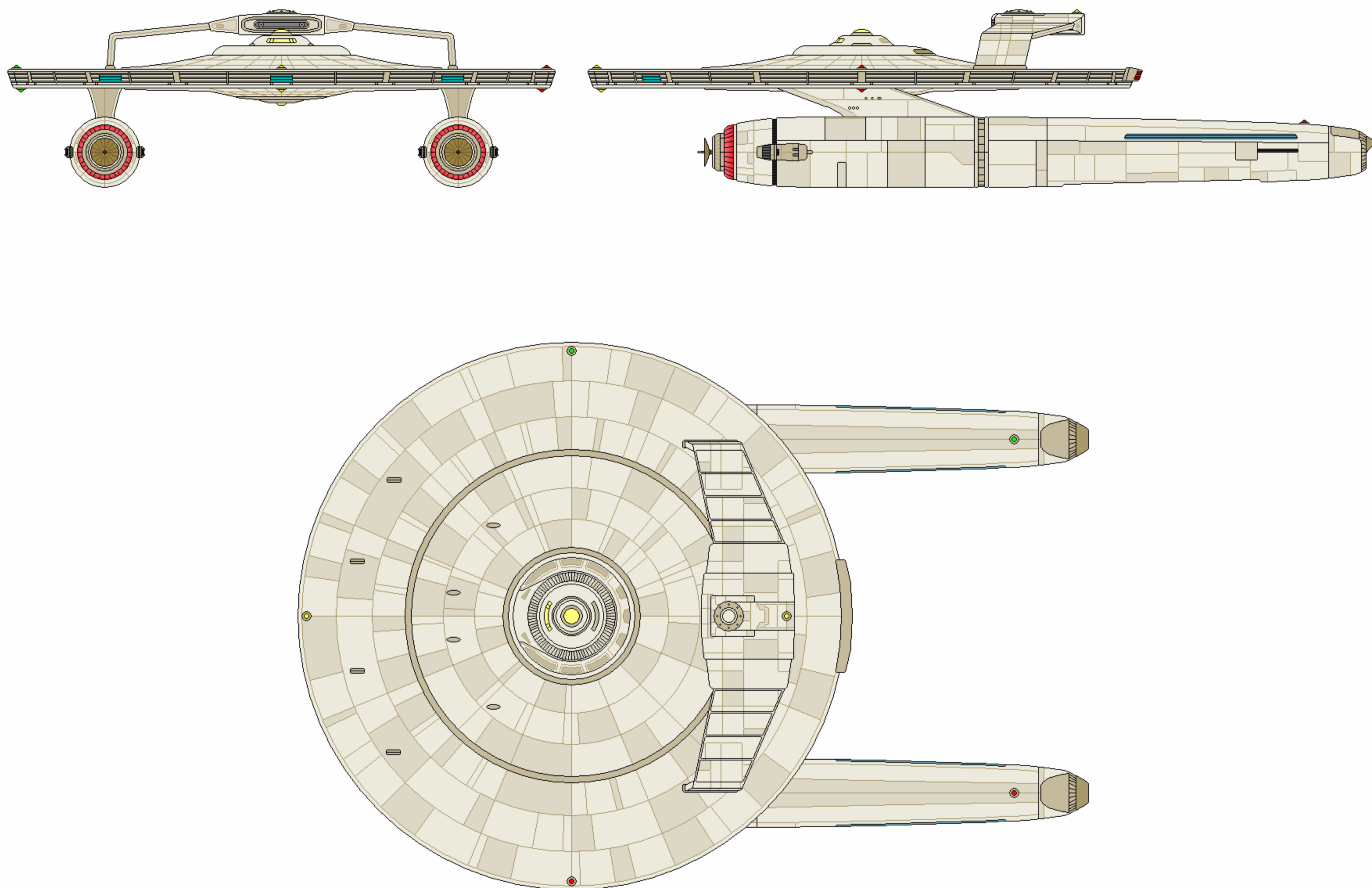

BURKE FLIGHT II  
WITH MODULAR WEAPONS POD

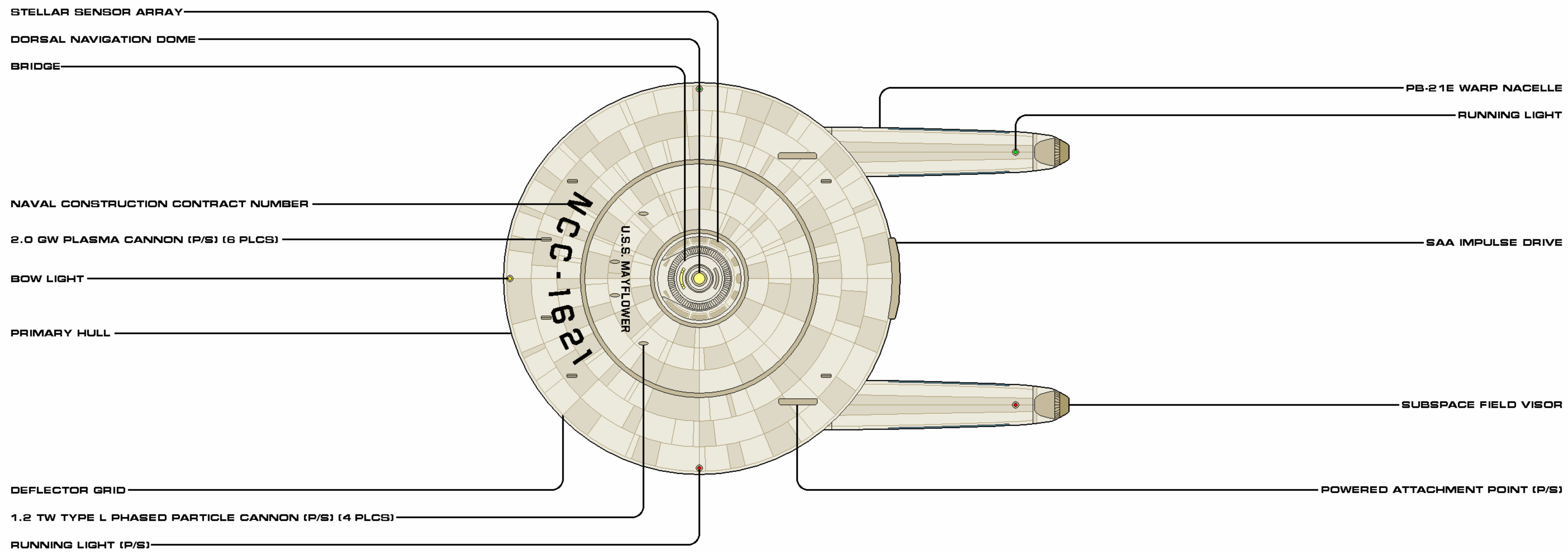
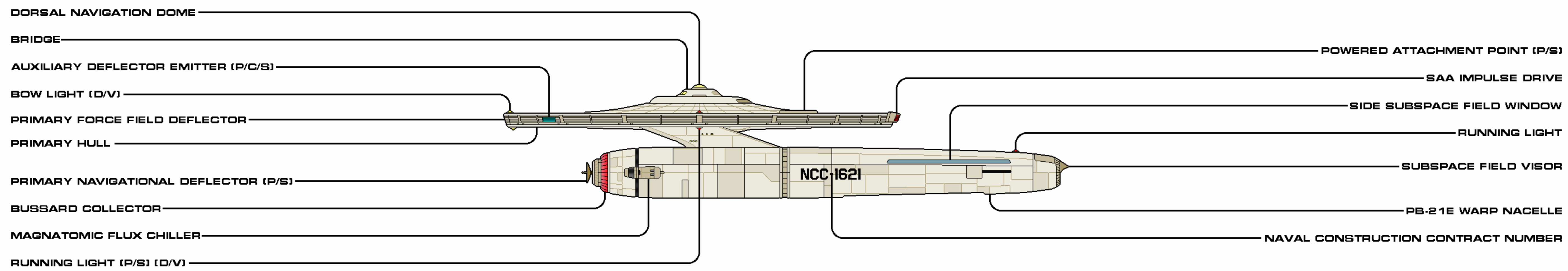

SHEET 1 OF 2

CLASS	BURKE	CATEGORY	NEARSPACE FRIGATE
VARIANT	FLIGHT II	CONSTRUCTED	2235
LENGTH	185.8 M	BEAM	122.0 M
HEIGHT	35.5 M	MASS	320,000 MT
OPERATIONAL	43/61	RELEASE DATE	1906.01

Authorized for release by Star Fleet Bureau of Starship Construction



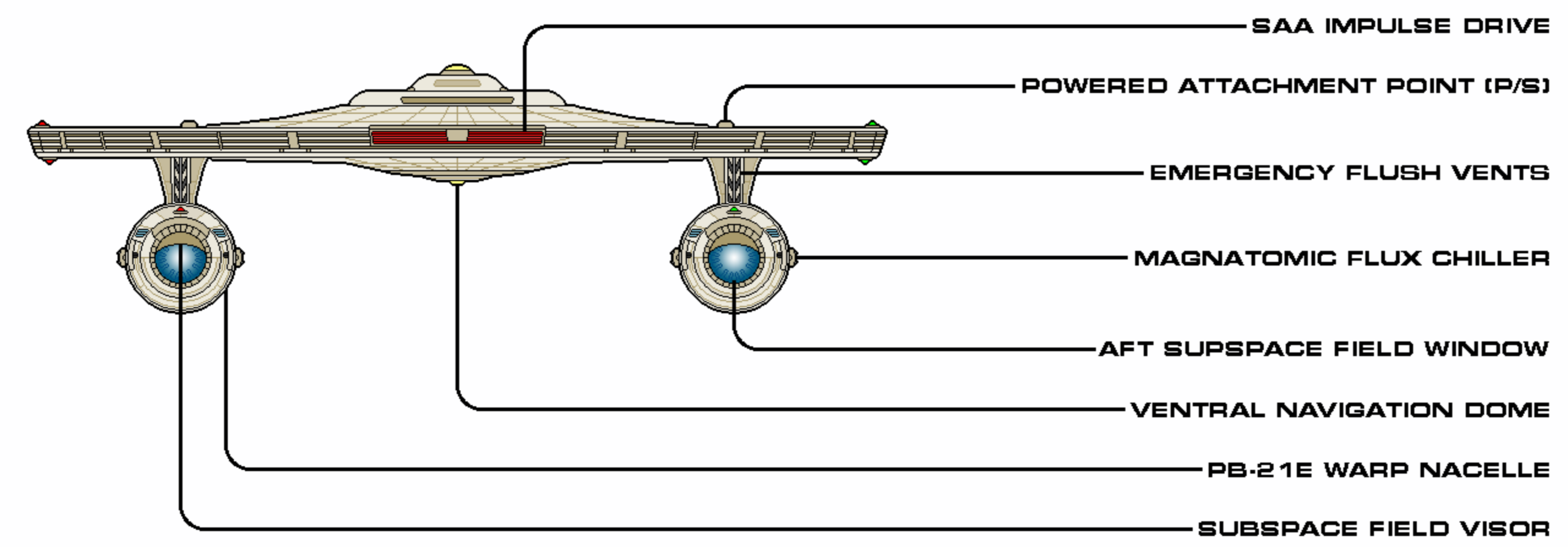
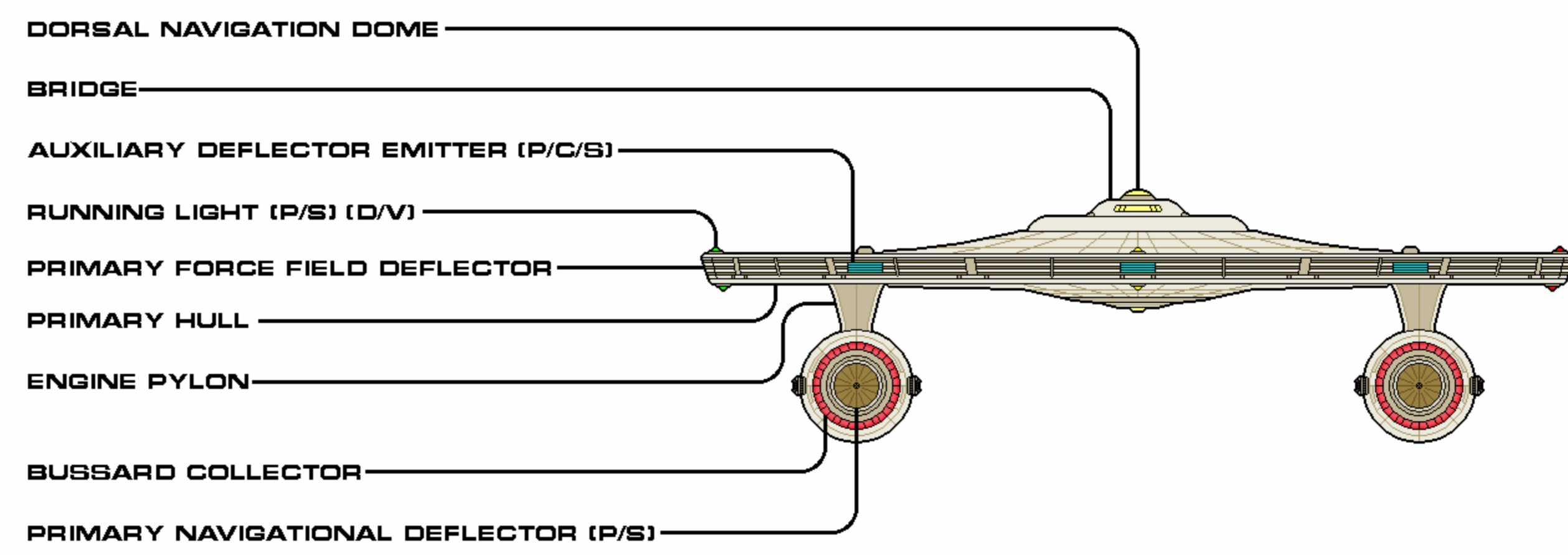
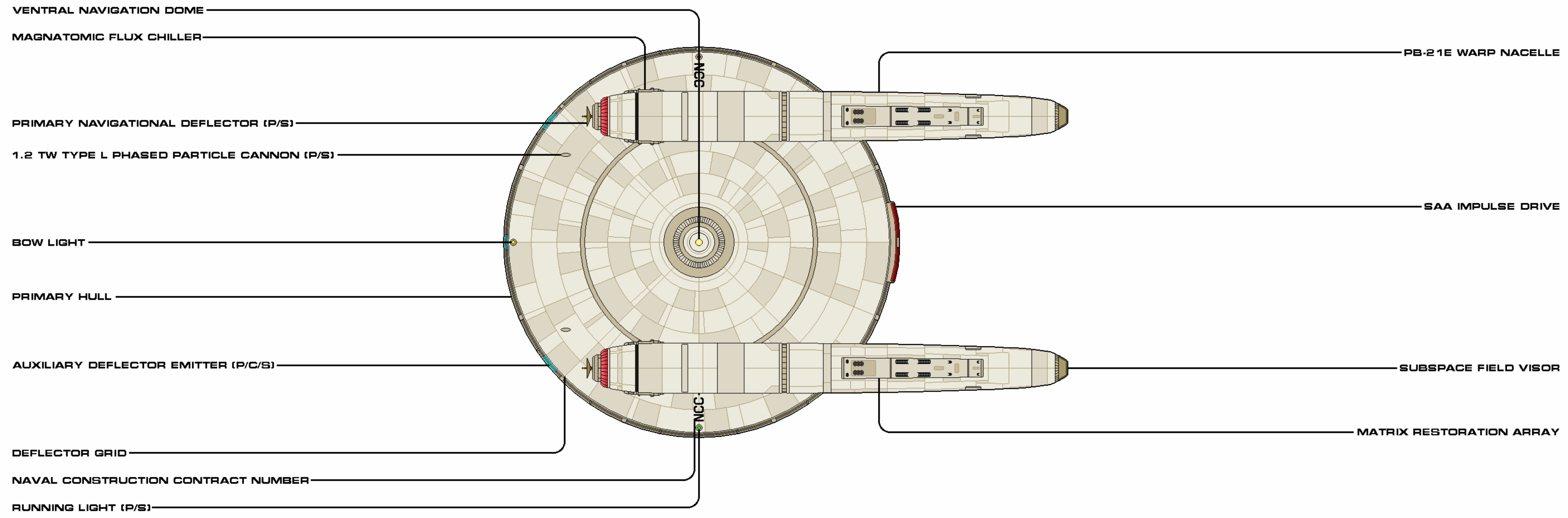

SHEET 2 OF 2

CLASS	BURKE	CATEGORY	NEARSPACE FRIGATE
VARIANT	FLIGHT II	CONSTRUCTED	2235
LENGTH	125.8 M	BEAM	122.0 M
HEIGHT	35.5 M	MASS	320,000 MT
OPERATIONAL	43/67	RELEASE DATE	1900.01

Authorized for release by Star Fleet Bureau of Starship Construction



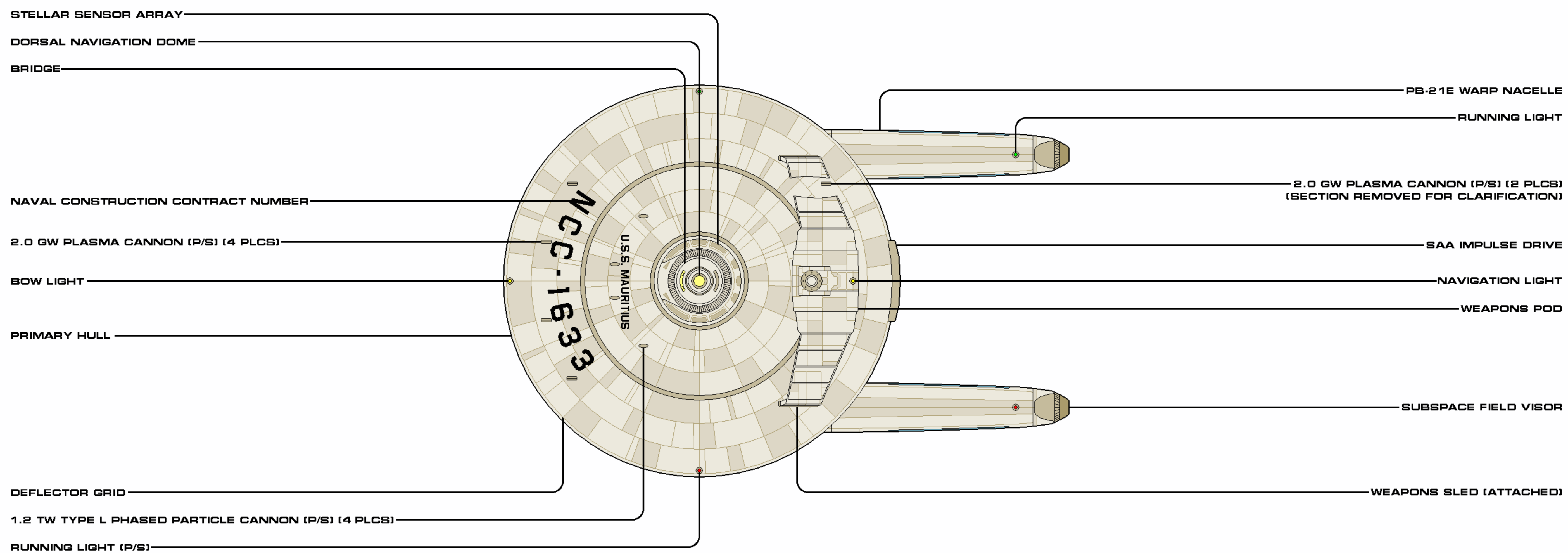
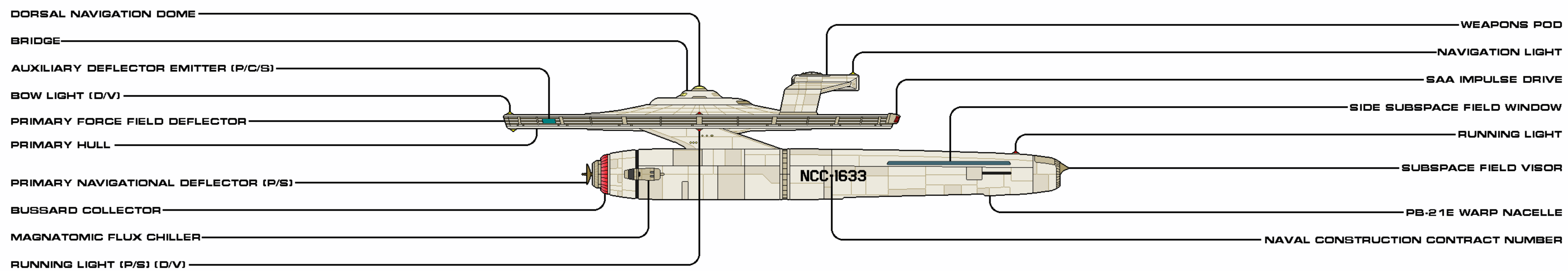

SHEET 1 OF 2

CLASS	BURKE	CATEGORY	NEARSPACE FRIGATE
VARIANT	FLIGHT II W/ POD	CONSTRUCTED	2235
LENGTH	185.8 M	BEAM	122.0 M
HEIGHT	39.9 M	MASS	352,300 MT
OPERATIONAL	43/01	RELEASE DATE	1906.01

Authorized for release by Star Fleet Bureau of Starship Construction

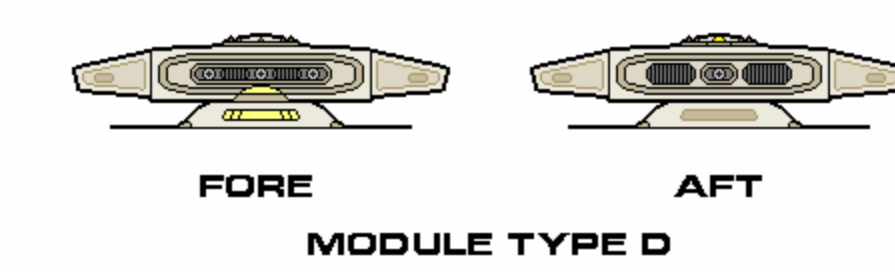
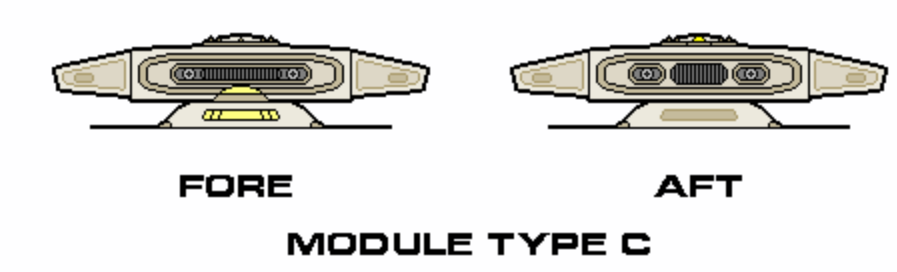
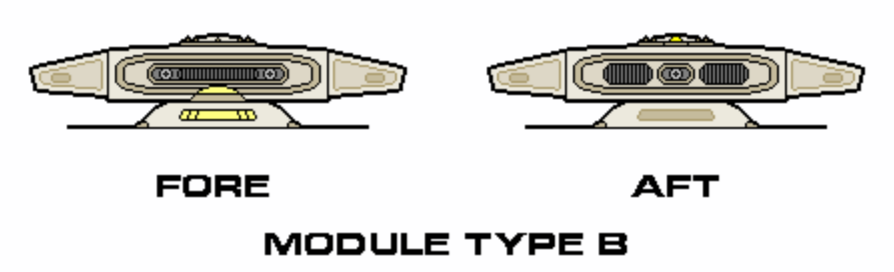
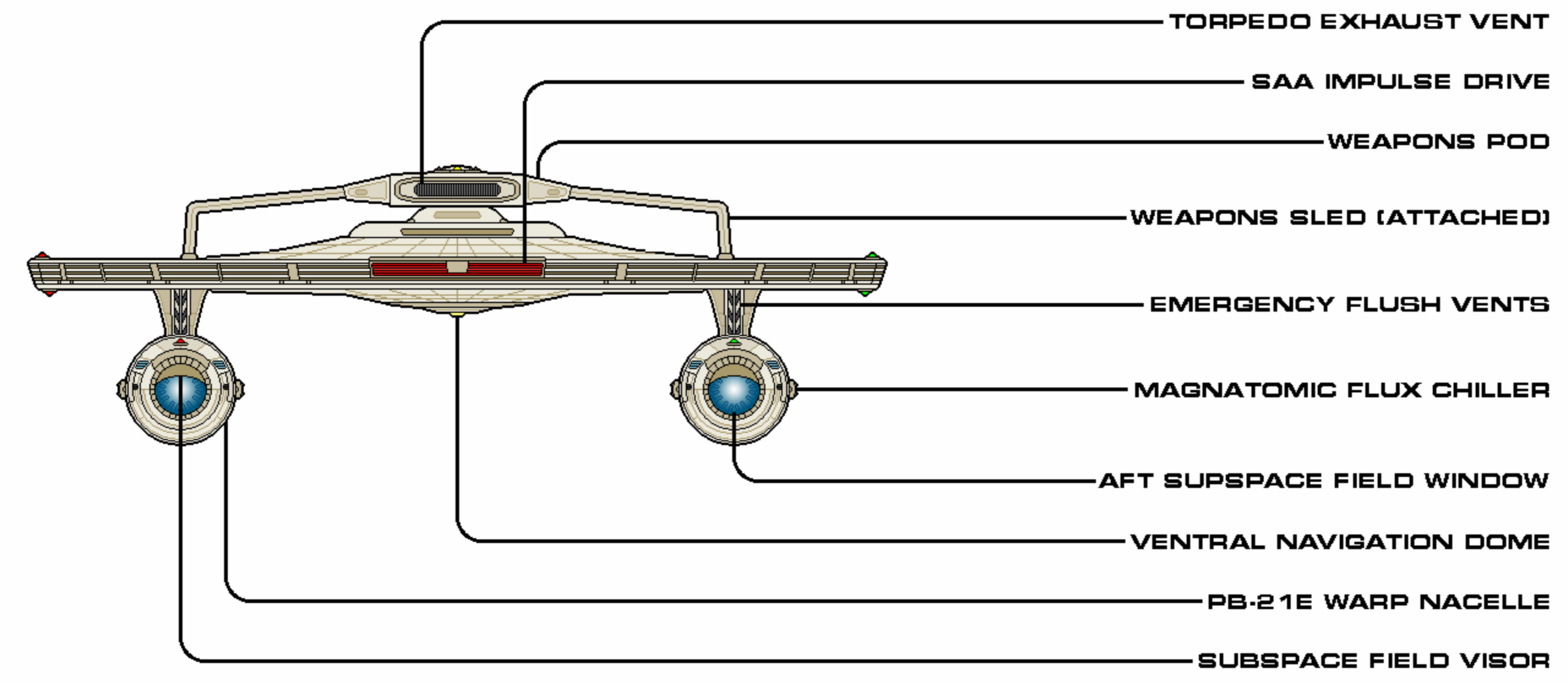
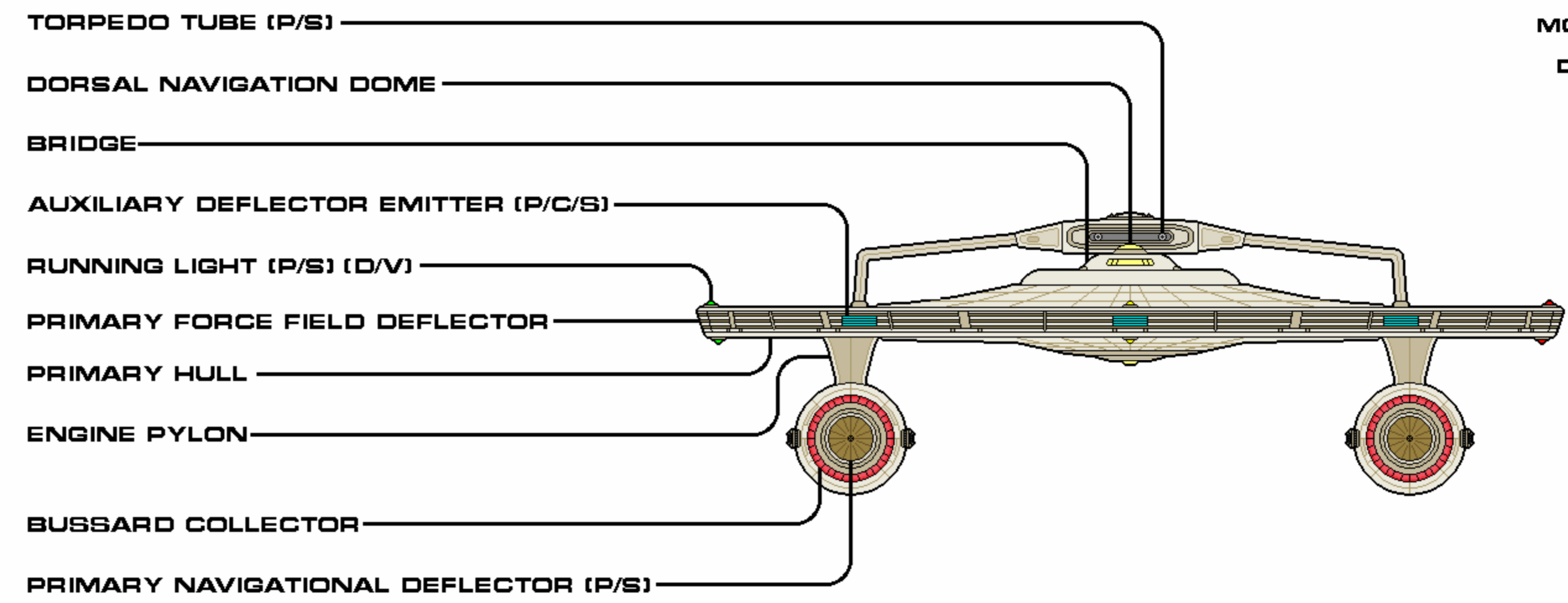
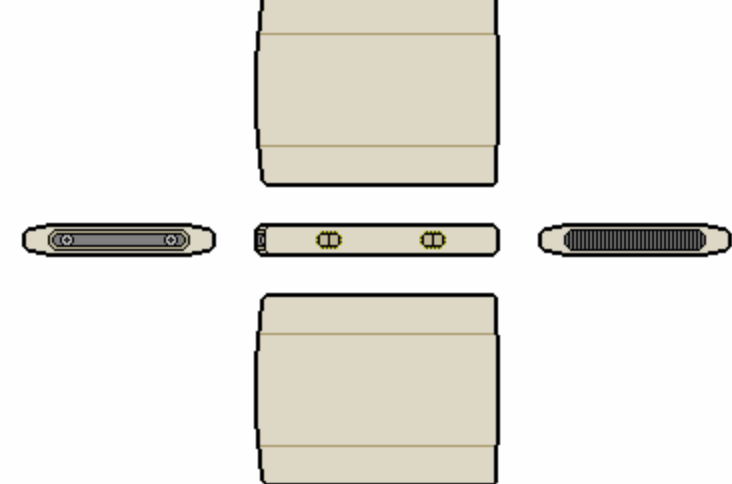
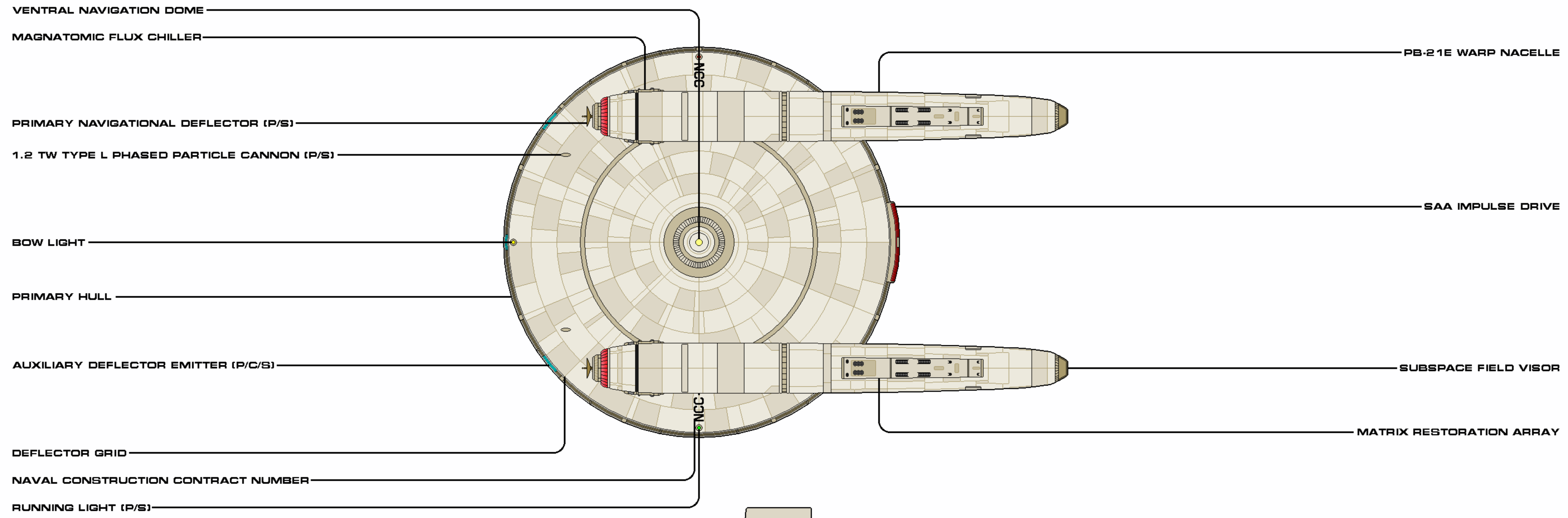

SHEET 2 OF 2

CLASS	BURKE	CATEGORY	NEARSPACE FRIGATE
VARIANT	FLIGHT II W/ POD	CONSTRUCTED	2235
LENGTH	125.8 M	BEAM	122.0 M
HEIGHT	39.9 M	MASS	352,300 MT
OPERATIONAL	43/67	RELEASE DATE	1906.01

Authorized for release by Star Fleet Bureau of Starship Construction



## ALDRIN FLIGHT II

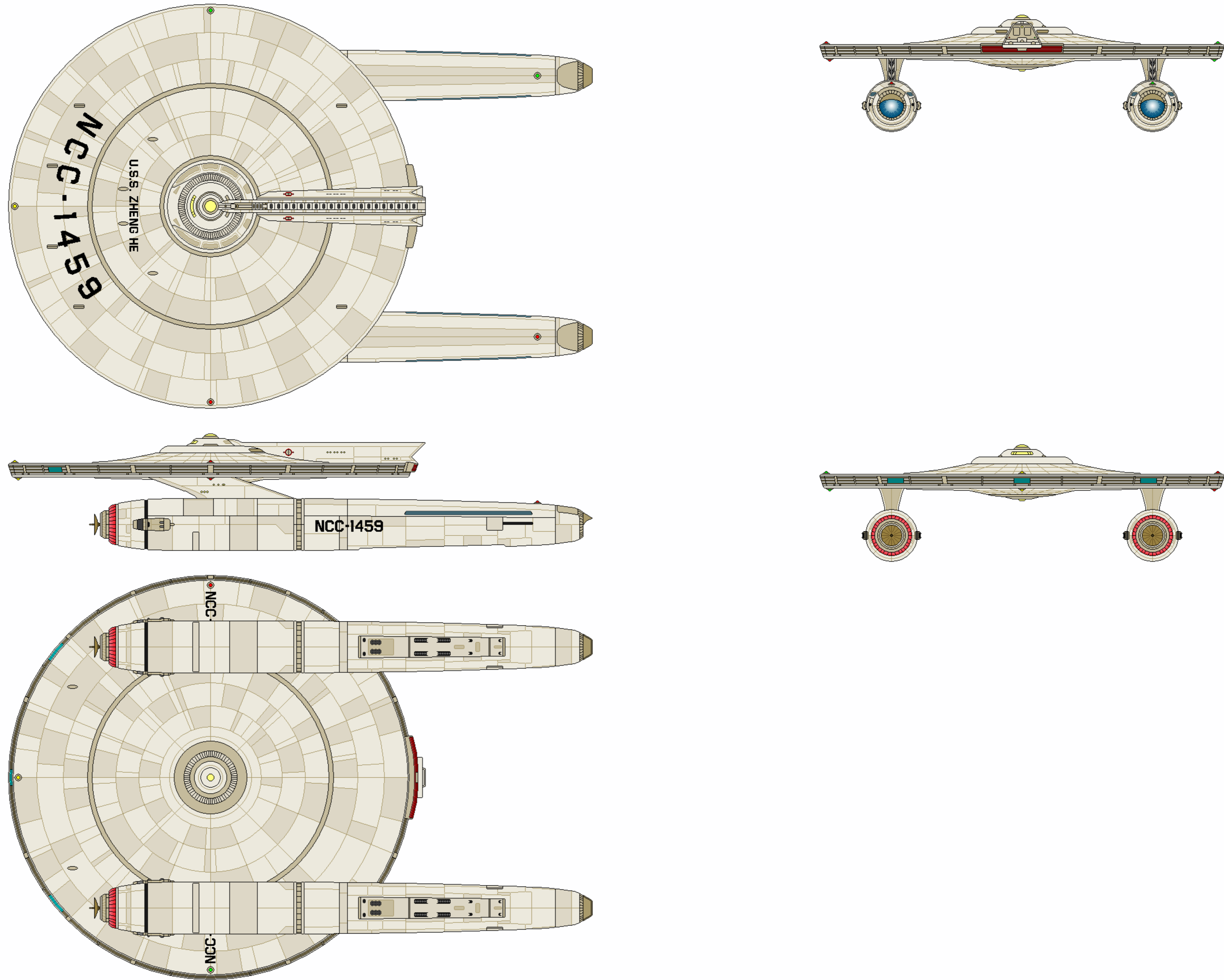

CATEGORY: DEEP SPACE FRIGATE  
OPERATIONAL: 2235 - 2245 (UPGRADE)  
MODIFIED: 24 (2235 - 2237)

DIMENSIONS:  
LENGTH: 185.8 M  
BEAM: 122.0 M  
HEIGHT: 35.5 M (36.6 BOOST)  
MASS: 325,000 MT

PERFORMANCE:  
CRUISE: WARP 4 (OCU)  
MAX: WARP 6.5 (OCU)  
ENDURANCE: 3 YEARS

COMPLEMENT:  
OFFICERS: 25  
ENLISTED: 214

TACTICAL:  
- 6X 2.0 GW PLASMA CANNONS  
- 6X 1.2 TW TYPE L PHASED PARTICLE CANNONS  
- 2-LAYER CONFORMAL FORCEFIELD  
- 2X PRIMARY NAVIGATIONAL DEFLECTORS  
- 3X AUXILIARY DEFLECTOR EMITTERS  
- OPTIONAL: BOOSTER POD

AUXILIARIES:  
- 4X WORK PODS





## ALDRIN FLIGHT II AUTHORIZED CONSTRUCTION

THE FOLLOWING SHIPS OF THE ABOVE CLASS WERE AUTHORIZED AS PART OF THE FEDERATION STAR FLEET BY FEDERATION COUNCIL APPROPRIATION.

USS ALDRIN	NCC-1450	USS MAGELLAN	NCC-1462
USS MOGENSEN	NCC-1451	USS RELENTLESS	NCC-1463
USS IRWIN	NCC-1452	USS ZHAI	NCC-1464
USS DYOMIN	NCC-1453	USS ZHANG	NCC-1465
USS MITCHELL	NCC-1454	USS SHACKLETON	NCC-1466
USS BEAN	NCC-1455	USS CHRETIEN	NCC-1467
USS SHARMAN	NCC-1456	USS SCHMITT	NCC-1468
USS DUKE	NCC-1457	USS FRIMOUT	NCC-1469
USS FEI	NCC-1458	USS JAHN	NCC-1470
USS ZHENG HE	NCC-1459	USS VESPUCCI	NCC-1471
USS HADFIELD	NCC-1460	USS VASCO DA GAMA	NCC-1472
USS ATKOV	NCC-1461	USS KOTOV	NCC-1473

### GENERAL INFORMATION

Between 2235 and 2237, all 24 vessels of the Aldrin subclass entered drydocks and spacedocks for their standard refit periods, along with the Burkes. The most important tactical upgrade they each received was having the three laser emitters removed and replaced with six Type L phased particle cannons of 1.2 terrawatt capacity, secured by spacetight hatches. Four were provided on the dorsal saucer, with the remaining two on the ventral side.

A lack of satisfaction with the PB-21B nacelle crafted to the mission profile of the frigates was primarily focused on the range capacity afforded the ship, which was limited to a cruise limit of warp 4, and a maximum speed of warp 6.5. Modelling suggested that a reflux of the warp field, focused on the immediate aft, along with a few other longevity and internal maintenance tweaks, might tip the scales of efficiency a bit in the ships' favor; a subspace field visor coupled on to the extreme end of the nacelles, however, did not support the results of the modelling. They were not removed, as they seemed to have no effect one way or the other, other than somewhat restricting the light emissions from that particular field window.

One of the selling points by Geering for the Aldrin subclass deep space frigate was the adaptability afforded by the spinal extension (with its additional fuel storage), vitally necessary for extending the patrolling range of the original class. The shipbuilder heavily pushed the versatility and capacity of the attachment rail running fore to aft along the extension for all sorts of sensors, mechanical gear, and other equipment, both proposed and as-yet unrealized. If an Aldrin was to be in the vicinity of a Class G Dichromic nebula, then the area commander could outfit the ship with the appropriate gravimetric sensors to map the distortions. An astrometric suite would be ideal for that T Tauri star just off the charted course. And independently controlled spotlights would be critical to assisting in ship-based recovery efforts, especially in the post-event investigations.

All of these events did occur, and many more, but one thing every ship's commanding officer requested before short- or mid-length deployments was the booster pod. While definitely a fuel burner, the immediate acceleration from both a full stop and during an otherwise-steady delta vee was commendable and potentially a life-saver. Aldrins were not oblivious of the various pirate forces, Orions included, and the unexpected rate of closure could often startle an otherwise confident hostile boarding party "visiting" a hapless merchant freighter. And when the warp bubble was fully formed, the additional 0.05 c of impulse could stop the show.

Certainly, the booster pod was a popular request with Aldrins, and once they were fully produced, rarely would a deep space frigate be seen without one, unless it was transiting thru the inner Federation or on a long-range patrol, outside of dependable refueling stages.

A similar image to the Aldrin Flight II with booster pod will be found within the Aldrin Flight IV entry.



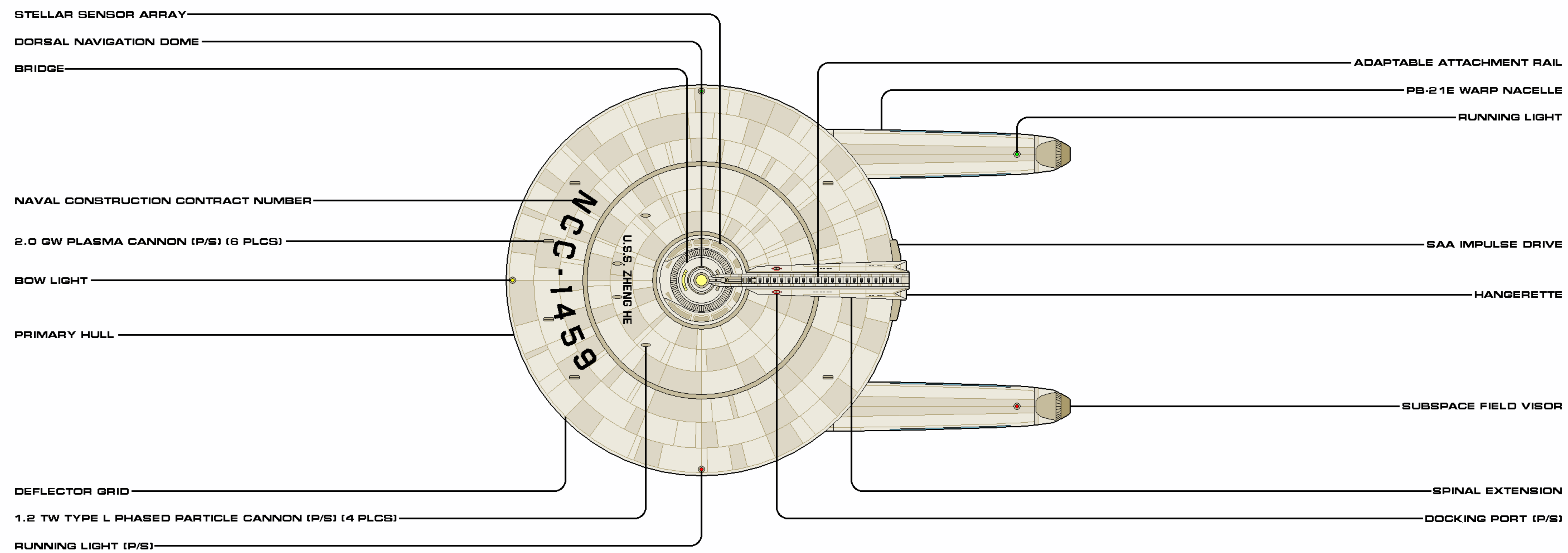
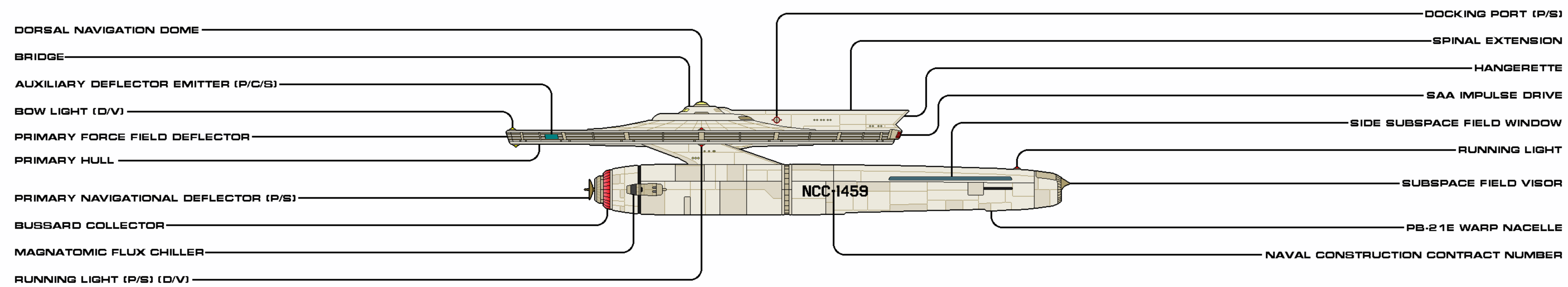

SHEET 1 OF 2

CLASS	BURKE	CATEGORY	DEEP SPACE FRIGATE
VARIANT	ALDRIN FLIGHT II	CONSTRUCTED	2235
LENGTH	185.8 M	BEAM	122.0 M
HEIGHT	35.5 M	MASS	325,000 MT
OPERATIONAL	24/61	RELEASE DATE	1906.01

Authorized for release by Star Fleet Bureau of Starship Construction

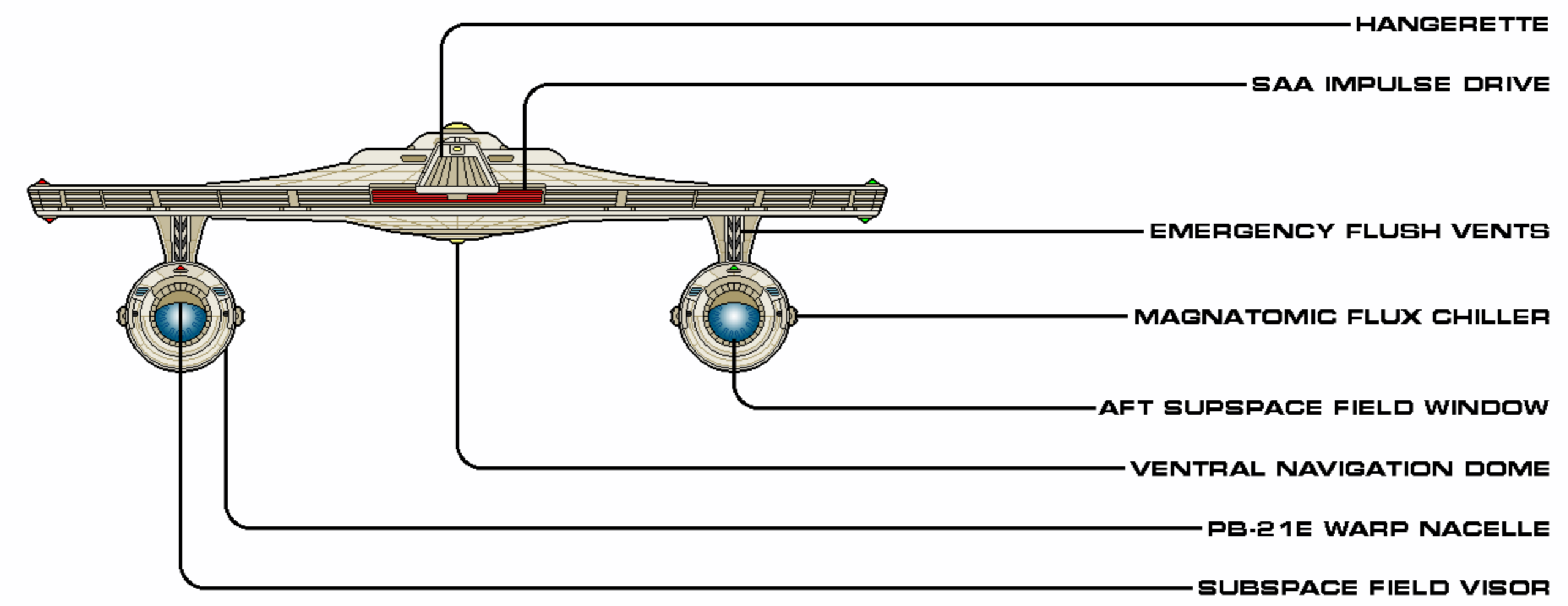
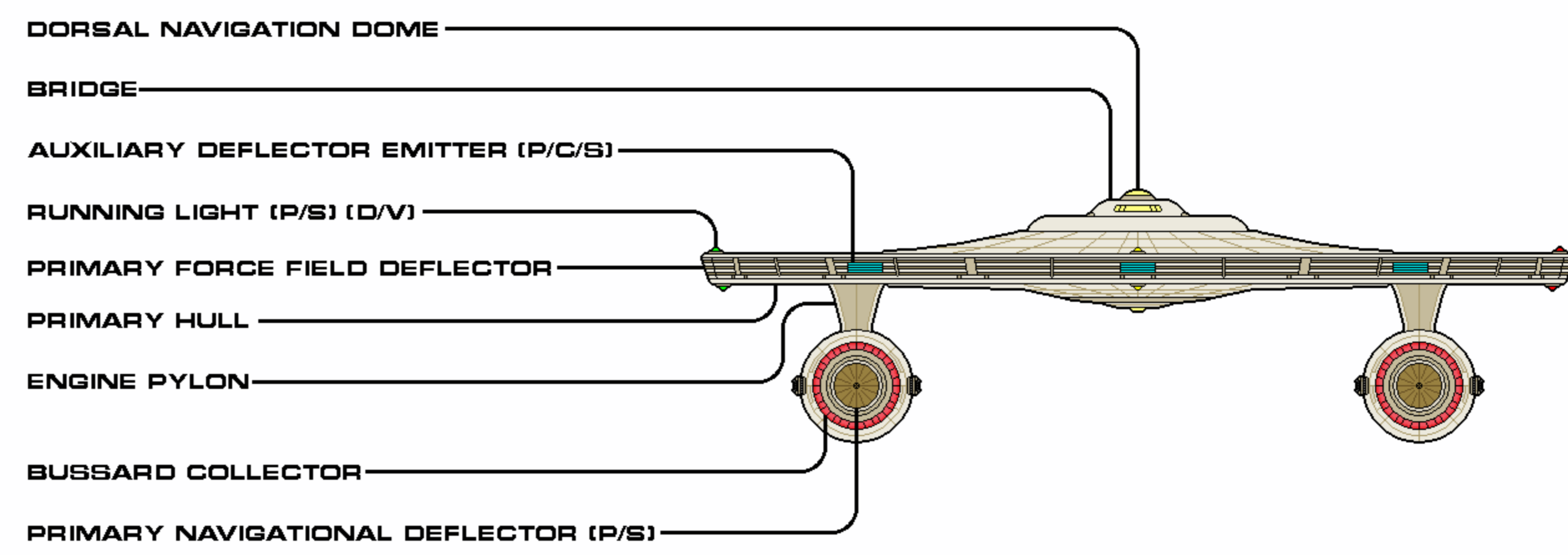
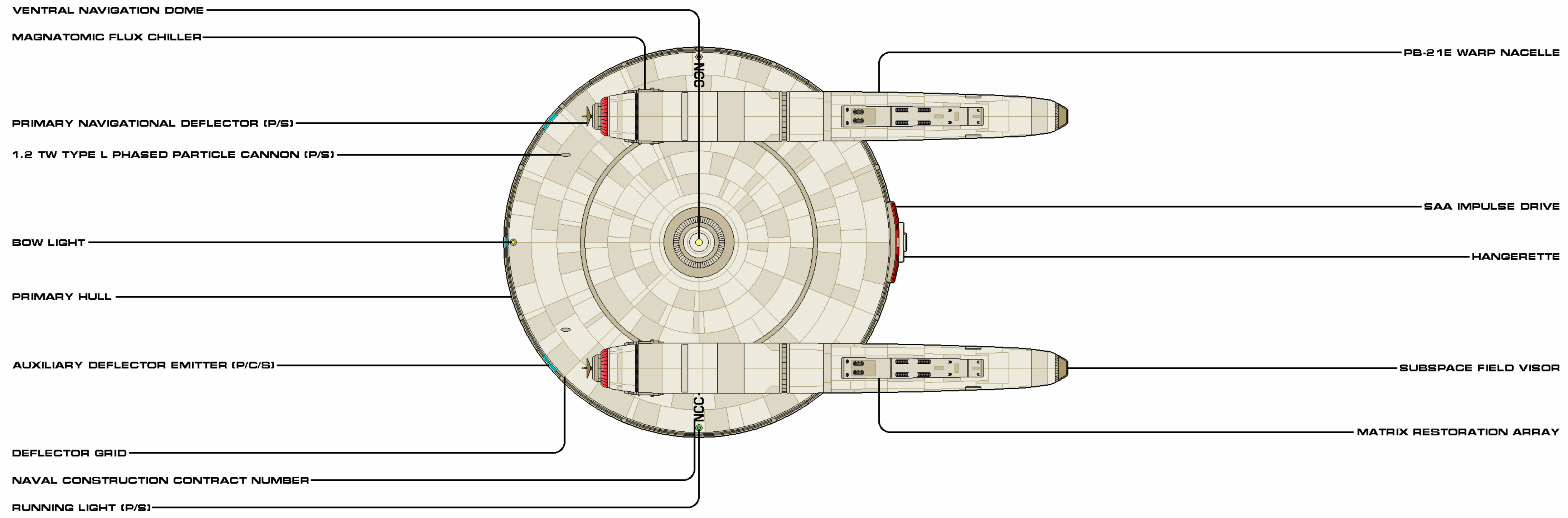

SHEET 2 OF 2

CLASS	BURKE	CATEGORY	DEEP SPACE FRIGATE
VARIANT	ALDRIN FLIGHT II	CONSTRUCTED	2235
LENGTH	125.8 M	BEAM	122.0 M
HEIGHT	35.5 M	MASS	325,000 MT
OPERATIONAL	24/61	RELEASE DATE	1906.01

Authorized for release by Star Fleet Bureau of Starship Construction

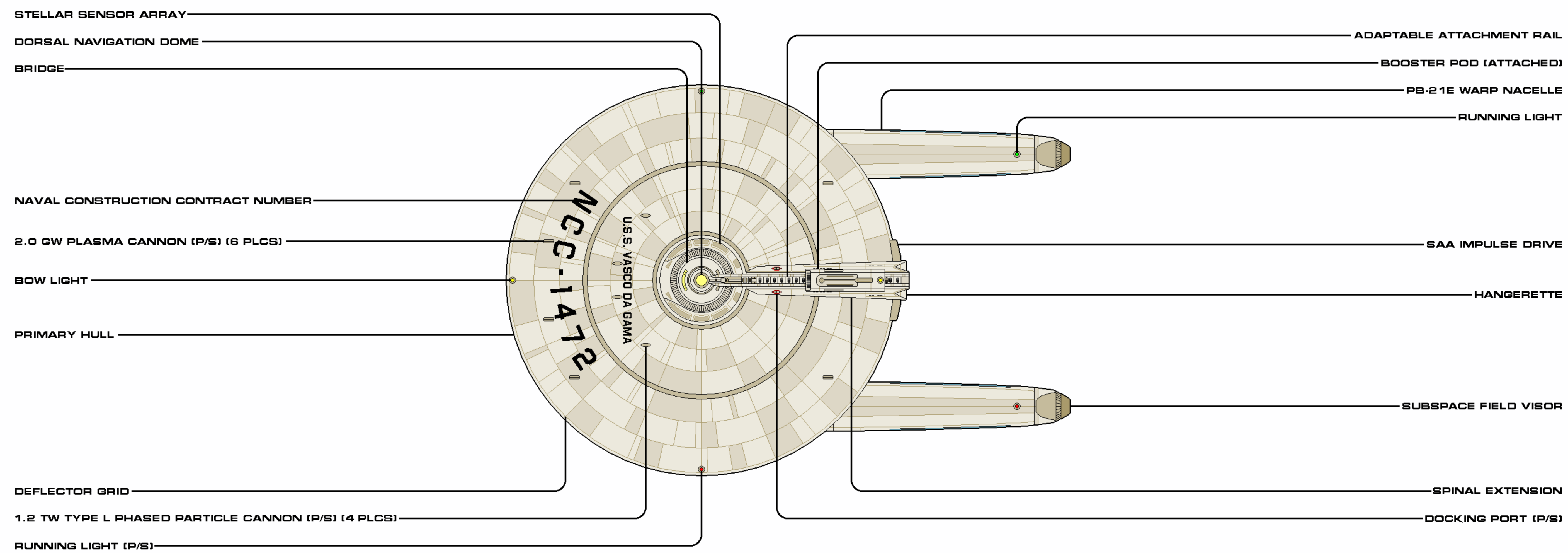
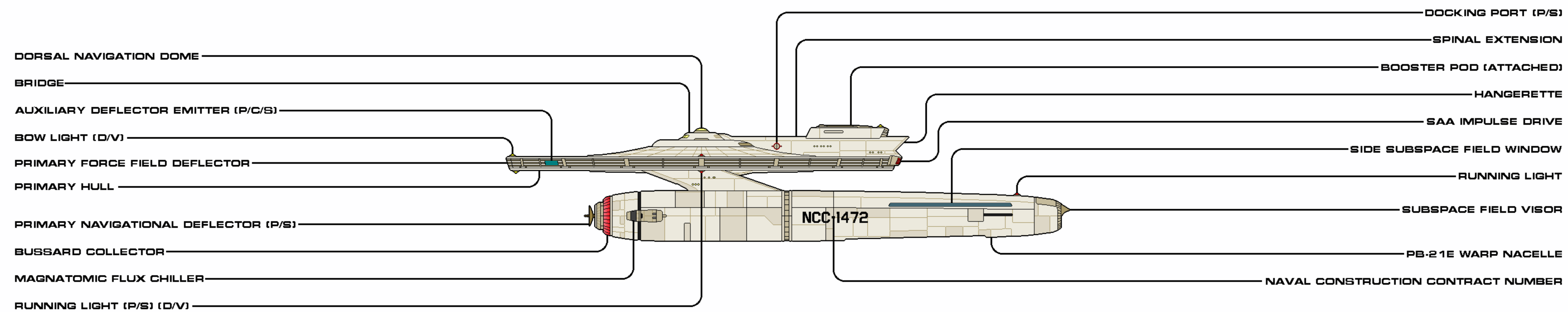

SHEET 1 OF 2

CLASS	BURKE	CATEGORY	DEEP SPACE FRIGATE
VARIANT	ALDRIN FLT II W/ POD	CONSTRUCTED	2235
LENGTH	185.8 M	BEAM	122.0 M
HEIGHT	36.6 M	MASS	332,250 MT
OPERATIONAL	24/61	RELEASE DATE	1906.01

Authorized for release by Star Fleet Bureau of Starship Construction



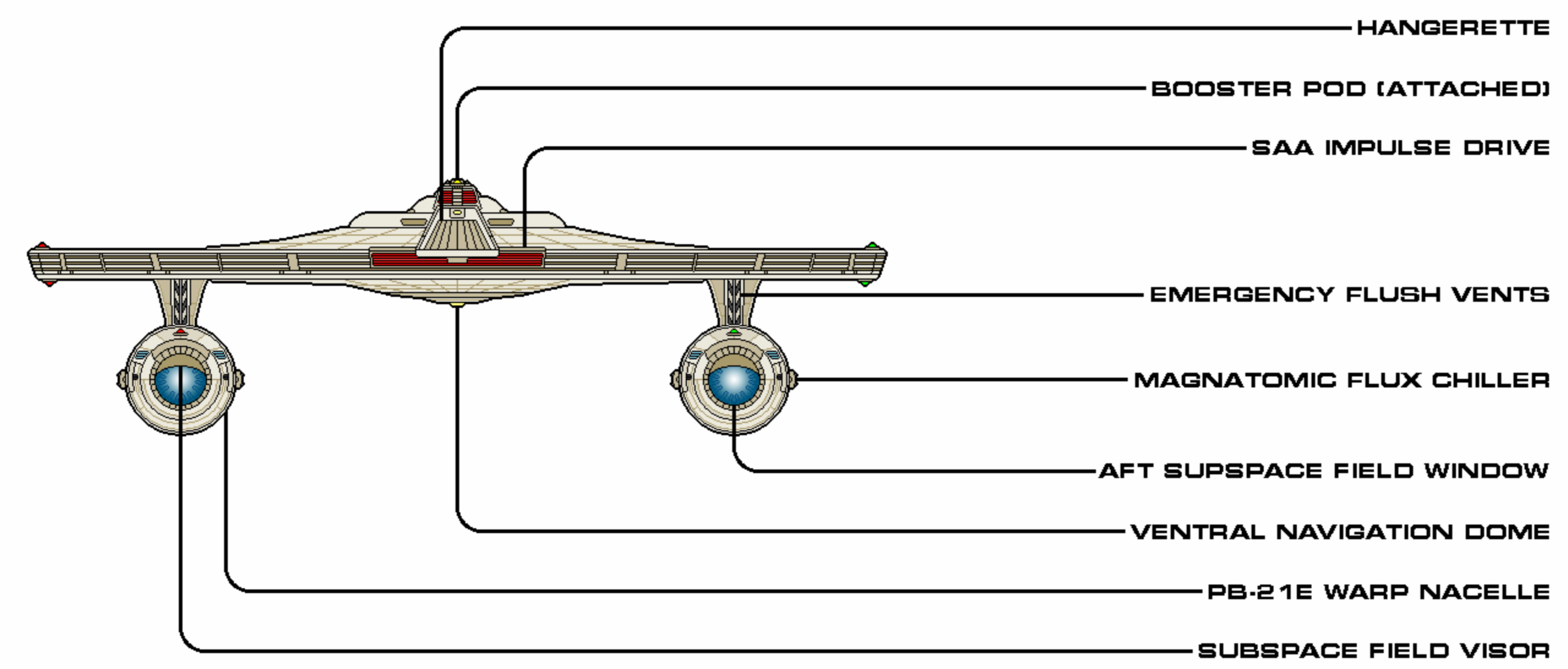
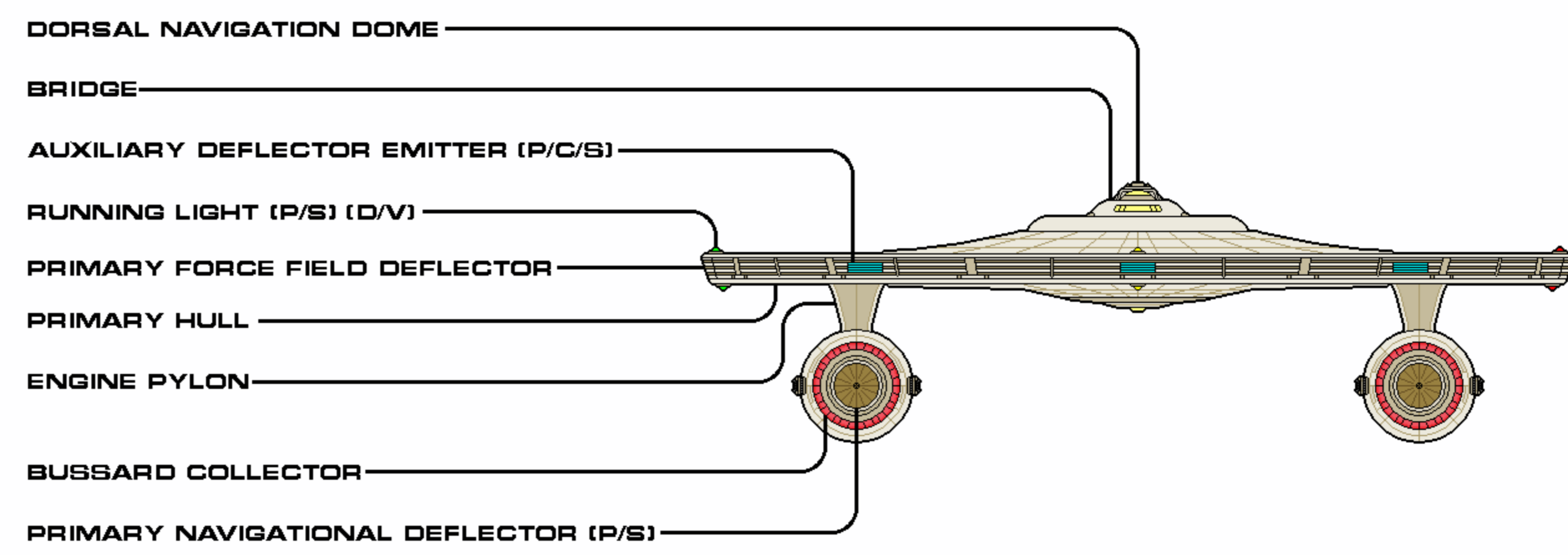
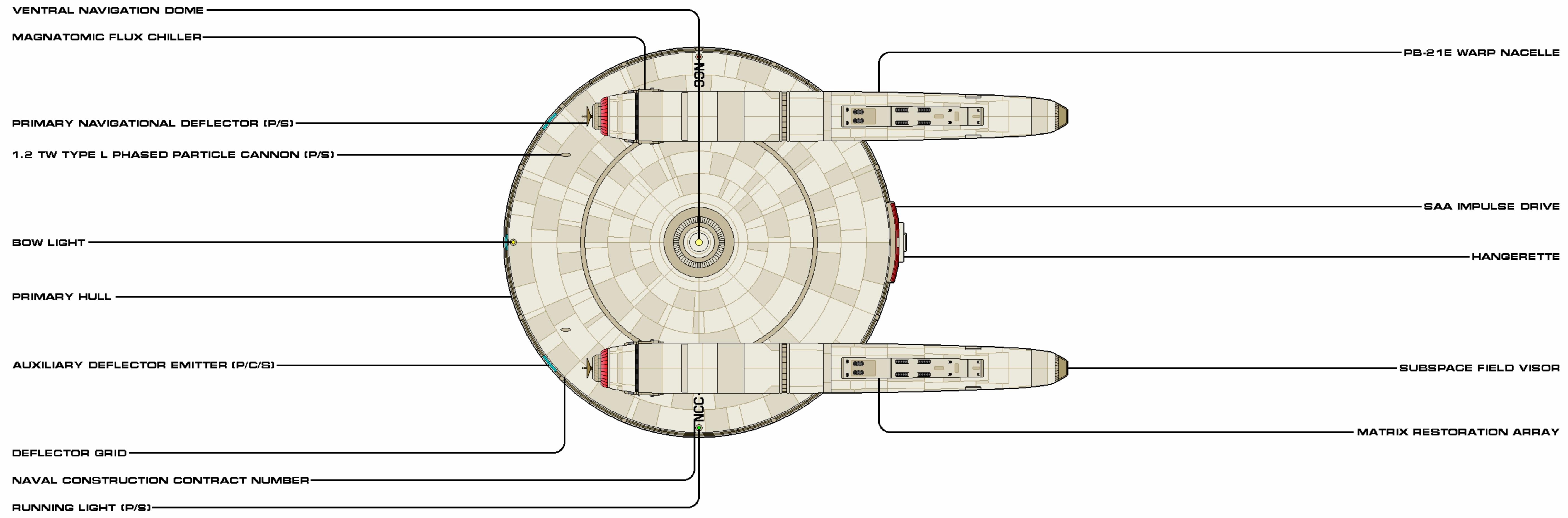

SHEET 2 OF 2

CLASS	BURKE	CATEGORY	DEEP SPACE FRIGATE
VARIANT	ALDRIN FLT II W/ POD	CONSTRUCTED	2235
LENGTH	125.8 M	BEAM	122.0 M
HEIGHT	36.6 M	MASS	332,250 MT
OPERATIONAL	24/67	RELEASE DATE	1906.01

Authorized for release by Star Fleet Bureau of Starship Construction

## BURKE FLIGHT III

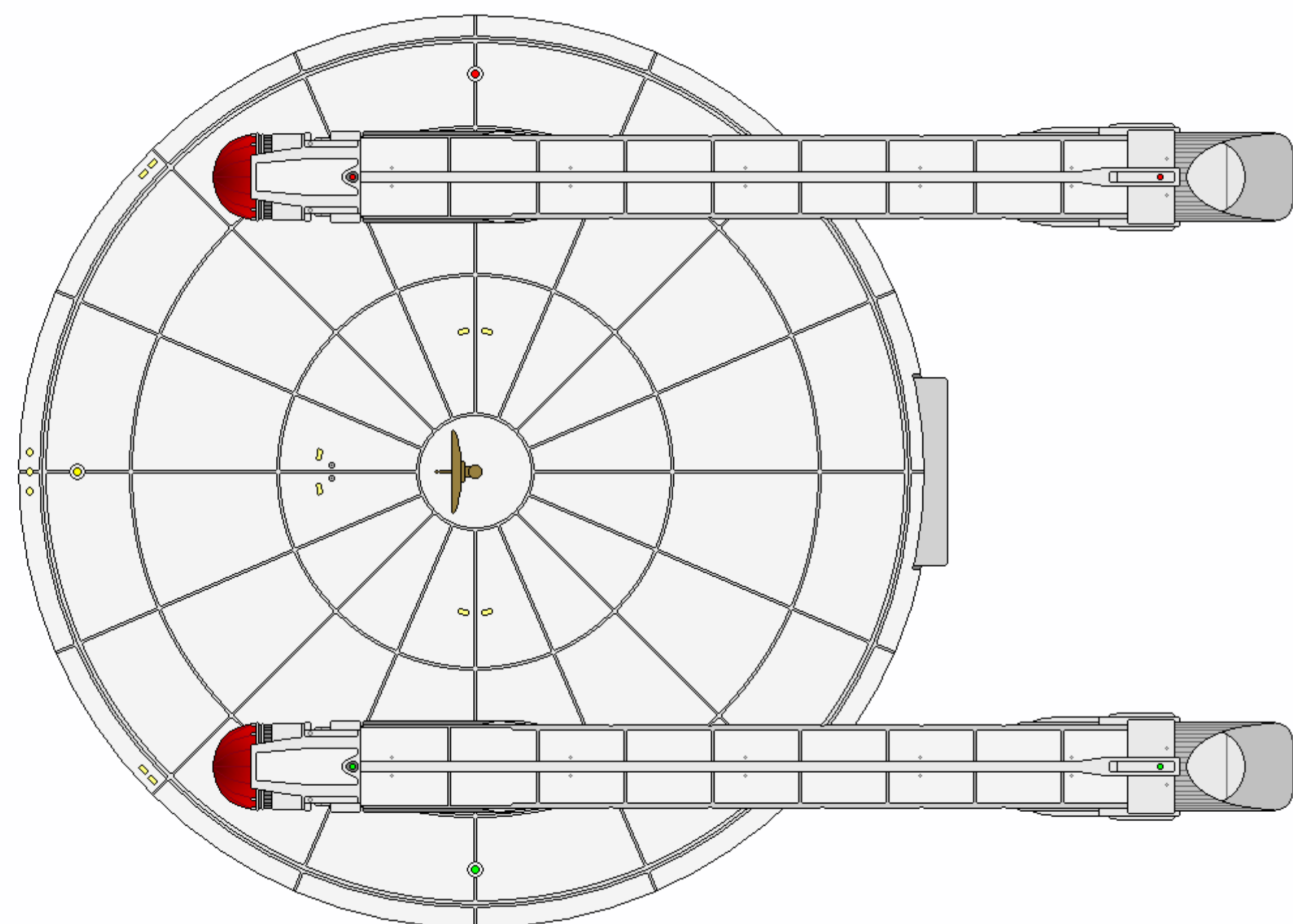
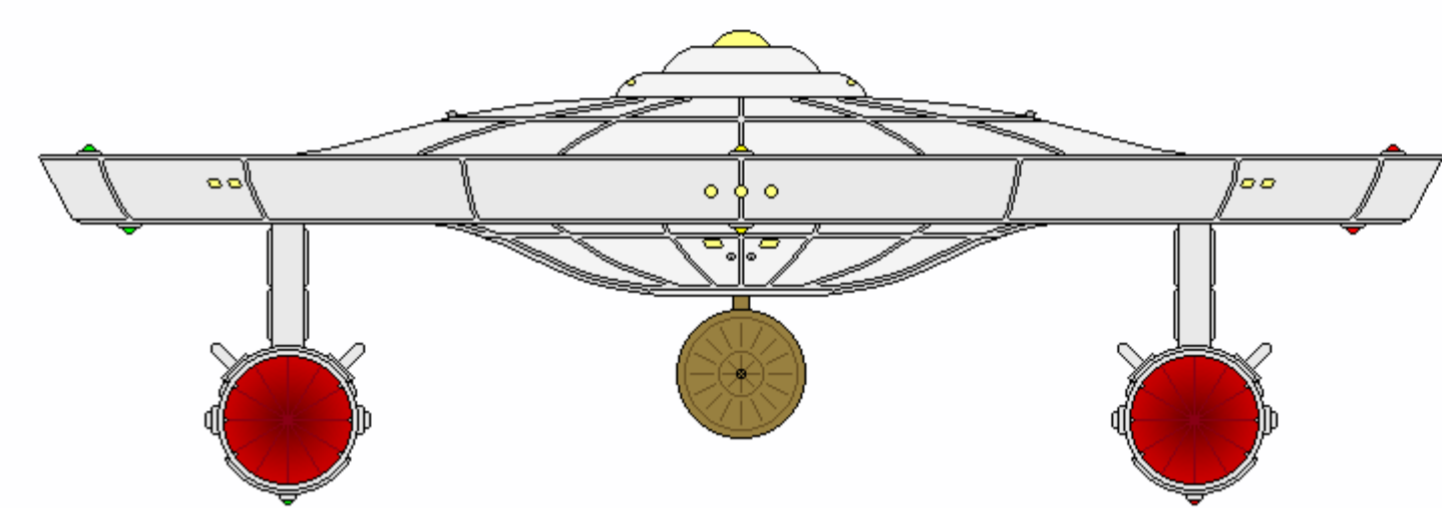
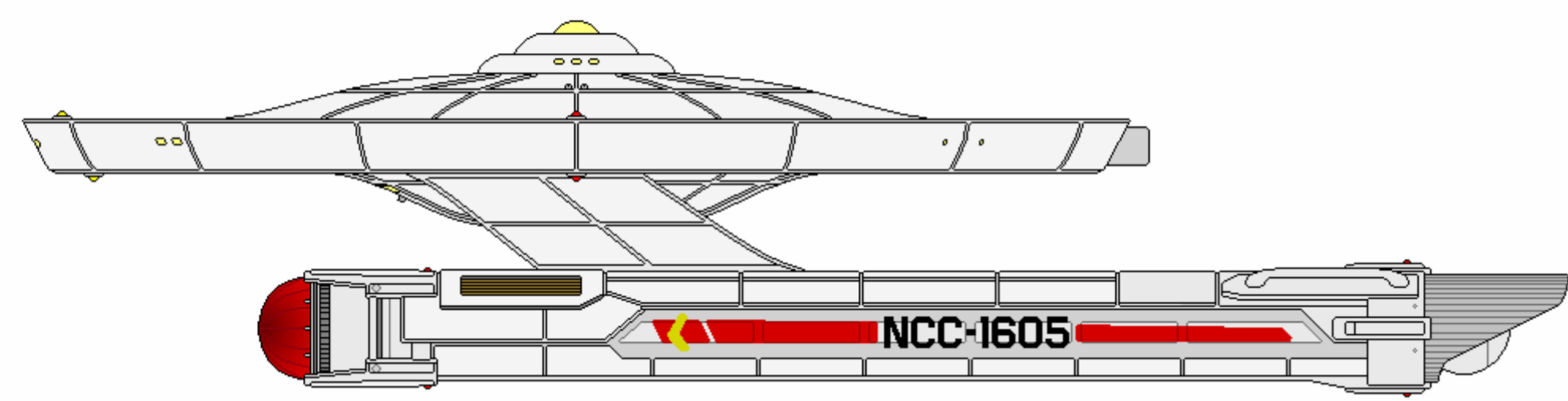
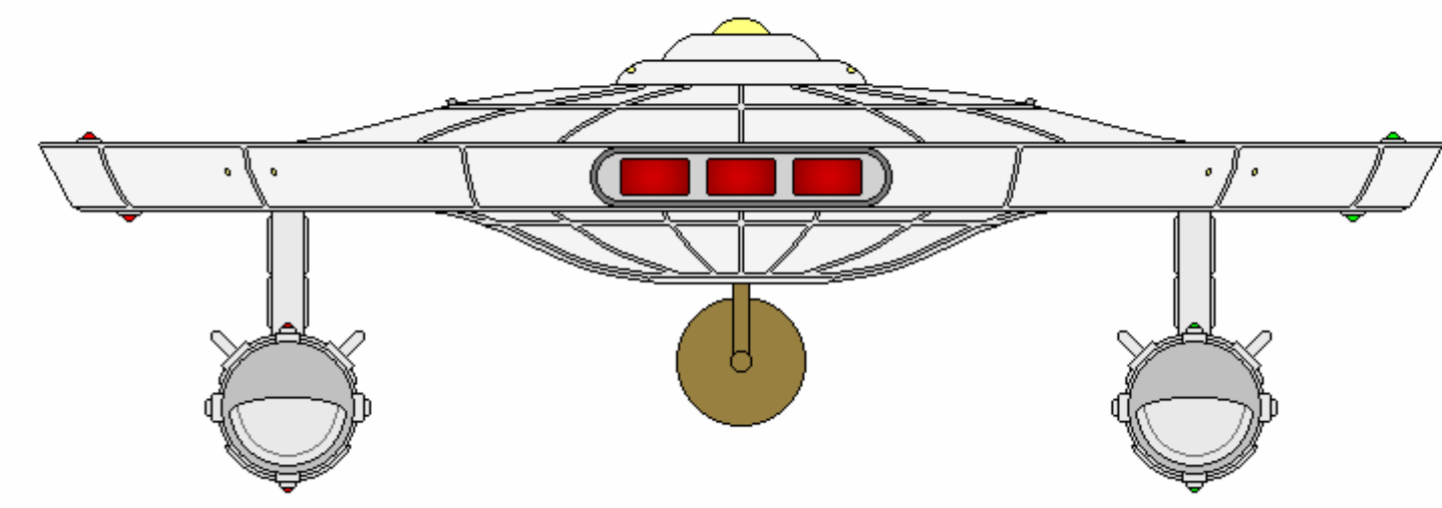
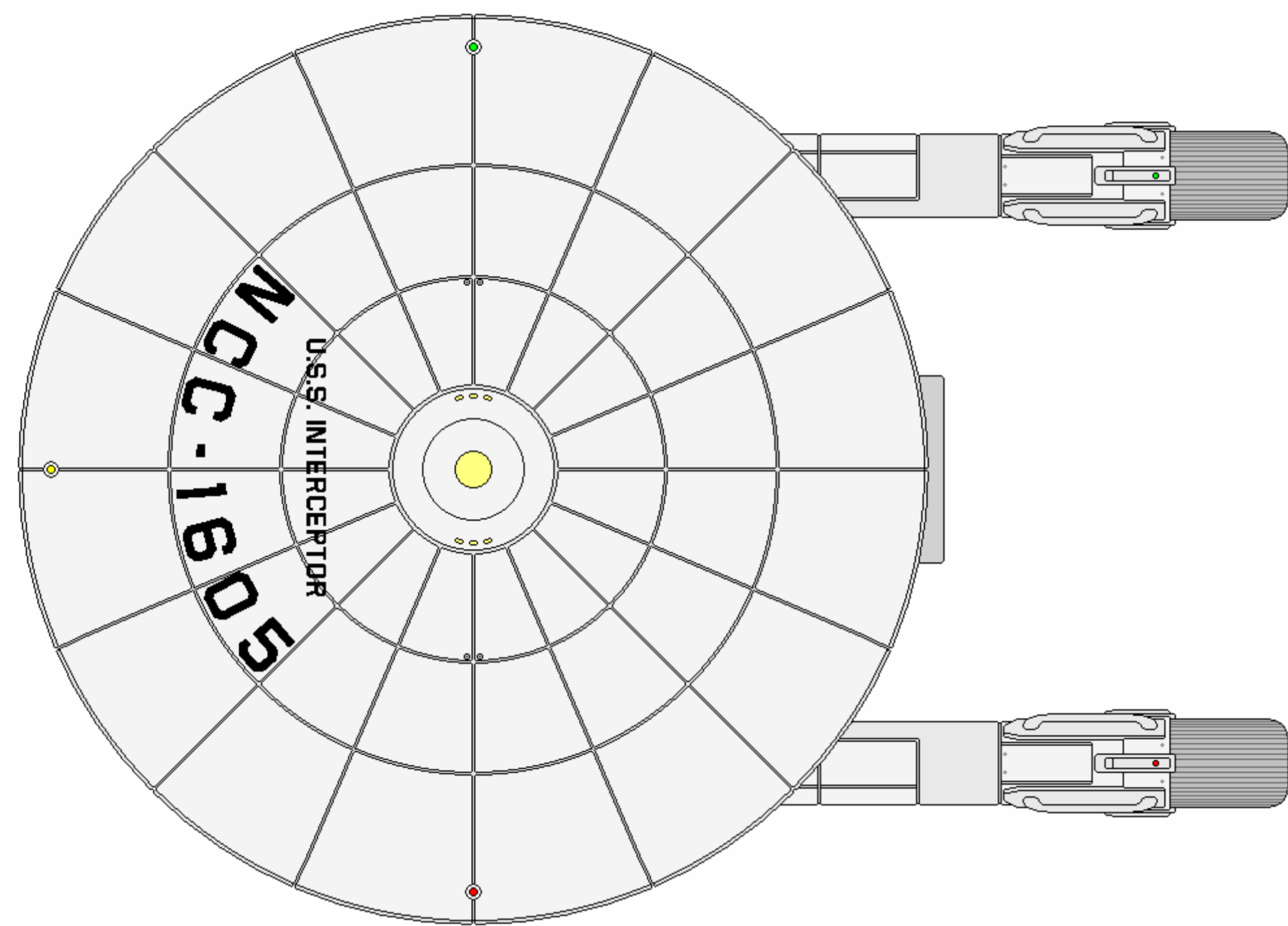

CATEGORY: NEARSPACE FRIGATE  
OPERATIONAL: 2244 - 2267  
MODIFIED: 8 (2244 - 2245)

DIMENSIONS:  
LENGTH: 179.6 M  
BEAM: 122.0 M  
HEIGHT: 41.7 M  
MASS: 360,700 MT

TACTICAL:  
- 6X TYPE VI PHASERS  
- 2-LAYER CONFORMAL FORCEFIELD  
- MAIN NAVIGATIONAL DEFLECTOR  
- AUXILIARY DEFLECTOR ARRAY

PERFORMANCE:  
CRUISE: WARP 5 (OCU)  
MAX: WARP 8 (OCU)  
ENDURANCE: 2 YEARS

COMPLEMENT:  
OFFICERS: 25  
ENLISTED: 214

AUXILIARIES: NONE



## BURKE FLIGHT III AUTHORIZED CONSTRUCTION

THE FOLLOWING SHIPS OF THE ABOVE CLASS WERE AUTHORIZED AS PART OF THE FEDERATION STAR FLEET BY FEDERATION COUNCIL APPROPRIATION.

USS BURKE	NCC-1600	USS RAIDER	NCC-1620
USS ABUNDANCE	NCC-1607	USS GREYHOUND	NCC-1627
USS EMDEN	NCC-1608	USS ALBION	NCC-1637
USS SABRE	NCC-1613	USS ARTFUL	NCC-1642

---

### GENERAL INFORMATION

In 2244, the Andorian shipbuilder company Chiokis, a sub-contracting design firm for previous ship classes, won the Star Fleet bid to modernize the Burke class nearspace frigate with the new solid state era nacelles. Chiokis seized this for the opportunity to promote its primary hull design (also a saucer shape), because the new PB-45 warp nacelles required external power generation: a total matter conversion powerplant not built into the nacelle itself, allowing the ship to achieve a cruising speed of warp 5 and a max speed of warp 8. This required a near-complete redesign of the saucer section to accommodate this massive new system.

Select ships of the Burke and Aldrin subclass series were designated for this radical refit; along with the new saucer modifications—both internal and external—they also received the latest (in the now more dependable) phaser emitters in twin banks, the new SAD impulse assembly and, for the nearspace frigates, a destroyer-type sensor dish attached to the ventral saucer via a "bulge" extension that would very soon be considered a characteristic of Chiokis' saucers. These modifications gave the ships a more engineered—less organic—look compared to the majority of the remaining ships of Geering origination.

All in all, only 8 of the Burkes would receive this upgrade. Not because the design concept was a failure by any means, but because of the expense and time for the upgrade was deemed too intrusive. This class would soon be a generation older in comparison to the numerous ship designs expected to be released as the vanguard of a large modernization leap forward for the fleet, and their lifespan would be limited regardless of any major facelifts. Additionally, both the existing nearspace and deep space ships were deemed too critical to operations in the short term to take them out of service for the time needed to refit the entire class.



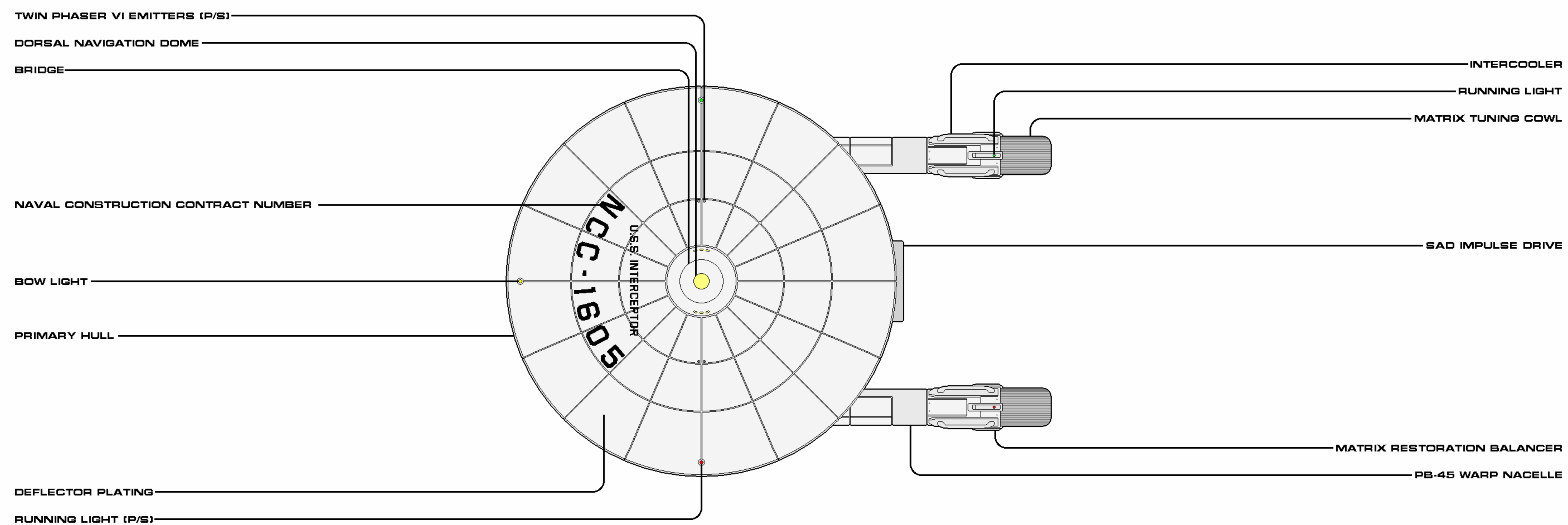
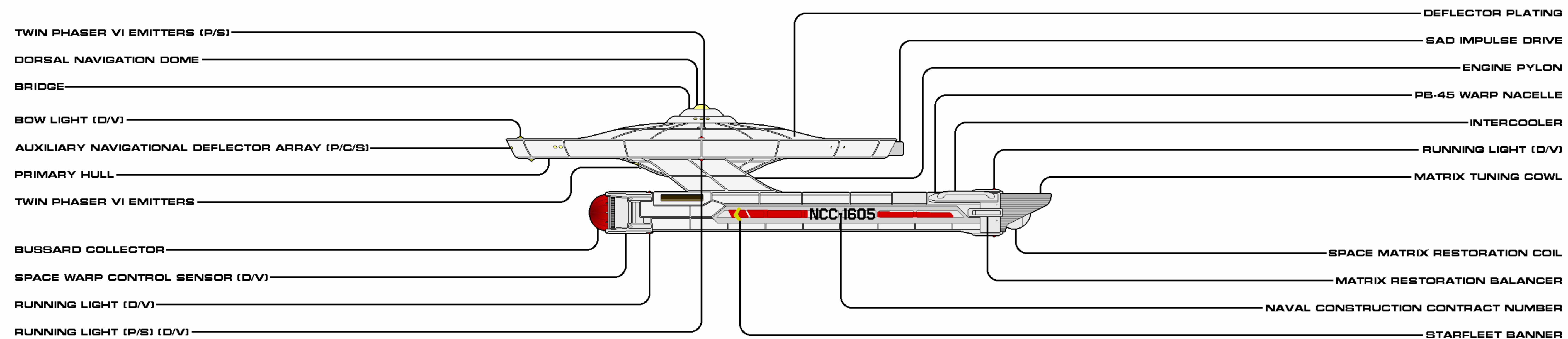

SHEET 1 OF 2

CLASS	BURKE	CATEGORY	NEARSPACE FRIGATE
VARIANT	FLIGHT III	CONSTRUCTED	2244
LENGTH	119.6 M	BEAM	122.0 M
HEIGHT	41.1 M	MASS	360,100 MT
OPERATIONAL	8/61	RELEASE DATE	1906.01

Authorized for release by Star Fleet Bureau of Starship Construction

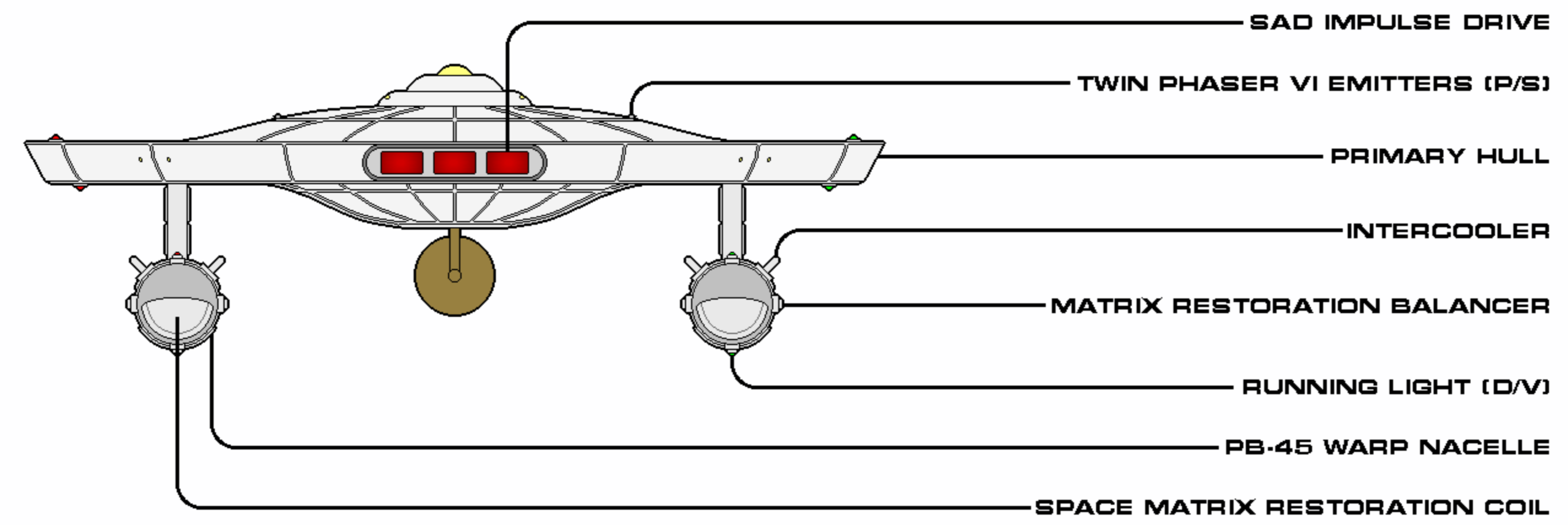
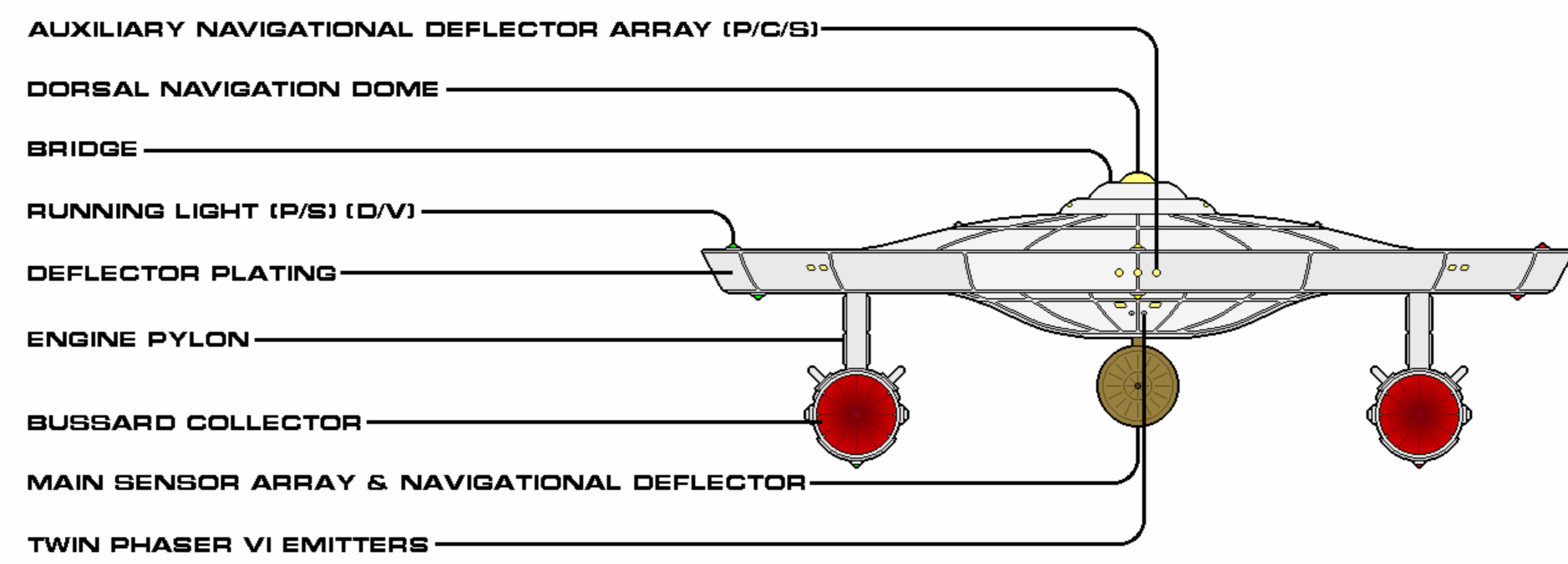
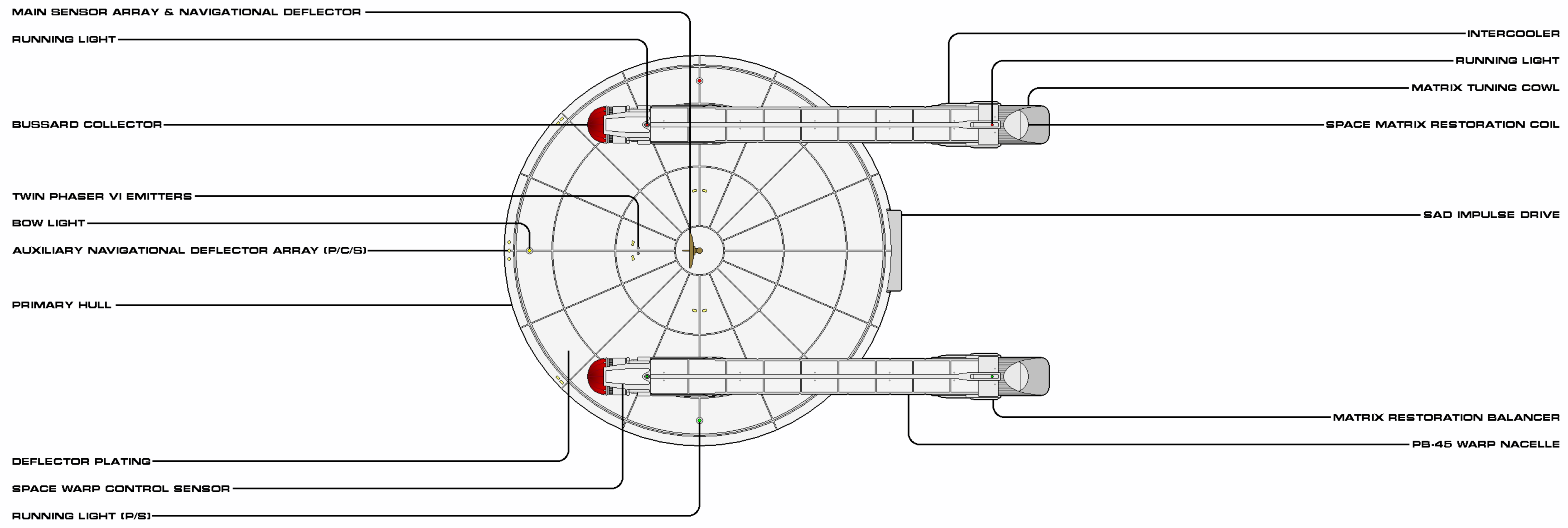

SHEET 2 OF 2

CLASS	BURKE	CATEGORY	NEARSPACE FRIGATE
VARIANT	FLIGHT III	CONSTRUCTED	2244
LENGTH	179.6 M	BEAM	122.0 M
HEIGHT	41.1 M	MASS	300,100 MT
OPERATIONAL	01/01	RELEASE DATE	1900.01

Authorized for release by Star Fleet Bureau of Starship Construction

## ALDRIN FLIGHT III

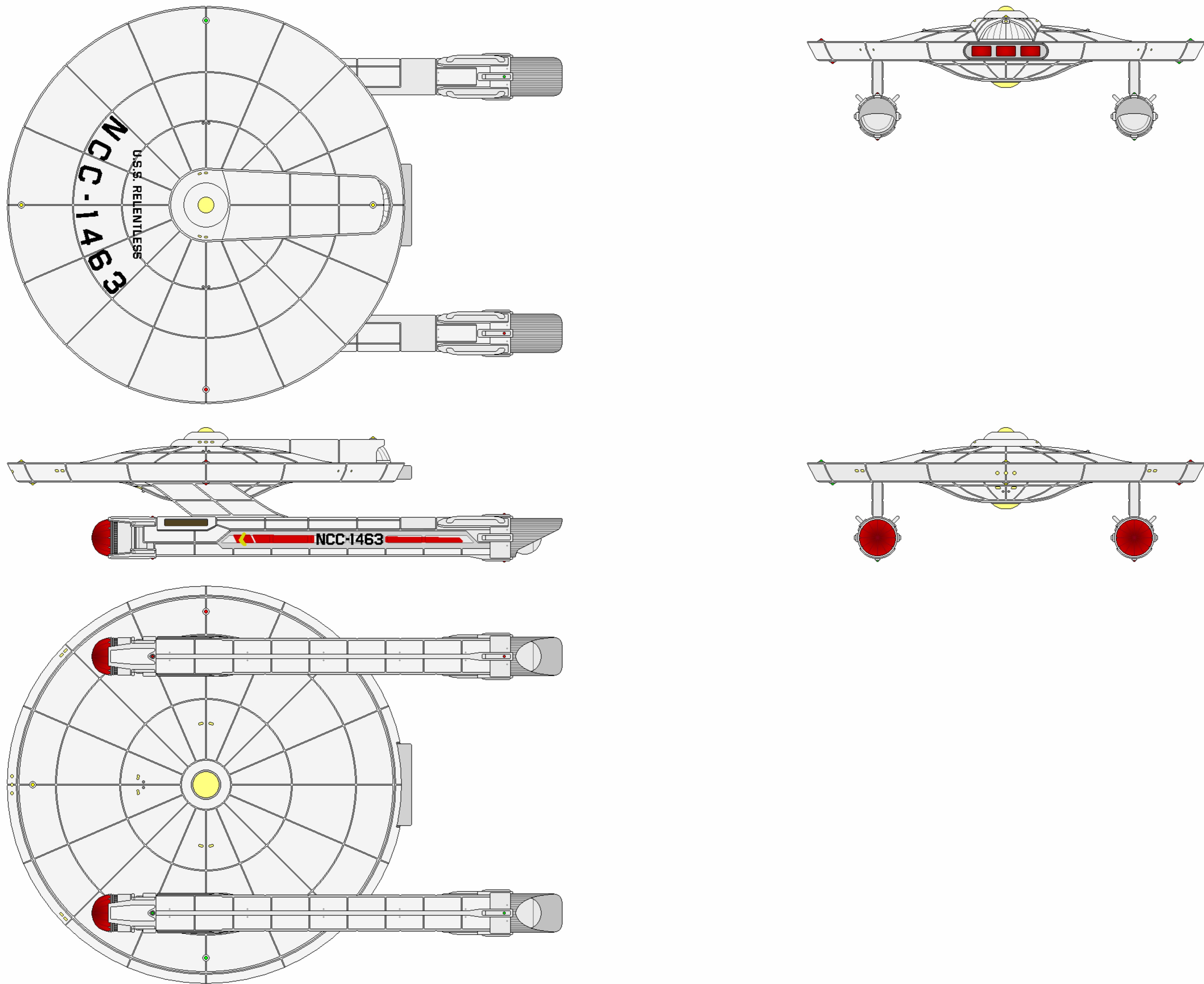

CATEGORY: DEEP SPACE FRIGATE  
OPERATIONAL: 2244 - 2267  
MODIFIED: 4 (2244 - 2245)

DIMENSIONS:  
LENGTH: 179.6 M  
BEAM: 122.0 M  
HEIGHT: 41.7 M  
MASS: 361,200 MT

PERFORMANCE:  
CRUISE: WARP 5 (OCU)  
MAX: WARP 8 (OCU)  
ENDURANCE: 3 YEARS

COMPLEMENT:  
OFFICERS: 25  
ENLISTED: 214

TACTICAL:  
- 6X TYPE VI PHASERS  
- 2-LAYER CONFORMAL FORCEFIELD  
- DEFLECTOR ARRAY

AUXILIARIES:  
- 4X WORK PODS





## ALDRIN FLIGHT III AUTHORIZED CONSTRUCTION

THE FOLLOWING SHIPS OF THE ABOVE CLASS WERE AUTHORIZED AS PART OF THE FEDERATION STAR FLEET BY FEDERATION COUNCIL APPROPRIATION.

USS ALDRIN	NCC-1450	USS ZHAI	NCC-1464
USS RELENTLESS	NCC-1463	USS KOTOV	NCC-1473

### GENERAL INFORMATION

In 2244, the Andorian shipbuilder company Chiokis, a sub-contracting design firm for previous ship classes, won the Star Fleet bid to modernize the Burke class nearspace frigate with the new solid state era nacelles. Chiokis seized this for the opportunity to promote its primary hull design (also a saucer shape), because the new PB-45 warp nacelles required external power generation: a total matter conversion powerplant not built into the nacelle itself, allowing the ship to achieve a cruising speed of warp 5 and a max speed of warp 8. This required a near-complete redesign of the saucer section to accommodate this massive new system.

Select ships of the Burke and Aldrin subclass series were designated for this radical refit; along with the new saucer modifications—both internal and external—they also received the latest (in the now more dependable) phaser emitters in twin banks, the new SAD impulse assembly, and, a ventral "bulge" extension that would very soon be considered a characteristic of Chiokis' saucers. These modifications gave the ships a more engineered—less organic—look compared to the majority of the remaining ships of Geering origination.

All in all, only 4 of the Aldrins would receive this upgrade (though an additional 8 would be selected for the Magellan deep reconnaissance variation). Not because the design concept was a failure by any means, but because of the expense and time for the upgrade was deemed too intrusive. This class would soon be a generation older in comparison to the numerous ship designs expected to be released as the vanguard of a large modernization leap forward for the fleet, and their lifespan would be limited regardless of any major facelifts. Additionally, both the existing nearspace and deep space ships were deemed too critical to operations in the short term to take them out of service for the time needed to refit the entire class.

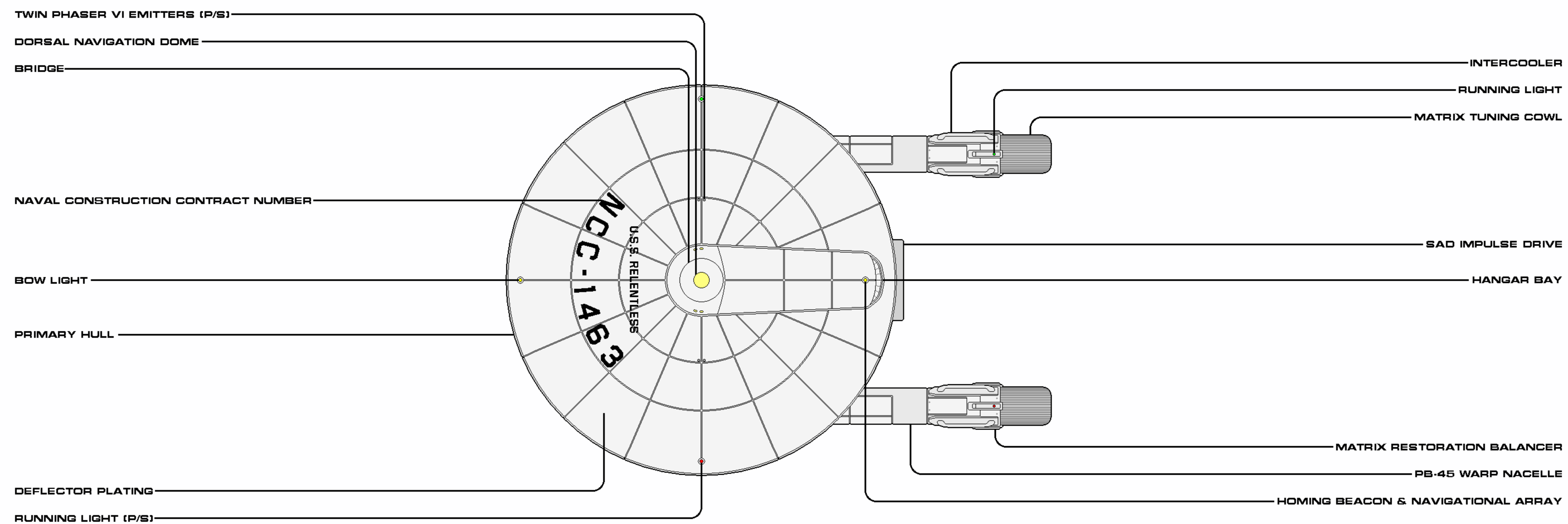
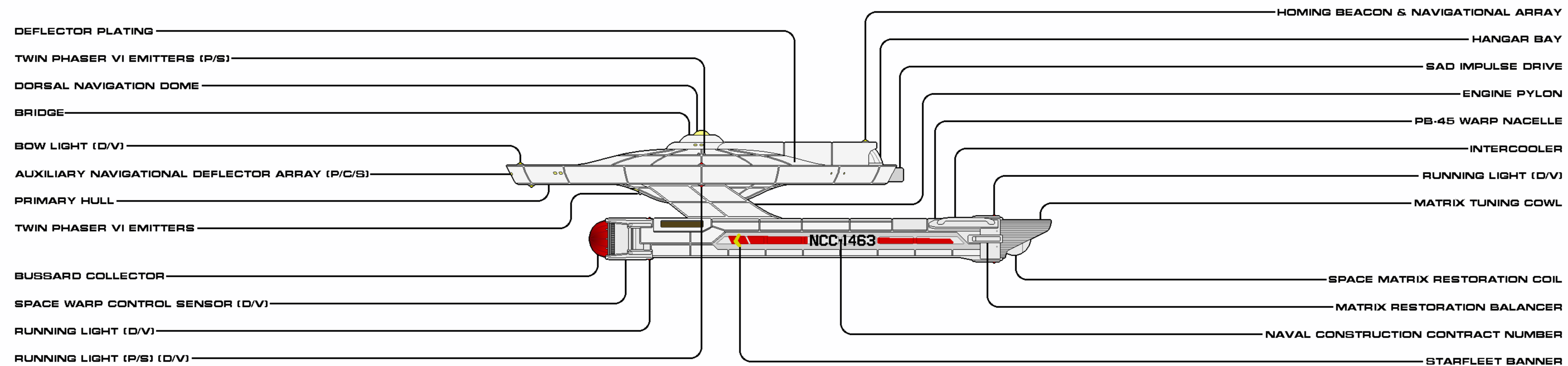

SHEET 1 OF 2

CLASS	BURKE	CATEGORY	DEEP SPACE FRIGATE
VARIANT	ALDRIN FLIGHT III	CONSTRUCTED	2244
LENGTH	179.0 M	BEAM	122.0 M
HEIGHT	41.1 M	MASS	361,200 MT
OPERATIONAL	4/61	RELEASE DATE	1906.01

Authorized for release by Star Fleet Bureau of Starship Construction

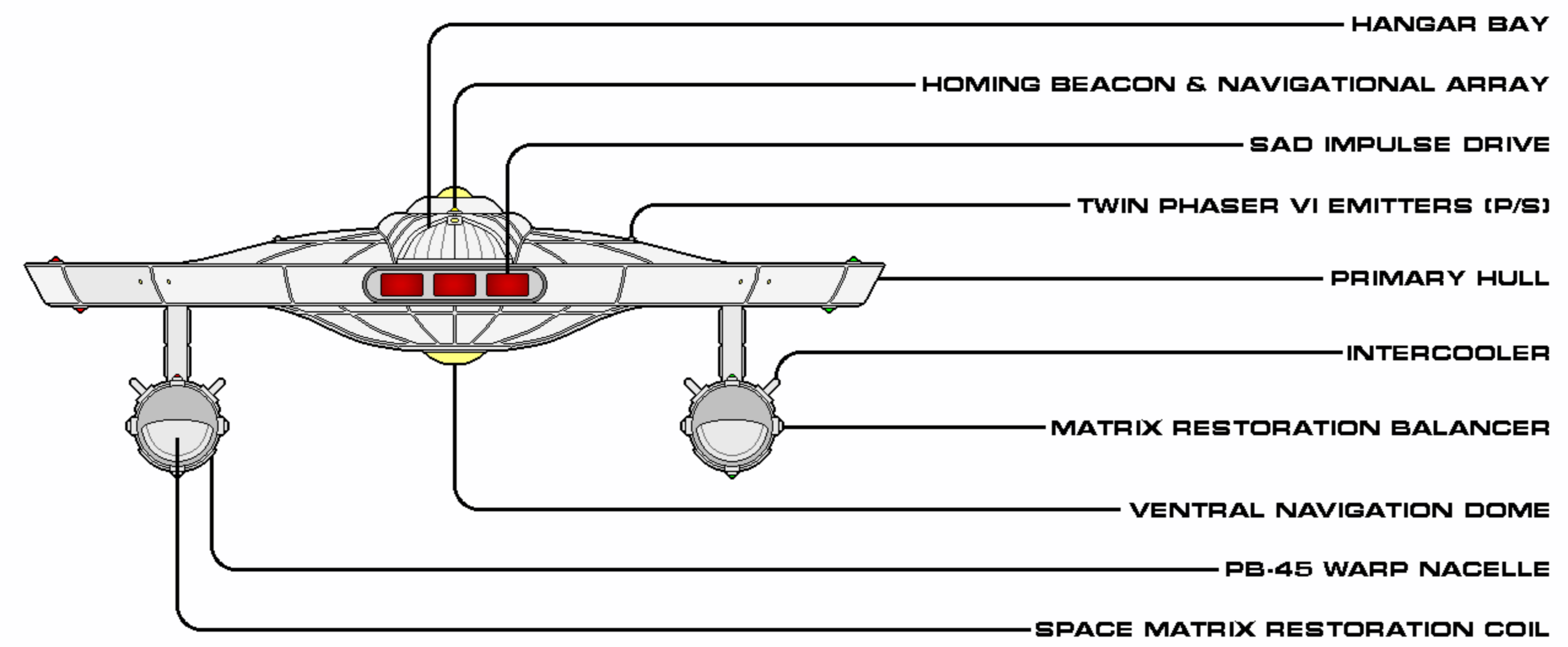
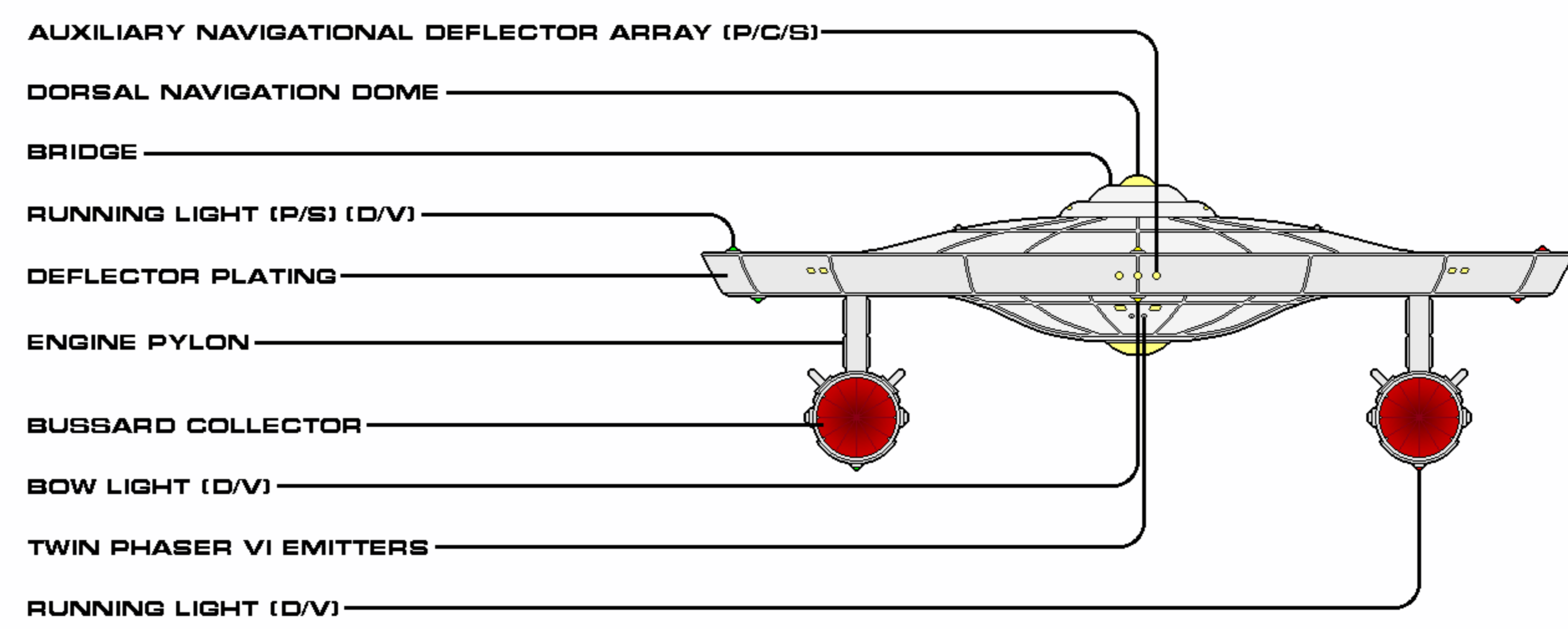
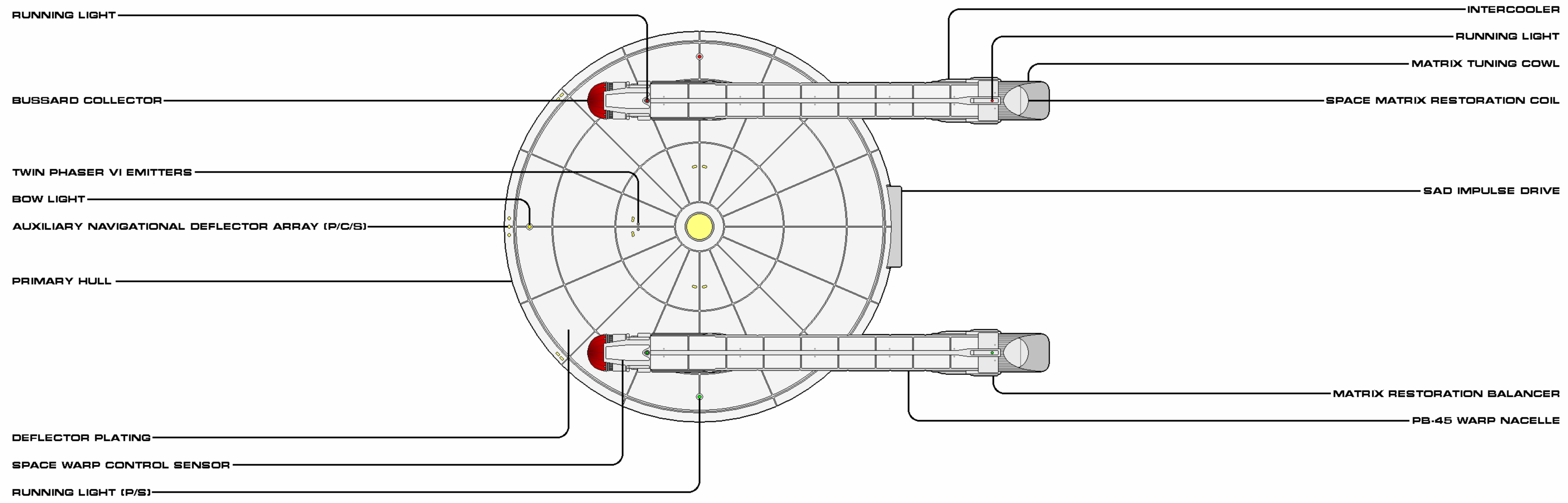

SHEET 2 OF 2

CLASS	BURKE	CATEGORY	DEEP SPACE FRIGATE
VARIANT	ALDRIN FLIGHT III	CONSTRUCTED	2244
LENGTH	179.0 M	BEAM	122.0 M
HEIGHT	41.1 M	MASS	301,200 MT
OPERATIONAL	4/61	RELEASE DATE	1900.01

Authorized for release by Star Fleet Bureau of Starship Construction



## MAGELLAN SUBCLASS

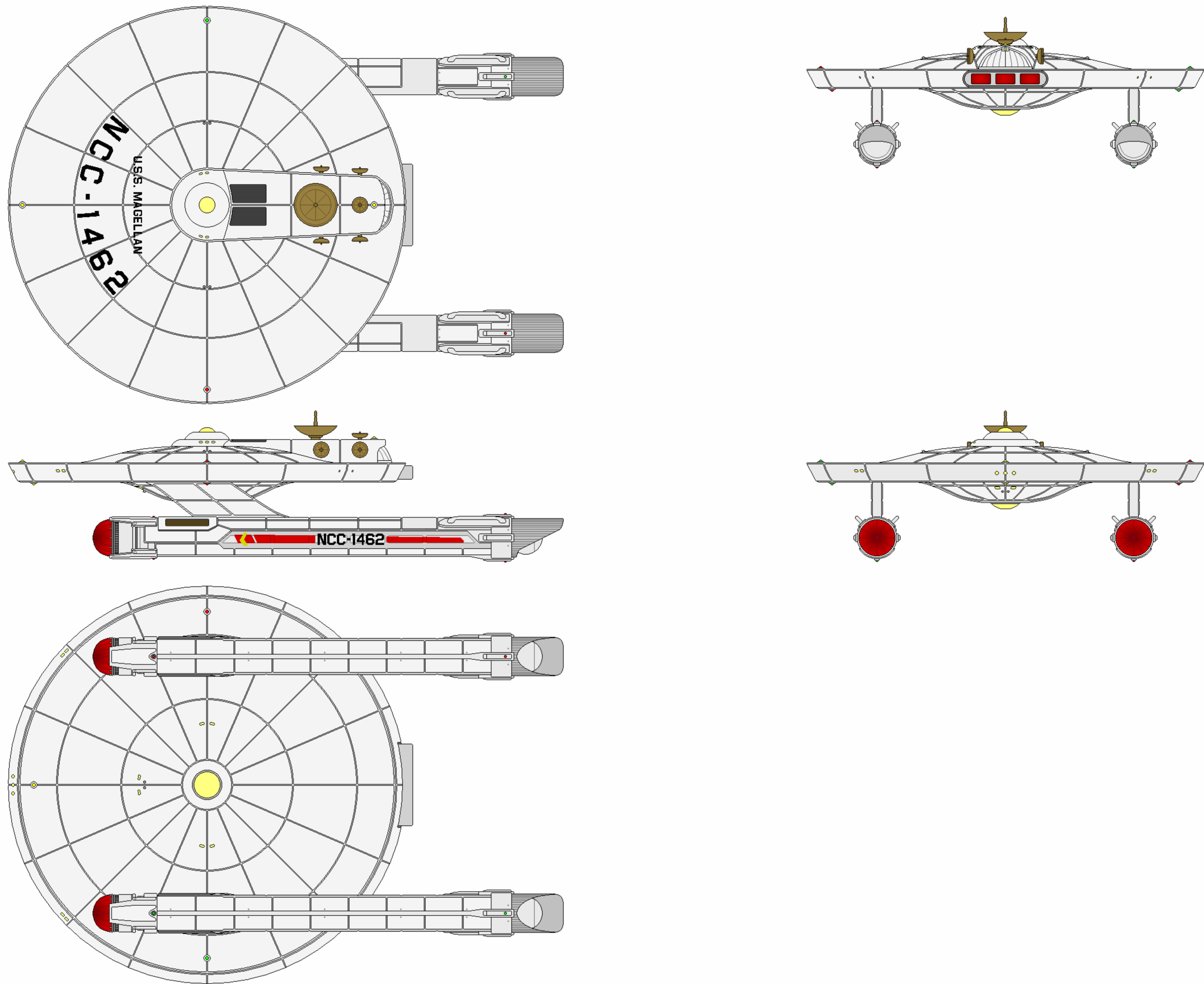

CATEGORY: SCOUT CRUISER  
OPERATIONAL: 2244 - 2267  
MODIFIED: 8 (2244 - 2245)

DIMENSIONS:  
LENGTH: 179.6 M  
BEAM: 122.0 M  
HEIGHT: 46.9 M  
MASS: 361,400 MT

PERFORMANCE:  
CRUISE: WARP 5 (OCU)  
MAX: WARP 8 (OCU)  
ENDURANCE: 3 YEARS

COMPLEMENT:  
OFFICERS: 25  
ENLISTED: 214

TACTICAL:  
- 6X TYPE VI PHASERS  
- 2-LAYER CONFORMAL FORCEFIELD  
- DEFLECTOR ARRAY

AUXILIARIES:  
- 3X WORK PODS



## MAGELLAN SUBCLASS AUTHORIZED CONSTRUCTION

THE FOLLOWING SHIPS OF THE ABOVE CLASS WERE AUTHORIZED AS PART OF THE FEDERATION STAR FLEET BY FEDERATION COUNCIL APPROPRIATION. NOTE: EACH OF THESE VESSELS WERE MODIFIED FROM THEIR PREVIOUS ALDRIN FLIGHT II CONFIGURATION.

USS MOGENSEN	NCC-1451	USS ATKOV	NCC-1461
USS DYOMIN	NCC-1453	USS MAGELLAN	NCC-1462
USS MITCHELL	NCC-1454	USS SCHMITT	NCC-1468
USS SHARMAN	NCC-1456	USS FRIMOUT	NCC-1469

---

### GENERAL INFORMATION

In 2244, with the decision to upgrade the Burkes and Aldrins to the developing Chiokis standard, a total of 12 of the latter subclass were re-assigned to regional drydocks to begin the yard period. Eight of these were selected to receive what was tentatively referred to as the Aldrin Flight III Plus overhaul, wherein they would receive all of the deep space equipment, but also have a multi-mission adaptable sensor suite bolted on all three sides of the re-configured spinal extension.

Oddly enough, one of the selling features of the earlier Flight II Aldrins was the adaptable attachment rail that ran along the dorsal side of the extension, but was removed for the Flight III series. Nonetheless, the variety of sensors installed (gravimetric, multiphasic, magneton, subspace differential, and virtual positron) were not intended to come off and their breadth met more than most expected contingencies. Additionally, an improved command, control, communications and intelligence (C3I) suite was internally installed to allow the ship to conduct its main mission: deep space reconnaissance. And in this role they performed exceptionally well, with sterling service in the Four Years War.

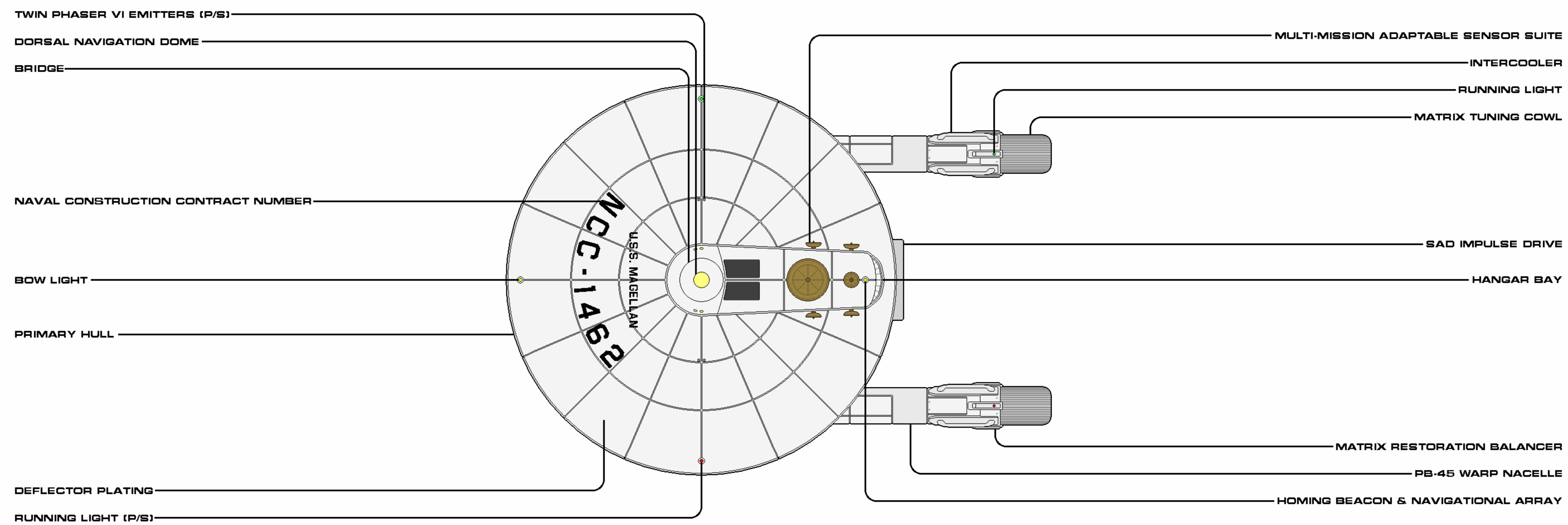
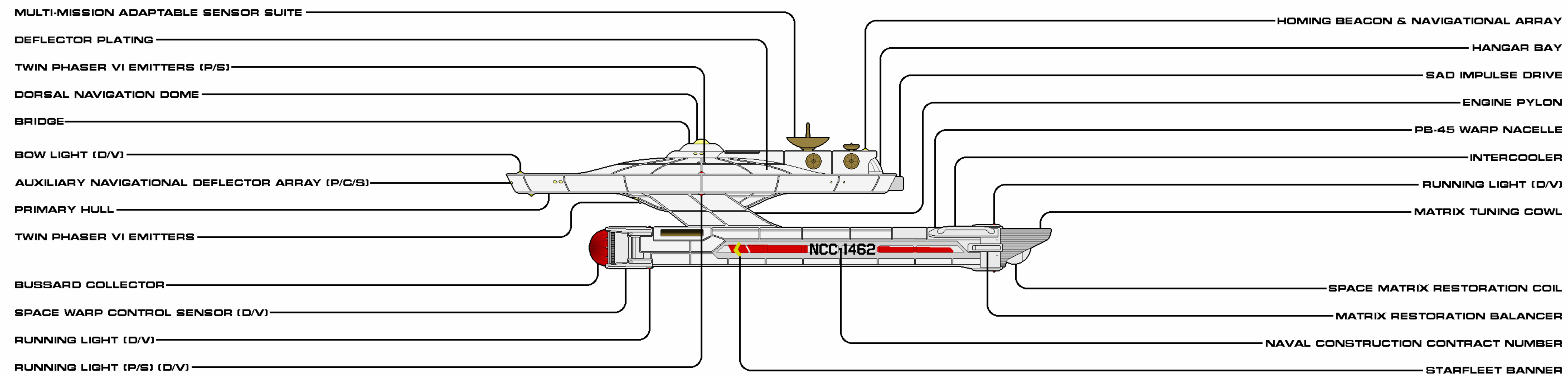

SHEET 1 OF 2

CLASS	BURKE	CATEGORY	SCOUT CRUISER
VARIANT	MAGELLAN	CONSTRUCTED	2244
LENGTH	179.6 M	BEAM	122.0 M
HEIGHT	46.9 M	MASS	361,400 MT
OPERATIONAL	8/61	RELEASE DATE	1906.01

Authorized for release by Star Fleet Bureau of Starship Construction



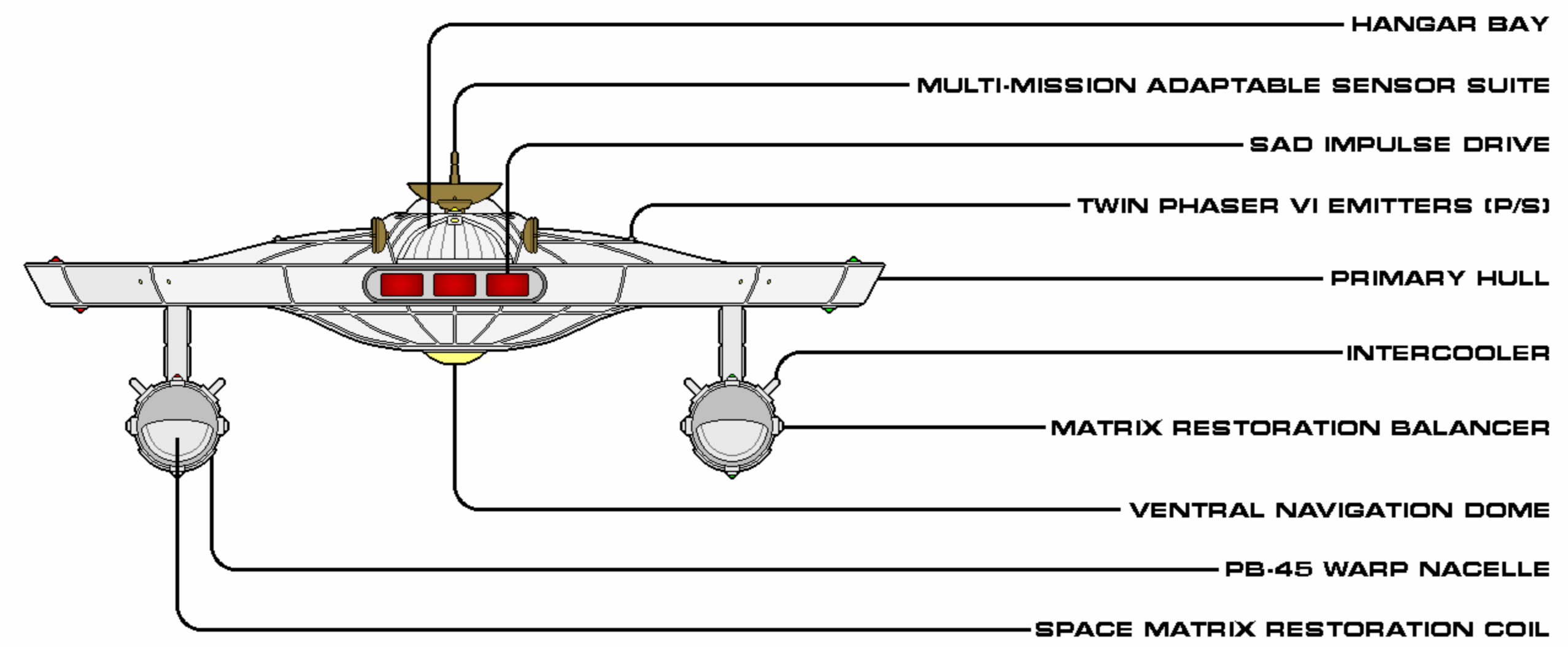
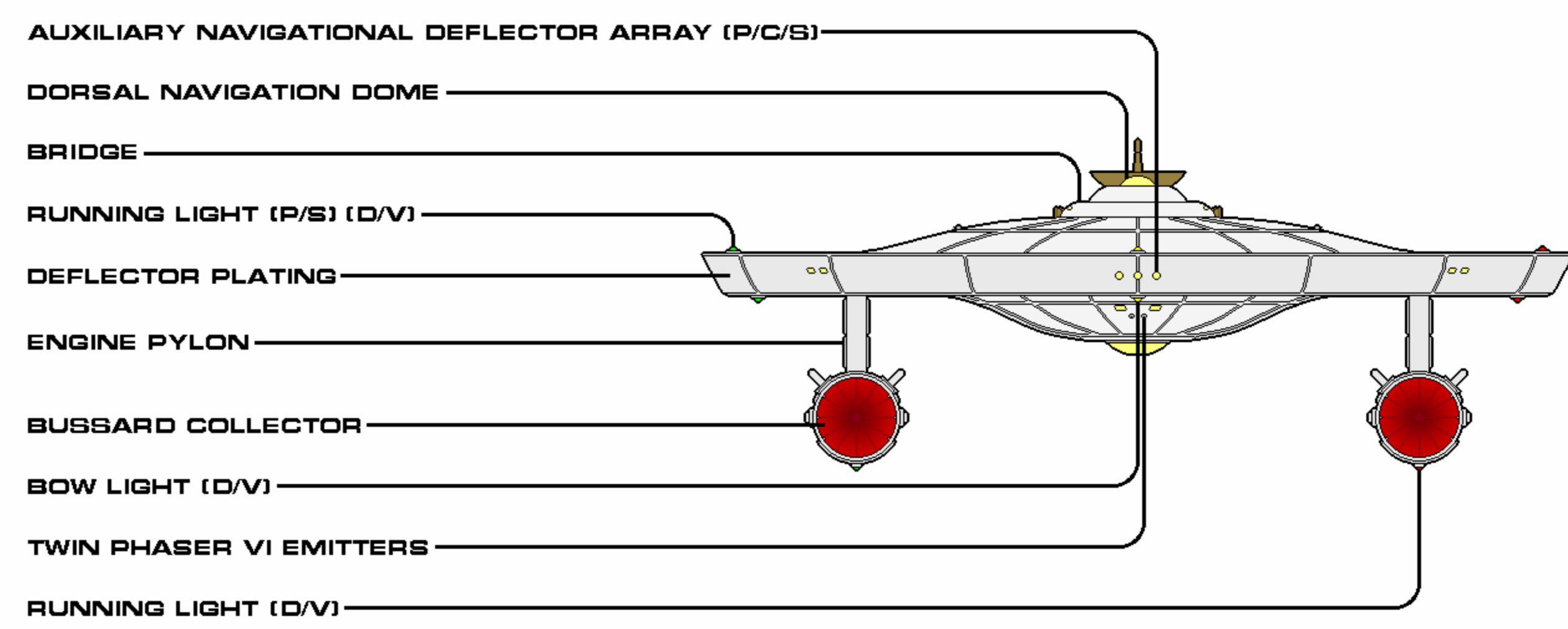
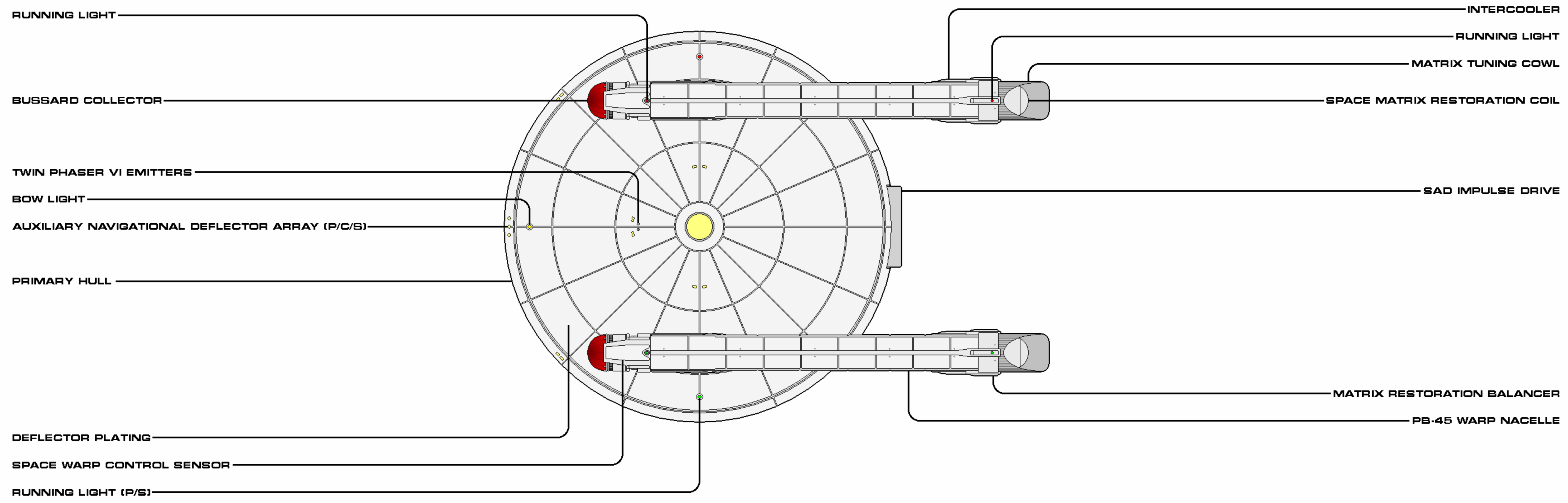

SHEET 2 OF 2

CLASS	BURKE	CATEGORY	SCOUT CRUISER
VARIANT	MAGELLAN	CONSTRUCTED	2244
LENGTH	179.6 M	BEAM	122.0 M
HEIGHT	46.9 M	MASS	361,400 MT
OPERATIONAL	01/01	RELEASE DATE	1906.01

Authorized for release by Star Fleet Bureau of Starship Construction

## BURKE FLIGHT IV

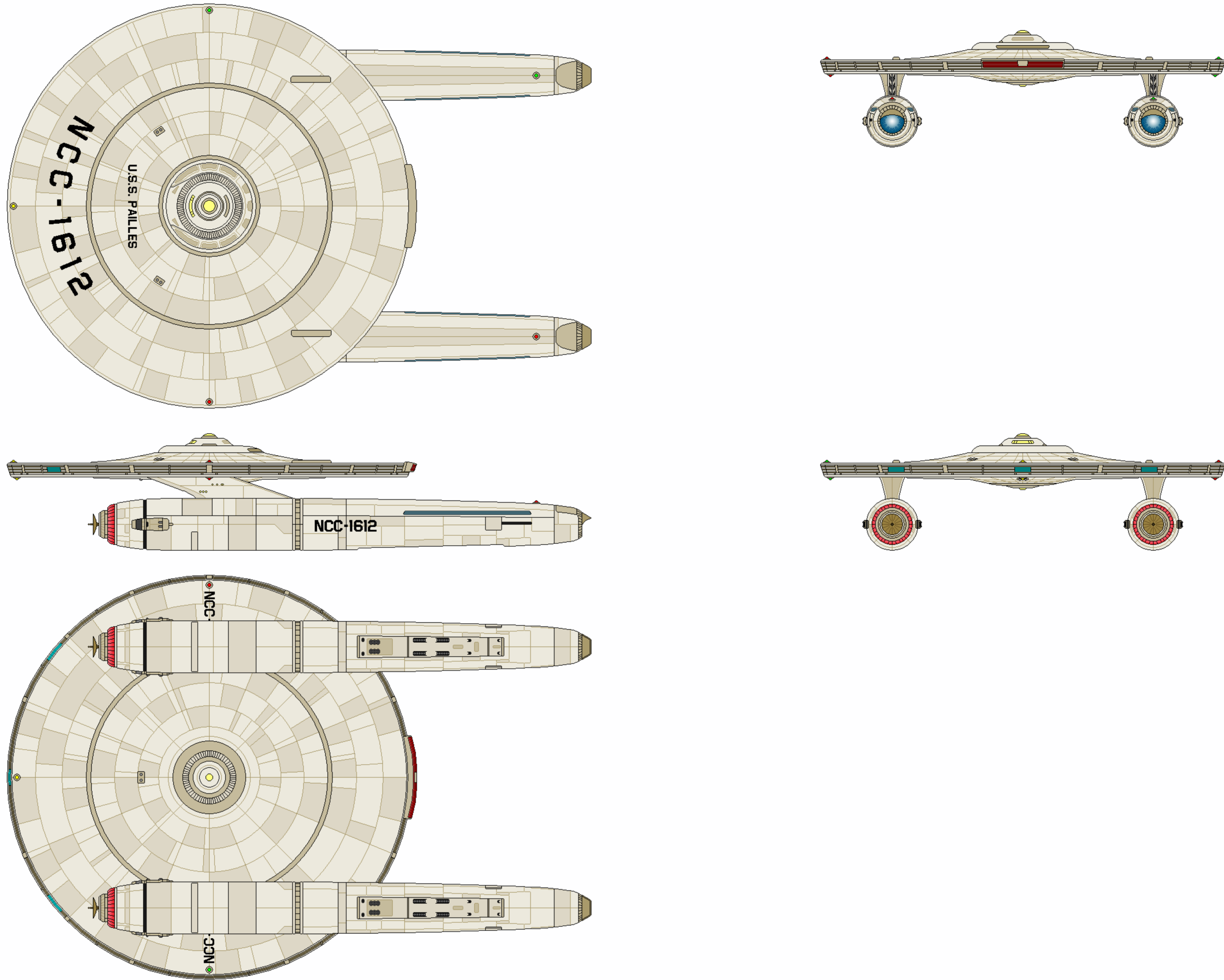

CATEGORY: NEARSPACE FRIGATE  
OPERATIONAL: 2252 - 2260  
MODIFIED: 35 (2252 - 2254)

DIMENSIONS:  
LENGTH: 185.8 M  
BEAM: 122.0 M  
HEIGHT: 35.5 M (39.9 POD)  
MASS: 321,200 MT

PERFORMANCE:  
CRUISE: WARP 4 (OCU)  
MAX: WARP 6.5 (OCU)  
ENDURANCE: 2 YEARS

COMPLEMENT:  
OFFICERS: 25  
ENLISTED: 214

TACTICAL:  
- 6X TYPE VI PHASERS  
- 2-LAYER CONFORMAL FORCEFIELD  
- 2X PRIMARY NAVIGATIONAL DEFLECTORS  
- 3X AUXILIARY DEFLECTOR EMITTERS  
- OPTIONAL: 4X MEDIUM TORPEDO TUBES (W/ 40 TORPEDOES)  
- OPTIONAL: DEFLECTOR POD

AUXILIARIES: NONE





## BURKE FLIGHT IV AUTHORIZED CONSTRUCTION

THE FOLLOWING SHIPS OF THE ABOVE CLASS WERE AUTHORIZED AS PART OF THE FEDERATION STAR FLEET BY FEDERATION COUNCIL APPROPRIATION.

USS FIREFLY	NCC-1601	USS NIGHTHAWK	NCC-1623
USS CLAYTON	NCC-1602	USS FIREBRAND	NCC-1624
USS QUILEUTE	NCC-1603	USS ECHO	NCC-1625
USS DRAGON	NCC-1604	USS SCIMITAR	NCC-1626
USS INTERCEPTOR	NCC-1605	USS ASTUTE	NCC-1628
USS BULWARK	NCC-1606	USS AQUITAINE	NCC-1629
USS THYHLEL	NCC-1609	USS FREYA	NCC-1630
USS BILLINGS	NCC-1610	USS TRENCHANT	NCC-1631
USS MAGPIE	NCC-1611	USS CALDER	NCC-1632
USS PAILLES	NCC-1612	USS MAURITIUS	NCC-1633
USS IROQUOIS	NCC-1614	USS ARGYLL	NCC-1634
USS DARING	NCC-1615	USS ACACIA	NCC-1635
USS ABYSSINIA	NCC-1616	USS LANCASTER	NCC-1636
USS RAMSEY	NCC-1617	USS PROTECTOR	NCC-1638
USS MAROON	NCC-1618	USS MANTIS	NCC-1639
USS TRACKER	NCC-1619	USS AGAMEMNON	NCC-1640
USS MAYFLOWER	NCC-1621	USS AOTEAROA	NCC-1641
USS VANGUARD	NCC-1622		

### GENERAL INFORMATION

As stated previously, the Flight III series of refits for the Burkes and Aldrins were abbreviated to 8 and 4 (respectively), due both in part to the expense of upgrading an entire class of aging vessels and their high OPTEMPO, regardless of their warp 6.5 or 8 nacelles. The ships were the linchpin for regional commanders, both in the major spacelanes and the "mid-space" between the homeworlds and the frontier. While it was regrettable the majority of the overall class would not be able to make use of the newer and faster PB-45 nacelles, they were still needed and valued in their respective roles.

Though long range intentions had the Burke lines operational into the 2270s, the intent also was to keep the ships relevant. Between 2252 and 2254, all remaining Flight IIs were brought into the yards for overhauls of the weapons systems. Both the plasma and particle cannons were removed, freeing up considerable space for the Type VI phaser emitters, now that the technology had hit its reliable stride. However, these modernizations did not allow the class to remain operational for the planned length; the first decommissionings began with a sizable block at the beginning of the 2260s, with the last stricken from the Star Fleet rolls in 2267.

The Burkes and Aldrins saw their beam weaponry armament halved with the replacement of the plasma and particle cannons by the three twin-bank phaser emitters during the refit beginning in 2252, from Flight II to Flight IV status. Commanding officers were not reticent to undergo this conversion, for phaser technology was well-touted by the skippers of other ships of the line. That faith did not mean there was any discussion of relieving the Burkes of their torpedo capabilities by removing the modular weapons sled, though. Quite the opposite: Star Fleet now felt it had enough test data to suggest the Type E torpedo module as the standard launcher for sled-equipped ships. Four forward-facing launchers were supported by a large aft-facing vent, allowing the launch-phase targeting sensors to work unimpeded. While this final configuration did not include the aft-facing launchers, the commonality of equipment and alignment allowed the weapons department on each of these ships a greater rate of fire than had been achieved in similar exercises with the previous four configurations.

By this time, operational area commanders were much less reluctant to outfit their Burkes with the weapons sled: regional partners and member states were becoming more accustomed to a more militarized Star Fleet, though they were also appreciative of the duality the fleet demonstrated through the more peace-oriented interactions of other vessels, such as cruisers and medical ships. It didn't hurt, either, to see a Burke warp into the system with a weapons sled now equipped with the new sensor module, in order to timely examine, in detail, some anomaly that had made its presence known or to assist in a black swan catastrophe.





## BURKE FLIGHT IV GENERAL INFORMATION (CONTINUED)

In 2258, a concerted effort was made to save the megesti, an energy-hungry spaceborne species endemic to the Algol system. Studied off and on by visiting exploration and research vessels for a few decades, several conclusions had been reached: the megesti's "natural environment" had been constructed (for them?) 23,000 years ago by parties unknown as a subspace disk orbiting two of the three stars, and the disk was rapidly degrading. The creatures had no more than another 1,550 years before they would fully dissipate. The Horizon class USS *Victoria's* survey of the system and the swarm had even raised the (hotly debated) question of the species' sentience.

The rescue concept was predicated on the idea of rejuvenating the subspace disk using warp-enabled deflectors to build and possibly retain "energy bridges" from the stars' highly charged center of gravity. Normally, such a feat would be well outside the capacity of the Federation, as most inhabitable zones of a solar system are almost a full astronomical unit (AU) or more from the host star(s), and the sheer amount of energy needed to even attempt such a task would be inconceivable. However, the close orbital nature of Beta Persei Aa1 and Aa2 (0.062 AU) allowed the swarm to endlessly travel about the binary pair at a relative distance of only 0.17 AU. Theoreticians suggested it just might be achievable in this specific situation.

Six Flight IV Burkes were equipped with their weapons pods and specially manufactured deflector modules. Five of the vessels were staged at equidistant points within the swarm's orbit (the sixth had standby duty) and engaged their modules at a precise point of the stars' shared revolution. While early indications supported the development of the bridge, it was determined the initial attempt was too short. A month later, the task force tried again, holding their positions for 16 days, and the results were encouraging; the subspace disk was definitely strengthened and the megesti reacted with a multitude of colors in the visual spectrum and alternating oscillations in intensity in the ultraviolet bands. However, when the optimal period of star orbits had passed and the beams were disengaged, the bridges withdrew and the same ratio of degradation had returned. At most, the effort only sustained the swarm's environment for the period of external activity.

It was concluded that a series of stationary subspace enhancers might be able to maintain the bridges for about half the orbital time, which meant that the Federation's efforts would only extend the environment by about an additional 800 years. A better answer would have to be discovered. Meanwhile, the deflector pods would go back into storage, not to be brought out again over the remaining 2 years of the Burkes' service.

A similar image to the Burke Flight IV with modular weapons pod will be found within the Burke Flight II entry.

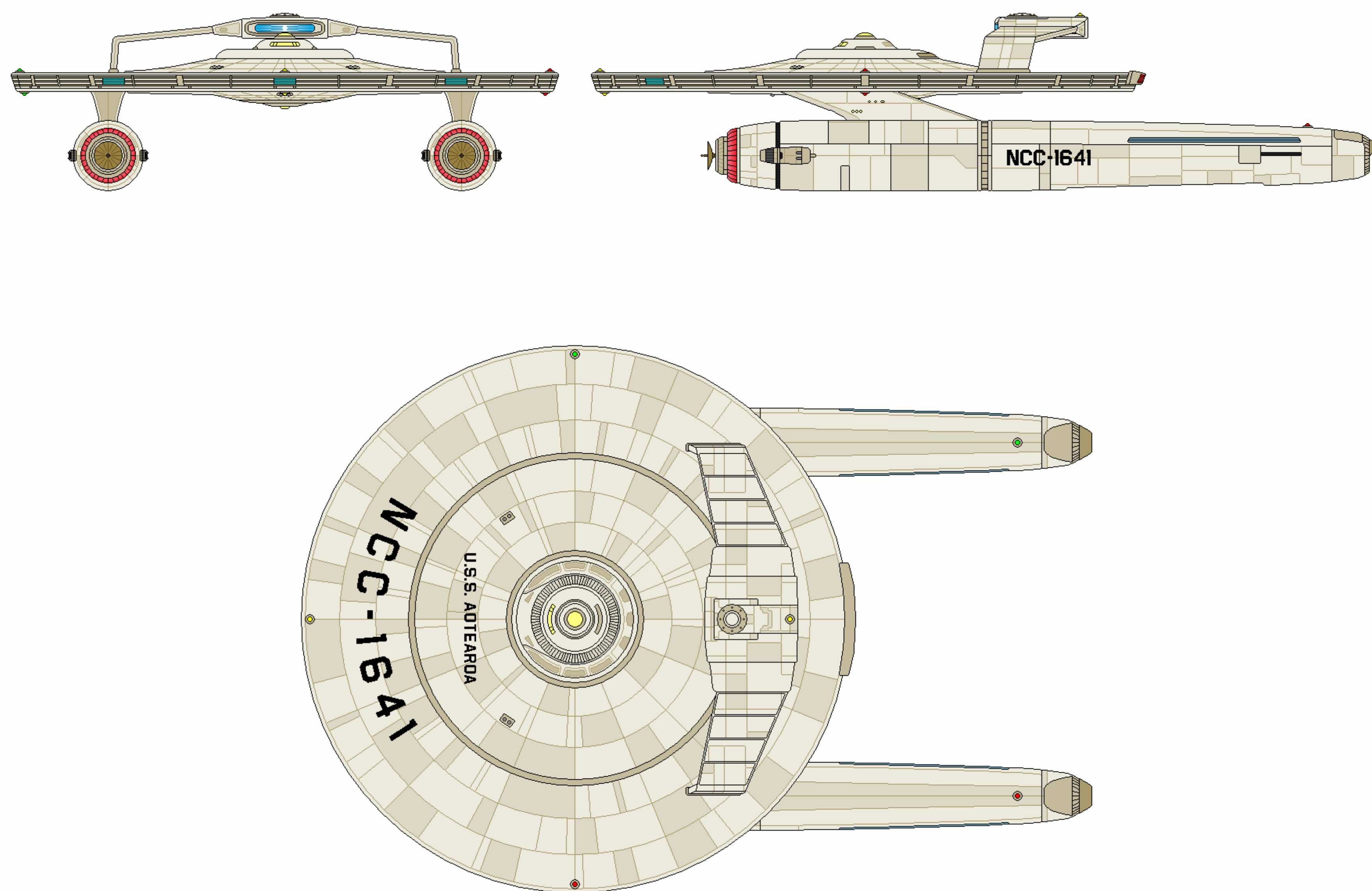

BURKE FLIGHT IV  
WITH MODULAR DEFLECTOR POD

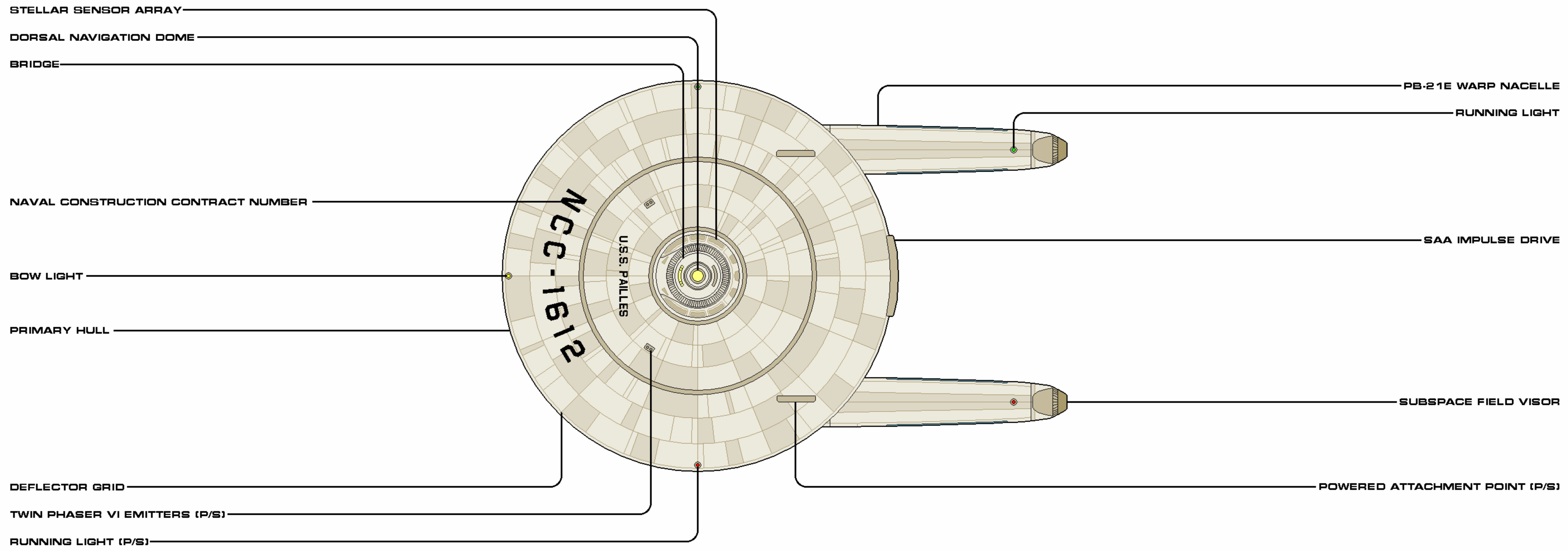
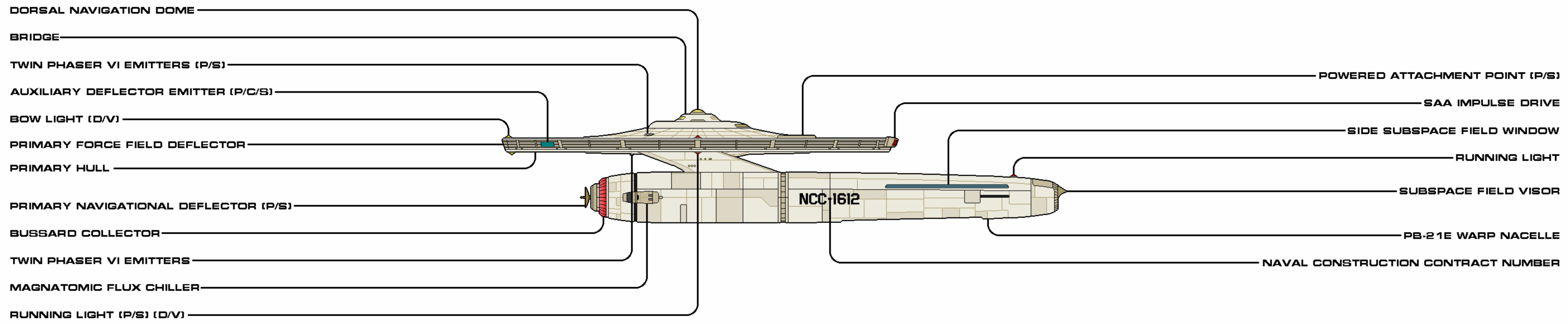

SHEET 1 OF 2

CLASS	BURKE	CATEGORY	NEARSPACE FRIGATE
VARIANT	FLIGHT IV	CONSTRUCTED	2252
LENGTH	125.8 M	BEAM	122.0 M
HEIGHT	35.5 M	MASS	32,200 MT
OPERATIONAL	35/67	RELEASE DATE	1906.01

Authorized for release by Star Fleet Bureau of Starship Construction



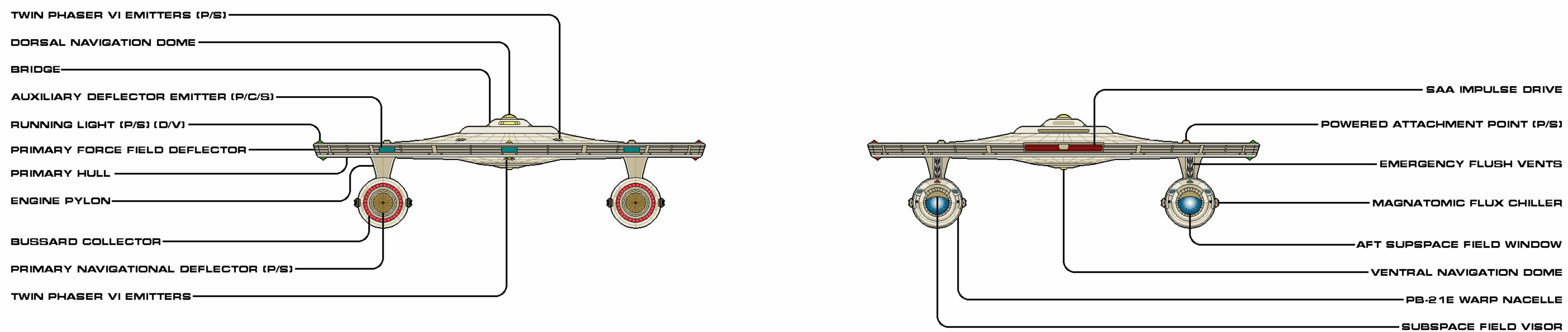
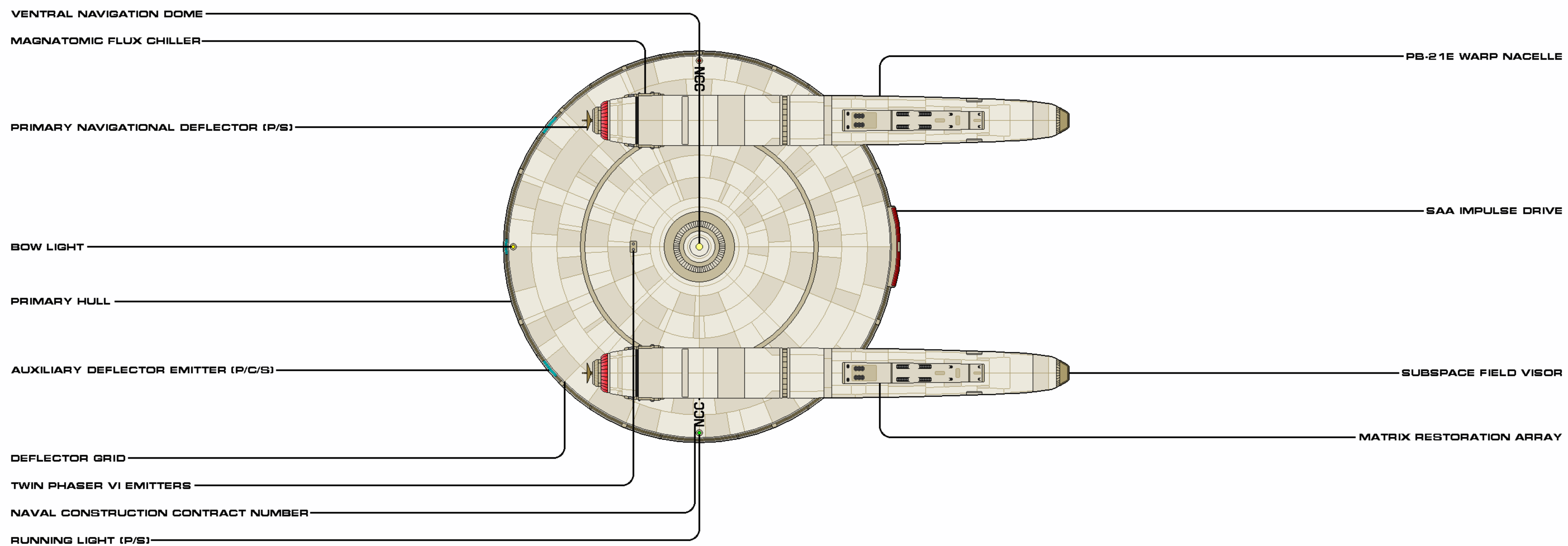

SHEET 2 OF 2

CLASS	BURKE	CATEGORY	NEARSPACE FRIGATE
VARIANT	FLIGHT IV	CONSTRUCTED	2252
LENGTH	185.8 M	BEAM	122.0 M
HEIGHT	35.5 M	MASS	321,200 MT
OPERATIONAL	35/01	RELEASE DATE	1906.01

Authorized for release by Star Fleet Bureau of Starship Construction



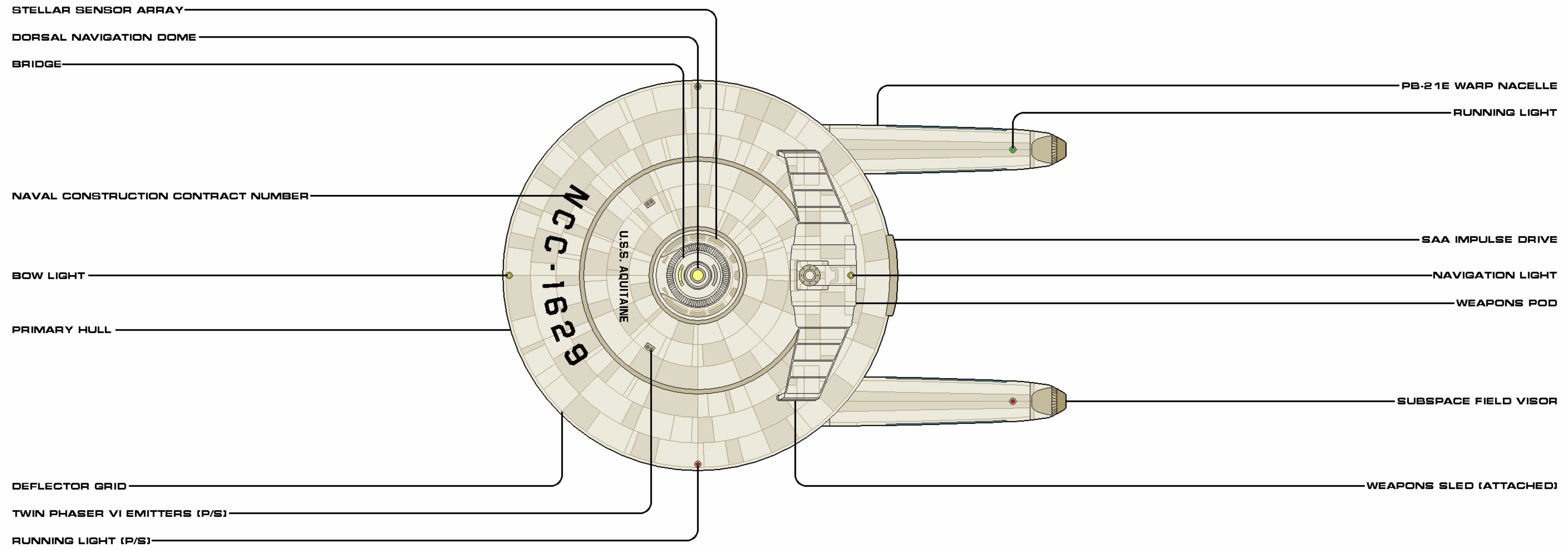
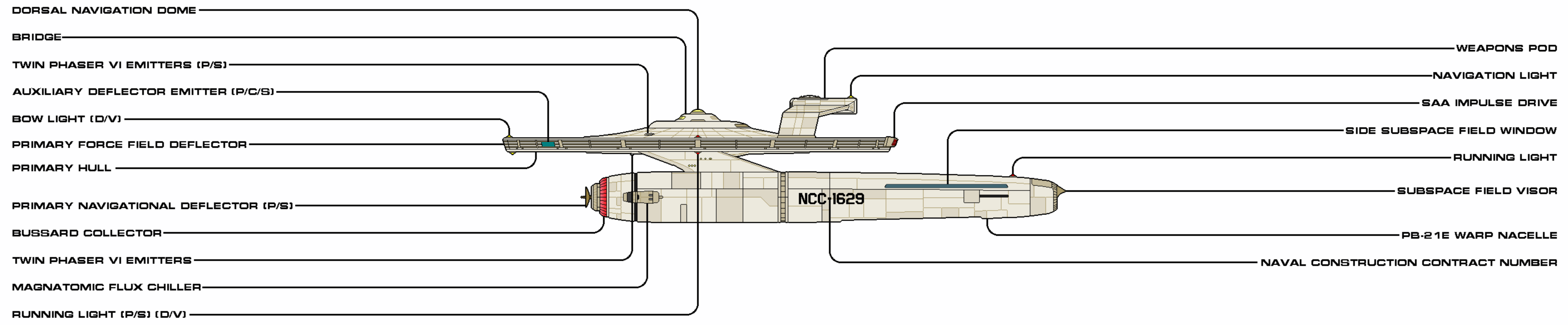

SHEET 1 OF 2

CLASS	BURKE	CATEGORY	NEARSPACE FRIGATE
VARIANT	FLIGHT IV w/ POD	CONSTRUCTED	2252
LENGTH	125.8 M	BEAM	122.0 M
HEIGHT	39.9 M	MASS	VARIABLE (OVER 322,000 MT)
OPERATIONAL	35/67	RELEASE DATE	1906.01

Authorized for release by Star Fleet Bureau of Starship Construction

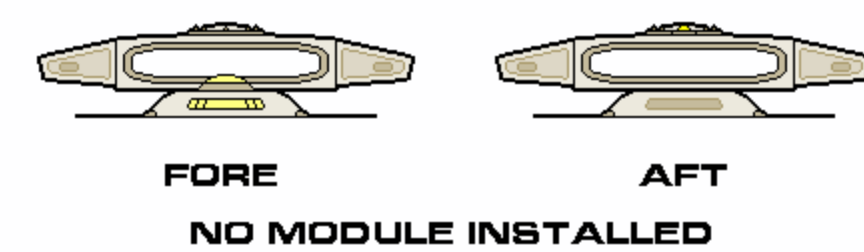
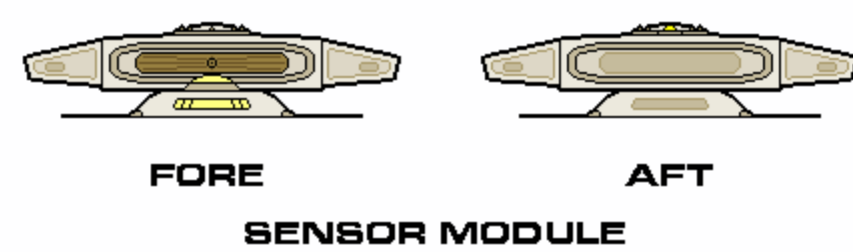
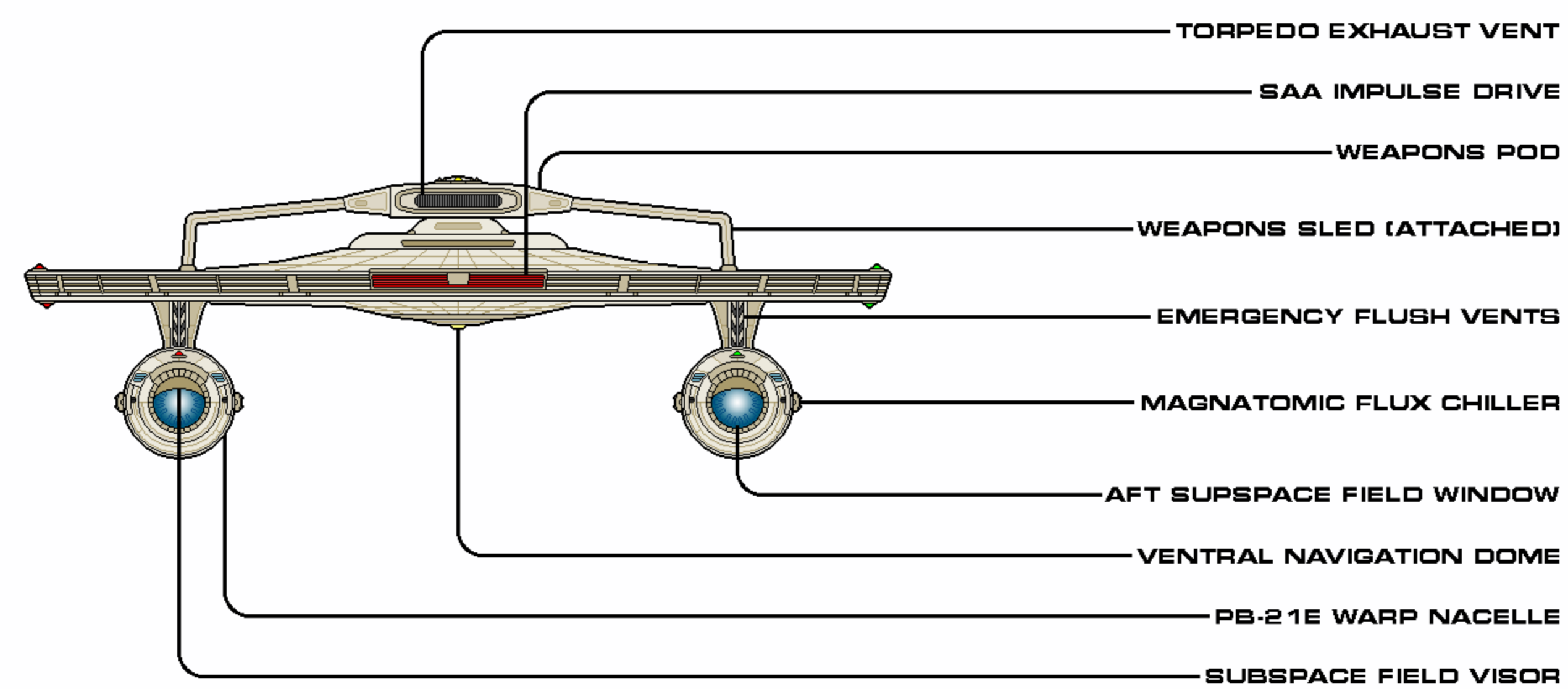
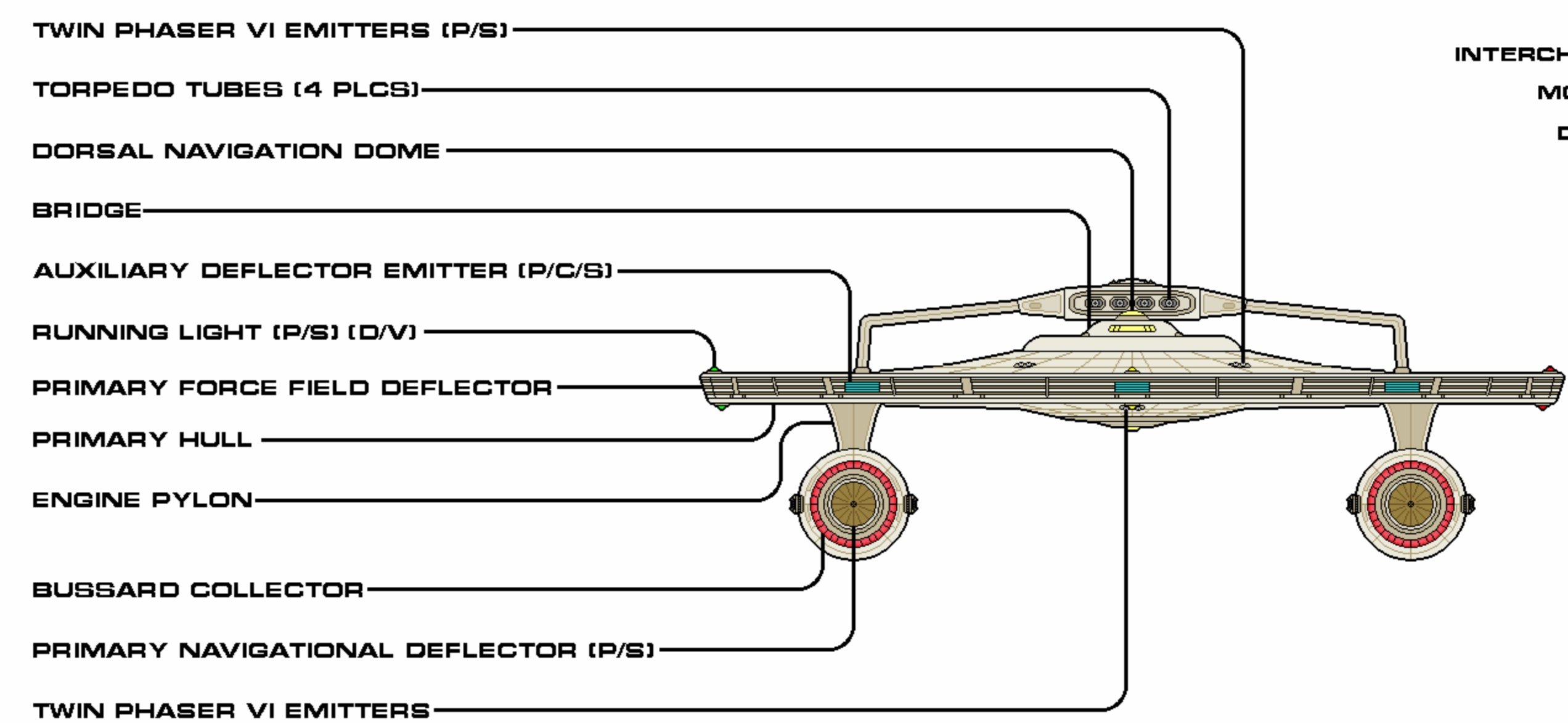
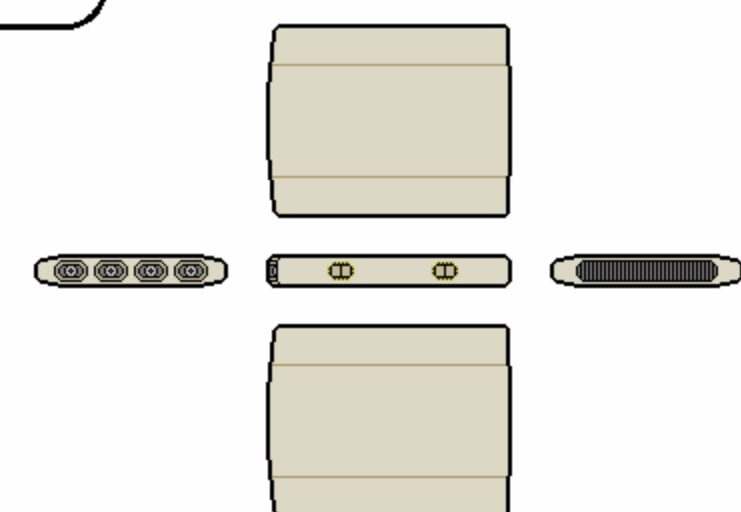
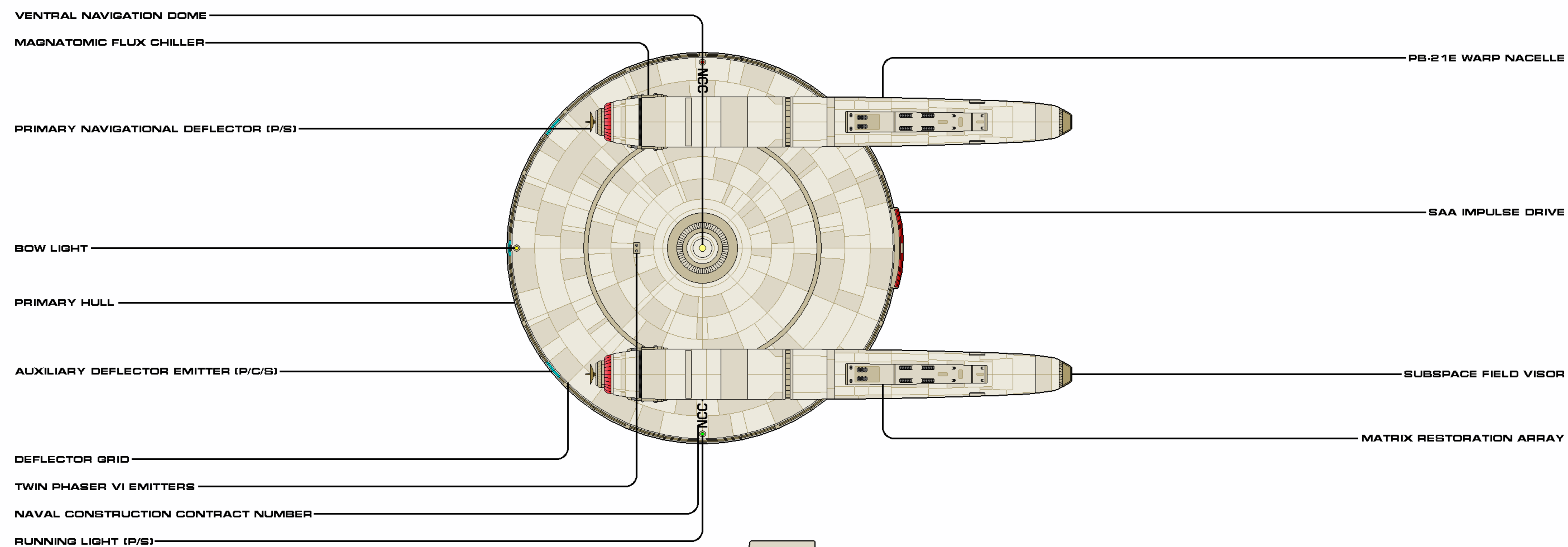

SHEET 2 OF 2

CLASS	BURKE	CATEGORY	NEARSPACE FRIGATE
VARIANT	FLIGHT IV W/ POD	CONSTRUCTED	2252
LENGTH	185.8 M	BEAM	122.0 M
HEIGHT	39.9 M	MASS	VARIABLE (OVER 322,000 MT)
OPERATIONAL	35/01	RELEASE DATE	1906.01

Authorized for release by Star Fleet Bureau of Starship Construction

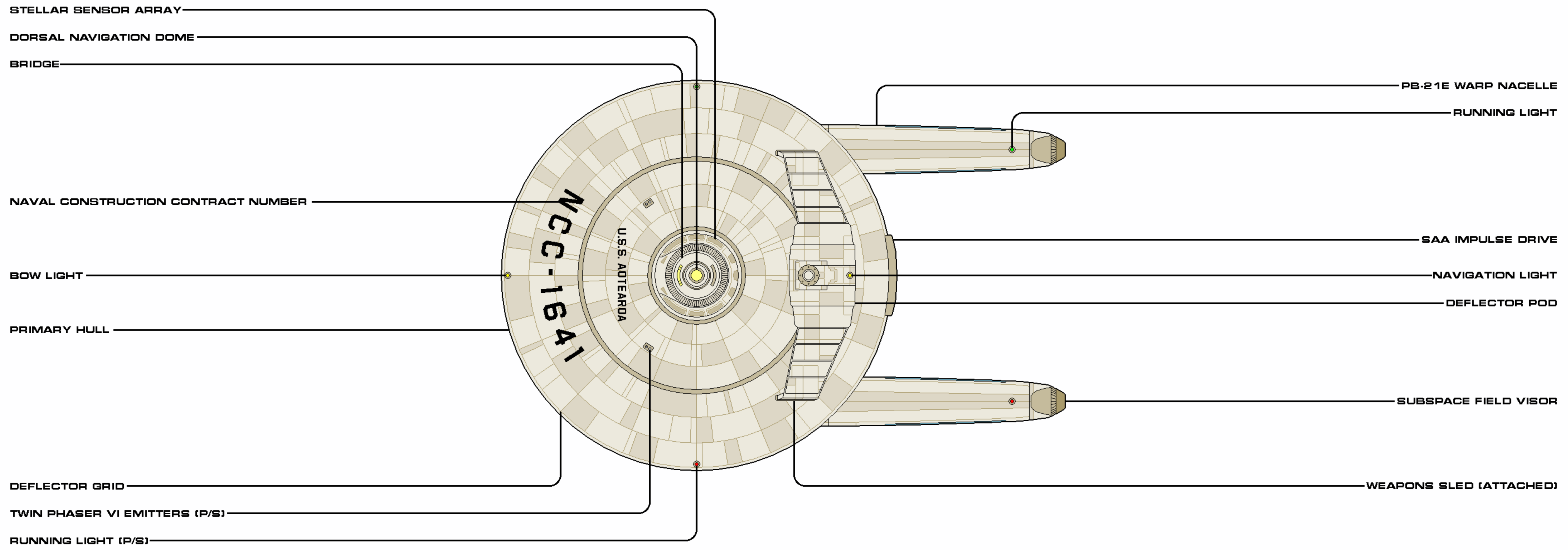
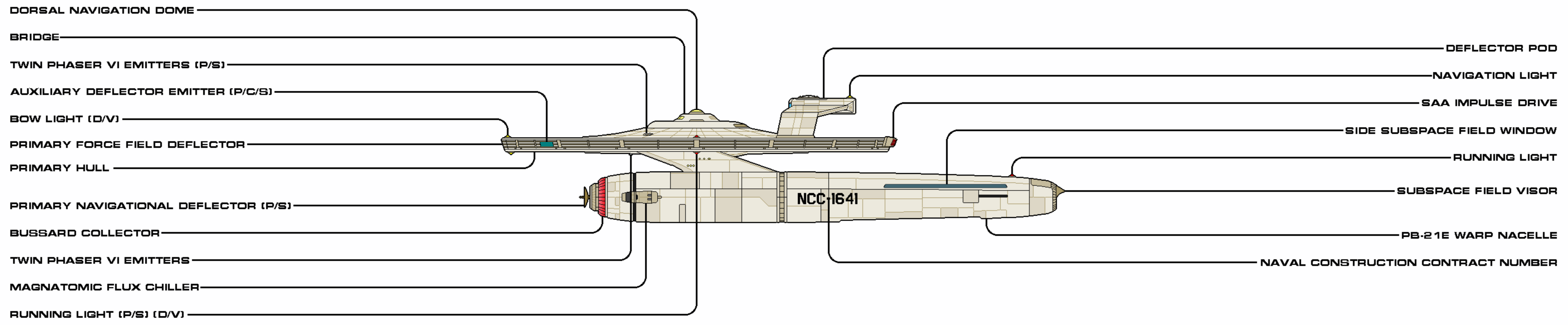

SHEET 1 OF 2

CLASS	BURKE	CATEGORY	NEARSPACE FRIGATE
VARIANT	FLIGHT IV w/ POD	CONSTRUCTED	2252
LENGTH	125.8 M	BEAM	122.0 M
HEIGHT	39.9 M	MASS	322,850 MT
OPERATIONAL	01/01	RELEASE DATE	1906.01

Authorized for release by Star Fleet Bureau of Starship Construction



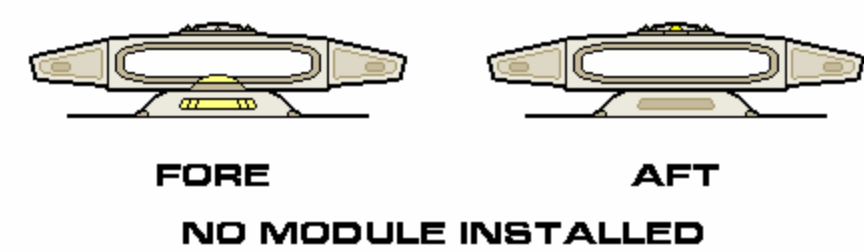
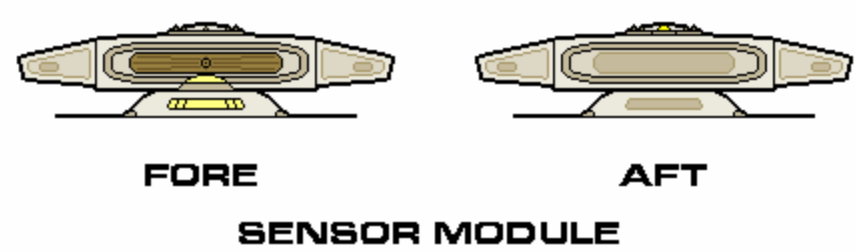
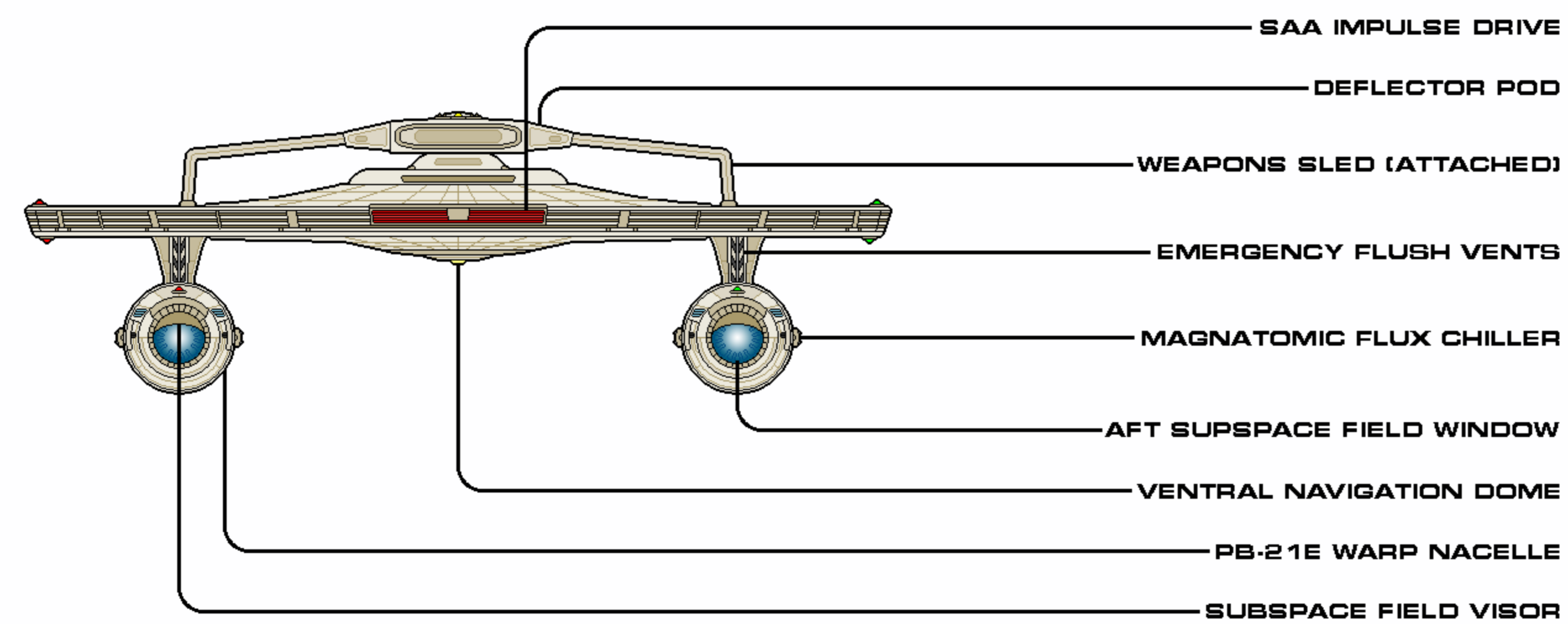
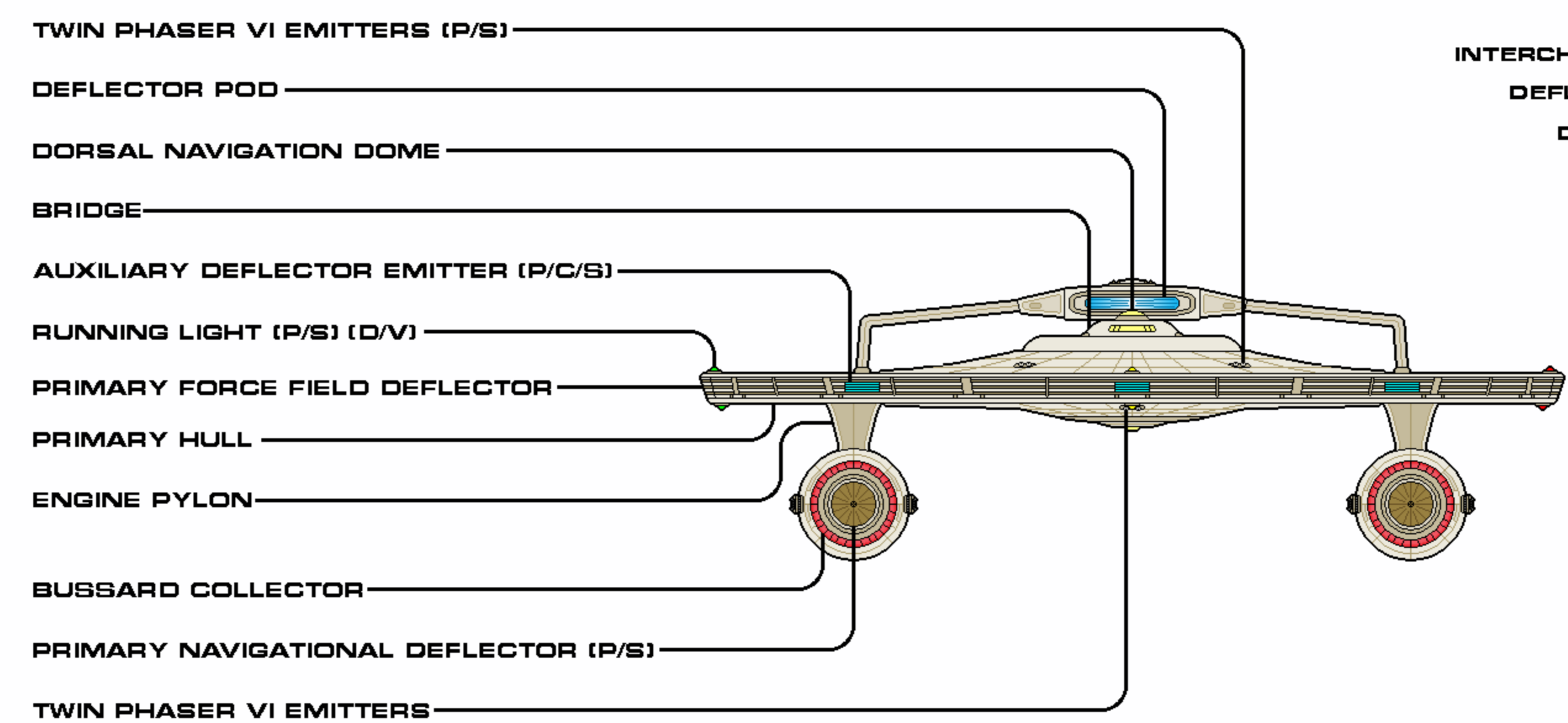
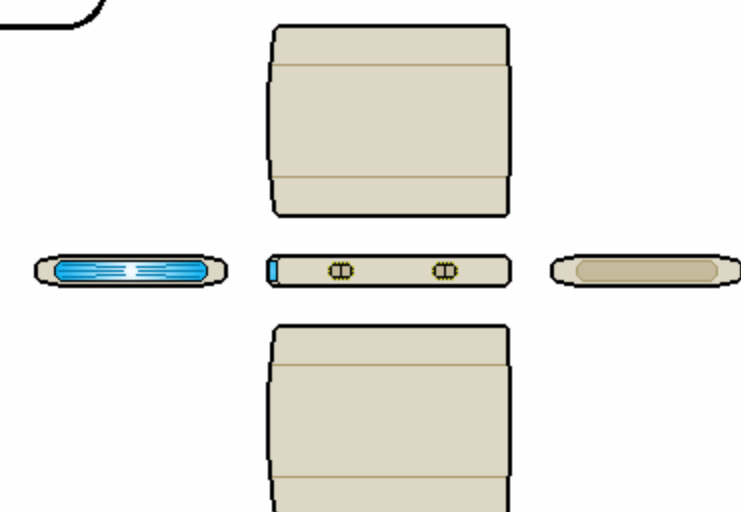
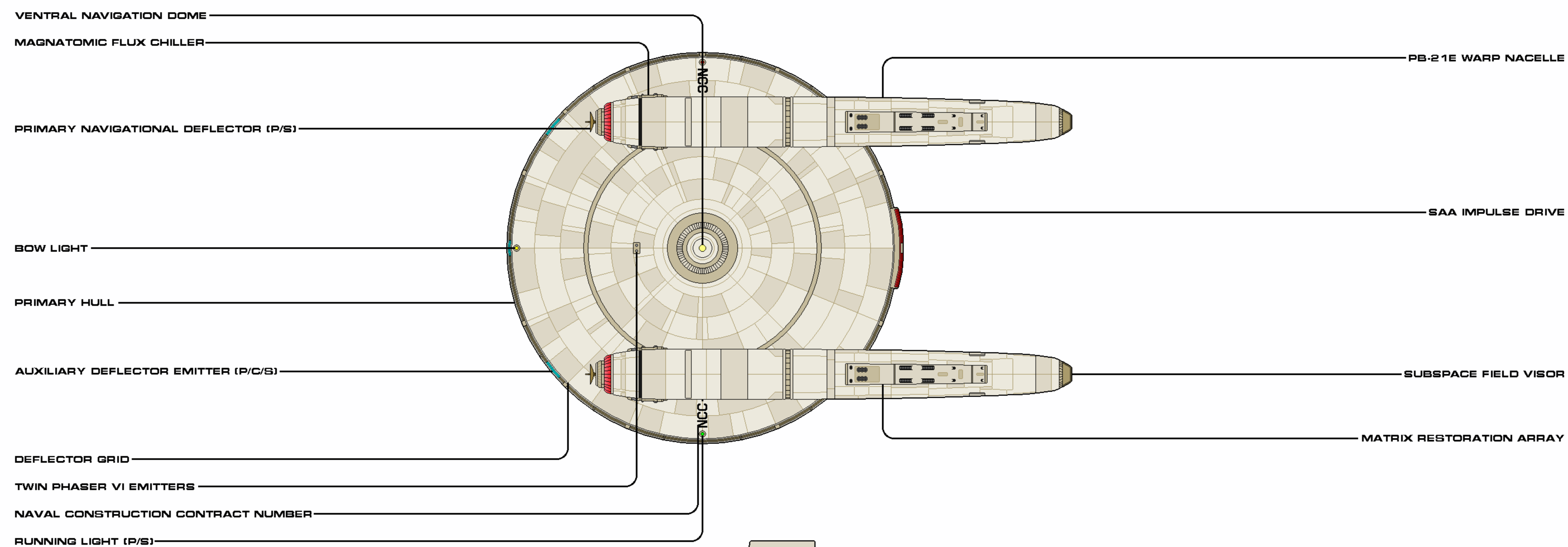

SHEET 2 OF 2

CLASS	BURKE	CATEGORY	NEARSPACE FRIGATE
VARIANT	FLIGHT IV w/ POD	CONSTRUCTED	2252
LENGTH	185.8 M	BEAM	122.0 M
HEIGHT	39.9 M	MASS	322,850 MT
OPERATIONAL	6161	RELEASE DATE	1906.01

Authorized for release by Star Fleet Bureau of Starship Construction

ALDRIN FLIGHT IV

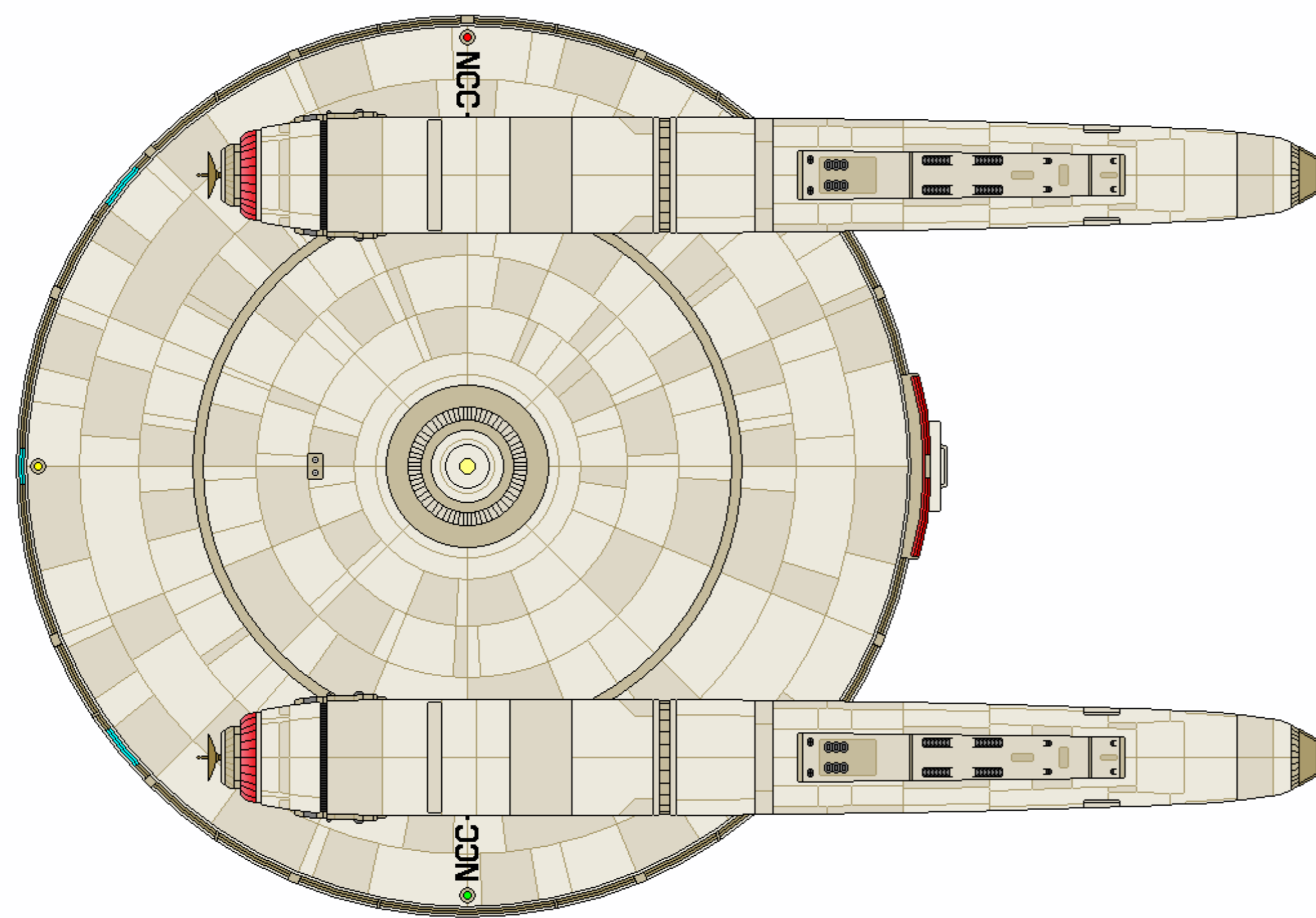
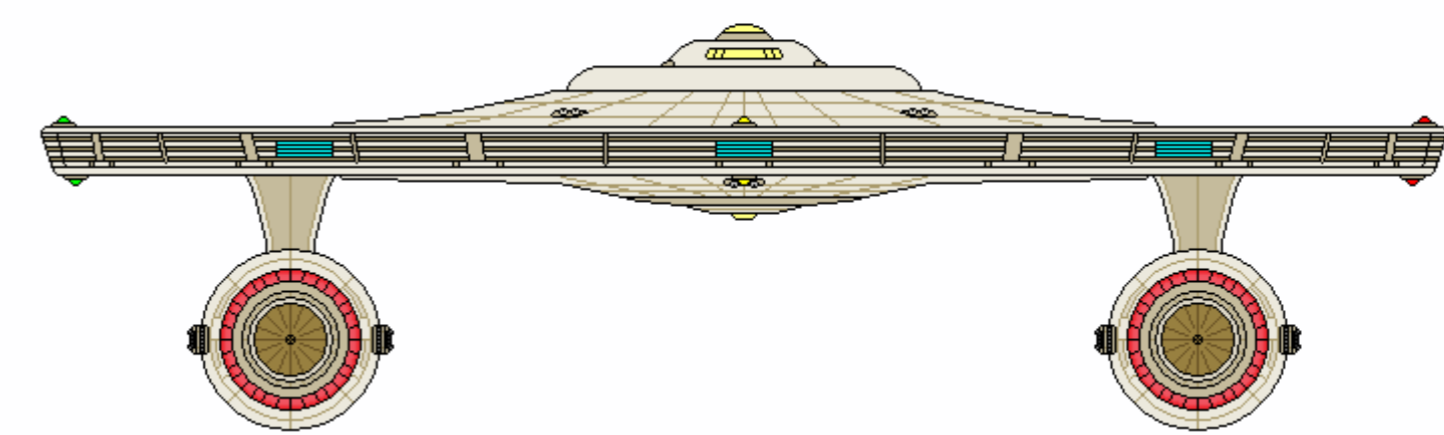
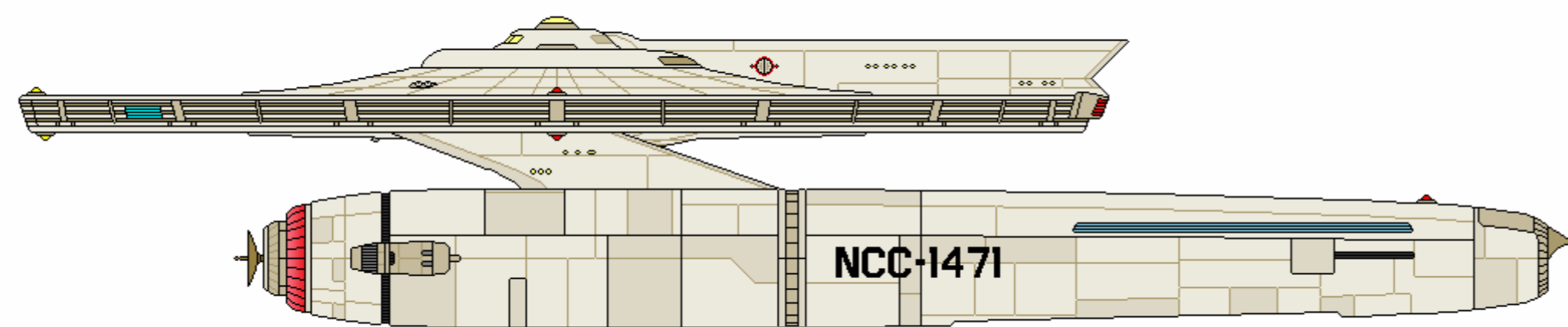
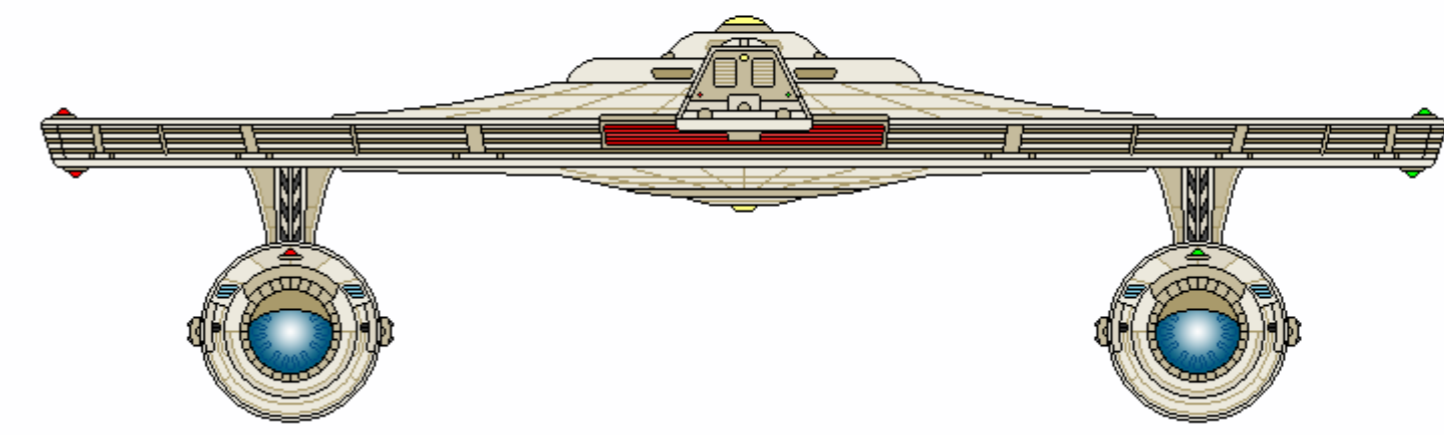
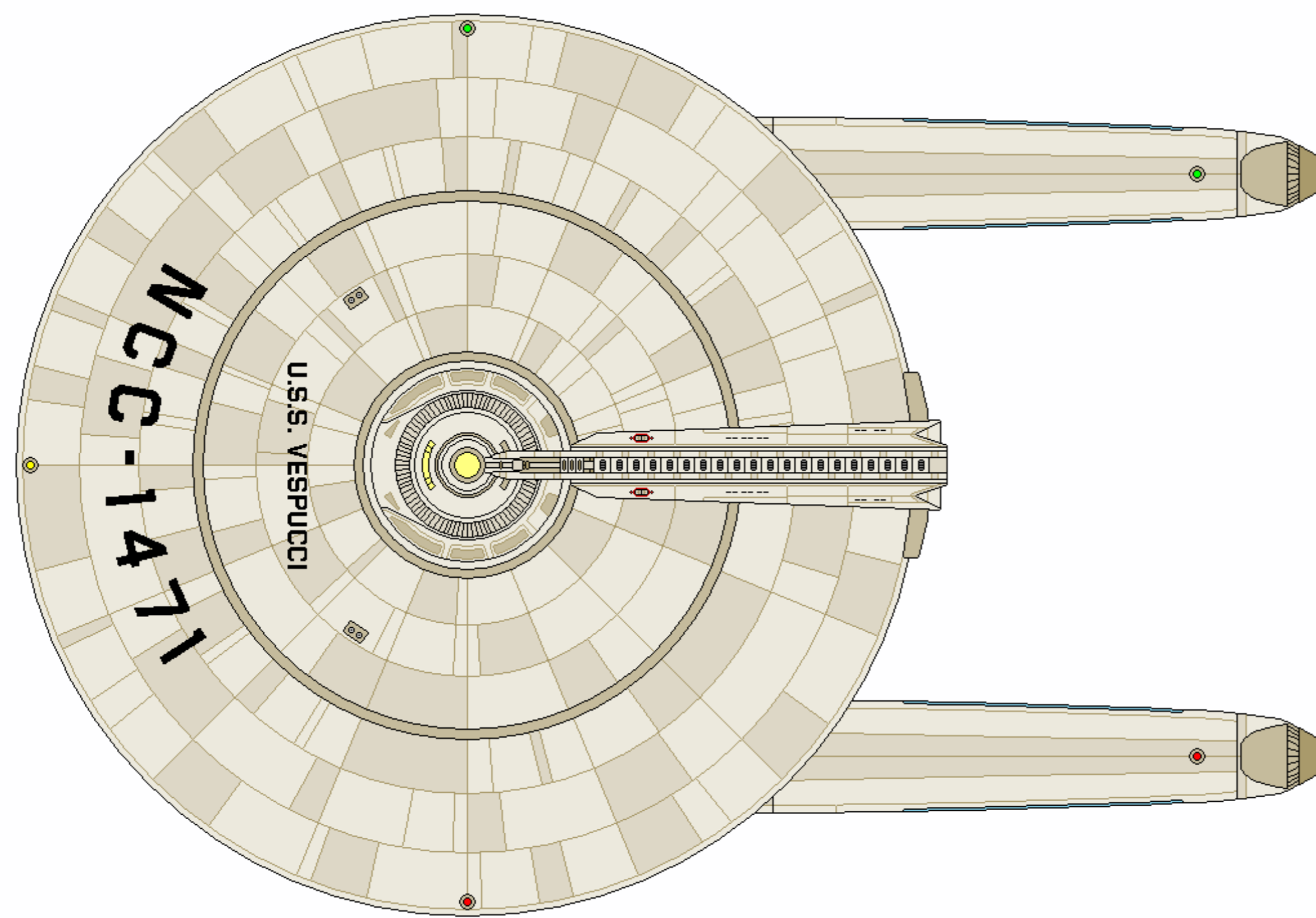

CATEGORY: DEEP SPACE FRIGATE  
 OPERATIONAL: 2252 - 2260  
 MODIFIED: 11 (2252 - 2254)

DIMENSIONS:  
 LENGTH: 185.8 M  
 BEAM: 122.0 M  
 HEIGHT: 35.5 M (36.6 BOOST)  
 MASS: 324,200 MT

TACTICAL:  
 - 6X TYPE VI PHASERS  
 - 2-LAYER CONFORMAL FORCEFIELD  
 - 2X PRIMARY NAVIGATIONAL DEFLECTORS  
 - 3X AUXILIARY DEFLECTOR EMITTERS  
 - OPTIONAL: BOOSTER POD

PERFORMANCE:  
 CRUISE: WARP 4 (OCU)  
 MAX: WARP 6.5 (OCU)  
 ENDURANCE: 3 YEARS

COMPLEMENT:  
 OFFICERS: 25  
 ENLISTED: 214

AUXILIARIES:  
 - 4X WORK PODS





## ALDRIN FLIGHT IV AUTHORIZED CONSTRUCTION

THE FOLLOWING SHIPS OF THE ABOVE CLASS WERE AUTHORIZED AS PART OF THE FEDERATION STAR FLEET BY FEDERATION COUNCIL APPROPRIATION.

USS IRWIN	NCC-1452	USS ZHANG	NCC-1465
USS BEAN	NCC-1455	USS SHACKLETON	NCC-1466
USS DUKE	NCC-1457	USS CHRETIEN	NCC-1467
USS FEI	NCC-1458	USS JAHN	NCC-1470
USS ZHENG HE	NCC-1459	USS VESPUCCI	NCC-1471
USS HADFIELD	NCC-1460		

### GENERAL INFORMATION

The Burkes and Aldrins saw their beam weaponry armament halved with the replacement of the plasma and particle cannons by the three twin-bank phaser emitters during the refit beginning in 2252, from Flight II to Flight IV status. Commanding officers were not reticent to undergo this conversion, for phaser technology was well-touted by the skippers of other ships of the line. Other than this undeniable improvement of firepower, the subclass continued on its mission of exploration and diplomacy within the Federation's "mid-space" regions, until the last was de-commissioned in the mid-2260s.

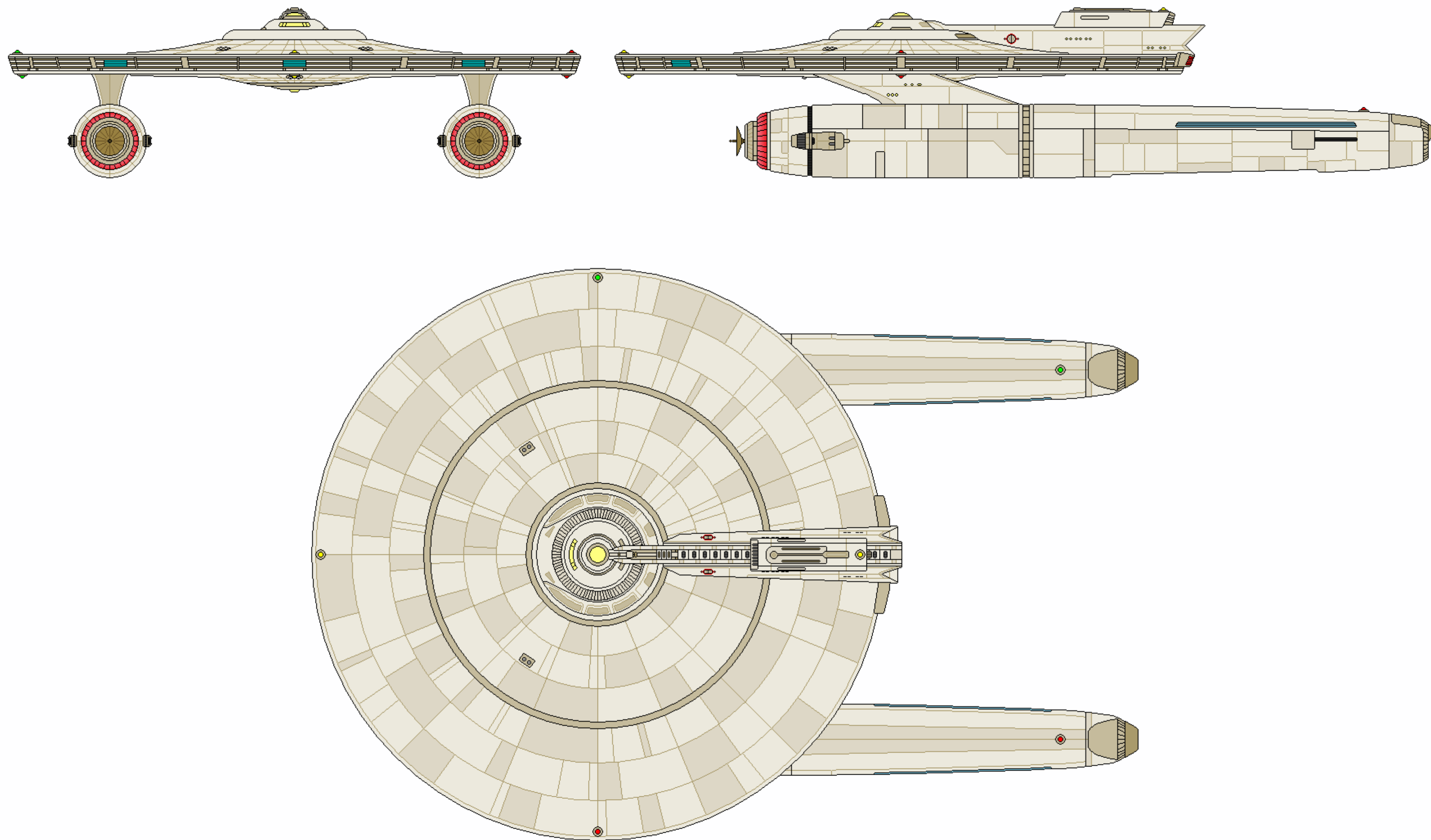

ALDRIN FLIGHT IV  
WITH BOOSTER POD



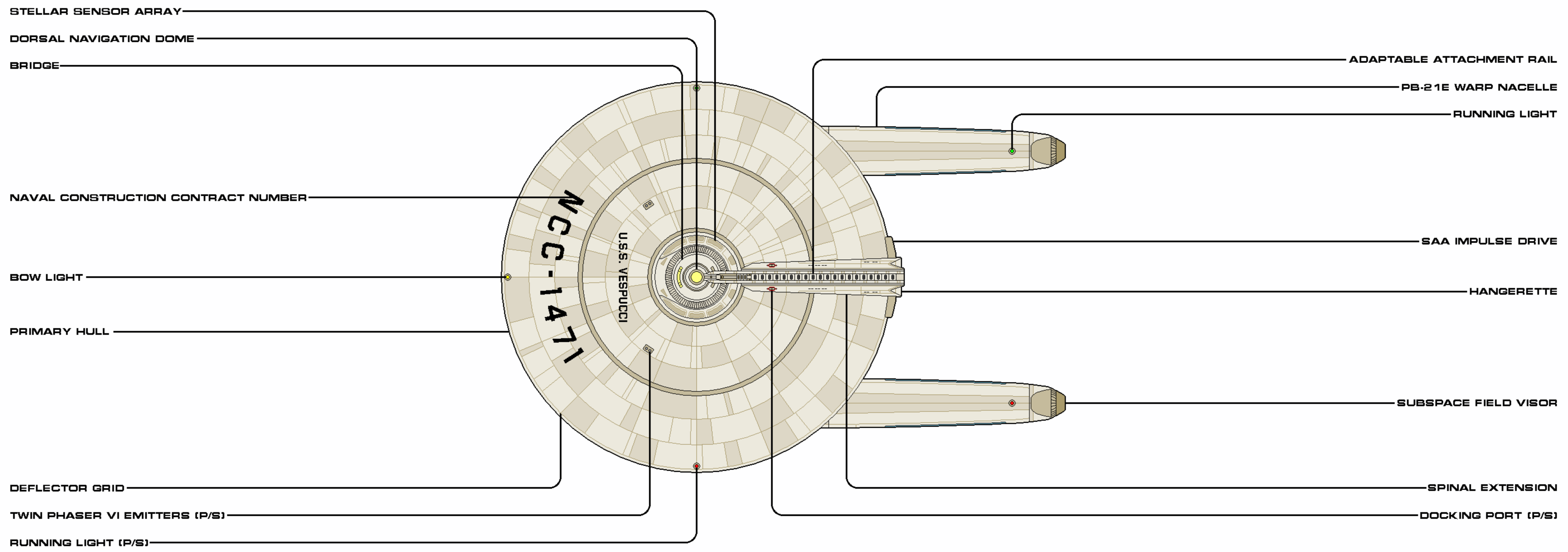
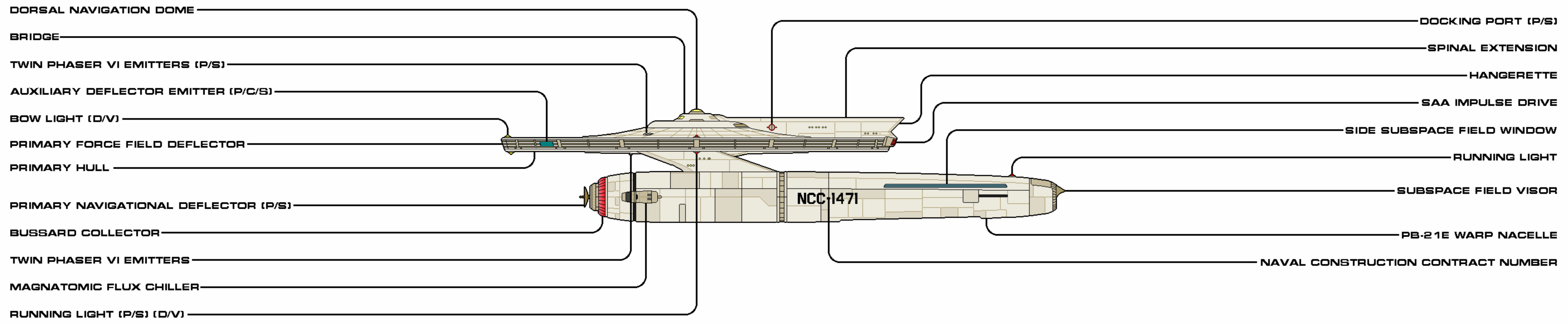

SHEET 1 OF 2

CLASS	BURKE	CATEGORY	DEEP SPACE FRIGATE
VARIANT	ALDRIN FLIGHT IV	CONSTRUCTED	2252
LENGTH	125.8 M	BEAM	122.0 M
HEIGHT	35.5 M	MASS	324,200 MT
OPERATIONAL	12/01	RELEASE DATE	1906.01

Authorized for release by Star Fleet Bureau of Starship Construction

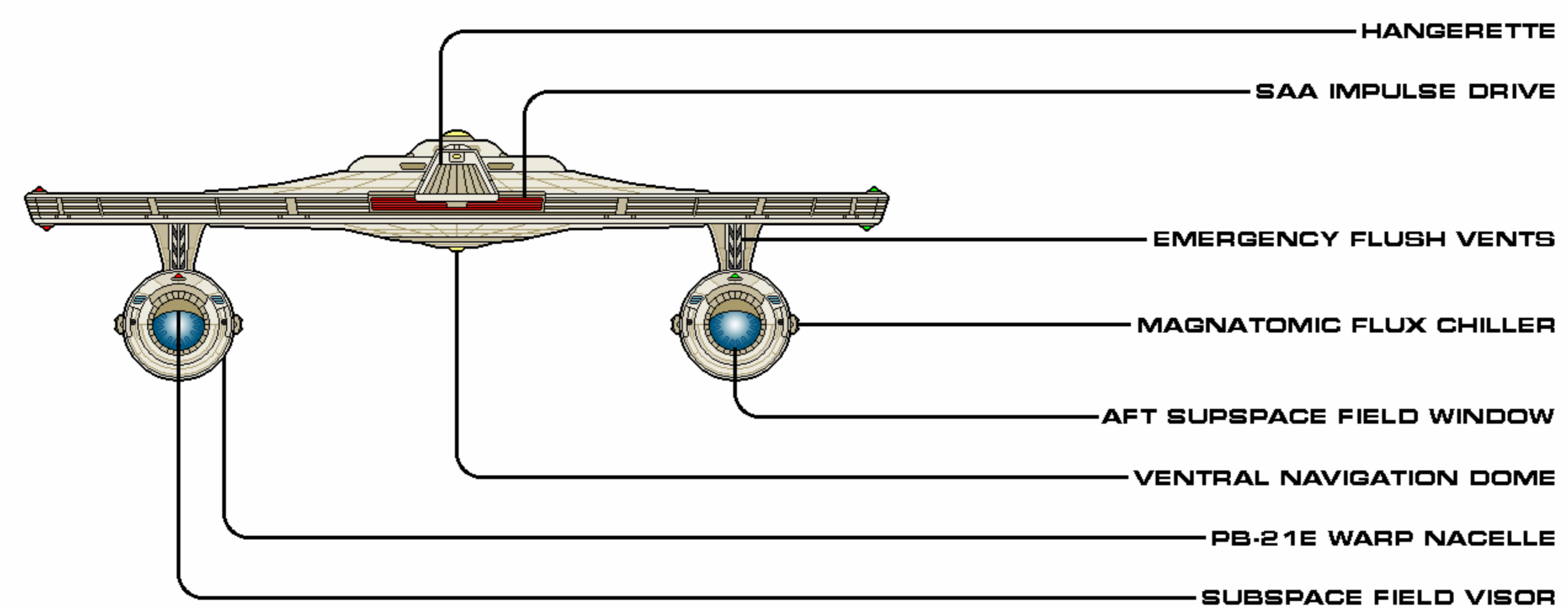
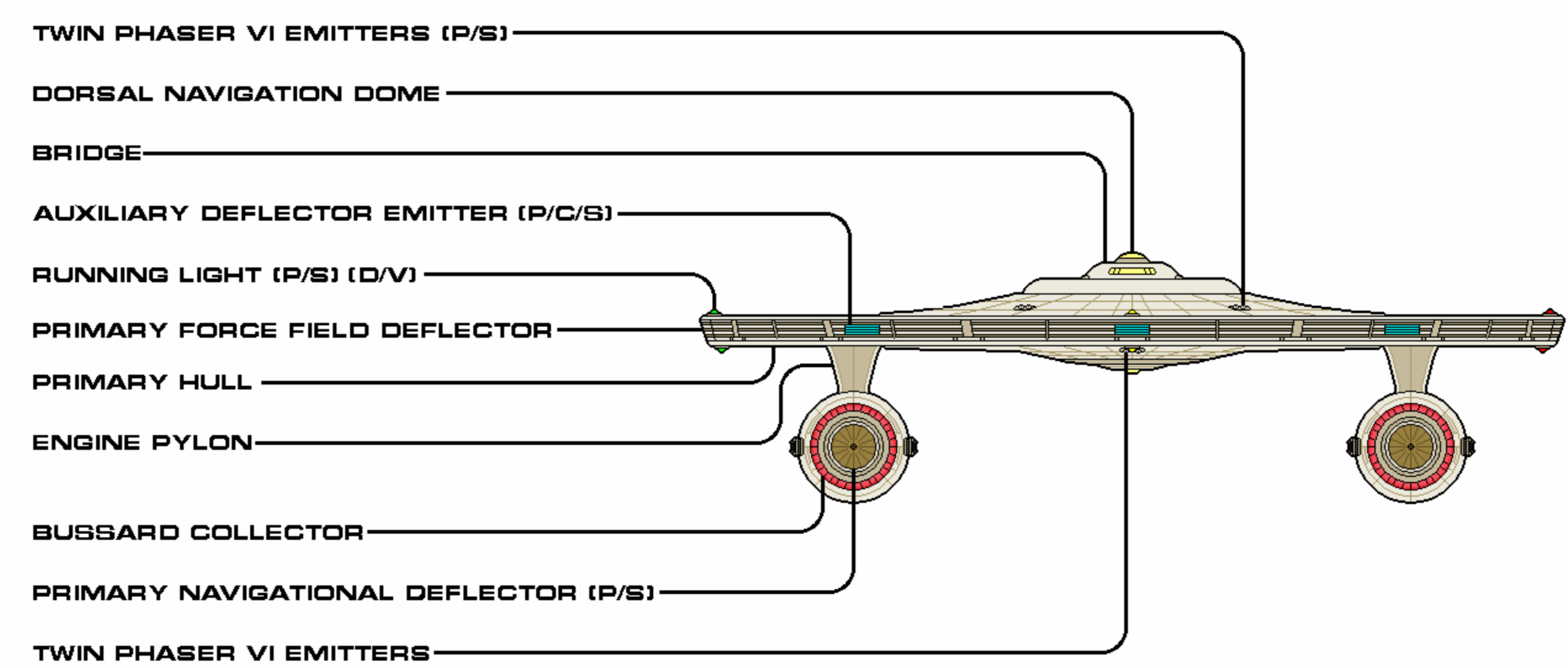
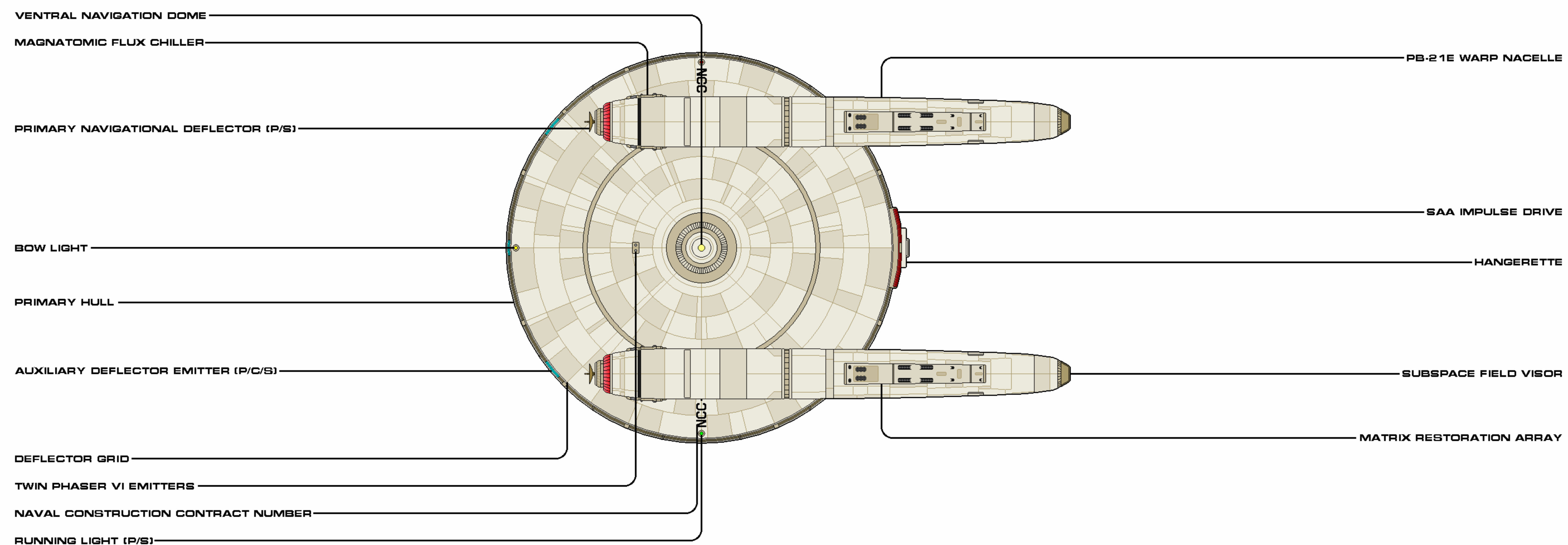

SHEET 2 OF 2

CLASS	BURKE	CATEGORY	DEEP SPACE FRIGATE
VARIANT	ALDRIN FLIGHT IV	CONSTRUCTED	2252
LENGTH	185.8 M	BEAM	122.0 M
HEIGHT	35.5 M	MASS	324,200 MT
OPERATIONAL	12/61	RELEASE DATE	1906.01

Authorized for release by Star Fleet Bureau of Starship Construction

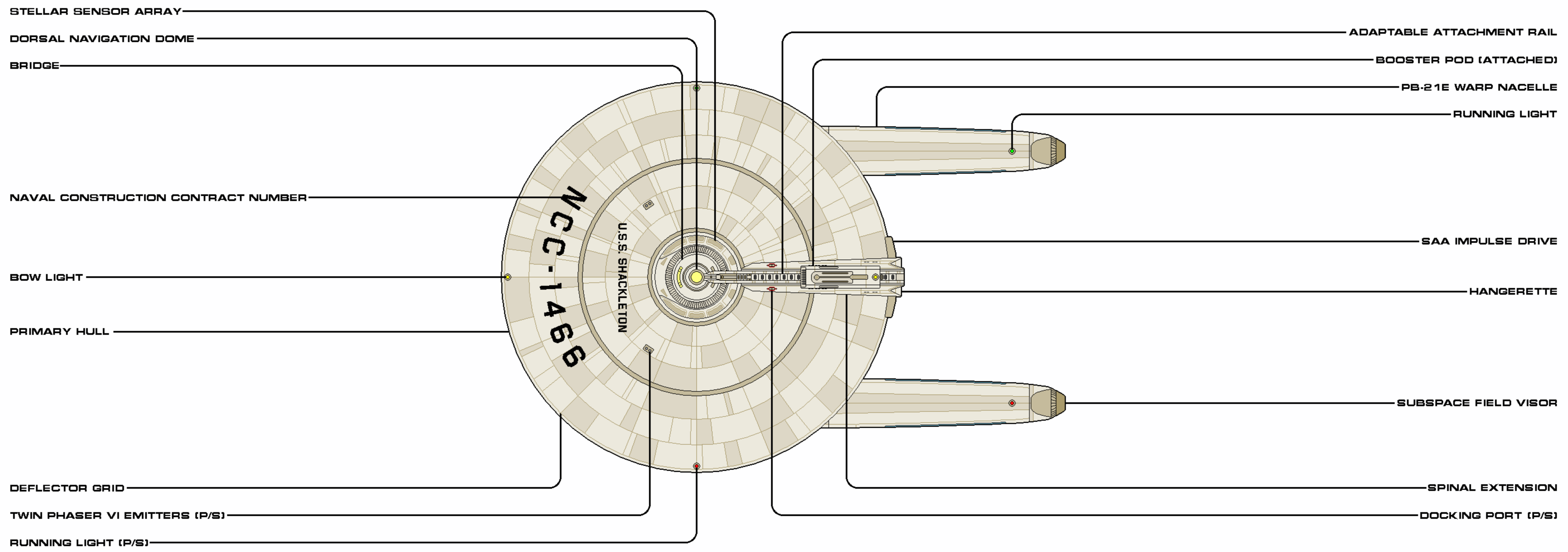
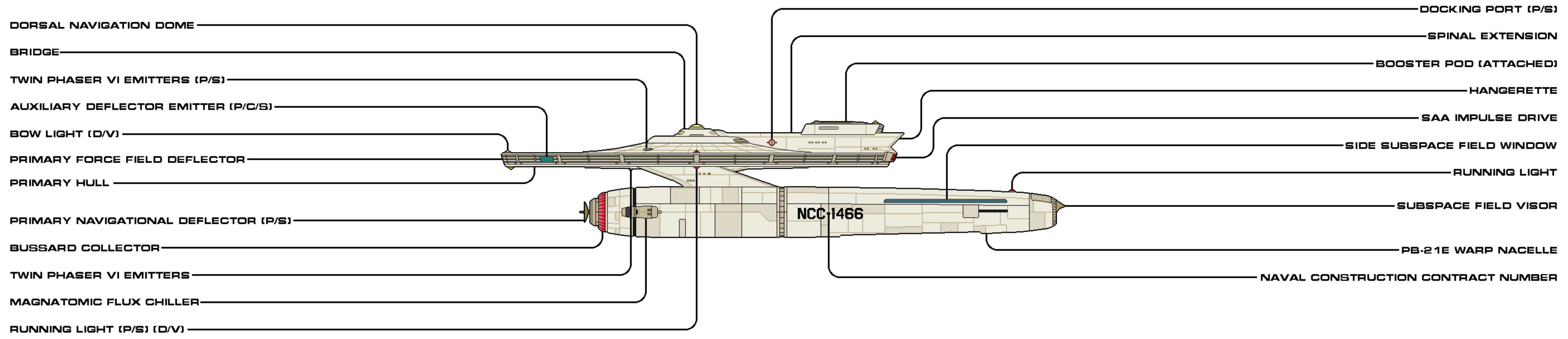

SHEET 1 OF 2

CLASS	BURKE	CATEGORY	DEEP SPACE FRIGATE
VARIANT	ALDRIN FLT IV W/ POD	CONSTRUCTED	2252
LENGTH	185.8 M	BEAM	122.0 M
HEIGHT	36.6 M	MASS	332,250 MT
OPERATIONAL	12/01	RELEASE DATE	1906.01

Authorized for release by Star Fleet Bureau of Starship Construction



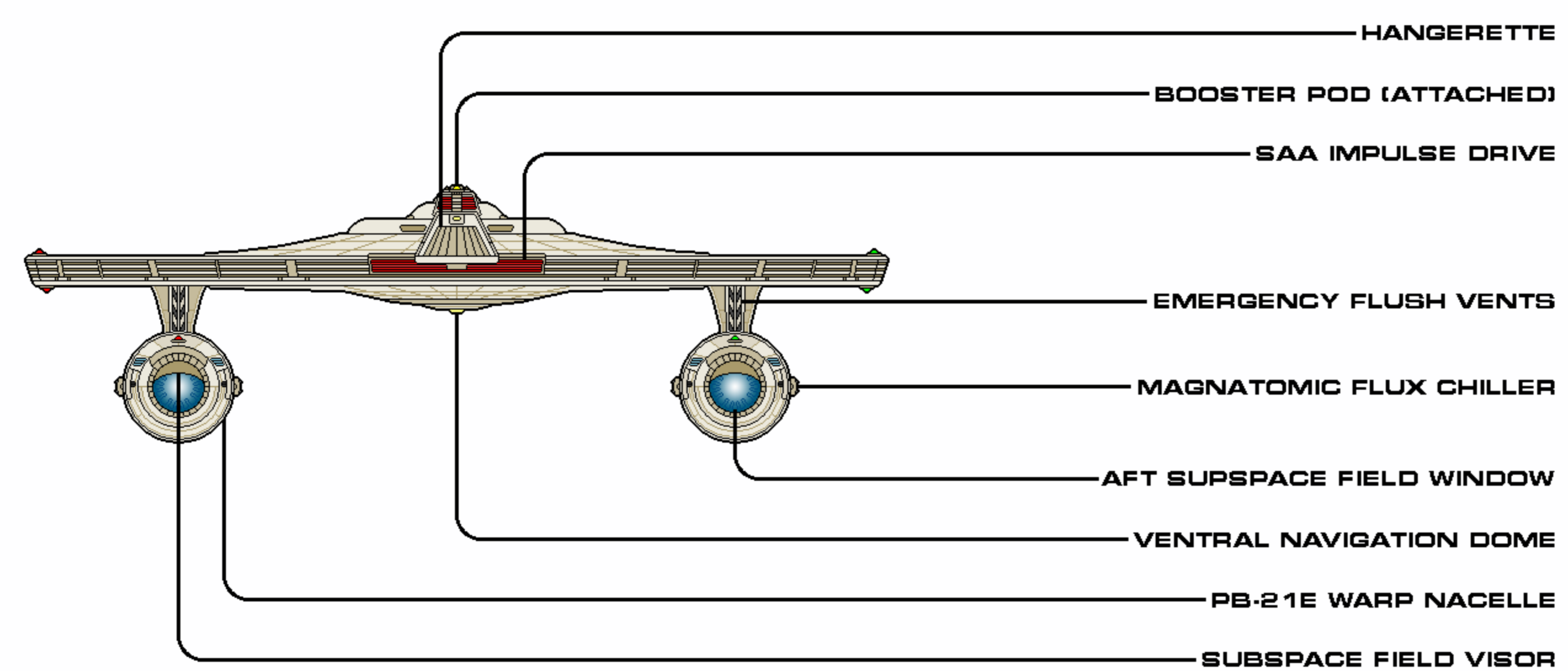
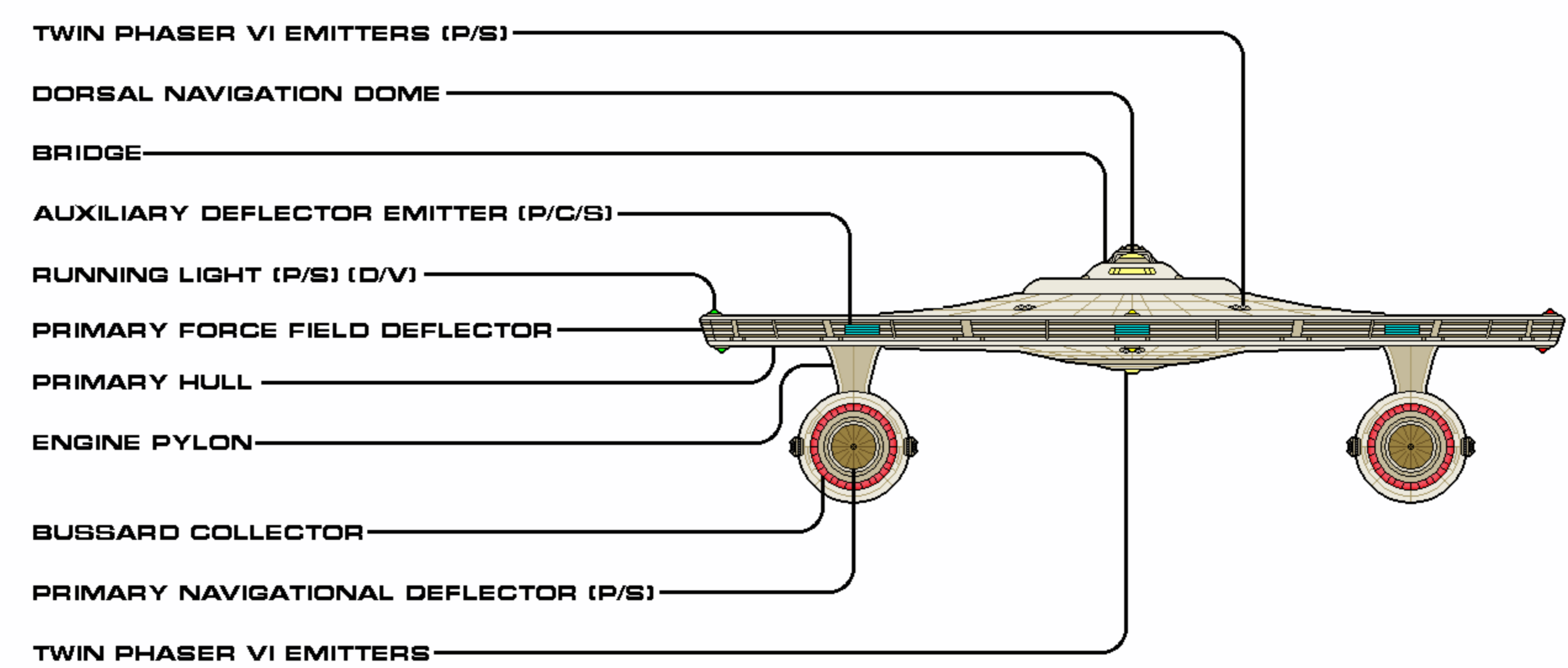
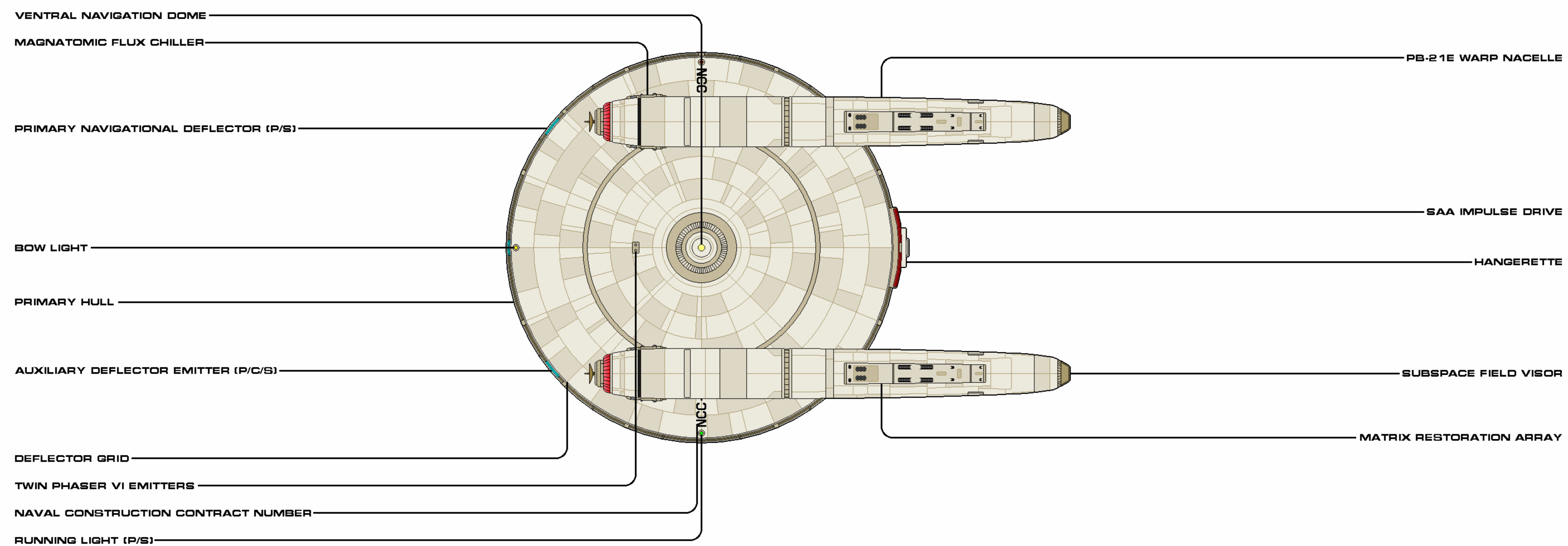

SHEET 2 OF 2

CLASS	BURKE	CATEGORY	DEEP SPACE FRIGATE
VARIANT	ALDRIN FLT IV w/ POD	CONSTRUCTED	2252
LENGTH	185.8 M	BEAM	122.0 M
HEIGHT	36.6 M	MASS	332,250 MT
OPERATIONAL	12/67	RELEASE DATE	1906.01

Authorized for release by Star Fleet Bureau of Starship Construction





## CLASS TIMELINE

2219

Texas class light cruiser USS Oklahoma (NCC-945) engages marauders intent on pillaging the settlements on Agnihotra.

The evacuation of 10 million inhabitants of Bayard's Planet is completed.

USS Enderbury (NCC-480, Kovaris subclass) is effectively destroyed when a defective pulse wave warhead (Vulcan technology) detonates right after leaving the launcher. The explosion rips open the pressure hull of the destroyer and kills most of the test crew immediately; radiation takes a further death toll.

Paradise planet Hydra II in Sector 16c is discovered by USS Poseidon (Mann class).

The Burke class patrol ship contract is awarded to Geering.

USS Constellation (NCC-1017, Advance subclass) suffers major battle damage to her bow structures.

2221

The (now) uninhabited Bayard's Planet is fully irradiated by the effects of the 2165 Phi Puma nova.

An expeditionary reinforcement flotilla, consisting of eight Kovarises class phase destroyers, two scouts of the Apache subclass and a single cruiser-tender of the Texas class, visits Rigel V.

The Burke class nearspace frigate enters service with Star Fleet.

USS Burke (NCC-1600) begins class trials.

Star Fleet gives the go-ahead for a Mark II version of the Burke, designated as the Aldrin subclass deep space frigate, starting with hulls already under construction.

USS Arecibo (NCC-i365, Lowell class scout) is lost to a puzzling Klingon attack above Sarthong V, a planet of scant strategic but noted archaeological significance.

On a patrol mission out of the Rigel II Fleet outpost, USS Nestor (NCC-i211, Bloodhound subclass corvette) witnesses a rendezvous between a Rigelian transport convoy and a Klingon destroyer, revealing the trade relations between the governments.

2222

USS Targa (NCC-467, Kovaris subclass) manages to disperse a magnetic storm threatening Balaka III by using her experimental pulse wave warheads - a Vulcan technology.

The Aldrin subclass deep space frigate enters service with Star Fleet.

Following two years of iterative design effort, Chiokis manages to make significant progress on connecting the two hulls of the future heavy cruiser.

2223

In a pyrrhic victory, USS Akula (NCC-275), a Placido class scout, is lost following combat against Klingons at the Battle of Arquin Pillar, as are the Kwajalein (NCC-406, Trent class) and Jacoubet (NCC-479, Kovaris subclass). The battle also marked the first of massed sublight fightercraft by a Star Fleet task force, to a dismal failure. Two of the nine Trents deployed to the region fell out and did not make the engagement.

USS Audace (Caracal class) falls victim to unknown enemies - most likely prey to Klingon disruptor cannon. The disappearance of the Audace was only noticed months after the fact; no flight recorder marker was found.

A Federation-flagged mining ship, Castro, is destroyed in the Sussmen-MacFarlane system's asteroid belt by a Klingon D5.

In response to the destruction of the Castro, the UFP levies sanctions against the Klingon Empire and establishes mandatory trade treaty reviews with all non-UFP states that also do business with the Klingons.

USS Vasco da Gama (NCC-1472, Aldrin subclass) is commissioned.

The UFP extends membership to Denobula Triaxa.

2225

The final Aldrin subclass deep space frigate, USS Kotov (NCC-1473) is built.

The Osceola disaster costs the lives of 277 colonists when a brief stasis synchronization fails.

2226

The final Burke subclass nearspace frigate, USS Artful (NCC-1642), is built.

USS Moscow (NCC-1423, Baton Rouge class) becomes the first ship to transmit and USS Tehran (NCC-1419, Baton Rouge class) the first one to receive a living human being intact through a warp-to-warp transport - an impressive achievement considering that only fifteen years earlier, the very concept had been deemed impossible by the Vulcan science council.

Geering presents Star Fleet with both a fast and an independent cruiser variant of the basic Burke design.

2235

The first of the Burke and Aldrin subclass frigates start receiving the weapons system upgrade to Flight II status.

Test runs of the Constellation and Republic prototype conversions prove the Horizon hull configuration is usable, with a slight altering of engine placement, for the Project Starship design.



## CLASS TIMELINE

2237

Altair, Izar, and Melev, and numerous fringe worlds, begin discussions of forming non-Federation 'defense zones' inside the Federation.

The final Burke and Aldrin subclass frigates receive a weapons system upgrade to Flight II status.

Councilman Saldran of Rigel IV leads a campaign of Star Fleet black-painting and doomsday predictions.

2244

The PB-45 nacelle is identified as a replacement for the PB-21 on the Burke series frigates.

The first of eight Aldrin subclass deep space frigates are refit to Magellan subclass scout cruiser standards.

Ships of both Burke and Aldrin subclass receive modernization refits from Chiokis (though about 13 Burkes will not be refit before the program is canceled).

2245

USS Troy (NCC-423) and USS Hellas (NCC-426), both Siva subclass destroyers, succumb to Klingon forces at Delta Leonis.

The last of eight Aldrin subclass deep space frigates are refit to Magellan subclass scout cruiser standards.

Pre-comm Ares (NCC-602, Monoceros class) is damaged beyond salvage during the final construction phase, in what appears to be an accident.

This year's defense review seals the fate of numerous pre-dilithium ship types.

USS Enterprise (NCC-1701, Constitution class) is commissioned, with program manager CAPT Robert April in command. USS Constitution (NCC-1700) is commissioned shortly after.

USS Republic (NCC-1371) and USS Constellation, both now Constitution class, are re-commissioned.

Final Battle of Axanar, where the "battered" USS Constitution and three of her "half-finished" sisters are moved to the forward repair base in orbit of the planet as a lure.

2250

Five command variant Caracal class ships (Palomar, Long Beach, Tayi, Dominion, and Rsah-dan) are re-activated (from the reserves) to make up for a shortfall in second-tier cruiser numbers.

USS Sindbad (NCC-1823, Sawyer class light scout) has the distinct honor of carrying President Varis to Axanar for the signing of the rehabilitation treaty; Axanar rejoins the Federation.

USS Vasco da Gama (NCC-1472, Aldrin subclass) is lost in an engagement with the Klingons.

The series of aggressive incidents by Klingons begun in 2246 concludes.

2252

Vulcans discover Zebulon Carter's journal on the planet, and return it to the United Earth government.

The United Federation of Planets makes first contact with Bolarus IX.

The Burkes & Aldrins start receiving a weapons system upgrade.

2254

The colony world of Prairie is attacked by Klingon forces.

The final Burke & Aldrin Flight II frigates receive the weapons system upgrade to Flight IV status.

USS Ulysses (NCC-1814, Sawyer class light scout) proves that the Klingon threat has not receded by stumbling onto an extensive attempt to influence prime directive-protected planets inside Federation territory.

USS Brazzaville and USS Providence, both Nelson class, are lost to Tholian-associated forces in separate incidents.

2257

The first of the Burke & Aldrin subclass frigates and Magellan scout cruisers start receiving transporter system upgrades.

USS Byrd (first of her class), on the return leg of her 25-year voyage, re-enters communications range.

2259

The last of the Burke & Aldrin subclass frigates and Magellan scout cruisers receive a transporter system upgrade.

USS Iblis (NCC-528, Siva Flight II) hits the battle cruiser USS Newton (NCC-3822, Proxima class) with her navigational deflector, killing 23 aboard the latter ship.

USS Byrd (first of her class) returns to New Aberdeen upon the conclusion of 25-year galactic survey voyage and enters a 2-year overhaul period.

USS Dauntless (NCC-1697, Pyotr Velikiy support cruiser) is badly damaged in combat at Xarant, retires to Starbase 7 for repairs.

2260

USS Texas (NCC-1900, Texas Flight II) defeats a Klingon D6 cruiser at Iota Eridani.

Klingon ships begin a series of frequent raids into UFP territory.

The United Federation of Planets rejects the membership bid by Bolarus IX, claiming the Bolians remain unstable. A world government





## CLASS TIMELINE

would have to survive the coming of a new generation for the Bolians to prove their commitment to world peace.

Altair rejoins the UFP

USS Smith (Byrd class galactic survey cruiser) returns a bit early from her 25-year voyage.

The President of the United Federation of Planets is selected-for the first time-by general election.

The final Burke and Aldrin Flight IV frigates are decommissioned.

2267

A cessation of hostilities with the Klingons is mandated by the Organians.

The Altair systems inaugurates a new president, which helps stabilize the region.

The final Burke and Aldrin Flight III frigates are decommissioned.

The final Magellan class scout cruiser is decommissioned.

Sixteen pirate attacks are connected to Orion activity all along the crucial Rigel shipping lane, and several dozen more are suspected of having been committed by Orions.

USS Niantic (NCC-1105, Miramar class) is lost in action on the hunting grounds of an alien planet-eating device.

USS Constellation (NCC-1017, Constitution class) is sacrificed, in order to destroy the Doomsday Machine.

The logistics of supporting the anti-piracy efforts becomes extremely difficult.

## STARSHIP COMPARISON GUIDE

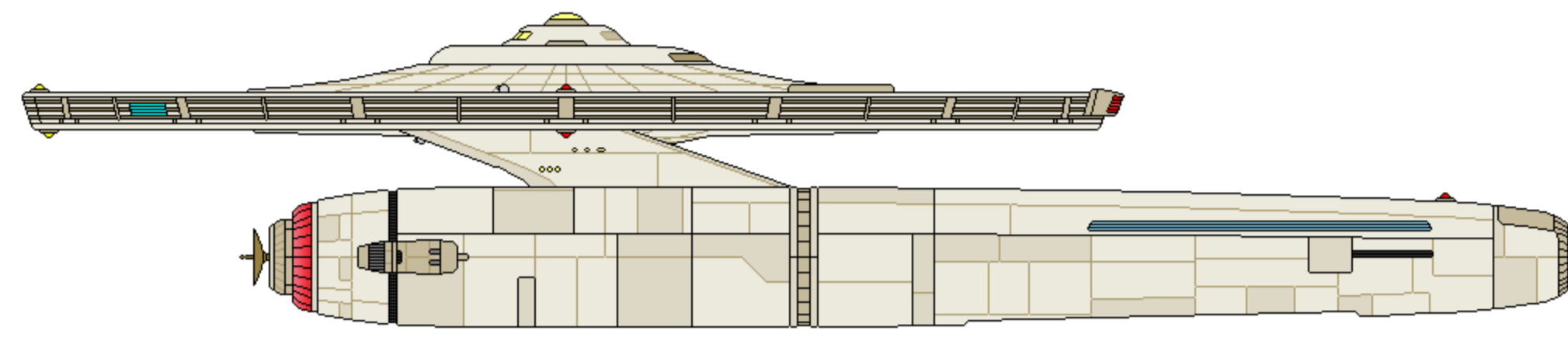

BURKE  
NEAR SPACE FRIGATE

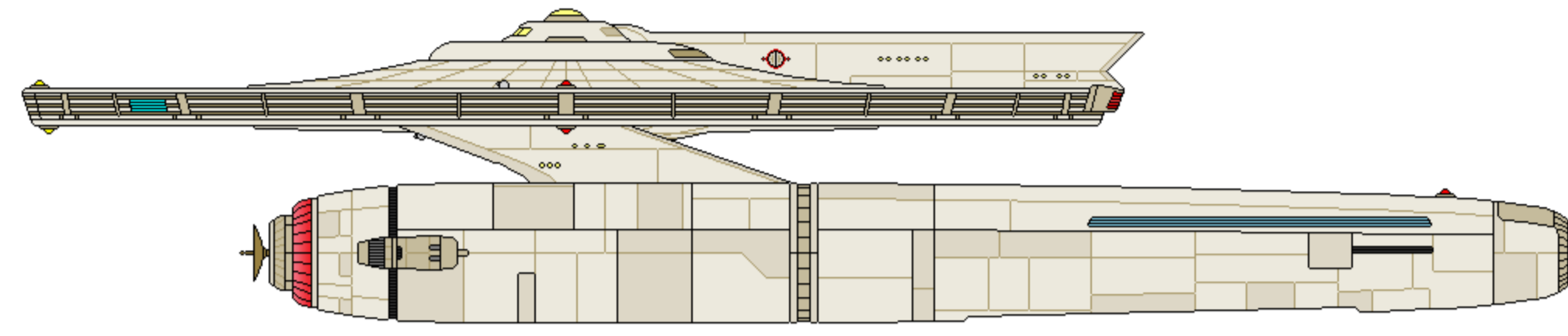

ALDRIN  
DEEPSPACE FRIGATE

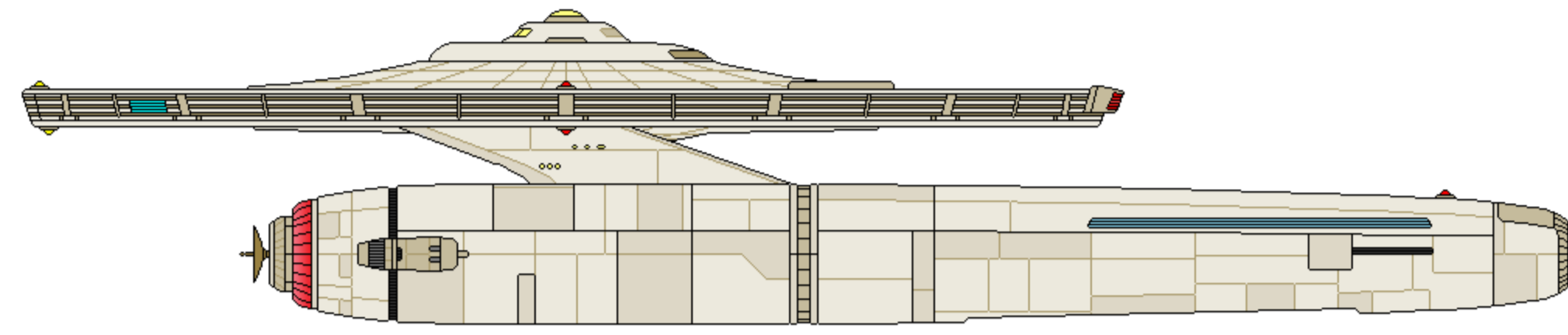

BURKE FLIGHT II  
NEAR SPACE FRIGATE

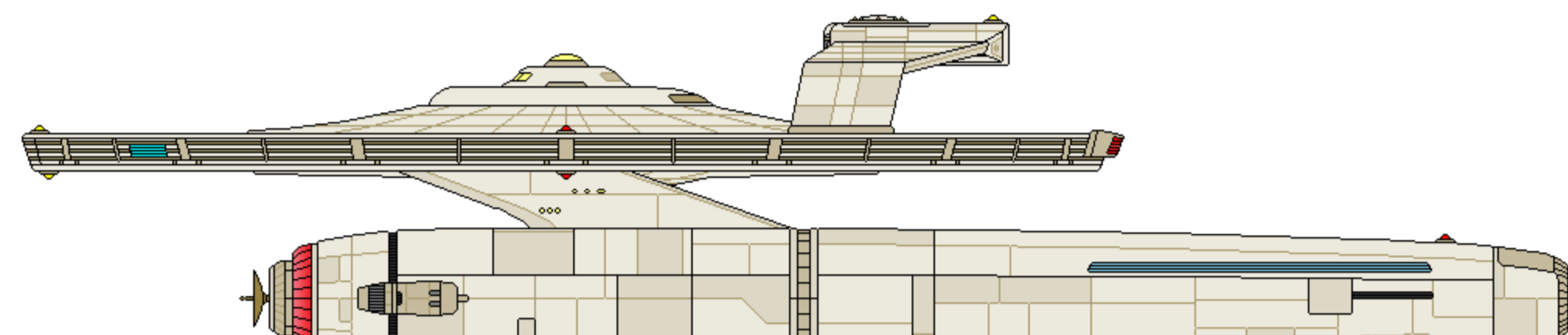

BURKE FLIGHT II  
W/ MODULAR POD

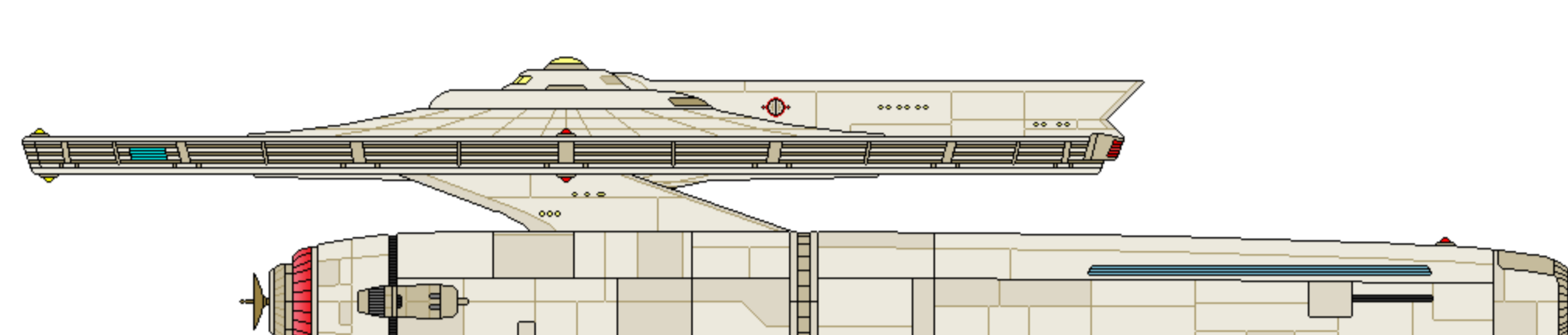

ALDRIN FLIGHT II  
DEEPSPACE FRIGATE

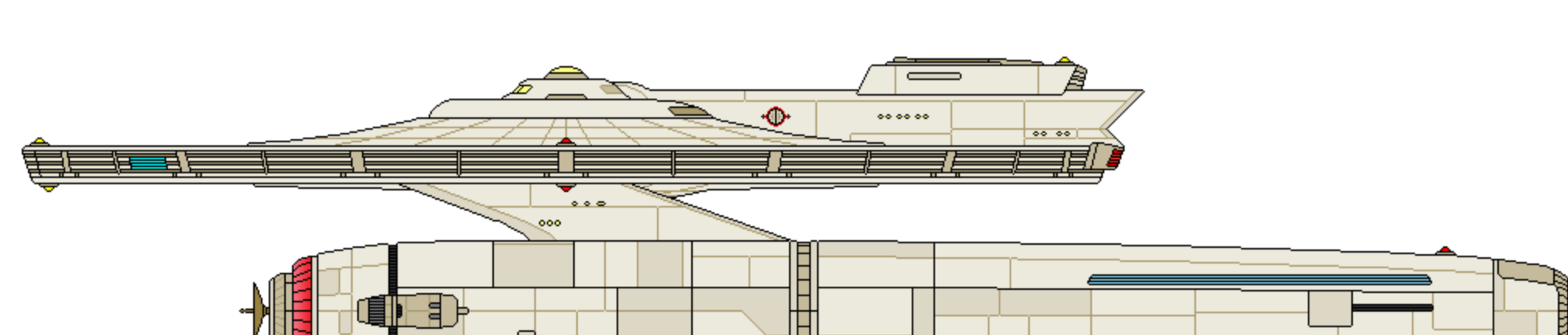

ALDRIN FLIGHT II  
W/ BOOSTER POD

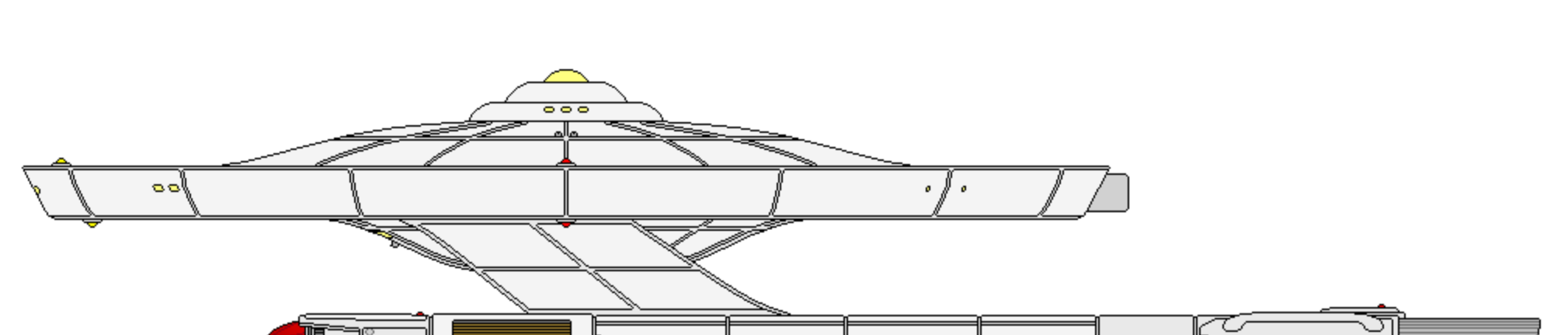

BURKE FLIGHT III  
NEARSPACE FRIGATE

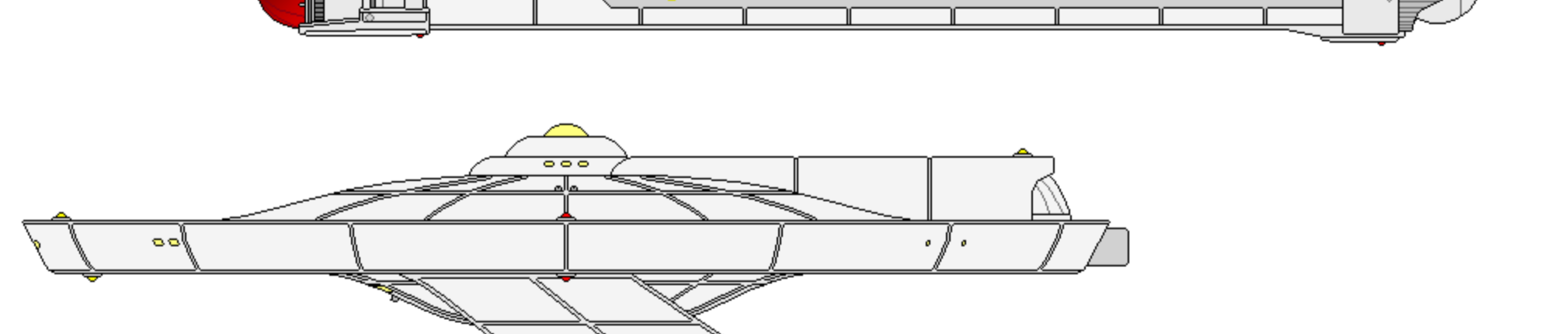

ALDRIN FLIGHT III  
DEEPSPACE FRIGATE

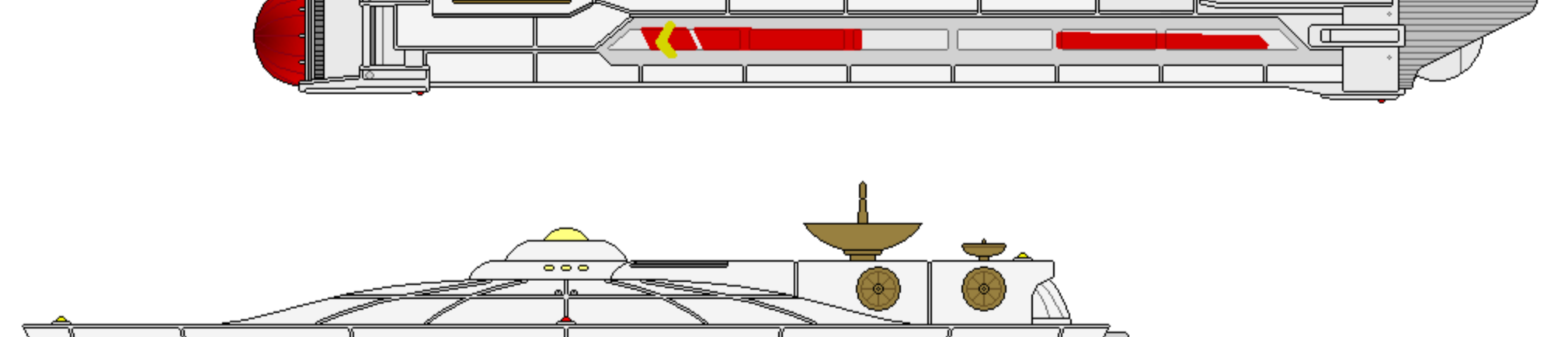

MAGELLAN  
SCOUT CRUISER

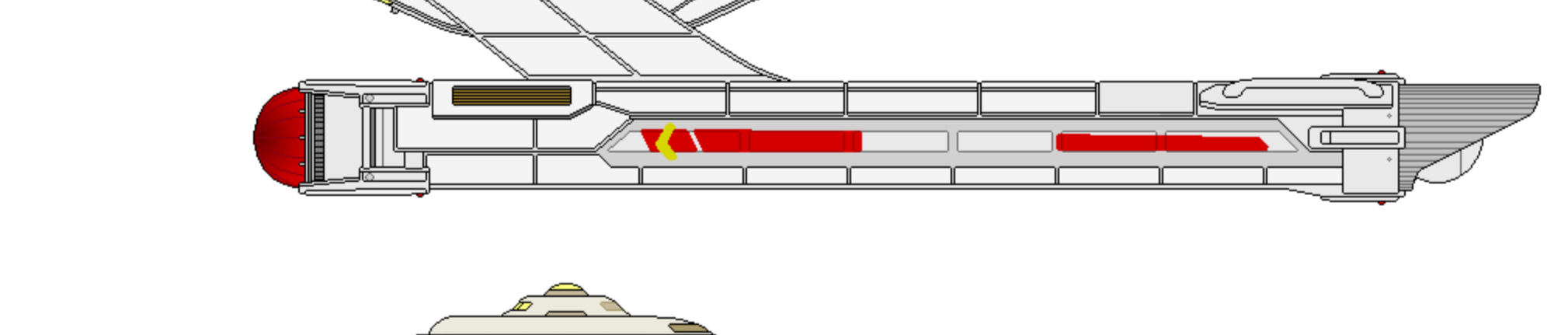

BURKE FLIGHT IV  
NEARSPACE FRIGATE

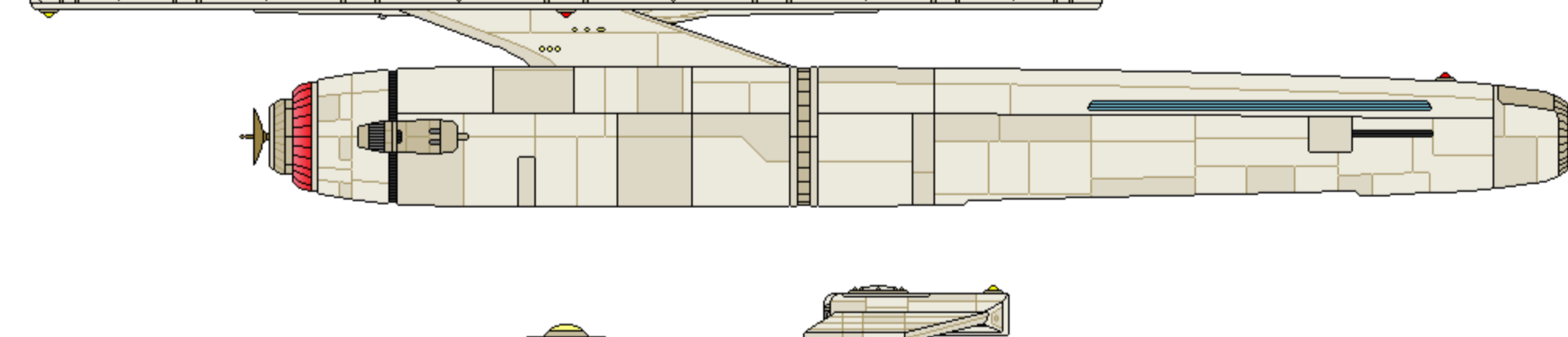

BURKE FLIGHT IV  
W/ MODULAR POD

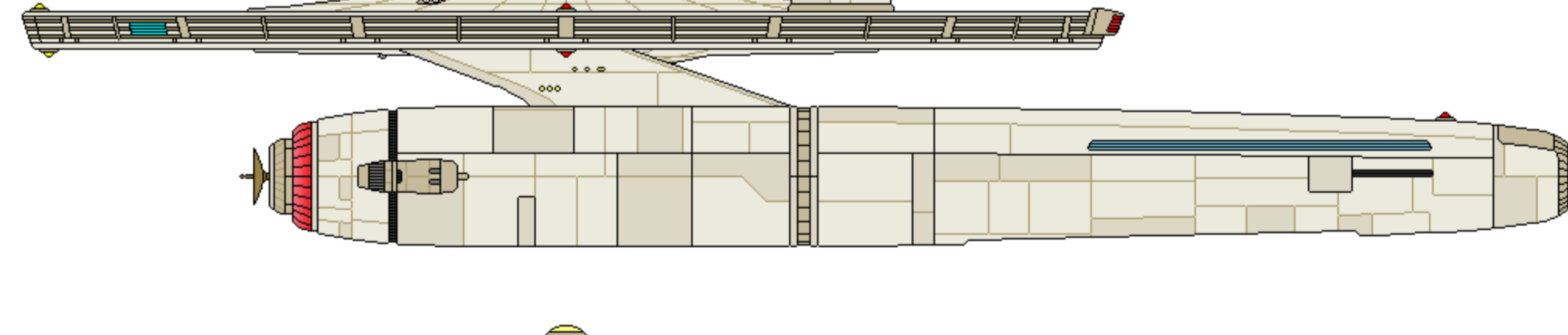

ALDRIN FLIGHT IV  
DEEP SPACE FRIGATE



## STARSHIP COMPARISON GUIDE

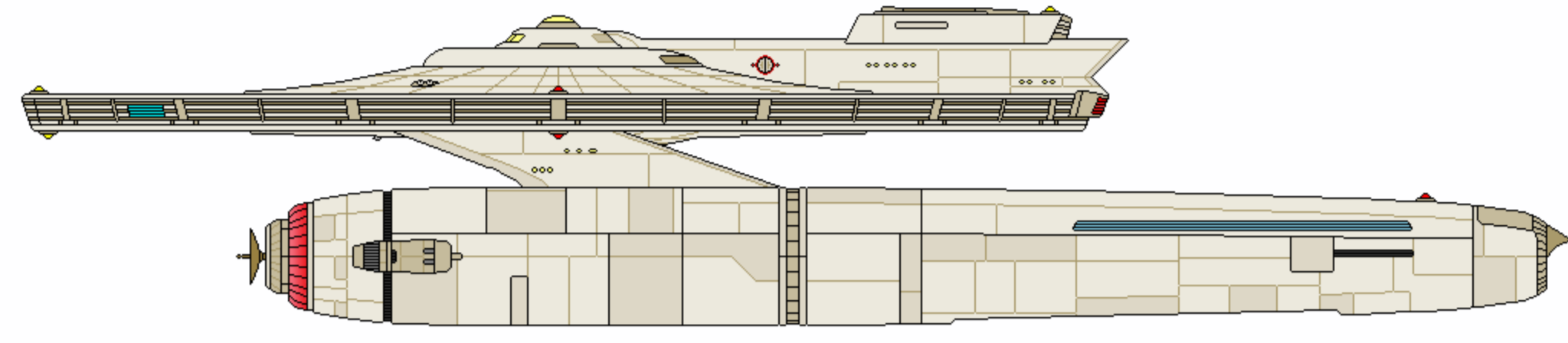

ALDRIN FLIGHT IV  
W/ BOOSTER POD





## GLOSSARY

**Array:** Generally, a combination of identical sensors, weapons, or other equipment operating in conjunction.

**Barge:** one of several differing types of vessels, including 1) a low-warp bulk carrier designed to transport unpackaged bulk cargo; 2) an orbital-to-atmosphere combat lander, usually heavily armored and lightly armed, to transport large troop formations into defended surface areas.

**C/P/S:** Centerline/Port/Starboard (see P/S).

**Class:** a production run of vessels all to identical (or nearly identical) standards. Ex: the Constitution class

**Corvette:** Small warp-capable ship dedicated to local patrol, law enforcement and community service missions. Sometimes landing-capable, not dependent on starbase facilities for support.

**Cruiser:** A medium multi-purpose starship. The largest exploration vessels until the early 24th century, when relegated to other duties with the introduction of large Explorer starships.

**Deep space:** The region near or beyond the recognized borders of the Federation, often uncharted in any considerable detail.

**Destroyer:** A medium offense starship intended for destroying enemy capital ships and installations, as well as conducting fleet escorts.

**ECS:** Earth Cargo Ship, a prefix for vessels flagged under the governing authority of the Earth Cargo Service.

**ELRS:** Extreme Long Range Sensor

**Flight:** A modification to a class of ship intended to be incorporated by most or all members of that class.

**Flitter:** an extremely low-altitude planetary personnel and freight vehicle, utilizing anti-grav hover equipment. Larger vehicles might resemble wheel-less trucks, with the smallest analogues to one- or two-person motorcycles.

**Frigate:** Until the late 22nd century, a dedicated medium defense and escort starship, larger than corvette but smaller than destroyer, often capable of trans-atmospheric operations. In the 23rd century and into the early 24th century, often used to designate defense and escort starships ranging from small patrol and escort ships typically lacking torpedo armament to versatile multipurpose ships similar to light cruisers.

**FTL:** abbreviation for Faster Than Light.

**GW:** GigaWatt

**Hopper:** a small vehicle designed for atmospheric flight. While some may have limited aerospace capabilities, they are generally utilized for intra- and intercity transport of personnel.

**ISA:** International Space Agency. Formed by the NUN in 2018 in an effort to coordinate international space exploration missions. Succeeded by both the UESPA and UESN in 2067 and 2069, respectively.

**Ishakawa-Dell Barrier:** The exponential growth in the power required by early warp nacelles as FTL speeds approached warp factor 6 (on the OCU scale).

**Laser:** Typically, a secondary weapon on early space vessels. Current shielding technology has largely negated the threat posed by the coherent electromagnetic beam.

**M:** Meters

**M/AM:** Matter/Antimatter

**MT:** Metric Tons

**Navigation Light:** Yellow in color; these lights are generally located on or near major points of superstructure of a space vessel. They often provide low-emission positioning signals for specific locations on and within the vessel for the purposes of proximity maneuvering by another vessel and relative destination positions for transporters. Not to be confused with red or green running lights.

**NCC:** Letter prefix in UFP Starfleet vessel registries, anecdotally said to come from the term Naval Construction Contract. Current usage has letter N signifying UFP registry, and CC signifying active Star Fleet forces.

**Nearspace:** The region of the Federation considered to be internal, fully charted, and uncontested.

**NUN:** New United Nations. Formed in 2011, first dissolved in 2053 (during the Third World War), re-formed in 2065 (two years following First Contact), then finally dissolved in 2079. Authorized the formation of the ISA (2018), UESPA (2067), UEDP and UESN (both 2069). Succeeded by the UEDP



## GLOSSARY (CONTINUED)

OCU: Original Cochrane Units, representing the original warp scale, where the warp factor cubed was the velocity in c, the speed of light.

Operational Standard: the description and designation for a previous testbed or prototype vessel that has been made operational, though not necessarily to the standards of the official class. Ex: USS Constellation (operational standard)

P/S: Port/Starboard; left & right side, respectively, in naval parlance.

Particle Cannon: A primary or secondary weapon on some early space vessels, though generally replaced by phaser technology. The weapon accelerated charged or neutral matter (or antimatter) particles to relativistic speeds. Also commonly known as phase cannons.

Phase Cannon: (see Particle Cannon)

Phaser: A directed-energy/particle weapon in common use aboard Star Fleet vessels, as well as other UFP and foreign fleets. Based upon rapid radion effect, it generates a wide-band particle beam utilizing both electromagnetic and subspace components.

Plasma Cannon: A projectile weapon in common use aboard early space vessels. A sublight weapon, the cannon generates, contains, and directs the release of ionized matter. The weapon is often complemented by particle and/or laser weapon systems.

Prototype: a vessel constructed (or modified) to perform tests and trials of a potential new class (or subclass) of ship.

Running Light: Red (port/left) and green (starboard/right) lights traditionally denoting the observed side of a water vessel under low light conditions. Utilized for similar purposes by space vessels of the UFP though generally for rapid orientation by the pilots/helms of other vessels maneuvering in close proximity. Not to be confused with yellow navigation lights.

SCE: (see Star Fleet Corps of Engineers)

Scout: A small to medium, fast research and/or reconnaissance space vessel, equipped with extensive sensor and research equipment. Though protected by defensive energy weapons, most substitute probe launchers for torpedoes.

Series: a succession of vessels all deriving from one standard, comprised of the original class, subclasses, flights, and types. Ex: the Constitution series

Shuttle: An auxiliary craft carried by larger vessels for orbit-to-ground transportation or detached operations. Also used for starbase liaison duties.

Shuttlepod: Very small auxiliary craft used for ship-to-ship or orbit-to-ground transportation, free-space maintenance, and repair work, and detached operations of a very limited nature. Usually not equipped with a warp drive.

Star Fleet: The primary exploration and defense organization of the UFP. Formed in 2161 to protect the integrity of the Federation and the safety of its members and to expand the knowledge of the member cultures.

Star Fleet Corps of Engineers: the special construction, maintenance, repair, and public engineering management agency (an echelon of Star Fleet Engineering) for both Star Fleet and the Federation. The SCE is often tasked with building and maintaining facilities both standard and exotic, as well as providing rapid response to engineering problems that occur far from Federation resources.

Starfleet: Short-hand name for the United Earth Starfleet (UESF), the primary exploration and defense organization of United Earth 2033-2161. Not to be confused with the UFP Star Fleet. Renamed Earth Fleet upon the formation of the United Federation of Planets.

STL: abbreviation for Slower Than Light.

Subclass: A significant variant of a given class of ship, usually newbuilds, though sometimes including important modifications to existing ships, that are not intended to replace the existing ships of the original class. Often named for the first ship to reach that final intended production standard.

Tender: An auxiliary vessel specifically designed for deep space replenishment and support of starships and other vessels. While often equipped with a tractor device, the inability to efficiently tow another vessel in warp distinguishes the tender from a tug.

Testbed: a vessel constructed (or modified) as a platform to test new technologies, with the vessel not necessarily transitioning to an operational status.

TNG: Terrance-Nelorr Graduated scale where upon each full warp factor is achieved when a certain number of cochranes were met in output, resulting in more efficient engine plateaus. In this scale, Warp 10 is unattainable.

Torpedo: The general designation for warp-capable guided projectile weapons, in contrast to sublight-only guided missiles.



## GLOSSARY (CONTINUED)

**Transport:** A Starship or other vessel dedicated to transporting passengers or cargo. They range in size from small two- or three-crew ships to huge starships and freighters.

**Transwarp Drive:** The common name for drive systems capable of higher speeds and efficiencies than the warp drive currently in use throughout the Federation. Promising venues of research include deep subspace immersion, new power regulation methods, dimensional rift techniques, and time manipulation. No practical drives of these types are yet available at this time.

**Tug:** 1) A warp-powered ship specifically designed to extend her warp field around objects that can thereafter be towed at warp speeds. Primarily used for the carriage of transport pods and towing of disabled starships or other equipment lacking appropriate motive capabilities. 2) A craft designed to propel ships or equipment lacking motive power about a limited area of operation, such as a space dock or construction site. May also refer to such a vessel intended to assist ships maneuvering within and in the vicinity of docking facilities.

**TW:** TerraWatt

**Tyme Barrier:** The exponential growth in the power required by early warp nacelles as FTL speeds approached warp factor 7 (on the OCU scale).

**Type:** a variant to a class, subclass, or flight that is extremely limited in numbers and not intended to supplant the origin category. Oftentimes used to explore potential variations for future upgrades. Ex: the Bonhomme Richard subclass (Type 2)

**UEDP:** United Earth Defense Pact. Formed by the NUN in 2069 to put the "Earth's ascendancy and safety ahead of national goals". Tasked with the combined command and control of the planet's various armed forces, it became the de facto world government upon the NUN's second dissolution in 2079, until superseded by the United Earth government in 2130.

**UES:** United Earth Ship. Ship prefix for the names of vessels of the UESN.

**UESF:** (see Starfleet)

**UESN:** United Earth Stellar Navy. Predecessor to the UESF. Formed under the authority of the United Earth Defense Pact in 2069.

**UESPA:** United Earth Space Probe Agency. Formed by the NUN in 2067, relieving the ISA of the coordination and development of human presence in interstellar space. Re-purposed as the exploration arm of the NUN in 2069.

**UESS:** United Earth Space Ship. Ship prefix for the names of vessels of the United Earth Starfleet.

**UFP:** United Federation of Planets. Formed in 2161 by a coalition of United Earth, the Andorian Empire, Tellar, Alpha Centauri, and the Confederacy of Vulcan, following the Romulan War.

**UFP SF:** (see Star Fleet)

**USS:** UFP Star Fleet Starship. Ship prefix for the names of Star Fleet vessels, emblazoned on ship hulls (along with the ship's registry number). Commonly abbreviated as "United Starship" in verbal communication, although the expressions "United Spaceship" and "Federation Starship" are also frequently used.

**Work Pod:** The general name for manned, sub-impulse craft used for construction, maintenance, repair, and other service tasks in space. A variety of external tools and modules are attached to the work pods to facilitate a multitude of tasks.





*In memory of Neale 'Vance' Davidson  
You inspired so many*

**JAYNZ**

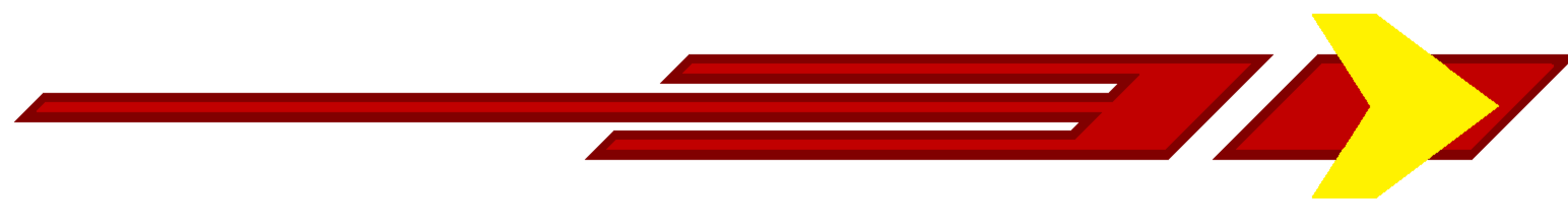

*VANCE, YOUR WORK CONTINUES...*



THE FOLLOWING ARE OTHER STARSHIP RECOGNITION MANUALS  
PUBLISHED BY DELTA DYNAMICS:

## **REPORTS**

- BONAVENTURE survey cruiser
- BONAVENTURE dilithium power testbed
- BURKE frigates
- CONSTITUTION heavy cruisers
- DURANCE cargo tugs
- HORIZON heavy cruisers
- SYRACUSE destroyers
- TRENT destroyers

