

**FIRST REVISED EDITION
PRIME ONE TIMELINE
(MODIFIED GRAHAM/MANDEL)**

6

**FEDERATION
SPACEFLIGHT
CHRONOLOGY**

TERRAN ORIENTATION

TERRANGO LANGUAGE EDITION



**AUTHORIZED
PERSONNEL ONLY**
SECURITY LEVEL TWO

Original texts and manuscript concept copyright © 2007 by Richard E. Mandel

STAR TREK, its on-screen derivatives, and all associated materials are the property of Paramount Pictures Corporation. Multiple references in this document are given under the terms of fair use with regard to international copyright and trademark law. This is a scholarly reference work intended to explain the background and historical aspects of *STAR TREK* and its spacecraft technology and is not sponsored, approved, or authorized by Paramount Pictures and its affiliated licensees.

All visual materials included herein is protected by either implied or statutory copyright and are reproduced either with the permission of the copyright holder or under the terms of fair use as defined under current international copyright law.

All visual materials used in this work without clearance were obtained from public sources through public means and were believed to be in the public domain or available for inclusion via the fair use doctrine at the time of printing.

Cover art courtesy of Steve Baron and SciFi Meshes

This work is dedicated to Geoffery Mandel, who started it for all of us.

Memory Alpha and SFHQ/Mastercom cataloging data:
UFP/SFD DTA HR:217622

22nd CENTURY

The Rise of the Federation (2101-2200)

PART SIX

2101-2150: THE BIRTH OF THE FEDERATION

OVERVIEW

CHRONOLOGY/TIMELINE

STARSHIPS

PROMETHEUS CLASS RINGSHIP

DY-1200 SERIES

DURANCE CLASS TRANSPORT

WRIGHT CLASS CRUISER

CAVALRY CLASS DESTROYER

VANGUARD CLASS TRANSPORT

HORIZON CLASS SURVEY CRUISER

ARMSTRONG CLASS HEAVY CRUISER

GALLANT CLASS STAR FIGHTER

HOPKINS CLASS HOSPITAL SHIP

ALIEN ENCOUNTERS

PIRACY IN HIGH SPACE

TERRAN EXPLORATIONS

RIGEL VII

ORION (RIGEL VIII)

PYRIMIS

HISTORICAL ARTICLES

AN OLD MAN ON A NEW WORLD

ONE PLANET, ONE GOVERNMENT

WELCOME TO THE FEDERATION

DYSON-YOYODYNE CHANGES MARKETS

STARBASE 1 BEGINS OPERATIONS

SPACE WAR GAMES DISTASTER

STAR FLEET ACADEMY FOUNDED

ATLAS DISAPPEARS WITHOUT A TRACE

SCHEMATICS



Spring on Vulcan



Summer on Andor

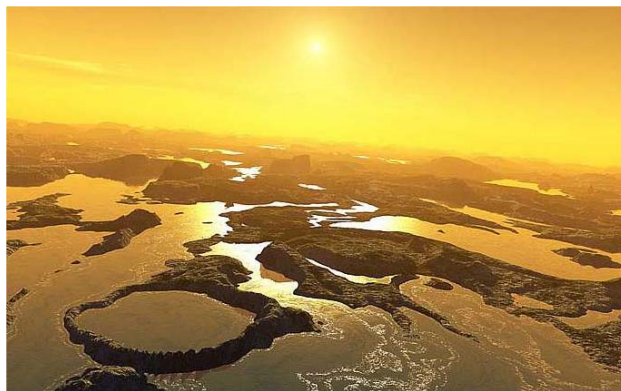

Fall on Kzin



Winter on Kaferia

2101-2150: The Birth of the Federation



The United Federation of Planets was formed from the most unlikely of circumstances. The hand of fate, or most likely the long-term designs of some long-ago advanced civilization now extinct, had placed five highly advanced humanoid civilizations within 20 parsecs of each other. These would become known as the Local Group. All save the Vulcans developed interstellar spaceflight within a two to three millennia timespan. All save the humans had endured the Kzinti scourge (or tolerated, in the case of the Vulcans) and survived until relief finally came in the form of the Earth-Kzin Wars. All had an ingrained desire to seek new worlds to contact and colonize, new peoples and civilizations whose very differences from them would show them the path towards new knowledge. None of these expected to find alien cultures with the same dreams and desires so close to themselves. The Vulcans, the eldest and most advanced, were the first to grasp the significance of this situation. Long before the end of the Kzinti Empire they were already moving, slowly yet deliberately, to bring these five disparate peoples together and band them together into an interstellar alliance the likes of which the galaxy had never seen.

The notion of an alliance of federation of some sort among the members of the Local Group was an

inevitable necessity. None welcomed the notion that all were competing for the same worlds within the Local Group, let alone the vast tracts of space opened up for exploration in the New Territories by the fall of the Kzinti Empire. Habitable or adaptable worlds were few and far between and already, as the case of Vega IX had shown, these were going to be hotly contested. The humans of Terra and Alpha Centauri by far had the strength and the will to build a Terran Empire had they so desired; however, they did not. Their own recent experiences coupled with the agony of the four Earth-Kzin Wars was part of the reason. The restraining influence of the Vulcans, smaller in number by far but with superior technology, plus their sometimes vexing yet always admirable dedication to logic and reason, was another. The perils of assumed belligerency had been graphically illustrated when first Tellar Prime and then Andor earned their places in the Local Group. The option of empire building was thus quickly jettisoned once these five cultures – Terran, Centaurean, Vulcan, Tellarite, and Andorian – came together. The other lesser worlds of the Local Group, both colonies and independent cultures, naturally looked to these five for leadership and direction after the fall of the Kzinti. It was thus only natural that they take the lead in picking up the pieces left behind by the war.

It seemed a given, even by the Vulcans, that humanity would form the backbone of this new interstellar alliance. It was the most populous and vigorous culture by far. Its desire to explore and colonize had already brought it in contact with almost every major and minor species of the Local Group, with more and more outreach into the New Territories every day. It had proven its martial abilities on behalf of those in its care during the Earth-Kzin Wars, displaying what was to all save the Vulcans a remarkable talent for learning from its enemies and using that knowledge against them. Such drive and determination for both peace and war would be needed in the new alliance. The only real issue was how to temper this desire for the common good. The other members of the Local

Group were leery of the idea of a permanent alliance for this very reason until humanity could prove it could work for the common good. Even given the proofs of the Earth-Kzin War and the War with the Vegan Tyranny, it would take much diplomacy on the part of Vulcan before the interstellar alliance for which it had so long worked began to coalesce and form.

The brief war with what remained of the Vegans reminded the members of the Local Group that there were more foes other than the fallen Kzinti still lurking in the Sea of Stars. A common alliance would be necessary to deal with such a threat. Humanity might be able to do it alone again; however, the best interests of all would be served by working together for the common good. A common alliance would also benefit the peace that would come after such conflicts, peace like that which the Local Group now currently enjoyed. Common trade protocols, a universal system of exchange, compatible laws, joint projects and cultural exchanges, and so on. The differences that made each of them unique could unite to make them stronger and thus benefit the common good. So the Vulcans said, time and again in their own quiet way each time a conference on the subject of alliance was held. The first did not succeed, nor did the second. Gradually, though, over the years and with the patient sponsorship of the Vulcans, the notion of alliance finally took hold.

The final obstacle towards the founding of the Federation was the biggest. Each of the Local Group powers would have to give up the bulk of their space fleets and pool them together in a common force for the common good. Terra's Star Fleet, by far the largest, best equipped, and most experienced, would serve as the foundation model for the new Federation Star Fleet. Naturally this caused protests among the Tellarites and Andorians, each proud of their own accomplishments and unwilling to break up their fleets in order "to ensure human dominance of the stars." Both the humans and Vulcans had to remind them that Terra, alone of all Local Group cultures, was already moving toward a multicultural, multi-ship fleet. Following the Terran lead would allow the others to both draw down their own fleets to local

defense levels while at the same time maintaining their cultural independence and importance. It was a political ploy, pure and simple, but it worked. There was no future for the Federation without Star Fleet. There was no future for Star Fleet without Local Group acceptance and support. The "local fleet" compromise broke the stalemate and cleared the last hurdle on the path to unity. The Articles of Federation were signed by representatives of the five major powers of the Local Group on May 8, 2127 (Terran Old Calendar). With that, the United Federation of Planets was born.

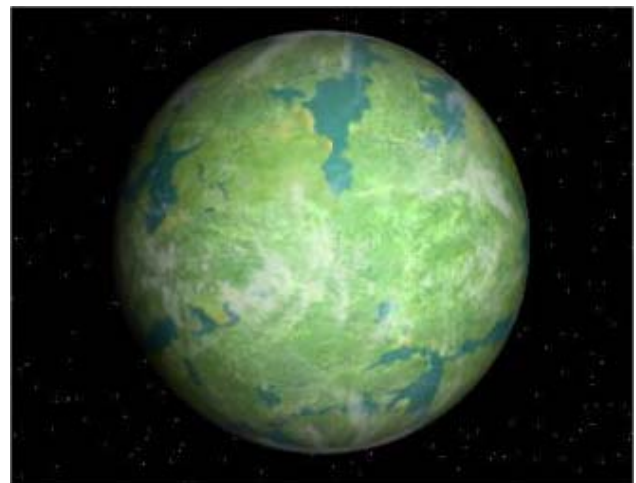

The planet Babel, site of the signing of the Articles of Federation (2127)



The last of the Vegan Tyranny voidships, shortly before its self-destruction in 2093

MAJOR EVENTS

2101

- The term *Class J* is derived for any limited-crew, limited-mass civilian freighter, transport, or tug in use within the Federation.
- The Terran-Vulcan Cultural Exchange Program marks a landmark event in the growing ties between these two Local Group powers.
- *Terra 15*, the last of the Industrial Space Arks, turns up at the first planet in the Tau Ceti system, disabled from an ion storm. The damaged ship is forced to make a crash landing on its nearby moon. A human colony is established under survival domes using parts scavenged from the ship.

2103

- The Mars Terraforming Project reaches the end of its first stage. The planet now has a breathable atmosphere, although it remains somewhat dry and cold. Work continues over the next century to make the climate of Mars more tolerable for humans.

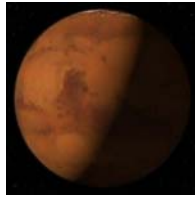

2104

- Terra's International Space Agency (ISA) is finally disbanded.

2105

- The *Prometheus* class ringship enters service.
- The military version of the CIE-07 enters service.
- The *Roanoke* class transports enter service.
- The *Long* class cargo barges are decommissioned.

2107

- The *Aquarius* class transports are withdrawn from service.

2108

- A UESPA mission arrives in the Tau Ceti system and rescues the stranded *Terra 15* colonists. Their crude emergency colony, whimsically named "Shangri-La" will be abandoned and never inhabited again. Its massive space ark derived survival domes will still be intact at the end of the 23rd century and visible to observers from orbit.



c. 2110

- Dyson-Yoyodyne releases the DY-1100 series, the first with true warp drive, during this decade.

2112

- Zefram Cochrane embarks on his last space voyage and never returns. He will later be declared "missing, presumed lost."
- A newly discovered planet is named Cochrane in honor of the lost space warp pioneer.



2113

- By this time poverty, war, and disease have been largely eradicated from Terra. This marks the beginning of a planetwide renaissance that historians will later call its Second Golden Age.
- The United Earth Government is founded from a union of the United States of North America and the European Hegemony – the former having overcome years of resistance from its religious and political conservatives. Most other major national governments will join within the decade.

2114

- The first Congress on Interstellar Union is organized by the Coalition of Planets with the sponsorship of the Vulcans. These will meet on a regular basis for the next fourteen years, paving the way for the founding of the Federation. The first is held at Barnard's Star; the rest at new diplomatic facilities on Babel.

2115

- The *Orlando* class transport, an automated *Monticello* retread, enters service.
- The *SS Marco Polo* discovers the Galactic Malestrom. This will later be nicknamed "Polo's Bolos" in its honor.

2116

- The venerable spaceliner *Magellan* is finally decommissioned. She is almost immediately purchased by a new owner and converted to a hospital ship, giving it a new lease on life within the Sol System.

2120

- The last of the "re-released" DY-245s, the DY-245 Mark II, is built. Dyson-Yoyodyne immediately releases the DY-500 Mark III, a new version of the DY-500 Mark II (re-release version) complete with improved

systems and jump drive capability. It is an instant hit and provides the funds necessary for the company's last commercial starship program.

- The *Cosmos* class scouts are decommissioned.

2121

- The Terran Star Fleet adopts new uniforms and a new logo as part of the planet's administrative transformation under the United Earth Government.
- The wreckage of the century-old submersible *Nautilus* is recovered from the oceans of Europa, with all of its recorders and telemetry intact.

2123

- The *SS Mariposa*, one of the first of the new DY-500 Mark III starships, is successfully launched from the Balkinour Cosmodrome on Terra on a colonization mission to the Ficus Sector. It follows in the wake of dozens of other such efforts.
- The DY-1200 series enters service during this decade. It will be the last original DY-series design ever built.



2125

- The Federation Era officially begins. Delegates from the Coalition of Planets, along with representatives from their colonies and other allied systems meet at Babel as part of this year's Congress on Interstellar Union to draft the Articles of Federation. The Articles will be the original founding document of the United Federation of Planets.
- A dissident faction on Vulcan, the Symmetrists, gains enough strength to weaken Vulcan participation in the Congress on Interstellar Union for two years.
- The first draft of the Articles of Federation is made and summarily rejected. The actions of the First Congress are tabled, to be resumed by the Second Congress the following year.

2127

- The final draft of the Articles of Federation are ratified by all attending delegates of the Congress on Interstellar Union at Babel on 08 May. The United Federation of Planets is born.
- As part of the founding of the Federation, the Terran Star Fleet (larger than any other such force wielded by any Coalition member or ally) becomes the backbone of the Federation Star Fleet. It is charged with the defense



of the new interstellar alliance. The military forces of all five members and their allies and affiliates will eventually be disbanded and incorporated into Star Fleet.

- A late amendment to the Articles of Federation allows for "the maintenance of fleet strength to the signed powers sufficient for local police, customs, and tariff duties." This compromise allowed the integrated Star Fleet clause to pass its final vote.
- The Star Fleet Special Security Division (SSD), the internal affairs and investigations department of Star Fleet, is founded.
- An Orion offer to join the Federation in exchange for the sum of 10 trillion pressed latinum strips is flatly rejected by the Congress. Orion declares its "neutrality" as a result.
- Harmon Axelrod, leader of the Terran delegation, is unanimously elected as the first president of the Federation Council.
- The Federation Worlds Court is founded. One of its very first rulings will be to ban the ownership of synthetic consciousness. This ruling will become one of the first to (indirectly) recognize the sentience of artificial intelligence.

2129

- Alpha III, aka Terra 4 (Terran colony 4), a planet in the Procyon A system, becomes the first new member of the Federation after its founding. It is a thriving Class M planet originally founded as a Buddhist Chinese colony.

2130

- Dyson Yoyodyne's last new spacecraft design, the warp-capable DY-1300 military cruiser, is planned but never built. The current company leadership acknowledges that its prominence in the field of Terran spacecraft is long over. They will instead focus exclusively on the "classic starship" market.

2132

- The Local Group's subspace transponder network is finally completed. Work begins on a similar network for the New Territories.

2134

- A branch of the Terran Space Academy is opened on Vulcan.
- The Romulans are encountered for the first time in the *Carrizal* Incident. The Federation survey cruiser *Carrizal* discovers and maps the Romii star system. The Romulans are shocked by the "bold" intrusion of the *Carrizal* into their space but allow the starship, well in advance of their own, to proceed unharmed. Instead, they begin to plan for war against its builders.

They will keep their activities covert for the next two decades, probing Federation strengths and weaknesses.

2137

- The Federation survey cruisers *Balboa* and *Stone Mountain* enter Romulan space on a mission of peace. The *Balboa* is promptly blasted from the sky and the *Stone Mountain* captured after its crew is annihilated. The Romulans learn much from the *Stone Mountain*, including the secrets of warp drive.
- In a perfect example of bureaucratic idiocy the decision is made not to send any more Federation starships beyond the borders of the New Territories, given the unexplained loss of three within a year. This will cause the Federation to turn a blind eye to the new threat growing on its far border for the next seven years.

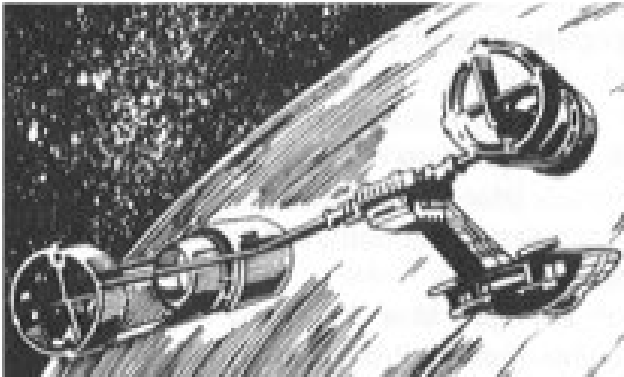

2139

- The *Wright* class cruiser enters service. This is nothing more than a Centaurean *Djartanna* heavily modified for Star Fleet use.

2140

- The first Federation census is conducted. Terra itself supports a population of ten billion, with another eight million humans living in space on various colony worlds.
- The UFP Infonet news service is created as a joint venture of the news services of various Federation member worlds.



2141

- A joint "live fire" training exercise between Terran and Centaurean ships results in tragedy when the *Verne* class cruiser *USS Scythe* is blindsided and fires on its fellow ships. 232 crewmen are lost when the destroyers *USS Hammer* and *USS Enmity* are fired upon in the resulting melee. The incident points out the need for a more formalized joint command structure and interspecies fleet training. From this incident will arise the institutions of Star Fleet Command and the Star Fleet Academy.
- Star Fleet Command comes into being.
- The *Cavalry* class destroyer enters service.
- The Star Fleet Design Bureau issues the first in what will become an ongoing series of Hull Number and Nomenclature Designation handbooks. In this first issue the basic parameters for naming Star Fleet vessels are set. Each ship authorized will be assigned a Naval Construction Contract (NCC) number by the SFDB. Hull names will be assigned based on the naming parameters for a given class in accordance with guidelines set by the Military Staff Committee. Major Federation vessels will have the "U.S.S." (United Space Ship) prefix on their names, whereas minor vessels will have a simple "S.S." (Space Ship). This basic system, with considerable modifications as each generation of starships is developed, remains in use to the present day.
- The original Starbase 1 enters service. One or two starbases will be built or completed every year from this point forward until the outbreak of hostilities in less than a decade.

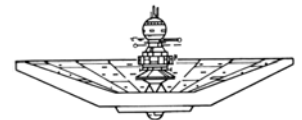

2142

- A major breakthrough in subspace radio research allows signals to be sent across the network at the previously unbelievable speed of Warp 15. This advance will be quickly backfitted into the existing network.
- A new generation of space buoys begins deployment throughout the Local Group and New Territories. These incorporate the new Warp 15 speed advance.



2143

- Star Fleet Academy is founded, with its first campus on Alpha Centauri at Phelios. Commodore Stavros Niarchos is the first Academy superintendent. Additional campuses will be established in the years to come on most major Federation worlds, with the Terran campus at San Francisco among them.
- Starbases 2 and 3 enter service.
- An informal policy begins to emerge in Star Fleet due to difficulties in achieving truly mixed crews. From about this time forward starships will be manned by 90% of one species and the remaining 10% a mix of volunteers from other whose physiology is compatible with the other 90%. Humans, who comprise 70% of Star Fleet personnel, are likewise represented in crew rosters. The majority of Star Fleet vessels will be crewed by humans, with a small mix of members from other species. This is a practice that will continue to the present day.

2144

- The *Vanguard* class transport, one of the largest commercial starships of its time, enters service. Many are also purchased for use with Star Fleet, with at least one permanently assigned to every major port and base facility.
- The Federation transport *SS Atlas* disappears while on a routine run near the edge of the New Territories. About the same time the ore carrier *SS Muleskinner* is rammed and subsequently spacejacked by "pirates." The ship is later found abandoned and its crew dead.
- The *Muleskinner* Incident gives rise to calls for increased Star Fleet vigilance against space piracy in the New Territories.

2145

- The Star Fleet vessel *Intrepid* finds the recorder marker from the *Atlas*. From it the Federation learns that a new and previously unknown alien species attacked and destroyed the *Atlas* without provocation. This is later revealed as the first deliberate incursion by the Romulans into Federation space.



- The Star Fleet transport *USS Chandeleur* disappears while on a supply run to the far side of the New Territories, cause unknown.
- The *SS Amaretto*, operating within Federation space on the far side of the New Territories, is attacked by two starships of unknown configuration similar to those logged on the recorder-marker of the *Atlas*. The civilian freighter is crippled; however, the attackers break off and retreat once a four-destroyer Star Fleet squadron arrives on the scene. The unknown aliens ignore all attempts by the lead Star Fleet vessel to communicate with them and successfully evade pursuit.
- The *Armstrong* class heavy cruiser enters service. It is derived from the Andorian *Thasfin* class cruiser and represents Star Fleet's first major "heavy" starship class.

2146

- The Delta VIII outpost on the far edge of the New Territories is destroyed. Evidence points to "pirate" activity; however, some officers in Star Fleet Intelligence are beginning to suspect otherwise.
- Star Fleet, acting on the direct orders of the Federation Council, launches 32 message probes into uncharted space beyond Delta VIII in an attempt to establish communications with the mysterious aliens who appear to be behind the recent "pirate" activity. The effort yields no results and none of the probes are ever recovered.
- The *Horizon* class cruiser enters service. A total of 51 will be built. Many will be destroyed in the new war that is about to break out along the edge of the New Territories.



2147

- Based on the failure of the probe mission, the Federation Council directs Star Fleet to beef up its strength on the far side of the New Territories in and around the general area where the "pirate" activity is taking place.
- Star Fleet Intelligence mounts a covert 12-ship mission into the same region in an effort to learn more about the mysterious aliens behind the attacks. None of the ships is ever heard from again.
- The Dinai Station Massacre marks the deepest penetration yet by the "pirates" into Federation space. All of the station personnel are killed and the station stripped of its equipment and supplies.



2148

- The *Arrow* and *Gallant* class starfighters enter service. Their unusual appearance soon earns them the nickname of "Frogstar fighters" by their pilots.
- The *Hopkins* class hospital ships are the first of the type to enter Federation service.
- A permanent Federation presence is established on Rigel IV.
- The Tholians are encountered for the first time.
- The meager data gleaned by Star Fleet Intelligence so far details general characteristics about the "pirate" vessels plaguing the far sectors of the New Territories. A report is subsequently issued to all Star Fleet vessels operating in the area. It is also made available to New Territories civilian ship captains.

2149

- Starbase 10 enters service. It is towed to its new location in the New Territories. It is one of the first starbases to service the area. It will prove to be of strategic importance in the conflict that will erupt within a decade.
- Efforts at developing a working transporter achieve their first initial success in decades. The "materializer" is capable of deconstructing and reconstructing inanimate objects for a distance of several meters. Unfortunately, the power and processing requirements are enormous. The Federation Science Council withholds authorization for lifeform tests once these obstacles are overcome. It is a hurdle that will not be cleared for several more decades.

2150

- The last of the world's hold-out nations to join the United Earth Government.
- The last vestiges of old-style nationality begin to disappear as the United Earth Government asserts authority over all of Terra.
- The next phase in the space buoy project commences as navigational beacons begin to be laid at all sector and quadrant corners in Federation space.
- The *Manta* and *Clark* class "space tanks" enter service. These are actually spacegoing monitors with limited maneuverability but cruiser class firepower.
- Construction begins on a major Terran space base that will in time become Starbase 11. It is the only one of Star Fleet's Star Bases that was not built by Star Fleet itself but converted from an existing facility.
- Anti-intoxicants become mandatory for all Federation law enforcement and intelligence operatives.

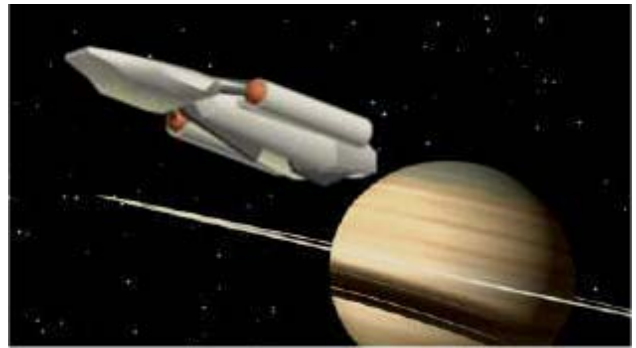

Rigel VIII, better known as Orion (c.2100)

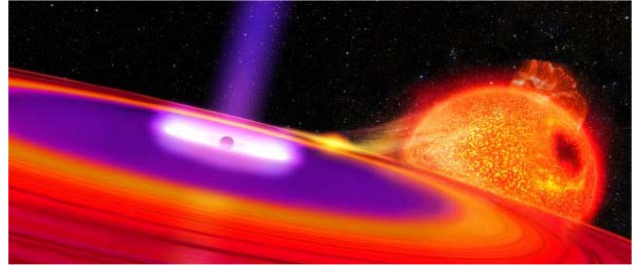

Polo's Bolos swallowing a star (c.2115)



Goddard Moonbase, Luna (c.2125)



Unknown pirate ship (c.2150)



Vulcan *D'kyr* class cruiser (c. 2150)

SPACESHIPS

***ROANOKE* CLASS TRANSPORT**

SERVICE ENTRY DATE (OLD CALENDAR): 2105

The new century ushered in a new class of Terran space transports. *Class J* cargo ships were something of an innovation at the time. They featured a redesigned cargo container grapple-and-tow system whereby these vessels could snake additional containers behind the ship in a train, towing these along with the ship's on-board cargo to their intended destination. The only limitations were the power of a Class J starship's warp engines (which limited just how many containers it could tow), and the limits to which its trailing warp field could be extended to cover the "stretching" of the ship in this manner. A three-container configuration was typical, with five representing the uppermost limit. The basic concept of the container-train configuration has proven so successful that it has remained virtually unchanged ever since.

Roanoke was the first of the Class J cargo ships. As with most vessels of its type crew spaces were at a premium. The ship's complement of 19 was squeezed together on three decks in conditions approximating those of an old DY-series starship. Oftentimes crewmembers would set up temporary quarters in the ship's lone shuttlecraft or even in the foremost cargo container. The latter was usually a costly proposition, though, and not followed unless the job involved a voyage of extreme duration. The less space needed by the crew meant the more that could be used for cargo ... and in the end, making a profit by hauling cargo was what a Class J starship was all about.

A total of 53 *Roanoke* class transports were purchased from Terra for the fledgling Star Fleet shortly after the founding of the Federation in 2127. These would form the core of its transport division, which evolved over many decades into the organization we know today as Starfleet Transport Command. These remained in service until the early 2200, thanks to numerous system and engine upgrades.

SCHEMATICS:



SPECIFICATIONS:

Length: 76.2 m
Beam: 58.8 m
Draft: 32.1 m
Mass: 19,400 DWT
Crew 20
Range: 6 years at L.Y.V.
Cruising speed: Warp 1.5
Maximum safe speed: Warp 2.2
Armament: 2 laser banks

Innovations

- First Terran transport with the ability to like multiple cargo containers together to increase cargo volume.

VISUALS:



ROANOKE DESIGN BY GREG JEIN
SCHEMATICS COURTESY OF THE STARSHIP SCHEMATIC DATABASE
VISUALS COURTESY OF FILEFRONT

PROMETHEUS CLASS RINGSHIP

SERVICE ENTRY DATE (OLD CALENDAR): 2105

The *Prometheus* class was arguably the most advanced and certainly the most unique Terran starship design of its generation. Improvements in ringship drive technology learned from the Vulcans allowed the starship engineers of Utopia Planitia to take their *Declaration* class design and refine it for the next generation. The new class could hit Warp 2 faster than any other Terran starship and could reach (and sustain) Warp 3 with ease. The only limiting factors as to its top speed were its structural integrity and its unusual tachyonic hyperdyne power plant. The engine had a theoretical limit of Warp 4.2; however, field trials showed that the design tended to get “the shakes” above Warp 3.1, becoming more pronounced with each 0.2 increase in warp speed. An unmanned prototype had torn itself apart at Warp 3.87 so the actual production design was never pushed beyond Warp 3.2. This was one of the first real-world indications of the semi-mythical Warp 4 barrier for early warp drive systems. This also made ringship technology a dead end as far as human starship designers were concerned. It would take considerable time and effort to develop a ringship capable of breaking Warp 4. Such was possible in theory, however, the outbreak of the Romulan War prevented it from ever happening.



Lack of inner space more than anything else limited the possible service applications for the *Prometheus* class. Nevertheless, it soon found two niches in which it could serve. Twelve were purchased by Solar Spaceways and reconfigured as interstellar spaceliners. These were renamed after famous Terran princesses of past history (*Teresa, Diana, Grace, etc.*) Star Fleet also ordered five as survey cruisers to supplement its own fleet of aging ringships. All were named after famous Terran explorers (*Balboa, de Gama, Livingstone, etc.*) The rest went to various civilian owners, retaining their original Utopia Planitia “giant” series of names. All were decommissioned by 2147.

SPECIFICATIONS:

- Length: 310 m
- Diameter: 205 m
- Crew 120
- Range: 12 years at L.Y.V.
- Cruising speed:Warp 3.0
- Maximum safe speed: Warp 3.2
- Armament: 4 laser banks (Star Fleet only)

VISUALS:



Concept painting (2102)

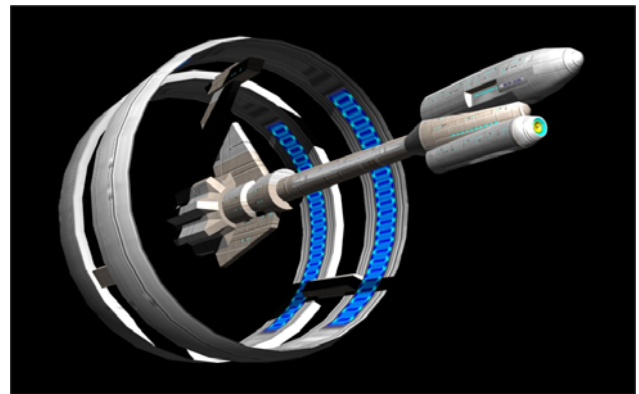

USS *Prometheus* – trial runs, Pluto Test Range (2104)

SCHEMATIC:

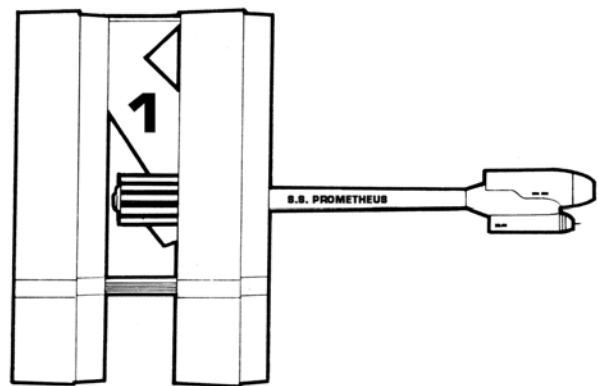

PROMETHEUS DESIGN BY WALTER M. JEFFRIES
AS INTERPRETED BY GEOFFERY MANDEL AND DOUG DREXLER

DY-1200 SERIES

SERVICE ENTRY DATE (OLD CALENDAR): 2123

The DY-1200 was the last hurrah for Dyson-Yoyodyne, the company that at one time had held a monopoly on the Terran spacecraft market. It was little more than an improved DY-900; however, one design feature deserves special notice. The company contracted with Cochrane Warp Dynamics for a new type of circumferential warp engine that was lighter yet just as powerful as current designs. Their solution was to lengthen the engine, adding more firing chambers to make up for the smaller diameter of its housing. This new engine design would serve as the basis for the warp engines used in the forthcoming *Daedalus* class survey cruisers.

The DY-1200 sold well enough for Dyson-Yoyodyne to make its graceful exit from the starship market. The company restructured soon after and focused exclusively on the "classic starship" market, providing parts and service for its own designs in addition to others from Terra and other Federation worlds from past starship eras.

SPECIFICATIONS:

Length: 270 m
Beam: 54 m
Mass: 19,250 DWT
Crew 75
Range: 3 years at L.Y.V.
Cruising speed:Warp 2.2
Maximum safe speed: Warp 2.75
Armament: 4 laser banks

VISUAL:

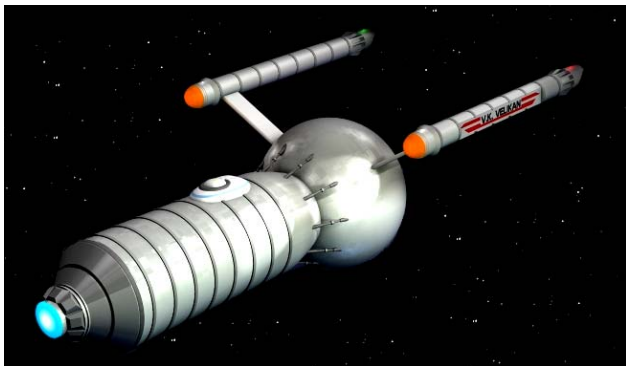

DY-1200 SERIES COURTESY OF THE JOURNAL OF APPLIED TREKNOLOGY

WRIGHT CLASS CRUISER

SERVICE ENTRY DATE (OLD CALENDAR): 2139

The *Wright* class cruiser was little more than an enlarged *Djartanna* with more powerful engines and accommodations for habitation by other Federation species. The already cramped interior space was further limited by the subsystems necessary to support the large array of weapons Star Fleet had required for the design. They never quite lived up to their expectations and were reclassified as light cruisers once the *Armstrong* class entered service in the 2140s.

The *Wright* normally carried two small shuttles in a bay just below the engine pylon dorsal and above the impulse engine. During the Romulan War the shuttles were commonly replaced with mine racks or two *Gallant* class fighters depending on the mission at hand.

These ships would soldier through the Romulan War despite their obsolescence. They could be most frequently found as the core ships in a starbase or outpost garrison fleet, where their heavy firepower mattered and inherent design limitations were of little consequence. They lumbered on long after the war, with the last of the *Wright* class decommissioned in 2179.

SPECIFICATIONS:

Length: 168 m
Beam: 159 m
Draft: 39.5 m
Mass: 23,500 DWT
Crew 125
Range: 5 years at L.Y.V.
Cruising speed:Warp 2.0
Maximum safe speed: Warp 3.0
Armament: 6 laser banks
2 particle beam cannon
2 fusion torpedo tubes (both forward)

VISUAL:

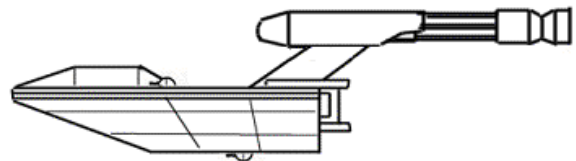

WRIGHT CLASS BY DAN KNUTSON
AS REINTERPRETED BY RICHARD MANDEL

HORIZON CLASS SURVEY CRUISER

SERVICE ENTRY DATE (OLD CALENDAR): 2146

This, the original *Horizon* class, was one of the first “true” Federation starships in that it was not a “local” design. Its lines betray its Terran heritage; however, as Terran influence was still very much dominant in the new Federation Star Fleet. These were the original survey cruisers of the Federation, systematically charting and surveying the new systems and worlds of the New Territories previously unknown to the Local Group. A total of 51 would eventually be built. The needs of the Romulan War would both slow production and change the class mission profile. Its armaments were upgraded and it was pressed into service to fill the gaps caused by losses among Star Fleet “heavies.” After the War, the survivors were reconfigured as priority armed transports and relegated to secondary duties. At least a dozen of these aged workhorses are still in use in the civilian sector.

SPECIFICATIONS:

Length:	280 m
Beam:	136.5 m
Draft:	57.8 m
Mass:	38,500 DWT
Crew:	224
Range:	15 years at L.Y.V.
Cruising speed:	Warp 3.0
Maximum safe speed:	Warp 3.25
Armament:	4 (8) laser banks* 2 (6) particle beam cannon* 50 (200) fusion torpedoes*

(*) numbers reflect Romulan War upgrade

Innovations:

- First non-local Federation starship class
- First starship to carry work pods
- First starship to use duranium to lighten mass

VISUAL:

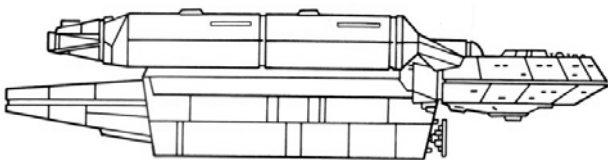

HORIZON CONCEPT BY RICK STERNBACH

ARMSTRONG CLASS HEAVY CRUISER

SERVICE ENTRY DATE (OLD CALENDAR): 2147

The *Armstrong* class was the main Andorian contribution to the new Star Fleet. Inspired by the Andorian’s own *Thofsin* class battlecruiser, the *Armstrong* class was designed to replace the aging *Messier* class in the role of primary Star Fleet ship-of-the-line. Its engines were the same weight saving, elongated Centaurean design as those of the DY-1200 transport; however the design of the rest of the ship was pure Andorian. The first of these entered service in 2147, with another being built every two years due to limited yard space. As each was introduced a *Messier* class starship was correspondingly “retired” to fleet scouting and secondary support roles. 12 additional ships were authorized once the Romulan threat became clear. All of these were completed by war’s end; however, four were lost in battle and a fifth so badly damaged that it had to be scrapped.

The *Armstrong* class emphasized the Andorian “weapons-over-comforts” design philosophy. Many of its crews complained that its interior spaces were as cramped as those of a *Cavalry* class destroyer. This was a price that Star Fleet was willing to pay for its impressive arsenal of lasers, torpedoes, and particle beam cannon. In another era they might have been classified as battle cruisers or dreadnoughts had they the shielding to match. Energy shielding technology was still a decade away from starship installation, though, so the *Armstrong* class was fitted with ablative armor like all other Star Fleet vessels of the era.

The *Armstrong* class shares the same distinction as the *Wright* class in being one of the forerunners of the Class I program. Whereas the *Djartanna* derived *Wright* class would eventually evolved through several stages into the Class I heavy cruiser, the *Armstrong* was the direct ancestor of the *Loknar* class frigate. It was the first Star Fleet vessel to employ an H-frame type hull design. This unusual configuration made the *Armstrong* class quite maneuverable at warp speeds, more so than it should have been for a vessel of its size and mass. This design feature did it little good in the mostly sublight battles of the Romulan War; however, it would benefit its descendants of wars to come.

One of the most interesting design offshoots of the *Armstrong* program was the **NX-Program** design study of the early 2150s. This would have replaced the catamaran-style primary hull with an elliptical saucer. Andor’s Chiokis Design Group had been doing a lot of experimentation with saucer-shaped hulls the past decade in an effort to overcome the limitations of existing starship designs. Their initial research data suggested that a saucer shaped primary hull, be it circular or elliptical, would maximize a starship’s mobility at warp speed. Unfortunately, the starship technology of the day was simply not up to building a frame strong enough for a saucer that could withstand the stresses of warp speed. In addition to this the warp engines of the day

HOPKINS CLASS HOSPITAL SHIP

SERVICE ENTRY DATE (OLD CALENDAR): 2148

These were not so much ships as they were mobile bases built for rapid transport from one location to another. All of them had the same external generic design; however, inside they could be custom-tailored to the specific needs of the worlds over which they orbited. These were extremely valuable in the settling of the New Territories, providing modern medical facilities where they would have otherwise been absent. They also played a prominent role in the Federation Medical Assistance Program, often being dispatched to worlds suffering from epidemics and other severe medical emergencies. At the end of the Romulan War several were converted into the first Neutral Zone outpost stations. The rest, with periodic upgrades and overhauls, continued in civilian service until 2173.

SPECIFICATIONS:

Length: 238 m
 Diameter: 150 m
 Mass: 90,000 DWT
 Crew 128
 Patient capacity up to 600
 Range: 4 years at L.Y.V.
 Cruising speed:Warp 2.2
 Maximum safe speed: Warp 2.75
 Small craft:5 medical shuttles
 Armament: 4 (8) laser banks*

(*) numbers reflect Romulan War backfits and conversions

VISUAL:

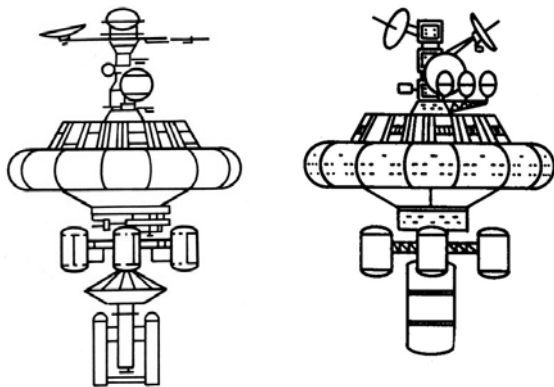

Hopkins class hospital ship as built c. 2100 (left)
 Neutral Zone outpost station conversion c. 2170 (right)

ORIGINAL *HOPKINS* CONCEPT BY RICK STERNBACH
 OUTPOST STATION MODIFICATIONS BY LAWRENCE MILLER

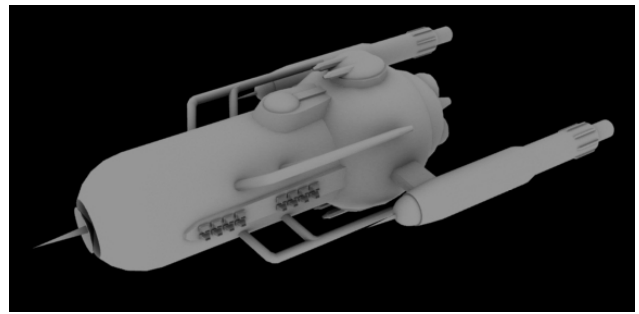

DY-1300 design proposal (c.2130)



A *Merchant* visits a newly discovered habitable world



Late afternoon on one of the inland seas of Rigel V



Typical Federation mobile supply base – New Territories

ALIEN ENCOUNTERS

PIRACY IN HIGH SPACE: THE EARLY ROMULAN ENCOUNTERS

EXTRACTED FROM *THE EARTH-ROMULAN WAR* BY HIDEKI OSASAKI
(TERRA: NEW CENTURY PRESS, 2270)



USS Atlas recorder-marker image – enlarged for clarity

In 2134 the Star Fleet survey cruiser *Carrizal* conducted a deep probe of unexplored space on the far side of the New Territories border. Its mission was to chart the region for any Class M worlds suitable for future Federation colonies. Even though the fledgling Federation had not as yet completed detailed surveys of its own interior, nonetheless it was already looking beyond its borders. The *Carrizal* was but one of several long-range survey ships sent on such missions, looking to push Federation influence into previously unexplored space. The irony here was that the *Carrizal* was a ringship, of the same design lineage as the ill-fated *Sakharov* over eight decades before. The hand of Fate enjoys inflicting such coincidences on human destiny.

Among the many worlds that the *Carrizal* charted was a previously unknown Class M planet in the Romii star system. It was part of a binary planetary pair, one of the few in known space. The world appeared to be already inhabited by a sentient life form, thus eliminating any possibility for colonization. Normal procedure would have been for the *Carrizal* to initiate first contact proceedings, however, it was already behind schedule on its survey mission and both captain and crew wanted to return home. Instead, the *Carrizal* made two orbits of this new Class M world at what it believed to be a safe distance, made its sensor recordings, and then left. Had its captain followed proper procedure on this occasion, history might have been written far differently than it is known to us today.

Three years later, the Federation survey cruiser ship *USS Balboa* returned to the Romii star system. It was accompanied by

another Federation starship, the *USS Stone Mountain*. Their mission was to initiate the first contact proceedings that the *Carrizal's* captain had so blatantly ignored before. Data from the *Carrizal's* sensor logs had revealed what appeared to be an intelligent culture on the verge of spaceflight. The crews of the *Balboa* and *Stone Mountain* went in with every hope and expectation of welcoming a fellow spacefaring race to the stars, just as the Vulcans had done with humanity in 2064. What neither expected was a hostile reception. The *Balboa* was blown to pieces in a carefully coordinated attack by both orbital weapons and over fifty small craft that swarmed into the area just a few minutes after the two starships had entered orbit. The *Stone Mountain*, damaged by flying debris from the *Balboa* and desperately trying to flee the scene, had its outer hull pierced in multiple locations by both missiles and lasers. It lost all atmosphere within seven minutes. The fate of any survivors who might have made it to their spacesuits is not recorded. The *Stone Mountain*, along with the wreckage of the *Balboa*, would be carefully studied by these mysterious, hostile, humanoid aliens for the next few years. As with many other survey cruisers of the era, the two Federation starships were simply logged as “missing, presumed lost,” memorialized in brief, then forgotten.

On 10 November 2144 the Star Fleet transport *USS Atlas* failed to return from a supply mission to Federation colonies along the far border of the New Territories. The ship was officially declared missing a week later and a search conducted by all nearby starships. Not long after the ore carrier *SS Muleskinner* was rammed, its cargo looted, and its crew murdered execution-style. Also around the same time the Star Fleet transport *USS Chandeleur* simply disappeared without a trace. Both the *Muleskinner* and the *Chandeleur* had been operating in the same general area where the *Atlas* was lost. The Federation Council immediately ordered a moratorium on all activity in the area while Star Fleet tried to deal with the problem. It would only get worse with time.

It was the *Messier* class cruiser *Intrepid* that finally located the debris field from what had been the *Atlas* in early 2145 and subsequently recovered its recorder-marker. Its data was immediately transmitted back to the nearest Star Fleet base via subspace radio. It showed the *Atlas* being attacked and destroyed by an alien starship of unknown configuration. Clearly visible on its underside was a large red insignia vaguely resembling an eagle or other bird of prey. Several months later the civilian transport *SS Amaretto* was attacked by two starships of unknown configuration while cruising in Federation space within range of the area of space where the prior attacks had taken place. It would have been destroyed had not a squadron of four *Cavalry* class destroyers picked up its distress

call and arrived on the scene. The unknown ships quickly withdrew at high warp speed, much to the irritation of the destroyer crews. Later, when the sensor logs of all five ships were played back and compared, the two intruders were discovered to be the same type of vessel that had attacked and destroyed the *Atlas*.

These incidents, occurring less a year apart but apparently involving the same culprits, convinced many in the Federation Council that space pirates had begun operating on the New Territories border. There had been trouble with piracy since the days of the Coalition, and their boldness and flair for grandiose gestures were well known. It was believed by many Federation politicians that the unusual "bird-of-prey" insignia on the mystery starships was one such gesture. As a result Star Fleet received increased funding for new starship construction, with the understanding that more vessels would be dispatched to the New Territories to "crush the pirates" as they became available.

These "pirates" didn't wait for Star Fleet to get ready. On 12 April 2146 they made their boldest move yet, looting and destroying a small Federation outpost on Delta VII and killing all of its personnel. The act prompted the Federation Council to order Star Fleet to dispatch almost three dozen warp probes into the general area in a vain attempt to establish contact with the "pirates," with no success. The following year, the "pirates" got even bolder. On 21 February 2147 they raided Dinai Station, a civilian sector supply base within cruising range of nearby Star Fleet outposts. This was their deepest penetration yet into Federation space and followed the same pattern as the Delta VII attack: the station was looted, stripped of any removable technology, and all of its personnel killed execution-style. This raid, the boldest yet, set off a fierce round of debate within the Federation Council that eventually resulted in even more orders and appropriations for Star Fleet.

Star Fleet was having considerable difficulty locating the "pirates" and putting an end to their vicious acts. They employed hit-and-run tactics, always fleeing the scene whenever warships arrived to engage them. No matter how many ships Star Fleet assigned to the New Territories border, it seemed that the "pirates" always found a way to slip past them. Most vexing of all was the new enemy's anonymity. Nothing was known about them except for the design of their ships and the "bird-of-prey" emblem on their undersides. Also, there was simply no comprehending the unintelligible subspace radio intercepts they were constantly monitoring in the area. They were either in code or in an alien tongue or perhaps both. Had someone thought to ask the Vulcans for help then the situation might have become more clear. That was not done. Instead, based on the available data, only one conclusion was clear to Star Fleet: the "pirates" were a well-organized and disciplined group, with a central command structure and raiders almost as powerful as some of Star Fleet's smaller warships. Such activity

might threaten the existence of Starbase 10, the newest such facility to be constructed and one of the first that would serve the New Territories. If the "pirates" could take out Starbase 10 then they could conceivably threaten the whole quadrant and perhaps even Local Group systems as well.

With this in mind Star Fleet made arrangements for two new fleets to join the forces it already had in the New Territories. On 30 November 2147 a 12-ship "black ops" fleet under the direct command of Star Fleet Intelligence quietly left for the New Territories. It was equipped with starships fitted with the latest in Federation stealth technology, weapons and drive systems, and manned by all-volunteer crews. Their mission was to go beyond the New Territories in the general area from which the "pirates" seemed to be originating and, to quote the operational order, "deal with the situation." At the same time the 159th Combat Squadron, under the command of Commodore Tonsum Han, was dispatched to the still-building Starbase 10. His orders were to keep his fleet in a constant state of readiness, prepared to defend the starbase against any attack by "outside forces." In support of these operations many of the border fleets were redeployed to new patrol areas as well.

This shake-up in Star Fleet strength in the New Territories corresponded with a marked decrease in "pirate" activity. It would cease completely by the middle of 2149. The Federation Council was confident that its actions had brought an end to the "pirate" threat. Star Fleet was complemented on dealing with "the pirate scourge," as one politician put it. There was just one problem with this rose-tinted picture. Star Fleet really hadn't done anything. It was still failing to intercept the "pirates" in time. The recent drop-off in "pirate" activity seemed to suggest that the recent fleet redeployment might have had something to do with it, but the aging combat veterans of Star Fleet weren't so sure. The new garrison fleet at Starbase 10 had encountered nothing since its arrival and already Commodore Han was itching for action. Most curious of all, Star Fleet's 12-ship "black ops" fleet had simply vanished. Like the *Chandeleur*, it was never heard from again.



TERRAN EXPLORATIONS

RIGEL VII

Rigel VII is home to an aggressive humanoid species known as the Kalar. They are thought to be the descendants of a lost Rigellian colony from ages past based on what few observations have been made of them. They have a culture approximating that of the Mongols in Terra's past, rating approximately D- on the Richter Scale of Culture. Their trust is not easily earned and they are highly belligerent, preferring to attack first and reason later. They have no concept of any worlds or technology beyond their own and are quite content to remain in their primitive lifestyle. For these reasons Rigel VII is generally avoided by most interstellar visitors to the Beta Orionis system, save in emergency or at great need.



Typical Kalar male in traditional costume

REPRODUCED FROM *THE WORLDS OF THE FEDERATION*
BOOK AND ARTWORK BY SHANE JOHNSON

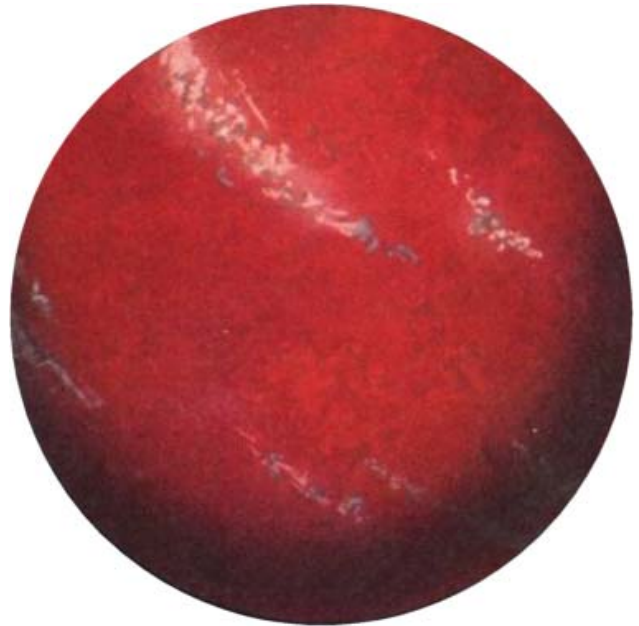

SPECIFICATIONS:

System star: Beta Orionis (*Rigel*)

Distance from system star 200 million km
Period of revolution (Terran measure) 14.6 hours
Period of orbit (Terran measure) 552 days
Mass 8×10^{24} kg
Diameter 5886 km
Axial inclination 31°
Average surface temperature 12°C

Satellites one (*Sky Rock*)
Planetary Richter Scale rating D-
Level of technology primitive

Indigenous culture(s) Kalar
(homo vulcanis rigelā)
Additional culture(s) none

Major surface features:
none

Places of note:
none

ORION

Orion (*Rigel VIII*) is unique in that it is the only Class M planet with a major ring system in all of known space. It is but one of six inhabitable planets out of thirteen (Classes J and M) in the Beta Orionis system. This quadruple star cluster has the most habitable worlds of any system yet charted.

The Rigel system is naturally shielded from the intense radiation of Beta Orionis by the Hakel radiation belt. This is an intense magnetic field, similar to Terra's Van Allen belts, that extends outward to a distance of about 80 AU from its star. This belt also accounts for the unusual number of habitable planets despite their distances from the system primary, Beta Orionis.

Orion was first visited almost 20,000 years ago (Terran old calendar) by a Rigellian named Murak Tan. The Rigellians are a Vulcan-like species from Rigel V and are believed to be descendants from the Vulcan Diaspora. Murak Tan quickly discovered Orion's native green-skinned humanoid species and their highly alluring females. He forcibly abducted three of the women and put them up for sale to the highest bidder at his next stop. Other interstellar traders promptly descended on Orion for more, setting up their own colonies and settlements as they fought for the rights to for the new Orion slave trade. Murak Tan's people, horrified by his actions, promptly forbade the Orion slave trade on their own world. This did not stop the legend of Orion female slaves from spreading across the quadrant. The civilization of Orion was forever destroyed as it reoriented itself around its one marketable commodity and descended into other criminal vices. They set up the largest intergalactic crime cartel in space over the years, as well as colonizing the two planets of Rigel's secondary star. Oddly enough, though, the people of Orion continue to hold the Rigellians in awe and respect for passing on one of the greatest profit-making opportunities in recorded galactic history.

Orion is a neutral world, having no allegiance to the Federation or any other nearby interstellar power. Its neutrality is an excuse for all kinds of covert and illegal activities, such as crime syndicates and interstellar piracy. This is normally tolerated by the Federation, so long as it doesn't get out of hand (as in the Coridan Affair) for two reasons. First, it provides a necessary vent for such activities that are restricted or outlawed elsewhere in the Federation. Second, it provides a clandestine means of contact and trade with species and powers with whom the Federation would otherwise officially have no contact. While Star Fleet itself is barred from Orion, encountering off-duty and undercover Star Fleet personnel is not uncommon.

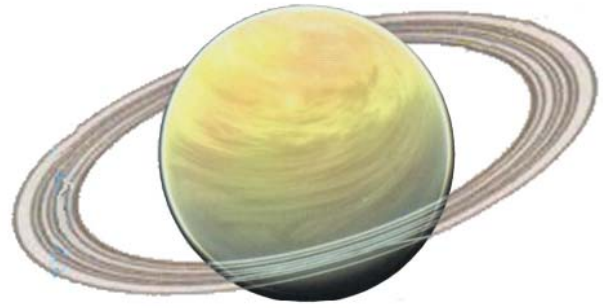

SPECIFICATIONS:

System star: Beta Orionis (*Rigel*)

Distance from system star 275 million km
Period of revolution (Terran measure) 18 hours
Period of orbit (Terran measure) 487 days
Mass 2×10^{24} kg
Diameter 4472 km
Axial inclination 23°
Average surface temperature 15°C

Satellites none
Planetary Richter Scale rating M
Level of technology current

Indigenous culture(s) Orion
(homo orionis)
Additional culture(s) various

Major surface features:
None; however, it is the only ringed Class M world in all of known space

Places of note:
Rralrark (main trading colony)

The Orions were also responsible for the only recorded "conquest" in all of Vulcan history. In 22 BC (Vulcan Calendar 139954) an Orion pirate fleet landed on Vulcan and attempted to loot the planet. They were eventually driven off; however, this first contact would have a profound impact on early Vulcan society and eventually lead to their pre-Surak warlike culture.

Thriving human colonies exist on Rigel II and IV. Rigel V, the homeworld of the Rigellians, is a longtime member of the Federation. Rigel VI is the trade hub of the system, and Rigel XII has one of the richest dilithium deposits in the quadrant.

HISTORICAL ARTICLES

AN OLD MAN ON A NEW WORLD

UNS NEWSWIRE – 12 JUNE 2103



The planet Mars evokes strong images in human fiction. Canals, buried cities, and giant war machines sent to invade Earth. Part of that fantasy became fact today when the atmosphere of Mars finally became breathable after decades of hard work.

“It’s a miracle,” noted Martian citizen Georges Picard. “Absolutely amazing. I’m glad I lived long enough to see this day.” Picard is the last of the original colonists of Mars, having come from Earth aboard the *Martian Genesis* in 1989. The 121-year old Picard still walks the hills and valleys in which he played as little boy, only now he doesn’t have to wear a pressure suit. We met with him at the *Martian Genesis* Retreat, a secluded park and commune complex that has grown up around the old colony ship. Picard’s hand played across the old ship’s pitted metal as he spoke.

“We came here to build a new world,” he says, his voice rasping with age. “We built one, by God. Crop failures, starvation, loss of supplies during the wars – they didn’t stop us. You see that over there?” he says, pointing to a monstrous construct at the edge of the retreat. “Atmospheric Processing Station Number One. They built it there when the others came, the ones that made the Colonies. Said they were going to fix the air so we could breathe it. I didn’t believe them at the time; however,” he says, taking in a deep lungful of air, “this is wonderful. Truly wonderful.”

Picard is considered Mars’ greatest living treasure. He is Mars history personified, an elderly yet spry man who now spends his days making his rounds of the Martian Colonies, welcomed by all and telling his tales to anyone who will listen, as did we. As for his secret for living so long? “I did everything wrong. Smoked, drank, ate all the wrong foods, and had *lots* and *lots* of sex. Let those health quacks back on Earth figure that one out! (laughs).”

ONE PLANET, ONE GOVERNMENT

ANTHONY EDWARD FORSYTHE

FIRST PRESIDENT OF THE UNITED EARTH GOVERNMENT

SELECTED EXCERPTS, SPEECH TO THE FIRST UEG ASSEMBLY

1 MAY 2113



Today marks the dawn of a new age on this planet, a world that up until now had been enslaved to nationalism and religious strife. A world that almost died twice in the two greatest wars mankind has ever seen: one against ourselves and one against a power from beyond the stars. A world that arose from the devastation of both conflicts and built itself anew, shedding the strife and contentiousness that have for so long kept our peoples apart. Today marks the dawn of the United Earth.

We thank our new allies from Vulcan for allowing us to come to this moment by ourselves. We know it was not an easy thing for you to do, sitting back with a logical solution to all our woes in your hand while we strove to seek our own path. Perhaps this is why our cultures work so well together. We are point and counterpoint, yin and yang, the rational and the emotional. You saw the way to where we are today, yet you were wise enough to let us feel the path too it, as a man in a dark room seeks the light. For that we thank you and hold ourselves in your debt.

Humanity has now put all of the woes that once afflicted it in the past. There is no war, no raging diseases, no rampant poverty. The worth of each individual, no how individual they may be, is recognized and honored. For this we can thank our forefathers, who in their wisdom recognized man’s need to conquer the stars and who set out to accomplish that goal. Their foresight saved us from ruin, brought us new friends, and led us to realize that our place in the universe is unique. We do not intend to cast aside that trust lightly. This United Earth Government is committed to ensure both man’s survival and his destiny in the Eternal Sea of Stars.

WELCOME TO THE FEDERATION

STELLAR BUSINESS JOURNAL – 08 MAY 2127



“Reaching For the Future” – painting by Ron Nixon (2127)

Today on the planet Babel and by unanimous consent the delegates of the major Local Group systems, their space colonies, and their allies ratified the Articles of Federation, creating the United Federation of Planets. This new organization replaces the old Coalition of Planets as the major governing body in this part of space.

There are major differences between the old Coalition and the new Federation. Before, the Coalition was a loose organization, concerned primarily with trade disputes and the occasional interstellar war. The Federation is organized along federal lines similar to those of the former New United Nations. It governs by representative democracy through the parliamentary system, as represented by the Federation Council. The executive is represented by office of the Federation President, the senior member of the Council, and the judicial by the Federation Worlds Court. All member worlds will be pooling their resources to come up with a common system of goods and exchange, trade and tariff regulations, and of course taxes. One must have a source of revenue to keep the new Federation running, after all.

One of the first jobs of the new Federation will be to organize its new Federation Star Fleet. The Terran Star Fleet, along with the fleets of all other Federation members, are to be disbanded and pooled for its first ship roster. The new Star Fleet will use these old ship until it can start building new ones of its own. In order that law and order do not break down in the process each member system is being allowed to keep small local fleets for law enforcement duties. Just how long this transition period will last is anyone's guess.

DYSON-YOYODYNE CHANGES MARKETS

A LETTER TO OUR CUSTOMERS – AUGUST 2130



“The End of an Era” – digital art by Andy Lodge (2130)

We at Dyson-Yoyodyne want to express our gratitude to the millions of customers who have supported us over the decades. We want to let you know from us that the rumors about our company going out of business are completely unfounded. What is about to happen is that our company is changing direction.

As many of you know Dyson-Yoyodyne is no longer the Solar System's lead manufacturer of starships. We have had troubled financial times in recent years because of this. It was only with your help and support that we were able to get back on our feet and re-enter the commercial market. Unfortunately our new line of ships have not sold as well as we had hoped. While our company is still making a profit, it has become clear to us that we can no longer compete in today's starship market. To do so would drive our company into a second bankruptcy, one from which we may never recover.

We do not want to betray the trust you have place in our leadership. That is why, after careful consideration, we have decided to focus our efforts exclusively on the new market of classic starships. This is the era in which we made our mark. By doing this we can remain a vibrant company and continue to support all of you who have supported us. By joining the classic starship market we can bring our company resources and technical expertise to bear on systems and technology that other manufacturers will no longer touch. By supporting the starships of the past we can keep our customers of the present and add more in the future.

This is exciting new ground for us. Already we have seen phenomenal sales of re-releases of two of our past classic starships, the DY-245 Mark II and the DY-500 Mark III. We are looking to re-release a third; however, we want YOU to choose it. All you have to do is visit our company website at syn.dysonyoyodyne.corp and pick from the list. The classic DY-series design that gets the most votes by December 31 will be the next released.

STARBASE 1 BEGINS OPERATIONS

UFP INFONET – 8 JULY 2141

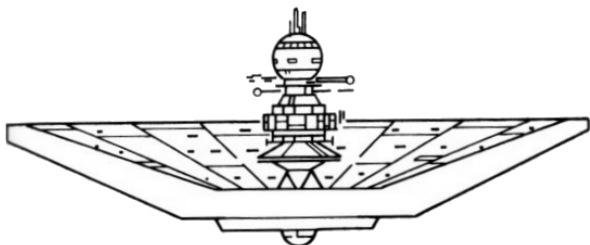

The original Starbase 1 (artist's conception)

The next step in the buildup of Star Fleet continues. Starbase 1 the first in a planned series of major space bases being built at strategic locations within the Federation, was officially commissioned today in a ceremony attended by Federation president Harmon Axelrod. Starbase 1 commanding officer "Felix" P'Jindik, a former commodore in the Tellarite Space Fleet, gave President Axelrod a full tour of the new facility.

Starbase 1 is an original design built into the bowl of a hollowed-out asteroid. It has extensive starship repair and maintenance facilities located along the inner surface of this "bowl." Rising from its center is a massive command tower, housing its operations, medical, and research facilities. At the base of the bowl is the largest small craft hangar yet built in the Federation, with room enough to house ships of all kinds ranging in size from a sub-light shuttle all the way to a Class J transport with a full load of cargo pods. Station defense has not been ignored, either, with a plethora of laser turrets and fusion torpedo launchers on both sides of the "bowl" and on the upperworks of the command tower. Starbase 1 also comes equipped with its own garrison fleet, in addition to the other Star Fleet and civilian vessels it will be servicing.

Starbase 1 was built in orbit around an as-yet unnamed Class M planet that is at the exact center of the new Federation star charting system. New starbases will be built at the rate of one to two per year at strategic locations along the 3D "grid" of that system. Starbase 2 the next in the series, is already building and should be complete by early next year. It has quite a different design than Starbase 1 and no two of these early starbases are exactly alike. The story is that this was a political move designed to evenly spread out starbase construction among the various Federation members and willing associates. Star Fleet is currently evaluating plans for standardized starbases once this initial series is completed.

SPACE WAR GAMES DISASTER

UFP INFONET – 14 SEPTEMBER 2141



Tragedy unfolded at the Terran-Centaurean war games exercises today, leaving 232 crewmen dead. The *USS Scythe*, a Terran *Verne* class cruiser, was accidentally given the wrong navigational coordinates during a live fire exercise. The ship promptly collided with the Centaurean cruiser *Atlantia*, jamming its fire control systems. The lasers from the *Scythe* cut through the destroyers *Hammer* and *Enmity*, destroying both ships and killing everyone on board. Star Fleet has halted the war games while a full investigation is made into the collision.

WELCOME TO STAR FLEET ACADEMY

REAR ADMIRAL STAVROS NIARCHOS, COMMANDANT

19 SEPTEMBER 2143

I want to welcome each and every one of you from your various worlds to this – the very first class of officers in Star Fleet Academy. I am honored to be in the presence of such distinguished candidates today.

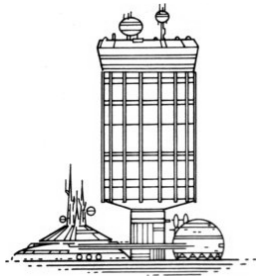

Those of you assembled here, from every species both member and associate of the Federation, male and female, young and old, represent the future of Star Fleet. What you learn here and how you apply it will, in a very real sense, shape and mold what Star Fleet becomes. This is an important responsibility and one you should not take lightly. I for one do not take mine lightly. It is my responsibility to guide you along this path that none of us have trod before. You can rest assured that I will expect no less of you than what I would expect of myself. Anything less will not do.

Within these newly built halls you will learn many things. You will learn the basics of starship engineering, celestial navigation, subspace communications, and space combat tactics. You will be given a college level education in the sciences and liberal arts. You will study the cultures and histories of the worlds of your fellow students. You will also be given a firm foundation in justice and the law, since the preserving of peace and order will be among your highest of duties. Most importantly, though, you will be taught the difficult skill of command. This will be the hardest part of your training, harder than the physical regimen you must endure, harder than the academic exercises you will have to perform. The skill of command and the enforcement of discipline within the military is the hardest thing for an officer to master. Most of you will have what it takes to meet this challenge. Some of you will not. You must learn how to command your subordinates, to earn their trust while remaining aloof from them; otherwise, you have no business being an officer. Any of you who are found lacking in the skill of command will be dismissed from this Academy. On that you have my solemn pledge.

The recent war games disaster has demonstrated the need for seasoned and competent officers who share common training. You will be the first of that generation. You will be held to a higher standard as a result. Those of you who graduate will share the same knowledge, the same skills, the same ability to command. As you continue to serve with Star Fleet and rise through the ranks, so will Star Fleet rise with you. While there will always be room for personal initiative, you must achieve it within that common framework that all of you who graduate will share. You are our future. We are counting on you to make that future succeed.

STARSHIP *ATLAS* LOST WITHOUT TRACE IN NEW TERRITORIES

UFP INFONET – 17 NOVEMBER 2144



The wreck of the *Atlas* (artist's sketch)

The transport ship *Atlas* has failed to return from a routine supply run to Federation colonies in the New Territories. Star Fleet has initiated an extensive search of the area where the *Atlas* would have made the last leg of its journey. Its fate and that of its crew remains a mystery.

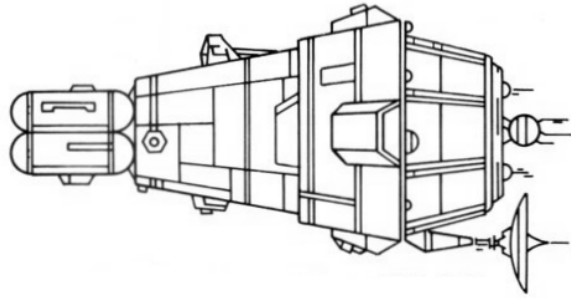

VANGUARD CLASS TRANSPORT
(2144)

Length: 260 m Drive: warp drive
Mass: 25,000 DWT Range: interstellar
Armament: lasers Crew: 94

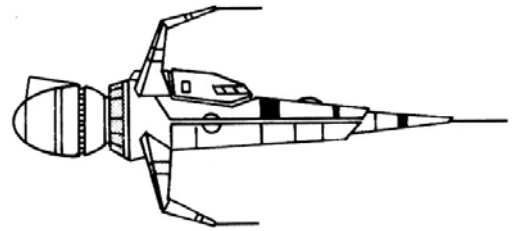

GALLANT & ARROW SERIES STARFIGHTERS
(2148)

Length: 30 m Drive: CDP generator
Mass: 70 DWT Range: interstellar
Armament: lasers, torpedoes Crew: 1-2

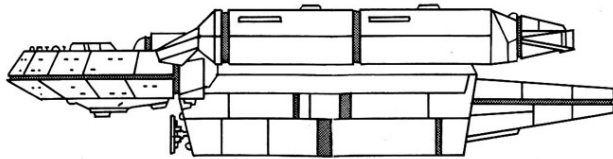

HORIZON CLASS SURVEY CRUISER
(2146)

Length: 280 m Drive: warp drive
Mass: 38,500 DWT Range: interstellar
Armament: lasers, torpedoes, Crew: 224
 particle beam cannon

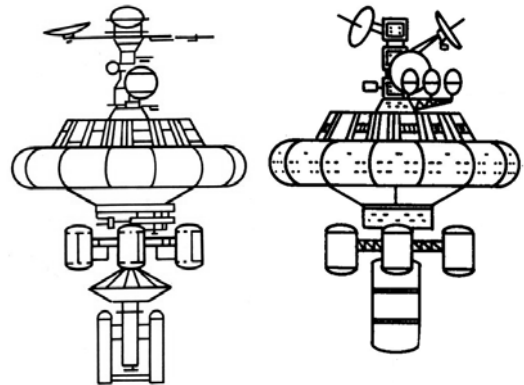

HOPKINS CLASS HOSPITAL SHIP (TYPES A & B)
(2148)

Length: 238 m Drive: warp drive
Mass: 90,000 DWT Range: interstellar
Armament: lasers Crew: 25-130
 (depending on configuration)

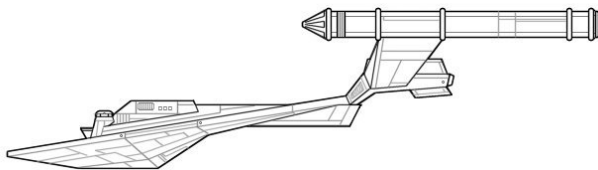

ARMSTRONG CLASS HEAVY CRUISER
(2147)

Length: 207 m Drive: warp drive
Mass: 38,000 DWT Range: interstellar
Armament: lasers, torpedoes, Crew: 175
 particle beam cannon

MANTA CLASS SPACE TANK
(2150)

Length: 61 m
Mass: 3050 DWT
Armament: lasers, missiles,
particle beam cannon
Drive: warp drive
Range: interstellar
Crew: 10





A glimpse of some of the worlds of the Rigel system

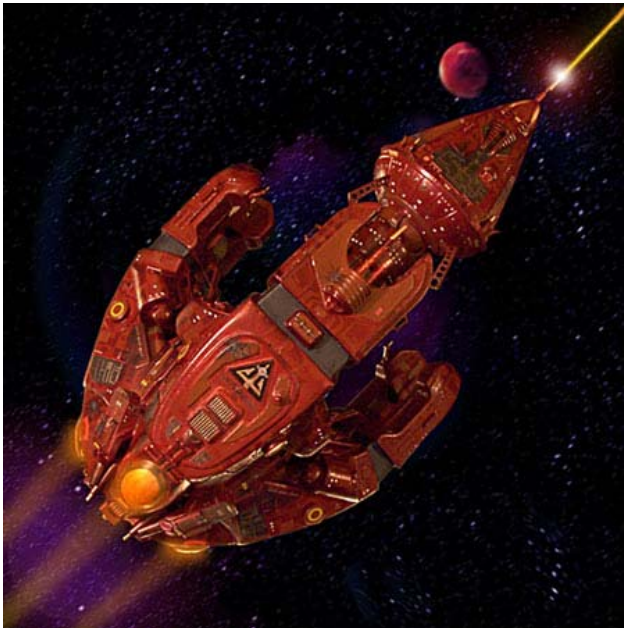

Orion raider (c.2130)



Romulus and Remus – Romii star system



Trading run to Tellar Prime



Classic Starships magazine – premiere issue (March 2120)

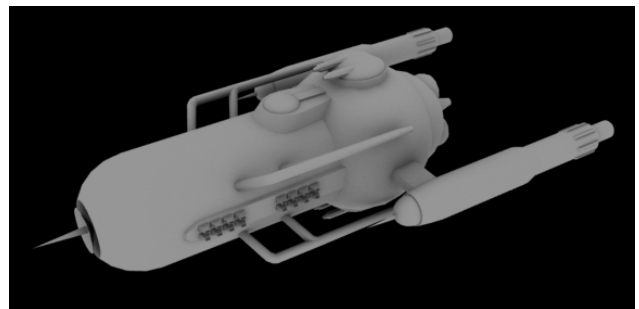

Dyson-Yoyodyne's unbuilt DY-1300 military cruiser

to be continued ...

ACKNOWLEDGEMENTS

VOLUME SIX: 2101-2150

AUTHOR'S COMMENTS:

A lot of you have asked about the artwork I've been including with each successive issue of the FSC. Some of you are laughing at my in-jokes, while others want to know where they can get their own copies. Many of these are "placeholder" images pulled from various space art Internet sites, intended to fill in for *STAR TREK* conceptual art that simply doesn't exist. That was one of the major drawbacks of Timo's otherwise excellent work *A Hobbyist's Guide to the UFP Starfleet*. You had no way to visualize what he was talking about. At least this way I can plant ideas in your head while at the same time making the FSC a more enjoyable read. As for the rest, I get them from *TREK* image and videogame archives all over the Internet. I just stick the subject I want to visualize into Google and usually add the word *image, gallery, art*, or something like that on the end and let it rip.

This is also the main reason why the FSC remains for the present a free publication. There's simply no way I could clear the legal hurdles involved with some of these images and sell it for profit. By keeping it as a public domain reference work the FSC falls under the "fair use" clause of copyright law. Leastways that's what my legal advisors told me. You see, I've been involved in several copyright actions of my own in the past. That's why I'm taking this approach. If someone objects, then I'll adapt accordingly.

I've included a revised Master Table of Contents in this issue to bring the FSC up to date with what I've done so far. It'll also give you a look ahead as to what's coming down the pike.

"So where's *ECS Horizon*?" some of you might be asking. It's not here because its existence conflicts with a ship class that's already established in fandom tech, mainly Sternbach's early Federation survey cruiser *USS Horizon*. Fandom tech holds weight here in the Prime One timeline; therefore, the *ECS Horizon* doesn't exist. The class itself might exist (as the *Roanoke* class transports per Timo's notes) but the *ECS Horizon* doesn't. Because of this I decided to err on the side of caution and not include it. If you want to know more about the *Roanoke* class then go read Timo's book, *A Hobbyist's Guide to the UFP Starfleet*. As for those of you who insist on having it here, I refer you to my timeline note about the designation of "Class J" cargo ships. My research seems to indicate that the *Roanoke* class transport would have entered service around 2105 as the first of the new-build "Class J" starships.

The *Prometheus* class ringship (*Atlas* class in the FRS site timeline) is a particularly vexing ship to try to place in any *TREK* chronology. According to the wall schematic in *Star Trek: The Motion Picture* a ringship very much like this was the first named *Enterprise*. That I have taken as Sternbach's interpretation and placed it in the era of the Earth-Kzin Wars so it can be first to build on the *Enterprise* reputation over the years. That leaves this design, the original by Jeffries, which at casual glance appears to be a somewhat evolved version of Sternbach's concept. Depending on which source you consult the Jeffries ringship enters service either just before or just after the Romulan War. I admit to swinging back and forth on the issue until one of my reviewers reminded me of the hijacking of the starliner *SS Diana*. According to the old SFC that took place before the Romulan War. While there's no obvious connection between the *Diana* and the Jeffries ringship, a casual reading of the old SFC would lead one to believe that the *Diana* was a starliner of the "*Declaration* series." It's a better case for the dating of the Jeffries ringship than any I've yet seen, so in this case I'm differing with Prime Zero (Dixon) and moving its service entry date back to before the War. It also fits better with the FRS ringship evolution as illustrated on their website. If someone can make a better case for the Jeffries ringship entering service after the War then I'm willing to listen.

FRS readers and site visitors should take note that I am using Mandel and Drexler's illustration of the Jeffries ringship from the *Star Trek Maps* instead of the *Atlas* interpretation by Aridas Sofia. That's because it's a better match for the majority of the original Jeffries production sketches. The drawing by Aridas appears to be based on a slightly alternate design Jeffries toyed with in at least three different drawings. In these a cluster of six small engines were mounted outside and behind the ring instead of a sole large engine on the inside. You can interpret his *Atlas* concept as the prototype for the *Prometheus* class, if you like. I've given you room for this interpretation by implying that most of the Jeffries ringships in civilian service had "giant" names (*Atlas, Prometheus, Paul Bunyan, Saturn*, etc.).

The *Wright* class was an attempt at addressing the appearance of the *Djartanna* at two different points in Dixon's research. Most evidence seems to support the later date; however, as the Terrans and other races were contributing to Star Fleet starship design I felt the Centaureans needed to be represented, too, and for more than just their warp engines. Hence I followed Timo's lead in creating an uprated *Djartanna* subclass. For that reason I've introduced the *Djartanna* in its original FASA lines on the first date and the uprated and reconfigured *Wright* (loosely

modeled after Timo's *Iceland* class) on the second. The *Djartanna/Wright* is part of Prime One's evolution towards the Class I heavy cruiser, so I wanted to show a *Djartanna* that was a little closer than when we first saw it back in Volume 05. My drawing of the *Wright* is horrible (as is its companion, the *Cavalry* class destroyer) and hopefully one of you will be willing enough to do a better job. The engines were borrowed from the *Durance* since that was already an accepted starship design and sharing components across classes would lower production cost. This in a small way anticipates the modular component construction programs of the *Baton Rouge* generation and the Class I Starships almost a century down the line.

The inclusion of FASA's *Armstrong* class heavy cruiser gives Star Fleet an extra "heavy" (aside from the dated *Messier* class) that it was sadly lacking in the coming Romulan War. It also gave me a chance to slip in a backhanded reference to *Enterprise*. Finally, it gives Okudaites and RPGers who are using the FSC for source material a convenient "hook" for patching the NX-01 *Enterprise* into the FSC (despite its glaring technical inconsistencies – Warp 5 in a Warp 3 era, for one). In that scenario the NX-01 would be the "logical" successor to the *Armstrong*, replacing the extra 15 built during the Romulan War as Star Fleet's main ship-of-the-line.

The *Armstrong* is yet another step in Prime One's evolution towards everybody's favorite starship. Of course we all know what comes next. The *Daedalus*, right? Not exactly. There's an interim design that all but us "old school" *TREK* techies have probably forgotten. Your memory will be refreshed once the Romulan War issue is released. I've dropped you a couple of hints, though, and the more discerning among you should be able to figure out what it is. Stay tuned.

Have you ever noticed that Goldstein and Sternbach's "mystery space probe" from the SFC, the one that flew into Federation space from outside the galaxy a few years before the Romulan War, looks amazingly like the Whalesong Probe from *ST IV*? That's why I linked the two together. My guess is that whoever sent the probe in the movie sent the little one first. When it never made contact (due to being intercepted while en route) its senders decided to sent a second, larger, and more powerful one that couldn't be stopped in any way, form, shape, or fashion. This second probe is the one featured in *ST IV*. The reason for the lag between the two probes is the time required for an extragalactic journey from God knows where.

I know some of you are scratching your heads at my mention of Starbase 10 being near the "New Territories" and thus within range of the "pirate" activity when Dixon, FASA and the SFC say it was Starbase 1. That's because I compared the action as described with the *Star Trek Maps*. The only starbase in the area that could have been around at the time, given the

construction rate of starbases (1-2 per year), is Starbase 10. You will also recall from the original *STAR TREK* television series (TOS) that Starbase 10 was within range of the Neutral Zone, which is exactly where the *Star Fleet Maps* puts it. That's why I changed the identity of the starbase in question. I also had to push back construction of Starbase 1 by a few years in order to adjust for this fact.

The planetary stats for Orion and Rigel VII are a wild guess based on what little I could find in my research. Odds are that they're probably wrong, too. I'd especially welcome corrections for these if you have them.

The idea for the character of elderly Martian colonist Georges Picard comes from *Star Trek: First Contact*. Captain Jean-Luc Picard mentions that one of his ancestors was among the original colonists of Mars. That would have made him a member of the *Martian Genesis* group. I envision him as a young boy at the time the ship landed on Mars; hence his age. I'm including older children among the *Martian Genesis* colonists due to its historical parallels with other frontier settlement accounts. "We wouldn't have allowed children on a colony ship!" some of you might protest. You probably wouldn't have allowed them on wagon trains to the American West or in ships heading to Australia, either, yet both happened.

I took the liberty of rewriting Commandant Niarchos' opening address to the first class of Star Fleet Academy. I attended the U.S. Naval Academy in my youth and what is in the old SFC is nothing like any speech I ever heard from the "Dant" or the "Supe" during my time there. To be honest, the SFC original is ridiculous at best.

I've had several questions regarding the *Atlas* since the initial release of this volume. The *Atlas* was not a ringship according to the FASA RPG supplement *The Romulan War*. Nowhere in this gaming supplement are ringships described, although some (Aridas Sofia in particular) have retconned ringships into the overall scheme of events. It was a Star Fleet transport hauling a cargo of neutronic fuel and cobalt tetroxides from Delta II to the Sector 5D Agricultural Colony. For this issue I have replaced my earlier photoshopped picture with one of Dana Knutson's drawings from the FASA supplement. It matches the destruction of the *Atlas* as described in the FASA materials, in particular the crew being forced to don EVA suits due to hull breaches prior to the final end.

Regards,

- Richard E. Mandel

SPECIAL THANKS TO:

Jason Boguess
FASA Corporation
Stan and Fred Goldstein
Timo Saloniemi
Aridas Sofia
Last Unicorn Games

VISUAL SOURCES:

Steve Baron
Dana Knutson
DarthMagus
Don Dixon
Feyman Federation Shipyards
Maeteen Greenway
Andrew J. Hodges
Walter M. Jeffries
Dan Knutson
Geoffery Mandel
SciFi Meshes
Gavin Pillay
"Reverend"
Aridas Sofia
Rick Sternbach
TallGuy
The Trek BBS
The SpaceArt Archive
Christian Zaber

CONTACT INFO:

Want to contribute to the *Federation Spaceflight Chronology*?
You can find me on the FRS Online or Star Fleet Network
forums. If you prefer direct contact then you can reach me at:

rtrodude@yahoo.com

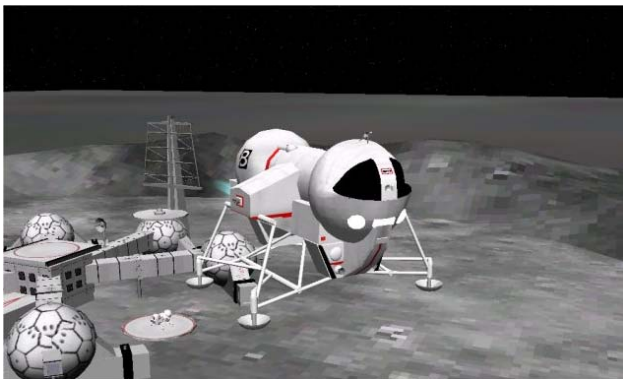

New Territores mining camp and "Bug Hopper" excursion vehicle

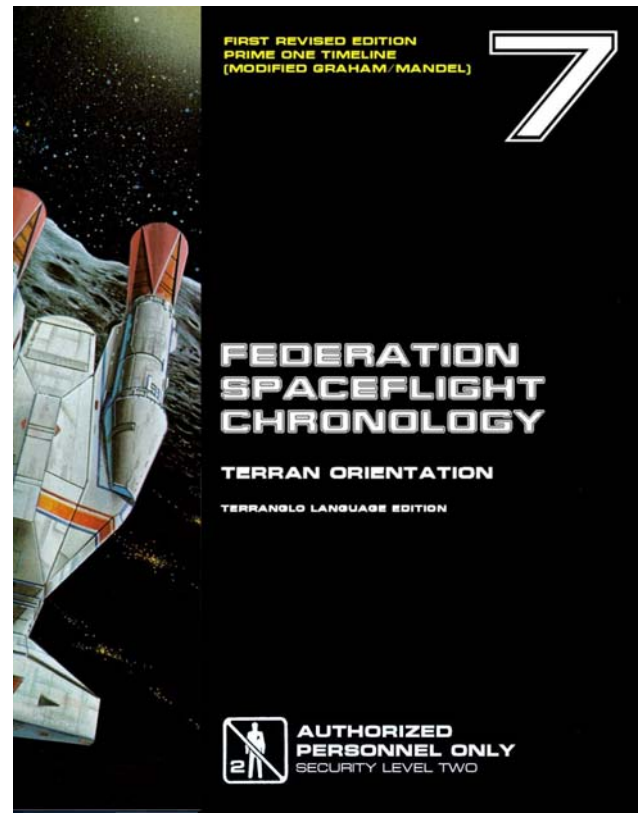

coming soon

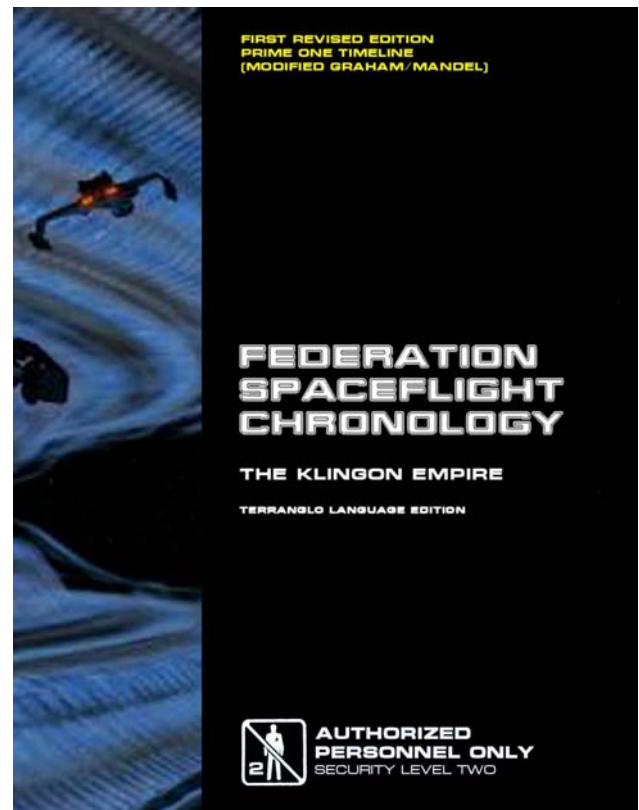

also available

