



# FEDERATION SPACEFLIGHT CHRONOLOGY

**TERRAN ORIENTATION**

**TERRANGL0 LANGUAGE EDITION**

**BY RICHARD E. MANDEL**

**FIRST REVISED EDITION  
PRIME ONE TIMELINE  
COMPILATION VERSION**

---

Original texts and manuscript concept copyright © 2007 by Richard E. Mandel

*STAR TREK*, its on-screen derivatives, and all associated materials are the property of Paramount Pictures Corporation. Multiple references in this document are given under the terms of fair use with regard to international copyright and trademark law. This is a scholarly reference work intended to explain the background and historical aspects of *STAR TREK* and its spacecraft technology and is not sponsored, approved, or authorized by Paramount Pictures and its affiliated licensees.

All visual materials included herein is protected by either implied or statutory copyright and are reproduced either with the permission of the copyright holder or under the terms of fair use as defined under current international copyright law.

All visual materials used in this work without clearance were obtained from public sources through public means and were believed to be in the public domain or available for inclusion via the fair use doctrine at the time of printing.

Cover art composited from the works of Andrew J. Hodges and Foundation Imaging

This work is dedicated to Geoffery Mandel, who started it for all of us.

Memory Alpha and SFHQ/Mastercom cataloging data:  
UFP/SFD DTA HR:217622

# FOREWARD

---

This is a free document.

No, really – it is! I mean it! I don't expect one dime in payment for this, nor should you pay anything for it. I did it for the fun of it, not to make any money. If you did pay for this, either from an online source or at some *STAR TREK* convention, then you got ripped off by some money-grubbing Trekkie or Internet bootlegger. This is totally, absolutely, 100% free with no limitations on *personal* use or distribution. That's the easy part. Here come the hard part.

I realize, given the fact that this document is designed for Internet distribution, that it can go anywhere and everywhere. I accepted that the moment I decided the Internet would be my release medium. I also accepted the fact that there will be an unscrupulous few who will look to profit off of my generosity. So, for this reason, I am establishing the following limits with regards to posting and distribution on various Internet sites and web pages – personal, commercial, or otherwise:

- 1) This document may not be posted on any site that charges a fee or requires personal information in order to gain access, either to the site itself or this document in particular.
- 2) This document may not be posted on any site that contains or distributes viruses, malware, advertising "cookies," spybots, or any other software or software tokens designed to infect or otherwise inhabit a home user's personal computer without his or her express written (not implied!) consent. So-called "click agreements" do not qualify for this clause.
- 3) You may not charge any kind of service or duplication fees (or anything along those lines) in order to distribute this document on "hard" media (such as rewritable computer media, old-fashioned paper, etc.)
- 4) I have no objections to others who want to build upon, edit, change, or in any other matter create a derivative work from this document so long as you acknowledge your source. Simply including a phrase such as "based on (or derived from) the *STAR TREK* historical research of Richard E. Mandel" or something like it is fine as far as I'm concerned. I used lots of sources in this work and I've tried to acknowledge all of them. The least you can do is show me the same courtesy.

Fair enough?

This "compact version" is the guide I will be going by as I prepare to retool my materials. I am setting aside my own ideas and preferences in order to rework the Second Edition of the *Federation Spaceflight Chronology* per the official canon timeline. Many hardcore *TREK* tech fans have taken me to task for this but I've made my decision and it is final. The timeline for this First Edition has remained the same for your sakes (per many, many requests) but expect to see changes. Several significant ones, in fact.

I realize that many of you, including those who helped in putting together the original multi-part edition of this document, may not agree with this First Edition "compact version" of my work. Please understand that I didn't get to this point without first doing a lot of research, second consulting, and third going with what seemed best and most consistent to me. That means a lot of material ended up on the cutting room floor, including material from previous editions. Furthermore, this is not meant to be the entire *Federation Spaceflight Chronology*. This is meant to be a scaled-down version, a "quickie" reference both for fans new and old as well as myself as I start work on the Second Edition. I've always regretted the fact that the last few installments of the original got away from me and ballooned up dramatically in size. Hopefully I've fixed that, plus a few other nagging issues I've had with the work as a whole. Those of you who still prefer the unedited originals, both draft and "final," can readily find them on the Web. Those of you content with this edition will be pleased to learn I've slipped in a few bonuses for you that weren't part of the original effort.

For what it's worth, I'm donating the original draft and "final" versions, as well as this First Edition version of the *Federation Spaceflight Chronology* to the *TREK* community. I always said everything from the First Version back would be yours and I meant it. Don't let the fact that I've decided to "go canon" stop you from enjoying this. It was always intended for you, the original hardcore tech followers of *TREK*, and you were the ones who helped bring it about. It's as much your work as it is mine. Be proud of what you've accomplished. I know I'm proud of you for setting aside your differences long enough to help me. Thanks. This wouldn't be what it is without you.

Richard E. Mandel  
1 July 2007

# MASTER TABLE OF CONTENTS

## FIRST REVISED EDITION – COMPILATION VERSION

---

### INTRODUCTION

---

#### 1900-2000: THE SAGA BEGINS

---

##### OVERVIEW

##### SPACECRAFT

VOSTOK  
SOYUZ  
APOLLO  
SKYLAB  
X-20 DYNOSAUR  
X-27 RAVEN  
OV-100 SPACE SHUTTLE  
DY-100 SERIES  
MARS PROBE ONE  
HEAVY LIFT VEHICLES

#### 2001-2025: BREAKING THE BONDS OF SOL

---

##### OVERVIEW

##### SPACECRAFT

SPACE FERRY II  
*STELLAR* SERIES SPACE PROBE  
*AVENTEUR* CLASS EXPLORER  
BUSSARD RAMJET COLONIZATION SHIP  
*DY-300 CLASS* PROTOTYPE  
CYCLOPS CLASS EXPLORER  
DY-500 *WHEELER* CLASS  
DY-245 CLASS

#### 2026-2050: THE ROAD TO THE STARS

---

##### OVERVIEW

##### SPACECRAFT

*GALILEO* CLASS TRANSPORT  
*ARES IV* SURVEY PROBE  
*COMPANION* CLASS ESCORT  
*COLUMBUS* CLASS EXPLORER  
DY-400 CLASS  
DY-500 CLASS (UPDATED)  
*DECLARATION* CLASS STARLINER  
*SEARCHER* CLASS SCOUT  
*MAGELLAN* CLASS SPACELINER  
DY-350 PROTOTYPE  
DY-430 CLASS

#### 2051-2065: THE EARTH-KZIN WARS

---

##### OVERVIEW

##### STARSHIPS

DY-550 SERIES  
*MAHAN* CLASS HEAVY CRUISER  
DY-X ASSAULT CRUISER  
*LIBERTY* CLASS SCOUT  
*COCHRANE* CLASS EXPLORER  
*VERNE* CLASS SURVEY CRUISER

##### ALIEN STARSHIPS

KZINTI PATROL CRUISER  
KZINTI DESTROYER

#### 2066-2100: JOINING THE LOCAL GROUP

---

##### OVERVIEW

##### TERRAN STARSHIPS

*KELDYSH* CLASS SURVEY CRUISER  
INDUSTRIAL SPACE ARK  
*CONESTOGA* CLASS COLONIZER  
*MERCHANT* CLASS EXPLORER  
*MESSIER* CLASS CRUISER  
*FRANKLIN* CLASS SCOUT  
*COSMOS* CLASS SCOUT  
DY-1000 SERIES (*EDISON* CLASS)

##### ALIEN STARSHIPS

VULCAN *SR'NARI* CLASS SURVEY CRUISER  
CENTAUREAN *DJARTANNA* CLASS CRUISER  
"EARLY" ANDORIAN *NARSH* CLASS CRUISER  
"LATE" ANDORIAN *KUMARI* CLASS CRUISER



## 2101-2150: THE BIRTH OF THE FEDERATION

---

### OVERVIEW

### STARSHIPS

*ROANOKE* CLASS TRANSPORT  
*PROMETHEUS* CLASS RINGSHIP  
DY-1200 SERIES  
*CAVALRY* CLASS DESTROYER  
*VANGUARD* CLASS TRANSPORT  
*HORIZON* CLASS SURVEY CRUISER  
*ARMSTRONG* CLASS HEAVY CRUISER  
*GALLANT* CLASS STARFIGHTER  
*HOPKINS* CLASS HOSPITAL SHIP

## 2151-2165: WAR IN THE STARS

---

### OVERVIEW

### STAR FLEET STARSHIPS

*MERCURY* CLASS SCOUT  
*DOPPLER* CLASS SCOUT  
GALACTIC SURVEY CRUISER PROPOSAL & PROTOTYPE  
*MARSHALL* CLASS DESTROYER  
*DAEDALUS* CLASS CRUISER  
*NORMANDY* CLASS STARFIGHTER  
*POWERS* CLASS SCOUT  
*U.S.S. BONAVENTURE* REBUILD

### CIVILIAN STARSHIPS

*FA-XIAN* CLASS EXPLORER  
*DEGBRAXIS* CLASS TRANSPORT  
*CLAUDIUS PTOLEMAEUS* CLASS CRUISER (DELETE)  
*ODOACER* CLASS SCOUT (DELETE)  
STAR FLEET'S CYLINDER SHIP PROGRAM

### ALIEN STARSHIPS

TELLARITE FREE TRADER *DEGBRAXIS*  
ROMULAN U-4 *CEREBUS*  
ROMULAN U-19 *CRONUS*

## 2166-2190: THE DIFFICULT DAYS

---

### OVERVIEW

### STAR FLEET STARSHIPS

*GOLIATH* CLASS BATTLE CRUISER  
*AURORA* CLASS SPACE CRUISER  
*TEXAS* CLASS LIGHT CRUISER  
*BOYDEN* CLASS AUTOMATED TRANSPORT  
*WATT* CLASS TRANSPORT  
MOBILE SPACE REFINERY  
*STELLARFORD* CLASS SPACELINER  
*PATTON* CLASS DESTROYER  
*TRIUMPH* CLASS BATTLE CRUISER

## 2191-2220: A NEW DIRECTION

---

### OVERVIEW

### STAR FLEET STARSHIPS

*MANW* CLASS SURVEY CRUISER  
*PROVIDER* CLASS TUG  
*RICKENBACKER* CLASS "FLYING FORTRESS"  
*LOWELL* CLASS SCOUT  
CR594 MOBILE CONSTRUCTION RIG  
*BERING* CLASS AUTOMATED TANKER  
*HUNTER* CLASS CORVETTE  
*BATON ROUGE* CLASS CRUISER  
*RANGER* CLASS SURVEY CRUISER  
*HALE* CLASS SCOUT  
*ANTON* CLASS CRUISER  
*BODE* CLASS SCOUT

### ALIEN STARSHIPS

KLINGON D-4 BATTLECRUISER

## 2225-2250: THE CLASS I ERA

---

### OVERVIEW

### STAR FLEET STARSHIPS

*CONSTITUTION* CLASS HEAVY CRUISER  
*SALADIN* CLASS DESTROYER & *HERMES* CLASS SCOUT  
*PTOLEMY* CLASS TRANSPORT/TUG  
*INDEPENDENCE* CLASS TRANSPORT  
*SHERMAN* CLASS CARGO DRONE  
*LARSON* CLASS DESTROYER  
*NELSON* CLASS SCOUT  
COCHRANE INDUSTRIES ONE-MAN SCOUT  
*LOKNAR* CLASS FRIGATE  
*KEARSARGE* CLASS LIGHT CRUISER  
*MIRANDA* CLASS CRUISER

### ALIEN STARSHIPS

KLINGON D-6 BATTLECRUISER

## 2251-2275: THE LINEAR REVOLUTION

---

### OVERVIEW

#### STARFLEET STARSHIPS

**FEDERATION AND STAR LEAGUE CLASS DREADNOUGHTS**  
**HOPI CLASS RESEARCH VESSEL**  
**DERF CLASS FLEET TENDER**  
**GAGARIN (GREER) CLASS CORVETTE**  
**ENTERPRISE AND TIKOPAI CLASS HEAVY CRUISERS**  
**LOTUS FLOWER CLASS FREIGHTER**  
**ANTARES CLASS FREIGHTER**  
**WHORFIN CLASS TRANSPORT**

#### ALIEN STARSHIPS

**ROMULAN U-34 "CRICKET"**  
**KLINGON D-7 BATTLECRUISER**  
**KLINGON D-8 BATTLECRUISER**

## 2276-2295: TOWARDS THE FUTURE

---

### OVERVIEW

#### STARSHIPS

**DREADNOUGHTS OF THE LINEAR WARP ERA**  
**SYDNEY CLASS TRANSPORT**  
**EXCELSIOR CLASS SPACE CONTROL SHIP**  
**MIDWAY CLASS SHUTTLECARRIER**  
**CONSTELLATION CLASS STAR CRUISER**

#### ALIEN STARSHIPS

**ROMULAN SPARROWHAWK**

## APPENDICES

---

### KEY HISTORICAL STARSHIPS

### ACKNOWLEDGEMENTS



The DY-X series starship *Leif Ericsson*, one of many storied survivors of the Earth-Kzin Wars (2049-2065). This is the same *Leif Ericsson* that was the first Terran ship to visit the planet Tellar in 2073. It is one of the oldest Terran ships still in operational condition, having been thoroughly rebuilt and modernized by its current civilian owners. It and its fellow DY-X series survivors are sometimes referenced as the DY-750 series in certain civilian publications.



A typical *Daedalus* class cruiser (c.2160)

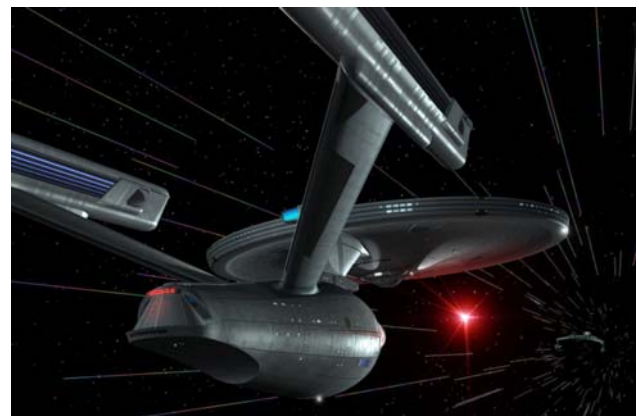

An *Enterprise* class heavy cruiser fires photon torpedoes at a Klingon battlecruiser while at warp speed (c.2180)

# INTRODUCTION

This civilian edition of Starfleet Academy's *Federation Spaceflight Chronology* is being published due to public demand. It is a compilation of historical starship data culled from the full twelve week course that is required for fourth-class cadets and cadets at the various Starfleet Academy camps throughout the Federation. This particular edition, developed by Starfleet Academy's San Francisco campus, is devoted to spacecraft development from the Terran perspective and how it ties into the evolution of Federation spacecraft over the years. This civilian version of the *Federation Spaceflight Chronology* is being made available for public distribution. Copies can be purchased through all of the normal civilian venues. For those of you who prefer the full 16-volume Starfleet Academy classroom version of the *Federation Spaceflight Chronology*, you can purchase it (in whole or in part) by the normal means through the Starfleet Academy Exchange, Training Office, Course Materials Section.

I was surprised when my office was inundated by thousands of civilian requests for copies of the *Federation Spaceflight Chronology* course material. Nevertheless one of Starfleet's duties is to serve the Federation public, and the Academy has no less a responsibility than Starfleet at large. To that end I and my staff have worked together to develop this civilian version tailored to the desires of this work's newfound audience. Many of your suggestions have been incorporated and are reflected herein. The overall driving request was for a single-volume work devoted exclusively to historical starships. The civilian version of this work reflects that desire, eliminating all of the contextual historical side materials used in the actual Academy course. This hopefully results in the shorter, terser work that most of you wanted. An added bonus for you is the inclusion of several starship data sections that are normally presented in supplemental materials handed out in class.

I speak on behalf of the whole of the Terran campus of Starfleet Academy in saying that I am glad we can serve the public in this way. We are pleased by your interest in and support of our educational efforts. It is our goal that our cadets here at the San Francisco Academy are not only among Starfleet's finest, but *are* the finest. The *Federation Spaceflight Chronology* is but one block in laying that foundation. By sharing it with you in this manner, we hope you too will gain something of an insight into the depths of "spot" knowledge required by a Starfleet officer at any given time.

CPTN Winchell Vanderbilt  
Starfleet Academy Training Office



Wernher von Braun (c.1970)



Zefram Cochrane (c.2150)



Artist's rendering of Federation Councilor Abraham Dannon delivering his famous "Sighted Man of Peace" speech near the end of the Romulan War (2162)

# **20<sup>th</sup> CENTURY**

---

## **The Space Age (1901-2000)**

# 1900-2000: The Saga Begins



The Earth is the cradle of humanity, yet mankind cannot stay in that cradle forever.

- Konstantin Tsiolkovsky (1903)

It is sometimes difficult for Terran cadets to grasp the fact that almost three centuries ago their ancestors were only thinking about powered flight. Today the concept of flight is taken for granted. Mankind flies in his atmosphere without a second thought and trips to the stars are commonplace. At the beginning of Terra's 20<sup>th</sup> century, however, the dream of flight was still very much that: just a dream. It was a myth as old as mankind himself, hearkening back to the ancient legend of Daedalus the craftsman fashioning wings for himself and his son Icarus out of feathers and wax. Humanity is known for its dreams. It is also known for having the knack of turning its dreams into reality.

When two American bicycle shop owners, Orville and Wilbur Wright, left their shop in Ohio for the sandy beaches of Kitty Hawk, North Carolina at the end of 1903 to test something called an *airplane* little did they know how their creation of fabric and wood was

about to change the history of mankind. The Age of Flight began with the Wright Brothers and the first successful flight of their frail little airplane. The Space Age, a direct offshoot of the Age of Flight, was about to get underway in a mere four decades. In 1944 the Nazi German government successfully test-fired the A-4 missile, later known infamously by its official military designation of V-2. It was humanity's first true rocket in the modern sense. The success of the V-2 rocket rested on the pioneering research of three different men in three different countries:

Konstantin Tsiolkovsky of Russia, Robert Goddard of the United States, and Hermann Oberth of Germany. These three men are the godfathers of the early Terran space program. Its midwife was German scientist Werhner von Braun, who designed the V-2, and after World

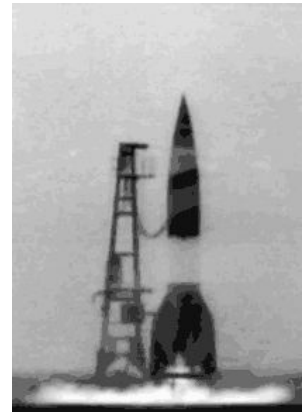

War II would go on to become the chief architect of the early American space program. Often ridiculed by their peers and scorned as impractical dreamers in their day, nevertheless these four brilliant scientists devised the basic theories and technology upon which most of the Terran space effort of the 20<sup>th</sup> century was based. Without them there would have been no Sputnik, no Vostok, no Gemini or Apollo. America would not have put a man on the moon by 1969 (Terran Old Calendar), nor would the Russians have pioneered the Terran space station, nor would have such revolutionary technologies as the reusable space shuttle and heavy lift vehicle been developed. Without these four men there would have been no Terran space program for decades.

The 20<sup>th</sup> century was a turbulent time, marked from start to finish by global tensions, political and social unrest, and unprecedented breakthroughs in science and technology. It was one of those rare times in human history when the entire planet went through a

paradigm shift in both lifestyle and philosophy. Two world wars and dozens of smaller ones had a lot to do with that, forcing mankind to up his level of technology again and again in rapid succession. Things that were thought impossible at the beginning of the 20<sup>th</sup> century, such as computers, became an inexpensive commodity by its end. So it was with the Terran space effort. The visions of the early pioneers in the 1920s and 30s were surpassed beyond their wildest imaginations before the century reached its end.

---

As with any planetary culture's space program rocket technology paved the way for the rest that would follow. The early efforts of the Germans, which arrived too late near the end of World War II to make their side any difference in the outcome, were capture and eagerly studied by the victorious Americans and Russians. The Russians were on the scene first and got most of the technology and notes. The Americans got the real prize, however. They got Werhner von Braun and his associates. So the official story goes. Whatever else they got, or was possibly spirited away before they could seize it (such as the long-rumored Vrill Program) has never been officially disclosed.

The Russians were first in overcoming almost every major hurdle at the start of the Terran Space Age. They put the first artificial satellite in orbit (*Sputnik 1*), they put the first man in space (Yuri Gagarin), the first woman in space (Valentina Tereshkova), launched the first multi-occupant spacecraft (Voshkod), and built Terra's first operational space station (Salyut). It was around this point; however, that the Russian space program failed them. At the risk of oversimplifying a complex issue their program had simply become too complicated for its own good. A string of calamities



and launch failures over a decade finally resulted in the spectacular catastrophe that was the N-1 manned moon rocket launch test. The resulting explosion not only destroyed the rocket but took out its service gantry and most of the launch complex as well. Successive attempts resulted in equally spectacular explosions. It was at this point that the Russian government finally stepped in and put a temporary halt to the ambitions of Russian space scientists. Not that it mattered by this point anyway, they told their disheartened comrades. The Americans had already beaten them to the moon the year before.

---

The Americans had started late and a full year behind the Russians insofar as space technology was concerned. Nevertheless they plowed into the fray with all of the gusto and bravado for which their country was known. American President John F. Kennedy, a charismatic politician and a skilled leader to boot (a rare combination), had challenged his people to help their country build a space program that would “put a man on the moon by the end of the decade.” His words still carry weight even today: “We do this thing not because it is easy, but because it is hard.” He knew that the Americans had the skill, ingenuity, and resources to catch and pass the Russians in the great race to space. Kennedy would not live to see his dream, being slain by an assassin's bullet in 1963; however, the space agency that he founded would make sure his dream became reality. That was NASA, the National Aeronautics and Space Administration and the direct ancestor of UESPA. By the mid 1960s they had successfully duplicated almost every one of the Russian space triumphs. In 1968 they beat the Russians to the moon with the *Apollo* program. The first man to set foot on Luna, the Terran moon, was NASA astronaut Neil Armstrong. Six more missions would follow in the years to come. It was only the beginning of humanity's leap into space.





---

The biggest problem in getting mankind to the stars was the cost. It was expensive sending up large, one-way rockets that could never be used again. A reusable spacecraft would lessen the costs considerably. Other fanciful dreams such as orbital elevators and tethered satellites were batted around for years. In the end the reusable spacecraft would prove to be the most practical and cost effective approach as far as humanity was concerned. The Americans led in this effort this time around with their OV-100 *Enterprise* class space shuttles, with the Russians playing a close second with their own Buran program. They left the rockets to the Europeans and forged ahead with more advanced technologies. The Russians had pioneered space station technology and were the acknowledged leaders in the field; so naturally they were in charge of the StarLab program. It was the first space station to be built by a joint effort of spacegoing nations, and the first of many such programs on Terra.

It should come as no surprise that with all of the government activity in space commercial industry and private sector efforts wanted their slice of the pie as well. The privately

financed *Conestoga One* rocket program was the first such successful effort, followed shortly thereafter by the Allen-Rutan effort *Spaceship*



*One*. The latter was the first privately built reusable spacecraft, on a smaller scale than but in the same vein as the more expensive NASA space shuttle. These ventures were small, however, compared with commercial ventures. It was largely the backing of private corporations that helped fund the construction of NASA's Goddard Moonbase. Their involvement was purely selfish: zero-gee manufacturing techniques could produce a highly profitable return back on Earth. The same was true for the various planetary satellite networks that provided communications and cheap power on a global scale. Finally, their funding of efforts to explore the

inner asteroid belt of the Sol System would bring them financial windfalls the likes of which had not been seen since the petroleum boom days of the turn of the century.

---

There was also another reason for man to make the move into space. He was not alone in the universe. The fact that other intelligent species existed on other worlds



was perhaps the best-kept secret of the governments of Terra in the 20<sup>th</sup> century. They consistently refused to divulge this information, despite the efforts of such leading scientists as Dr. Hogan Richman, simply for the fear of the impact that such knowledge would have on humanity. The Brookings Report, commissioned by the American government during the Cold War era, had determined that humanity's most probable reaction to a real alien encounter would be worldwide culture shock. Similar studies by the Russian KGB and Britain's U.N.I.T. had come to the same conclusion. Each



national government set up one or more secret agencies to collect and collate data on possible and potential alien contacts. Oftentimes even the political leaders of these nations were kept in the dark as to the true nature and extent of such agencies. Their overall plan was to slowly disseminate the knowledge that mankind was not alone in the universe as one might slowly cook a good meal. Too much knowledge too soon and mankind might go into a cultural tailspin from which it might never recover. Too little too late and mankind would not be ready for the day when First Contact would inevitably happen ... and it already *had*, at least in officially classified form. Terran leaders desperately wanted their world to be a spacefaring one by the time true First Contact was established. At least then they would be in a better position to bargain and establish something approaching normal relations with their new neighbors in the universe.

---

By the end of the millennium and despite the brief horror of the Eugenics Wars mankind was about to enter what would seem to be a new Golden Age. Due to the technology developed in the colonization of the Moon and Mars the standard of living went up radically over all of Terra. An agricultural renaissance was about to take place in outer space the likes of which had not been seen on Terra in many lifetimes. Cheap electrical power, in the form of beamed microwave from orbiting space satellites, would eventually account for more than 75% of Earth's power needs. Thus, two of the largest problems facing the people of Earth would be solved overnight. Public support for exploration and utilization of space would never be higher. The future of Man was assured ... or so it seemed.

---



Gerald K. O'Neill, author of *The High Frontier* (1975)



Earth orbital rendezvous (1998)

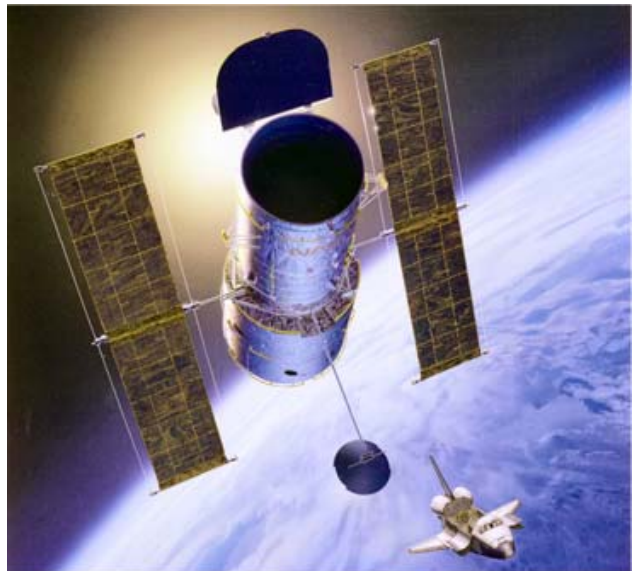

Hubble Space Telescope (c.1990)



# SPACESHIPS

---

## VOSTOK

---

**SERVICE ENTRY DATE (OLD CALENDAR): 1961**

*Vostok 1* was the first successful manned Terran space vehicle. It carried a crew of one human, Russian cosmonaut Yuri Gagarin, orbiting the Earth in a little under two hours before parachuting back to Earth. Its successful launch and recovery was another first for the Russian space program, keeping them well ahead of American progress at the time. *Vostok IV* carried Terra's first woman into space, Russian cosmonaut Valentina Tereshkova. The design would be quickly phased out of service once the larger and more rugged Vokshod spacecraft became available.

---

### SPECIFICATIONS:

Length:	4.55 m
Diameter:	2.43 m
Displacement:	4.93 DWT
Crew:	1
Range:	10 days at maximum life support capacity

Apogee:	302.3 km above sea level
Perigee:	176.3 km above sea level
Flight duration:	1 full orbit

Innovations/Experiments:

- Conducted audiovisual communications with Earth

---

### VISUAL:



## SOYUZ

---

**SERVICE ENTRY DATE (OLD CALENDAR): 1967**

Perhaps the most outstanding success of the early Russian space program other than their space stations was this three man orbital spacecraft. It was in service longer than any other pre-UESPA Terran spacecraft. Some were even being flown by private Russian firms after the turn of the millennia. The design was proven and durable, with a long history of reliability and accomplishment. There were even two versions designed for travel to Luna, although they never saw official service. Soyuz held the Terran record for longest space flight duration (425 hours) until the debut of the various space shuttle programs.

---

### SPECIFICATIONS:

Length:	7.48 m
Diameter:	2.72 m
Displacement:	7.22 DWT
Crew:	3
Range:	18 days at maximum life support capacity

Apogee:	224.0 km above sea level
Perigee:	204.0 km above sea level
Flight duration:	limited by available supplies

Innovations/Experiments:

- First three occupant Terran spacecraft
- Most reliable Terran pre-fusion manned spacecraft

---

### VISUAL:



# APOLLO

**SERVICE ENTRY DATE (OLD CALENDAR): 1968**

Soyuz's counterpart in the United States space program was Apollo, a multistage long-range three-person spacecraft. That was also the primary difference between the two. Soyuz was optimized for Earthspace operations, while Apollo was designed to fly its crew on a round trip to Luna and back. When NASA's initial lunar exploration program ended in the 1970s then so did Apollo, making any fair comparison with Soyuz difficult at best.

The primary Apollo spacecraft consisted of the three-person command module and a larger service module that held the main rocket motor, fuel, and life support systems. This service module was jettisoned prior to re-entry in Terra's atmosphere. Apollo moon missions also included a two-person Lunar Excursion Module (LEM, not pictured) with which the main Apollo craft would dock prior to the trip to Luna.

## SPECIFICATIONS:

Length:	10.77 m
Diameter:	3.91 m
Displacement:	29.5 DWT
Crew:	3
Range:	12 days at maximum life support capacity

Distance traveled:	402,576 km (from Earth to Luna)
Flight duration:	8-10 days (average)

Innovations/Experiments:

- First manned Terran craft to leave orbit (Apollo 8)
- First successful touchdown and exploration of surface of Luna, Terra's moon (Apollo 11)
- Discovery of first known Slaver stasis box (Apollo 18)

## VISUAL:



# SKYLAB

**SERVICE ENTRY DATE (OLD CALENDAR): 1973**

Skylab was NASA's first space station and Terra's first orbiting space laboratory. As such it is usually regarded as the true ancestor of StarLab even though the Russian Salyut space station was first in orbit. The intent of Skylab was to study the effects of long-term weightlessness and enforced "cabin fever" on astronauts in preparation for NASA's planned trip to Mars. The Russians took the hint and sent up a new Salyut with even more scientific capacity than Skylab.

Skylab was built using recycled Apollo and Saturn hardware in an effort to save costs. Skylab's unlaunched ancestor, the Gemini-based MOL (Manned Orbital Laboratory) was designed in the same manner. Its age precluded continued use and resupply. It eventually fell out of orbit and burned up upon re-entry in 1979.

## SPECIFICATIONS:

Length:	29.3 m
Diameter:	7.2 m (excludes solar panels)
Displacement:	70.9 DWT
Crew:	3
Range:	limited only by available supplies and ability to maintain orbit
Apogee:	444 km above sea level
Perigee:	345 km above sea level
Orbital duration:	102 minutes per orbit

Innovations/Experiments:

- First full scientific laboratory in orbit
- First Terran tests of extended duration weightlessness

## VISUAL:



# X-20 DYNOSOAR

**SERVICE ENTRY DATE (OLD CALENDAR): 1963**

The X-20 DynoSoar (Dynamic Soarer) was a black project designed by the United States military in the late 1950s. Its purpose was to build a reusable "space plane" compatible with the existing rocket technology of the day. The idea was that it would launch either on top of a Titan IIC rocket or, as later proposed, on the back of an XB-70A Valkyrie bomber at high altitude. After orbital insertion the pilot would conduct whatever top secret mission he or she had been assigned, then re-enter and land just like any other airplane.

The production model X-20A, had it been built, would have been longer and somewhat larger than the X-20 prototype. This was for its modular bay (an ancestor of the OV-100's cargo bay), which was designed to accept a variety of mission packages. The X-20B would have had an even larger bay and more option packages. The X-20C would have been capable of carrying and delivering a nuclear payload.

The DynoSoar project never got beyond the working prototype stage. The United States government cut funding in 1966 mere months before the first manned test flight because they could not see any clear purpose for such a craft. Be that as it may, the concepts and technology that went into the DynoSoar program would be revisited in later years with both the X-27 Raven and OV-100 space shuttle programs.

A popular fictional movie of the day named *Marooned* featured an early X-20 concept design configured with a four-man rescue module. In the movie it was sent up to rescue the crew of a malfunctioning *Apollo* spacecraft.



North American XB-70 Valkyrie Bomber (c.1970)

This would have been the DynoSaur's secondary launch vehicle

## SPECIFICATIONS:

Length:	10.77 m
Beam:	6.34 m
Draft:	2.59 m
Displacement:	6.5 DWT
Crew:	1
Maximum altitude:	160 km above sea level
Flight duration:	1 orbit
Range:	40,700 km (Earth orbit)
Cruising speed:	14,000 km/h
Maximum speed:	28,165 km/h

### Innovations/Experiments:

- First reusable Terran spacecraft
- Direct ancestor of X-27 Raven and OV-100 space shuttle

## VISUAL:



X-20 prototype after atmospheric drop test (1964)



X-20A DynoSoar (conjectural)

# X-27 RAVEN

## SERVICE ENTRY DATE (OLD CALENDAR): 1986

The X-27 Raven was the United States military's counterpart to the civilian OV-100 space shuttle program. It was for the most part an updated version of the X-20 DynoSoar program but with a more clearly defined mission in mind. After the loss of the space shuttle *Challenger* in 1984 the United States military wanted its own reusable space vehicle. Their reasoning was that since one shuttle had failed others might. They did not want, to borrow a Terran phrase, "to put all of their eggs in one basket" when it came to launching military satellites. Since the DynoSoar had already proven itself in prototype all that was needed was to update the design and avionics for its new mission: that of a reusable military launch vehicle for covert satellite launches. The United States approved this crash black project this time around under the code name Raven, provided that it had to be built entirely out of proven, off-the-shelf (and therefore cheap) technology.

Building the Raven was no problem, given its origins in the DynoSoar, and the extensive use of composites cut its weight in half. Building its launch vehicle without escaping notice was proving to be another challenge; that is, until someone remembered that the United States Air Force still had the parts for a third unbuilt XB-70 Valkyrie bomber in storage at its Groom Lake testing facility. The new launch vehicle, now designated the SR-3 Condor, was built to a modified Valkyrie design to address problems found when flight-testing the original two prototypes back in the 1970s. The only real difference from the original configuration was that the SR-3 would carry the X-27 aloft on a centerline belly mount, as opposed to the above-mentioned center fuselage mount planned for the XB-70A.

In a normal mission run an SR-3 would launch from Groom Lake (the infamous "Area 51" of UFO lore) with the X-27 riding beneath until a speed of Mach 3 and a ceiling of 31.6 km had been reached. At this point the SR-3 would release the X-27 and then immediately bank out of its way. As soon as the SR-3 was clear the X-27 would fire its rocket engine, boosting it to orbital velocity. Upon reentry it could land as would an OV-100 series space shuttle at any suitably equipped airfield.

It is believed that the first X-27 Raven underwent aerodynamic testing in 1986 and first successfully launched into space by the end of that year from atop its Condor carrier plane. Operational SR-3s were spotted by civilians in and around the Groom Lake area from 1987 to 2000. The X-27 was first spotted at Holloman AFB, New Mexico in 1994. The tandem combination was only sighted once while in flight in mid-1998. At least two more X-27 Ravens were built over the following decade as well as a second SR-3 Condor lift vehicle. The program remained in service at least as long as did the OV-100 shuttles (possibly a few years longer) before it was officially retired.

## SPECIFICATIONS:

Length:	30 m
Beam:	13 m
Draft:	9.2 m
Displacement:	14 DWT
Crew:	1
Armament:	varied with mission (could carry up to two nuclear MIRV payloads)

Maximum altitude:	160 km above sea level
Flight duration:	1 full orbit

Cruising speed:	28,000 km/h
Maximum speed:	47,500 km/h

### Innovations/Experiments:

- Updated version of X-20 DynoSaur concept
- Military counterpart to OV-100 space shuttle
- First mission configurable military space vehicle
- First potentially armed Terran space vehicle (in one discussed configuration)

## VISUAL:

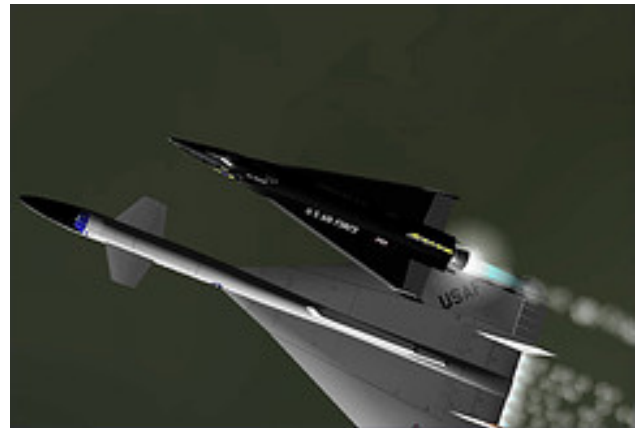

X-20B DynoSaur and XB-70A Valkyrie (conjectural)



SR-3 Condor and X-27 Raven (conjectural)  
Note the similarities between the two programs



# OV-100 CLASS SPACE SHUTTLE

**SERVICE ENTRY DATE (OLD CALENDAR): 1980**



OV-100 *Enterprise* during atmospheric test flight (1977)

If Mars Probe One is to be regarded as NASA's crowning achievement, then the OV-100 series space shuttle program was NASA's most enduring legacy. It was the first Terran spacecraft designed for reuse after its return. It was the first multi-launch large cargo space vehicle, which earned it the unofficial nickname of the "space truck" in its day. It was also the first Terran spacecraft designed with an extended lifespan in mind. Properly maintained and serviced, each NASA space shuttle was supposed to last, to borrow a phrase from the era, "10 years or 100 launches, whichever comes first." Most of the major satellites and probes of the day were carried aloft and launched from a space shuttle. Many of the components for StarLab and Space Station Freedom were hauled aloft in a space shuttle. Although operational for only 12 years, the space shuttle became such a fixture that, save for one notable exception, launches became a routine part of normal Terran life.

The basis space shuttle system was comprised of four parts: two solid rocket boosters for initial launch, an external fuel storage tank for orbital insertion burn, and the space shuttle orbiter itself. Only the solid rocket boosters and orbiter were reusable; the fragile external fuel tank was not designed to survive the heat of re-entry. Building it to do so would have made the whole system too heavy for launch. The sheer size of this configuration required the launching platforms that NASA had originally designed for the Apollo program. After launch the boosters would burn until their propellant was expended, then they would be jettisoned and the orbiter's main motors would kick in burning fuel from the external tank. After orbital insertion the external tank would be jettisoned and the space shuttle orbiter would begin its mission in space.

The shuttle's likeness to that of a terrestrial airplane was not accidental. Extensive research with lifting bodies in the 1960s and 1970s had provided NASA with the data necessary to design a shape that would both survive re-entry and be able to glide to a landing like a normal aircraft would. A similar approach was used in the military X-20 DynoSoar and X-27 Raven programs (see separate articles). This long glide was necessary because the orbiter would have no fuel to burn for course

correction once it began re-entry. This also dictated a suitably prepared landing area. Four sites in the United States were supplemented by two more in Europe and one in Eastern Russia. This gave any returning orbit plenty of target fields on which to land. The orbiter system was also capable of ditching in a belly landing on water in an emergency.

The OV-100 series shuttle's large payload bay measured 18m by 4.6 meters and could lift aloft any cargo that would fit inside. Most of the time this was used for orbital launches of scientific and communications satellites (as well as a handful of military birds). A specially configured laboratory module called SpaceLab allowed for basic industrial and scientific research of commercial manufacturing processes in weightless conditions as had been done with Skylab years before. A first for a Terran spacecraft was the shuttle's Canadian-built manipulator arm, which could be employed like a giant waldo to pull cargoes out of the bay, put them in, or assist with exterior work on other spacecraft and satellites.

When the OV-100 space shuttles first entered service the entire launch delivery system was painted white. NASA engineers later learned they could save launch weight (and much needed money) simply by not painting the shuttle's external fuel tank. This is why it has an orange or rust color in later images. The avionics systems of the OV-100s were upgraded three times during their lifetime to match rapid advancements in Terran computer technology.

---

The worst disaster in Terran space history up that time occurred on January 28, 1986 when the space shuttle *Challenger's* main fuel tank exploded a mere 73 seconds after launch. The orbiter was blown to pieces in one of the most horrifying "live" sights ever captured on Terran media. The entire crew died seconds later when their crew cabin, falling out of control, hit the nearby ocean at a speed of over 300 mph. As a nation mourned the entire space shuttle fleet was grounded while the explosion was investigated. The fault was eventually traced to an O-ring seal in one of the main booster rockets that had failed in the extremely low temperature conditions that existed on the launch pad just prior to launch. This was an environment in which the seal had never been designed to operate. The seal had broken as the shuttle launched, causing ignited fuel to spray directly on the shuttle's main fuel tank and burning a hole through it, causing the explosion 59 seconds into launch. This O-ring system and many other related space shuttle components were redesigned and new safety procedures were put into place before NASA would allow the shuttles to fly again.

## SPECIFICATIONS:

Length:	37.2 m
Beam:	23.8 m
Draft:	17.3 m
Displacement:	68 DWT
Crew:	7-10
Maximum altitude:	1000 km above sea level
Flight duration:	7-30 days
Range after re-entry:	2035 km
Average landing speed:	335 km/h

Maximum payload-to-orbit: 29.5 DWT  
Maximum payload-to-ground: 4 DWT

### Innovations/Experiments:

- First reusable Terran spacecraft
- First multiple mission, variable payload Terran spacecraft
- First production Terran spacecraft purposely designed for a conventional landing

## VISUAL:



OV-105 *Atlantis* launch (STS-71)



Yuri Gagarin (left) and Valentina Tereshkova (right), the first Terran man and woman in space.



American president John Fitzgerald Kennedy walking with Dr. Wernher von Braun, inventor of the ballistic missile (basis for the first manned Terran space rockets)

# MARS PROBE ONE

**SERVICE ENTRY DATE (OLD CALENDAR): 1986**

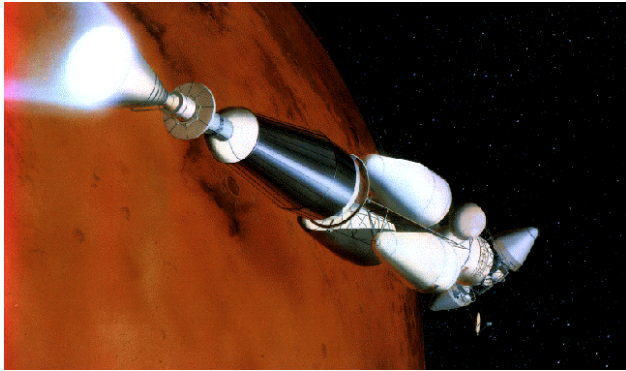

Mars Probe One was perhaps the single greatest achievement of America's NASA space agency prior to its absorption into UESPA. It had been known for years that Mars had the greatest potential of any nearby Sol System planet for a Terran colony; however, getting there was the problem. The answer was found in Project Orion, a modernized version of the early NERVA nuclear rocket program. The fact that it would be using fission powered rocket plus the need to carry stores and equipment for a round trip of three to four years, plus time spent on the surface of Mars, dictated the sheer size of Mars Probe One. This was the main reason why Mars Probe One was built at the Goddard Moonbase instead of on Terra, where Luna's lower gravity would help in such a massive undertaking.

Mars Probe One was actually two ships in one. The *Willy Ley* served as orbital parent ship while the smaller *John Carter* made the actual surface landings. The *Willy Ley* was built a section at a time (as was the *Carter*), each carried up into space aboard a space shuttle and then ferried to the then-building Goddard Moonbase. A total of 71 such trips were required before Mars Probe One completed construction. The actual pilot module for the *Ley* only required the first trip; the rest was for the ship's massive superstructure and the ferrying of components for the *John Carter* lander. An early form of artificial gravity was provided via centrifugal motion generators attached to a single rotating section of the ship. This was the first and last time such a system was ever used in a Terran spacecraft, as more advanced systems became available shortly thereafter. The craft was designed for a 540-day round trip from Terra to Mars and back again. Once construction was approved on a second ship (the *Kennedy*) this feature became a redundant safety fallback. Its *Carter* lander carried two one-man rovers, a base camp module, a portable interplanetary transmitter, and enough materials and supplies to build and maintain a surface expedition for six months. These would be left behind on the surface for future missions once the initial survey was done. The resultant empty storage space aboard the *Carter* was to be filled with rock and soil samples for the trip home to Earth (or so the

official report reads; one wonders why they needed so much room for rocks and dirt).

The initial flight to Mars took 342 days 11 hours, just over two days longer than initially planned, with Mars orbital insertion achieved on 24 April 1987. A mid-course correction had to be made in order to avoid a previously undetected meteorite, resulting in the delay. The crew of the *Carter* spent a total of 48 days on the Martian surface. Only 45 had been planned; an extra three were authorized due to problems encountered near the end of the surface expedition. According to official reports the *Carter* burned too much fuel during its landing approach and several non-critical systems had to be stripped out of the ship in order to lighten the load for takeoff.

Mars Probe One had been originally designed for a Terra-Mars round trip; however, this was changed in mid-mission. A follow-up NASA ship, the *John F. Kennedy*, arrived in orbit just as Mars Probe One was receiving the last of its survey teams for the trip back to Earth. Both crews returned to Earth aboard the *Kennedy*. A thoroughly reprovisioned *Willy Ley* was left in orbit as both waypoint and impromptu space station for the next Terran space mission. It remains there to this day as both museum and monument to this remarkable mission.

The *Willy Ley* was named for the co-author of the 1956 book *The Exploration of Mars*, written with the technical input of rocketry pioneer Werhner von Braun. The *John Carter* was named for a popular fictional character created by Terran author Edgar Rice Burroughs who had a series of adventures on the Red Planet. The *John F. Kennedy* was named for the famous United States president who started his country up the path towards space.

## SPECIFICATIONS (PROBE WITHOUT BOOSTER ASSEMBLY):

Length:	140 m
Beam:	22 m
Draft:	7.3 m
Displacement:	19 DWT
Crew:	6
Apogee:	16,000 km above median surface level
Perigee:	3,200 km above median surface level
Flight duration to Mars:	342 days 11 hrs

### Innovations/Experiments:

- First Terran spacecraft to reach Mars (Sol IV)
- First Terran expedition to visit Sidonia

# DY-100 CLASS SPACESHIP

**SERVICE ENTRY DATE (OLD CALENDAR): 1990**

While Apollo was Terra's first crude interplanetary spacecraft, the Dyson-Yoyodyne DY-100 was the first practical one. Built to take advantage of almost three decades of Terran



space technology it proved to be the most versatile vessel of its time. In both civilian and military roles, as both freight hauler and peacekeeper, and even (in one notable instance) as an escape ship the DY-100 consistently outperformed every other Terran spacecraft of its day. It would eventually initiate an entire series of Terran spacecraft designs, and some of those built to a DY-100 derived design are still in service even today.

The DY-100 *Copernicus* was the first ship in the class and was completed before the fusion power breakthrough in 1990. She was the only one with old-style nuclear rocket engines and is currently on display at the Federation Air and Space Museum on Terra.

The DY-102 *Botany Bay* was stolen by former Earth dictator Khan Noonien Singh, who used it to escape prosecution for war crimes along with 96 of his followers in 1996 following the end of the Eugenics Wars. The vessel was not recovered until some two centuries after it had launched – fully operational and will all aboard still alive in suspended animation, a striking testament to the durability of its design.

## VISUAL:

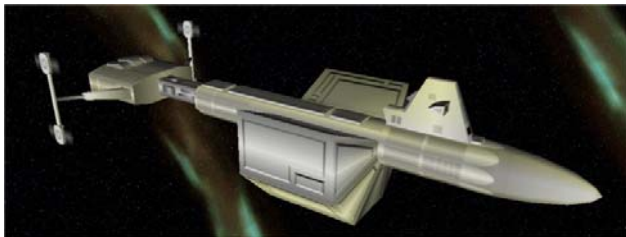

Typical DY-100 production model

## SPECIFICATIONS:

Length:	108 m
Beam:	48.8 m
Draft:	32.3 m
Displacement:	21,000 DWT
Crew:	20 (normal operations)
Range:	up to 3 years if fitted for interplanetary travel

Cruising speed:	53,500 km/h
Maximum speed:	84,250 km/h

### Innovations/Experiments:

- First mass produced Terran interplanetary craft
- First fusion-powered Terran spacecraft
- Could carry up to ten mission-configurable, multi-link cargo modules

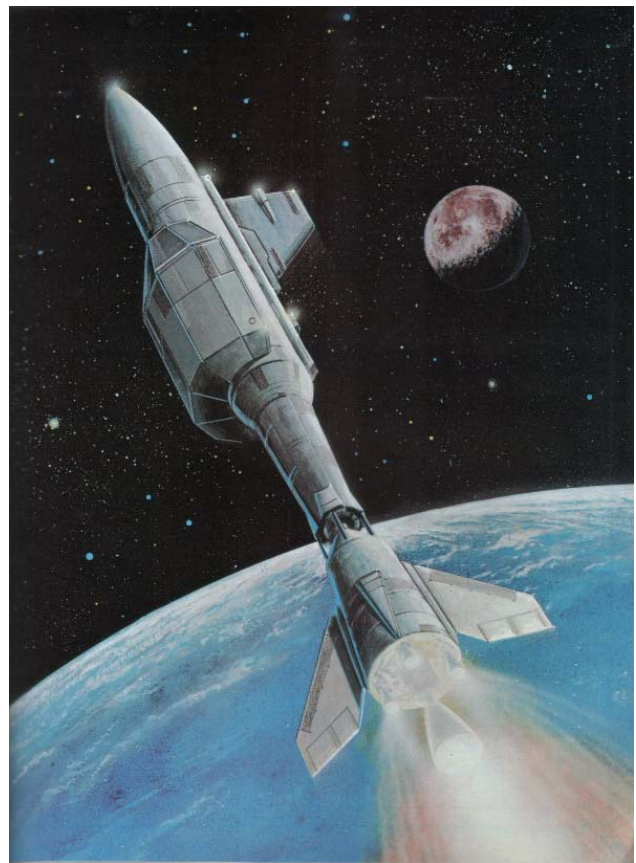

DY-100 *Copernicus*, prototype ship for the DY-100 program



# HEAVY-LIFT VEHICLES

## SERVICE ENTRY DATE (OLD CALENDAR): c.1996

The Goliath HLV was an idea that had been kicking around NASA ever since the 1960s, when famed German scientist Werhner von Braun first proposed the idea. At the time he had suggested that the massive Saturn rocket designed to carry man to the moon had other uses, such as putting space station components into orbit. The idea would eventually become a reality with *Skylab*, which was built on a Saturn second stage frame and used a modified Saturn IB rocket to achieve orbit. The space shuttle program was supposed to replace such rockets; however, NASA had little use for such old-fashioned technologies once fusion-powered spacecraft became a reality. The buck was passed to private industry, which already had several ideas of its own on reusable industrial launch vehicles.

Formal application for the Goliath HLV was made to UESPA in 1995 based on an earlier NASA design study. The first Goliath HLV successfully lifted a test payload to Terran orbit from the Bakinour Cosmodrome the following year. The main body of this first Goliath HLV was retrieved by its Russian owners from the Northern Pacific after its successful splashdown and went on to be reused eighteen more times before it was replaced with another. *Goliath* was the HLV system of choice for the industries of most major spacefaring nations.

There were four other main competitors to the *Goliath* program. Dyson-Yoyodyne's Conestoga III series was based on the original 1970s era HLV design study by Werhner von Braun. Its main drawback was that only the crew/cargo module was reusable; however, this was not seen as a problem by budget-conscious customers with one-shot missions in mind. It proved the most popular because it was the cheapest and used already proven technology. Easy profits from the Conestoga III were used to finance the DY-100 and other similar programs. The British Rocket Group's Space Arrow, based on the old NASA Delta Clipper concept, was the most expensive alternative; however, it had the decided advantage of a completely self-contained reusable craft. It was very popular with Old World European business consortiums. The Chinese Shenzou-10 was the popular model with Asian countries. Finally, the Rozhenski-Petrov HSFL (Heavy Solid Fuel Lifter) was the last gasp of the old Russian space program trying to stay competitive in an already crowded market. It was essentially the old N-1 moon rocket with all of the bugs worked out; consequently, it was the only one of the major competitors to Goliath that could accomplish commercial missions outside of Terran orbit. It saw only a handful of missions in a three-year span, putting communications satellites in orbit around the Moon, before the Rozhenski-Petrov consortium went bankrupt.

Goliath and its surviving competitors would remain in service for almost three decades with budget-conscious space-oriented Terran businesses until fusion powered reusable spacecraft became a practical (and affordable) reality.

### VISUALS:



Left – NASA's Goliath  
Right – Dyson-Yoyodyne's Conestoga III

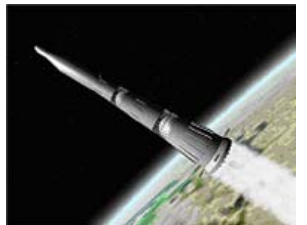

Left – Chinese Shenzou-10  
Right – Rozhenski-Petrov HSFL



The British Rocket Group's Space Arrow

# **21<sup>st</sup> CENTURY**

---

## **The Star Age (2001-2100)**

# 2001-2025: Breaking the Bonds of Sol

---



With the dawn of a new millennia in Terran reckoning mankind found himself no longer limited to a single world. He had both the desire and the technology to break the bonds of his homeworld and venture forth into the void. That he did, establishing his first permanent off-world colonies in the Sol System. The first beachheads had already been established on Luna and Mars only a few years before. Within the quarter-century both of these had grown into full-fledged, self-sufficient colonies. New footholds would be established in the inner asteroid belt as well as the Jovian and Saturnian moons. The giant L-4 and L-5 space cities were built in orbit around Terra, with additional ones planned for Mars and other colonized worlds. Mankind even dared to plan for exploration beyond the bounds of his own solar system. This period is known in Terran history as the Planet Age: the period of time in which mankind was no longer limited to just one world for his habitations. It was but the beginning.

Along with this drive into space came a wave of industrialization and technology to support it. Major spaceyards were built both in Terran and at Mars for the building of a new generation of Terran spacecraft. These would finally allow humanity to break the bonds of his star Sol and venture into great Sea of Stars. In the meantime, though, there was plenty enough

exploration and colonization with the Sol System to go around.

With any wave of colonization comes the commoner in time, seeking new fortunes or simply to start anew. The First Great Space Rush began in 2014 with the passage of the Space Homestead Act and would continue for some three decades thereafter. Its generous settlement policies opened the door for the average human to take his or her family, pull up stakes, and resettle off world. In this he was only following the examples of his ancestors: the great Oklahoma Land Rush, the California and Alaskan Gold Rushes, the settlement of the Australian Outback, the German colonization of South Africa, and so on. There are countless parallels in human history. It is one of the idiosyncrasies of humanity: to venture forth against all reason and judgment into an untamed wilderness in order to better one's self and family. So it was then and so it was now. A veritable wave of humans sallied forth into the asteroid belt seeing quick riches through raw mineral mining. Along the way, they ensured that humanity would no longer be a Terra-centric species. Mankind was in space to stay.

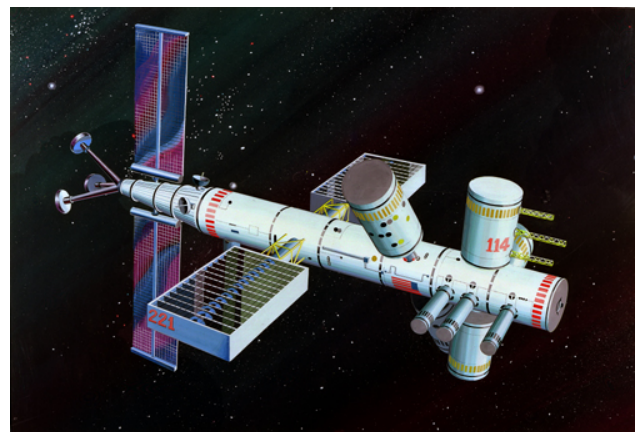

Even with all of the incredible advances that had put mankind into space in so short a time a common consensus was lacking. The Eugenics Wars reminded everyone on Terra what a few well-armed madmen

could do to the planet. If humanity was to survive it needed to get its act together and head for the stars before it destroyed itself in another war. The dawn of a new millennium saw Terra's first one-world government in the form of the New United Nations. One of the first acts it passed was the United Space Initiative, confirming to all that man's ultimate destiny was in the stars. UESPA was reorganized and, as part of this, the United Earth Solar Fleet (UESF) was born. This organization was independent of any Terran nation, using its growing off-world resources to further space exploration efforts. In time it would also take over police and military duties for Terra's off-world colonies. It was the forerunner of Star Fleet.

Around the same time that the UESF was founded UESPA found it needed a better means of coordinating the science and survey missions of Terra's various spacefaring nations. UESPA itself had become too bureaucratic by this point to continue in this task. Instead it created the International Space Agency (ISA) to act as both liaison and coordinator among the various national space agencies. Unlike the UESF, the missions of the ISA were always of purely scientific nature, even though the UESF was sometimes involved in support. The ISA can rightly be said be the Terran forerunner of the organization we know today as the Federation Bureau of Sciences.

---

Perhaps the most portentous discovery in this period of Terran history was the confirmation of non-Terran intelligent life in the universe. Firm evidence had already been discovered at the end of the 20<sup>th</sup> century, when the astronauts of Apollo 18 stumbled across a Slaver stasis box on the moon. The million-year-old flying belt found inside, still fully functional, gave Terra advanced anti-gravity technology long before it would have developed it on its own. There were also the striking images of the face on Mars first photographed on the Sidonia plain by the Viking space probe. Further follow-up missions, including a secret side excursion by the Mars Probe One mission, confirmed that the remains of a once-vibrant alien civilization that predated humanity by thousands of years existed on Mars. What the *John Carter*

astronauts found in the Sidonia ruins would be kept a carefully guarded secret for generations. What could not be hid by the New United Nations were subsequent discoveries of fossilized alien life on Mars, as well as evidence of strip mining on the Jovian and Saturnian moons stumbled across by the Saturn-Titan Probe. The cat was now out of the bag, to borrow a Terran euphemism. After the initial predicted culture shock wore off, though, mankind's natural curiosity took over. Humanity might no longer be unique in the universe; however, it was no longer alone, either. A growing desire began to fill the hearts of man to seek out this new life, these new civilizations ... to boldly go where no man had gone before. That desire would eventually take man to the stars and beyond.



---

As humanity prepared itself to take its first faltering steps beyond the Sol System it knew that its current spacecraft propulsion systems were woefully inadequate to the task. First-generation rockets, powered either by messy chemicals or radioactive fission, were soon replaced by a range of clean and efficient fusion power engines. The technology was perfected and further refined by the end of the decade, resulting in the *ion impulse drive*. This we know today as the impulse engine. Its basic theory and design has remained unchanged ever since this era in Terran spaceflight development. Simply put, it was the most efficient and reliable form of sub-light propulsion ever developed on Terra (or any other Federation world, for that matter). Ion impulse engines would drive two more generations of Terran spacecraft to the stars until the introduction of warp drive in the 2060s.

At the same time that work on the ion impulse engine was proceeding, a spacecraft power plant of a completely different sort was being developed in secret. The details surrounding this remain murky, as most of it was lost during World War III. What is known is that a top secret development program was



initiated by UESPA in co-ordination with NASA (the best of the various national space agencies) and Dyson-Yoyodyne (the pioneers of Terran interplanetary spacecraft). The goal of this program was to develop a next-generation engine for Terra's first interstellar spacecraft, or "starship" for short. What was so unusual about this drive system, if the surviving reports are true, is that it marks the first effort in history of known current galactic humanoid cultures to tap the unlimited power of a controlled singularity. This ambitious project was known as the *spinner drive* and was first tested in small-scale form on a converted DY-200 series spacecraft in 2018. This test just happened to coincide with the tragic loss of the *UES Cyclops*, mankind's first purpose-built starship, which exploded near Mars on its maiden voyage. The cause was never determined; however, many believed it to be due to catastrophic failure of its experimental advanced power planet (the details of which are still unknown. Spinner drive immediately suggested itself as a workable alternative, and efforts commenced on producing a version suitable for driving a starship to Alpha Centauri and back. Those efforts would not see results for another decade.

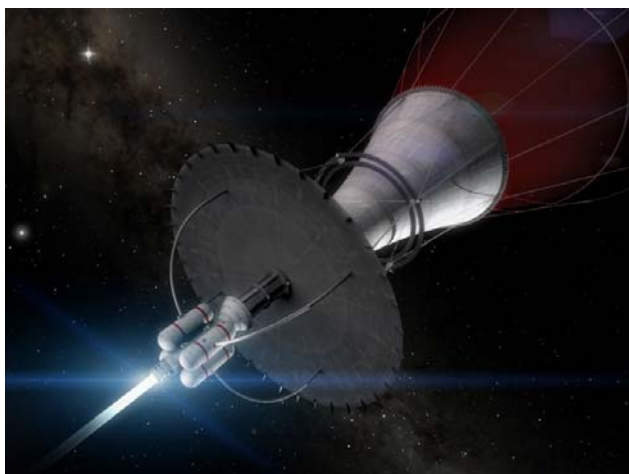

The loss of the *Cyclops* did not mean that mankind's efforts to break the bonds of Sol were at an end. Far from it. As the old Terran adage goes, "If at first you don't succeed, try, try again." A series of privately funded "space arks" had already started leaving the Sol System in 2010, making do with proven Bussard ramjet technology to launch multi-generational colonization efforts at nearby systems. Dyson-Yoyodyne's DY-500 series of spacecraft entered

service in 2019, a year after the *Cyclops* disaster, and become the Terran stellar workhorse of a generation. Its extended range would acclimate crews to being in space for two or three years at a time – excellent training for interstellar missions to come. Also, like its ancestor, the DY-100 class, a member of the DY-500 class would leave the Sol System under tragic circumstances. The loss of the *UES Courageous* would raise the safety bar on all subsequent Terran spacecraft designs, and also lead in due time to humanity's first true successful starship.

One would think that with all of his bounty, the technological rewards reaped from his rapidly expanding space program, and the abundant resources from cheap solar power and asteroid mining, that Terrans would finally shed their clamorous past and unite as one under their new government. Sadly, however, it was not meant to be. A rift began to develop between humanity in space and humanity on Terra. The former were the forward-thinkers, looking ever outward; while the latter were still trapped by the religious and petty bickering of Terra's past. Slowly, inexorably, Terra's space colonies began to distance themselves from the political affairs of their homeworld as Terra began to stumble once again towards the brink of doom. The greed, prejudice, and strident nationalism that should have ended with the Planet Age only seemed to become worse. The age would end with riots around the globe as the socially dispossessed fought for their place in Terra's new society. Events such as the Bell Riots in the United States, the Neo-Trotsky Movement in Russia, a resurgent eugenics movement in Southeast Asia, and the Avingon Riots in France were all signs of a planet falling fast into chaos. Like its two predecessors before the New United Nations proved ineffective in stopping these conflicts. The final straw prove to be the British invasion of the newly reunified Ireland in 2025, done under the pretext of reclaiming its former possession of Northern Ireland. The Planet Age, which had seemed to promise so much for Terra when it began a mere twenty-five years before, ended with the outbreak of World War III.

# SPACESHIPS

## ***LINDBERGH* CLASS SPACE FERRY**

**SERVICE ENTRY DATE (OLD CALENDAR): 2003**

The *Lindbergh* class Space Ferry (or Space Ferry II, as it is sometimes called) was the last in a generation of reusable, chemical-powered Terran orbital spacecraft dating all the way back to the X-20 DynoSaur program in the 1960s. As originally designed it would achieve orbit via chemical boosters; however, the fusion revolution at the turn of the millennia eliminated the need for them. These Space Ferries played a key role in the establishment of the Orbital Power Satellite network that guaranteed Terra's independence from fossil-fueled power stations. It also played a key part in ferrying finished components for the construction of the first L-5 O'Neill "space cities." Though they were only in service for 12 years they had a major impact on Terra's growing space program.

### **SPECIFICATIONS:**

Length:	61 m
Beam:	51 m
Draft:	51 m
Displacement:	2750 DWT
Crew:	6 (+ up to 125 passengers depending on configuration)
Range:	Terra-Luna and Terra/L-5 runs
Maximum speed:	11,000 m/sec

Innovations/Experiments:

- Could carry up to 10,000 cubic meters of cargo
- Multiple cargo bays (8 per side) for easy access

### **VISUAL:**

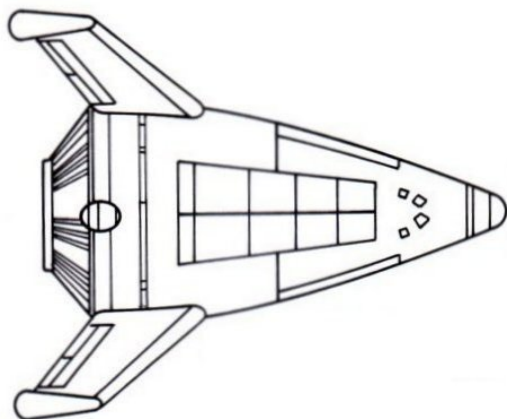

## ***STELLAR* SERIES SPACE PROBE**

**SERVICE ENTRY DATE (OLD CALENDAR): 2015**

These were the first Terran space probes that were specifically designed to travel into the void beyond Pluto. Their main purpose was to gather data necessary for the proper construction of Terra's first generation of true interstellar manned spacecraft. Recent advances in Terran computer technology made these Terra's first space vehicles of any kind equipped with a form of artificial intelligence (AI). They also carried an advanced fusion drive system that was the forerunner of the ion impulse engine.

The *U Thant*, a *Stellar* series probe launched in 2016, was the first Terran spacecraft to discover the existence of natural antimatter, long thought by Terran scientists to be a physical impossibility. This discovery would help pave the way towards the development of human faster-than-light technology.

### **SPECIFICATIONS:**

Length:	85 m
Beam:	44.5 m
Draft:	44.5 m
Displacement:	1,100 DWT
Crew:	none
Range:	5.9 l.y. (Barnard's Star) or 2500 days at max. fuel consumption

Maximum speed: 0.104c

Innovations/Experiments:

- First Terran space vehicle equipped with an AI

### **VISUAL:**

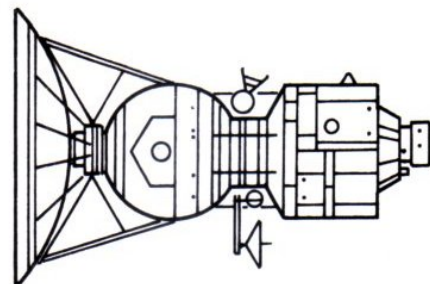

# BUSSARD RAMJET COLONIZATION SHIP

**SERVICE ENTRY DATE (OLD CALENDAR): 2010**

This was the designation given by UESPA to a string of private sub-light colonization ships launched from Terra starting in 2010. Though the designs tended to vary among individual efforts all of them had one thing in common: their massive Bussard ramjet engines. These were a cheap alternative to the normal fusion plants of the day. The basic principle involved fueling their engines with a giant forward scoop (usually a EM field or polarized mesh many times the size of the actual ship) that would scoop up the hydrogen normally present in the interstellar void. This would then be force-fed into the ship's engine in the same manner as a traditional atmospheric ramjet engine. As long as the ship was moving it would essentially fuel itself. UESPA was leery of such a system and never gave these efforts public backing. Instead, the groups backing these craft worked in co-ordination with UESPA's member space agencies, such as NASA and the ESA. All UESPA had to do was approving their final launch clearance and planned extra-system trajectory. UESPA would later employ elements of Bussard ramjet technology in its first generation of faster-than-light starships.

## VISUALS:

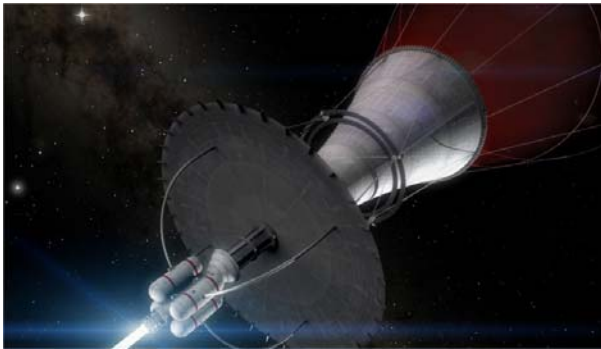

*SS Forty Families*, the first *Alamo* type spaceship

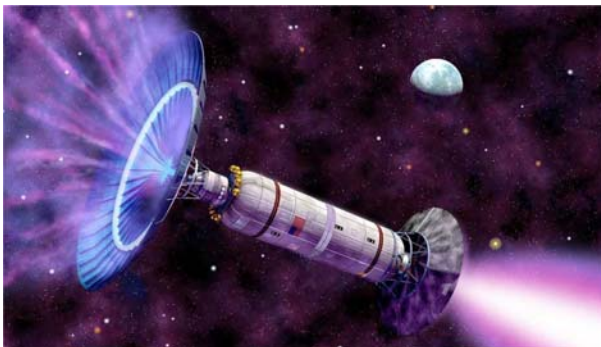

*SS Marilee*, a later variant

# DY-300 CLASS PROTOTYPE

**SERVICE ENTRY DATE (OLD CALENDAR): 2013**

The DY-300 class was intended to be the natural successor to the DY-100 and DY-200 classes, and two prototypes were built in 2013 to test the design. Unfortunately, a new structural bracing system employed in construction was found to be seriously deficient and the program put on hold. Both the DY-300 and successor DY-400 class would be delayed until the 2030s due the problems encountered with these first DY-300 prototypes. Instead, the DY-500 class entered production ahead of schedule in their place.

The early DY-300 prototype program did have one positive aspect, however. For the first time in Terran history a reasoning ship's computer, or AI (artificial computer) was a standard feature in a spaceship. It was this AI, nicknamed "SAL" by the first prototype's crew, that warned them of the structural instabilities which almost destroyed their vessel during one of its test runs. Similar systems would become standard in all future Terran spacecraft starting with UESPA's *Aventeur* class explorer craft.

## SPECIFICATIONS:

Length:	145 m
Beam:	29 m
Draft:	45 m
Displacement:	18,700 DWT
Crew:	30
Range:	untested
Cruising speed:	135,000 km/h

### Innovations/Experiments:

- First use of a AI (artificial intelligence) as the primary ship's computer of a Terran vessel.

## VISUAL:

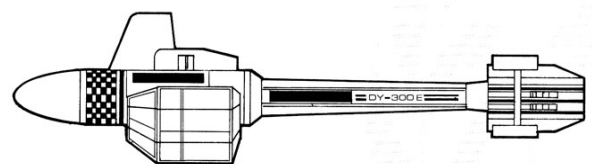

# CYCLOPS CLASS EXPLORER

**SERVICE ENTRY DATE (OLD CALENDAR): 2018**

The *Cyclops* was a one-shot design intended to be mankind's first-ever manned interstellar spacecraft. It was the first product of the TAU Program (Thousand Astronomical Units), thus named for the intended minimum range of such a craft. It was built for NASA under contract to UESPA by Boeing Aerospace. The *Cyclops* launched successfully from Terran orbit in 2018. Unfortunately, it exploded under mysterious circumstances not long after leaving the vicinity of Mars when it fired its main engine for the first time. All crewmembers were killed and the true cause of the explosion was never determined. This unfortunate incident set UESPA's extra-solar exploration efforts back another full decade.



Not much is known today about the *Cyclops*. All of the development data was supposedly lost during World War III. All that is known for sure is that it supposedly employed a "revolutionary" new form of propulsion that was supposedly far in advance of the fusion drives of the day. Most historians have suggested that the *Cyclops* was the first ship equipped with a matter-antimatter conversion drive whose first attempted use went horribly wrong. It may have also been one of the early "spinner" drive prototypes. We may never know for sure.

There would be two more ships of different designs built for NASA under the auspices of the TAU Program. These were the *Cerebus* and the *Charybdis*. Both would prove as ill fated in their time as did the *Cyclops* in its own.

## VISUAL:

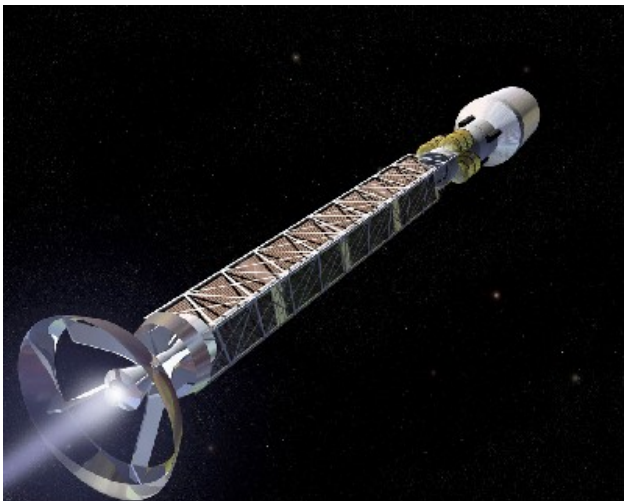

The only known surviving image of the *Cyclops* (digitally enhanced for clarity)

# AVENTEUR CLASS EXPLORER

**SERVICE ENTRY DATE (OLD CALENDAR): 2018**

This was the very first Terran spacecraft design built entirely in space. Construction of the first two vessels was in Earth orbit while the remaining three were built at the new Utopia Planitia orbital complex above Mars. They were all named for famous Terran explorers. They were designed for extended interplanetary survey and exploration across the whole Sol System. As such they had some of the largest cargo capacity and most advanced propulsion systems of their day.

The *Aventeur* class is best remembered for the *Lewis & Clark*, which performed the Saturn-Titan probe of 2019-2021 under the command of Colonel Shaun Geoffery Christopher. It is preserved today at the Utopia Planitia Orbital Museum at Mars.

## SPECIFICATIONS:

Length:	125 m
Beam:	28.5 m
Draft:	28.5 m
Displacement:	28,000 DWT
Crew:	109
Range:	2.57 billion km (Earth-Saturn)

Cruising speed: 700,550 km/h

### Innovations/Experiments:

- First major Terran spaceship class built with ion impulse drive
- Twelve 1140 cu m jettisonable cargo modules for storage (based on common Dyson-Yoyodyne design)

## VISUAL:

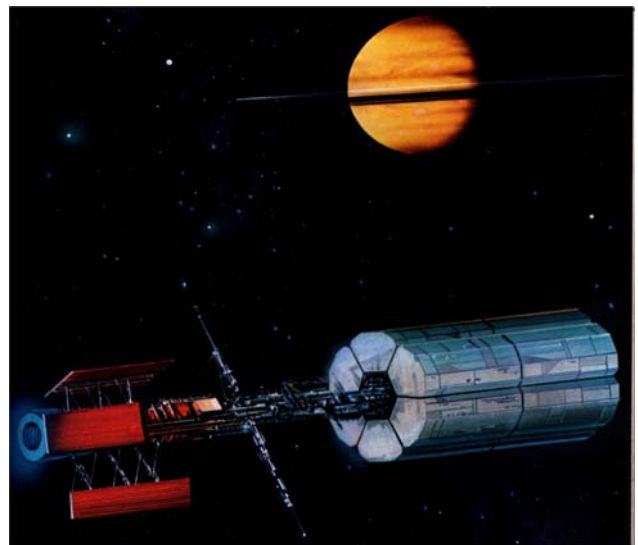



# DY-500 WHEELER CLASS

**SERVICE ENTRY DATE (OLD CALENDAR): 2019**

The DY-500 series was rushed into production ahead of schedule in order to fill the gap caused by the failure of the DY-300 prototypes in testing. The real design intended for the DY-500s was incomplete and untested; therefore, a fallback solution was adopted. Vessels in the aging DY-100 class were brought back in and extensively modified to produce the “new” DY-500 class. A new fusion power plant was installed as well as the new magnetohydrodynamic generator (MHD unit). This provided on-board power directly from the thrust from the ship’s engines. MHD units were safer than previous systems and this innovation soon became standard in Terran spacecraft of the day. The unused design would eventually become the DY-430 series.

The DY-500 is forever affiliated with the First Great Space Rush. Many were purchased by eager homesteaders for the trip to the Sol System inner asteroid belt. Some of their cargo modules would then be turned into quick-fab homes while the others were used to ship their mined materials back to Mars and Terra. So many DY-500 conversions and new builds happened during the First Great Space Rush that they remained a common sight on the space lanes for centuries. Even today a few of these aging relics can be found in the possession of cash-strapped intersystem prospectors, still slowly plying the spaceways as they did back in their heyday.

## SPECIFICATIONS:

Length:	107.6 m
Beam:	32.63 m
Draft:	32.3 m
Displacement:	22,500 DWT
Crew:	11 (+44 passengers)
Range:	2.5 years at S.O.P.
Cruising speed:	470,000 km/h
Maximum speed:	480,000 km/h
Avg. voyage duration:	185 days (Terra-Asterpolis run)

Innovations/Experiments:

- First Terran spacecraft fitted with MHD power units

## VISUAL:

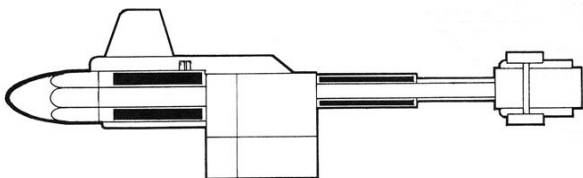

# DY-245 CLASS

## “STRETCH” TRANSPORT

**SERVICE ENTRY DATE (OLD CALENDAR): 2025**

The DY-245 class was a stopgap design like the DY-500 intended to cover for the delayed DY-300 program. It was essentially an extended DY-100 with two extra anchor sections for four times as much cargo capacity. It could mount either standard Dyson-Yoyodyne cargo containers or several of the new, smaller “Beach Ball” series in their place for bulk transport of liquids. The design benefited from the advanced power plant of the DY-200 series; however, it was the slowest Dyson-Yoyodyne design in operation (when fully loaded) because of its heavier mass. Even so the DY-245 would become a common low-cost alternative to the *Galileo* transport, shuttling high-volume cargoes on the Terra-Mars and Mars-Asterpolis runs. Many would wind up as impromptu colony ships for trips to the Ficus Sector once that was opened for exploration.



As built the DY-245 series was not given a class name. Most of the vessels were named, if at all, according to the whims of their owners. This practice would be followed with subsequent Dyson-Yoyodyne spacecraft classes

## SPECIFICATIONS:

Length:	154.8 m
Beam:	36.3 m
Draft:	31.5 m
Displacement:	31,250 DWT
Crew:	20 (+25 [passengers])
Range:	2.25 years at S.O.P.
Cruising speed:	275,000 km/h (full load)
Maximum speed:	290,000 km/h (full load)

Innovations/Experiments:

- First of the DY series to carry the “Beach Ball” bulk liquids cargo container.

## VISUAL:



# 2026-2050: The Road to the Stars

---



No discussion of this period in the history of Terran spaceflight can avoid the mention of World War III. It rolled across the surface of the planet in waves for some twenty-three years, leaving no country untouched and no family without its war dead. It all but stymied Terran advances in space exploration on the planet as it turned inward and turned its technology against itself. Killer satellites, orbital missile and laser platforms, quick-launch attack craft, sub-orbital assault ships – the list goes on and on. What started out as simple spat over the obsolete concepts of nationalism and territorial rights quickly devolved into a war that pitted alliance against alliance, nation against nation, and brother against brother. As soon as the conflict in one part of the world would die down another would already be flaring. War in one form or another raged nonstop on Terra until the end, when the surviving major nations finally unleashed their nuclear arsenals in the worldwide rain of death that the more noble among mankind had for so long hoped to avoid.

In the space of twenty minutes one-third of Terra's inhabited surface was laid waste, incinerated under a combined ground and orbital bombardment in an horrific maelstrom that was forever after remembered as the Day of Fire. Over 600 million of the planet's humans died in those terrible twenty minutes and almost as many would die during the Post Atomic Horror that followed. Perhaps it was inevitable, given man's nature. Oftentimes he has to destroy in order to create. In this case the old axiom was correct. The Terran culture that finally emerged from the Post Atomic Horror was radically different from the one before. Gone were the nationalism, religious bickering, and petty political spats. Most of the reasons for them simply no longer existed, incinerated along with most of man's past and burned away by the simple need to survive, no matter how or what the cost. The few humans left on Terra who managed to survive the Post Atomic Horror vowed to build a new society, free from its ills of old. In this they were helped by their former space colonies, who had long ago shed such burdens for the promise that the New Frontier offered them. Terra would be rebuilt and many of its cultural and historic icons restored; however, gone forever would be the societal idiosyncrasies that had led to the Day of Fire.

---

The wartime burden carried by its parent government didn't stop NASA from trying to fulfill its obligations to UESPA under the TAU Program to build a true interstellar spacecraft. This was one of the few spacecraft programs that managed to proceed in spite of the war. NASA had failed once before with *Cyclops*. Their next attempt, *Cerebus*, used the new and still largely experimental "spinner" drive for its main engine. Everything seemed to be going as planned, and the engine appeared to be working according to design, when the ship's telemetry was lost just after it cleared Neptune. A UESF military recon mission eventually found the drifting derelict, its engines shattered and its atmosphere vented into space. All aboard were dead; whatever calamity had

struck them had not left them enough time to get to the escape pods. This second failure might have seemed an ominous sign of which NASA should have taken heed; however, its decades-long reputation for excellence was on the line. "Third time's the charm," its contractors grimly said as the last of the TAU Program ships was built. This was the *Charybdis*, as ill fated as its two predecessors, and it would simply vanish without a trace in 2037. What data was available pointed to a catastrophic failure of its spinner drive, similar to what had happened with the failed fusion drives of the *UES Courageous* back in 2022. The TAU Program would be NASA's last, with all funding being cut for future spacecraft development. The agency itself would be absorbed into the ISA shortly thereafter. In the meantime, though, Utopia Planitia was already succeeding for UESPA where NASA was failing with the first "ringships" ever to enter Terran service.

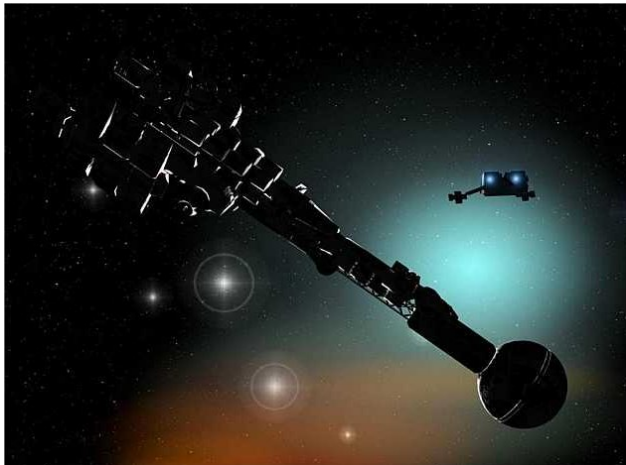

While most of the humans on Terra were busily trying to exterminate themselves the humans of Terra's space colonies were rapidly leaping ahead on the road to the Sea of Stars. The first major phase of expansion at the Utopia Planitia shipyards at Mars was completed in 2029. While ship classes had already been building at Utopia Planitia before this, the availability of the new, larger facilities saw a rapid boom in the size and number of Terran vessels. Utopia Planitia would not see such a large expansion again in its shipbuilding capacities until the Earth-Kzin Wars (2048-2065). In the meantime, however, it would produce some of the best and most renowned

Terran spacecraft of its time. These included the *Columbus* class explorer, ISA's most famous vessel and the first true starship; the *Companion* class scout, which was the UESF's first true spacegoing ship-of-the-line; and the elegant *Declaration* class starliners, widely regarded as the most beautiful Terran spacecraft of their day.

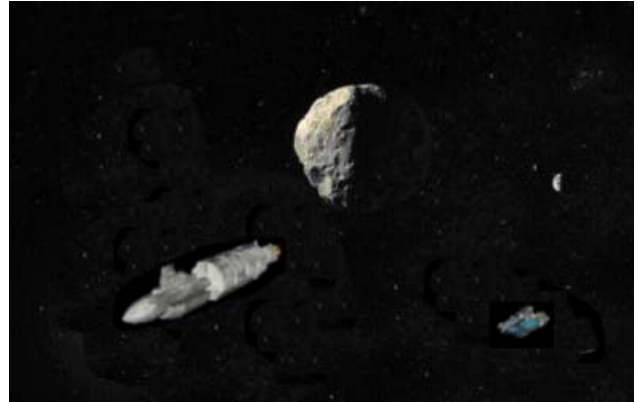

Certainly the most talked-about effort of Terran colonists during this time (and lied-about, depending on the tale-teller) was the mining of the Sol System's inner asteroid belt. It was the American Wild West all over again, with spaceships and early lasers instead of horses and six-shooters. There were no "space Indians" to contend with (yet); however, there were territorial wars aplenty as miners and homesteaders fought over claims – and not always with words, either. The local UESF garrisons were kept busy breaking up one mining war after another or rescuing swindled homesteaders from the claims of unscrupulous mining companies. Eventually, though, as the region stabilized somewhat and its population boomed, large quantities of nickel and iron were shipped back to Terra and Mars. These would be sent either in raw form via mass driver or in refined form via transport ship. It saw the mining town of Asterpolis grow from a regional space capital to one of the most important colonial settlements in the Sol System. This gave the asteroid miners a newfound place of importance among their peers in the early Terran colonies. Even today the people of Asterpolis take pride in their mining heritage. Daily and weekly tours are conducted of the most important mining sites. The important role that Asterpolis and the asteroid miners played in the Earth-Kzin Wars is not given short shrift, either, with a fully reconstructed

UESF asteroid laser defensive base available for public inspection as part of the tour.



The biggest project by far that UESPA undertook during this time was the terraforming of Venus. Billions of blue-green *cyandium caldarium* algae had been seeded into its atmosphere in late 2025. These “ate” carbon dioxide and produced oxygen in the process. Within two years large quantities of oxygen were detected in the harsh atmosphere of Venus. At the same time its atmosphere began to condense natural water, which rained onto the surface and filled its previously dry canyons and gullies. This in turn lowered the planet’s notoriously high atmospheric pressure. By 2047 enough of a transformation had taken place for the establishment of the first manned base on Venus. The planet still had a long way to go before it could ever be properly colonized; however, these early results were certainly promising.



Such a large expansion of the Terran colonies required an infrastructure to match. Huge space farms were built to grow food under otherwise hostile

conditions. A new generation of space transports were built to supply these rapidly growing populations. Dyson-Yoyodine lost its former monopoly on civilian space travel as better and roomier designs from competing companies gained public acceptance. It still had its military contracts, however, and in these it would continue the historic heritage of the legendary DY-series spacecraft design.

Three events near the end of this era would forever change the destiny of man on the eternal Sea of Stars. The first was the concealed crash of a Vulcan survey ship on Earth in 2045. The second was first contact with the humans of Alpha Centauri in 2048. The third was the attack on the scout ship *Sakharov*, also in 2048, which led directly to the First Earth-Kzin War in 2049-2050.

The Vulcans were the oldest of all cultures currently populating the worlds of the Local Group. Alone of all they had faster-than-light drive, which by default also made them the most powerful. The fact that they chose not to exercise that power spoke much of both their culture and their situation. Vulcan had interstellar colonies, yes, but it did not have an empire and did not want one. Thousands of years ago Surak the Reformer had brought the philosophy of logic to his people, changing them from a warlike to a benevolent race. The more emotional among the Vulcans, refusing to accept Surak’s way, had left long ago, never to return.



The Vulcans had been aware of humanity for centuries, monitoring its steady progress as it strove to set foot on the Sea of Stars. Of all the newly risen cultures in the Local Group that they had surveyed over the years they found humanity the most promising. They seemed to be the living embodiment of their own philosophy of IDIC: infinite diversity in infinite combinations. Mankind had many diverse cultures and even more sub-permutations on those, yet in times of great crisis they almost always banded together for the common good. Most importantly,



though, they had in droves the cultural drive that the Vulcans now lacked. Logic and technical superiority had their down sides as well. Vulcan was in danger of becoming a stagnant culture. Logic dictated that given enough time a new power would arise that would surpass Vulcan dominance in the stars, possibly destroying them in the process. Logic also dictated that Vulcan was better served allied with such a culture than fighting an eventually losing war against it. That, among other things, is why once humanity achieved practical spaceflight they began to watch then quite keenly. The crash of one of their Terran survey ships in 2045, followed by the safe return of its crew by the Terrans themselves, taking care not to reveal the true identity and nature of their “guests,” spoke a lot of these beings of whom the Vulcans were already beginning to hold in some regard. Still, they waited for a more tangible sign that humanity was ready to join the Local Group not only as a friend but also as an equal and ally. They would get that sign within their own lifetimes.

---

Humanity’s first contact with a non-terrestrial culture turned out, surprisingly, to be an encounter with itself. The inhabitants of Alpha Centauri VII, the first “alien” culture ever encountered by Terrans, were in fact Terrans themselves – Greeks transplanted from the 3<sup>rd</sup> century BCE by the Preservers and left to develop on their artificially created, Earth-like world. Not surprisingly their civilization developed in parallel to their distant brothers back in the Sol System (an event which would lead Centaurean scientist Zacmar Hodgkins to posit his Law of Parallel Planet Development). Of course, they put their own unique spin on their path to the stars. By 2002 they had mastered the science of interplanetary travel; however, their primary method for such journeys was the solar sail (a technology that the Terrans had largely bypassed). By 2020 it had found a peaceful means of coexisting with its fledgling space colonies via the Alpha Centauri Concordium of Planets, thus sparing the system from events such as the Sol



System’s Martian Rebellion. They were not without their faults, as the failure of their colony on Alpha Centauri IV subsequently showed; however, they were as quick to adapt to a given situation and make the best of it as were their brothers on Terra.

The Centaureans had become aware of life in the Sol System about the same time that the Sol System had become aware of life at Alpha Centauri. Their own interstellar program was already well underway by the time the *UES Icarus* arrived from Terra. They welcomed the ship’s crew with open arms – partly overjoyed at seeing they were dealing with other humans, but also because the Terrans had saved them the trouble and expense of the trip. At least one Centaurean scientist was not pleased by this development, however, and he shared his concerns privately with *Icarus* commander Captain Roger Tauber. As Captain Tauber listened to his translator (a native-born Greek on his own crew) relay the scientist’s description of his new drive system he realized that here was a true genius worth more than a few words of social courtesy. He put him in touch with his ship’s science officer Frank Jocasta, and the two (along with translator in tow) left the reception. Tauber wouldn’t see Jocasta in person again for another week, but when he did, Jocasta would have news that would forever change the future of mankind on the Sea of Stars.

---

The last culture that needed to be humanity’s first contact with a truly alien species would turn out to be its first. The ferocious, catlike Kzinti were the undisputed masters of one of the greatest interstellar empires at that time in the galaxy. It roughly comprised what is today known as the coreward sectors of the Federation’s Alpha and Beta Quadrants. They had conquered the Tellarites and forever planted nightmare visions of “the Great Claw-Swipe” in their culture. They knew the Andorians and, while failing to conquer them, nevertheless had made their independence a dearly bought victory that required constant vigil. They respected the Klingons and had fought several bloody



wars with them on the far side of their empire. They loathed the Vulcans and feared them, all the while secretly rejoicing that the pacifist ways of the “eaters-of-roots-and-leaves” guaranteed the Kzinti Empire would continue. They were not counting on humanity to enter the picture.

Historians have always debated the initial contact between humanity and the Kzinti in 2048 that brought on the four Earth-Kzin Wars. To some it seems too incredible a set of circumstances to believe. The Terran ship *Sakharov* was nowhere near Kzinti-claimed space; thus logically it should have never encountered a Kzinti patrol cruiser. Supporters of the account will reply that the Kzinti had a long-standing habit of sending ships into unclaimed areas of space in order to find “new food for our dinner table,” as one captured Kzinti captain put it. This was no different and the *Sakharov* just happened to be in the wrong place at the wrong time. The rejoinder to this is that, as Kzinti records have since shown, the Kzinti cruiser was on the run from a Vulcan cruiser whose path it had dared to cross. Such theories intimate the Vulcans may have had a part to play in the *Sakharov* incident, deliberately steering the Kzinti cruiser by its pursuit in such a manner that it *had* to come across the *Sakharov* sooner or later. The Vulcans have always dismissed such theories as emotional speculation and have offered free access to their historical archives to prove their innocence. They also point out, and rightly so, that logically humanity would have run up against the Kzinti sooner or later. The notion persists in certain quarters to this day, though, that there was much among Vulcan activities at the time that was not recorded (or possibly wiped). The Kzinti were the greatest scourge that the Local Group and other systems in the known galaxy had suffered for a thousand years. It would take a more noble culture of equal drive and determination but greater intelligence, ingenuity, and resourcefulness to defeat them. The Kzinti would eventually meet their match in humanity; however that conflict at this point was just beginning. Mankind had four bloody wars to go before the Kzinti would be forever denied their dinner table in the stars.



The Day of Fire claims one of many Terran cities

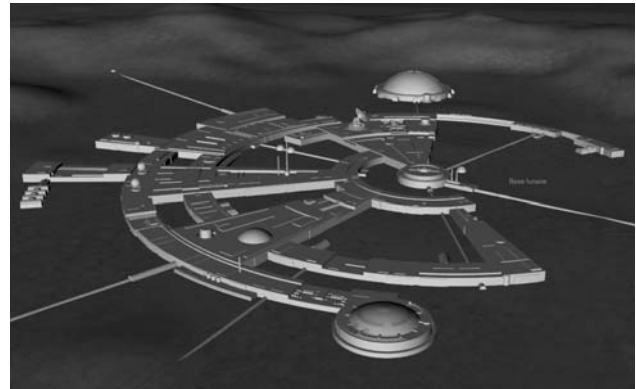

UESF Aitken Base, Luna



Velestus, aka Alpha Centauri IV



A Kzinti warrior feeds on the remains of Lt. Georgi Radetski, *UES Sakharov* – artist’s drawing from survivor’s account (2048)

# SPACESHIPS

## ***GALILEO* CLASS TRANSPORT**

**SERVICE ENTRY DATE (OLD CALENDAR): 2028**

Forever associated with the First Great Space Rush, the *Galileo* class transport was one of the most enduring workhorses of the era. These were ruggedly build and extremely durable. These were the most popular cargo ships in the asteroid belt (for those who could afford them) and also popular with companies that provided transport to the outer planets of the Sol System. They would also prove themselves during the Earth-Kzin Wars as one of the few Terran spacecraft that could survive a pounding from Kzinti drone attacks. The class itself stopped building in 2062; however, most of the survivors were refitted with warp drive and continued to serve well into the 22<sup>nd</sup> century. A handful of these well-worn veteran transports still exist in private hands today – a testament to the durability of their design.

### **ORIGINAL SPECIFICATIONS (2028):**

Length:	300 m (with one cargo pod)
Diameter:	120.7 m
Displacement:	500,000 DWT (empty,) 4,840,000 DWT (full load)
Crew:	98
Range:	5.75 billion km (Earth-Pluto)
Cruising speed:	2,000,000 km/h
Maximum speed:	3,075,000 km/h

### **VISUAL:**



## ***ARES IV* SURVEY PROBE**

**DATE LOST (OLD CALENDAR): 2032**

The main objective of *Ares IV* was a decade-long mapping and survey mission of the entire surface of Mars, scouting for potential colony sites as well as any other previously undetected phenomena. In this it coordinated its activities with the orbital station *Willy Ley* and the Martian Colonies on the ground. This ion impulse powered probe was nearing the end of its mission in 2034 when it and mission commander Lt. John Kelly were literally whisked away by a spatial anomaly (at that time an unknown phenomena). The survey team was left stranded on the surface, which was almost immediately enveloped by a major dust storm due to the passing of the anomaly. It took a ground rescue mission some two weeks to locate and retrieve them. The ultimate fate of the *Ares IV* still remains unknown.

### **SPECIFICATIONS:**

Length:	46 m
Diameter:	12 m
Displacement:	92 DWT
Crew:	3
Range:	interplanetary (Earth-Mars)
Maximum speed:	2,450,000 km/h

### **VISUAL:**



## COMPANION CLASS CRUISER

SERVICE ENTRY DATE (OLD CALENDAR): 2033

The *Companion* class was the UESF's first major capital ship class. It was quite popular in the years before the First Earth-Kzin War and could often be found escorting military convoys from one end of the Sol System to the other. Its extensive command and control facilities made it an ideal mobile headquarters platform. Many could also be found keeping a watchful eye over the testing of prototype spacecraft employing the latest advances in fusion reactor design and pre-warp engine technology. The weaknesses in their design did not become evident until the First Earth-Kzin War of 2048-2050. They were simply too slow and vulnerable for effective combat against the smaller and more maneuverable Kzinti vessels. Eight were destroyed in the Battle of the Sol System and another five would be lost in subsequent encounters. The class as a whole was retired in 2080. The *UES Fisher*, the last *Companion* class cruiser to be retired from active military service, was later upgraded with warp drive and renovated for use as a diplomatic courier. It is the only vessel of its class that still survives and is preserved at the Utopia Planitia Spaceyards Museum Complex at Mars (Sol IV).



### SPECIFICATIONS:

Length:	156 m
Beam:	37.9 m
Draft:	37.9 m
Displacement:	69,000 DWT
Crew:	20
Range:	up to 6 billion km
Armament:	4 forward lasers 25 fusion missiles

Cruising speed:	6,000,000 km/h
Maximum speed:	9,500,000 km/h

#### Innovations/Experiments:

- First major Terran warship class
- First Terran spacecraft class fitted with extended sensor and communications suites.

### VISUAL:

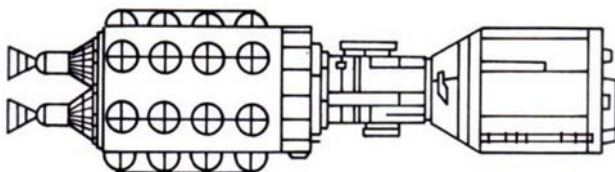

## COLUMBUS CLASS EXPLORER

SERVICE ENTRY DATE (OLD CALENDAR): 2040

The *Columbus* class represented a tremendous step forward in Terran spacecraft design. This was the first true Terran starship class and the first to utilize spiked-antimatter propulsion as its main drive. This new variation on standard impulse drive allowed these ships to reach speeds up to 0.75c. They would be obsolete within two decades once warp drive technology was perfected.

The *UES Icarus* is remembered as the first Terran vessel to visit another inhabited world (Alpha Centauri VII). It is still preserved today at the Star Fleet Space Flight Museum at Luna. The *UES Adam & Eve* was to have been the first Terran vessel to visit Barnard's Star. It was destroyed by the Kzinti in 2049 just short of its goal. There were no known survivors.

### SPECIFICATIONS:

Length:	120 m
Beam:	37.2 m
Draft:	37.2 m
Displacement:	86,000 DWT
Crew:	40
Range:	8.5 light-years
Armament:	4 forward lasers 25 fusion missiles

Cruising speed:	warp 0.75
Maximum speed:	warp 0.85

#### Innovations/Experiments:

- First Terran starship to use a spiked-antimatter engine

### VISUAL:





# DECLARATION CLASS STARLINER

**SERVICE ENTRY DATE (OLD CALENDAR): 2035**

The name *starliner* is something of a misnomer. It was Utopia Planitia's term for UESPA's first purpose-built starship, designed to explore those star systems nearest to Terra. The only thing that held these elegant ships back was their early ion impulse engines, which confined them to sublight speeds. All were built and dispatched to every single star system within range of Terra known to have habitable planets. All save one (*Enterprise*) would turn back and return to Terra before completing their missions, having been passed enroute by faster ships. Since the *Enterprise* was already over halfway to Alpha Centauri its crew decided to complete its mission anyway. It arrived in the aftermath of the first Kzinti attack on Alpha Centauri, providing much needed relief and supplies to the damaged *UES Icarus*. The starliner *Enterprise* is preserved as a museum ship at the Star Fleet Proxima (Centauri) Shipyards.

## SPECIFICATIONS:

Length:	300 m
Diameter:	210 m
Displacement:	52,700 DWT
Crew:	95
Range:	20 years at S.O.P.
Armament:	2 laser turrets 50 fusion missiles

Cruising speed:	warp 0.32
Maximum speed:	warp 0.75

Innovations/Experiments:

- First Terran starship design
- First Terran starships to carry on-board small craft

## VISUAL:



# SEARCHER CLASS SCOUT

**SERVICE ENTRY DATE (OLD CALENDAR): 2036**

The *Searcher* class was designed as a budget-sized version of the *Declaration* class. They were assigned to travel to the less prestigious (and more numerous) systems on UESPA's exploration list. The ship's small size meant that it carried no auxiliary craft for planetfall. Instead, its forward section was designed to detach from the rest of the ship and act as a planetary lander. It would re-link with the main body of the ship once a planetary survey was completed. This was the only novel item in the design of the *Searcher*. The class itself was unspectacular and would have been forgotten had it not been for the *Sakharov's* terrible first contact experience with the Kzinti. It came out the other side a flying wreck with over half of its crew dead. The class as a whole was retired shortly after the end of the first Earth-Kzin War.

## SPECIFICATIONS:

Length:	162 m
Beam:	90.3 m
Draft:	90.3 m
Displacement:	21,750 DWT
Crew:	40
Range:	20 years at S.O.P.
Armament:	2 forward lasers 25 fusion missiles

Cruising speed:	warp 0.35
Maximum speed:	warp 0.80

Innovations/Experiments:

- First Terran vessel with a detachable forward hull

## VISUAL:

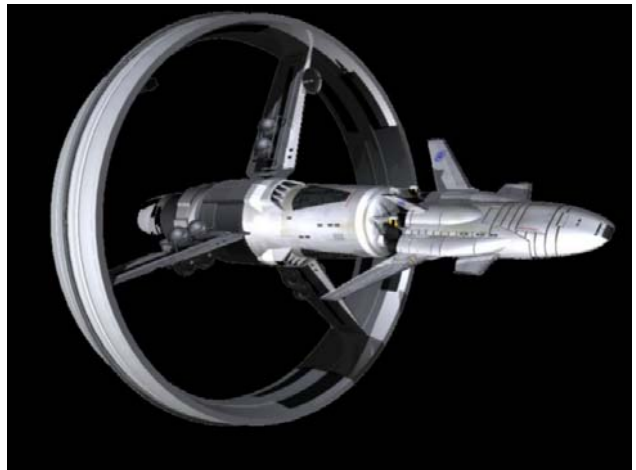

# DY-400 CLASS TRANSPORT

**SERVICE ENTRY DATE (OLD CALENDAR): 2037**

The long-delayed DY-400 class finally entered service in 2038. It had been held up for many years due to the failure of its early prototypes. Its partial reversion to the tried and true DY-100 base design represents a throwback to the tried and true; i.e. "what worked before." It was not perceived as being that much of an improvement over other exiting Dyson-Yoyodine designs, especially with the superior DY-500 upgrade also available. As a result it did not sell very well and had all but disappeared from service by 2045. A retooled version intended for the science and survey role (often referred to as the *Helsinki* class) was reintroduced in 2055. All six of the DY-400s that were eventually enjoyed moderate success during the Second and Third Earth-Kzin Wars as military intelligence gathering vessels.



## SPECIFICATIONS:

Length:	100.6 m
Beam:	36.7 m
Draft:	29.1 m
Displacement:	24,500 DWT
Crew:	16
Range:	2.5 years at S.O.P.
Maximum speed:	400,000 km/h
Maximum speed:	460,000 km/h

## VISUAL:

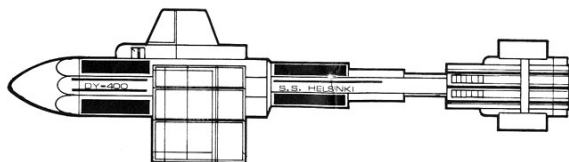

# UPDATED DY-500 CLASS

**SERVICE ENTRY DATE (OLD CALENDAR): 2038**

The updated DY-500 class was the way that Dyson-Yoyodyne had meant to build this class back in the 2020s. Economic concerns had dictated otherwise at the time. The resultant delay actually proved to be a blessing in disguise. It gave Dyson-Yoyodyne the chance to incorporate the latest in engine and secondary systems design into the updated DY-500. The class was intended to be the first production Terran spacecraft equipped with "spinner" drive but these were yanked due to the loss of the *Charybdis* from the apparent failure of such an engine. Conventional impulse drive engines were fitted instead. Production was boosted by a UESF contract for an intersystem transport, with one out of every three updated DY-500s going to the UESF. Many were refitted for combat during the Battle of the Sol System in the First Earth-Kzin War and many would also see service during the next two wars. The design would also serve as the basis for the subsequent DY-430 and DY-550 classes.



## SPECIFICATIONS:

Length:	151 m
Beam:	28.3 m (excluding radiators)
Draft:	32.6 m
Displacement:	38,500 DWT
Crew:	55
Range:	5 years at S.O.P.
Cruising speed:	435,000 km/h
Maximum speed:	475,000 km/h

## VISUAL:

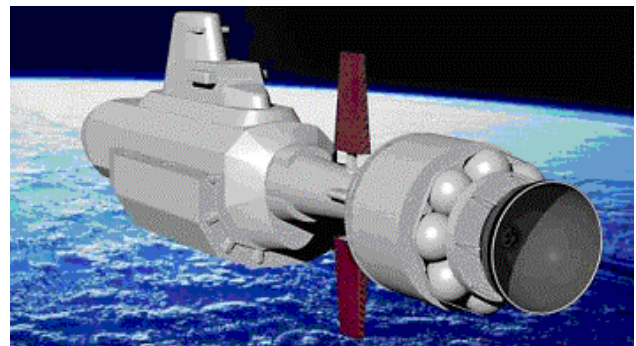

# MAGELLAN CLASS SPACELINER

**SERVICE ENTRY DATE (OLD CALENDAR): 2040**

The *Magellan* class comprised the great Terran space passenger liners of their day. In fact the word *spaceliner* was coined to describe them. These plied the Terran spaceways for over three decades, providing luxurious comfort for Sol System tourists. In an age where planetary space travel was measured in terms of days, weeks, and even months these ships were designed with every possible amenity. Their level of excellence became the *de facto standard* by which all subsequent spaceliners were measured and even today's are hard-pressed to equal.

At the time of the Earth-Kzin Wars (2048-2065) many of these were appropriated by the UESF and converted for use as troop transports. One, the *Cortez*, was lost in a convoy ambush during the Second Earth-Kzin War.

Only one was saved from the scrapper's torch. The *Prince of Wales* is preserved today in its original sublight configuration at the Federation Air and Space Museum at Terra (Sol III).

## SPECIFICATIONS:

Length:	100 m
Beam:	18.2 m
Draft:	30.9 m
Displacement:	20,000 DWT
Crew:	30 (+ 260 passengers)
Range:	800 million km
Cruising speed:	50,000 m/sec
Maximum speed:	75,000 m/sec

### Innovations/Experiments:

- First true spaceliner class
- First spacecraft fitted with luxury accommodations and accessories (such as theaters, night clubs, dining rooms, etc.)
- First Terran spacecraft fitted with lifeboat pods

## VISUAL:

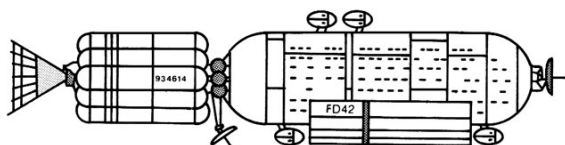

# DY-350 PROTOTYPE

**SERVICE ENTRY DATE (OLD CALENDAR): 2049**

The DY-350 program was initiated as a means of converting the proven DY-series design into a destroyer-class space warship. At the time it was meant as an escort for the *Companion* class cruiser; however, the outbreak of the First Earth-Kzin War changed that. The unfinished DY-350 prototype was hastily outfitted with weapons, existing DY-series engines, and then thrown into the fray. It subsequently scored the most kills of any single UESF ship in the Battle of the Sol System. Its effectiveness as a combat vessel was thus vindicated. The subsequent DY-X program would benefit greatly from the combat data gleaned from this prototype's performance.



## SPECIFICATIONS:

Length:	115 m
Beam:	33 m
Draft:	47 m
Displacement:	19,500 DWT
Crew:	28
Range:	4 years at S.O.P.
Maximum speed:	440,000 km/h
Armament:	4 forward lasers 5 missile pods (25 fusion missiles each)

### Innovations/Experiments:

- First DY-series designed specifically for combat

## VISUAL:

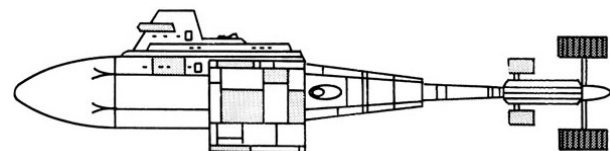

# DY-430 CLASS TRANSPORT

**SERVICE ENTRY DATE (OLD CALENDAR): 2048**

The DY-430 took the proven success of the updated DY-500 design and enlarged it in anticipation of interstellar voyaging. It was the first Dyson-Yoyodine design to employ a spiked-antimatter engine design, similar to but smaller than that first used in the *Columbus* class explorers. The needs of the Earth-Kzin Wars saw all of these appropriated by the UESF as armed interstellar transports. After the war they were returned to civilian use, where many found a new life as impromptu colony ships. At least one, the *S.S. Urusei Yatsura* (named after a popular fictional character of the day) would make it as far as the Ficus Sector, setting the all-time single-journey range record for a sub-light Dyson-Yoyodine spacecraft.



## SPECIFICATIONS:

Length:	140 m
Beam:	53 m
Draft:	45 m
Displacement:	44,500 DWT
Crew:	20 (+ 100 passengers)
Range:	5 years at S.O.P.

Cruising speed:	435,000 km/h
Maximum speed:	475,000 km/h

## VISUAL:

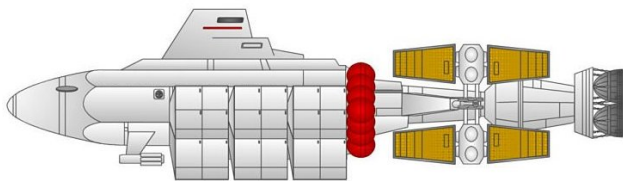

"Beam rider" spacecraft test near Jupiter (2032)



The attack on the *Searcher* (2048)



Major General Hans Dietrich  
UESF Combined Forces Commander, Earth-Kzin Wars



A DY-series takes out a Kzinti cruiser (2049)



# 2049-2065: The Earth-Kzin Wars

---



In 2048 humanity got their first contact with an intelligent, non-terrestrial, non-human species that certain of its members had for so long desired. They had hoped, prayed, built their dreams on such an encounter, imagining it to be a benevolent and peaceful exchange with a rational, highly advanced alien race that would accept humanity for the stumbling yet promising species that it was.

What they got instead were the Kzinti.

The Earth-Kzin Wars were a bloody landmark in humanity's quest for the stars. They were a brutal wake-up call to the fact that not all aliens were going to be the benevolent and peaceful species for who New Age types had for so long yearned. Like every species before them who had run afoul of Kzin, humanity had a simple choice. It could either be conquered or fight to survive. Humanity understandably chose the latter. What made them different from almost other cultures that had made the same choice, though, was that they took it one step further. They took the war to the Kzinti. They fought back with a determination and savagery that rivaled that of their feline foes. At the same time, however, they managed to keep from falling into the well of martial depravity for which the Kzinti were legend. Somehow, despite everything they suffered,

humanity never lost its nobility, its compassion, its sense of justice balanced with mercy.

---

During the war, when one of the few rare intelligent *kzinretti* escaped captivity by her people and fled to human-controlled space, humanity welcomed her with open arms. She was not treated as a second-class citizen, nor was she made an object for public spectacle. She was treated as a true equal, an intelligent being in her own right no different from a human save for the fur on her skin. The freedom that she now enjoyed was almost too much for her to comprehend. When she was asked if she had a name, she merely shook her head, saying that in her culture females didn't deserve names. When her hosts kindly asked her if she would like to have her very own name, she immediately broke down in tears. This spoke much of man's nobility during the Earth-Kzin Wars. They would be rewarded for that nobility within months of the war's end.

---

By the time the final death toll was compiled from the First Earth-Kzin War, in which humanity fought to save its very freedom and newly-found place in the stars from its would-be felinoid oppressors, more than 4,500 humans had died and over 13,000 injured in both the Sol and Centaurean star systems. That was only the beginning. It was a drop in the bucket compared to the massive casualty figures that were about to be racked up. There was another attack wave on the way and more behind them.

Information gleaned from wrecked Kzinti ships and some of the dying crewmen aboard them had made this all too clear. The standard Kzinti tactic for dealing with a new foe was to send several fleets every few years, starting with the ones closest to the new threat, in massed wave attacks until either their new foe was beaten or proved unbeatable. The data did not reveal the identity of the "unbeatables." UESF Major General Hans Dietrich, now the Unified Field

Commander of both Terran and Centaurean forces, wanted to make clear to the Kzinti that humanity were definitely among the “unbeatables.” He therefore began planning a long-term strategy designed to put the Kzinti out of action as soon as possible. In the short term this meant quickly rebuilding the combined fleets and filling them with new ships that had the armament and maneuverability to deal with their foe. In the long term this meant finding a way to strike at the Kzinti so as to break up their staggered massed-wave tactics. The first part was easy, relatively speaking. The second part would be harder, given that Terran ships were still limited to sublight velocities. Zefram Cochrane’s new warp drive wouldn’t become practical for at least another decade, given current estimates, and by then it might be too late. Another way had to be found to short-circuit the Kzin battle plan before their sheer numbers finally took their toll on Dietrich’s available resources.

Perhaps the most important discovery of the war at this time was made while Terran and Centaurean scientists were reverse-engineering captured Kzinti technology. They learned that the Kzin already possessed a form of warp drive. It was crude and incapable of sustained use. Instead, Kzinti ships would “jump” from point to point and then spend a fair amount of time in between recharging their engines for the next jump. This explained why they could travel anywhere they wanted in the Local Group within two years’ time. It was officially dubbed the *continuum distortion propulsion* (CDP) generator after current Terran experiments along the same lines. It was similar to the CDP generator technology that was being tested at Kashishowa Station prior to its destruction in 2053. Most humans called it the “jump drive” for short. Kzinti energy generation technology was roughly on the same level as humanity’s, though, which meant that the engines of their ships simply weren’t up to the massive power requirements involved for sustained cruising. This was the basic operating principle behind the “jump drive.”

When a captured Kzinti officer was asked how they came up with the CDP engine, he is said to have smiled and then snarled, “We didn’t. The pig-men did.

We took it from them. Made them build it for us. But that was long ago. We fight you now. You will meet them soon, when you lie beside their bones on our dinner tables. Softskins like you, but with hair like us and hooves for claws. Very fat. Very tasty.” The full import of his words would not be understood until first contact was made with the Tellarites in 2073.



Much has been made by the historians of Operation Rock Drop, the incredible event that brought an end to the Third Earth-Kzin War. It would have been impossible to achieve, let alone attempt, had it not been for the alien device found at Sidonia on Mars decades earlier. After years of others failing to unlock its mysteries, General Dietrich’s new scientific advisor somehow managed to discern its purpose. It was an artificial wormhole generator, the first (and still only) ever discovered by man, designed to open a tunnel in space from one point to another. No one knew why the Builders had left it behind, nor did General Dietrich frankly care. Dietrich also remembered an asteroid in orbit around the Sol System, that at one time had been a comet and was fitted with fusion engines to keep it from hitting Terra. He had in his hands both the means and method to deal the Kzinti a crushing, possibly fatal blow, provided a way could be found to power and operate the device. Dietrich was not surprised when his new scientific advisor, a man of considerable genius, quickly found a way to make the device operational. Thus was Operation Rock Drop born.

Any future plans Dietrich might have had for his new device were shattered when a Kzinti battle fleet



attacked his own, just as Operation Rock Drop was getting underway. The battle was eventually won and Operation Rock Drop a success, with the planet Kzin devastated by the asteroid strike; however, Dietrich's fleet suffered many casualties during the fight. Among these was his new scientific advisor, who was lost when the science section of Dietrich's flagship *Indomitable* was hulled during the battle. The alien wormhole generator was also wrecked beyond repair. They were both irreplaceable and the hand of Fate would never deal humanity such cards again in the Earth-Kzin Wars. General Dietrich consoled himself with the fact that they had bought enough time for Star Fleet's new warp drive ships to come on line. When the Kzinti came back, and they undoubtedly would once they had recovered sufficiently, Star Fleet would be ready for them. Star Fleet would be waiting with a fleet of ships the Kzinti could not possibly hope to defeat. On that day the Kzinti would go down and never menace humanity again.



The Earth-Kzin Wars eventually broke the back of the Kzinti Empire. Many of its former occupied systems promptly overthrew their Kzinti garrisons and declared their freedom after the fourth and final war. These would be eager to be affiliated with the Federation once that arose a few decades later, never again wanting to suffer brutal occupation as they had done under the Kzinti paw. Several of the Kzinti border sectors or former servitor races, though, broke away from the quickly collapsing Empire and declared their independence as stellar powers in their own right. These still thirsted for conquest in true Kzinti fashion and humanity would learn their names in turn. The savage M'Dok ... the lizard-like Tzenkethi ... and the genetically engineered Kzinti offshoots of the Mirak Star League ... these were the ones who, along with the shrunken Patriarchy,

would continue to trouble the spaceways for decades to come. Humanity would be there to challenge them, though, along with many newfound allies whose respect they had forever earned in their long and bloody struggle with the Kzinti.

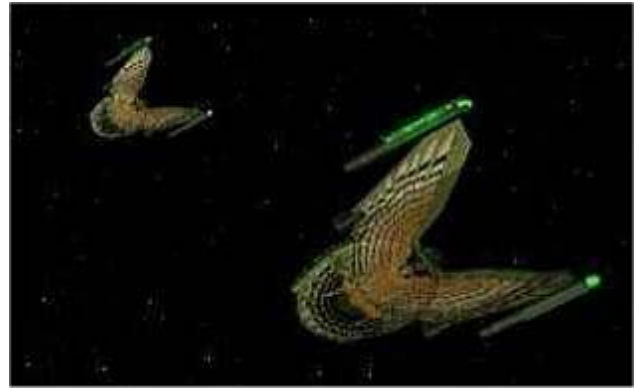

Meanwhile, on the other side of former Kzin space, two other interstellar forces sensed the shift in the balance of power along their borders. They began to push back the disorganized and disheartened Kzinti border fleets, expanding their own empires at the sake of their former foe. It would be almost a century before the first of these would encounter humanity, and another half-century more before it ran across the other. The Local Group and its newly added territories might be safe for now, but there were two other future foes already lurking over the distant horizon.

Miklos Sofia  
*The Rise and Fall of the Kzinti Empire*

# SPACESHIPS

## DY-550 SERIES TRANSPORT

**SERVICE ENTRY DATE (OLD CALENDAR): 2055**

The DY-550 was an attempt to market an “economy model” of the popular updated DY-500 series by replacing its expensive advanced impulse engine with a cheaper (and slower) power plant. Because of this it was easy to tell a standard DY-500 apart from the DY-550. All one had to do was look for the two oversized ion drive radiator plates straddling its rear-mounted engine. This earned it the unfortunate nickname of “the Flying Sub” and helped turn public opinion against it. The design was sound enough, but the public preference for the original configuration was clear. Most asteroid belt miners and other potential business customers would only buy a DY-550 provided they couldn’t afford anything better. One could always count on such new owners junking the ion drive as fast as possible and replacing it with something better, usually a DY-series fusion or impulse engine assembly salvaged from a battle wreck. The Earth-Kzin Wars were another reason for the DY-550’s failure to sell, as it drove down sales of new starships across the board. The DY-550 ceased production after only three brief years on the market.

### SPECIFICATIONS:

Length:	108.5 m
Beam:	67.3 m
Draft:	41.8 m
Displacement:	23,750 DWT
Crew:	14 (+25 passengers)
Range:	10 years at S.O.P.
Cruising speed:	warp 0.43
Maximum speed:	warp 0.60

### SCHEMATIC:

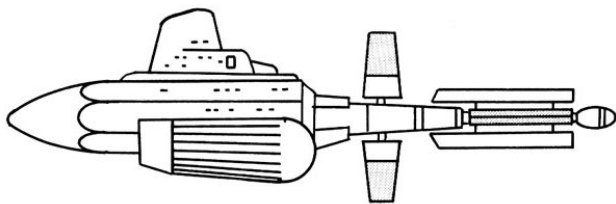

## MAHAN CLASS HEAVY CRUISER

**SERVICE ENTRY DATE (OLD CALENDAR): 2056**

After the poor performance of the *Companion* class against the Kzinti the UESF decided that a redesign was in order. The *Companion* space frames would be completely reworked in order to better combat the Kzin. Thus the *Mahan* class heavy cruiser was born. Its four main engines were built as removable modules in anticipation of a warp drive upgrade. It had two main hull hard points: one of which was almost always occupied by the new particle cannon weapons system and the other most often a multiple fusion missile rack. The biggest visual change from the *Companion*, aside from the extra armor, were the amidships wing booms with their dual rail guns. The *Mahan* still suffered in maneuverability when compared to a Kzinti vessel; however, its added arms and armor helped make up the difference. All surviving *Mahan* class starships remained in service well into the early years of the 22<sup>nd</sup> century.

### SPECIFICATIONS:

Length:	160 m
Beam:	52.9 m
Draft:	43.6 m
Displacement:	78,500 DWT
Crew:	45
Range:	10 years at S.O.P.
Armament:	6 forward lasers 4 rail guns 1 particle cannon 100 fusion missiles
Cruising speed:	warp 0.55
Maximum speed:	warp 0.68

#### Innovations:

- First Terran spacecraft to mount a particle cannon
- Most hull hard points could be cycled with different weapons systems depending on desired configuration

### SCHEMATIC:

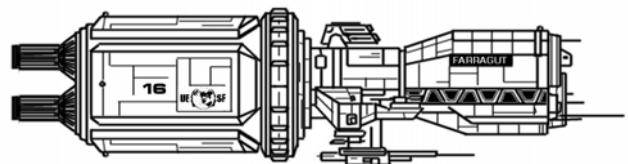

# DY-X SERIES ASSAULT CRUISER

**SERVICE ENTRY DATE (OLD CALENDAR): 2057**

Around the same time that the *Mahan* project got underway the firm of Dyson-Yoyodyne proposed a combat design based on their proven DY-series technology. This would be able to fill both the space combat and ground assault roles. The UESF, which was desperate for anything that could be used to fight the Kzinti, quickly approved the project. The armored DY-X assault cruiser entered service just in time for the Third Earth-Kzin War (2058-2060). Its unique design allowed it to operate in theaters and under conditions that were unsuitable for a *Mahan* class heavy cruiser or other UESF "heavy." The DY-X proved so versatile that it remained in the UESF inventory, with minor upgrades and improvements, until the UESF was formally dissolved as part of the founding of the Federation Star Fleet.

The DY-X was the first warship in Terran spacecraft history with an emergency separation capability. In the event of extensive damage or extreme circumstances the entire command section, from the bow all the way back to the base of the boom, could be jettisoned and operate as its own spaceship. Inside the boom were two fusion rockets arranged top-to-bottom, so as to allow room for accessways to the rest of the ship. These rockets were quite capable of propelling the DY-X boom outside of the potential blast radius of an exploding aft section within 15 seconds.

The Kzinti could not help but take note of the many "Vargas" and anime girls often painted as "nose art" on the front of the many DY-Xs (and other DY-series spacecraft) by their crews. It is said by some that the post-war infatuation that some Kzinti had with young human females arose from seeing these suggestive pictures so many times on the ships they fought during the War. It was because of this that all spacecraft nose art other than fleet-approved general designs (such as the ever-popular Evil Eyes and Tiger's Maw) were banned from the early 22<sup>nd</sup> century onward. In its place was substituted the non-suggestive Squadron Insignia Scheme (SIS) for all ships in the same class.

A fair number of DY-Xs still remain in service, having been converted for civilian transport use, as well as an almost equal number in the hands of private owners and classic starship buffs. The design remains quite popular even today due to its versatility, with a wide assortment of aftermarket kits available for restoration and maintenance as well as reproduction hulls and frame assemblies. Although Dyson-Yoyodyne no longer makes the DY-X it still supplies parts and service to their many owners. The Kloratis Drive Systems division of Cochrane Industries offers a full warp drive upgrade using trititanium frame reinforcements and its reproduction Pegasys VX-28, non-dilithium moderated warp engines. This gives any suitably modified DY-X a cruising speed of Warp 4 and a maximum speed of Warp 5.5.

A whole family of second-generation DY-X designs was planned but never built. The *MacArthur* class assault ship would have been a next-generation DY-X. The *Pegasus* was another DY-X variant, somewhat smaller and more streamlined, that was intended to fill the "light cruiser" roles for less important missions. The *John Paul Jones* class traded the delta-shaped secondary hull for a Kzinti-like spherical secondary suitable for carrier operations. The end of the Earth-Kzin Wars plus the perfection of warp drive put an end to all future development of the DY-X program, with only a reduced-scale *John Paul Jones* prototype being built. This one-of-a-kind DY-X orphan was quickly sold and converted for use by its new civilian owner as an interstellar transport. Its ultimate fate remains unknown.

## SPECIFICATIONS:

Length:	167 m
Beam:	90 m
Draft:	24 m
Displacement:	23,000 DWT
Crew:	94
Range:	3 years at S.O.P.
Armament:	3 forward lasers dual 36-pack missile racks (all models) 2 wingtip particle cannons (Fourth Earth-Kzin War)
Cruising speed:	warp 0.65
Maximum speed:	warp 0.80 (*)
(*)	CDP capable of warp 1.2 "jumps" of up to 12 minutes

### Innovations:

- First production Terran starship with a CDP generator
- First Terran starship with an emergency separation capability for its command section
- First DY-series designed for planetary landings

## SCHEMATICS:

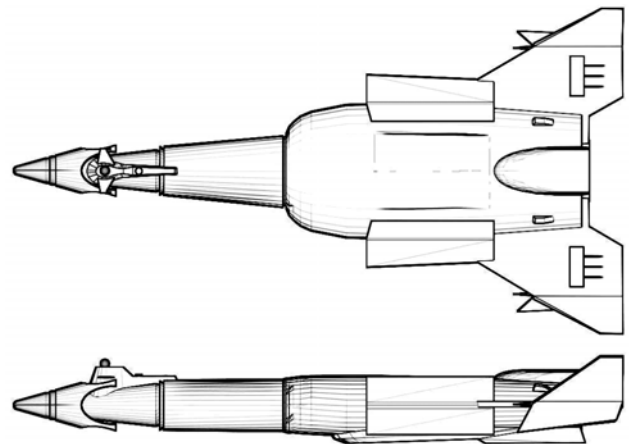



*Mahan class heavy cruiser (2056)*

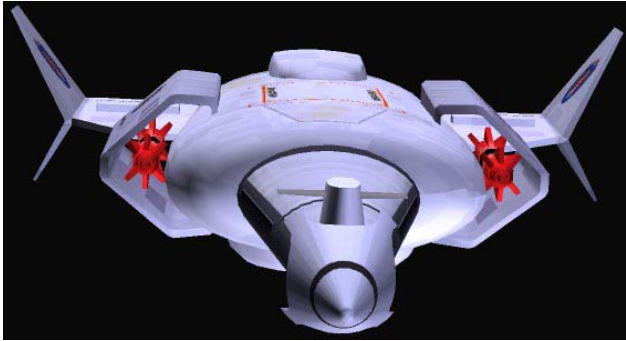

*DY-X assault cruiser (2056)*



*UESF Marine forward recon team (c.2060)*



*UES John Paul Jones (2065)*  
The only second-generation DY-X ever built

## **LIBERTY CLASS CRUISER**

**SERVICE ENTRY DATE (OLD CALENDAR): 2058**

The *Liberty* class cruiser represented the closest that humanity had yet come to building a true warp drive starship. It was the first to utilize spiked antimatter to power its CDP generator. This resulted in warp speed bursts approaching warp factor 2 for as long as the reaction could be maintained. Limited fuel reserves and the lack of proper celestial navigation gear hampered what was otherwise an excellent design. The basic engine design of the *Liberty* class, with suitable modifications, was the direct ancestor of the design used in both the *Cochrane* and *Verne* class starships. The *Liberty* class would prove the easiest of all pre-warp Terran ships to convert to true warp drive due to its engine similarities with its immediate descendants. Their sidekicks would be the later *Orion* class scouts, with a similar design and profile but a smaller crew.

The unique spiked antimatter CDP technology of the *Liberty* and *Orion* classes could be and was often used as a devastating weapon. More than once careless Kzinti vessels found themselves incinerated by the kilometers-long plume caused by a UESF captain's carefully calculated ignition of the CDP generator of his "*Liberty* ship."

### **SPECIFICATIONS:**

Length:	145 m
Diameter:	75.4 m
Displacement:	26,300 DWT
Crew:	45
Range:	5 years at L.Y.V.
Armament:	4 forward lasers 20 fusion missiles 300 kinetic-kill rockets

Cruising speed:	warp 2.0
Maximum safe speed:	warp 2.5

#### **Innovations:**

- First CDP-equipped starship to use spiked antimatter

### **SCHEMATIC:**

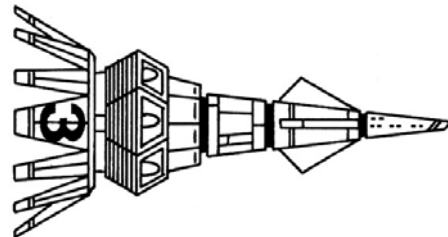

## COCHRANE CLASS CRUISER

**SERVICE ENTRY DATE (OLD CALENDAR): 2060**

These were the first dedicated interstellar exploration vessels built since the onset of the Earth-Kzin Wars. Wartime priorities were not forgotten, however. The lead ship *Bonaventure* was a conversion of the unbuilt prototype cruiser *Seneca*, which had been partially destroyed in drydock during the Second Earth-Kzin War. Once completed it became the first fully operational warp drive starship in the United Earth Star Fleet. Her first voyage was to ship Cochrane and the Centaurean government-in-exile back to their newly liberated homeworld. As soon as that was done she joined the Combined Forces as a fleet scout and saw limited action during the Fourth Earth-Kzin War. After returning home for refurbishing and systems upgrades, she was sent out on her "first" major interstellar voyage and played her part charting new systems in the postwar Second Great Space Rush. The *Bonaventure* was subsequently retired as a museum ship after being damaged by a Kzinti raide while returning from her second voyage. However, it would not be her last.

The "lines" of the *Cochrane* class would be followed in the own development path of Terran-designed starships all the way down to the *Caracal* class cruisers at the end of the 21<sup>st</sup> century.

### SPECIFICATIONS:

Length:	206 m
Beam:	63.4 m
Draft:	66.7 m
Displacement:	19,400 DWT
Crew:	45
Range:	6 years at L.Y.V.
Armament:	2 forward lasers

Cruising speed:	warp 2.0
Maximum safe speed:	warp 2.5

#### Innovations:

- First Terran starship with true warp drive
- First starship with a separable command section.
- First starship to use a celestial (non-Terran oriented) navigation and guidance system.

### SCHEMATIC:

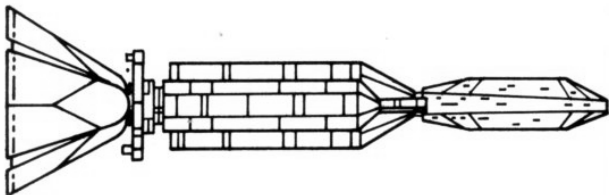

## VERNE CLASS SURVEY CRUISER

**SERVICE ENTRY DATE (OLD CALENDAR): 2064**

The *Verne* class survey cruisers were widely regarded as the most innovative and visually stunning of Terra's first generation of warp drive starships. Originally based on a wartime United Americas design, their unique design and proven reliability were admired by would-be starship engineers across the Sol System. They were the first to mount triple external warp engines (feeding into a common thrust system). Although built too late for the Earth-Kzin Wars, the class starship *UES Verne* ferried Sol System representatives to the Sirius star system for the signing ceremony of the Treaty of Sirius. The *Verne* class starship *UES Amity* is officially recognized as making first contact with the Vulcans after the end of the Earth-Kzin Wars. A total of 18 were built, all of which were retired by 2095.

### SPECIFICATIONS:

Length:	235.9 m
Beam:	80.4 m
Draft:	50.0 m
Displacement:	25,000 DWT
Crew:	112
Range:	5 years at L.Y.V.
Armament:	8 forward lasers 50 fusion missiles

Cruising speed:	warp 2.5
Maximum safe speed:	warp 2.7

#### Innovations:

- First Terran starship with triple warp drive nacelles

### VISUAL:

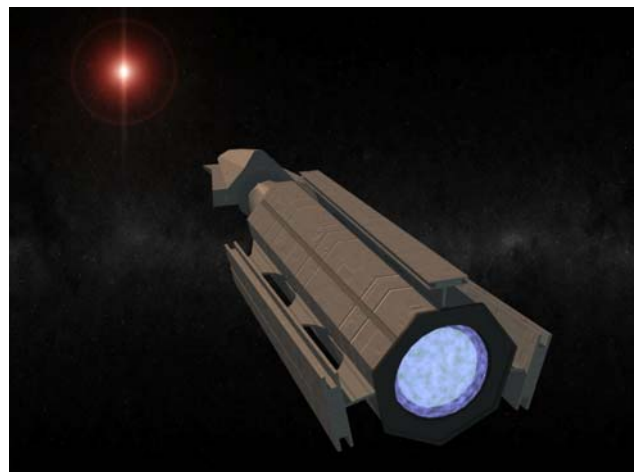



# ALIEN STARSHIPS

## KZINTI PATROL CRUISER

**DATE FIRST SIGHTED: 2048**

The Kzinti patrol cruiser was the most commonly encountered type of Kzinti vessel during the four Earth Kzin Wars. It was extremely agile despite its size due to its polarized graviton drive system. In contrast to Terran "brute force" sublight engines, this worked by manipulating the local gravity fields around the ship. Kzinti ships could maintain cruising speeds of 0.70c and emergency sublight bursts of up to 0.90c. They were also capable of planetary landings, something that few Terran "heavies" at the time could do. The one flaw in a Kzinti patrol ship, though, was the same thing that made it such a slippery opponent. There was no form of protection for its graviton drive's main cooling vent and the ship's weapon arcs were not designed to cover it. The Kzinti never bothered to address this issue, choosing to produce more ships instead and hoping that sheer numbers would win out over Terran doggedness. It didn't.

### SPECIFICATIONS:

Length:	248 m
Diameter:	185 m
Displacement:	115,000 DWT
Crew:	65
Range:	10 years at L.Y.V.?
Armament:	2 forward lasers 200 fusion-style missiles

Cruising speed:	warp 0.65
Maximum speed:	warp 0.90 (*)
(*) CDP capable of warp 1.2 "jumps" of up to 12 minutes	

#### Innovations:

- First Kzinti starship design ever encountered

### SCHEMATIC:

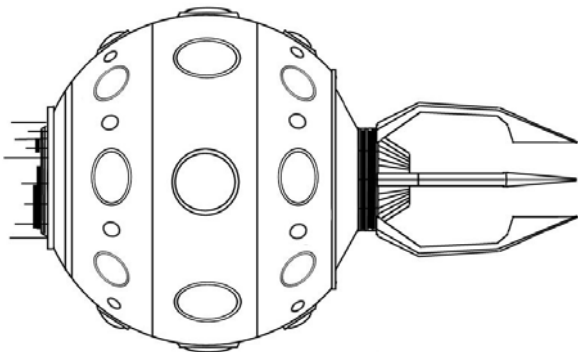

## KZINTI DESTROYER

**DATE FIRST SIGHTED: 2054**

These were the largest vessels ever fielded by the Kzinti during the war. This was the one Kzinti capital ship class that could literally make mincemeat out of any UESF ship that crossed its path – provided it had time to charge and fire its graviton gun. A graviton gun was used to hull the L-5 space colony *Brynnar City* during the Second Earth-Kzin War, killing almost its entire population in the process. This formidable weapon would also eventually prove to be its downfall, though. It took almost 1½ minutes to prime the weapon for firing, though, during which time the ship was incapable of using its jump drive or firing its other beam weapons. Human particle beam cannon, while having neither the range nor firepower, could recharge in a matter of seconds and were almost as effective in close combat. UESF starships could easily close to combat range and open fire with their particle cannon while a Kzinti destroyer was still waiting to charge up its graviton gun. The Kzinti eventually figured out a way for destroyers to fire their graviton guns on a half-charge; however, by then the humans had gained the upper hand in both technology and tactics. All surviving Kzinti destroyers were scrapped per the terms of the Treaty of Sirius in 2066.

### SPECIFICATIONS:

Length:	329 m
Beam:	126 m
Draft:	145 m
Displacement:	173,850 DWT
Crew:	40 (plus @100 troops)
Range:	10 years at L.Y.V.?
Armament:	8 lasers graviton gun 400 fusion-style missiles

Cruising speed:	warp 0.65
Maximum speed:	warp 0.90 (*)
(*) CDP capable of warp 1.6 "jumps" of up to 15 minutes	

### SCHEMATIC:

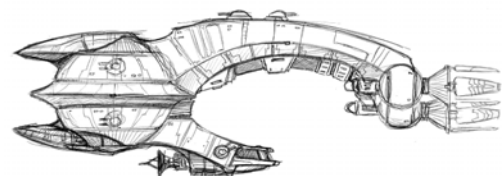

# 2066-2100: Joining the Local Group

---

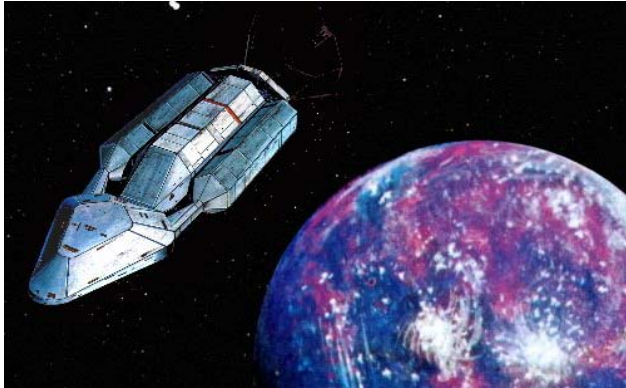

Warp drive is a rare example of a technology that takes vast amounts of resources and time to develop, but then immediately offers total compensation for the effort. Vulcans have once calculated that a culture will either initiate a massive exploration and colonization program within 50 years of the invention, thus beginning the inevitable arc of galactic conquest, later complacency, and final fall to complete oblivion; or then it will hesitate with using the warp drive, and stagnate completely until awakened by warp-borne visitors. In the rare case it meets an aggressive neighbor in near-equal terms, it may also become a single-planet military power bent on isolationism and highly proficient in achieving that goal.

Earth seems a type A1 example of the first path. Despite the wounds of its recent wars, the planet sent out more than 50 warp-powered ships within ten years of Cochrane's flight. Within 30 years, more than 5000 vessels had left for parts unknown, and six colonies had been founded on empty Class M worlds. One of these was lost soon thereafter, but it did not deter the other hopefuls in the slightest. In comparison, none of the other warp-capable cultures were expanding into Earth's immediate vicinity. The earliest years of the UESF thus represent a rare opportunity to observe a space navy evolving in a power vacuum, unhindered and uninspired by external threats. Whatever hindrance or inspiration Earth's Vulcan protectors provided remains a matter of some disagreement even after several centuries of study.

The Terran vessels developed during this time are in many ways exceptional for an ascending interstellar power. Races beginning their star travel amidst other FTL cultures are often forced to accept an excessively military posture to survive in the competitive environment, and this normally limits the experimentation done on high speed and long range propulsion, as well as curtailing exploration programs. The basic design of these vessels in turn places great importance on these very aspects, while featuring very limited offensive and defensive armament. The ubiquitous 'boomer ship' of the 2090s-2140s is a remarkable exception from galactic norm, a design sacrificing everything else for the superior ability to engage in interstellar trade. The conscious choice of UESF to dedicate major resources to aiding in the creation of this nonmilitary fleet is an equally unique sacrifice in galactic history, at least among those cultures that have survived beyond their first century in space.

Timo Saloniemi  
*Hobbyist's Guide to the UFP Star Fleet*

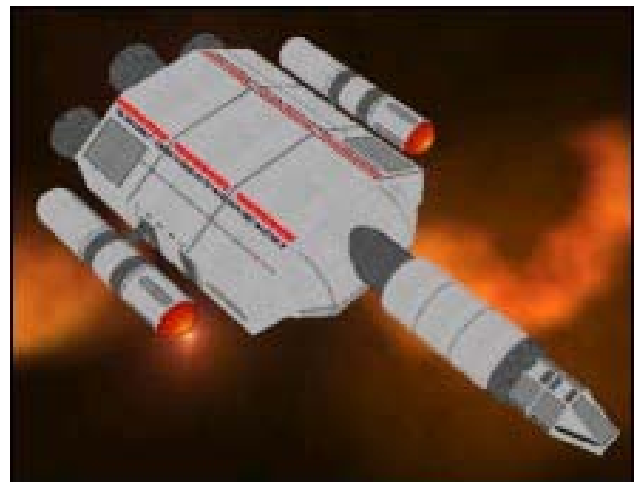

Galactic survey cruiser *S.S. Defiant* (2064)

# TERRAN STARSHIPS

## ***KELDYSH* CLASS SURVEY CRUISER**

**SERVICE ENTRY DATE (OLD CALENDAR): 2064**

The *Keldysh* class survey cruiser was Zephram Cochrane's first major peacetime starship design to be built. The intent was for these ships to undertake the first surveys for UESPA of the holdings of the former Kzinti empire beyond Local Group space. The lead ship, *Keldysh*, had been converted from the wrecked hull of the wartime prototype battlecruiser *Seneca*. They performed admirably as survey cruisers despite their rather ungainly looking design. Its boom-mounted circumferential warp engine arrangement was copied directly from Cochrane's own warp drive prototype. This would prove to be the herald of things to come. The class remained in service, with periodic upgrades and swapping of old engines for new, until 2130.

The most notable member of the class, the *Valiant*, was lost in the upper quadrants of known space near the edge of the galaxy. It had been following the projected route of the Terran spaceship *Courageous*, lost almost four decades earlier, in an effort to determine what had happened to the ship and its crew. The ultimate fate of the *Valiant* would remain a mystery until its recorder-marker was found by the starship *Enterprise* in 2261.

### **SPECIFICATIONS:**

Length:	92.4 m
Beam:	41.1 m
Draft:	17.0 m
Displacement:	16,900 DWT
Crew:	80
Range:	5 years at L.Y.V.
Armament:	2 laser cannon 8 fusion missiles

Cruising speed:	warp 2.05
Maximum speed:	warp 2.10

#### Innovations:

- First starship class built after the Earth-Kzin Wars
- First starship class with boom mounted warp engines

### **VISUAL:**

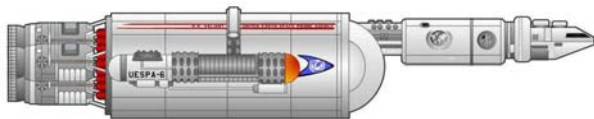

## ***TERRA* SERIES SPACE ARK**

**SERVICE ENTRY DATE (OLD CALENDAR): 2067**

The Space Arks started out life as a series of massive mobile industrial refineries intended for raw materials extraction just beyond the Solar System. Their rugged construction was due both to the ongoing Earth-Kzin Wars and the fact that they were to spend most of their time operating in the Kuiper Belt and Oort Cloud zones. Their massive design and industrial origins precluded the use of jump or warp drive; instead, a series of four fusion reactors powered a common large impulse drive system that could achieve a cruising speed of 0.5c. The end of the war brought an end to the need for these vessels, so seventeen hulls in various states of completion were sold off to the highest bidder. Hulls 1-10 and 15, which were over 50% complete, were eagerly snapped up by private colonization consortiums. These were looking for ready-made or near-ready ships that could be adapted for long-range interstellar voyages. The others (11-14) were scrapped for salvage. The fact that these were sublight vessels mattered little to the colonists, who were planning for multigenerational voyages anyway. All but the last two, *Terra 10* and *Terra 15*, would never reach their destinations, falling prey to various dangers en route.

### **SPECIFICATIONS:**

Length:	306 m
Diameter:	140 m
Displacement:	34,600 DWT
Crew:	35 (+500 passengers)
Range:	100 years at S.O.P. (est.)

Cruising speed:	warp 0.50
-----------------	-----------

### **VISUAL:**

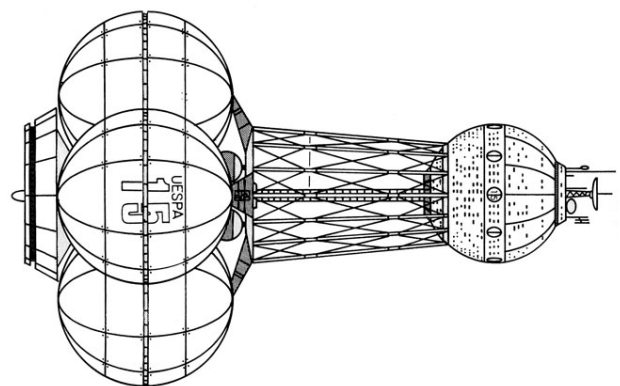

## CONESTOGA CLASS COLONY SHIP

SERVICE ENTRY DATE (OLD CALENDAR): 2069

These were the first purpose-built Terran colonization craft capable of warp speed. The design was fairly simple, in essence a warp engine frame built around a colonization cubicle designed for re-entry and landing on a hard planetary surface. Such landings were always permanent. *Conestogas* had to jettison its warp engines as part of the atmospheric entry procedure, and the onboard fusion reactors for powering ship's systems (and the planned colony) were insufficient to lift it back off again. Provided a successful landing had been achieved, the crew would then revive the colonists (suspended in cryosleep chambers) and unseal the cargo holds, which held all of the gear necessary to establish the new colony. Strictly speaking, this made a trip aboard a *Conestoga* a one-way proposition but one that its passengers eagerly accepted, risking their lives in order to establish new homes on a previously unknown world. Five of six *Conestoga* missions would ultimately prove successful, with the Terran colony of Ophiucus being the most notable. The design was withdrawn from production in 2080, by which time more advanced designs had replaced the *Conestoga* in the colonization role. The remaining unused ships in the class were reconfigured for use as transports and so served until withdrawn from service in 2098.

### SPECIFICATIONS:

Length:	197.2 m
Beam:	71.0 m
Draft:	34.9 m
Displacement:	23,800 DWT
Crew:	25 (+200 colonists)
Range:	10 years at L.Y.V.
Cruising speed:	warp 1.60
Maximum speed:	warp 2.00

### VISUAL:



## MERCHANT CLASS CARGO HAULER

SERVICE ENTRY DATE (OLD CALENDAR): 2072

The *Merchant* class has the unenviable reputation of being one of the ugliest little Terran starships ever to see service. It was nothing more than a basic frame with an unlicensed copy of a Utopia Planitia command module mounted on one end and a stripped-down GSC-1600 warp engine assembly on the other. The frame itself provided a central anchor for almost every kind of cargo module used by humanity from the old DY-series of the late 1990s up to current models. It was not designed for beauty, however. It was an interstellar trader, pure and simple. Utopia Planitia promptly filed a lawsuit over the original command module design, eventually forcing a different design to be installed on later ships in the class.

The *Merchant* class would have been forgotten had it not been for the *Marco Polo*, the only starship of its class to ever achieve fame. The *Marco Polo*, under the command of Lorenzo Malfatti, was the first Terran starship to visit the Rigel System and its Orion colonies. The *Marco Polo* would return to the local group with eager Orion traders in tow, anxious to take advantage of this previously unknown and untapped market for their own personal gain. Later, near the end of its career, it would discover the interstellar phenomena known today as "Polo's Bolos," twin black holes locked together in a perpetual interstellar wrestling match. The original *Marco Polo*, like the other members of its class, was eventually scrapped; however, its name lives on in each successive generation of Star Fleet survey cruisers.

### SPECIFICATIONS:

Length:	42.1 m
Beam:	25.2 m
Draft:	7.9 m (w/o landing gear)
Displacement:	14,200 DWT
Crew:	14
Range:	1.5 years at L.Y.V.
Armament:	4 forward lasers (+ various owner mods)
Cruising speed:	warp 1.00
Maximum speed:	warp 1.60

### VISUAL:





## FRANKLIN CLASS SCOUT

**SERVICE ENTRY DATE (OLD CALENDAR): 2075**

The *Franklin* class was the last of the “flared arrow” starships. Its origins like in the spiked antimatter war-era *Orion* class scout. These were built for speed and maneuverability, with intelligence gathering as their primary function. Their unique design heritage precluded easy upgrades and shortened what might have been longer service lives. A few saw service in the early years of the War with the Vegan Tyranny but they were hopelessly outclassed by Vegan ships. The last was retired in 2095.

### SPECIFICATIONS:

Length:	45 m
Diameter:	20 m
Displacement:	55 DWT
Crew:	4
Range:	5 years at L.Y.V.
Armament:	4 forward lasers 50 fusion missiles

Cruising speed:	warp 2.25
Maximum safe speed:	warp 2.50

#### Innovations:

- Last of the “flared arrow” spiked antimatter starships

### VISUAL:

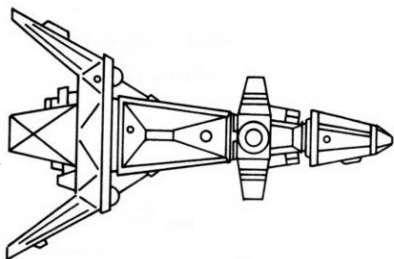

## MESSIER CLASS CRUISER

**SERVICE ENTRY DATE (OLD CALENDAR): 2078**

The *Messier* class starships, the most heavily armed starships of their time, were Star Fleet’s first major warship class since the end of the Earh-Kzin Wars. Almost everything about it reflected the angular design philosophy prevalent among Terran starship engineers at the time. The engines, however, were provided by Cochrane Warp Dynamics of Alpha Centauri. 28 were built between 2078 and 2100. With periodic refits they continued to serve well into the Romulan War era.

This was the first Terran starship to include the new subspace radio. Its only drawback was that it was useless outside of the Local Group subspace net. This drawback was partially offset by the addition of temporary subspace transponders, which it could drop every two light-years outside of Local Group transmitter range as needed.

### SPECIFICATIONS:

Length:	258.0 m
Beam:	113.8 m
Draft:	72.1 m
Displacement:	108,600 DWT
Crew:	93
Range:	4 years at L.Y.V.
Armament:	8 laser banks 4 particle cannon 55 fusion missiles

Cruising speed:	warp 2.75
Maximum safe speed:	warp 2.90

#### Innovations:

- First starship with subspace radio.
- First Star Fleet starship class with integrated crews

### VISUAL:

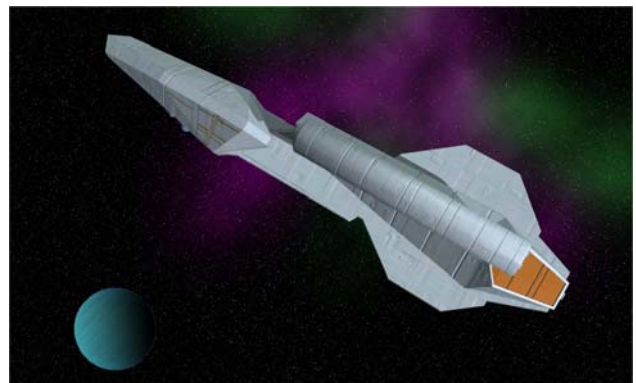

## COSMOS CLASS SCOUT

**SERVICE ENTRY DATE (OLD CALENDAR): 2082**

The 38 vessels of the *Cosmos* and later *Huey* classes together make up one of the more unusual starships of their era. They were designed from the onset as multi-mission capable. A variety of different sensor pallets, ranging from heavy to light, could be fitted to the ship's cylindrical nose depending on the mission at hand. Most of the time these carried the heavy Explorer sensor pallets for exploration and survey of new star systems from a distance. They entered service just in time for the War with the Vegan Tyranny and often served as intelligence gathering ships. Their most notable accomplishment for UESPA after the war was helping to complete the initial surveys of the New Territories, from which the first navigational charts of the region were made. All were retired by 2120.

### SPECIFICATIONS:

Length:	229.3 m
Beam:	101.2 m
Height:	54.0
Displacement:	36,700 DWT
Crew:	100
Range:	8 years at L.Y.V.
Armament:	none
	( <i>Cosmos</i> class)
	2 forward lasers
	50 fusion-style missiles
	( <i>Huey</i> sub-class)

Cruising speed:	warp 2.2
Maximum speed:	warp 2.9

### VISUAL:

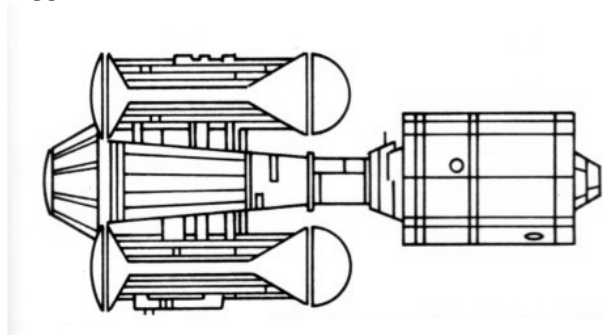

*Cosmos* class scout  
(*Huey* configuration almost identical)

## EDISON CLASS CRUISER (DY-1000)

**SERVICE ENTRY DATE (OLD CALENDAR): 2084**

The DY-1000 *Edison* will forever be known as "the ship that broke Dyson-Yoyodyne." It represented their last, best hope to regain the monopoly they once held on the Terran spacecraft industry. Given the excellence of the competition it is surprising that it would have produced such a subpar design, but that it did. Its fatal flaw was its lack of sufficient meteoroid shielding. The *Edison* was severely damaged by multiple meteoroid strikes while on a test run through the Kuiper Belt and wound up with just over a third of its compartments hulled. Fortunately none of its crew were lost; however, its engine room was among the compartments wrecked by the meteoroids. The disabled ship had to be towed back for major repairs. Dyson Yoyodyne's stock rating fell with each day that it took for the *Edison* to return to the Pluto Test Range. By the time it was berthed and undergoing repairs the company was filing for bankruptcy.



The orphaned *Edison* eventually found a home with UESPA as a science probe training ship. It was also frequently loaned to higher educational institutions for space science excursions across the Sol System. It enjoyed a longer life than it deserved in this new role, finally being retired in 2139. Ironically, it sits in orbit beside the *Tritium* (another notable failure) at the Terran branch of the Federation Air and Space Museum.

### SPECIFICATIONS:

Length:	245 m
Beam:	44.5 m
Height:	78.3 m
Displacement:	34,000 DWT
Crew:	58
Range:	10 years at L.Y.V.

Cruising speed:	warp 1.50
Maximum speed:	warp 2.00

### VISUAL:

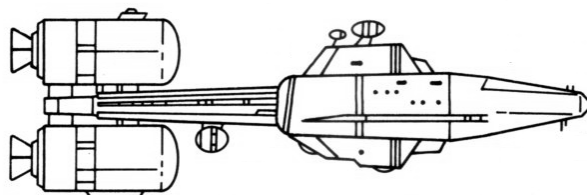

# ALIEN STARSHIPS

---

## VULCAN SURVEY CRUISER

### *SR'NARAI* CLASS

---

Vulcan ship designs were unique among Local Group starship designs prior to Terra joining the scene in the 21<sup>st</sup> century. Their ships were the only warp-capable ones at the time to utilize a toroidal drive system. Terrans quickly dubbed them “ringships” after their own sublight ringship designs, such as the *Declaration* and *Searcher* class. Utopia Planitia would copy aspects of these graceful vessels into its own line of Terran warp drive ringships, most notably the *Valkyrie*, *Bellerophon*, and *Atlas* classes.

The *Sr'narai* is typical of the period. The design was the most advanced starship fielded by a member of the Local Group during this time. Other contemporary Vulcan capital ship designs were merely logical extensions of the basic *Sr'narai* design principles.

#### VISUAL:

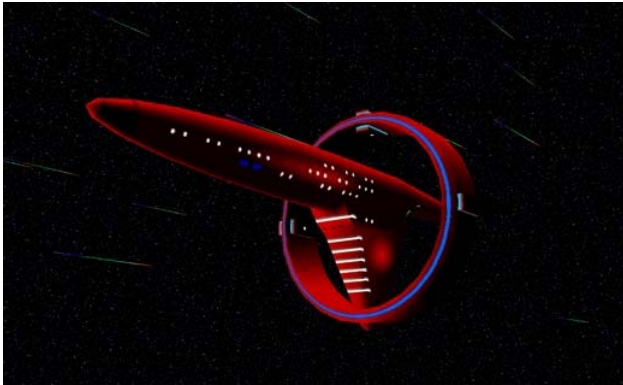

## CENTAUREAN CRUISER

### *DJARTANNA* CLASS

---

The starships of Alpha Centauri followed their own distinct development path apart from that of its brother planet Terra. Thanks largely to the influence of Zephrae Cochrane, Centaurean designs quickly adopted a boom nacelle approach. As with the earlier *Keldysh* class survey cruisers, these typically had two warp engines mounted on booms away from the main body of the ship. This both allowed for the formation of a more stable warp field than contemporary Terran designs and permitted the engines to be jettisoned in case of an emergency. Like the earlier *Keldysh* class, one can see in the *Djartanna* class the faint beginnings of what would eventually become Star Fleet's Class I starships.

The *Djartanna* class starship was the first non-Terran starship design to be incorporated into Star Fleet. It was also the last “local” design produced for Star Fleet before its own dedicated starship classes entered service.

#### VISUAL:

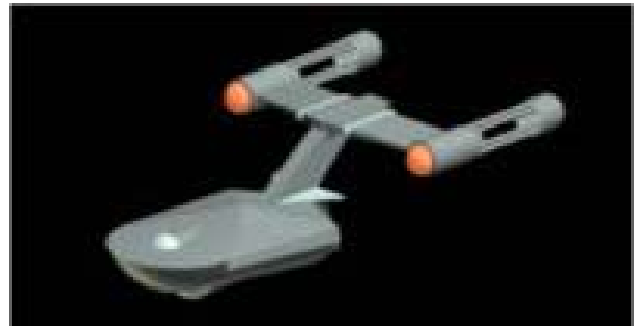

## “EARLY” ANDORIAN CRUISER

---

### ***NARSH* CLASS**

It should come as no surprise that a species known for its warlike culture would field a warship as its first major warp-capable starship. The Andorian *Narsh* was the main patrol ship of the 14-world Andorian empire at the time of first contact with humanity. Although its warp drive systems were not as sophisticated as those of human starships of the era it literally bristled with weapons in comparison. Only the *Messier* class cruisers of the Terran Star Fleet were as heavily armed as an Andorian *Narsh* class battlecruiser. This reflected the prevalent Andorian military tactic of responding in strength with overwhelming firepower to any perceived threat. This design philosophy was similar to that of the Klingons, with both cultures fielding comparable armed battlecruiser designs around the same time. One can only speculate as to how any of these might have fared had they met each other in mortal combat.

Only one example has survived the passage of time. The *Narsh* was sold for use as a regional defense ship in 2140. After the Romulan War the Andorians reacquired the *Narsh* and restored it as a museum ship. It is one of only five “home-grown” starship, all warships of different designs and eras, that the Andorians have so honored. It can be seen and visited inside its permanent berth at the main orbital access complex above Andor.

### **VISUAL:**

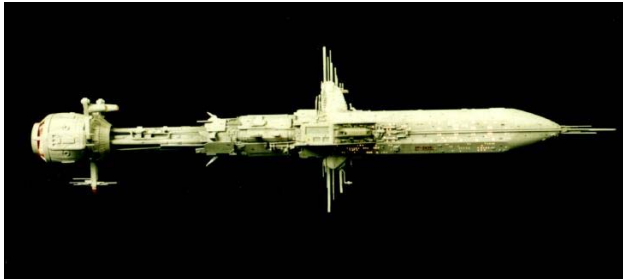

## “LATER” ANDORIAN CRUISER

---

### ***KUMARI* CLASS**

The *Kumari* was the last and arguably the best starship class fielded by the Andorians prior to the dissolution of major Federation member local fleets. It is as much a tribute to Andorian ingenuity as it is martial philosophy. It is as heavily armed as its human, Vulcan, and Klingon contemporaries. It could do one thing no other capital ship of its era could do, though, and that was make planetfall. The harsh conditions of the Andorian homeworld dictated this facet of its design; however, its tactical advantages are obvious. These were employed to their fullest by the famed “Blue Fleet” of the Romulan War, the same that won the Battle of Winston’s Star and saved the Federation flank from being turned during the Romulan’s first major offensive.

The overall excellence of the *Kumari* ensured that it would soldier on long after the rest of the Andorian fleet was gone – first as a regional defense ship, then as an armed trader and ambassadorial vessel. Some two dozen still survive today, of which all but a few remain under Andorian ownership. The Starfleet Marines have two of their own, gifts from the Andorian government, which have been converted for use as auxiliary assault craft.

### **VISUAL:**





# **22<sup>nd</sup> CENTURY**

---

## **The Rise of the Federation (2101-2200)**

# 2101-2150: The Birth of the Federation

---



The United Federation of Planets was formed from the most unlikely of circumstances. The hand of fate, or most likely the long-term designs of some long-ago advanced civilization now extinct, had placed five highly advanced humanoid civilizations within 20 parsecs of each other. These would become known as the Local Group. All save the Vulcans developed interstellar spaceflight within a two to three millennia timespan. All save the humans had endured the Kzinti scourge (or tolerated, in the case of the Vulcans) and survived until relief finally came in the form of the Earth-Kzin Wars. All had an ingrained desire to seek new worlds to contact and colonize, new peoples and civilizations whose very differences from them would show them the path towards new knowledge. None of these expected to find alien cultures with the same dreams and desires so close to themselves. The Vulcans, the eldest and most advanced, were the first to grasp the significance of this situation. Long before the end of the Kzinti Empire they were already moving, slowly yet deliberately, to bring these five disparate peoples together and band them together into an interstellar alliance the likes of which the galaxy had never seen.

The notion of an alliance of federation of some sort among the members of the Local Group was an

inevitable necessity. None welcomed the notion that all were competing for the same worlds within the Local Group, let alone the vast tracts of space opened up for exploration in the New Territories by the fall of the Kzinti Empire. Habitable or adaptable worlds were few and far between and already, as the case of Vega IX had shown, these were going to be hotly contested. The humans of Terra and Alpha Centauri by far had the strength and the will to build a Terran Empire had they so desired; however, they did not. Their own recent experiences coupled with the agony of the four Earth-Kzin Wars was part of the reason. The restraining influence of the Vulcans, smaller in number by far but with superior technology, plus their sometimes vexing yet always admirable dedication to logic and reason, was another. The perils of assumed belligerency had been graphically illustrated when first Tellar Prime and then Andor earned their places in the Local Group. The option of empire building was thus quickly jettisoned once these five cultures – Terran, Centaurean, Vulcan, Tellarite, and Andorian – came together. The other lesser worlds of the Local Group, both colonies and independent cultures, naturally looked to these five for leadership and direction after the fall of the Kzinti. It was thus only natural that they take the lead in picking up the pieces left behind by the war.

It seemed a given, even by the Vulcans, that humanity would form the backbone of this new interstellar alliance. It was the most populous and vigorous culture by far. Its desire to explore and colonize had already brought it in contact with almost every major and minor species of the Local Group, with more and more outreach into the New Territories every day. It had proven its martial abilities on behalf of those in its care during the Earth-Kzin Wars, displaying what was to all save the Vulcans a remarkable talent for learning from its enemies and using that knowledge against them. Such drive and determination for both peace and war would be needed in the new alliance. The only real issue was how to temper this desire for the common good. The other members of the Local

Group were leery of the idea of a permanent alliance for this very reason until humanity could prove it could work for the common good. Even given the proofs of the Earth-Kzin War and the War with the Vegan Tyranny, it would take much diplomacy on the part of Vulcan before the interstellar alliance for which it had so long worked began to coalesce and form.

The brief war with what remained of the Vegans reminded the members of the Local Group that there were more foes other than the fallen Kzinti still lurking in the Sea of Stars. A common alliance would be necessary to deal with such a threat. Humanity might be able to do it alone again; however, the best interests of all would be served by working together for the common good. A common alliance would also benefit the peace that would come after such conflicts, peace like that which the Local Group now currently enjoyed. Common trade protocols, a universal system of exchange, compatible laws, joint projects and cultural exchanges, and so on. The differences that made each of them unique could unite to make them stronger and thus benefit the common good. So the Vulcans said, time and again in their own quiet way each time a conference on the subject of alliance was held. The first did not succeed, nor did the second. Gradually, though, over the years and with the patient sponsorship of the Vulcans, the notion of alliance finally took hold.

The final obstacle towards the founding of the Federation was the biggest. Each of the Local Group powers would have to give up the bulk of their space fleets and pool them together in a common force for the common good. Terra's Star Fleet, by far the largest, best equipped, and most experienced, would serve as the foundation model for the new Federation Star Fleet. Naturally this caused protests among the Tellarites and Andorians, each proud of their own accomplishments and unwilling to break up their fleets in order "to ensure human dominance of the stars." Both the humans and Vulcans had to remind them that Terra, alone of all Local Group cultures, was already moving toward a multicultural, multi-ship fleet. Following the Terran lead would allow the others to both draw down their own fleets to local

defense levels while at the same time maintaining their cultural independence and importance. It was a political ploy, pure and simple, but it worked. There was no future for the Federation without Star Fleet. There was no future for Star Fleet without Local Group acceptance and support. The "local fleet" compromise broke the stalemate and cleared the last hurdle on the path to unity. The Articles of Federation were signed by representatives of the five major powers of the Local Group on May 8, 2127 (Terran Old Calendar). With that, the United Federation of Planets was born.

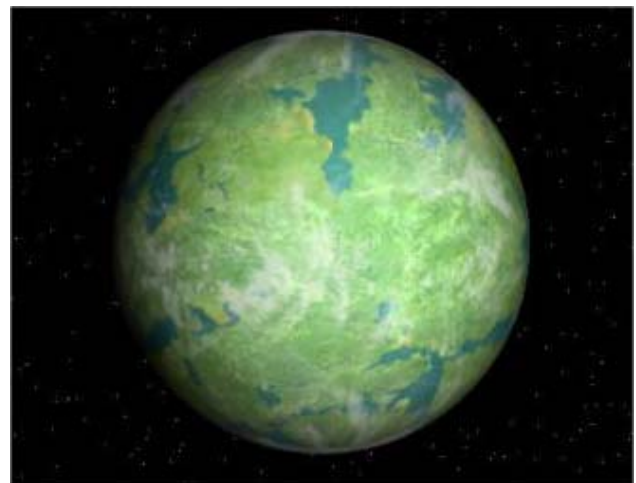

The planet Babel, site of the signing of the Articles of Federation (2127)



The last of the Vegan Tyranny voidships, shortly before its self-destruction in 2093

# SPACESHIPS

## ***ROANOKE* CLASS TRANSPORT**

**SERVICE ENTRY DATE (OLD CALENDAR): 2105**

The new century ushered in a new class of Terran space transports. *Class J* cargo ships were something of an innovation at the time. They featured a redesigned cargo container grapple-and-tow system whereby these vessels could snake additional containers behind the ship in a train, towing these along with the ship's on-board cargo to their intended destination. The only limitations were the power of a Class J starship's warp engines (which limited just how many containers it could tow), and the limits to which its trailing warp field could be extended to cover the "stretching" of the ship in this manner. A three-container configuration was typical, with five representing the uppermost limit. The basic concept of the container-train configuration has proven so successful that it has remained virtually unchanged ever since.

*Roanoke* was the first of the Class J cargo ships. As with most vessels of its type crew spaces were at a premium. The ship's complement of 19 was squeezed together on three decks in conditions approximating those of an old DY-series starship. Oftentimes crewmembers would set up temporary quarters in the ship's lone shuttlecraft or even in the foremost cargo container. The latter was usually a costly proposition, though, and not followed unless the job involved a voyage of extreme duration. The less space needed by the crew meant the more that could be used for cargo ... and in the end, making a profit by hauling cargo was what a Class J starship was all about.

A total of 53 *Roanoke* class transports were purchased from Terra for the fledgling Star Fleet shortly after the founding of the Federation in 2127. These would form the core of its transport division, which evolved over many decades into the organization we know today as Starfleet Transport Command. These remained in service until the early 2200, thanks to numerous system and engine upgrades.

### **SCHEMATICS:**



### **SPECIFICATIONS:**

Length:	76.2 m
Beam:	58.8 m
Draft:	32.1 m
Displacement:	19,400 DWT
Crew:	20
Range:	6 years at L.Y.V.
Armament:	2 laser banks

Cruising speed:	warp 1.5
Maximum speed:	warp 2.2

#### Innovations

- First Terran transport to utilize a linked cargo container "train" system to increase cargo capacity.

### **VISUALS:**



# PROMETHEUS CLASS RINGSHIP

**SERVICE ENTRY DATE (OLD CALENDAR): 2105**

The *Prometheus* class was arguably the most advanced and certainly the most unique Terran starship design of its generation. Improvements in ringship drive technology learned from the Vulcans allowed the starship engineers of Utopia Planitia to take their *Declaration* class design and refine it for the next generation. The new class could hit Warp 2 faster than any other Terran starship and could reach (and sustain) Warp 3 with ease. The only limiting factors as to its top speed were its structural integrity and its unusual tachyonic hyperdyne power plant. The engine had a theoretical limit of Warp 4.2; however, field trials showed that the design tended to get “the shakes” above Warp 3.1, becoming more pronounced with each 0.2 increase in warp speed. An unmanned prototype had torn itself apart at Warp 3.87 so the actual production design was never pushed beyond Warp 3.2. This was one of the first real-world indications of the semi-mythical Warp 4 barrier for early warp drive systems. This also made ringship technology a dead end as far as human starship designers were concerned. It would take considerable time and effort to develop a ringship capable of breaking Warp 4. Such was possible in theory, however, the outbreak of the Romulan War prevented it from ever happening.

Lack of inner space more than anything else limited the possible service applications for the *Prometheus* class. Nevertheless, it soon found two niches in which it could serve. Twelve were purchased by Solar Spaceways and reconfigured as interstellar spaceliners. These were renamed after famous Terran princesses of past history (*Teresa, Diana, Grace, etc.*) Star Fleet ordered five as survey cruisers to supplement its own fleet of aging ringships. All were named after famous Terran explorers (*Balboa, de Gama, Livingstone, etc.*) The rest went to various civilian owners, who renamed them as they saw fit. All were decommissioned by 2147.



## VISUALS:



Concept painting (2102)

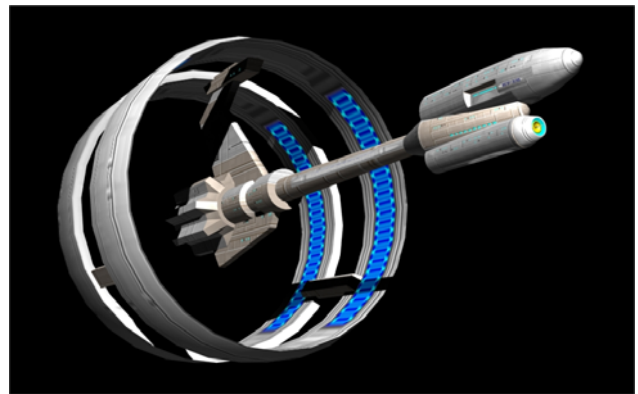

USS *Prometheus* – trial runs, Pluto Test Range (2104)

## SCHEMATIC:

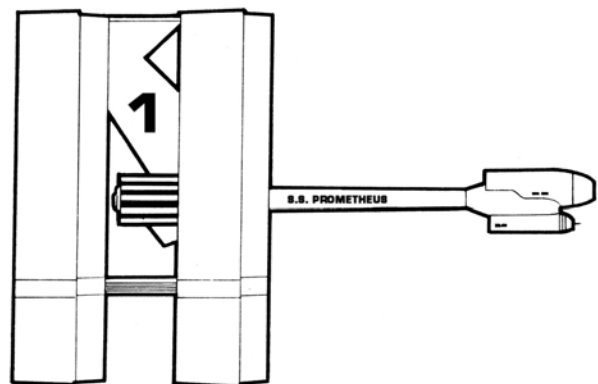

## SPECIFICATIONS:

Length:	310 m
Diameter:	205 m
Crew:	120
Displacement:	69,550 DWT
Armament:	4 laser banks (Star Fleet only)
Range:	12 years at L.Y.V.
Cruising speed:	warp 3.0
Maximum speed:	warp 3.2



# DY-1200 SERIES

**SERVICE ENTRY DATE (OLD CALENDAR): 2123**

The DY-1200 was the last hurrah for Dyson-Yoyodyne, the company that at one time had held a monopoly on the Terran spacecraft market. It was little more than an improved DY-900; however, one design feature deserves special notice. The company contracted with Cochrane Warp Dynamics for a new type of circumferential warp engine that was lighter yet just as powerful as current designs. Their solution was to lengthen the engine, adding more firing chambers to make up for the smaller diameter of its housing. This new engine design would serve as the basis for the warp engines used in the forthcoming *Daedalus* class survey cruisers.

The DY-1200 sold well enough for Dyson-Yoyodyne to make its graceful exit from the starship market. The company restructured soon after and focused exclusively on the "classic starship" market, providing parts and service for its own designs in addition to others from Terra and other Federation worlds from past starship eras.

## SPECIFICATIONS:

Length:	270 m
Beam:	54 m
Displacement:	75,250 DWT
Crew:	75
Range:	3 years at L.Y.V.
Armament:	4 laser banks
Cruising speed:	warp 2.20
Maximum speed:	warp 2.75

## VISUAL:

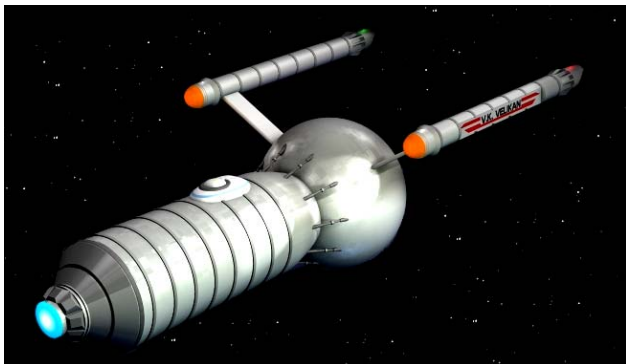

# CAVALRY CLASS DESTROYER

**SERVICE ENTRY DATE (OLD CALENDAR): 2141**

Project Mars was originally conceived by the Centaureans to develop a new destroyer as a potential successor to the Terran DY-X. After the war ended, though, the project was temporarily shelved. The War with the Vegan Tyranny reminded Star Fleet of the need for a small, well armed, and highly maneuverable destroyer type starship. The original proposal was dusted off and revamped to take advantage of the latest in Centaurean warp drive technology. Although initially criticized for its cramped quarters and ungainly looking appearance, it proved an effective combatant. The hull-over-single-engine design of the *Cavalry* class, unique at the time, would be revisited by the Class I starship program almost a century later.

Before the Romulan War the *Cavalry* class destroyers were used primarily as patrol and customs enforcement craft. The ambush of the destroyer *USS Patton* in 2159, the last *Cavalry* class starship ever built, is widely regarded as the opening salvo in the Romulan War (2159-2162). Their slow warp speeds limited their availability on the front lines, though, so most wound up in garrison fleets or at secondary defensive line stations. All were scheduled to be decommissioned in 2162 but were retained in service due to the outbreak of the M'Dok War. They were retired as a whole shortly after the end of that conflict.

## SPECIFICATIONS:

Length:	130 m
Beam:	25 m
Draft:	35 m
Displacement:	14,900 DWT
Crew:	80
Range:	2 years at L.Y.V.
Armament:	4 laser banks 1 particle beam cannon 2 fusion torpedo tubes
Cruising speed:	warp 2.0
Maximum safe speed:	warp 3.1

## VISUAL:

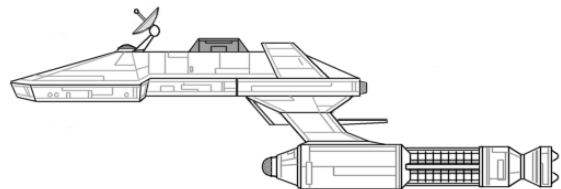

## VANGUARD CLASS TRANSPORT

**SERVICE ENTRY DATE (OLD CALENDAR): 2144**

This was the largest civilian transport (in terms of cargo capacity) of the early years of the Federation. It could be found everywhere in the civilian, industrial, and military sectors, plying the space lanes with all kinds of cargo. Its side loading ports and reconfigurable cargo bays is what gave these starships their versatility. They could carry almost anything, from raw ore and goods to finished bulk product, both frozen and liquid cargoes, and even small spacecraft. They could also carry up to 1000 beings in a pinch, which proved useful in several different occasions – especially during colony and base evacuations and in the troopship role during the Romulan War. Most were maintained for decades by their owners with periodic upgrades. Not surprisingly, a fair number are still in civilian service even today.

### SPECIFICATIONS:

Length:	260 m
Diameter:	98.7 m
Displacement:	25,000 DWT
Crew:	94
Range:	10 years at L.Y.V.
Armament:	none (usually)*
Cruising speed:	warp 2.0 (loaded) warp 2.75 (unloaded)
Maximum speed:	warp 2.3 (loaded) warp 3.0 (unloaded)

(\*) 4 laser banks backfitted during Romulan War

### SCHEMATIC:

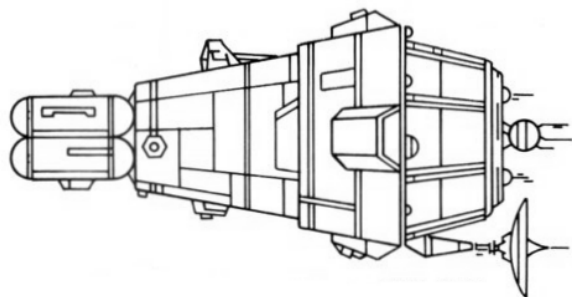

## HORIZON CLASS SURVEY CRUISER

**SERVICE ENTRY DATE (OLD CALENDAR): 2146**

This, the original *Horizon* class, was one of the first “true” Federation starships in that it was not a “local” design. Its lines betray its Terran heritage; however, as Terran influence was still very much dominant in the new Federation Star Fleet. These were the original survey cruisers of the Federation, systematically charting and surveying the new systems and worlds of the New Territories previously unknown to the Local Group. A total of 51 would eventually be built. The needs of the Romulan War would both slow production and change the class mission profile. Its armaments were upgraded and it was pressed into service to fill the gaps caused by losses among Star Fleet “heavies.” After the War, the survivors were reconfigured as priority armed transports and relegated to secondary duties. At least a dozen of these aged workhorses are still in use in the civilian sector.

### SPECIFICATIONS:

Length:	280 m
Beam:	136.5 m
Draft:	57.8 m
Displacement:	38,500 DWT
Crew:	224
Range:	15 years at L.Y.V.
Armament:	4 (8) laser banks* 2 (6) particle beam cannon* 50 (200) fusion torpedoes*
Cruising speed:	warp 3.0
Maximum speed:	warp 3.25

(\*) Second set of numbers reflect Romulan War upgrades

#### Innovations:

- First non-local Federation starship class
- First starship to carry work pods
- First starship to use duranium to lighten mass

### SCHEMATIC:

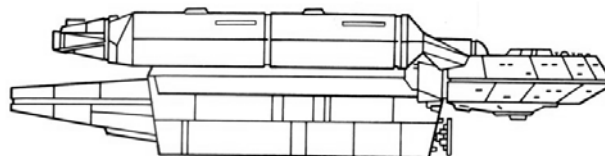

# ARMSTRONG CLASS

## HEAVY CRUISER

**SERVICE ENTRY DATE (OLD CALENDAR): 2147**

The *Armstrong* class was the main Andorian contribution to the new Star Fleet. Inspired by the Andorian's own *Thofsin* class battlecruiser, the *Armstrong* class was designed to replace the aging *Messier* class in the role of primary Star Fleet ship-of-the-line. Its engines were the same weight saving, elongated Centaurean design as those of the DY-1200 transport; however the design of the rest of the ship was pure Andorian. The first of these entered service in 2147, with another being built every two years due to limited yard space. As each was introduced a *Messier* class starship was correspondingly "retired" to fleet scouting and secondary support roles. 12 additional ships were authorized once the Romulan threat became clear. All of these were completed by war's end; however, four were lost in battle and a fifth so badly damaged that it had to be scrapped.

The *Armstrong* class emphasized the Andorian "weapons-over-comforts" design philosophy. Many of its crews complained that its interior spaces were as cramped as those of a *Cavalry* class destroyer. This was a price that Star Fleet was willing to pay for its impressive arsenal of lasers, torpedoes, and particle beam cannon. In another era they might have been classified as battle cruisers or dreadnoughts had they the shielding to match. Energy shielding technology was still a decade away from starship installation, though, so the *Armstrong* class was fitted with ablative armor like all other Star Fleet vessels of the era.

The *Armstrong* class shares the same distinction as the *Wright* class in being one of the forerunners of the Class I program. Whereas the *Djartanna* derived *Wright* class would eventually evolve through several stages into the Class I heavy cruiser, the *Armstrong* was the direct ancestor of the *Loknar* class frigate. It was the first Star Fleet vessel to employ an H-frame type hull design. This unusual configuration made the *Armstrong* class quite maneuverable at warp speeds, more so than it should have been for a vessel of its size and mass. This design feature did it little good in the mostly sublight battles of the Romulan War; however, it would benefit its descendants of wars to come.

One of the most interesting design offshoots of the *Armstrong* program was the **NX-Program** design study of the early 2150s. This would have replaced the catamaran-style primary hull with an elliptical saucer. Andor's Chiokis Design Group had been doing a lot of experimentation with saucer-shaped hulls the past decade in an effort to overcome the limitations of existing starship designs. Their initial research data suggested that a saucer shaped primary hull, be it circular or elliptical, would maximize a starship's mobility at warp speed. Unfortunately, the starship technology of the day was simply not up to building a frame strong enough for a saucer that could withstand the stresses of warp speed. In addition to this the warp engines of the day

could not put out a powerful enough structural integrity field to assist in holding together such a design. This meant that there was no possibility of the NX-Program ever being built during this era. The NX-Program was not in vain, however. Lessons learned during its development would be applied to the forthcoming *Daedalus* class survey cruisers. As for the NX-Program itself, it would eventually come to life almost a full century later once the technology had caught up with the concept.

All ships of the *Armstrong* class were named for famous Local Group space pioneers. Only one *Armstrong* class heavy cruiser has survived the passage of time. The *UES John Glenn* (NCC-C210) was sold to the Caitians as a system defense ship in 2175. It was modernized, renamed the *M'ritt*, and continued on active duty until 2208, when it was placed in the Caitian mothball fleet. The UESPA Foundation is currently in negotiations to purchase the *M'ritt* and restore it as a museum ship.

### SPECIFICATIONS:

Length:	207 m
Beam:	120 m
Draft:	33.1 m
Displacement:	138,000 DWT
Crew:	198
Range:	12 years at L.Y.V.
Armament:	24 laser banks 12 particle beam cannons 6 fusion torpedo tubes
Cruising speed:	warp 3.2
Maximum speed:	warp 3.9

#### Innovations

- First of the Star Fleet "H-frame" starships

### VISUAL:

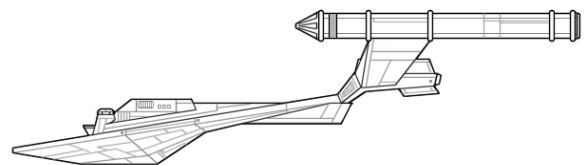

## ***GALLANT* CLASS STAR FIGHTER**

**SERVICE ENTRY DATE (OLD CALENDAR): 2148**

The Federation's first space fighter came in two flavors. The *Gallant* configuration was a pure space superiority fighter craft, fitted with four of the most powerful laser banks of its time. The *Arrow* configuration was fitted with less powerful lasers, lightening the ship's mass so that up to 4 fusion torpedoes could be carried on centerline mounts. Both were built on the same frame, with a single GSC combination impulse/jump generator for short-range operations. Their unusual visual appearance, due to their four cross-mounted lasers, soon earned them the nickname of "Frogstar fighters" by their pilots.

The idea of a "star fighter" was a popular one with the Terrans, who had come to the stars with a culture rich in the military fighter pilot tradition. The realities of space combat would prove otherwise. 289 of the 410 built between 2148 and 2159 were lost the first year of the Romulan War and only a handful of their pilots survived. One shot from a starship laser was enough to destroy them; also, pilot ejection systems were of little use in an infinite void where the chances of being spotted, let alone rescued, were practically nil. After these staggering losses Star Fleet redeployed its star fighters along with its few carriers to its garrison fleets, where they served for the rest of the war.

### **SPECIFICATIONS:**

Length:	30 m
Diameter (fintips):	13 m
Displacement:	70 DWT
Crew:	1-2
Armament:	4 laser banks ( <i>Gallant</i> ) 4 fusion torpedoes ( <i>Arrow</i> )

Cruising speed:	warp 2.0
Maximum safe speed:	warp 2.5

#### Innovations

- First Federation space fighter craft

### **VISUAL:**

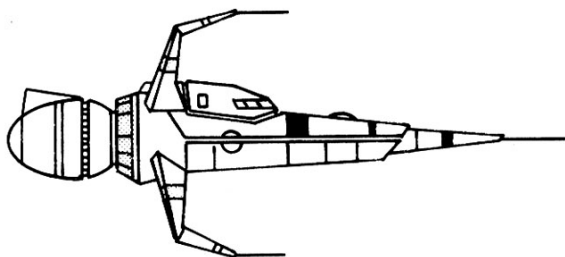

## ***HOPKINS* CLASS HOSPITAL SHIP**

**SERVICE ENTRY DATE (OLD CALENDAR): 2148**

These were not so much ships as they were mobile bases built for rapid transport from one location to another. All of them had the same external generic design; however, inside they could be custom-tailored to the specific needs of the worlds over which they orbited. These were extremely valuable in the settling of the New Territories, providing modern medical facilities where they would have otherwise been absent. They also played a prominent role in the Federation Medical Assistance Program, often being dispatched to worlds suffering from epidemics and other severe medical emergencies. At the end of the Romulan War several were converted into the first Neutral Zone outpost stations. The rest, with periodic upgrades and overhauls, continued in civilian service until 2173.

### **SPECIFICATIONS:**

Length:	238 m
Diameter:	150 m
Displacement:	90,000 DWT
Crew:	128
Patient capacity:	up to 600
Range:	4 years at L.Y.V.
Small craft:	5 medical shuttles
Armament:	4 (8) laser banks*

Cruising speed:	warp 2.20
Maximum safe speed:	warp 2.75

(\* ) numbers reflect Romulan War backfits and conversions

### **VISUAL:**

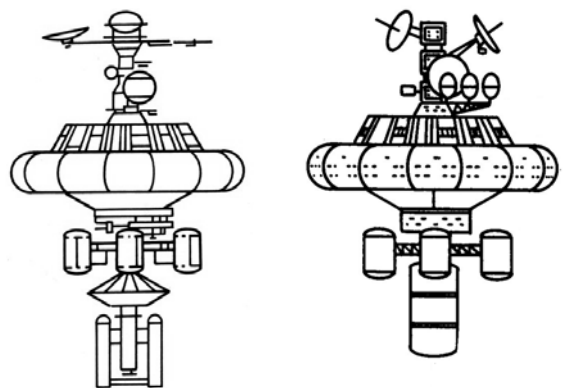

*Hopkins* class hospital ship as built c. 2100 (left)  
Neutral Zone outpost station conversion c. 2170 (right)

# 2151-2165: War in the Stars

---

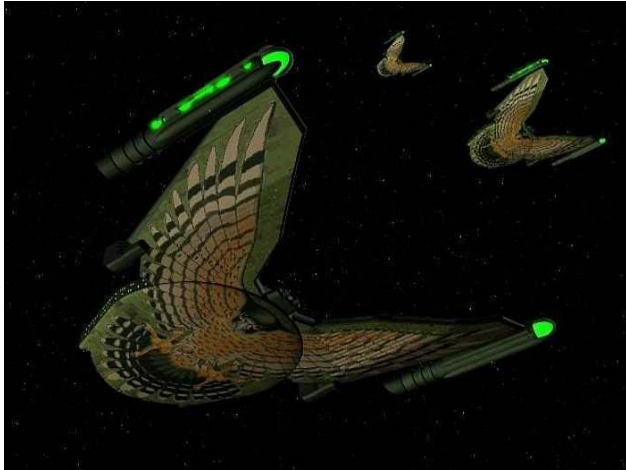

The middle of the 22<sup>nd</sup> century was dominated by a conflict that would wind up reshaping the Federation from a loose-knit confederation of worlds into a strong interstellar alliance. In a certain sense the Romulan War (2159-2162) was already well underway, with ever increasing attacks on Federation shipping by mysterious alien marauders from beyond the New Territories. Ore freighters were spacejacked, civilian shipping destroyed, and even Star Fleet was not immune as several of its ships simply vanished, never to be heard from again. For a while they were considered a minor nuisance, a variation on common space pirates (such as some of the Orion criminal cartels) that plagued the lesser traveled backwaters of known space. Once colonies and space stations (as opposed to lone ships) began to be attacked, then suddenly the rest of the Federation sat up and took notice. The Delta IV massacre, the raid on Dinai Station, and finally the execution-style slaughter of over 200 defenseless passengers and crew of the starliner *Diana* were but the latest atrocities in an ever-expanding pattern that could no longer be ignored. The Federation had tried to turn the other cheek, had tried contact, had hoped that the voice of reason would be heard by this new foe. Once it became clear that the aliens were refusing all overtures of peace, then the time had come for war. Star Fleet was mobilized, additional fleets were deployed, and a tripline of picket ships strung across the New Territories border in

expectation that the enemy would cross them. They did so with an invasion fleet at the Eta Leonis system, destroying the hapless destroyer *Patton* with a single massed volley as soon as it raised the alarm. That deadly volley marked the official beginning of the Romulan War.

---

Much has been said and written about the Romulan War and the events surrounding its cause. There is a whole section of Memory Alpha's databanks devoted exclusively to works on the subject, which even includes post-war Romulan submissions from our era. Perhaps the definitive work on the subject from the Federation point-of-view is *The War Torn Galaxy: A History of the Romulan War* by the late John Gill, onetime Star Fleet Academy instructor in history. The Romulan perspective was best given in various interviews with one of their own -- a female starship captain in the Romulan Space Navy. She was captured and held prisoner for a time as the result of a Star Fleet covert operation in 2263, and as such she was the first Romulan ever taken prisoner by Star Fleet. As the Commander later revealed to one of her interrogators, members of her own family had actually been involved in many of the major battles of the war. The edited transcripts of those interrogations, including her discussions on the Romulan War, were subsequently published in *Why We Fight the Federation*. It gives a rare insight into the Romulans from the enemy perspective, the likes of which was not available before or has been since. It corroborated a steadily growing mountain of evidence that the causes and effects of the War were not as clean-cut as many have believed.

---



To describe the Romulan War in detail would be to unnecessarily duplicate the works of Gill, the Commander, and many others who have better and



more thoroughly examined the subject from every conceivable perspective. Cadets are directed to use the timeline in this document as a starting point for their own research. It gives a concise summary of the war from its beginnings in the 2130s to its end and aftermath in the mid-2160s.



By 2161 the Romulan War was over. The Romulans were driven from the field at the Battle of Cheron, the last conflict of the war. Shortly thereafter, over subspace radio, they agreed to the terms of the Treaty of Alpha Trianguli. It wasn't that they didn't want to keep on fighting; rather, they no longer had the resources to continue with any hope of winning. They accepted the humility of defeat in order that their people and their Empire could survive. The Neutral Zone was established and the Romulans retreated behind it, where they would not be heard from again for a century.

The Federation has always refrained from claiming an outright victory over the Romulan Star Empire even though the tide had turned in its favor by war's end. The war had ground both sides down in manpower and resources. Victory meant little when measured up against the losses of hundreds of thousands of lives and many more wounded or maimed for life. All that the end of the war brought was freedom from fighting. The Federation had survived, but just barely. Now the decades-long process of rebuilding had to begin on many Federation worlds. The Federation would rise from the ashes of war even stronger than ever, with a new government and a new sense of purpose in the Sea of Stars. Some systems, though, such as the charred ruin that had once been Alpha Omega  $\beta$ , would never recover.

Shortly after the end of the Romulan War, there occurred one of those little "incidents" for which the Kzinti had become famous. This was more than just a simple incident, though. What might have been a simple police action wound up almost turning into a

real war, thanks to Star Fleet's forced downsizing courtesy of the Federation Council. The M'dok, a breakaway Kzinti group, who had founded their own "empire" from a piece of the old Kzinti Empire, began attacking the Federation in 2162. They saw in Star Fleet's forced downsizing an opportunity to rebuild something of the glorious Kzinti Empire of old. Fortunately they had learned little from the defeat of their ancestors a century before. Local Star Fleet squadrons were able to hold their own against M'dok massed wave attacks until reinforcements could be dispatched. Within five months the tide of the "war" had turned into a simple task of search and destroy. Within another ten months the "war" was over. It might not have taken that long had not Star Fleet had to deal with M'dok close-in pinwheel attacks and its own depleted starship resources. The situation was further aggravated by a number of former Star Fleet vessels in the possession of the M'dok that they had "legitimately" purchased under the guise of Caitian merchants. Star Fleet wound up having to destroy a all of these former starships – many of which had risen to fame during the Romulan War, only to be turned into little more than pirate vessels at the hands of the M'dok. Even so, a Federation victory was inevitable. All of the M'dok fleets were hunted down and destroyed, their homeworlds were besieged until they surrendered, and they were eventually confined to their own "patriarchy" just like the Kzinti.

The decades to come would see a long peace settle on the Federation. All of the New Territories on all borders would eventually be secured against future such wars once Star Fleet got back to strength. A new wave of exploration and colonization took place now that the threat of interstellar war was finally gone. It would be the time of the First Golden Age of the Federation, with new members joining and new allies rallying to its cause. With peace in its hands, the Federation would finally be able to realize the lofty goals of interstellar security and prosperity that the Vulcans had foreseen so long ago ...

... that is, until the Klingons arrived on the scene.

# STARSHIPS

## MERCURY CLASS SCOUT

**SERVICE ENTRY DATE (OLD CALENDAR): 2154**

These ships were developed as a low-cost alternative to refitting *Cavalry* class destroyers for the role of fleet scout. They were also a cheaper alternative by far for “regular” scouting missions deemed of too low a priority to justify a more advanced fleet scout. The *Mercury* class was little more than a habitable control section strapped on top of a combined high-end sensor and warp engine platform. Their inexpensiveness combined with their small size resulted in a total of 72 being built by war’s end. They often operated in groups of two or three, scouting along Romulan defenses or making quick dashes into Romulan-held space in order to gather intelligence on Romulan deployments. Many were destroyed during such daring missions, resulting in the loss of 21 members of the class during the war. The remaining 51 survived the conflict and continued to serve with Star Fleet in various roles until 2181. Amazingly, 33 *Mercury* class scouts still survive today, all in the hands of private “classic starship” enthusiasts who have restored them to various in-service configurations.

### SPECIFICATIONS:

Length:	162.2 m
Beam:	79.7 m
Draft:	84.2 m
Displacement:	6,800 DWT
Crew:	48
Range:	2 years at L.Y.V.
Armament:	2 lasers 1 particle beam cannon
Cruising speed:	warp 2.0
Maximum speed:	warp 3.2

### VISUAL:

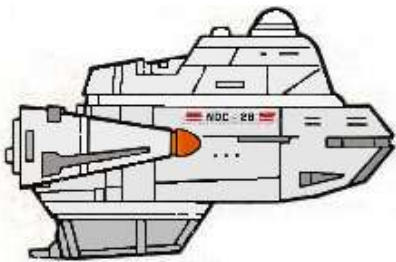

## DOPPLER CLASS SCOUT

**SERVICE ENTRY DATE (OLD CALENDAR): 2157**

The *Doppler* class scout was a smaller and slower contemporary of the *Mercury* class. Its armament was identical but better placed, with superior firing arcs as a result. In particular, the underslung location of the *Doppler's* gimbal-mounted particle cannon gave it a multi-directional heavy fire capability that the *Mercury* was sadly lacking. Its service entry date also meant that the *Doppler* class received the benefit of a force field shielding system. It was the second starship class so equipped (the contemporary *Marshall* class destroyers being the first).

The *Doppler* class scouts became famous for the part that three of its members played in the key battle of Admiral William Larson’s “Triangle” Offensive of 2161-2162. The Federation victory of the Battle of the Clouds would not have been possible had not the *Doppler* class scouts *Cordwainer*, *Miramar*, and *Selyana* independently pinpointed the location of a secret Romulan base that had been supplying Romulan forces in the area for the past year. All were lost prior to the battle; however, the tactical reports they made before their destruction made possible Admiral Larson’s subsequent victory. After the war the class was sold off for use in various local system defense fleets. The last was decommissioned in 2177.

### SPECIFICATIONS:

Length:	150 m
Beam:	36.1 m
Draft:	24.5 m
Displacement:	4,100 DWT
Crew:	30
Range:	3 years at L.Y.V.
Cruising speed:	warp 2.0
Maximum speed:	warp 3.1

### VISUAL:

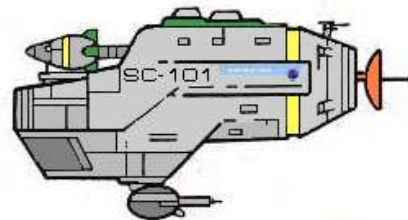

# GALACTIC SURVEY CRUISER DESIGN PROPOSAL & PROTOTYPE

**SERVICE ENTRY DATE (OLD CALENDAR): 2155**

The Galactic Survey Cruiser was a design proposal submitted in 2153 to the Star Fleet Design Bureau by a young Terran starship engineer named W. M. Jefferies. It was a radical departure from the accepted starship practices of all members of the Federation. A single, small-scale prototype was built in 2155 to test the concept and showed considerable promise. This lone prototype would become one of the most influential starships in Federation history. One can see in its design, for the first time, the classic "lines" of its legendary descendant: the *Constitution* class heavy cruiser of the 23<sup>rd</sup> century.

The Jefferies prototype was a one-fourth scale replica of the proposed design. Even so, it was built to the exact specifications Jefferies had laid down in his proposal. There was nothing new about its propulsion or systems packages; all of these were comprised from off-the-shelf components. The main purpose of this prototype was to test the structural soundness and warp dynamics of its revolutionary new design.

In studying the current starship designs of his day, Jefferies had arrived at the conclusion that none of them provided the right mix of warp-friendly design, frame stress reduction, damage survivability, and interior space necessary for a true deep space exploration vessel. His concept combined several existing ideas from these other design philosophies into a one of his own making. From Terra he borrowed the idea of separable hull components with redundant systems in case of emergency. From Alpha Centauri he borrowed the idea of subspace streamlining and, most importantly, the boom engine configuration. From Andor he got the idea for a primary hull saucer, although he could not implement a true saucer due to the shipbuilding limitations of his day. From Tellar Prime he got the latest in mid-sized warp engines from Kloratis Drive Systems, as standard Cochrane-style models built for Star Fleet were far too large for his scaled-down prototype. Finally, from Vulcan he got the most advanced starship computers and control systems available. As a nod to his sponsor, Cochrane Warp Dynamics, Jefferies named his prototype *Bonaventure* after the very first starship equipped with warp drive.

The revolutionary aspects of the Jefferies design cannot be emphasized enough. The warp dynamics of its shape gave it the ability to hit Warp 2.8 on its very first space trial with little effort despite its underpowered engines. Subsequent trials raised its top speed to Warp 3.8, making it the fastest starship at the time. Many starship historians believe that it would have eventually broken the legendary Warp 4 barrier, had not the outbreak of the War forced the termination of the program. Aspects of the Jefferies prototype design were incorporated into

the contemporary *Daedalus* class survey cruisers as soon as the testing data became available. It would also serve as the model for the rebuilding of the actual *Bonaventure* starting in 2163.

The original Jefferies prototype served as a fast fleet scout during the Romulan War. By virtue of its design it survived that conflict. It was removed from service in 2162 and donated to the Federation Air and Space Museum at Terra, where it remains today.

## SPECIFICATIONS:

Length:	50 m
Beam:	28 m
Draft:	22 m
Displacement:	2,750 DWT
Crew:	14
Range:	2 years at L.Y.V.
Cruising speed:	warp 3.2
Maximum speed:	warp 3.8

## VISUAL:

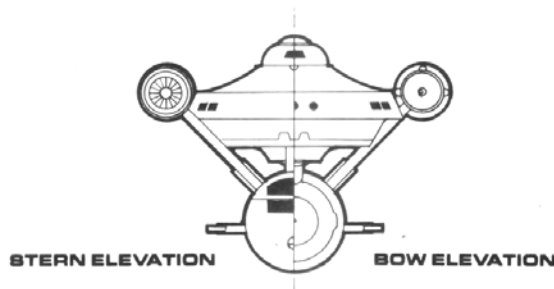
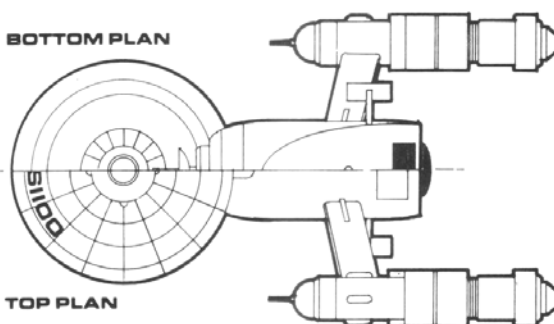
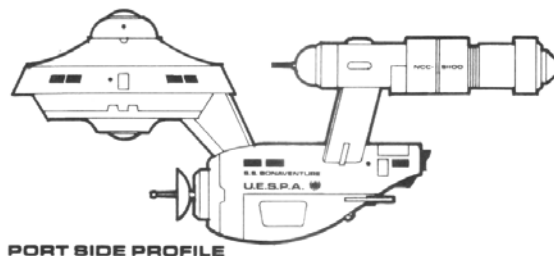

# MARSHALL CLASS DESTROYER

**SERVICE ENTRY DATE (OLD CALENDAR): 2157**

The *Marshall* class was rushed into service just in time for the Romulan War and served as Star Fleet's mainstay vessel for the entire course of the conflict. These quickly became known as the "hammerheads" due to their distinctive appearance. They were extremely popular with their crews and proved to be one of the few Star Fleet starship classes at the time that "... could give as good as it got." Their heavy armament and innovative force field screens insured they would be everywhere, appearing as fleet flagships and squadron leaders in almost every major battle of the Romulan War. The excellence of the class came at a high price, though. Of the intended 260 ships of the class only the first 36 would be built. Resources that might have been used for the construction of *Marshall* class starships were instead diverted to their less-expensive CS-series alternatives.

After the war Star Fleet found itself in a unique and rather difficult situation. The starship program intended to replace the "hammerheads" as the backbone of the fleet, the *Goliath* class battlecruiser, failed in prototype acceptance tests and was immediately shelved. Star Fleet's response was to order an additional 28 ships of the updated *Marshall-B* class to cover the gap this created in the fleet. It also began experimenting with a number of other starship designs over the next two decades in an effort to find a worthy (and affordable) successor to its beloved "hammerheads." The year 2187 would see the introduction of the *Marshall-C* configuration, better known as the *Patton* class in honor of its famous predecessor. The failure of the *Tritum* program that same year meant that the *Marshall* class (and its derivatives) would have to continue as the backbone of the fleet. It would be another two decades before the *Baton Rouge* program came along, giving the aged *Marshall* class its long-deserved chance to take its final bow. By the time Star Fleet's "hammerheads" were finally retired in the early 23<sup>rd</sup> century they had served Star Fleet for almost six decades – longer than any other starship class at the time.

The *Marshall* class was originally named after famous Terran historical military figures. As the class grew the names of military figures from other worlds were added as well. After they were decommissioned many names used for *Marshall* class destroyers were recycled for future destroyer programs.

Only two ships of the original *Marshall* class still survive in Federation hands. The class ship *USS Marshall* (NCC-D230) was saved from the scrapper's torch by the Titan Fleet Yards and painstakingly restored to its original Romulan War configuration for public display. The *USS Hannibal* (NCC-D246), the longest serving surviving member of the original *Marshall* class (50 years) and the flagship of Admiral Alexander Hamilton

at the Battle of Cheron, is on public display at the orbital complex of the Federation Air and Space Museum on Terra.

## VISUAL:



## SPECIFICATIONS:

Length:	225 m
Beam:	117 m
Draft:	45.5 m
Displacement:	22,700 DMT
Crew:	157
Range:	10 years at L.Y.V.
Armament:	22 laser banks 10 particle cannons 2 fusion torpedo tubes

Cruising speed:	warp 3.5
Maximum speed:	warp 3.8

### Innovations/Experiments:

- First starship with protective force field screens.
- Most heavily armed Star Fleet starship of the war

## SCHEMATICS:

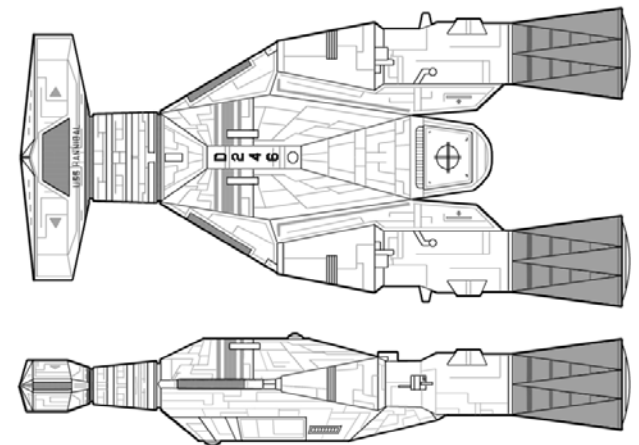

# DAEDALUS CLASS CRUISER

SERVICE ENTRY DATE (OLD CALENDAR): 2158

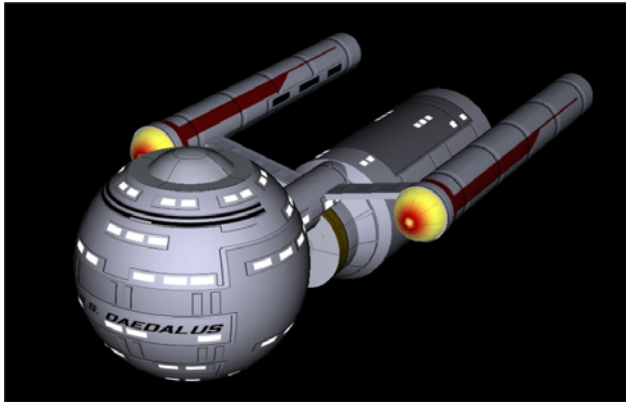

In 2156 the Romulan War was already looming on the horizon. Star Fleet was understandably looking for any starship on which it could get its hands to beef up its fleet. It found a ready candidate in the *Daedalus* class survey cruisers. The first two ships of the class had already been under construction for the past nineteen months. They had been partially reworked while still in their berths to take advantage of the latest design data from the Jeffries Galactic Survey Cruiser Project; hence the delay in their completion. The Federation Council granted Star Fleet the authority to “take over” the *Daedalus* class and finish it on an accelerated schedule as a military cruiser. This was done much to the irritation of both UESPA and the Federation Bureau of Sciences; yet both acknowledged that the looming war against the Romulans took precedence above all else.

The need for swift completion under these conditions meant that the *Daedalus* as built could not implement all of the data learned from the Jeffries Project. A simple spherical primary hull was fitted instead of the toridal saucer that had been worked up from the Jeffries Project data. Star Fleet standard PB-2 circumferential warp drive units, an uprated version of the ones first used with the *Armstrong* class heavy cruiser, were installed instead of the proposed new “Pegasys” series VX-1 by Kloratis Drive Systems, as UESPA had intended. Although not as powerful as the Pegasys VX-1 on paper, the PB-2s were already available and did not have to go through a lengthy testing and evaluation process. Finally, one small yet significant change remained to be made to the *Daedalus* design. It was equipped with lasers and torpedoes for combat conditions. They were not part of the original design, since a survey vessel was traditionally unarmed; however, Star Fleet experience with the Romulans had proven the folly of such a practice. They would have mounted more weapons had there been any room left for them in the already thrice-redesigned hull. Instead, they would have to content themselves with hiding additional weapons inside its shuttle bay on an as-needed basis per mission specs.

The *Daedalus* class has often been criticized for its utilitarian lines and rather ungainly appearance. It is quite a different ship

as built from what had been intended, which would have more closely resembled the Jeffries Project prototype after its mid-construction design revision. One must understand, though, the wartime environment that dictated how fast and under what conditions the *Daedalus* class entered service. One must also take into account that despite its “primitive” looks the *Daedalus* was one of the fastest and most agile starships of its day. The limited application of the Jeffries Project data had given the Federation its first “modern” starship class regardless of its appearance. The arrival of the *Daedalus* and its brethren on the scene in 2158 was one of the factors that helped the Federation defend itself in those terrible first two years of the Romulan War. They would also prove instrumental in winning it. The *Daedalus* class would go on to serve long after the war was over, returning to more peaceful missions and performing admirably in its intended role as survey and exploration vessels.

All starships of the *Daedalus* class were officially retired in 2196. A few still serve “unofficially” in various support roles.

## SPECIFICATIONS:

Length:	114.5 m
Beam:	49.4 m
Draft:	37.5 m
Displacement:	27,500 DWT
Crew:	120
Armament:	7 laser banks 2 fusion torpedo tubes
Cruising speed:	warp 3.5
Maximum speed:	warp 3.9

### Innovations/Experiments:

- First “modern” Federation starship class

## VISUAL:

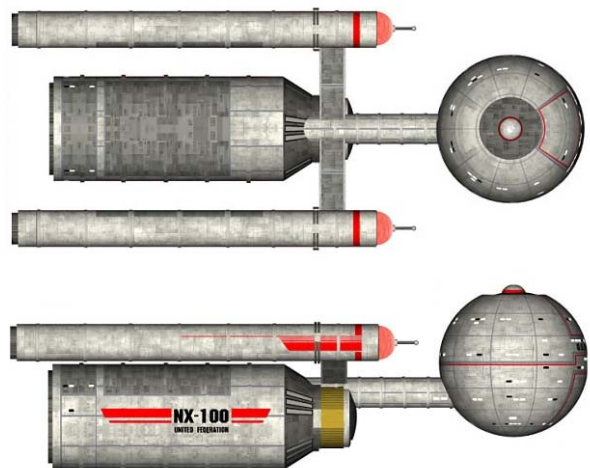



## ***NORMANDY*CLASS STARFIGHTER**

**SERVICE ENTRY DATE (OLD CALENDAR): 2163**

These were little more than a refined version of the *Gallant* class taking into account lessons learned during the Romulan War. It still used the same GSC-890 jump drive engine; however, the rest of the craft was completely redesigned. The crew ejection module now included a more powerful homing beacon and built-in maneuvering thrusters with a limited fuel supply. The quad lasers were brought as close to the main hull as safety permitted. Finally, instead of the separated fighter/attack models, refined subsystems and a redesigned, elongated nose allowed for options packages to be fitted in the field for various mission configurations. The standard fighter version carried extra energy stores for the on-board lasers plus short-range ship-to-ship drones, ELINT versions carried a sensor and jamming pallet, and attack versions carried a full rack of fusion torpedoes. These three were the most common, although several others were also available.

Whether or not the *Normandy* class starfighter would have succeeded where the earlier *Gallant* and *Arrow* classes failed is a moot point. It came too late for the Romulan War and retired too early for subsequent action with the Klingons. All were removed from Star Fleet service and sold off for use in local system defense fleets by 2190. About 100 or so still exist today, either still in local fleet service or under private ownership by “classic starship” collectors.

### **SPECIFICATIONS:**

Length:	40 m
Beam:	12 m
Draft:	12 m
Displacement:	95 DWT
Crew:	3
Range:	N/A
Armament:	4 forward lasers 12 drones or 6 fusion torpedoes

Cruising speed:	warp 2.8
Maximum speed:	warp 3.3

### **VISUAL:**

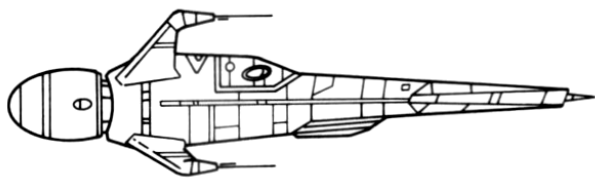

## ***POWERS*CLASS SCOUT**

**SERVICE ENTRY DATE (OLD CALENDAR): 2165**

One of the things that the Romulan War proved was the ineffectiveness of particle beam weaponry against starships with force field energy screens. Star Fleet’s next class of scout ships, the *Powers* class, was one of the first post-war designs to take this lesson into account. It carried fusion torpedoes instead of a particle beam cannon as its heavy armament; hence its rather odd-looking configuration as opposed to following in the *Mercury/Doppler* design lineage. Also, as another design experiment, its sensor suite was mounted in three external pods that could be switched out at its home base or jettisoned in the field in an emergency.

The rather unremarkable service record of the *Powers* class was due more to the peacetime conditions in which it found itself than anything else. This might help explain why the *Powers* class was so quickly decommissioned in 2182, just one year after the older but longer-serving *Mercury* class scout. Most were quickly resold and reconfigured as interstellar police craft, in which role they served for another two decades. Only a dozen or so managed to escape the scrapper’s torch at the end. All of these are either in the hands of private “classic starship” collectors or in use by independent merchants.

### **SPECIFICATIONS:**

Length:	75 m
Beam:	32 m
Draft:	30 m
Displacement:	2,300 DWT
Crew:	20
Range:	3 years at L.Y.V.
Armament:	4 laser banks 1 fusion torpedo tube
Cruising speed:	warp 2.5
Maximum speed:	warp 3.3

### **VISUAL:**

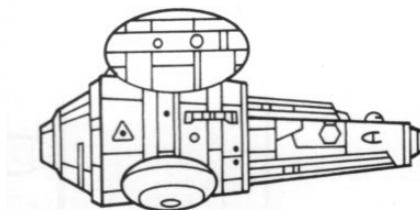

# ***U.S.S. BONAVENTURE (REBUILD)***

**SERVICE ENTRY DATE (OLD CALENDAR): 2165**

The year 2161 saw the most important breakthrough in warp drive technology in decades. The PB-6 “Quantum II” warp engine by Cochrane Warp Dynamics made it theoretically possible to exceed Warp 4 for the first time in Federation history. It was the greatest starship design achievement of the age and would find its way onto many a Star Fleet vessel in the generation of starships to come. The development also happened to roughly coincide with the 100<sup>th</sup> anniversary of warp-powered starflight. After the war, the Federation Council chose a unique (and still controversial) way to mark both historic occasions. The venerable *Bonaventure*, the very first production starship equipped with warp drive, was recalled from retirement and rewoven into an entirely new vessel – using both the new PB-6 warp engines and *all* of the data gleaned from the Jeffries Project prototype design of 2155.

This decision was not as welcome as one might think. Many “classic starship” buffs and historical preservationists were firmly opposed, citing the *Bonaventure*'s key role in starship history. They publicly condemned the move, noting that one of the last of the first-generation faster-than-light Terran spacecraft still in existence was being sacrificed for little more than a public relations ploy. In the end though, their voices went unheeded. The *Bonaventure* was towed out of its berth at Star Fleet's fleet reserve facility on Luna for a historic rebuilding at the nearby Star Fleet facilities above Aitken Base.

The *Bonaventure* that emerged from its orbital spacedock above Luna in late 2164 looked nothing like the original. Gone were the old flat, angular lines and overall lumpy profile. Gone as well were the arrow-shaped primary hull and early fusion-based faster-than-light warp engines. In its place was a brand new starship, incorporating all of the technological advances that had been developing since its maiden flight in 2060. This was the first time (but certainly not the last) that Star Fleet would so drastically rebuild one of its historic starships. It did so because it could. For the first time since the end of the war it was working with an unlimited budget. To this end the new *Bonaventure* was the Jeffries Project brought to life, retooled with the latest in starship technology advances and ready to strut its stuff before the Federation for all it was worth.

After its formal commissioning in 2165 and making the expected publicity rounds, the rebuilt *Bonaventure* immediately set out on its third long-term voyage. Sadly, however, it was to be its only one. The *Bonaventure* was lost with all hands while investigating the Delta Triangle in 2166. The ship was rediscovered there, still intact, a century later. Unfortunately the unique spatial anomalies of the Delta Triangle prevent it from ever being recovered. A single sister ship, the new-build *Bonnie Chance*, was built as a replacement in 2168. It would be the only other

one ever built. The new *Bonaventure* design was simply too expensive to fund for any additional ships in the class.

Many of the design innovations first implemented in the *Bonaventure* rebuild project would go on to be used in subsequent Star Fleet starship designs. Perhaps the notable among these were the new PB-6 warp engines. These would go on to see long years of service with the *Horizon* and *Archon* class survey cruisers. One obvious nod to her Jeffries design lineage was her thin discoid primary hull, which was a first at the time. Such a design was not be used again until the end of this era. This was because the technology of the day could not build a duraluminum hull strong enough to withstand speeds of warp 4 for any extended length of time. This is why the *Bonaventure* was given an elliptical disc instead of a true disc. The design helped offset the stresses caused on it at high warp speed. The idea of the “thin disc” primary hull would not be revisited until the discovery and eventual use of trititanium for starship construction.

---

## **SPECIFICATIONS:**

Length:	198 m
Beam:	95 m
Draft:	77 m
Displacement:	115,000 DWT
Crew:	190
Armament:	1 bank of 2 lasers

Cruising speed:	warp 3.4
Maximum speed:	warp 3.9

### Innovations/Experiments:

- First time a Star Fleet vessel was ever broken down and rewoven into a new starship class
- First production starship to use PB-6 warp engines
- First production starship class in Star Fleet history to attempt a disc-shaped primary hull design
- Overall design would later go on to inspire the next two generations of Star Fleet starships

---

## **VISUAL:**

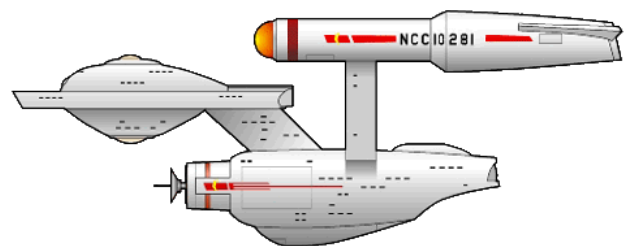

# STAR FLEET “CYLINDER SHIPS”

**SERVICE DATES (OLD CALENDAR): 2154-2162**

Aside from a few notable new ship classes, such as the *Daedalus* class survey cruisers and the *Marshall* class destroyers, most of the Romulan War was fought by clumsy cylindrical Terran starships against hordes of clumsy, cylindrical Romulan starships, with the occasional odd class or two thrown in for good measure. This was a throwback of sorts as far as Terran spaceflight had developed; however, there was a very good reason for it. All battles took place at sub-light speeds at or near a planetary system or other stellar landmark. One did not need a ship designed for warp speed to fight a sub-light battle.

These CS-series starships, or “cylinder ships” as they were better known, were derived from the unbuilt Dyson-Yoyodyne DY-1300 military cruiser of 2130. They were designed to be cheap, easy to build, and quick to launch and join the action. Average construction time was six to nine months per ship, with some of the ships in the smaller design classes being built in as little as three months. All of the CS-series starships were produced in large numbers in all sizes with a varying mix of weapons expressly for the war effort. Creature comforts were kept to an absolute minimum. The extra room gained was used for weaponry, armor, and even early force field systems (in the later classes). When the Romulan War finally ended all of these “cylinder ships” were either sold or scrapped within four years after the Federation Council mandated the downsizing of Star Fleet. A surprising number were purchased by undercover M’dok agents (in disguise as Caitians) and used against Star Fleet in the short-lived Federation-M’dok War.

Illustrations of some of the more important CS-series starship classes involved in the Romulan War are shown here in order to highlight their role in Federation spacecraft history. Cadets wishing to conduct further studies into the CS-series starships should address their inquiries to the [Starfleet Museum](#), Memory Alpha branch, via the Academy Intranet.

## VISUALS (NOT TO SCALE):

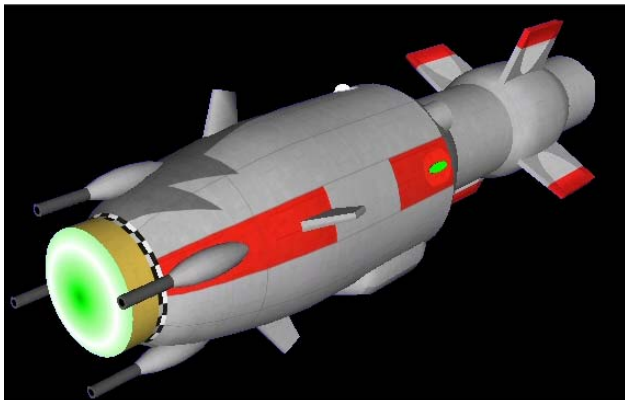

*Minotaur* class space fighter



*Pioneer* class heavy cruiser



*Tannhäuser* class heavy cruiser



*Yorktown* class escort carrier

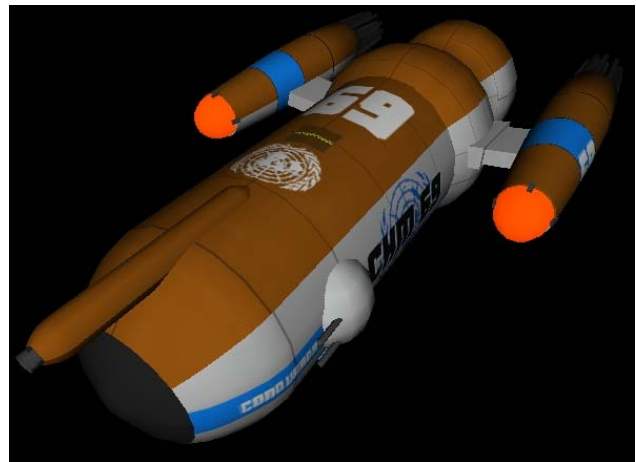

*Conqueror* class heavy cruiser

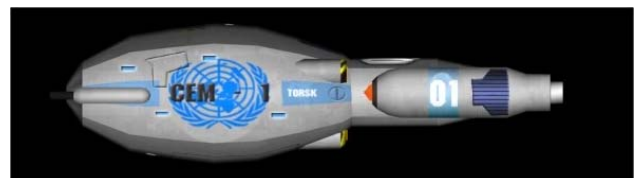

*Torsk* class patrol cruiser

CYLINDER SHIP PROGRAM BY MASAO OSASAKI  
3D MESHES AND MODELS BY DARKDRONE  
COURTESY OF THE *STARFLEET COMMAND III* DOWNLOADS SECTION

# ALIEN STARSHIPS

## TELLARITE “FREE TRADER”

### *DEGBRAXIS CLASS*

These massed produced vessels were very popular with civilian traders and commercial transport firms. They were excellent for the small-to-medium cargo, long-haul role and could be found everywhere in the Federation. A number of these were on supply runs to various colonies and stations in the New Territories when the Romulan War broke out and were hurriedly pressed into service as evacuation ships. They were not very maneuverable but were well armed for civilian craft, usually capable of holding their own against lone Romulan raiders until nearby Star Fleet vessels could come to their rescue. They were also among the thousands of civilian craft pressed into service as Star Fleet supply craft to support the war effort. Many were lost in convoy raids to Romulans marauders before the tide turned in favor of the Federation. The survivors continued in service after the war until the 2170s, when most were replaced by their owners with newer, faster designs. Only a handful still continue to ply the stars today, with the rest having been grounded or scrapped.

### SPECIFICATIONS:

Length:	198 m
Beam:	95 m
Draft:	77 m
Displacement:	95,000 DWT
Crew:	190
Armament:	1 bank of 2 lasers (pre-war configuration) 3 banks of 5 lasers (wartime configuration)

### VISUAL:

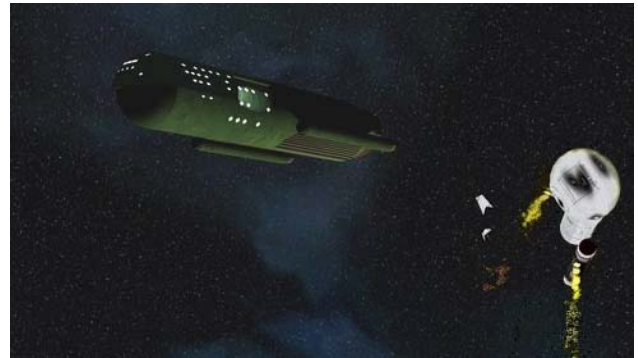
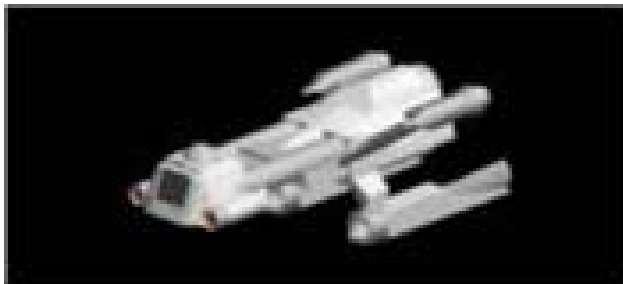

The aftermath of a Romulan ambush

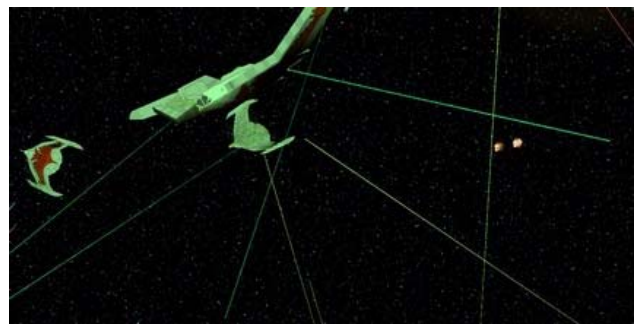

Romulan Warbirds at the Battle of Rigel



Vulcan cruisers to the rescue at the battle of Omicron Ara III



The destruction of Alpha Omega B

# ROMULAN U-4 *CEREBUS*

(ROMULAN *VAS'MAKLARAM* – “SHRIEKING BIRD”)

SERVICE ENTRY DATE (ESTIMATED): 2130

DATE FIRST SIGHTED BY FEDERATION: 2144



This is one of the oldest known Romulan starship designs, predating the Romulan War by at least two decades. Data gleaned from Starfleet Intelligence suggests that it entered service no earlier than 2130. This data also suggests that it was the first Romulan warp-capable military spacecraft. In many ways, particularly with regards to engine design, construction, and sublight maneuverability, it was more advanced than most of the starships that the Federation Star Fleet was fielding at the time.

Although early and primitive by modern standards, the *Cerebus* already shows many of the distinguishing characteristics of Romulan military designs: the sweeping, wing-like engine support pylons, the unibody hull with rear-mounted sub-light engines, and the “Bird-of-Prey” emblem on its underside. Its curved surfaces were in stark contrast to the angled “slab ship” designs preferred by Terran starship engineers and represented different approaches to starship combat. The Romulans eschewed the inherent stealthiness of a faceted, slab-like hull for the maneuverability of a smooth one. This gave the *Cerebus* incredible sub-light acceleration and agility. A lone *Cerebus* might not outgun a typical Federation vessel; however, it could almost certainly outmaneuver and outrun it. Furthermore, it was rare when a *Cerebus* was found alone. They usually operated in packs of three or six, preying on easy targets and zipping away whenever the alarm was raised. Another impediment to Federation attacks was the energy screens of a *Cerebus*. All Romulan starships had early forms of force field screens, requiring that their attackers first overwhelm the cohesive energies of the screens before weapons could penetrate them and do damage to the ship itself. This remained a Romulan advantage until just before the war, when the Federation deployed force field screen technology of its own.

At least 30 *Cerebus* class cruisers are thought to have been built by the Romulans from 2130 to 2137. Most were lost during the Romulan War. This was largely due to the fact that by the time the war started they had already been outclassed by improved Federation designs. The survivors were briefly returned to front-line service in 2159 but this was a desperation measure due to rapidly mounting Romulan losses. Only four *Cerebus* class cruisers are known to have survived by war’s end. One sole example remains as a museum ship in orbit around Romulus. Its presence is meant as a permanent reminder of the great war that was fought “... to save the Empire from Federation domination.”

---

## SPECIFICATIONS:

Length:	140 m
Beam:	75 m
Draft:	45 m
Mass:	77,000 DWT
Crew:	110
Armament:	4 beam weapons 2 missile tubes 1 plasma cannon (wartime refit, replaces 2 inboard lasers)

Cruising speed:	warp 2.0
Maximum speed:	warp 2.5

### Innovations:

- First Romulan starship class ever observed
- First Romulan starship seen using force field screens



# ROMULAN U-19 *CRONUS*

(ROMULAN *VASTAM HATHAM* – “WARBIRD”)

SERVICE ENTRY DATE (ESTIMATED): 2154

DATE FIRST SIGHTED BY FEDERATION: 2158



The “Warbird” is by far and away the most recognizable of all Romulan designs. It began its service during the Romulan War and has existed, in one form or another, ever since. Its deceptively sleek and simplistic contours hide a powerful weapons array capable of destroying a starship twice its size given the chance. It is little wonder then that when the original Warbird made its debut, shortly before the start of the Romulan War, the Federation intelligence experts of the day gave it the code name of *Cronus*, king of the Titans in Greco-Roman mythology. The Warbird was without doubt the king of all Romulan starships of its time.

Evidence indicates that the Romulans were in the process of developing the Warbird as early as 2151. A Warbird predecessor, the *Cocytus* class, had already been spotted in 2156. The Warbird itself made its spectacular debut as part of the Romulan drive to Rigel in the opening months of the Romulan War. A squadron of six under the personal command of Fleet Commander Decius made a name for itself in battle after battle, as it helped push decimated Federation forces back towards the border. Romulan forces were then thrown into disarray when one of its Warbirds blundered into the Delta Triangle and was lost – the same one that happened to have Fleet Commander Decius on board. This bought the Federation enough time to regroup its fleet at Rigel, where it eventually stemmed the Romulan tide.

There were only 24 confirmed individual Warbirds sighted during the whole of the Romulan War. This stands in stark contrast to the 500-700 strong figures reported for the contemporary *Chrysaor* class and suggests that the war may have come too soon for the Warbird. Like the storied German Me262 of the Terran Second World War, the Romulan Warbird had too many advances and cost too much to be produced in sufficient numbers. It was the first starship in recorded Federation history to make use of a tritanium hull (one of the major

contributing factors to its expense). This fact would not be lost on starship designer Mark Chausser in later decades. No Warbird was ever lost to Federation forces in combat, and only one was lost during the whole of the war. It is a record that no other Romulan starship class of the Romulan War can claim. Such abilities also had their down side. It cost eight times as much to build a Warbird as it did the contemporary *Chrysaor*, and the complexities of its all-tritanium hull meant that each Warbird took about four years to build. Had the Empire been able to produce them in quantity then the tide of war might have taken a very different turn.

The only major difference in armament between the Warbird and the *Cocytus* was the removal of the wing-mounted missile tubes and magazines. These were relocated to the bottom of the primary hull, replacing the two dual laser mounts. Two single beam weapons were fitted in concealed fairings on the bow curve of the ship, apparently as a fallback measure. These relocations were necessary to allow the fitting of the most powerful warp engines ever installed to a Romulan starship during the war. Their extra power was used in the beginning to generate an improved warp field that allowed the Warbird to perform combat maneuvers that few other starships could touch. After the war they would prove useful in testing an early version of the Romulan cloaking device.

---

## SPECIFICATIONS:

Length:	250 m
Beam:	273 m
Draft:	60 m
Mass:	87,500 DWT
Crew:	100
Armament:	2 beam weapons 2 missile tubes 2 linked plasma cannon cloaking device (postwar only)

Cruising speed:	warp 3.0
Maximum speed:	warp 3.9

### Innovations:

- First “heavy” Romulan cruiser class
- Most advanced Romulan starship of its time

# 2166-2190: The Difficult Days

---



Those were difficult days. I remember as a junior officer getting bumped from one kind of ship to another. Never the same class twice. I was posted to six different starships in six different classes within ten years .... I was green then, mind you, and I've learned a lot about what was happening since then. It was as hard on the senior officers as it was for us. If only the damn politicians had left Star Fleet alone, then maybe we wouldn't have gotten in the mess we did. Then again, maybe we would have anyway.

William van Anling  
Admiral, Star Fleet (ret.)  
(2147-2251)

The period of time from the end of the Romulan War until just before the turn of the 22<sup>nd</sup> century is known in Star Fleet lore as “the Difficult Days.” It was during these years that Star Fleet seemed to lose its way. The reasons are obvious: hamstrung by a sharply reduced budget, forcibly re-tracked from a purely military organization into a “peaceful exploration force,” and constantly criticized for every misstep no matter how large or small. It was as if the rug of Federation faith upon which Star Fleet had once stood was suddenly yanked from beneath its feet. It stumbled, and continued to stumble for the next few decades, trying to regain a sense of purpose and dedication while fighting off the meddling of Federation politicians all the way.

The end of the Romulan War had brought the first major peace dividend to the Federation. Aside from

the brief police action of fighting the M'dok and the occasional terrorist threat, there would be no major conflicts in Federation space for decades. It is understandable what happened next. History repeated itself, regardless of culture or species or world. The citizens of the Federation grew content and even self-indulgent, quickly forgetting the horrors of the Romulan War in order to resume sedately peaceful lives. The politicians and bureaucrats within the newly re-organized Federation government greedily eyed the large outlays for Star Fleet spending and snatched all that they could. After all, who needed a large military during a time of peace? There was plenty of leftover hardware from the war. Why buy more? So, the funding that would have gone to keep Star Fleet in its prime went instead for public projects such as the Galactic Cultural Exchange, for Federation interstellar fairs, and so on. Only a fraction of its former budget now went to maintain the organization that had fought so hard to bring this peace dividend to life. Only a handful of supporters rose up to defend Star Fleet's development budget in the Federation Council. They were lone voices in the wilderness. Only the renewed possibility of war with the Romulans would finally bring the Council back to its senses. By that time, however, it was too late and the damage had already been done. Star Fleet would have to develop a whole new generation of starships from scratch before it could regain something of its former strength and glory of old.

---

The drastic reductions in Star Fleet spending in the late 2160s meant that it could no longer order production blocks



of 30, 40, or an “unreasonable” 50 starships at a time. Even an order for as few as 10 was often deemed “a needless waste of public funds.” Star Fleet had to limit its new military starship orders to three, four, maybe as many as a half-dozen vessels in a given class if they were lucky ... but only if they

were warships. Science vessels and transports were seemingly immune to the budgetary axe because they could be used "... for peaceful purposes, which is what the new Star Fleet is supposed to be all about." So the pundits of the day said, and so the politicians believed. Star Fleet Command had no choice but to grit its teeth and humbly accept the new role that was being defined for it: a semi-military enforcer of the peace for who violence was used only as a weapon of last resort. It hid what new builds it could under the guise of "research cruisers" and "science ships" while doing its best to maintain its rapidly aging fleet. Many veterans of the Romulan War could not accept this situation and left the service as quickly as possible, crippling Star Fleet even more. The Federation Council refused to stop this bleeding of talent because former Star Fleet veterans were proving themselves useful in the rapidly growing civilian shipping sector. This loss of a valuable talent and experience pool would hurt Star Fleet tremendously in the years to come.

Councilor T'Mek of Vulcan was typical of the political thinking of the time. She was the ranking member of the Procurement Sub-Committee, and it was she who repeatedly block additional funding for new Star Fleet starship classes.

I fail to see the logic in the outlay of funds for a class of starships with definite military connotations when there exists no clear need for such vessels. There are at present no pressing dangers from species beyond Federation space. What dangers that exist within our borders, such as the occasional terrorist act, have proven to be well within the current operational capacities of Star Fleet. Additional funding for a series of starships intended for wartime activities, which would be operating within a time of peace such as ours, is most illogical.

How far Vulcan had fallen from the days of the Earth-Kzin Wars, when the ability of Star Fleet's Terran ancestor to make war was a subject of praise on Vulcan, not scorn! It proved that even the Vulcans were not immune to the perils of peaceful times.



It is small wonder, then, that the quality of new Star Fleet vessels began to slip as the years rolled by. Despite the best efforts of some within the Starship Design Bureau, the rather unorthodox methods used by some to escape Council limitations coupled with fanaticism towards design preferences of the past would push Star Fleet to the brink of collapse. The highly publicized mess that was the *Tritium* Debacle involved failure at almost every level of the starship design and procurement process. It involved under-the-table deals on a heretofore unprecedented scale in order to build a class of starships that would obviously never work as designed to anyone with decent engineering sense. The end result was a starship that went out of control on its first major space trial, almost killing its crew and coming close to destroying several nearby space stations in the process before its wild tumbling could be stopped. The ensuing scandal would eventually break Cosmodyne Corporation, the main contractor for the *Tritium* program, as evidence of its kickbacks and bribes to cover shoddy contractor work came to light. Most of its senior executive officers would be imprisoned for crimes against the Federation by the mid-2190s, with many a former Star Fleet officer from the Starship Design Bureau sharing their cells with them. With the dissolution of Cosmodyne also came the death of the old Terran "slab hull" starship design philosophy. The *Tritium* Debacle had, more or less, put the final nail in the coffin of a design philosophy that should have been abandoned decades before.

With Star Fleet caught at the literal crossroads by forces without and within, it fell to its remaining civilian allies to take up the slack. Their names are familiar to students of Federation starship history. Cochrane Warp Dynamics of Alpha Centauri, the leader in the field of starship warp engines, along with their “friendly” new rival Kloratis Drive Systems of Tellar ... Chiokis Starship Design of Andor, staunch champions of the old Jeffries Project proposal, who were ready to take it to new and dizzying heights ... Vickers Shipbuilding of Terra, one of its oldest firms and subcontractor of many a Star Fleet design ... the new Deneva Research Station, whose research into microelectronics and materializer theory were about to bear fruit ... and more. Parallel breakthrough developments in many fields were unflinchingly pointing towards a whole new generation of Federation starships the likes of which even the legendary W. M. Jeffries had never dreamed. Only three things were missing from this slow-cooking stew that would make it ready: a new construction material capable of withstanding Warp 4 stress loads, a new starship design that could handle Warp 4 without tearing itself apart, and a new series of starship engines that could push a starship’s cruising speed past Warp 4 and beyond.

The first issue, a new construction material for starship hulls, unexpectedly proved to be the quickest to resolve. Trititanium (also known as *tritanium*) was discovered on the mining planet Motherlode in 2184. Once its elemental properties were determined and analyzed, it soon became clear that it was a natural for use in starship construction. It was as malleable as duraluminium but 21.4 times stronger than diamond. Laboratory tests indicated that a starship built with a trititanium hull could withstand theoretical stresses of Warp 20, five times more than the so-called “Warp 4 barrier” limiting duraluminium hulls. That was the nasty secret behind this legendary speed barrier. It was not that the warp engines of the day were not capable of exceeding Warp 4. It was that the starship frames



being built couldn’t stand the stress. There was no Warp 4 barrier, given the right building materials. Building a starship out of trititanium was an obvious solution to this problem. Its subsequent use on the base frame for the *Mann* classes would prove once and for all that the Warp 4 barrier was nothing more than the myth it had always been.

The second issue, a new starship design, had already been addressed. The pre-war Jeffries Project prototype had clearly shown the direction that future Star Fleet starships needed to take. The rebuilt *Bonaventure* (now lost) and its lone sister ship, the *Bonnie Chance*, were visible proof of the concept. Only the aftereffects of the Romulan War, the technology of the day, the construction limitations of the time, and the severe budget limitations imposed on Star Fleet by the Federation Council had prevented the Jeffries Project from yielding more fruit than it should have. The Federation Council couldn’t see this, though, caught up in post-war politics and more concerned with maintaining the present peace than planning for a future war. They took the excellent performance of the *Daedalus* class cruisers for granted without really knowing, or for that matter caring, what had enabled that excellence in the first place. They repeatedly denied Star Fleet’s requests for more starships of the rebuilt *Bonaventure* configuration until, as they had hoped, Star Fleet finally quit asking.



Fortunately for Star Fleet, its civilian contractors did not have to worry about interference from the Federation Council. They pressed ahead with refining the concepts embodied in the work of Jeffries and bringing them into the present. Chief among these



was Chiokis Starship Design of Andor, one of the strongest backers of Star Fleet in the Federation starship industry. Star Fleet manage to arrange the “loan” of the advanced starship *Bonnie Chance* to Chiokis for what they claimed was “routine in-service maintenance.” It was nothing of the sort. Chiokis engineers were allowed to put the *Bonnie Chance* through every space test they could devise, evaluating its performance under every conceivable condition as only trained starship engineers could do. The results further augmented the data Star Fleet had already made available to Chiokis from the trial runs of both the rebuilt *Bonaventure* and the original Jeffries Prototype. Chiokis now had all the data it needed to design new types of primary and secondary hulls for the next generation of Star Fleet vessels. The discovery of trititanium shortly thereafter was a literal godsend for this effort. While they waited for enough of this new material to begin construction on a new prototype, Chiokis senior engineer Mark Chausser and his assistant Franz Joseph IV began to work on a new design for a Star Fleet starship. That effort, with additional modifications, would forever revolutionize the Federation starship industry.



Meanwhile, two of Star Fleet’s other primary civilian contractors were hard at work resolving the third issue that blocked development of the next generation of Star Fleet vessels. Cochrane Warp Dynamics had already seen the first production versions of its PB-series circumferential warp engines, the PB-2, enjoy great success during the Romulan War. Their design was proven and reliable, easy to service and maintain, and open to quick upgrade due to the use of boom mounts as opposed to in-hull mounting. Cochrane was as ready as Chiokis and other Star Fleet contractors for the next generation of starships, and was as equally frustrated when the Federation Council repeatedly refused to grant the necessary funding. Nevertheless, it soldiered on with its own research



and development, doing its best to improve upon the promise shown by its postwar PB-6 “Quantum II” warp engine.

The PB-8 “Quantum III” was little more than a simplified PB-7 with every possible corner cut that would both reduce cost and maintain operational safety. Its main claim to fame was its use on the failed *Goliath* battlecruiser project of 2165. All involved were quick to point out that the engines themselves were not the reason for the *Goliath*’s failure. The engines themselves had performed admirably. The main problem was that they had been attached to a starship that was simply too big and had too many systems for them to handle. Star Fleet was able to salvage Cochrane’s reputation despite the failure by backing them before a hearing of an investigatory subcommittee of the Federation Council. The low-cost PB-8 would become Star Fleet’s favorite “second-tier” engine in subsequent years, often finding its way into fleet upgrade programs, with the last such being the *Marshall-C* refits of the late 2180s.



It was fortunate that newer warp engines from Cochrane were not used on the ill-fated *Tritium*. Instead they were busy developing the PB-14 “Pollux.” This design had tested at Warp 6 in simulation, further fueling efforts at developing a more powerful successor. There was no question now that Cochrane Warp Dynamics would have a new generation of warp engines ready for Star Fleet’s newest starship ... provided, of course, that the ever-present design and funding obstacles were overcome first.

While these years were a difficult time for the advancement of Star Fleet, they were boom years as far as the civilian starship industry was concerned. Freed from wartime restraints, armed with the latest technological advances, and enjoying a boom in





surplus hulls and parts, civilian starship development in the Federation underwent a virtual explosion following the Romulan War. No less than ten different major civilian starship classes were introduced to Federation service between 2166 and 2190 – all of which were civilian craft. Those were just the significant ones. There were at least twice as many lesser designs, as well as *almost a hundred* different type of the new “personal starships.” These were small, family-sized craft, akin to Terran automobiles of the 20<sup>th</sup> century or what had been intended with the Cochrane Interstellar Express in 2074. The post-war boom in the Federation economy, coupled with the relative low cost of late 22<sup>nd</sup> century starships, finally made personal starflight within the financial reach of all but the poorest Federation citizen. It was a new market waiting to be tapped and Federation businessmen would tap it with a vengeance. The personal starship market would prove so successful that by the end of the century over 20% of Federation families would own their own starship ... and more than one enterprising businessman would make multimillion credit fortunes in the process.

Civilian starship designers of the late 22<sup>nd</sup> century soon learned that their new customers expected no less of their craft than had Star Fleet or the interstellar trading conglomerates. Most wanted top performance at affordable cost, with travel in relative comfort and provisions for all of the normal amenities of life while enroute. Others wanted vessels tailored to their particular needs or tastes. A dedicated few, the “classic starship” pioneers of this new market, wanted easier access to surplus or decommissioned Star Fleet hulls for restoration or customization. Many companies soon emerged that could address the needs of all of these. The “classic starship” market had always been there, and always would be, but enjoyed a newfound popularity as the UESPA Foundation (and later the Star Fleet Association) gave their backing to the business. The “personal luxury” and “high-performance” civilian markets came into being around this time, with each catering to a specific niche of the



market. Finally, there was enough business in the Warp 2 “family” market for anyone who could maintain their profit margins without going broke in the process. One of the most surprising players of all in this “new” arena was the mighty Cochrane Warp Dynamics, which could no longer ignore the very industry it had helped to create and subsequently abandoned almost a century before.

Thus it was that while Star Fleet languished and the Federation Council fought over every last credit that it would be appropriated for new builds, the space lanes were teeming with thousands civilian starships of every shape, size, and description. All too soon, civilian designs would be competing with the best of Star Fleet in advancing the future of the Federation starship industry.



# STARSHIPS

## ***GOLIATH* CLASS BATTLECRUISER**

**SERVICE ENTRY DATE (OLD CALENDAR): N/A**

The *Goliath* was ordered during the dark days of the Romulan War (2160-2161), when the threat of Local Group invasion was all too real. It was the first Star Fleet vessel to evoke the image of the Terran aquatic dreadnought – a gigantic starship optimized for heavy firepower, designed to blast into the heart of the Romulan Star Empire at Warp 4 while destroying everything in sight. It was also Star Fleet's first colossal failure of this period in Federation spacecraft history.

The biggest problem with the *Goliath* was that it was too large. It was too massive and had too many systems for its engines to handle all at once. The end result was little more than a dreadfully sluggish, badly overgunned monitor. In theory it had a cruising speed of Warp 3.5. In space trials it could barely manage Warp 3. In combat trials it could be outmaneuvered even by an old Warp 2 freighter. The *Goliath* project was abandoned immediately after its space trials, after which the disarmed prototype was sold to recoup its development costs.

### **SPECIFICATIONS:**

Length:	312 m
Beam:	189 m
Draft:	95.6 m
Displacement:	245,000 DWT
Crew:	375
Armament:	20 laser banks 18 particle beam cannons 16 fusion torpedo tubes
Cruising speed:	warp 2.8
Maximum speed:	warp 3.1

### **VISUAL:**

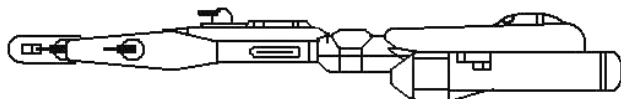

## ***AURORA* CLASS SPACE CRUISER**

**SERVICE ENTRY DATE (OLD CALENDAR): 2169**

The *Aurora* originated as a Vulcan “pleasure craft” that caught the eye of many a Terran visitor to Vulcan and its space colony worlds in the post-war era. Permission was eventually granted to copy the design so long as they left Terran factories unarmed. The *Aurora* class thus earned the unique distinction of being the first ever warp-powered civilian starship offered for sale after the end of the Romulan War. 269 of these six-person civilian starships would be built by 2180, with 3 major (*Aurora*, *Montcalm*, *Merido*) and 34 minor known different design variations. Among the various buyers were Federation politicians, business magnates, entrepreneurs, and wealthy families. The *Aurora* class was not limited to civilian use alone, though. In 2174, space cruisers of Duotechnica's *Meridio* sub-class would find their way into Star Fleet service as diplomatic couriers and low-priority transports. The Vulcan design heritage of the *Aurora* class ensured long service lives, with many still in service even today.

### **SPECIFICATIONS:**

Length:	21.1 m
Beam:	19.7 m
Draft:	10.6 m
Displacement:	18,750 DWT
Crew:	6
Armament:	none
Cruising speed:	warp 1.0
Maximum speed:	warp 1.6

### **VISUAL:**

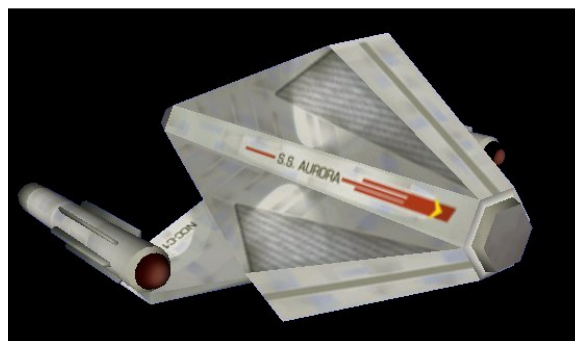

# TEXAS CLASS LIGHT CRUISER

**SERVICE ENTRY DATE (OLD CALENDAR): 2175**

The base design for the *Texas* class was a holdover from the Romulan War – a vessel intended not only to take punishment but to dish it out as well. As such it was something of an anomaly in the peaceful post-war era. Authorization for construction was cancelled and then reapproved several times before it was finally given the go-ahead in mid-2170. 50 were originally conceived back in 2160; by the time approval finally came through and the Federation Council had their way that number had been cut down to just 12. They were built as originally designed and as such was the last Star Fleet starship class to have laser-resistant armor plating. This had been rendered obsolete by the development of force field shielding systems during the War; however, Star Fleet saw this as an excellent opportunity to rid its inventories of excess reserve armor. What little was left over from the building of the *Texas* class was eventually sold.

These ships were obsolete from the moment they entered service. Their one saving grace was that they were one of the few Star Fleet starship classes designed for a planetary landing and take-off. As such they found their purpose as fleet support roles, often serving as fire support ships or ground support vessels. They excelled in the latter role, where their heavy weapons and armor plating would make them a favorite with the Star Fleet Marines during the war-torn days of the early 23<sup>rd</sup> century. Eventually four of these would be turned over to the Marines, who had them rebuilt as “commando cruisers” with modern warp engines and weaponry to better support their operations. The only obvious visual differences between this configuration and the original were the new PB-32 warp engines and the removal of the main navigational deflector from the front underside of the ship. These *Texas*-based “commando cruisers” would go on to become the longed-lived starships still in service with Star Fleet (120 years) when this document was published.

As of this date all *Texas* class light cruisers have been decommissioned. Only ten remain in the Star Fleet Reserve, with the others having been sold or scrapped.

## SPECIFICATIONS (2175):

Length:	189.9 m
Beam:	85.3 m
Draft:	50.1 m
Displacement:	112,000 DWT
Crew:	140
Armament:	6 laser banks 2 fusion torpedo tubes
Cruising speed:	warp 3.0
Maximum speed:	warp 3.6

## SCHEMATIC:

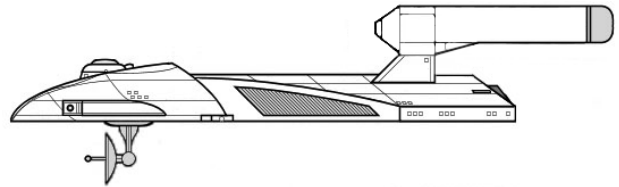

Configuration as-built (2175)

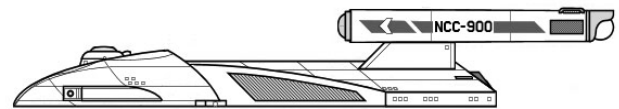

“Commando cruiser” configuration (c. 2260)  
As fitted with standard Class I era PB-32S series warp engines  
and main deflector removed for ground support operations

## VISUALS:



# **BOYDEN CLASS**

## **AUTOMATED TRANSPORT**

**SERVICE ENTRY DATE (OLD CALENDAR): 2177**

The *Boyden* class automated transports were the first Star Fleet vessels of this era in which the Federation Council approved high build numbers. This was largely due to the inexpensiveness of their unusual design. Conceived by Gulliver GPF, they featured an old-style, spiked-antimatter, rotary fusion reactor feeding two engine nacelles mounted top and bottom. The technology involved hailed from the Earth-Kzin Wars. By this time, however, spiked antimatter engines cost next to nothing to build; hence the almost instant approval of the class by the Council. 108 of these odd-looking craft were produced in two blocks between 2177 and 2190. Their only real flaw was that as automated vessels they were easy prey for space pirates and other looters, so they usually traveled in small convoys with at least one Star Fleet or several police vessels as escorts. Their odd design and overall reliability endeared them to Star Fleet Transport Command, for whom they would serve for the next half-century before retirement.

### **SPECIFICATIONS:**

Length:	62.6 m
Beam:	31.0 m
Draft:	39.5 m
Displacement:	40,360 DWT
Crew:	none
Armament:	none
Cruising speed:	warp 2.0
Maximum speed:	warp 3.0

### **VISUAL:**

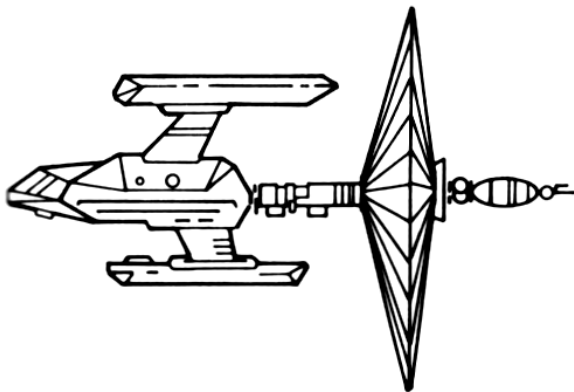

# **WATT CLASS TRANSPORT**

**SERVICE ENTRY DATE (OLD CALENDAR): 2180**

This was Star Fleet's first major post-war fleet transport class. It was very much a military design, with both high speed and high payload capacity. It had dual towing pads that could accept any of Star Fleet's standardized transport containers of the day. This necessitated the mounting of its dual warp engines in an over-under configuration, mimicking the arrangement of the older *Boyden* class automated transport.

The *Watt* class has the distinction of not losing any of its members to space piracy during its long service record. They would remain in Star Fleet service until the introduction of the Class II starship program in the early 23<sup>rd</sup> century. Most were sold to the civilian sector after their decommissioning, where many continue to serve to this day.

### **SPECIFICATIONS:**

Length:	164.2 m
Beam:	113.2 m
Draft:	34.0 m
Displacement:	89,000 DWT
Crew:	60
Armament:	4 laser banks
Cruising speed:	warp 3.0
Maximum speed:	warp 3.8

### **VISUAL:**

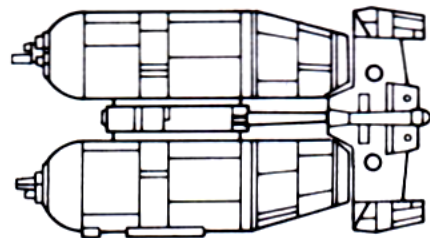

# MOBILE SPACE REFINERY

**SERVICE ENTRY DATE (OLD CALENDAR): 2183**

The need for large amounts of raw antimatter to power Federation starships saw the construction of these gigantic space refineries in 2183. They could either create raw antimatter from available matter or process natural antimatter wherever it might be discovered. They had no propulsion save for maneuvering thrusters and were usually towed into position by warp-powered tugs. They proved their value during the Four Years War with the Klingons (2246-2250), helping to keep Star Fleet vessels in the field while the limited Klingon fuel stores and stretched supply lines more than once caused their ships to withdraw from battle.

This “starship class” (although technically a mobile base) has never been retired due to its unique, one-of-a-kind nature. Star Fleet provides generous assistance to the civilian sector in their maintenance, modernization, and occasional upgrading because of their impact on fleet operations. The construction of a new mobile space refinery nowadays is rare, usually happening only when an older one wears out or is destroyed.

## SPECIFICATIONS:

Length:	335 m
Beam:	315 m
Draft:	163 m
Displacement:	375,000 DWT
Crew:	85
Armament:	none

## VISUAL:

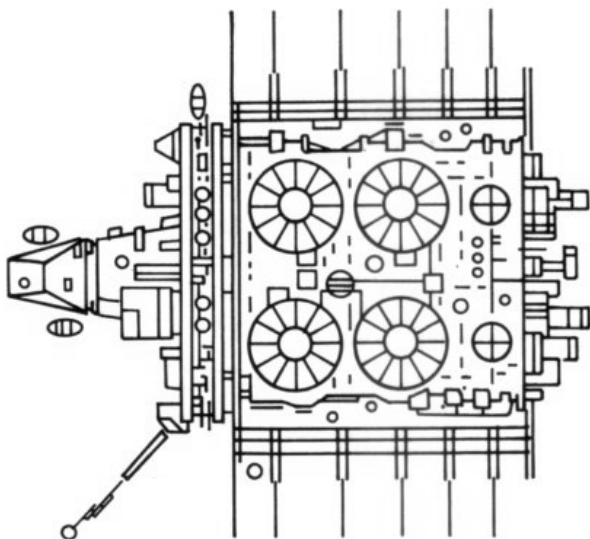

# STELLARFORD CLASS STARLINER

**SERVICE ENTRY DATE (OLD CALENDAR): 2185**

The *Stellarford* class starliners were the largest capacity passenger starships ever built. These had double the capacity of their largest predecessors (2200 passengers and crew), the latest in the civilian warp engines, and a cruising range that was the same as the most advanced Star Fleet starships of their time. They were extremely popular with the burgeoning space tourism industry of the day, frequently chartered for pleasure cruises to such spectacular stellar phenomena as the Jewel Stars. Their standard for luxury and opulence has yet to be matched.

All *Stellarford* class starliners had their original P-700 warp engines replaced with civilian model PB-16S circumferential warp drive units around the turn of the century. All were officially retired by 2221, however, they were reactivated and pressed into service as troop transports during the Four Years War (2246-2250). This was due to their sheer volume, which no other dedicated Star Fleet design at the time could match. While in temporary service with Star Fleet all were fitted with four phaser banks for defensive purposes. These were removed once they were returned to reserve status. At least two still survive as of this date in the Federation boneyard at Qualor II.

## SPECIFICATIONS:

Length:	264 m
Beam:	105 m
Draft:	96.8 m
Displacement:	34,000 DWT
Crew:	200 (+ 2000 passengers)
Cruising speed:	warp 3.2
Maximum speed:	warp 3.5

## VISUAL:





# PATTON CLASS DESTROYER

**SERVICE ENTRY DATE (OLD CALENDAR): 2187**

The *Patton* class was the first of three new starship classes that were part of Star Fleet's first major rebuilding effort after the Romulan War. It was named for the famous *Cavalry* class destroyer lost in the first battle of the Romulan War. It represents the last major iteration of the venerable *Marshall* class destroyer design.

36 of the new *Patton* class destroyers were built to bring the numbers of the *Marshall* class up to 100 vessels strong. In addition, a *Patton*-style upgrade was performed on most of the older *Marshall* class vessels. This is often referenced as the *Marshall-C* upgrade in publications on the subject. All of its laser systems were upgraded with more modern and powerful units on a two-for-one mount basis. The particle beam cannons were removed and replaced with additional fusion torpedo tubes and magazines. All ship's computer and support systems were upgraded to the latest standard as part of this process. The *Patton* class also got the latest in warp technology upgrades, with Star Fleet standard PB-18 circumferential warp engines replacing the obsolete Westinghouse models of old. Since the PB-18 was a close fit for the older engine assemblies a special "sleeve mount" casing was designed for the upgrade. This allowed for quick upgrading from *Marshall-B* to *Marshall-C* with minimum yard time and comparable field performance. New-build *Patton* class starships, on the other hand, had standard PB-18s fixed to their hulls on redesigned mounts.

Both the *Patton* and upgraded *Marshall* classes would remain in service with Star Fleet at full strength up through the end of the 22<sup>nd</sup> century. The last *Patton* was decommissioned in 2217.

## SPECIFICATIONS:

Length:	225.1 m
Beam:	117.0 m
Draft:	45.5 m
Displacement:	24,500 DWT
Crew:	157
Armament:	11 laser banks (7 fore / 4 aft) 5 fusion torpedo tubes (3 fore / 2 aft)
Cruising speed:	warp 3.2
Maximum speed:	warp 3.8

## SCHEMATIC:

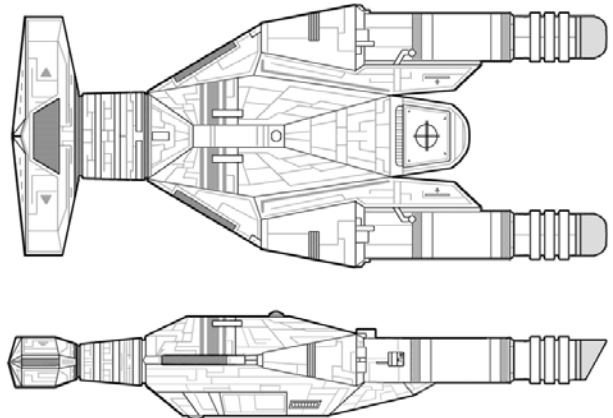

*Marshall-C, aka Patton upgrade*

## VISUAL:



An original *Marshall* (A-configuration) and the newer *Patton* in formation. Its overall dimensions betray its ancestry; however, the sleeker lines and upgraded warp engines of the *Patton* are quite evident in this image. One can also see how easy it was to come up with the notion of the sleeved engine mounts for the *Marshall-C's* PB-18 warp engine upgrade.

# TRITIUM CLASS BATTLECRUISER

**SERVICE ENTRY DATE (OLD CALENDAR): 2188**

The *Tritium* was the second of three new starship classes in Star Fleet's aborted rebuilding effort of the mid-2180s. It is also the reason why the effort collapsed. It is a legend among Star Fleet starship captains and engineers – not because of what it did; rather, what it failed to do. It was supposed to be the most advanced and powerful starship of its day, with its highly touted triple warp engine design theoretically capable of maintaining a cruising speed over warp 4. Instead, it wound up being a colossal failure, embarrassing Star Fleet to no end and becoming its second major design failure since the end of the Romulan War. The *Tritium* debacle was the most costly mistake in Star Fleet history. Thankfully, it has never been repeated.

According to most experts, the only two good things to come out of the *Tritium* program were its 12-person shuttlecraft and the introduction of the tricorder as Star Fleet's first all-purpose survey tool for landing party teams.

## SPECIFICATIONS:

Length:	202 m
Beam:	161 m
Draft:	118.6 m
Displacement:	47,600 DWT
Crew:	250
Armament:	12 laser turrets
Cruising speed:	warp 3.2
Maximum speed:	warp 3.6

## VISUAL:



A civilian transport preparing to make planetfall



A system patrol cutter making its rounds



The Dreamstar, most popular civilian starship of the era



Explosion of the Phi Puma supernova

# **23<sup>rd</sup> CENTURY**

---

**The Age of Advancement  
(2191-2295)**

# 2191-2220: A New Direction

---



By the beginning of the 23<sup>rd</sup> century Star Fleet knew where it needed to go in with its next generation of starships. All of the experimentation over the past 25 years had paid off in the form of a series of design specifications that, once combined, would produce the ideal starship. These were a flattened, preferably thin disc-shaped primary hull; a streamlined “Block IV” style secondary hull, and twin warp engines on booms mounted up and away from the secondary hull.

There were two more hurdles Star Fleet had to jump before it could start work in earnest on its next generation of starships. The first was the obvious cost. The recent funding cuts made in Star Fleet’s appropriations from the Federation Council limited just how “modern” an all-new build program could be. In order to be cost-effective this new program would have to be a mix of both old and new: just enough old in the right places to keep the budget down while as new as possible everywhere else. The second was limited yard space. Star Fleet still had several ship classes building, both from older programs and from many side projects (such as science and survey vessels) mandated by the Federation Council. In addition, many civilian spaceyards that had once catered exclusively to Star Fleet now had slipways full of civilian spacecraft of all kinds, with more on order for this ever-expanding market. Vickers Shipbuilding was the one spaceyard with space available (saved, in fact) for a new starship program. The new ships that Star Fleet was proposing, though, could not be built by Vickers alone. It simply didn’t have the capacity to fabricate all of the major components and control systems by itself. Many of these would be brand new

and had never been incorporated into a single Star Fleet vessel before. A solution would have to be found to all of these issues before Star Fleet could proceed with its next generation starship program.

The famed Terran scientist Thomas Alva Edison once said that “necessity is the mother of invention.” So it was that Mark Chausser of Chiokis Starship Design, the lead engineer for Star Fleet’s next generation starship program, proposed a innovative (and rather radical) solution in early 2201. Instead of awarding a full naval construction contract to a single contractor, multiple contracts would be awarded for individual components – such as what Star Fleet was already doing with its warp engines. One major contractor (in this case Vickers Shipbuilding) would be in charge of the hulls and frames, while Star Fleet itself coordinated the work of component contractors and supervised final starship assembly. The finished starship could then be launched in considerably less time than it would take to have one contractor do everything for Star Fleet. The potential savings in administrative costs alone were significant. This method would also free up more yard space for additional construction, since less dock time would be required for a given build class under this scheme. Construction of individual components would take place in parallel in smaller facilities. Only when the time came for final free-space assembly of the frame and all of its components would a starship-sized spacedock be required. An obvious side benefit of such a program would be standardized starship components. These could then be interchanged across vessels in the same class, starship classes using similar components, or even arranged in different configurations for new starship classes. It seems so obvious today but at the time it was a major breakthrough in starship design philosophy. Chausser called this the *modular component procurement program*. Star Fleet’s Starship Design Bureau called it a godsend. This program was first implemented with the *Baton Rouge* and *Ranger* class

cruisers program in 2205. It has remained the standard for Star Fleet starship design ever since.

---

As part of its move to keep the costs down on its next generation of starships, Star Fleet switched warp engine suppliers for the first time in its history. There was no question that the Cochrane Dynamics PB-18 series was going to be one of the best warp engines of its generation, given its maker. Unfortunately, Cochrane was still having problems working out technical glitches with the energy regulation systems of the PB-18, meaning it would not be ready in time for the new starship program. Facing a looming production deadline and the potential for rising development costs, Star Fleet had no choice but switch suppliers and go with the VX-28 “Pegasys” warp engine from Kloratis Drive Systems. This was an opportunity heaven-sent for this Tellarite firm. The new VX-28 had already been suggested for the *Mann* class survey cruisers but had been passed over due to mount incompatibilities with the *Mann* hull design. Their overall similarities to Cochrane’s Perth PB-series, however, made them an excellent substitute for the problem-plagued PB-18. They would perform exceptionally well with the Jeffries-type hull configuration being adopted for Star Fleet’s next generation starship program. The Kloratis VX-28 “Pegasys” warp engine was one of the best designs of its generation. It would also become the visible trademark of all *Baton Rouge* generation starships.

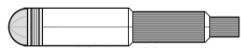

Star Fleet would eventually adopt Cochrane-derived warp engines again in a few short years for other starship classes. Nevertheless, Star Fleet engineers would always have a special place in their hearts for their “odd child,” as they lovingly called the VX-28 “Pegasys.” Although somewhat less powerful than Cochrane’s original PB-18 design, the VX-28 was easier to operate and required minimal maintenance in comparison. It was the first modularized Star Fleet warp engine that was rated for a cruising speed above Warp 4. It was also the last operational Star Fleet warp engine produced before the dawn of

dilithium-regulated designs. It is interesting to note that even today Star Fleet has yet to completely abandon the venerable VX-28 despite its “odd child” status. One can still find several of them at every starbase and major port facility, ostensibly for the few *Baton Rouge* era starships still in fleet service. There is a method to this seeming madness, however. It was not unheard of during the Four Years War for a damaged Class I starship with warp engines beyond repair to be temporarily fitted with VX-28s in order to get it operational again. Such seems to be part of the reasoning behind Star Fleet’s continued maintenance of its remaining VX-28 inventories around the Federation. Its excellent operational record, despite its age, has no doubt ensured that Star Fleet will keep the VX-28 around, even if only as a quick-fit “fill-in” engine, for years to come.

---

The use of the Kloratis VX-28 “Pegasys” warp engine was not the only compromise Star Fleet had to make with the *Baton Rouge* generation. The secondary hull for the program was nothing close to what had originally been planned. That too was a necessary, cost-savings compromise. In order to gain support for the *Baton Rouge* generation Star Fleet had to court some of its fiercest political foes, ones who had long been advocates of the old Terran “slab hull” designs. It didn’t matter that this particular design philosophy had reached a dead end. What was needed were construction funds and political support in the Federation Council if Star Fleet was going to get all the ships that it wanted. Both Mark Chausser and his assistant Franz Joseph IV were upset when they heard about this. They understood, though, that insofar as this generation of Star Fleet vessels were concerned they couldn’t have their cake and eat it, too. The most important thing, as Star Fleet liaison Captain William van Anling pointed out, was to get them to accept the new primary hull saucer. Once that was in place then the rest of the Jeffries Project concept would follow. It was a natural, given what

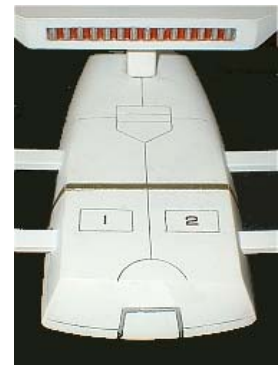



was already happening with the experimental *Mann* class cruisers. Of all the parts of the *Baton Rouge* design that were required, the secondary hull was the only one left that could be compromised. The real next generation design – “Project Starship,” as some jokingly called it – would have to wait a few more years until Star Fleet could be confident of Federation Council approval. Chausser and Joseph grudgingly agreed to incorporate a redesigned “slab hull” type secondary hull into the *Baton Rouge* program as close to Jeffries Project specs as this antiquated philosophy permitted. In the meantime, though, Chausser kept himself busy working up a “real” secondary hull once the time was right to for it to be accepted. He never got the chance to see it become reality.

Mark Chausser, the genius behind the *Baton Rouge* generation of starships, the creator of the Star Fleet primary hull saucer, and the man who almost single-handedly changed the direction of Star Fleet starship design, was tragically killed in a shuttlecar accident in 2204. He was on his way to a meeting of the Procurement Sub-Committee of the Federation Council when he was hit head-on by a drunk driver. Chausser was killed instantly. He never got to see the new generation of starships that he helped bring about come to life. Franz Joseph IV, his protégé, who was only twenty-nine at the time, succeeded him as chief starship designer of Chiokis. It would be up to Joseph to oversee his mentor’s dream as it became reality ... and to make sure that no compromises were made once it came time for Project Starship’s turn at the docks.

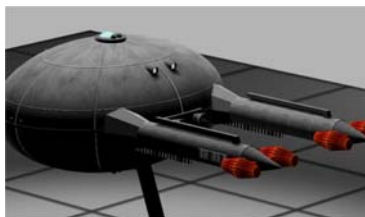

For all that it was about to do for Star Fleet and the Federation, there was one honor that would forever be denied the *USS Baton Rouge*. On 27 May 2192, the new survey cruiser *USS Mann* officially broke the legendary Warp 4 barrier. It achieved and maintained a cruising speed of Warp 4.2 for three hours without

any signs of stress to its hull or frame. Later space trials would push the cruising speed limit up to Warp 4.5 as far as the *Mann* and the rest of its class was concerned. The event was hailed in the press of the day as the most significant in the history of warp drive since its invention by Zefram Cochrane. To be more accurate, though, it proved Mark Chausser’s theory that the use of a trititanium frame would remove all known limits on starship design. The *Baton Rouge* class and its derivatives, the first with all-trititanium hulls and frames, would be the first to exceed Warp 5. The situation that had so plagued starship designers in the 21<sup>st</sup> and 22<sup>nd</sup> centuries was now effectively reversed. From this point forward it would be the warp engines, not the hull or space frame, which would effectively limit just how fast a properly designed 23<sup>rd</sup> century starship could go.

During the past decade all research on the *materializer*, the ancestor of the modern transporter, had come to a virtual standstill. The issue of its use with living organic matter, such as an intelligent lifeform, had been bogged down in Federation courts due to ethical concerns. The key question at the heart of the matter was this: did a being put through a materializer “die” in the process? In other words, was the lifeform that came out the other side the same one that had gone in? The case eventually worked its way up to the Federation Worlds Court, which made its landmark ruling on the subject in 2200. Its summation reads as follows:



As has been demonstrated to the satisfaction of this Court, the essence of Materializer operation is the total conversion of a living being from a matter state to a pure energy state, transporting that energy over a distance while maintaining its cohesion, then reversing the process and totally converting said energy back to a matter state identical to its previous form with the use of a previously stored pattern. As the conversion from matter to energy is total and complete, as cohesiveness is maintained in transit, and as reconversion is in effect a successful total reversion of said process, then there is no chance for the quality known as life to be lost through the use of a Materializer save for problems with the equipment

or a premeditated act. This is in effect the same guiding principle as for any other tool, instrument, or system with the potential to cause harm to or take the life from any being. To this end this court sees no ethical issues associated with the use of the Materializer on a living being so long as the proper safety precautions are taken with regards to operating procedures and the equipment involved. This court rules in favor of the Defendant.

With those words the Federation Worlds Court cleared the last remaining hurdle in the development of what we know today as transporter technology. Star Fleet, realizing its implications, promptly threw its backing behind the efforts of the renewed research effort at the Deneva Research Station. In 2206 the first successful transport of a living being with a materializer was conducted at the Deneva Research Station. In 2208 the *Baton Rouge* class starships *USS Moscow* and *USS Tehran* participated in the first successful shipboard test of materializer technology. Within a few years they would become a standard part of shipboard systems aboard all Star Fleet starships. Materializers would never completely replace short-range shuttlecraft and warp shuttles for various reasons (such as energy field interferences); however, within the century they would become the preferred method of transit for all Star Fleet landing party teams and Star Fleet Marine insertion/extraction operations.



It is a fact of technology that one important breakthrough inevitably leads to another. William Abramson's development of the theory of transtator physics led to the invention of the transtator by Vukovic and Govindarajan. This is the fundamental building block on which all of modern Federation computer and electronics technology is based. The development of the transtator in turn enabled Dr. Richard Daystrom, one of the Federation's most pre-eminent computer scientists, to bring to life a theory he had been developing since his teenage years. There is not space enough in this



document to describe how he took his dream and made it reality. Suffice it to say that when he was done, his *duotronic computer system* revolutionized the industry. It changed the face of applied Federation computer technology as thoroughly as did the introduction of the first personal computers in Terra's late 20<sup>th</sup> century. Once again, the power and processing capabilities of systems that had once filled rooms and even whole buildings became available in small and compact form. The impact on the starship industry alone was enormous. Duotronic-based ship's computers, among the largest such systems of their day, were capable of controlling and regulating every single major function of a starship with only routine crew maintenance. This alone freed up manpower previously needed for starship operations, which resulted in less deck and more science personnel being assigned to Star Fleet vessels. The most important asset of a duotronic ship's computer, though, was its split-second ability to dynamically control and adjust a starship's warp field. This allowed Star Fleet designers to not only break the old "Roddenberry Twin-Nacelle Rule" but to solve all the problems associated with the old tri-nacelle configuration in one stroke. Single-nacelle starships would be the first such previously "impossible" designs to enter service with the *Drake* and *Cooke* class starships. Limited funding and Council indifference, though, did not permit Arbing and Lidde's initial proposal for a *Baton Rouge* era triple-engine dreadnought to become reality at this time. That development would have to wait several more decades and another interstellar war before it too would come to life – an "impossibility" made possible by the duotronics breakthrough.



As has been mentioned before, the energy regulation issues that plagued Cochrane Warp Dynamic's new PB-18 warp engines prevented their acceptance by Star Fleet for several years. It even caused Cochrane to lose the warp engine contracts for the entire

*Baton Rouge* generation of starships. The fact of the matter was that current warp engine designs had reached their limits, yielding a designed cruising speed in the Warp 4 to 4.5 range and a designed emergency "burst" speed of Warp 6. Beyond those limits, regulating the required energy flow was practically impossible for the warp engine technology of the day to handle. The next major breakthrough in this field would be accomplished by chance. When the rubidium focusing crystal of a mining laser was broken at the Lalande VIII mining complex in 2208, a quick-thinking engineer promptly fabbed a new crystal from a nearby dilithium deposit. The first time the rebuilt laser was tried, it had suddenly gained four times as much power despite having the same fusion generator as before. Word soon spread, with mining engineers all over the sector making the same adaptations to their equipment. It was inevitable that Star Fleet would learn of this discovery and pass it on. As the reader might have guessed, this discovery would eventually lead to the development of phaser technology some four decades later. More important for its time, however, the unusual energy moderating properties of dilithium crystals proved the solution to the problems plaguing Cochrane's PB-18 warp engine.



Unlike the Romulans, though, the Klingons were openly aggressive and showed no fear of Star Fleet's current border forces. The *Baton Rouge* and her sister ships were subsequently rushed to the border as fast as they could be completed, where their sudden appearance had the desired effect. The number of Klingon border incidents went on a marked decline, with only the occasional incursion or ambush taking place for the next few decades. War with the Klingon Empire seemed a certainty in the near future given its bellicose nature. Even so, the introduction of the *Baton Rouge* generation of starships is credited by many with delaying the start of that war for decades.



It was a good thing that the modernization of Star Fleet was no longer being neglected. A new threat to the *Pax Federationis*, as some called the long peace that followed the Romulan War, was making itself felt on the Federation border beyond the Rigel sector. As in the days before the Romulan War, Federation starships were disappearing or being attacked by a mysterious foe. The Orions obviously knew who they were; however, the Orions weren't talking. A chance encounter by Federation trader E.A. Jacoby would not be realized for the significant event that it was and his first contact report subsequently lost in bureaucratic red tape. The attack on the transport *Millie Sue* and the subsequent attack on the Star Fleet vessel *Sentry* proved to all concerned the overt belligerency of the "newly discovered" Klingon Empire.

# STARSHIPS

## ***MANN* CLASS SURVEY CRUISER**

**SERVICE ENTRY DATE (OLD CALENDAR): 2192**



The *Mann* class was named for Captain Stuart Mann, the late commander of the *USS Horizon* and one of the true pioneering starship captains of the *Pax Federationis*. *Mann* was built by Chiokis Starship Design under the pretense of being scientific and exploratory vessels; in effect, less expensive stablemates to the *Horizon* class starships. The real purpose of the *Mann* class, however was to break the legendary Warp 4 barrier. To that end the secondary hull was sacrificed and all ship's functions concentrated within a "bloated disc" primary hull, with its twin warp nacelles mounted directly on its backside. The limits of its internal volume obviously limited its mission profiles, a fact which the Federation Council either did not notice or chose to ignore when they authorized 12 ships in the class for construction. The custom-built Vickers J27-A warp engines (licensed from an experimental Cochrane design) and Chiokis-designed trititanium frame allowed the *USS Mann* (NCC-750) to hit and maintain a Warp 4 cruising speed on its very first space trial. The *Mann* and its siblings would go on to carve their own niche in Federation spacecraft history despite their "little brother" status to the mighty *Horizon* class.

Starships of the *Mann* class seemed to be everywhere during this part of the *Pax Federationis* (2163-2245). In 2198 the *USS Leonidas* (NCC-752), under the command of Captain Pyotr Mirabella, was successful in locating and securing a "Flying Fortress" that had been spacejacked by pirates and was about to be liberated of its cargo (an experimental improved Star Fleet deflector system). In 2200 the *USS Endurance* (NCC-757), under the command of Admiral Okuru Nelson, oversaw the final stages of the evacuation of all 10 million inhabitants of Bayard's Planet before its surface was ravaged by the radiation-soaked shockwave from the Phi Puma supernova. Also in 2200, the

*USS Sagan* (NCC-758) became the first Star Fleet vessel in history to have an all-Andorian crew. In 2202, the *USS Poseidon* (NCC-755), under the command of Captain Marvin D. Goodwell, entered orbit around the planet Hydra II and thus discovered the first pelagic planet in the history of Federation space exploration.

The very design that had enabled the *Mann* to become the fastest starship of its day ultimately proved to be its undoing. Its restrictive internal hull volume, comparable to that of a *Horizon* class starship's secondary hull, severely limited the amount and types of upgrades it could receive. The class was eventually retired from Star Fleet service in favor of the *Ranger* class, its *Baton Rouge* era successor, in the early 2220s.

### **SPECIFICATIONS:**

Length:	185 m
Beam:	101.7 m
Draft:	40 m
Displacement:	54,000 DWT
Crew:	294
Range:	8 years at L.Y.V.
Armament:	6 laser banks 2 fusion torpedo tubes
Cruising speed:	warp 4.0
Maximum speed:	warp 4.5

#### Innovations:

- First Star Fleet starship capable of maintaining a Warp 4 cruising speed
- First starship in Federation history to achieve a 1:1 matter/antimatter intermix ratio with its warp engines
- First Star Fleet starship to be fitted with a dual purpose sensor/deflector grid system on its hull.

### **SCHEMATIC:**

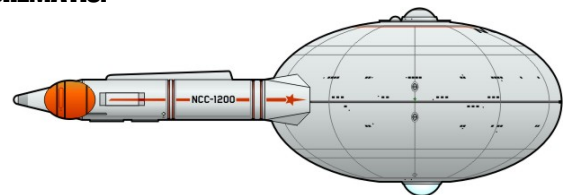

# PROVIDER CLASS TUG

**SERVICE ENTRY DATE (OLD CALENDAR): 2193**

The *Provider* class tug will forever be associated to students of Federation spacecraft history with the massive, 100-kilometer long warp superconvoys that became a common sight in the Federation during the early years of the 23<sup>rd</sup> century. In this time, before the capability for bulk mass transport of goods via special transporter beam conduits through space, these massive superconvoys were the primary means for transporting millions of metric tons in processed goods from one Federation system to another. Each superconvoy had eight *Provider* class tugs in an octagonal arrangement at its head, interlinking and synchronizing their warp fields in order to both pull and steer the superconvoy. "Booster squares" of four tugs staged between every 10-container segment assisted in this process. The superconvoy has since gone the way of the proverbial dinosaur; however, plenty of *Provider* class tugs still provide towing services in the civilian sector even today.

## SPECIFICATIONS:

Length:	225 m
Beam:	220 m
Draft:	45.6 m
Displacement:	72,500 DWT
Crew:	66
Armament:	4 laser banks
Towing speed (laden): warp 2.0	
Cruising speed (unladen): warp 3.5	

## VISUAL:

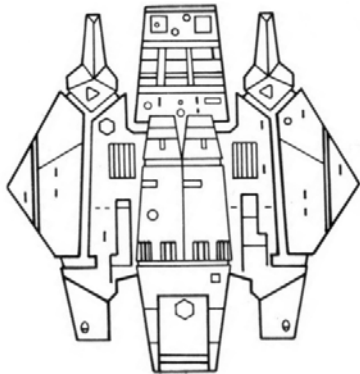

PROVIDER DESIGN BY RICK STERNBACH

# RICKENBACKER CLASS

## "FLYING FORTRESS" TRANSPORT

**SERVICE ENTRY DATE (OLD CALENDAR): 2194**

The "Flying Fortress" was specifically designed to provide the most secure means possible of transporting extremely valuable cargoes across Federation space. To that end the *Rickenbacker* class transport carries cruiser firepower in addition to double shielding, old-style ablative armor, and triple-layer armored cargo holds with a fully armed security detail on board (or Marines, if in Star Fleet use) for extra protection. Its cargoes have covered the full range of Federation valuables, from a single bottle of Saurian brandy of rare vintage to holds full of pressed latinum bars for interstellar commerce. Only once in its official service history has a "Flying Fortress" been successfully attacked and disabled, but even then its badly mauled hijackers were unable to penetrate the multiple layers of its armored holds in time before Star Fleet arrived on the scene and finished them off. These vessels have since been replaced in mainstream commerce by more modern designs; however, one can still occasionally encounter a "Flying Fortress" operating in the outer sectors of Federation space.

## SPECIFICATIONS:

Length:	310 m
Beam:	195 m
Draft:	185 m
Displacement:	190,000 DWT
Crew:	422
	(not including security or Marine details)
Armament:	20 laser banks
	12 fusion missile tubes
Cruising speed:	warp 4.0
Maximum speed:	warp 4.5

## SCHEMATIC:

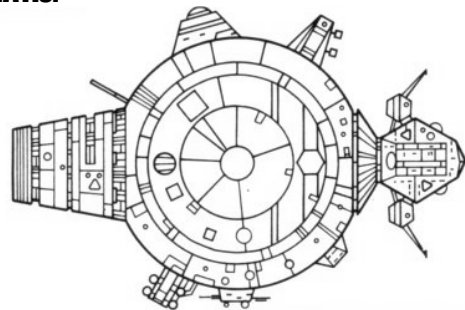



# LOWELL CLASS SCOUT

**SERVICE ENTRY DATE (OLD CALENDAR): 2198**

This is the second of three starship classes in the so-called “*Mann* generation” recognized by some starship historians. It is nothing more than a scaled-down *Mann* with pylon mounted warp engines for easier upgrading and maintenance. The use of the *Mann* design as its basis all but ensured Warp 4 performance. At half the size of its inspiration, though, its interior spaces as designed were extremely cramped and reminded some grizzled Star Fleet veterans of the pre-war *Cavalry* class destroyers. In order to help alleviate this situation most of the sensor suite was removed and mounted on external pods fitted amidships so as to cause minimal impact on the ship’s warp field. In addition, a “drag pod” with special sensors could be deployed from a housing mounted aft, between the dual warp engine pylons.

The *Lowell* class starships were designed as high-speed scouts, capable of moving in and out of sensitive areas as fast as possible while taking as many sensor and scanner readings in the process. Its one flaw was the lack of a torpedo tube. Although not seen as an oversight at the time, the subsequent development of self-propelled sensor probes (an adaptation of torpedo technology) guaranteed the obsolescence of the class. The last *Lowell* class scout was retired in 2222.

## SPECIFICATIONS:

Length:	74 m
Beam:	28.8 m
Draft:	23.7 m
Displacement:	26,000 DWT
Crew:	130
Armament:	4 laser banks
Cruising speed:	warp 4.0
Maximum speed:	warp 4.7

## SCHEMATIC:

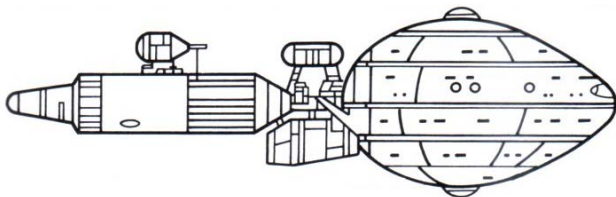

# CR594 MOBILE CONSTRUCTION RIG

**SERVICE ENTRY DATE (OLD CALENDAR): 2203**

These were the first rapid-deployment space docks in Star Fleet history. The intention the CR594 was to have the capability of deploying a full-fledged construction and repair facility in the field as quickly as possible whenever such was required. Warp tugs did the actual deployment, with the CR594 itself having only ion-powered station keeping thrusters for limited propulsion. In the absence of a fleet tug a special gravitic impeller drive, courtesy of Utopia Planitia Shipyards, could be fitted for transport. This was rarely used, though, limited as it was to Warp 2 due to the CR594’s sheer mass. Within its frame were all the facilities and equipment necessary to build, repair, or upgrade all of Star Fleet’s current and next-generation starships given proper materials. The only exception was the one-of-a-kind shuttlecarrier *Illustrious*, which was as big as the CR594 itself. The last officially left fleet service in 2253; however, most are still in operation with new civilian owners and now service Federation civilian shipping instead. The CR594 is the direct ancestor of the “classical” series of spacedocks (*Maya*, *Roman*, etc.) in use by Star Fleet today.

## SPECIFICATIONS:

Length (with impeller):	1600m
Beam:	275 m
Draft:	238 m
Displacement:	2,875,000 DWT
Crew:	750
Armament:	none
Cruising speed (*):	warp 2.0
Maximum speed (*):	warp 2.2

(\* ) with gravitic impeller drive; incapable of warp if not

## SCHEMATIC:

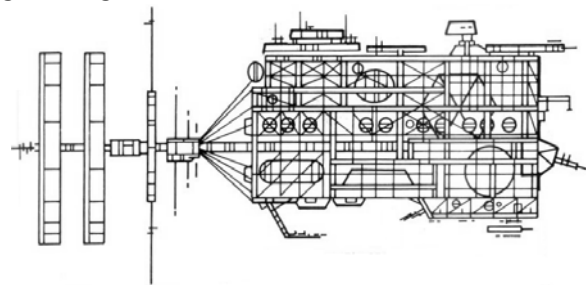

CR594 with optional gravitic impeller drive attached

# BERING CLASS AUTOMATED TANKER

**SERVICE ENTRY DATE (OLD CALENDAR): 2204**

These vessels were procured for Star Fleet Transport Command for the bulk transport of liquids, slushes, and gaseous materials. The actual "ship" as such consisted of the warp engine, an interconnecting dorsal, a control deck (normally automated with provisions for a small crew as required), and container interlock modules. These interlocks allowed as many containers as needed to be attached up to the load required or the limits of the engine. The illustration below shows a fairly common three-container configuration. Configurations of six, eight, or even twelve containers were not unheard of, though, and on at least one occasion a *Bering* was configured to haul fourteen containers.

The *Bering* class remained in service with Star Fleet, with numerous system and engine upgrades, up through the Four Years War (2246-2250). They were relegated to the Star Fleet Reserve in the mid-2260s. They were finally sent to the boneyards in the late 2270s, with the last *Bering* class starship being scrapped in 2281.

## SPECIFICATIONS (AS ILLUSTRATED):

Length:	204.1 m
Beam:	54.4 m
Draft:	115.5 m
Displacement:	173,900 DWT
Crew:	none
Armament:	none
Cruising speed (unladen):	warp 4.0
Towing speed (laden):	warp 3.0

## SCHEMATIC:

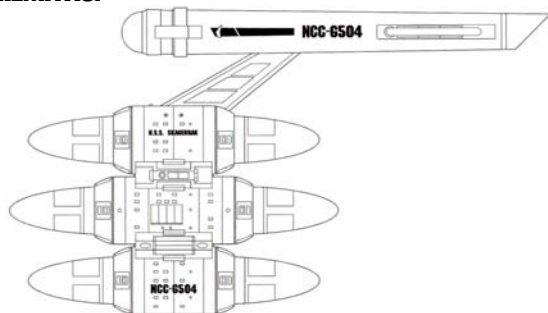

*USS Skagerrak* – as found in the Delta Triangle (2264)

# HUNTER CLASS CORVETTE

**SERVICE ENTRY DATE (OLD CALENDAR): 2201**

Entering service at the turn of the 23<sup>rd</sup> century, the *Hunter* class corvette was best known for its long association with Federation intersystem police forces. It was based on a military patrol ship design that had ultimately been rejected for the usual budgetary reasons. Overall, the *Hunter* class enjoyed an excellent reputation with its crews. It was unmatched in its class against all but dedicated military designs and Orion pirate vessels. The last *Hunter* was retired from police service in 2225; however, many can still be seen in use under private ownership.

## SPECIFICATIONS:

Length:	85 m
Beam:	38 m
Draft:	43 m
Displacement:	4125 DWT
Crew:	6
Armament:	4 laser banks
Cruising speed:	warp 3.6
Maximum speed:	warp 4.8

## VISUAL:

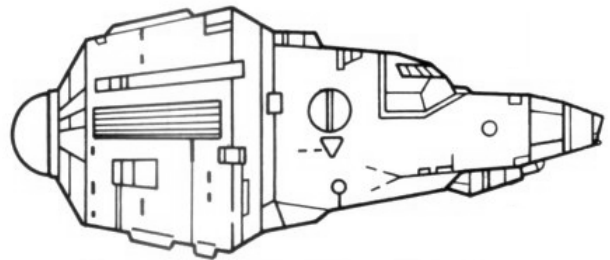

*HUNTER* DESIGN BY RICK STERNBACH

# BATON ROUGE CLASS

## HEAVY CRUISER

SERVICE ENTRY DATE (OLD CALENDAR): 2205



*U.S.S. Moscow* (NCC-1357), Star Fleet Museum

The *Baton Rouge* class starships represented the penultimate configuration of a quarter-century worth of efforts by both the Starship Design Bureau and Chiokis Starship Design of Andor in order to come up with the best starship design for general fleet use. It was the first starship class fitted with transporter technology and the last without dilithium-moderated warp engines. It also has the distinction of being the first starship class ever built under Star Fleet's modular component program.

The visual likeness to the original Jeffries Program prototype of 2155 is striking. The main differences are due to both design and budget considerations. The all-tritanium Chiokis-style "thin saucer" was a first in Federation starship construction. An oversized "slab type" tritanium secondary hull, fitted in standard configuration under and behind the primary hull, provided additional room for survey and exploration facilities as well as one of the largest starship shuttlecraft hangers at the time. An "underslung" engine configuration had to be employed instead of the favored "overhull" one in order to offset the warp field drag of the oversized impulse deck. This had the side benefit of making the new vessel more maneuverable in warp, albeit sacrificing some speed and acceleration in the process. The Kloratis VX-28 "Pegasys" warp engines were the first time that Star Fleet had ever contracted outside of Cochrane Warp Dynamics for a major starship class. They would go on to become one of the visual hallmarks of the *Baton Rouge* generation.

An interesting experiment at the time was the use of two small warp engine support pylons per side instead of one large one. It was hoped that this would give the design more stability and allow for higher warp speeds. In reality the advantages gained

by the "thin twin boom" concept were minimal at best. The *Nordenskjold* class, the final *Baton Rouge* build group and often considered its own class due to several significant design changes, would revert back to a single support pylon system.

The use of modular construction techniques in the building of the *Baton Rouge* class, plus the push to get it into service as quickly as possible, made it one of the fastest built starship classes in Federation history. Almost every ship in the class went from base assembly of major components to final fitting of interior systems within ten months and commissioning within sixteen. The *USS Baton Rouge* (NCC-1300) beat the lead ship of the similar *Ranger* class survey cruisers out of the yard by mere hours, thus becoming the first of its generation and lending its name to this era in Federation spacecraft history.

As predicted the *Baton Rouge* modular construction program spurred the development of multiple side starship classes based on *Baton Rouge* components. Fifteen different derivative designs were planned at one time, with six actually put into production. These were the *Ranger* class survey cruiser, the *Constant Warwick* class light cruiser, the *Drake* class destroyer, the *Cook* class scout, the *Anton* class cruiser, and the *Detroyat* class heavy destroyer. A seventh, the *Marklin* class destroyer, was converted to the Class I Program just as it was about to begin construction. All of the *Baton Rouge* era designs would be incorporated into the subsequent Class I Program. This resulted in all of the older *Baton Rouge* era starship classes being cancelled, many while ships were still under construction. This explains why there are obvious gaps in starship classes when comparing the Class I and *Baton Rouge* generations, as well as the shortage of vessels in certain *Baton Rouge* era designs. The leftover *Baton Rouge* era components would be used to keep their generation in service or for experimental designs (such as the *Kearsage* class light cruiser).

A total of 25 *Baton Rouge* class starships were built between 2205 and 2212. This was the largest build class of a new Star Fleet ship-of-the-line since the Romulan War. They quickly gained a reputation as one of the best combat starships of its day. In 2219 a task force consisting of four *Baton Rouge* class cruisers successfully engaged and routed a Tzenkethi battle fleet on its way into Federation space. All of the Tzenkethi vessels were either destroyed or damaged beyond repair, with the Federation fleet suffering only minor damage in return. They would again prove their effectiveness during the early days of the Four Years War (2246-2250), holding their own against the deadly Klingon D-6 battlecruiser in the few and often lopsided encounters between the two.

In 2208 the *Baton Rouge* class starships *Moscow* (NCC-1357) and *Tehran* (NCC-1308) participated in the first successful test of starship transporter technology. Subsequent ships in the class were built with them preinstalled and the technology back-fitted into all older ships in the class. All were also upgraded with Daystrom Duotronic Mark I computers as soon as these became available. During the Four Years War all but eight *Baton*

*Rouge* class cruisers had their original Pegasys VX-28 warp engines replaced with the more powerful Cochrane Dynamics PB-32 "Titiac." All received phaser upgrades, with some having two additional single phaser banks mounted to the rear of their secondary hulls (one to each side of the hangar bay) per the *Nordenskjold* configuration. These wartime refits were expensive given the age of the class and not continued once the war was over, leaving eight unmodified *Baton Rouge* cruisers in their original configuration. These were retired as soon as post-war build strength permitted, while the remaining upgraded vessels continued to serve Star Fleet well into the Class I era.

All remaining active duty *Baton Rouge* class cruisers were decommissioned in 2263, although several still remain in the Star Fleet Reserve. The *U.S.S. Moscow* (NCC-1357), one of the two that was part of the first successful starship transporter test, and one of the few that still retains its original Pegasys VX-28 warp engines, was donated to the Star Fleet Museum at Memory Alpha and restored for public display. The *U.S.S. San Diego* (NCC-1438) is preserved as a museum ship at the Star Fleet Division Orbital Shipyards at Luna by the Starfleet Association.

The *Baton Rouge's* success as Star Fleet's premiere starship of the day is without question. Even so, certain aspects of the design continued to vex Star Fleet. The oversized impulse deck and slab-like secondary hull were design concerns that had been "allowed" to happen. This was for the simple reason that Star Fleet needed the *Baton Rouge* immediately to replace its rapidly aging Romulan War era capital ships. Both of these had also necessitated the move of the warp engines to their "underslung" arrangement, something that Star Fleet designers knew full well was not the best configuration for an optimum starship warp field. That is why, when the next generation of Star Fleet vessels went to the drawing boards, they would go back to the Jeffries Prototype one last time before deciding the future of Star Fleet starship design.

**VISUAL:**



**SPECIFICATIONS:**

Length:	245 m
Beam:	153 m
Draft:	64.6 m
Displacement:	92,500 DWT
Crew:	344
Armament:	4 laser banks 2 photon torpedo tubes

Cruising speed:	warp 4.5
Maximum speed:	warp 5.2

Innovations:

- First large Star Fleet starship program in over two decades (31 vessels in 3 build groups)
- First Star Fleet starship class since the *Bonnie Chance* to have a "thin disc" primary hull
- First Star Fleet starship class with an all-trititanium hull and frame
- First Star Fleet starship class built using the modular component construction system
- First Star Fleet starship class with transporter technology and duotronic computer systems

**SCHEMATICS:**

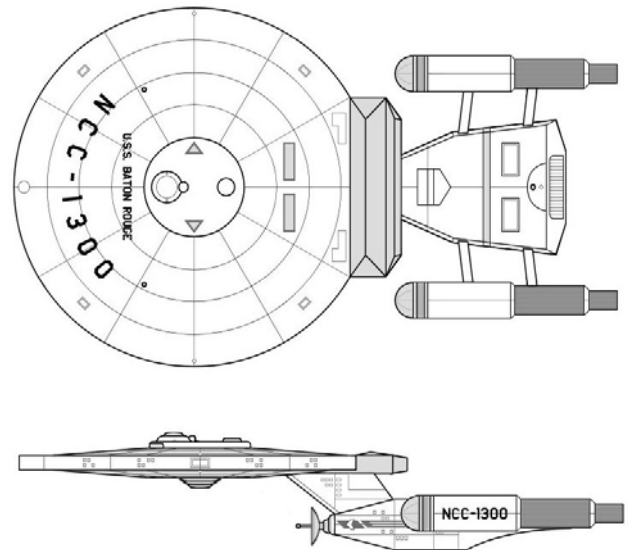

# RANGER CLASS SURVEY CRUISER

SERVICE ENTRY DATE (OLD CALENDAR): 2205

The *Ranger* class was a variation of the *Baton Rouge* concept intended to replace the *Mann* class in the survey cruiser role. For this purpose the secondary hull was moved up on top of the primary hull and the engines mounted underneath. This gave the *Ranger* the capability to change out its secondary hull as needed for special assignments, something that no other *Baton Rouge* era starship could do. This rarely happened because the science and survey facilities of a *Ranger* were usually more than adequate for the task. The idea would stick around, though, eventually leading to the development of the underslung container arrangement for the *Ptolemy* class transport/tug of the Class I Program.

The *Ranger* was one of only two *Baton Rouge* era starships classes that would be converted for the Class I Program. They saw service during the Four Years War and continued in the science and survey role for six more decades. For more information please consult *Federation Spaceflight Chronology Volume 10: The Class I Era*.

## SPECIFICATIONS:

Length:	235 m
Beam:	153 m
Draft:	66 m
Displacement:	92,500 DWT
Crew:	287
Armament:	4 laser banks 1 fusion torpedo tube
Cruising speed:	warp 4.5
Maximum speed:	warp 5.1

## SCHEMATICS:

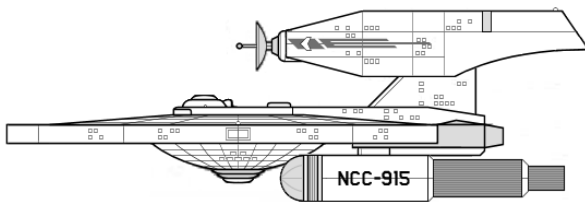

# HALE CLASS SCOUT

SERVICE ENTRY DATE (OLD CALENDAR): 2210

The limitations of the *Lowell* design saw this produced as a quick-to-build stopgap scout until the *Cook* class could be approved for construction. Its small size and stealthy construction stood in stark contrast to the bloated, *Mann*-derived *Lowell*. In fact, it was so small that it could carry only a single, limited-range shuttlecraft with minimal repair and maintenance facilities.

The main advantage that the *Hale* had over the *Lowell*, apart from its size, was its fusion torpedo tube. This was never intended to launch torpedoes; instead, it was used for the firing of the new "probe missile." Based on converted fusion torpedo technology, probes were designed for stand-off survey, thus lessening the risk to any starship investigating an unusual event or phenomena. The *Hale* class scout was the first to use them in service. Within a few years room would be made in the torpedo magazines of all Star Fleet vessels for an array of probes for a variety of mission profiles.

All 25 vessels in the *Hale* class were decommissioned *en masse* in 2231 as part of Star Fleet's changeover to the Class I Program. Most were sold off for use in local system defense fleets.

## SPECIFICATIONS:

Length:	120 m
Beam:	114 m
Draft:	34.5 m
Displacement:	9,000 DWT
Crew:	65
Armament:	1 laser bank 1 fusion torpedo tube
Cruising speed:	warp 4.0
Maximum speed:	warp 5.0

### Innovations:

- First Federation scout designed for the use of probes

## SCHEMATICS:

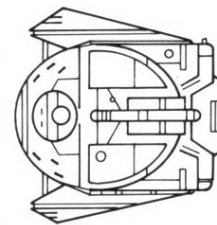



# ANTON CLASS CRUISER

**SERVICE ENTRY DATE (OLD CALENDAR): 2210**

The *Anton* represented an experiment in producing a “single hull” starship with all the performance and versatility of a Jeffries-derived design. This was accomplished by replacing the back half of a *Baton Rouge* saucer with a custom “modularized hull.” An *Anton* could be reconfigured for a special role simply by putting it into dock, pulling the aft hull plates, then removing and adding modularized deck sections as needed. Its oversized dual shuttle bays could handle either specialty science craft or two full squadron of fighter shuttles, plus spares to boot. This gave the *Anton* the most mission potential of any design in its era.

The complexities involved in fabricating the *Anton*'s special hull significantly delayed its entry into service. It was the largest of the *Baton Rouge* era starships, and the resources required to build it were considerable. In 2218 Star Fleet temporarily halted the program after the completion of only six ships due to a myriad of reasons, most particularly stress problems that had developed with its “splayed” angled warp engine pylons. In 2220 it ordered that the remaining twelve ships be built to a modified Class I design to resolve this and other related issues. This design would eventually evolve into the *Coventry* class frigate (and its counterpart, the *Miranda* class cruiser). All of the *Antons* that were already built were eventually returned to the yard and uprated to Class I specifications.

## SPECIFICATIONS:

Length:	185 m
Beam:	142 m
Draft:	48 m
Displacement:	146,500 DWT
Crew:	290
Armament:	4 laser banks 1 fusion torpedo tube

Cruising speed:	warp 4.4
Maximum speed:	warp 4.8

### Innovations:

- First of the “modularized hull” Star Fleet starships

## SCHEMATICS:

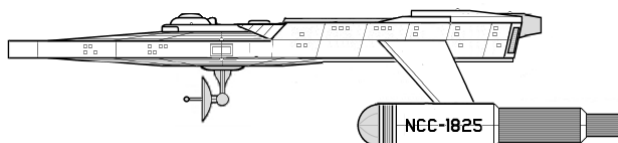

# BODE CLASS SCOUT

**SERVICE ENTRY DATE (OLD CALENDAR): 2213**

The *Bode* (considered by some as the “fourth” member of the “*Mann* generation”) was another attempt to overcome the design limitations of the



*Lowell* class scout, but this time on a reconfigured hull. The overall design was the same; however, the *Bode* eschewed the elliptical disc of the *Lowell* in favor of a more utilitarian approach. Crew complement was also reduced, thanks largely to the installation of duotronic systems, in order to make way for a torpedo launch system. This gave the *Bode* class the probe-launching ability that the older *Lowell* lacked. Unique to the design was a special protective system fitted to the front of the warp engines. This helped to shield the delicate instrumentation of the *Bode*'s sensor suite from the effects of its own warp field.

All five ships in the *Bode* class were called out of retirement to serve during the Four Years War (2246-2250). During the war (and largely due to heavy Star Fleet losses) they were updated with modern systems and warp engines. The last of the rebuilt *Bode* class was not retired until 2254, once Star Fleet had enough new-build scouts so that its services were no longer required. None survived the scrapper's torch.

## SPECIFICATIONS:

Length:	191 m
Beam:	78.7 m
Draft:	31.0 m
Displacement:	47,000 DWT
Crew:	73
Armament:	2 laser banks 1 fusion torpedo tube

Cruising speed:	warp 4.0
Maximum speed:	warp 4.9

## SCHEMATICS:

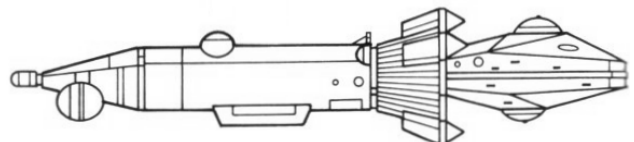

# ALIEN STARSHIPS

---

## KLINGON D-4 BATTLECRUISER

---

### *D'AMA* CLASS

**DATE FIRST OBSERVED BY FEDERATION: 2218**

The D-4 was one of the first Klingon starship designs ever encountered by the Federation and the first seen using the *D'rell* type hull. At that time it was known as the *Bon'chuune* class, so named after one of the first vessel of its type ever encountered. Only later did its true designation and class name become known, as well as its *D'rell* type hull lineage. The D-4 is also a classic example of the Klingon penchant for recycling starships via infrequent technology upgrades, as it is the oldest known warship design still in Klingon fleet service.

Surprisingly little is known about the *D'ama* class. It was apparently the first to fit a command boom on its *D'rell* hull, thus pioneering the classic "look" of Klingon starships for the next century. It was apparently withdrawn from service not long after its poor performance at the Battle of Verruca II in 2223. It would reappear again during the Four Years War, mostly in support or reconnaissance roles. As of this date (2295) at least 28 are still in service with the Empire, all upgraded with the "Klingon linear warp refit" and fielded by many of the lesser Houses.

Like all *D'rell* based designs the *Dama* is extremely warp-dynamic. Unfortunately it is the lightest armed of the type, no doubt due to its age. It also lacks sufficient hard points for the addition of more weapons. This might explain its removal as a front-line Klingon vessel so soon after the Empire's initial encounters with the Federation. Even after several refits it is still no match for a modern Federation starship larger than a frigate or older destroyer. Increased tensions with the Federation in the wake of the Genesis Incident probably accounts for the continued service of the elderly *D'ama*.

---

### VISUAL:



---

### SPECIFICATIONS:

Length:	205 m
Beam:	130 m
Draft:	45 m
Displacement:	84,600 DWT
Crew:	305
Armament:	2 standard disruptor banks

Cruising speed:	warp 4
Maximum speed:	warp 6

#### Innovations:

- First known use of the *D'rell* type secondary hull
- First Klingon starship class ever encountered by the Federation.

---

### SCHEMATICS:



# 2221-2250: The Class I Era

---



Magnificent, isn't it? The soundness of Franz Joseph's original design holds up well. You know, there was a time when people thought he designed these ships only for amusement – that they'd never have any practical application.

William van Anling  
Admiral, Star Fleet (ret.)  
(2147-2251)

No major starship program has had as great an impact on Star Fleet and the future of the Federation as has the Class I Program. Its origins were seven decades old with their roots in the Jeffries Project, a starship design far ahead of its time. It had been delayed decade after decade due to Federation Council politics and lack of direction within Star Fleet over the future of the fleet. It had taken a visionary, W. M. Jeffries, to conceive the program. It took another, the late Mark Chausser, to convince Star Fleet that the technology was ready and the time was right. It took a third, Franz Joseph IV, to take both of their visions and turn them into reality. When he did, he would forever change the very concept of the word *starship*. It would be as if the past 150 years of Terran and Federation spaceflight advances were but blips on the screen, necessary landmarks to hurriedly pass by on the way to the prize. The Class I Program that Joseph helped bring about did that. It changed everything about starships and the way they were conceived. It built upon the pioneering work of Chausser's *Baton Rouge* generation to set the standard by which all future Federation starships would be measured. From there it would spread out into the science, merchant, and civilian starship

sectors and even make a lasting impression on the Federation's future foes.

In a very real sense, we are still living in the Class I Era. Almost every aspect of modern Federation starship design, from component configuration to ship's interior layouts, from warp engine philosophies to starship procedures and protocols, can be directly traced back to the 2222 launch of the *U.S.S. Constitution*. The Class I Program did more than just define a new generation of starships. It also defined the future of Star Fleet, and with it the Federation. Had not the Class I fleet been available when it was, then the Four Years War with the Klingon Empire would have been a very different affair. It might have easily devolved into the desperate struggle that was the Romulan War, with countless casualties and atrocities. The Class I Program made sure that such a thing never happened. That alone was justification enough to silence even its harshest critics.



Modular component construction techniques that had been pioneered with the *Baton Rouge* generation of starships were taken to new heights with the Class I Program. As originally conceived there were only three basic component configurations: a twin nacelled (heavy) cruiser, a single nacelled destroyer/scout, and a twin-nacelled saucer fitted with a tractor grapple for use as a transport/tug. By

the end of the Four Years War there were a total of *fourteen* distinct Class I starship designs under construction, with multiple build classes authorized for almost all of them and more designs pending approval. This did not include the long-delayed dreadnought, which would not be built until just after the Four Years War, nor did it include the effort to convert five *Baton Rouge* era starship classes to Class I specifications. Proceeding in parallel was the Class II Program, a joint Star Fleet / Merchant Marine effort, with six distinct starship designs (each with multiple build groups) based on Class I components. The immediate effect was to produce the first modern Star Fleet in decades. There were important side effects as well. All of this construction effort resulted in boom years for starship yards across the Federation, with everyone involved contributing to the Class I program to some degree. Component modularization meant that work could proceed in parallel on the hulls of multiple starship classes, so long as the other main components (warp engines, secondary hulls, specialized attachments, etc.) were ready and delivered on time. The starship boom also brought about a parallel boom in the Federation economy, lifting its gross economic product to previously unseen heights. Times were good and jobs were available for all who desired them, thanks to Star Fleet's Class I and Class II Program.



There were, unfortunately, a number of beings that did not appreciate these good times. Instead, they saw an increasingly militaristic and totalitarian Federation government arming for war. They wanted freedom from bureaucracy and government regulations. They wanted things as they had been before the Federation Charter was enacted: a weak,

decentralized Federation banding together only in times of great interstellar crisis, with all its members and associated free to conduct their own intersystem affairs. Some of the more militant groups, such as the increasingly popular Terra Return League, advocated the dissolution of the Federation. Beyond these were others, who idolized the likes of Terra's notorious Colonel Green and were not above violence in achieving their aims.

In 2224, a group of Tellarite merchant ships were fired upon by Star Fleet forces under the command of Admiral Hathari of Andor while his fleet was ostensibly conducting war games exercises near the planet Th'allt. It was actually a deliberate act to cover up what became known as the Scandal of Archimedes. This sordid affair played right into the hands of Federation dissidents, who up until this point had been repressed by Council decree. Many of those who had imposed those decrees were deposed themselves in the wake of hearings and arrests that followed. This freed the Terra Return League and its allies of the restrictions that had all but silenced them during the terror-laden days at the end of the 22<sup>nd</sup> century. They were quick to resume their clarion calls for the dissolution of the Federation. The Scandal of Archimedes added weight to their words, much to the dismay of the new Federation Council. Eventually the clamor became so great that a special Babel Conference was called in 2230 to resolve the matter. A special guest of honor at this conference would be Captain Krenn, the new ambassador from the Klingon Empire. This was intended to show him how the Federation could peacefully resolve major problems without antagonism and violence. Unfortunately, the Babel Conference of 2230 would be one of the most strife-ridden in Federation history and leave Captain Krenn with much food for thought in his report back to his Klingon superiors.



Even before the conference convened it was struck by violence. Vice Admiral Andreas Mitskoval, Star Fleet chief of staff, was assassinated along with his adjutant and several of his entourage by a bomb planted in his airtram at Star Fleet Headquarters. He had just left his office and was on his way to Babel to



represent Star Fleet interests at the conference. This unprecedented act of terrorism, which was never solved, set the tone for the rest of the Babel Conference. Star Fleet Marines stood guard everywhere as conference security was tripled.

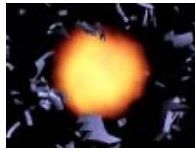

As for himself, Captain Krenn seemed to be enjoying the charges, counter-charges, accusations, threats, and such that flew back and forth in the conference chambers in the first few days. "It is as if we never left home," he was heard to say to one of his aides.

As might be expected, the loudest and most strident voices at the Babel Conference of 2230 were those of the Terra Return League and its allies. They called for a halt to Federation expansion and abolition of the "discredited" Federation Charter. The latter found considerable support among other Federation opposition groups, such as the Symmetrists, the Free Space League, and (to no one's surprise) the Orion trade cartels. At the other end of the spectrum were the Border Worlds Association and the League of Federation Affiliated Systems, who clamored for more Federation assistance and a continued Star Fleet presence in their systems. The Border Worlds delegates were especially upset by Captain Krenn's presence, calling him a spy and not a diplomat. Krenn is reported to have smiled and replied, "I am neither. I am a soldier in service to the Empire. I am not here to fight nor to spy. My current assignment is to sit here and watch you Federation fools destroy each other."

The Babel Conference of 2230 might very well have ended in the dissolution of the Federation were it not for the intervention of two humans. Commodore Douglas Shepherd was in command of the cruiser *Savannah* (NCC-1307). He had been originally detailed to escort Captain Krenn's unarmed D-5 cruiser *Serpant* to the Babel Conference. Due to the assassination of Admiral Mitskoval he was immediately promoted to rear admiral and named acting Star Fleet chief of staff. It was Admiral Shepherd who would speak for Star Fleet at the Babel



Conference, and that he did with surprising eloquence.

Star Fleet is not an unresponsive monolith, callously disregarding the needs and wishes of the Federation and its allies. We have always been there for them. Despite the desires of some we will always be there for as long as Star Fleet lasts. I need only to point out that the alternative to peace is war. That is a solution that none of us desire.

There are few beings in this room that were alive at the time of the Romulan War. Those of you who were remember those perilous times. My grandfather and my father often told me about them and how close the Federation came to falling. Were it not for the courage and dedication of the men and women, the humans and beings and other species that serve in Star Fleet and defend the Federation, we would not be here today. All of you know this, even if you do not share the living memories of the others in this room. The freedom you have to argue today was bought with the blood of Star Fleet. We demand nothing in return save the privilege of continuing to serve the Federation and its affiliated worlds. If there is no Federation, if you go through with this vote to dissolve it, then there will be no Star Fleet. That would be welcome news to some of you here today. I for one never want that day to come.

Gentlebeings, the Federation is not perfect. That is why we have conferences such as these, to *peacefully* resolve our disputes. Let me remind you, however, that without the Federation there is no Star Fleet, nor is there any alternative to Star Fleet. The Federation will fall, a house divided, and your worlds and systems will be left open to any foe with the might and will to conquer them. It is my duty to see to it that such a thing never happens. I ask you, delegates – please allow me to continue to perform that duty. Please do not dissolve the Federation. Without it, all of us will surely fall.

The silence that followed Admiral Shepherd's words was broken by another human clearing his throat. He asked permission to speak and it was granted. His name was Carter Winston, a wealthy Federation entrepreneur known for his benevolence and charity, a man who gave away fortunes as fast as he made them to help other beings less fortunate than he. It was Carter Winston who had the last word before the vote was taken on dissolution.





I feel a little out of place here. I am a businessman, not an ambassador. As a civilian I have no special standing among you other than an invited guest. So why have I asked to speak? Well, it's all this talk about limits, and tariffs, and sanctions, and restrictive regulations, and suffocating bureaucracy, and the need to "return to our roots" and such. To be honest, none of this sounds like the Federation that I know. I think, to borrow one of my grandfather's favorite expressions, we "can't see the forest for the trees." Perhaps it's time to step back, look around, and truly realize what is about to happen here.

I'm a human. My great-grandparents were born on Earth, and I'll be the first to admit to a fondness for the place. It isn't home to me, though, any more than my childhood home on Deneva. My home is the stars, and I won my success there with hard, hard work and very little of this so-called "Federation interference" I've been hearing about. The Sea of Stars is too wide and rich for any one political body to effectively control with such restrictive authority. I don't mean to demean any of you here, but I have great difficulty in believing the tales I've heard about a Federation dictatorship imposed over the space I've traveled. I've been to every major world in the Federation and I've seen no such thing.

You should not be talking about limits and restrictions. Instead, you should be talking about freedoms and opportunities, because they're out there. They're beckoning to anyone who will heed their call. It's always good to have some roots, and a place to go back to when you need it, but you shouldn't become so narrow-minded as to restrict yourself there. So, put down your roots where you will and make that place yours, but remember: the Federation is what we make of it. It is ours to fashion after our own image. Any complaints we have about the Federation are complaints about ourselves, and in ourselves the solution lies. If we give up this dream of a United Federation of Planets, we are giving up on ourselves as well.

As I see it, the future is neither bleak nor constrained. It is full of promise and mystery and is ours for the choosing. I know what my choice would be if I could vote today. I would vote for the future. I can but hope that you would do the same.

The motion to dissolve the Federation failed by a single vote. The rest of the Conference passed rather uneventfully, with the delegates drafting resolutions to deal with various minor concerns. The

Terra Return League and several other dissident parties soon dissolved, never to be heard from again. The Federation's greatest peacetime crisis had passed. Once again it could look towards the future.



The Babel Conference of 2230 was not the end of the Federation's troubles. Captain Krenn had learned much from his visit and shared his information in many reports back to his Klingon superiors. The Klingon Empire itself had just emerged from a bloody civil war, with a newly installed, strong central government under the iron fist of Chancellor Kar'harmmer. He despised everything about the Federation and for what it stood because it was so unlike the Klingon way. He also resented "constant Federation encroachment" on their shared border, although in truth it was the local Klingon commanders who were doing most of the "encroaching." Almost as soon as he entered office Chancellor Kar'harmmer resolved to destroy the Federation once and for all. To that end he began preparing the Klingon Empire for an all-out war with the United Federation of Planets – winner take all.

The Four Years War was destined to become the only major interstellar war ever fought between the Klingons and the Federation. Klingon numbers and tenacity were thrown by the bucketful at Federation technological might ... and essentially washed off. Large portions of border space were lost to the Klingons in the first year of the war; however, there were no Klingon deep-penetration offensives (as had been hoped) like there had been during the Romulan War a century before. This time, Star Fleet knew that the Klingons were coming and had almost two decades to prepare for such an event. The most

telling factor in the Federation's favor, though, was the presence of the new Class I fleet. Klingon starships were among the best and most maneuverable fighting vessels of their day, yet the Class I fleet held its own in every major battle. Even when the odds were against them, as they often were during the early months of the war, only a surprisingly small number of Class I starships fell victim to Klingon attacks. The presence of Class I starships on the war front helped prevent the collapse of Star Fleet defensive lines during the initial Klingon campaigns and later (with new phaser technology) help turn the tide in Star Fleet's favor. Class I starships drove the Klingons back to the border and were poised for their own offensive when the Klingons sued for peace. It was a victory they would neither forgive nor forget, and it all came about as a result of "those damned Federation devil-ships."

Star Fleet's Class I Program had proven its worth in war as ably as it had done in peace. It would continue to prove its worth on both fronts in the decades to come.



Class F shuttlecraft (2222)



Typical shipyard resupply operations (c.2240)



*Enterprise* (NCC-1701) escorts an old DY-X converted for transport duty during the Four Years War (2250)



Klingon forces retreat from Federation space following the end of the Four Years War (2250)

# STARSHIPS

## ***CONSTITUTION* CLASS HEAVY CRUISER**

**SERVICE ENTRY DATE (OLD CALENDAR): 2222**



The most famous of all Class I starships, largely due to the exploits of the *Enterprise* (NCC-1701), the *Constitution* class starships were the original backbone of the Class I fleet. They were designed to be true multi-mission ships, excelling in both the military and exploration roles. For the first quarter-century of their service lives they were the great explorers, surveying and charting much of what remained of unexplored space within Federation borders (and sometimes without). The Four Years War with the Klingon Empire called upon them in the military role, in which they distinguished themselves in every battle they fought. Upgrades to phaser weaponry in 2247 made them the most powerful capital ships of their time. The valuable *Constitution* class was removed from the war front, though, once more dedicated combat Class I starships became available, and returned to assignments more worthy of their multi-mission construction. They would continue operating in this manner for the rest of their service lives.

The *Constitution* class was not the first starship class to serve Star Fleet beyond a standard service lifespan of 30 Terran years. It was, however, the first in which the concept of an extended service life far beyond the norm was applied on a class basis (as opposed to selected ships). This was made possible by its all-tritanium hull and frame, which had already extended the service lives of the older *Horizon*, *Archon*, and *Baton Rouge* era starship classes. The base frame of a Class I heavy cruiser had a theoretical service lifespan of a century (100 Terran years) given proper maintenance and no exposure to extreme stresses. As a whole, though, the Starship Design Bureau rated the lifespan for a *Constitution* class heavy cruiser at three-quarters of a century (75 Terran years). This allowed for both irregular hull and frame stressing during extreme missions and periodic overhauls of both major and minor ship's components and onboard systems. An approximate 25-year cycle was established for major overhauls and changeouts of all critical starship components. These would usually last 1-2 years (the

linear warp refits of the late 2260s and early 2270s lasting 2½ years). In the meantime, minor overhauls (6-9 months) would occur after every five-year mission while ship's stores were being replenished and its personnel rotated. A Class I heavy cruiser could thus serve Star Fleet in this manner for 75-80 years before being placed in ready reserve for another 20-30 years before final decommissioning. This meant Star Fleet could always count on having a fleet of spaceworthy starships at its disposal – a luxury that it had never enjoyed before. The *Constitution* class heavy cruisers were the first to demonstrate the wisdom of such planning. Extended service life program (ESLP) refits, such as those pioneered with the *Constitution* class, are now a standard part of Star Fleet support operations.

It had been the original intent of Star Fleet to refit all *Constitution* class starships with PB-31 warp engines starting around 2245. This would have taken place during their first regularly scheduled ESLP refit. The outbreak of the Four Years War in 2246 changed all that. Starships that had already been docked for their ESLP refits were hurriedly put back together and sent to the war front with their original PB-18 warp engines. Because of this, *Constitution* (NCC-1700) and *Enterprise* (NCC-1701) were the only two Class I heavy cruisers that received PB-31 warp engines prior to the war, since their refits were already well underway when the war broke out. The others would have to wait for upgraded engines until after the war, by which time the new PB-32 had passed Star Fleet acceptance tests. The remainder of the *Constitution* class received PB-32 warp engines during post-war ESLP refits. *Constitution* and *Enterprise* had to wait until 2260 for theirs.

Two additional build groups of the *Constitution* class were authorized as part of Star Fleet's expansion during and after the Four Years War. These are often referred to as the *Bonhomme Richard* and *Achernar* sub-classes due to slight variances in design. *Bonhomme Richard* was the first with PB-32 warp engines "out of the yard," while *Achernar* was the first to be fitted with PB-47s and an early version of Star Fleet's modern dual-purpose deflector grid system.

There is only one "original" *Constitution* class heavy cruiser still in Star Fleet. The *Potemkin* (NCC-1657) was converted to a training ship shortly after the Four Years War. It became the main Class I training starship after the decommissioning (and subsequent scrapping) of the aged Class I prototype *Republic* (NCC-1371) in 2257. It never received a linear warp refit due to its training vessel status. The *Potemkin* was decommissioned earlier this year and placed in the Star Fleet Reserve. Plans are already underway to convert it to a museum ship at Memory Alpha within the next few years. Its retirement marks the end of one of the most pivotal eras in Star Fleet starship history.

---

## SPECIFICATIONS:

Length: 290 m  
Beam: 127 m  
Draft: 73 m  
Displacement: 190,000 DWT  
Crew: 430  
Range: 18 light-years at L.Y.V.  
Armament: 6 phaser banks  
2 photon torpedo tubes

Cruising speed: warp 6  
Maximum speed: warp 8

### Innovations:

- First starship class in Star Fleet's new Class I program.
- First Star Fleet starship class with a projected 75+ year service lifespan.

---

## SCHEMATICS:

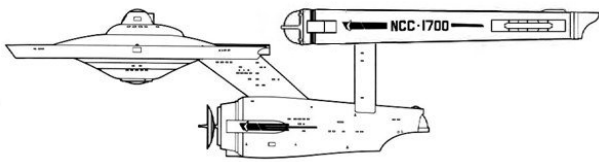

*Constitution* as built (c.2220s)  
sporting her original PB-18C warp engines

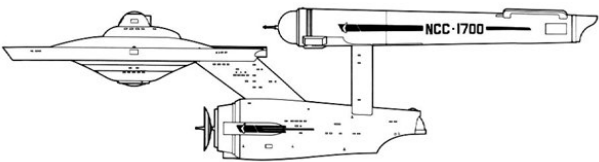

*Constitution* after first ESLP refit (c.2240s-2250s)  
sporting PB-31 warp engines

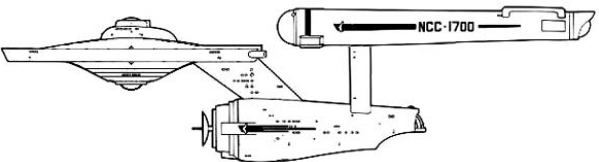

*Constitution* after *Bonhomme Richard* upgrade (c.2260)  
sporting PB-32 warp engines and a retooled primary hull

---

---

## VISUALS:



*U.S.S. Potemkin* (NCC-1657) at the height of her career

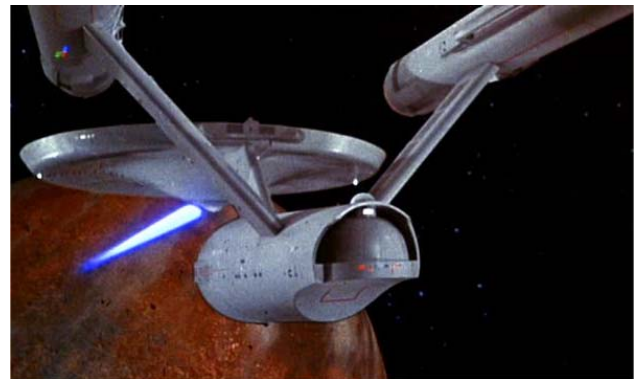

A rare shot of a *Constitution* class starship  
firing on a planetary ground-based target



Front-on view of an original *Constitution* class starship. This appears to be the post-war *Constitution* or *Enterprise* based on the visual evidence. Note the enlarged deflector dish and canted intercoolers indicative of a PB-31/32 series warp engine. Only *Constitution* and *Enterprise* retained oversized deflector dishes after their first ESLP refits.



# ***SALADIN* CLASS DESTROYER & *HERMES* CLASS SCOUT**

**SERVICE ENTRY DATE (OLD CALENDAR): 2224**



These were the Class I descendants of the single-nacelled *Drake* class destroyer and *Cook* class scout of the *Baton Rouge* era. Like their predecessors, the *Saladin* and *Hermes* had more specialized mission profiles and interior design due to their lack of a secondary hull. The *Saladin* was intended to be an inexpensive fleet combatant and picket ship, patrolling Federation borders and responding to situations where the presence of a cruiser-class vessel was not required. The *Hermes*, based on the same hull, played the role of fleet scout and was fitted with the most sophisticated sensor, surveillance, and ELINT/ECM/ECCM packages of its day.

The single-nacelled design, though, was not without its problems. Even as early as its *Baton Rouge* ancestors there had been intermittent problems with warp field instabilities above Warp 5. Early *Saladin* and *Hermes* class starships were plagued by total warp field collapse any time they attempted to exceed Warp 6, usually resulting in the dreaded “wormhole effect.” Unfortunately, there was a whole lot of nothing that could be done due to the lack of a counterbalancing engine in the ship’s design. Subsequent duotronic computer upgrades helped alleviate but not completely solve these instability problems. The end result was a one-in-four chance of creating a wormhole whenever the Warp 6 threshold was exceeded. This issue would not be completely resolved until Star Fleet’s linear warp technology program came on line in the 2260s. Be that as it may, though, it was this inherent instability that also made the single-nacelled Class I starship such an excellent combatant. In both simulation and practice a *Saladin* could always outmaneuver the legendary Klingon D-6 battlecruiser, which was in itself a considerable accomplishment – provided, of course, its warp field didn’t collapse into a wormhole first. *Saladin* commanders soon found ways to use this tendency to wormhole at high warp speed to their advantage on several occasions during combat with Klingon forces during the Four Years War. Eventually, though a design was found that could give *Saladin* combat performance without the *Saladin*’s notorious warp field issues. That design would be the *Larson* class destroyer.

It is often difficult to tell the difference between a *Saladin* and *Hermes* hull. Most of the *Hermes* class and its spin-offs received extensive phaser upgrades after the Four Years War, giving them a phaser capacity equivalent to a *Saladin*. The key difference, though, is that a *Hermes* lacks photon torpedo tubes. This is true even of the linear warp refit version. Space that would have been occupied by photon launching assemblies is instead taken up by its extensive electronics and sensor suite.

The *Saladin* and *Hermes* class starships have reached the end of their projected service lives. They are currently scheduled to be decommissioned and scrapped beginning this year (2295), their fleet roles now performed by newer and more able designs.

---

## **SPECIFICATIONS:**

Length:	242 m
Beam:	127 m
Draft:	60 m
Displacement:	95,000 DWT
Crew:	200
Range:	9 light-years at L.Y.V.
Armament:	6 phaser banks 2 photon torpedo tubes ( <i>Saladin</i> only)

Cruising speed:	warp 6
Maximum speed:	warp 8

### Innovations:

- First single-nacelled Class I starship design

---

## **SCHEMATIC:**

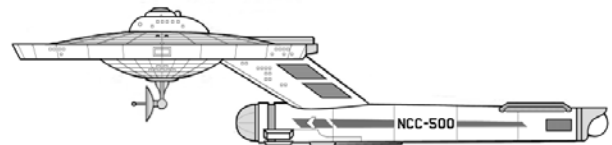



# PTOLEMY CLASS TRANSPORT/TUG AND CONTAINER SYSTEM

SERVICE ENTRY DATE (OLD CALENDAR): 2224

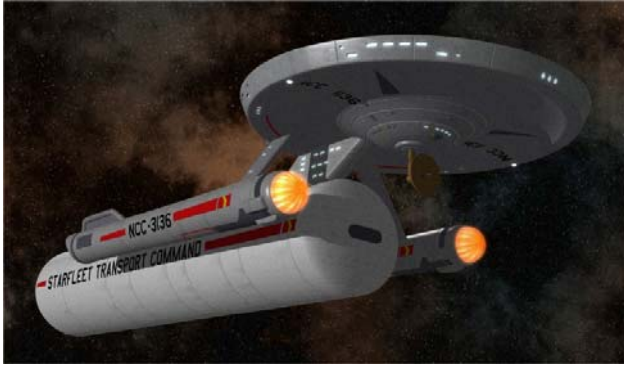

The idea of a fleet transport combined with a standardized modular cargo system was not new. Star Fleet had been using such transports ever since the founding of the Federation, with the *Watt* being the best known and most popular. Be that as it may, the *Watt* was by now too old and too slow to adequately support the new Class I fleet. Starfleet found its answer in the *Ptolemy* class transport/tug, itself based on Class I components.

Star Fleet had already been looking for a suitable replacement for its aging *Watt* class transport/tugs for some time. The *Swiftsure* proposal at the turn of the century had come the closest to acceptance but ultimately died due to lack of funds. The abrupt termination of the *Baton Rouge* generation in favor of the Class I Program also resulted in the cancellation of yet another proposed transport/tug design (*Liberty*). This meant that the first wave of Class I starships had to include a new transport/tug class by default, since Star Fleet could no longer put off the issue. The Starship Design Bureau's solution was both simple and elegant. It was in essence a light cruiser with a tractor tow pad (instead of a "stub" secondary hull) for towing standardized cargo containers. The amount it could tow would be limited only by the capabilities of its dual PB-18 warp engines.

With the new transports also came a new container system, significantly larger and with greater volume than that used with the old *Watt* class transport. Initially there were only five different Class I cargo containers: bulk products, liquids, dry goods, refrigerated goods, and personnel. The personnel container was also self-powered (via modern impulse engines) and was designed to operate on its own as a sublight starliner. Over time, a number of additional types of cargo container were added: colony transport, spare parts shipment, mobile repair facility, and so on. Three specialized containers developed in support of fleet combat operations were the battle pod (giving a tug dreadnought firepower), the carrier pod (turning a tug into a fully functional shuttlecarrier), and the troop transport pod (in support of planetary ground operations). Even more would be added in the decades that followed.

It became all too obvious during the Four Years War that not enough *Ptolemy* class starships had been ordered to meet Star Fleet's wartime transport needs. The *Ptolemy* class was pushed well beyond its designed operational limits as a result. The operational stresses they endured during this time seemingly made the *Ptolemy* class prime candidates for the scrapheap. Once the *Ptolemy* class was given closer examination, though, it was found that their hulls had not degraded as much as had been thought. Many would receive linear warp refits in the 2270s. The remaining non-upgraded *Ptolemy* class starships are being retired to the Star Fleet Reserve as they reach the end of their normal service lives, having ably fulfilled the role for which they were designed to serve.

## SPECIFICATIONS:

Length:	222 m
Beam:	127.1 m
Draft:	66 m
Displacement:	126,500 DWT
Crew:	210
Range:	9 light-years at L.Y.V.
Armament:	4 phaser banks

Cruising speed:	warp 6
Maximum speed:	warp 8

### Innovations:

- First Class I transport/tug design to enter service
- First starship designed for use with the new Class I transport container system.

## SCHEMATIC:

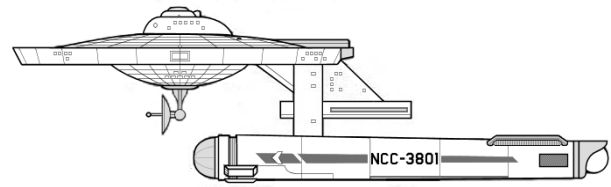

## ***INDEPENDENCE* CLASS TRANSPORT**

**SERVICE ENTRY DATE (OLD CALENDAR): 2229**



These were Star Fleet's first major transport vessels in the Class I era. They were officially designated as Class II starships due to their auxiliary support role. 100 were originally approved, and by 2240 there were 514 in service constructed in six build groups. That was the same year that the Federation Council cancelled the remaining 86 ships in the *Fraternity* class (the sixth build group) due to lack of apparent need. Within six years they would regret their decision due to the outbreak of the Four Years War and more were quickly ordered. They began construction too late to help the existing fleet, however, and what transports were not destroyed were worked well beyond their official limits for stress, cargo, and endurance.

The seventh build group, the *Huron* class, entered service after the War. It has a modified configuration and is sometimes considered a class in its own right due to its size and noticeable design changes. The eighth and final group, the *Condor* class, is currently awaiting approval by the Federation Council. It represents a linear warp retooling of the *Independence* class. These will be all new builds, provided funding is granted for construction.

### **SPECIFICATIONS:**

Length:	117 m
Beam:	69 m
Draft:	60 m
Displacement:	85,000 DWT full load
Crew:	42
Range:	20 light-years at L.Y.V.
Armament:	2 phaser banks

Cruising speed:	warp
Maximum speed:	warp 7

#### Innovations:

- First starship design in Star Fleet's new Class II program.

## ***SHERMAN* CLASS CARGO DRONE**

**SERVICE ENTRY DATE (OLD CALENDAR): 2235**

The *Sherman* class has often been described as a "smaller, meaner" version of the *Independence* class. These were designed from the start to operate entirely on automation in relatively safe sectors of Federation space. Interior spaces are functional at best, although rudimentary accommodations were provided in the event manual operations were required. These were intended primarily for colony and starbase supply but were pressed to fill the transport gap during the Four Years War. Five build groups were originally authorized and two older yet similar classes were updated to *Sherman* specifications. Many were also sold to private industry or the Federation Merchant Marine. The *Sherman* class drones still remain a familiar sight on the spaceways, even though advances in bulk transporter technology (via subspace-transmitted mass patterns) have all but rendered them obsolete.

### **SPECIFICATIONS:**

Length:	113 m
Beam:	52 m
Draft:	55 m
Displacement:	78,000 DWT
Crew:	27 (normally automated)
Armament:	none (normally)
Range:	20 light-years at L.Y.V.
Cruising speed:	warp 6
Maximum speed:	warp 8

### **VISUAL:**



# LARSON CLASS DESTROYER

**SERVICE ENTRY DATE (OLD CALENDAR): 2240**

The problems of the single-nacelle Class I starship vexed Star Fleet's Starship Design Bureau for years. Such a vessel was necessary for fleet operations, yet the inherent warp instabilities of the design would by nature limit those very operations. That was something Star Fleet could not afford, so the Starship Design Bureau devoted considerable time to solving this problem. Their first solution remains among the most unique, mounting the warp engine on dual oversized canted "wings," for lack of a better word. These eliminated the crossflows that created warp field instabilities in a single-nacelle starship. This increased both the size and mass of the *Larson*, however, it was a small price to pay for zero chance of a wormhole above Warp 6. The slanted boom design proved such a success that the *Larson* quickly replaced the *Saladin* on Star Fleet's production schedule. It would eventually serve as the basis for a number of sub-classes (such as the *Shackleton* class survey cruisers) and derivative designs (including the dual-engine *Derf* class tender). 89 *Larson* class destroyers in six major build groups have been authorized since the class entered service in 2240. Practically all of the survivors (from war, attrition, mission losses, etc.) continue in Star Fleet service today.

The secondary hull of the *Larson* is not designed in the same manner as *Anton* derived designs. There are no dual shuttle bays, since this space is taken up by an extended impulse deck. Instead, as many non-essential subsystems as possible have been removed from the primary hull and placed in here, as well as in the canted booms. This extra space in the *Larson's* primary hull is used for extra phaser capacitors and photon torpedo magazines – a feature v in its 2270s era linear warp refit.

## SPECIFICATIONS:

Length:	271 m
Beam:	132 m
Draft:	84 m
Displacement:	115,000 DWT
Crew:	230
Range:	20 light-years at L.Y.V.
Armament:	6 phaser banks 2 photon torpedo tubes

Cruising speed:	warp 6
Maximum speed:	warp 8

### Innovations:

- First Class I starship with canted engine pylons
- Most successful of the Class I single-nacelle designs
- One of the few Star Fleet starship class named after a military hero (Admiral William Larson, hero of the Triangle Campaign during the Romulan War)

## VISUALS:



## SCHEMATIC:

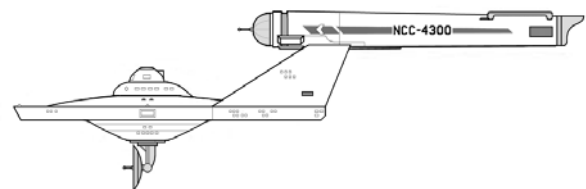

## NELSON CLASS SCOUT

SERVICE ENTRY DATE (OLD CALENDAR): 2240



The *Nelson* represented an alternate take to the *Larson* in solving the warp instabilities inherent with a single-nacelle design. In this case the underslung engine arrangement was retained but the single support pylon was replaced by two small canted ones. This doubled the effective radiator area of the warp engine. It was admittedly not as an effective solution as that which had been used with the *Larson*, however, it was obviously more cost-effective. The *Nelson* class were also the first Class I scouts to be fitted with photon torpedo tubes, making them the operational equivalent of their destroyer brethren insofar as fleet operations were concerned. Most of the time, though, they carried an extensive and varied assortment of probes and only a small number of torpedoes sufficient for defensive purposes.

The *Nelson* soon replaced the *Hermes* as the standard Class I scout design in production. Despite their being newer vessels, all were placed in the Star Fleet Reserve in the late 2260s while the older *Hermes* class received a linear warp refit. They were reactivated and upgraded in the 2280s as the *Hermes* class (like many other original Class I starships) were retired in favor of newer starships. Upgraded vessels of the *Nelson* class have replaced all retired *Hermes* class starships as of the date this work was published (2295). Many still remain in reserve in their original Class I configuration, though, ready to be returned to service should the need arise.

### SPECIFICATIONS:

Length:	265 m
Beam:	127 m
Draft:	61 m
Displacement:	105,000 DWT
Crew:	200
Range:	9 light-years at L.Y.V.
Armament:	6 phaser (3 banks of 2) 2 photon torpedo tubes
Cruising speed:	warp 6
Maximum speed:	warp 8

## COCHRANE INDUSTRIES

### MARK IV ONE-MAN SCOUT

SERVICE ENTRY DATE (OLD CALENDAR): 2240

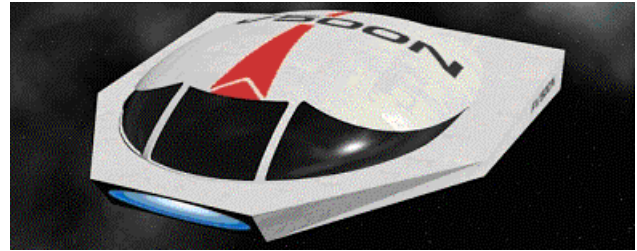

Cochrane Industries was set up as a spin-off company of Cochrane Warp Dynamics when it returned to the small craft market in 2179. The Cochrane Mark IV Scout was the most popular personal starship of the Class I era and was a favorite of both civilians and traders alike. Its dual Kloratis KT-12 warp engines could push it up to Warp 6, allowing its owner to travel practically anywhere in the Federation within a few days. They could be found everywhere in every port and star system both major and minor, engaged on almost every kind of business, both legal and not. The Mark IV officially ceased production in 2260; however, its sheer numbers ensure that it will remain a familiar sight in Federation space for decades to come.

### SPECIFICATIONS:

Length:	10.4 m
Beam:	9.2 m
Draft:	3.1 m
Displacement:	42 DWT
Crew:	1 (+ up to 3 passengers)
Range:	2 light-years at L.Y.V.
Armament:	none (usually)
Cruising speed:	warp 4
Maximum speed:	warp 6

### SCHEMATIC:

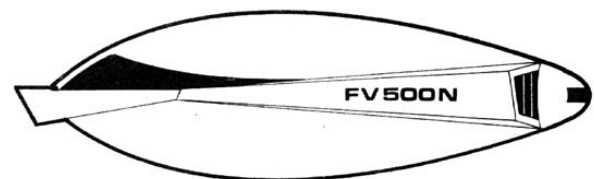



# LOKNAR CLASS FRIGATE

**SERVICE ENTRY DATE (OLD CALENDAR): 2242**

The *Loknar* is unique among Class I frigates. It owes its unusual appearance to the aborted NX-project advocated by the Andorians back in the 2140s. At that time the technology was simply unable to meet the proposed design specs without major compromises. Once trititanium and improved construction techniques became available then the Andorians got their wish. They were allowed to proceed with a design modified to Class I specifications, with the understanding that they would have to shoulder most of the construction costs themselves.

The design of the *Loknar* is reflective of the Andorian philosophy of "big guns and little comfort." It was the first to mount six lasers in banks of two: one bank in front of the lower primary hull and two equally spaced on the topside. This feature would eventually be adapted for the dual phaser mounts of Class I starships during and after the Four Years War. Its "splayed" dual warp engine configuration also made for an extremely maneuverable vessel despite its size. Its interior accommodations, though, were spartan compared to those of other Class I starships. Its shuttle bay was small and limited in comparison as well.

The *Loknar* quickly became a favorite of combat-eager starship captains during the Four Years War. It won more encounters with Klingon starships than it lost, tallying up the most impressive combat record of any starship class during the war. Cries from the Federation Council to decommission these ships after the end of the war were countered by assigning them to volatile Federation borders. It is there that they still serve, with linear warp technology upgrades to keep them current with the rest of today's Class I fleet.

## SPECIFICATIONS:

Length:	288 m
Beam:	127 m
Draft:	86 m
Displacement:	140,000 DWT
Crew:	177
Range:	10 light-years at L.Y.V.
Armament:	6 phaser banks 2 photon torpedo tubes
Cruising speed:	warp 6
Maximum speed:	warp 8

### Innovations:

- The only Class I starship designed and built entirely by the Andorians

## VISUALS:



## SCHEMATIC:

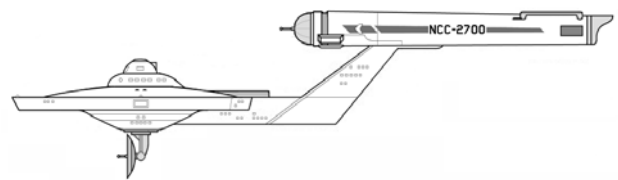

Original configuration (2241)

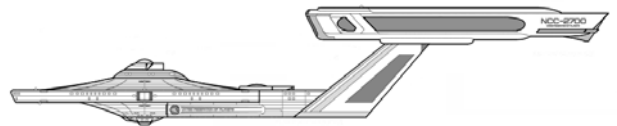

Current configuration (2295)



# KEARSARGE CLASS LIGHT CRUISER

SERVICE ENTRY DATE (OLD CALENDAR): 2245



As the threat of war with the Klingon Empire loomed ever closer Star Fleet decided it was high time for what might appropriately be called a “war cruiser.” This would be an inexpensive starship with all the firepower of a standard heavy cruiser. Of all the designs that were submitted to the Starship Design Bureau in the late 2230s for this project the *Hamilton* proposal looked the most promising. The only remaining issue was how to reduce its projected cost without reducing its firepower. Enter Chiokis Starship Design, the moving force behind the Class I Program. Its first suggestion was to lose the standard Class I upper primary hull assembly in favor of the simpler one from the *Baton Rouge* era. Since this was going to be a purely military vessel then it didn’t need extensive science labs and such. Second, Star Fleet should use S-variant warp engines (the “shorty,” as Support Services called them) in place of normal Class I starship engines. Normally used for transports and auxiliaries, these would severely limit the range and duration of the new class, given Star Fleet expectations for normal and combat operations. Chiokis engineers pointed out that range wasn’t necessarily an issue, since this new class would spend the bulk of its time on the borders as opposed to extended-duration exploration missions. They would be rapid-response vessels, quickly sallying forth from deep space stations or border outposts to deal with any threat knocking on its door. Star Fleet conceded on both points and the Federation Council was quick to agree, given the projected low cost of the new design. Final approval was given in 2243, with construction commencing almost immediately.

It is easy for starship historians to argue that the *Kearsarge* should have never been produced given its inferior engines. The *Surya* and *Loknar* class frigates were superior in every aspect, being able to go places and do things the underpowered *Kearsarge* could not. This would have remained true had not the Four Years War come along. As Star Fleet starship losses began to mount it boiled down to simple manner of numbers. *Suryas* and *Loknars* were expensive to build; *Kearsarges* were not. Five

*Kearsarge* class NCLs could be built for the same amount of credits it took to build three Class I frigates. That is why *Kearsarge* production boomed and frigate production dwindled during the Four Years War. The *Kearsarge* had found the mission for which it had been designed: short range, low cost, starship-class fleet combatant.

A common Four Years War modification replaced the dual photon torpedo tubes with a quad array. This resulted in Star Fleet’s second “heavy firepower forward” Class I design (*Marklin* being the first). There were also many other modifications tried with the *Kearsarge* class –far too many to list here – to augment both combat and support roles. Their limited mission profiles kept them on the borders as patrol ships following the end of the Four Years War. They would have one last bout of glory during the Kzinti Incursion of 2272, after which the *Kearsarge* class was retired en masse to the Star Fleet Reserve. They are at present scheduled to be scrapped at the turn of the century.

## SPECIFICATIONS:

Length:	211.8 m
Beam:	122.0 m
Draft:	47.2 m
Displacement:	112,500 DWT
Crew:	272
Range:	3 light-years at L.Y.V.
Armament:	6 phaser banks 2 photon torpedo tubes
Cruising speed:	warp 5
Maximum speed:	warp 8

## SCHEMATIC:

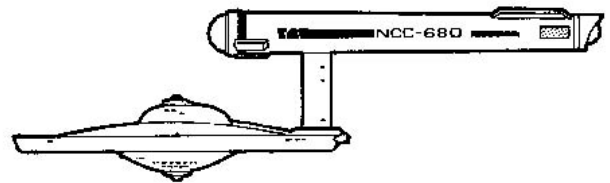

Original *Hamilton* proposal

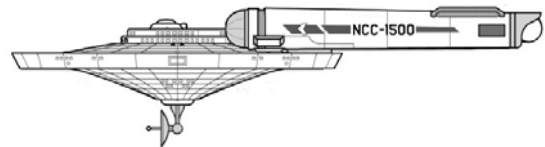

*Kearsarge* class as built

# MIRANDA CLASS CRUISER

SERVICE ENTRY DATE (OLD CALENDAR): 2248



Project Avenger was a design study undertaken by the Starship Design Bureau in the late 2230s. Its goal was to produce an improved *Anton* class cruiser. Alone of all of Star Fleet's starship classes, the aged *Anton* class had proven equally adept in both the cruiser and shuttlecarrier roles. Their origins in the *Baton Rouge* era, though, combined with several obvious design flaws meant that there would be limits as to how and in what manner they could be upgraded. A purpose-built Class I starship based on the *Anton*, as opposed to upgrading the *Antons* themselves, would prove more useful in future Star Fleet operations to come..

Two major changes were made to the *Anton* design before it became the *Miranda* class cruiser. The first major change was the replacement of its splayed warp engine pylons with straight mounted ones. The splayed pylons, which were mounted along the aft edge of its modularized hull, had proven more prone to stress problems than those of any other starship in Star Fleet. This change alone resulted in a more stable design. The second major change was to install a series of four "hard points" to the rear of its unique modular primary hull. These were two to a side, with one running along the edge of the hull, in the old location for the warp engine pylons, and another directly above the new straight pylons. The reason for this was simple. Anything mounted on these hard points could tap directly into the warp engines for power, thus eliminating a lot of power routing (and system vulnerability due to extended conduits). The *Miranda* "roll bar" option mount made its debut at this time, designed to straddle the top two hard points. In its most common form it sported extra photon torpedo tubes in addition to special long-range sensors. Another common version was an electronic warfare version, with a special ELINT sensor array replacing the photon torpedo package and dual ECM/ECCM pods.

The *Miranda*'s side "hard points" were rarely used in this era; however, starbase-rated phasers would be tested on these mounts after the war during the development of the megaphaser cannon.

All but two *Mirandas* were uprated to linear warp technology in the 2280s.

## SPECIFICATIONS:

Length:	236 m
Beam:	136 m
Draft:	63 m
Displacement:	162,000 DWT
Crew:	227
Range:	18 light-years at L.Y.V.
Armament:	6 phaser banks 2 photon torpedo tubes optional "roll bar" mounted weaponry

Cruising speed: warp 6

Maximum speed: warp 8

Innovations

- Four hull hard points for optional weapons and other accessories (side mounts usually plated over)
- Custom "roll bar" for extra systems and/or weapons

## SCHEMATIC:

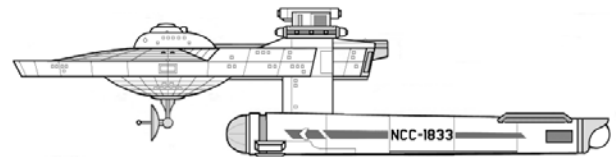

Original *Miranda* design with standard "roll bar" (c.2250)

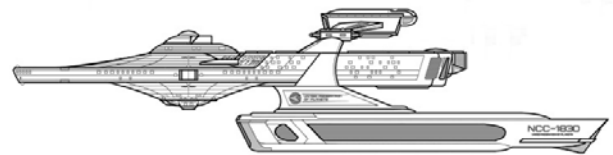

Linear warp *Miranda* conversion with new "roll bar" (c.2280)

# ALIEN STARSHIPS

## KLINGON D-6 BATTLECRUISER

### ***RAXOR* CLASS**

**DATE FIRST OBSERVED BY FEDERATION: 2241**

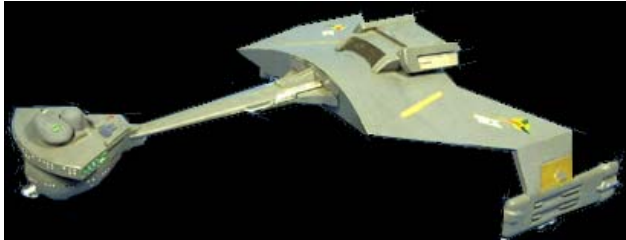

The *Raxor* class battlecruiser provided the first ugly surprise the Klingons had for Federation forces at the onset of the Four Years War. Star Fleet captains expecting to tangle with a *D'ama* or *Dupat* often found themselves with a serious fight on their hands when engaging a *Raxor* for the first time. It was fast, well armed, and extremely warp dynamic – more so than Star Fleet vessels of the day. In standard “wolf packs” of three it was well nigh unbeatable. Single ship-to-ship combat by skilled commanders, though, revealed another story. The *Raxor* was designed purely for offense. It lacked adequate shielding to its sides and rear, and its weapon arcs were incomplete with regards to its aft section. This meant that any Federation starship that could get behind a D-6 could probably destroy it. This was a difficult proposition, given the high warp dynamics of the *Raxor* class, but not impossible – as many Star Fleet starship commanders would eventually learn. The D-6 would remain the backbone of the Klingon fleet until the 2250s, when the successor D-7 began to be produced in quantity.

It is believed some 60-100 *Raxor* class battlecruisers were built starting around 2230 and ending in 2250. Many of these would later be sold to the Romulans under the terms of the Treaty of S'marba. At least 20, possibly more, still remain in Klingon service with the lesser Houses as of this date. Very few remain in their original configuration, with most being converted to the carrier or fire support role. A few have been converted to prison ships, crewed by inmates from Klingon penal colonies who are allowed to work off their sentences by serving for the glory of the Empire. Some D-6s have had the 2260s era limited shielding refit, but most still retain their original smooth hull configuration.

It is often difficult for new Star Fleet officers to distinguish the difference between a D-6 and D-7. The most obvious physical difference is at the front of the command boom. The D-6 has an extended shroud around its sensor array, giving the appearance of a torpedo or missile launcher. A real D-7 has no such shroud. Experienced starship spotters will also note the telltale absence

of the energy signatures for the D-7's additional disruptor mounts during a standard sensor sweep.

### **SPECIFICATIONS:**

Length:	205.2 m
Beam:	152.4 m
Draft:	55.3 m
Mass:	102,500 DWT
Crew:	410
Armament:	7 standard disruptor banks 2 heavy disruptor banks

Cruising speed:	warp 6
Maximum speed:	warp 7

#### Innovations:

- Most recognizable Klingon battlecruiser design
- Immediate precursor to *Klalode* (D-7) and *K't'inga* (D-8) battlecruiser designs

### **SCHEMATIC:**

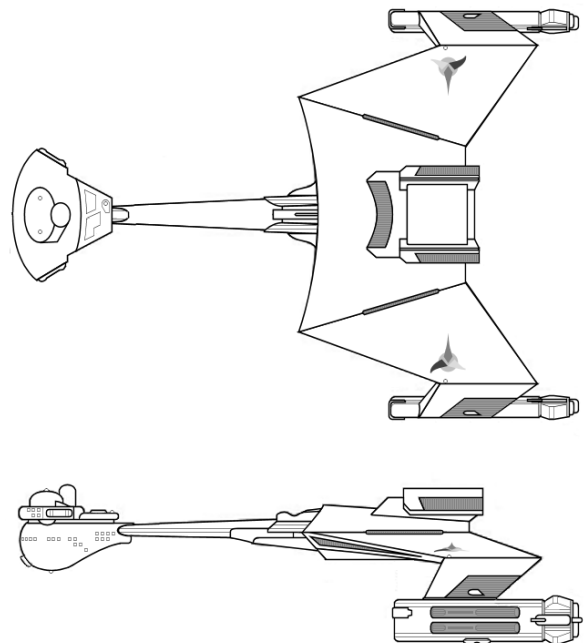



## 2251-2275: The Linear Warp Revolution

---

I remember the first time I saw the *Enterprise* after she was rebuilt. We were rushed, we had a deadline, *Vejur* was on its way to Earth. Still, I have to hand it to Mr. Scott – Commander Scott, pardon – for taking one of those precious minutes to show her off. It was supposed to be a pre-launch inspection, but it was more than that. I hadn't yet seen the rebuilt *Enterprise*, except once before, when she was halfway through the process. I knew what she was going to look like based on that and the construction profiles. Still, to see her for real .... I just stood there with my mouth open as Mr. Scott made that single, slow pass around her, giving me a good look before we finally docked. She was so ... glorious. That wonderful old girl of mine, reborn into a beautiful young woman, sparkling in shining white under those drydock floodlights. It literally took my breath away. It's a sight I'll never forget for the rest of my life.

James Tiberius Kirk  
former Starfleet starship commander  
(2229-2293)

The Class I Era officially came to its end in 2255 with the *Federation* class dreadnought. Even as the most powerful starship of its time was preparing to join the fleet, though, yet another revolution in starship design was already on the way. It was one that would remake the Class I fleet in its own image, outstripping even the mighty dreadnought's firepower and warp capability within twelve short years.

The use of trititanium in starship construction had removed the lone remaining bottleneck to starship construction. That had been the ability of the ship's frame to withstand stresses higher than the semi-mythical Warp 4 barrier. Once that bottleneck was removed, then the onus had passed back to warp engine design. The only things now limiting a starship were the power, speed, and range of its warp engines. Circumferential warp engines, first introduced in the early 2150s, had been the standby of Starfleet for years. They were powerful and fairly easy to both operate and maintain given proper starship design and control systems. Even so, a century later it was becoming evident that circumferential warp technology was fast approaching its limits. A plateau had been reached of a sustained emergency speed of Warp 8 for standard dual-nacelle starship designs (Warp 6 for single-nacelle and Warp 10 for triple-nacelle designs). To the common man this was of little concern; however, it was of considerable worry to Starfleet. Experiments with captured Klingon warp engine technology had shown that their S-Graph systems were inherently more flexible and easier to upgrade than their Federation counterparts. Klingon designs permitted change-outs of major components as improved technology came along. This process might take only a few weeks to a

few months. Common Starfleet practice was to change out the entire engine and its associated control programs. This required a space dock or free-space reassembly area and was a process that took months to complete. If the Klingons made any major advances in their warp technology within the decade (and all intelligence pointed to them doing just that) then their newly refitted starships would probably outclass their current Starfleet counterparts. To prevent this, Starfleet would have to adopt a new warp engine design and do it *now*, while they still had time to put a fleet-wide upgrade plan into effect.



The year 2262 saw a new kind of warp engine become available to Starfleet. It had been a joint development project of Cochrane Warp Dynamics and Leeding Industries designed to represent the next generation in warp technology. Development had begun in the late 2250s on the LN-40 linear warp engine. This was designed as a self-contained unit that could be fitted onto existing Class I starships. Its very appearance was markedly different from any of its precursors, betraying its revolutionary design. The old spooled-coil system of circumferential warp engines, which had reached their zenith with the legendary PB-series, gave way to the linear feed plasma systems of Leeding's new designs. Starfleet was understandably excited at the promise that this new technology held, which had the potential to double the power of its existing fleet of starships with a minimum of effort. To that end three starships, each representing one of the major base configurations of the Class I fleet, were withdrawn from service and turned over to Leeding for LN-40 testing and conversion. These were the heavy cruiser *Endeavour* (NCC-1716), representing the base Jeffries/Joseph design; the scout *Monoceros* (NCC-601), representing single-nacelled designs, and the

transport *Keppler* (NCC-3816), representing both its own class and most of the frigate fleet as well.

The results of extensive testing conducted in 2262 with these three starships produced mixed results. Design limitations inherent with the LN-40 meant that it had to be fitted in pairs. Problems with adapting it to the single-nacelled *Monoceros* required a redesign, with the paired LN-40s mounted on top of its hull in a configuration resembling a *Kearsarge* class light cruiser. The LN-40s themselves also did not prove to be as much of a revolution as Leeding had first promised. True, they were capable of delivering superwarp speeds in excess of warp factor 8 for extended durations. Unfortunately, they had the highest dilithium decay rate of any modern warp engine Starfleet had ever tested. Running a LN-40 equipped starship at superwarp speed would literally burn out its engines in a manner of minutes. This was a major factor that would have to be overcome if the promise that linear warp technology held were to be realized. The Procurements Division rejected LN-40 technology on this basis. *Endeavour*, *Monoceros*, and *Keppler* would be the only starships ever fitted with these engines, which they retained when they returned to fleet service. The LN-40 project was officially abandoned; however, the drive to produce a viable linear warp engine was not.

It took several more years and two more design iterations before Leeding was ready to submit a new linear warp engine to Starfleet for field testing. Their final solution to the LN-40's decay issues was quite radical; however, it worked. It removed the dilithium converter assemblies from the engines and made it a single, separate assembly within the hull of the starship itself. A massive matter/antimatter intermix chamber fed the converted energy into the warp engine(s). This system was also linked into a redesigned impulse engine system, whereby each system could tap off of the other for power. The obvious advantage to this was that the impulse deck could be used to "cold start" the warp engines, a feature that had never been available on a Class I starship until now. Likewise, power from the warp drive could be used to jump-start the impulse deck. Both systems now worked together instead of



separately, and both could be operated from each other's control systems. Making the impulse deck part of the warp power assembly also had an added benefit, one that was vital to Leeding's new warp engine design. In the past, impulse power was not normally used during faster-than-light travel. The impulse engines were allowed to idle or power auxiliary systems in order to keep their reactors running. This was necessary but ultimately wasteful. Leeding's new design used this excess impulse power to reinforce the flux capacitors in the new unified dilithium converter assembly. This prevented the rapid dilithium decay of the LN-40 design by repeatedly reversing the polarity of the neutron flow, setting up a constant interference field to prevent decay from ever starting in the first place. It was an engineering kludge, admittedly, but it worked, and that was all that mattered. The final form of this design was termed the Leeding LN-64 linear warp engine. It would go on to become the namesake of a whole new generation of Federation starships.

Despite its growing pains, despite its costs, and despite the shortcuts that had to be taken along the way, Starfleet's linear warp program of the 2270s was without doubt a great success. This allowed it to keep its fleet on a par with the new-build classes of the Klingons and Romulans at considerably less cost than it would have taken to build a whole new fleet. It ensured that these newly upgraded starships would remain viable fleet assets until a new generation came along to replace them. Finally, it gave Starfleet new prestige among the masses as a defensive force fully capable of delivering on its commitments. Starfleet had reached what was to be the zenith of its popularity since the founding of the Federation. The era that followed, though, the two decades between that zenith and today, would see Starfleet fall to an almost equal low in a web of politics and conspiracy that was, to be honest, largely of its own doing.



Dreadnoughts in action during the Four Days War (2261)

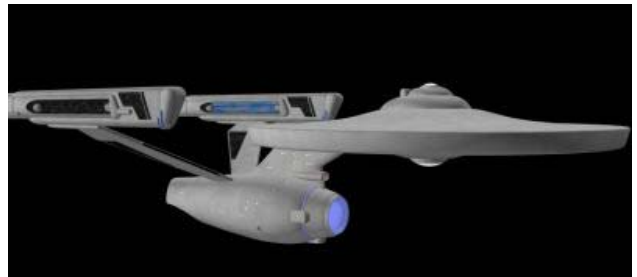

Computer model of the original *Constitution* upgrade proposal. This would eventually become the *Tikopai* class heavy cruiser.



The upgraded *Enterprise* (NCC-1701), first starship of the linear warp generation



Upgraded *Constitution* and *Miranda* class cruisers undertake a joint mission

# STARSHIPS

---

## ***FEDERATION AND STAR LEAGUE*** **CLASS DREADNOUGHTS**

---

**SERVICE ENTRY DATE (OLD CALENDAR): 2255, 2291**

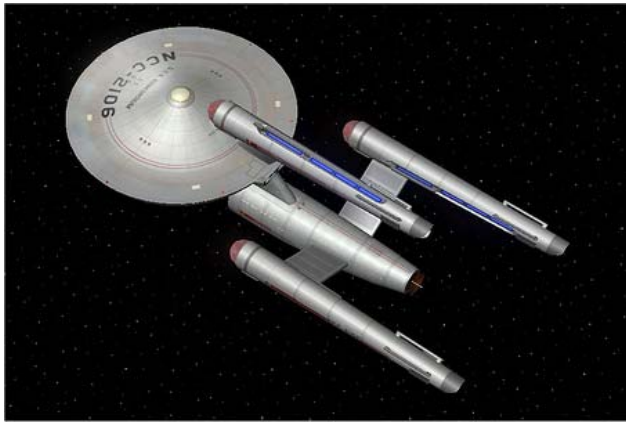

The idea of a triple-nacelled “super starship” had been kicking around the Starship Design Bureau ever since the *Baton Rouge* era. Arbing and Lidde, one of the lead contractors of both the *Baton Rouge* and Class I programs, were the champions of this concept. They had come within an ace of getting their *Baton Rouge* era *Invincible* prototype built when it was cancelled, like so many other *Baton Rouge* era starship classes, once the Class I Program was established. It took the hard lessons taught by the Klingon’s B-1 *Jul’Kar* class battleship during the Four Years War to convince Starfleet Command that a dreadnought was a needed fleet asset. Surprisingly, the Federation Council took less convincing than had the Procurements Board, approving the post-war construction program without debate on the first pass. The fight for funding of all 20 ships in the planned class was another matter, though, and fiercely debated within the Military Staff Committee until in the end only 12 were built.

The *Federation* class dreadnoughts were the epitome of the Class I era. They were the first to field Cochrane’s new PB-47 “Titiac” warp engines, capable of driving such a massive starship as if it were a light cruiser. They had many other features pioneered with the early Class I starships: multiple beam weapon banks (*Federation* had extra phaser banks on the belly of her secondary hull), a spacious shuttle bay (which could hold almost as many shuttlecraft as a *Surya* class frigate), and extensive sensor suites (the equivalent of a *Hermes* class scout). A slightly redesigned primary hull saucer also housed a centrally located command bridge, as opposed to the topside mount of normal Class I designs. This was done to protect the bridge from being targeted during combat, which had been a favorite battle tactic of the Klingons during the Four Years War.

There was still doubt within certain parts of Starfleet Command as to the workability of a triple nacelle design. Problems with such a configuration dated all the way back to the UESF’s *Verne* class starships of the mid-22<sup>nd</sup> century and, more recently, in the ignominious *Tritium*. Arbing and Lidde’s solution was to follow the warp field flow of the basic Jeffries design in the placement of its engines. The third warp engine was mounted ahead of the other two and on top of the primary hull, as opposed to the symmetrical, in-line triangular configurations of earlier designs. This allowed the forward engine to act as a spearhead of sorts for the other two, thus reducing the tendency to wormhole. This configuration also had an obvious combat advantage: in an emergency saucer separation, the primary hull of a *Federation* class dreadnought would remain warp capable. This configuration would be duplicated in all subsequent Federation dreadnought designs.

The only chance these ships got for the kind of combat for which they were designed was during the brief Four Days War of 2261. By the time the Organians intervened and enforced peace on both sides, a battle fleet led by the dreadnoughts *Federation* (NCC-2100) and *Affiliation* (NCC-2108) had already penetrated the Klingon border and fought their way to its outer industrial zones. The Klingons were understandably impressed by the demonstrated abilities of Starfleet’s new combat vessels, and would copy aspects of their design into the later C-series *K’herr* class dreadnoughts.

All *Federation* class starships received linear warp technology during their first ESLP refits in the late 2270s. This move was made with the events of the Kzinti Incursion of 2272 still fresh in everyone’s minds. The new configuration, dubbed the *Star League* sub-class, retains both the lines and layout of the original secondary hull configuration while adding linear warp technology. The program is credited with saving the dreadnought class from being eliminated altogether. All but three of the *Federations* had received this conversion by 2291, when conversion of the last three was curtailed due to political and financial reasons. Attempts to restart the process several times have stalled. It is most likely that they will never be upgraded, thus forced to spend the rest of their service lives as training, auxiliary, or second-rate combat vessels.

---

---

### SPECIFICATIONS (*FEDERATION*):

Length:	306.8 m
Beam:	135.5 m
Draft:	93.9 m
Displacement:	285,000 DWT
Crew:	500
Range:	16 years at L.Y.V.
Armament:	10 phasers (5 banks of 2) 2 photon torpedo tubes

Cruising speed:	warp 8
Maximum speed:	warp 10

### SPECIFICATIONS (*STAR LEAGUE*):

Length:	307.6 m
Beam:	141.7 m
Draft:	84.1 m
Displacement:	222,500 DWT
Crew:	500
Range:	20 years at L.Y.V.
Armament:	20 phasers (7 banks of 2 plus 6 single mounts) 2 photon torpedo tubes

Cruising speed:	warp 11
Maximum speed:	warp 15

#### Innovations:

- First successful Class I starship design to have more than two warp nacelles
- 

---

### VISUALS:

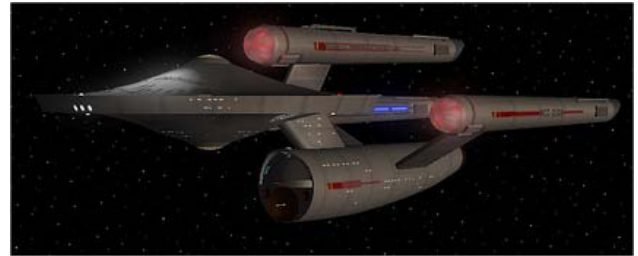

*Federation class dreadnought (c.2260)*



*Star League dreadnought conversion (c.2295)*

---

### SCHEMATICS:

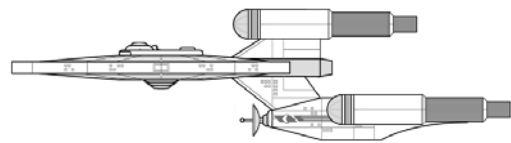

Arbing and Lidde's original *Invincible* dreadnought proposal

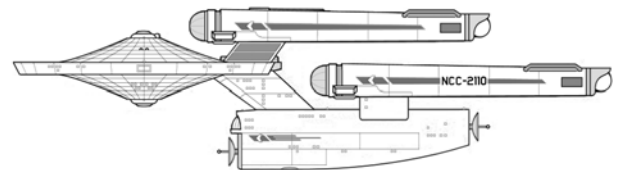

*Federation class dreadnought (c.2260)*

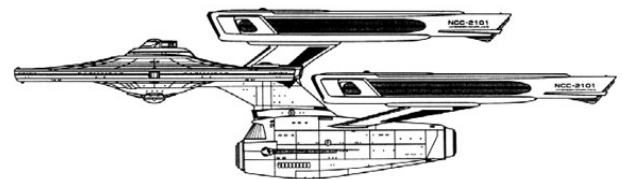

*Star League class dreadnought (c.2295)*

---

## ***HOP!* CLASS RESEARCH VESSEL**

**SERVICE ENTRY DATES (OLD CALENDAR): 2258**

Although it was the spiritual descendant of the *Cahuya*, the Class II *Hopi* differed in many aspects. It was fitted with modern PB-47 circumferential warp engines, for starters. It also lacked the *Cahuya's* limited ability for a planetary landing. What made it unique was its sectioned triple hull. Its center hull had control and crew spaces on one end, with both secondary propulsion and an oversized shuttle bay on the other. Everything in the middle, though, was removable. This permitted the fitting of specialty packages, such as extended sensor suites or a deep space telescope for stellar cartography mapping. The side sections were 100% reconfigurable according to mission need and duration. This made the *Hopi* class among the most flexible and popular research craft of their time.

### **SPECIFICATIONS:**

Length:	203.8 m
Beam:	138.2 m
Draft:	92.1 m
Displacement:	151,800 DWT
Crew:	325
Range:	5 years at L.Y.V.
Armament:	4 phasers (1 bank of 2 both fore and aft)

Cruising speed:	warp 6
Maximum speed:	warp 8

### **SCHEMATIC:**

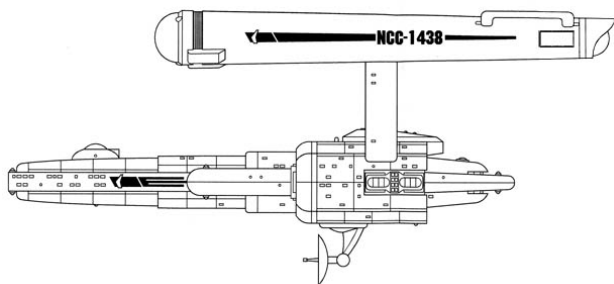

## ***DERF* CLASS TENDER**

**SERVICE ENTRY DATE (OLD CALENDAR): 2260**

The *Derf* class was designed to act as fleet tenders, providing support for Starfleet operations in combat zones and also maintenance of the Federation's marker buoy system during times of peace. It was an odd role for an odd ship, yet *Derf* filled it admirably. It mounted a customized extended primary hull full of repair and maintenance facilities, shops, spare parts storage, and other items that always seemed heaven-sent to duty-pressed starship engineers. A single *Derf's* onboard facilities could usually handle all but the most severe of starship damage. The *Pearl* class mobile spacedock would be created during the linear warp era to fill this gap, assisting the *Derf* in its role of keeping the Class I fleet in full operational trim.

### **SPECIFICATIONS:**

Length:	274 m
Beam:	128 m
Draft:	65 m
Displacement:	128,000 DWT
Crew:	72
Range:	6 years at L.Y.V.
Armament:	6 phasers (3 banks of 2)

Cruising speed:	warp 6
Maximum speed:	warp 8

### **SCHEMATICS**

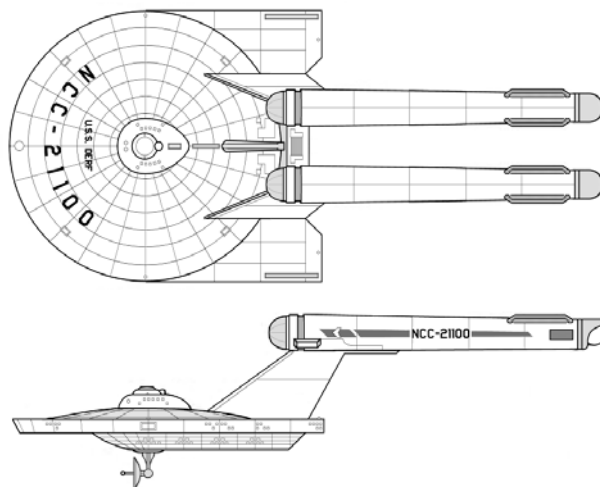

# GAGARIN (GREER) CLASS CORVETTE

SERVICE ENTRY DATE (OLD CALENDAR): 2266



The *Gagarin* class corvette was to the Class II Program what the *Enterprise* was to the Class I Program. It provided an all-new, modern technology frame on which to base a variety of new linear warp derived starship designs. In the case of the *Gagarin*, however, the ship involved was a brand new design, meant to serve as a base for the many different kinds of low-profile missions for which a true starship was not required. Various attempts at this had been tried over the years, but in the *Gagarin* they found what many consider to be their ultimate and most successful expression.

The stock *Gagarin* prototype, *U.S.S. Greer* (NCC-472) was little more than a small form factor hull with minimal crew and command facilities slung between two Kloratis FWB linear warp engines. Three hard points were mounted under the ship, two directly under the engines and one centerline for different kinds of attachments. The first variation of the *Gagarin*, the *Oberth* class research ship, has since become the most famous. It features an underslung sensor and survey pod, with power provided through support pylons attached directly to a *Gagarin*'s powered outer hard points. The following year saw the introduction of the *Jester* class light corvette (almost identical to *Oberth* but with a photon torpedo rack instead of the sensor pod) and the *Orca* class gunboat (an triple-engined *Gagarin* with megaphaser cannon). Many more variations followed in the years to come. For example, the *Clarke* class clipper was a *Gagarin* with a third underslung warp engine and internal modifications for diplomatic accommodations. Another well-known example was the *Fisher* class light tug, which is a *Gagarin* fitted with a Class I transport container tow pad.

A total of 226 *Gagarin* hulls have been built since the class first entered service in 2266, with more on the way. For almost every Class I starship class there is a corresponding Class II *Gagarin* derivative to match. This has given Starfleet the most versatile "light" mission capability it has had since its inception. This has proven to be of great benefit in current times, what with the cutbacks and restrictions in Class I starships imposed by the Starfleet Reorganization Order of 2295. The availability

of the *Gagarin* has enabled Starfleet to better cover gaps imposed by the Federation Council under this order. The versatile *Gagarin* and its derivatives can be expected to serve Starfleet in an expanded capacity in the future given these circumstances. The fact that all of these are new builds, with 100-year expected service lifetimes, almost guarantees it.

## SPECIFICATIONS (BASE CONFIGURATION):

Length:	120 m
Beam:	103 m
Draft:	40 m
Displacement:	22,500 DWT (base config.)
Crew:	between 24 and 60
Range:	10 years at L.Y.V.
Armament:	2 phasers (1 bank of 2) (other configurations vary in types and amount of additional armament)
Cruising speed:	warp 6.0
Maximum speed:	warp 7.6

All specifications are subject to variance depending on specific sub-class. For specifications concerning a specific sub-class, cadets should consult the Academy Intranet. Civilians should consult the *Jackill's* series of Starfleet reference works, in particular Volumes 2 and 3.

### Innovations:

- First multimission design for Starfleet's Class II starship program
- Versatility of basic design has spawned numerous derivative and sub-classes since its initial launch.

## VISUALS:

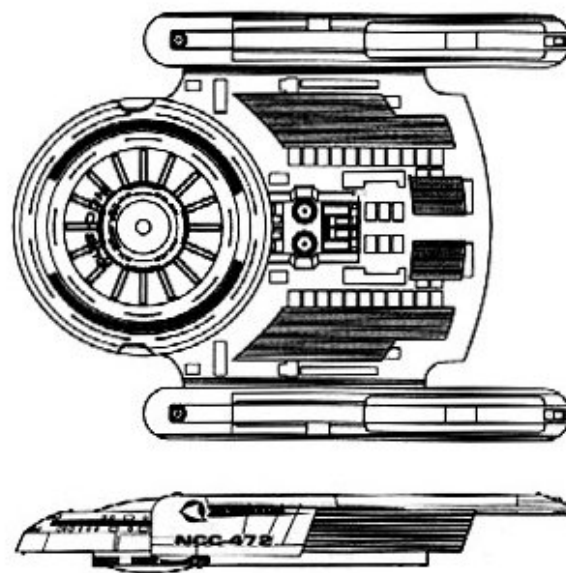



# ***ENTERPRISE* CLASS HEAVY CRUISER**

**SERVICE ENTRY DATE (OLD CALENDAR): 2267**



On 7 March 2265 the Starfleet heavy cruiser *Enterprise* returned to the Sol System after completing its historic five-year mission under the command of Captain James Tiberius Kirk. Both Captain Kirk and his officers were public celebrities due to their exploits; the *Enterprise* herself had long since surpassed her lost sister *Constellation* as an icon in the public eye. The *Enterprise*, to them, was Starfleet realized, the very essence of all that the Federation was supposed to be. There was only one problem with this picture. *Enterprise* was an old ship. She had been the second ship of the Class I Program back during its inception, launched in 2223 amid great fanfare and hope for the future. *Enterprise* had helped not only to realize that future but to also defend it under the commands of such captains as Robert April, Christopher Pike, and Captain Kirk. Even so, the *Enterprise* was aging, and not even a major overhaul and two major upgrades (plus many minor ones) over the past five decades could hide that fact. The time had come for her second ESLP refit, one designed to extend her life by another 20-25 years. It just so happened that *Enterprise* was in the right place and at the right time, as it had been so many times before during its storied career. Its next ESLP refit would like no other performed before on a starship of its class.

The *Enterprise* that re-entered service prematurely in 2267, the only ship available at the time capable of dealing with the Vejur Crisis, was like no other in Starfleet. Two months after its return to Terra back in 2265, after all crew had disembarked, the ship's logs downloaded and all systems shut down, it had been towed into the spacedock normally reserved for dreadnought construction. This was on the direct orders of Fleet Admiral Heihachiro Nogura, Commander-in-Chief of Starfleet. The next ten months were spent stripping the ship down to its base frame and stress-testing every deck, bulkhead, and frame member along the way. *Enterprise's* PB-47 circumferential warp engines, which were practically brand new and had been in use for less than a year, were removed along with their support pylons. The rebuilding process began in 2266, initially to the *Tikopai* specification that had been originally drawn up on the orders of Fleet Admiral Nogura. Vociferous

objections were raised on certain aspects by Commander Montgomery Scott, former chief engineer of the *Enterprise* and now head of the conversion project. This caused the design to be changed in mid-conversion. These changes mainly affected weapons and sensor capability (as well as a modified internal layout for the secondary hull) and were quickly incorporated into the refit. The old dish-style navigational deflector was replaced by a hull-mounted recessed one, and a new split-level hanger bay (considerably larger than the previous one, courtesy of Commander Scott) was also included. The fitting of Starfleet's new small craft docking system at strategic points on the hull was also a first for an active duty vessel. The primary hull saucer retained its classic lines; obvious changes included the new impulse deck and additional phaser banks. The most telling visual difference of all, though, were her powerful new LN-64 linear warp engines. *Enterprise* was the first operational starship to receive them.

*Enterprise* did not get a proper shakedown cruise until after the Vejur Crisis was over. Once again resuming the con was Rear Admiral James T. Kirk, who had resumed the captaincy (with the blessing of Fleet Admiral Nogura) after the untimely disappearance of Captain Willard Decker. Extensive testing during *Enterprise's* shakedown cruise revealed her to be the most powerful ship in Starfleet (and possibly known space) at the time. She outclassed a dreadnought with her 12 phaser banks and dual photon torpedo tubes. Her new engines were rated for warp 8 cruising speeds and warp 12 emergency speeds, although *Enterprise* hit an unofficial speed of warp 17.8 during subsequent testing. With impressive numbers such as these Starfleet wasted little time in seeking and winning Federation Council approval for more funding for its linear warp program. Starfleet's entire Class I fleet was immediately put on schedule to receive linear warp upgrades as fast as yard space, duty schedules, and funding allowed.

---

## **SPECIFICATIONS:**

Length:	304.8 m
Beam:	141.7 m
Draft:	71.3 m
Displacement:	210,000 DWT
Crew:	500
Range:	22 years at L.Y.V.
Armament:	18 phasers (7 banks of 2 plus 6 single mounts) 2 photon torpedo tubes
Cruising speed:	warp 8
Maximum speed:	warp 12

### Innovations:

- First official starship class in Starfleet's new Class I linear warp technology upgrade program
- First fitted with Starfleet's docking port system

---

**VISUALS:**

*U.S.S. Enterprise* (NCC-1701) in fleet service immediately after her rebuilding in 2268. The original was lost in action in 2287. The upgraded heavy cruiser *Yorktown* (NCC-1717) would be renamed as a new *Enterprise* (NCC-1701-A) later that year. This was in honor of James Kirk's extraordinary efforts to end the Whalesong Crisis and save Terra from destruction.

---

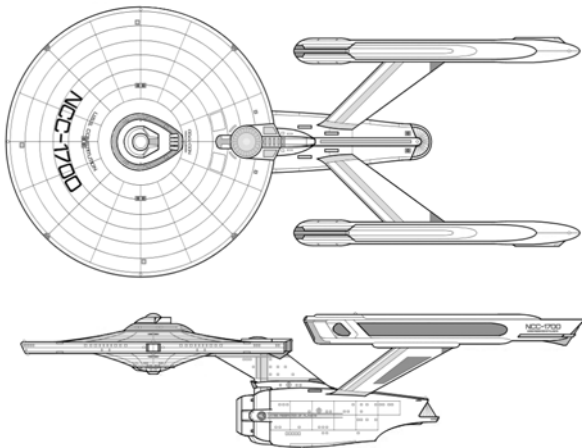
**SCHEMATIC:**

---

**LOTUS FLOWERCLASS TRANSPORT**

**SERVICE ENTRY DATES (OLD CALENDAR): 2268**

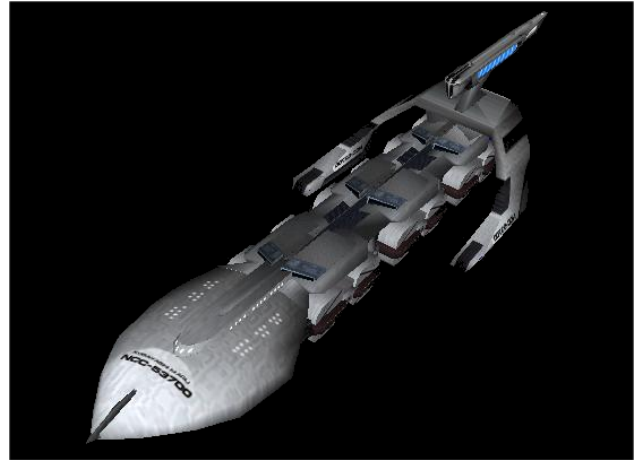

This was the first civilian transport craft of the linear warp era. 218 of these were ordered by the Federation Merchant Marine for various purposes to meet its ever-expanding transport requirements. At least twice that number have been sold to a variety of Federation businesses and private citizens. It has dual detachable holds that can be configured for a variety of cargo. In their place it can carry a single standard Starfleet transport container or one or more containers of other various systems in use, such as the older and still popular *Watt*-era cargo pods.

---

**SPECIFICATIONS:**

Length:	237 m
Beam:	73 m
Draft:	49 m
Displacement:	148,000 DWT (empty) 245,000 DWT (full load)
Crew:	81
Range:	2 years at L.Y.V.
Armament:	none
Cruising speed:	warp 7 (unloaded) warp 3 (full load)
Maximum speed:	warp 9 (unloaded) warp 6 (full load)

---

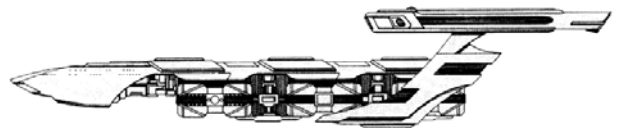
**VISUALS:**

## **ANTARES CLASS FREIGHTER**

**SERVICE ENTRY DATES (OLD CALENDAR): 2269**



The *Antares* class freighter is a common sight at all points in Federation space. It is popular with both corporate and independent operators alike due to the ruggedness of its design. It is capable of planetary landings for loading and off-loading of its cargoes. It has six individual general-purpose cargo holds, any of which can be sealed off and separated via explosive bolts in the event of an emergency. Its warp engine design is somewhat old-fashioned but adequate for the task. *Antares* owners are known to “soup up” their ships to suit their own tastes, resulting in thousands of individual variations.

### **SPECIFICATIONS:**

Length:	280 m
Beam:	75 m
Draft:	51 m
Displacement:	53,200 DWT (empty) 115,000 DWT (full load)
Crew:	48
Range:	3 years at L.Y.V.
Armament:	varies with owner
Cruising speed:	warp 5 (unloaded) warp 3 (full load)
Maximum speed:	warp 7 (unloaded) warp 6 (full load)

### **SCHEMATIC:**

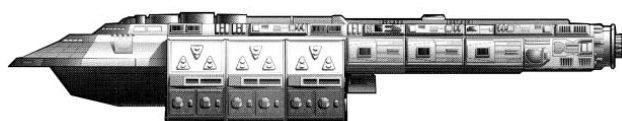

## **WHORFIN CLASS TRANSPORT**

**SERVICE ENTRY DATES (OLD CALENDAR): 2270**



These were originally developed for use as diplomatic vessels and priority personnel transports. All were named for famous Federation ambassadors of both past and present. They served Starfleet in this role for almost two decades before they were replaced by more modern designs. Many *Whorfin* class starships were purchased by the civilian sector following their decommissioning from Starfleet, but several still remain in fleet reserves as a fallback measure.

### **SPECIFICATIONS:**

Length:	127.1 m
Beam:	37.7 m
Draft:	22.3 m
Displacement:	35,000 DWT (empty) 129,300 DWT (full load)
Crew:	22
Range:	3 years at L.Y.V.
Armament:	2 phasers (1 bank of 2)
Cruising speed:	warp 5.0
Maximum speed:	warp 7.5

### **VISUALS:**

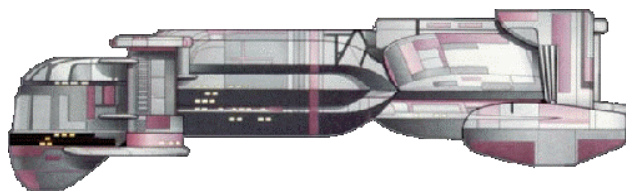

# ALIEN STARSHIPS

## ROMULAN U-34 *CRICKET*

(ROMULAN *VASHATHAM* – “WARBIRD”)

SERVICE ENTRY DATE (ESTIMATED): 2252

DATE FIRST SIGHTED BY FEDERATION: 2260

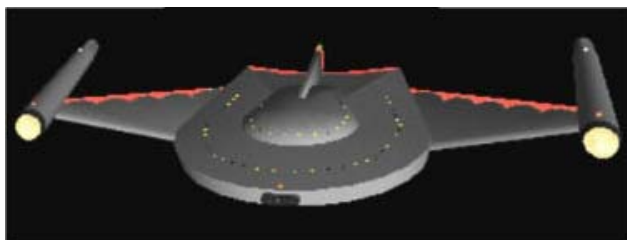

The *Cricket* was the first Romulan ship ever observed operating in Federation space since the end of the Romulan War. It was originally classified as the P-1A *Empire* class until several decades later, once more information on the Romulan Space Navy became available. It has since been reclassified in accordance with standard Starfleet Intelligence nomenclature.

*Cricket* represents the pinnacle of postwar Romulan designs. Its lines clearly evoke the “Warbird” of the Romulan War, for which it has since been named (by both Starfleet and the Romulans, as it later turned out). It is the “Warbird” reborn in almost every aspect save for improved engines and weaponry. *Cricket*'s engines are capable of sustained cruising speeds over warp 4 and a burst emergency speed approaching warp 6. The main difference from its wartime predecessor is its plasma torpedo system, which represented a giant leap forward in Romulan heavy weapons technology, and its cloaking device, which became Romulan standard fleet issue with its *Capsize* predecessor. The only drawback of its new plasma weaponry was it that it required most of a *Cricket*'s warp power to generate a plasma torpedo; furthermore, it could not be held in its tube for more than a few seconds. Like *Capsize*, this power requirement meant that *Cricket* could neither arm nor fire a plasma torpedo while cloaked. Another limiting factor to the *Cricket* was its short operating range due to lack of available interior space for fuel stores. *Cricket*s, like most other Romulan starships of the era, were usually dropped off within range of their targets by a *Gooney Bird* warp transport and returned to it once their mission was complete.

In late 2161, in an apparent effort to test Starfleet resolve, a lone *Cricket* crossed the Neutral Zone and began attacking Federation outpost stations. Four were quickly destroyed before the starship *Enterprise* (NCC-1701), the nearest Starfleet vessel, could respond. What followed next was a pursuit and fight between the *Cricket* and the *Enterprise* that took it all the

way to Icarus IV, a comet whose path crosses the Neutral Zone. *Enterprise* was eventually able to corner and disable the *Cricket*, but only after suffering a fair amount of damage from a hit by one of the *Cricket*'s plasma torpedoes earlier in the encounter. *Enterprise* had unsuccessfully attempted to outrun the torpedo at a speed of warp 8 before it struck. Fortunately, most of the plasma torpedo's strength had dissipated by the time of impact; even so, it was still strong enough to overwhelm *Enterprise*'s shields and damage the ship. Data from the attack on the *Enterprise*, coupled with extensive analysis of the debris remaining from the four destroyed outpost stations, were used to compile a combat profile for the *Cricket* in this initial encounter. It also gave Starfleet its first taste of advanced plasma weaponry, for which ever after it would accord the Romulan Space Navy the respect it was long overdue.

*Cricket*, along with its offshoots and derivatives, are still fairly common sights along the Neutral Zone despite their age. They were retired from main fleet service with the introduction of *Winged Defender*; however, many continue to soldier on in auxiliary roles. Many have also been converted for a variety of other purposes or served as testbeds for technology conversions and upgrades. The bulk of these are dealt with under the entry for the modernized “Warbird” class (V-8).

Starfleet commanders are advised to be on guard when confronting a *Cricket* in combat. In the hands of a skilled Romulan commander it can still be as deadly as any modern Romulan starship given its plasma torpedo system.

### SPECIFICATIONS:

Length:	131.0 m
Beam:	234.1 m
Draft:	33.5 m
Mass:	70,000 DWT
Crew:	170
Armament:	4 disruptors 1 plasma torpedo tube
Cruising speed:	warp 4.4
Maximum speed:	warp 5.7

#### Innovations:

- First Romulan starship sighted in Federation since the end of the Romulan War
- First Starfleet encounter with a cloaked Romulan ship
- First Romulan starship to field plasma torpedoes



# KLINGON D-7 BATTLECRUISER

## KLLOLDE CLASS

DATE FIRST OBSERVED BY FEDERATION: 2262



The *Kloldde* class battlecruiser is essentially the *Raxor* class with most of its deficiencies addressed. A modified B-1 *Jul'kar* class *D'rell*-type hull, with its increased armament, replaced the D-6 *Raxor*'s less able one. This small change gave the design the added offensive and defensive armament that it lacked before. More powerful engines helped to compensate for, but not completely address, the *Raxor*'s limited side and rear shielding. The end result was a Klingon battlecruiser design that was essentially a match for Star Fleet's Class I heavy cruiser.

The D-7 *Kloldde* class battlecruiser is probably the most recognizable Klingon starship and certainly the most talked about. While it has never seen fleet action insofar as is known, individual D-7s and D-7 squadrons have frequently tangled with the best of Star Fleet in numerous border incidents. Most Star Fleet commanders have developed a healthy respect for it, which has only served to enhance its reputation. Small wonder then that it is still seen as the unofficial symbol of the Empire's might despite a superior successor (the D-8 *K't'inga* class).

Some 35-60 *Kloldde* class battlecruisers are believed to have been built, with a handful sold to the Romulans starting in 2264. A limited shielding retrofit was first noticed in 2263. None have been upgraded beyond this point. The *Kloldde* was effectively replaced by the *K't'inga* on the Klingon starship production schedule. Many now serve as test beds for various weapons technologies, such as stasis field generators and the Klingon version of photon torpedoes. Some have even undergone a carrier conversion similar to that of the D-6. Most D-7s currently serve as operational support vessels, assisting their successor D-8s on various missions for the glory of the Empire.

## SPECIFICATIONS:

Length:	216.4 m
Beam:	152.4 m
Draft:	55.3 m
Mass:	110,000 DWT
Crew:	454
Armament:	10 standard disruptor banks 2 heavy disruptor banks

Cruising speed:	warp 6
Maximum speed:	warp 7

### Innovations:

- First heavy-firepower Klingon battlecruiser class

## SCHEMATIC:

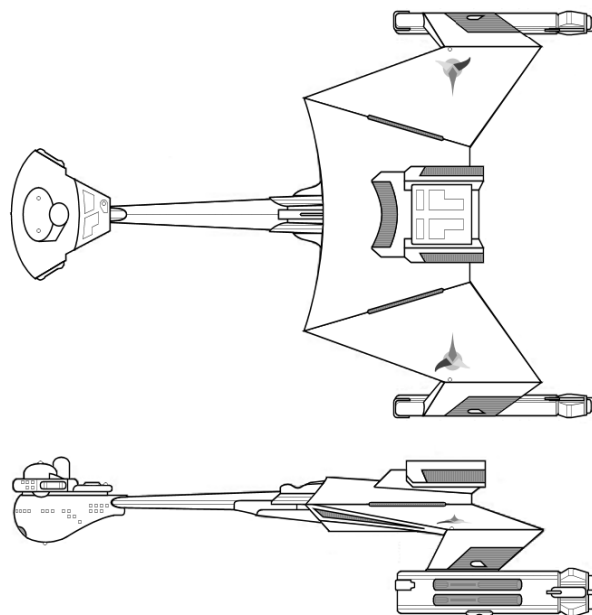



# D-8 BATTLECRUISER

## *K'TINGA* CLASS

**DATE FIRST OBSERVED BY FEDERATION: 2267**

The D-8 *K'tinga* is the fourth and final iteration on the classic *D'rell* type hull whose evolution apparently began with the D-4. It is for all intents and purposes a heavily uprated D-7, with an improved shielding system and photon torpedoes in place of its disruptors. Coupled with the *D'rell* hull's proven maneuverability these upgrades make the D-8 a worthy foe for Star Fleet's new linear warp refitted starships.

The D-8 was first seen in action during the V'Ger Crisis of 2267. As V'Ger made its way across Klingon space a trio of D-8 battlecruisers unsuccessfully attempted to engage it near the Organian Treaty Zone. All three vessels were destroyed in the process; however, extensive intelligence was gathered on the encounter by the nearby Epsilon 9 monitor station (which was itself destroyed by V'Ger shortly thereafter). Analysis of the data confirmed that the Klingons were keeping pace with Federation starship technology and that in a fair fight the D-8 would prove to be a formidable opponent. In practice the D-8 has proven to be the Klingon equivalent of the *Enterprise* class heavy cruiser, once again establishing relative parity between the two interstellar powers for a time.

The D-8 is currently the mainstay of the Klingon battlecruiser fleet. It has replaced both of its predecessors, the D-6 and D-7, on the Klingon production schedule and has all but replaced them in major fleet operations. As all of these are brand new, fitted with the latest in Klingon starship technology advances, the D-8 will most likely remain a common sight for decades to come.

## **VISUAL:**

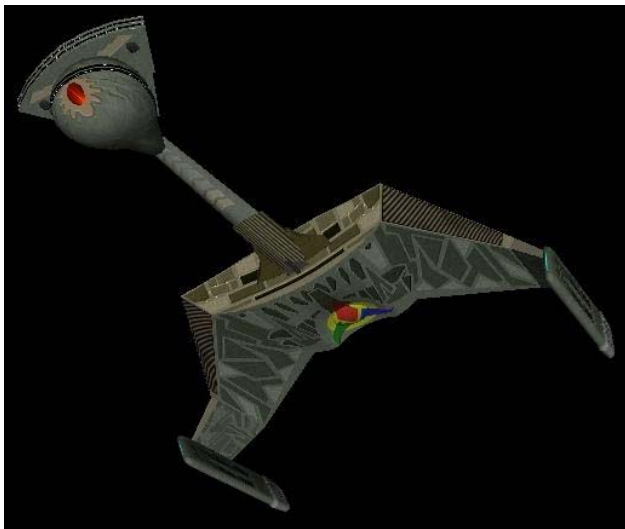

## **SPECIFICATIONS:**

Length:	214.3 m
Beam:	152.4 m
Draft:	57.3 m
Mass:	120,000 DWT
Crew:	385
Armament:	10 standard disruptor banks 2 photon torpedo tubes
Cruising speed:	warp 6
Maximum speed:	warp 10

### Innovations:

- First "linear warp" type Klingon starship class
- First Klingon starship fitted with photon torpedoes

## **SCHEMATICS:**

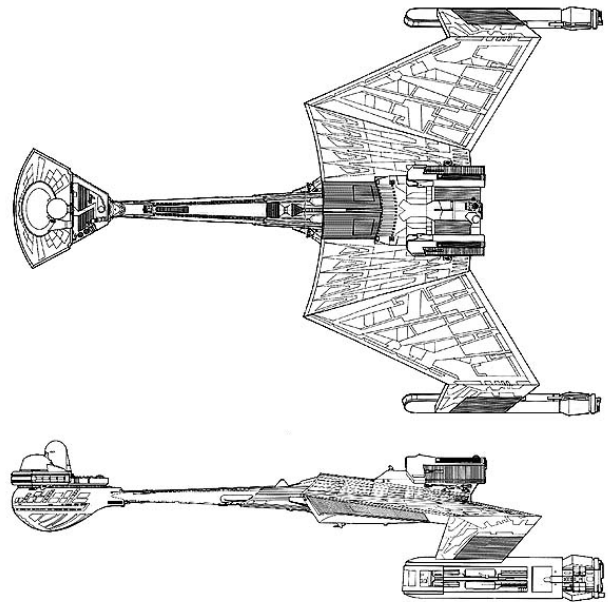

# 2276-2295: Towards the Future

---



The Starfleet of the early 2270s lived through an escalation boom in the aftermath of the intrusion by the V'Ger entity, with nearly unlimited resources provided for the prevention of any further invasions of similar kind. The *de facto* source of these resources, the Organian Peace Treaty, proved but a temporary lull in Klingon-Federation political and military intrigue. Only the stern leadership of Fleet Admiral Robert Conrad and his legendary successor Heihachiro Nogura had kept Starfleet from overreacting to the Klingon threat in the preceding decades. When these powerful figures retired from Starfleet command, other forces began vying for power in the highest echelons. The infamous coup attempt by Vice Admiral Vaughan Rittenhouse, even though doomed to fail from the outset, cast deep shadows over the public image of Starfleet – shadows that even the brief return of Fleet Admiral Nogura and the resurrection of the exploration program were hard pressed to disperse.

For the duration of the late 2270s, the militaristic forces inside Starfleet were again technically

outnumbered by the more peaceful factions. Despite its official peaceful doctrine, though, Starfleet continued to prepare a huge fleet of modern cruisers with significant military as well as exploration capabilities. Also, the major programs for production of modern dreadnoughts and the space control ship program were finally providing results. These would culminate in the *Excelsior* class, the next 'backbone' vessel of Starfleet and a worthy successor to the famous *Constitution* heavy cruisers.

The Klingon Empire attempted to match the Federation move for move, upgrade for upgrade, and new class with new class. It also introduced cloaking capability to many of its naval vessels, courtesy of its treaty with the Romulans. The rigorously structured and exploitative Klingon economy was slowly descending towards chaos, as it simply did not have the base to cope with the conservation-minded free market economy of the Federation. Some visionary leaders foresaw the inevitable and strove for closer diplomatic and ultimately economic ties with the Federation. Others sought for the answer in

increased military spending and frantic conquest of new worlds to exploit for new resources. No headway could be made on the Federation front, though, not even after it had become painfully evident that the Organian peace treaty no longer was being enforced at all. Neither side would back off, not even after a series of provocations revolving around the Genesis Incident that introduced a new potential superweapon of immense power.

To offset this balance of terror, a far-flung conspiracy was engineered by Starfleet hardliners who, under the leadership of Fleet Admiral Lemuel Cartwright, aimed for an offensive against the Klingon Empire. Simultaneously and perhaps not coincidentally, relations with the Romulan Star Empire grew warmer. These two troubling developments came to a peak in the Praxis incident, where a key Klingon energy production facility exploded and left the whole Empire badly damaged. The conspirators saw the right moment had come, and seized it. A chain of assassinations was begun to pave way for a declaration of war against the weakened Empire. Unfortunately, the plan of the hard-liners required support of Klingon and Romulan factions to succeed, and complex plots often end in a disaster, as was luckily the case with their attempted coup of 2291. The actions of one man, Captain James T. Kirk, saved the life of President Ra-ghotarei and the integrity of the Federation. Relationships between the UFP and the Klingon Empire drastically improved, in the aftermath of the aborted coup, and a thorough cleansing of Starfleet would eventually result.

adapted from  
*Guide to the UFP Starfleet*  
by Timo Saloniemi



A *Saladin* class destroyer being upgraded (c.2280)



The *Midway* class shuttlecarrier *Ark Royal* (c.2295)



The massive super dreadnought *Yamato* (NCC-1305-C) undergoing space trials (2290)



The mining complex on Praxis before it was destroyed (c.2290)  
*Image courtesy of the Klingon Empire*

# STARSHIPS

## DREADNOUGHTS OF THE LINEAR WARP ERA

### SERVICE ENTRY DATES (OLD CALENDAR):

**ULYSSES CLASS: 2278**

**MISSOURI CLASS: 2287**

**YAMATO CLASS: 2291**

Starfleet began conversion of its *Federation* class dreadnoughts along with other ship classes during the fleetwide linear warp upgrade programs of the 2270s. *Federation* had been made obsolete overnight by this development, and the old design's limits had been dramatically illustrated by the vain attempt of the dreadnought *Entente* (NCC-2120) to catch V'Ger before it could reach Earthspace. It would not do for one of Starfleet's newest pre-linear Class I starships to be already obsolete, one that was supposed to be the fastest and most powerful of that same fleet. For this reason the *Star League* conversion program began.

Unfortunately, *Federation* proved more costly and troublesome to convert to linear warp technology than any other other Class I starship. The specialized primary and secondary hulls were largely to blame for this, as was the need to keep the unique three-nacelle configuration in order to preserve its warp geometry. Delays and cost overruns continued to compound until, in the end, the Admiralty conceded that new builds would be less troublesome. Thus, even as *Star League* conversions proceeded, work began on what would become the modern linear warp dreadnought program.



*Ulysses* was the first new-build dreadnought of the linear warp generation. It was a spin-off of Project Citadel, Starfleet Command's effort to develop a cruiser-sized command ship. The resultant design was too large for a standard cruiser classification; hence the dreadnought designation. Work on *Ulysses* would in turn influence development of the *Excelsior* space control ship. Operationally it functions like a scaled-down *Excelsior*, with similar weaponry but redesigned LN-66 engines

and a scaled-down secondary hull. It is extremely warp-agile for a dreadnought, thanks to the use of a modified split primary hull dorsal similar to that used for the *Nelson* class destroyer.

Although the *Ulysses* is the oldest of the new-build modern dreadnoughts, it has two distinct advantages over its successors. Its components are similar enough to existing Class I Program and *Excelsior* generation starships to make for easy upgrades. In fact *Ulysses* has proven to be the least expensive capital ship of the linear warp generation to refit. They are also quite mission versatile, and have been reconfigured to serve in a variety of roles. These two factors ensure that *Ulysses* will survive the Starfleet Reorganization Order and enjoy an extended service life well into the 24<sup>th</sup> century.



*Missouri* is considered to be the Federation's most all-around capable modern dreadnought. That said, it is also known as one of the slowest and ugliest. Its lines fall squarely into the "function over form" school, causing many humans to liken it to a flying boat or bathtub. Appearances can be deceiving, however. For all of its lack of visual charm, the "B.U.F.F." (*Missouri's* unofficial nickname) has perhaps the heaviest and most balanced mix of power, weapons, and shielding capability of any warship of its class. Such a mixture requires raw amounts of power in addition to that available from standard warp and impulse power grids. *Missouri* is therefore unique among Starfleet vessels in that it has a third main power system: a series of high-capacity modern fusion reactors buried deep within its hull, fully capable of powering either the weapons or shielding grid all by themselves and available for propulsion under emergency conditions. This was the first time such a system has ever been employed on a Starfleet vessel, and its success may spur future such efforts. The one drawback of the *Missouri* is that it is the slowest dreadnought in Starfleet due to all of these features; however, most of its crews don't seem to mind given the shipboard resources available to them.



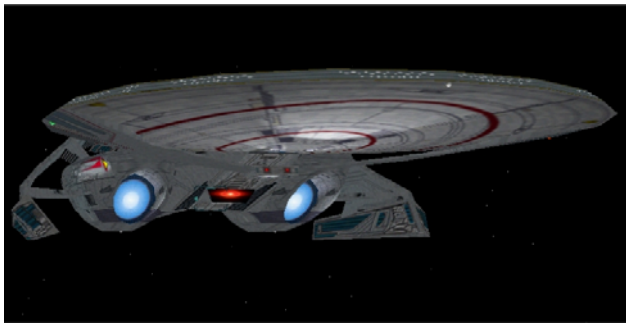

*Yamato* was designed as a direct challenge to the mighty Klingon B-10 battleship. Some are already calling it a battleship or "super dreadnought," although technically it is classified as just a dreadnought. It is the most heavily armed and powerful Starfleet vessel ever constructed. *Yamato* also has a quad LN-70 warp engine arrangement, one each mounted to dual secondary hulls and the other two mounted perpendicularly over the line of the primary hull. Only the *Yamato* (NCC-1305-C) has entered service so far, with two more (*Musashi* and *Shinano*) under construction at the Utopia Planitia Orbital Shipyards. No more are on order, with all being converted to long-range "explorers."

The enactment of the Starfleet Reorganization Order of 2295 has affected new build dreadnoughts as well as hold. The entire uprated *Federation (Star League)* class is being removed from service, with *Affiliation* (NCC-2108) being the last on the decommissioning schedule. The *Ulysses* class will be retained, though, given its relatively low operational costs and proven mission versatility. The entire *Missouri* class is being placed in ready reserve effective next year, leaving *Yamato* as the only new-build dreadnought class in active Starfleet service. As for the *Yamato*, the remaining five ships in the class have been cancelled. Its sister ships *Musashi* and *Shinano* will be converted to long-range explorers while still in the yard. *Yamato* will be removed from service for conversion to this configuration as soon as *Musashi* or *Shinano* are completed and join the fleet.

---

### **ULYSSES CLASS SPECIFICATIONS:**

Length:	549 m
Beam:	185 m
Draft:	79 m
Displacement:	850,000 GMT
Crew:	925 (+80 Marines)
Range:	20 years at L.Y.V.
Cruising speed:	warp 9
Maximum speed:	warp 14
Armament:	16 phasers (5 banks of 2 plus 6 single mounts) 6 photon torpedo tubes (4 forward, 2 aft)

---

### **MISSOURI CLASS SPECIFICATIONS:**

Length:	793 m
Beam:	238 m
Draft:	79.3 m
Displacement:	2,150,000 GMT
Crew:	1100 (+90 Marines)
Range:	20 years at L.Y.V.
Cruising speed:	warp 8
Maximum speed:	warp 12
Armament:	18 phasers (5 banks of 2 plus 8 single mounts) 10 photon torpedo tubes (6 forward, 4 aft)

---

### **YAMATO CLASS SPECIFICATIONS:**

Length:	854 m
Beam:	238 m
Draft:	82.6 m
Displacement:	1,870,000 GMT
Crew:	1,200 (+90 Marines)
Range:	25 years at L.Y.V.
Armament:	26 phasers (10 banks of 2 plus 6 single mounts) 2 megaphasers (forward firing arcs) 6 photon torpedo tubes
Cruising speed:	warp 15
Maximum speed:	warp 20

---



**SCHEMATICS (APPROXIMATE SCALE):**



*Star League* class dreadnought



*Excelsior* class space control ship

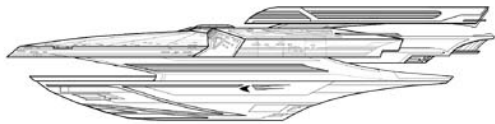

*Missouri* class dreadnought



*Yamato* class super dreadnought



An early conceptual rendering of *Yamato*, bearing a different hull registry number than the one actually assigned.

**SYDNEY CLASS TRANSPORT**

**SERVICE ENTRY DATE (OLD CALENDAR): 2277**



In late 2272 the Starship Design Bureau requested bids for a linear warp powered medium transport with cargo-carrying capabilities between that of the older *Independence* and *Sherman* classes. Starfleet Command was opting for a single Class II auxiliary transport design this time around in light of the tremendous costs of the Class I linear warp program. Shintoi Heavy Industries of Alpha III won the contract with the *Sydney* class. Its interior was dominated by no less than six holds, one of which was a dedicated cargo hold and the other five reconfigurable to the buyer's specifications. So far 79 *Sydney* class transports have been purchased for Starfleet in seven different base configurations: general transport, colony and base supply, hospital ship, auxiliary command ship, repair ship, diplomatic courier and Marine transport. Over 100 have been purchased or are on order by the Merchant Marine and some three dozen are destined for private ownership. Shintoi marketing executives are confidently predicting that the *Sydney* will become the most popular transport starship of its time.

**SPECIFICATIONS:**

Length:	235.3 m
Beam:	120.8 m
Draft:	51.1 m
Displacement:	170,500 DWT
Crew:	between 45 and 85 depending on configuration
Range:	5 light-years at L.Y.V.
Armament ...	2 phasers (2 banks of 1, fittings for 4 more)
Cruising speed:	..... warp 6
Maximum speed:	..... warp 12

**SCHEMATIC:**

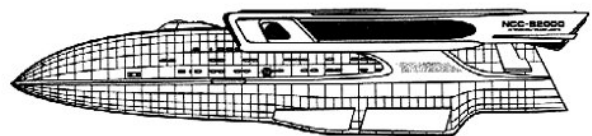

# ***EXCELSIOR* CLASS**

## **SPACE CONTROL SHIP**

**SERVICE ENTRY DATE (OLD CALENDAR): 2288**



It was called “the Great Experiment.” It was meant to be the herald of a new generation of starships, just as *Baton Rouge* and *Constitution* had done in their day. The space control ship program was to be the largest and most powerful Federation starship of its time, fitted with the latest technological advances and capable of speeds and deeds of daring previously thought impossible. On most of these points, *Excelsior* and her descendants largely succeeded.

*Excelsior* might not have ever come about had it not been for two things. The first was the Klingons. Every time the Federation produced a new starship class, the Klingons would do their best to produce a more powerful one. When the Federation surpassed that one they would try to leapfrog them again. This went on from first contact until 2278, when the Klingons introduced the *K'herr* class dreadnought. This monster of a starship easily outclassed an upgraded *Federation*, and Starfleet Intelligence was reporting that an even larger Klingon starship class (*Kar'hammer*) was on the way. This was reason enough for *Excelsior*, but it was not the only one. The second was the Galactic Barrier. Data from the visits by the *Enterprise* to the Galactic Barrier, the first in 2259 and the second in 2262, indicated that starship engines of massive power were required to safely penetrate it for extragalactic travel. Outside observation of the Kelvan modifications to the *Enterprise* engines in 2262 (which they afterwards removed without providing any documentation of the efforts) indicated that a combination of transwarp speed and high energy shielding would be necessary in order to avoid the Barrier's deadly psionic effects. Research into duplicating the work of the Kelvans led to the development of transwarp drive theory in the early 2270s. Transwarp would be necessary for any starship attempting extragalactic exploration, something for which Starfleet was definitely planning once current political issues (i.e. the constant threat of war from the Klingons) were resolved. This development also dovetailed nicely with the efforts to design a starship superior to Klingon efforts. The massive power requirements necessary for transwarp travel would also provide ample energy for weapons and shielding systems.

In 2274 Starfleet began accepting bids for the space control ship program. The specifications were straightforward: an upsized Jeffries/Josephs configuration with dreadnought firepower and room for 30 shuttlecraft, capable of self-sufficient operations for up to 10 standard years and deriving both ship's power and main propulsion via transwarp engine technology. By 2283 there was only one designs still in the running, and a single full-scale prototype was authorized for construction.

*Excelsior* (NX-2000) was built by the Sol System's famed Utopia Planitia Orbital Shipyards. It was named for a recently lost Class I heavy cruiser and utilized Cochrane/Leeding FTWA-1 transwarp engines. The prototype was finished by 2285 and extensively tested for the following year. It performed admirably save in one area, and in this area it failed miserably. So blatant was this failure that it would bring about the permanent end of Starfleet sponsorship for transwarp drive research.

It has often been said that the initial failures of “the Great Experiment” were due to its transwarp drive. This is not exactly true. The problem was in transwarp theory itself and the control systems designed to implement it. Starfleet engineers had been unable to duplicate the Kelvan modifications, so they did the next best thing: they sought a way to create a controlled wormhole. The effects of wormholes on faster-than-light travel, especially with regards to starship warp engine imbalances, were well known. The idea behind transwarp was to create a controlled wormhole in front of a starship, an artificial subspace channel as opposed to a normal subspace warp field, that would literally suck a starship inside and propel it forward at sustained speeds in excess of warp 20. Crossing the Great Barrier would pose no problem to a transwarp starship because it would literally punch its way through, flying through a controlled wormhole so fast that there wouldn't be time for the Barrier's psionic variances to begin affecting its crew. That was the theory, anyway. What happened in practice was that transwarp control systems proved virtually incapable of managing the wormhole once it was generated. *Excelsior* repeatedly went out of control during transwarp tests and had to resort to the old-fashioned method of shutting down its warp drives in order to stop their wormholes. The most dramatic of these failures occurred on 9 July 2287. *Excelsior*, having had its transwarp drive and control systems rebuilt for the third time, simply disappeared on its fourth and what would prove to be its final transwarp test flight. A frantic search by every Starfleet and civilian vessel in and around the Local Group yielded nothing. Two weeks later, the *Excelsior* suddenly reappeared just outside the Sol System in the exact same spot where she had disappeared, completely drained of all power and running off of emergency batteries. The reconfigured transwarp control system combined with the power of *Excelsior's* engines had done more than create a wormhole. It had apparently created a breach in the local space-time continuum through which the ship had fallen through. *Excelsior* had become trapped in the limbo between universes until Captain Raymond Styles and his crew had regenerated enough ship's power to affect a safe return. None of them, including Captian Styles, expressed a desire to

stay on a starship that the more existential among them were now beginning to call cursed, and they were soon transferred to other duty stations. It was at that point that Starfleet Command stepped in and terminated the transwarp program for good.

The loss of transwarp did not condemn the space control ship program, however. *Excelsior* was quickly stripped of its transwarp control systems and ones used for standard linear warp drive were adapted for use with its unique warp engines. There was method behind Starfleet Command's apparent madness. The *Excelsior* program had already authorized by the Military Staff Committee despite the transwarp issue, and the keels for two additional *Excelsior* class vessels (*Columbia* and *Galacta*) were already being laid. The growing threat of the Klingon shipbuilding program had forced the rapid acceptance of the space control ship program, problems or no. Transwarp technology was not necessary in dealing with the Klingon's new dreadnoughts. Starfleet needed the *Excelsior* and needed it now, before the Klingons started using their new *K'herr* class for more than just propagandist stunts. Political realities, in this instance, saved a starship class from extinction instead of condemning it as it had so many times before.

The overall excellence of the modified *Excelsior* design has quickly proven itself in any task upon which it is called. So successful has it become, in spite of its early pre-service failures, that many are already calling it "the new *Constitution*" of the fleet. Starfleet Command, to its credit, has always seen the *Excelsior* in this light, playing the role of a new and larger heavy cruiser in a new fleet of starships that it has since dubbed "the *Excelsior* generation." A number of spin-off designs have already appeared, inspired by exiting Class I Program vessels, and some have even won tentative approval for construction. It appears that *Excelsior* may very well join *Baton Rouge* and *Constitution* in becoming the defining starship design of its era.

There exists a third variation of the basic space control ship platform. *U.S.S. Enterprise* (NCC-1701-B), named after her *Constitution* class ancestor, entered service in 2293 as the first of the so-called "modified *Excelsiors*." This configuration includes the addition of two extra hangar bays to the primary hull saucer, upgraded Cochrane/Leeding FESW-2 warp engines, and a set of bulges for additional sensor systems on either side of its secondary hull. Weaponry and shielding systems are also improved, making this new *Enterprise* the most powerful starship in all of Starfleet as of this date.

**VISUALS:**



*Excelsior* (NX-2000) in prototype configuration (2286)



*Enterprise* (NCC-1701-B) as she appears today (2295)

**SPECIFICATIONS:**

Length:	453.1 m (standard) 467.0 m (modified)
Beam:	185.0 m
Draft:	79.1 m
Displacement:	386,500 DWT (standard) 511,250 DWT (modified)
Crew:	780 (including 50 Marines and 20 shuttle pilots)
Range:	15 light-years at L.Y.V.
Armament:	24 phasers (standard - 12 banks of 2) 30 phasers (modified - 7 banks of 2 plus 16 single banks) 4 photon torpedo tubes (2 each fore and aft)

Cruising speed: ..... warp 15  
Maximum speed: ..... warp 20

NOTES: Modified listings are for the *Enterprise* variant (NCC-1701-B).

The change in mass for the modified version represents the addition of the secondary hull bulges as well as the dual auxiliary hangars to the aft section of the primary hull.

The 780 listed for *Excelsior* class starships crews is an average figure. Thus can range anywhere in size from 530 to 875 depending on mission parameters. This includes deployment of Marine troops and support personnel as well as combat shuttle pilots and maintenance crews.



**SCHEMATICS:**

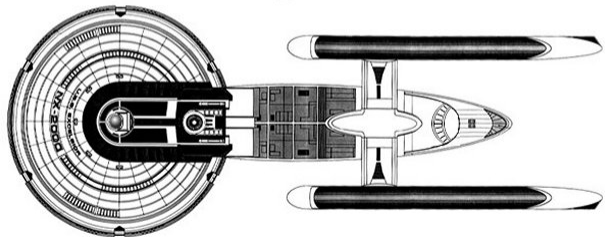
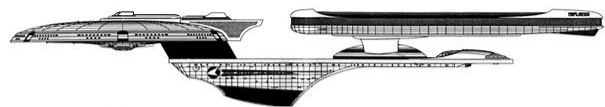

*U.S.S. Excelsior (NCC-2000)*

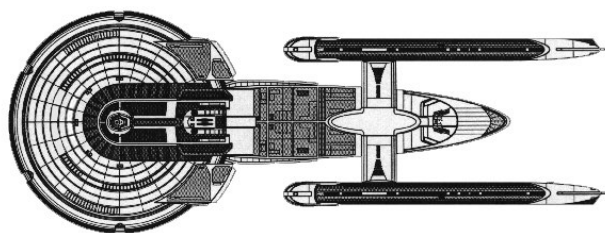
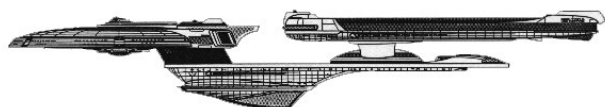

*U.S.S. Enterprise (NCC-1701-B)*



*Enterprise-B (NCC-1701-B) in orbit above Terra*



*Excelsior (NCC-2000) greets a planetary dawn*



*A modified Excelsior on a deep space probe ...*



*... while another searches a planetary ring for pirates*

# MIDWAY CLASS SHUTTLECARRIER

**SERVICE ENTRY DATE (OLD CALENDAR): 2289**

*Midway* is based on the unbuilt *Napoleon* class fleet carrier of the 2260s. It was intended to offer the operational versatility of a Class I heavy cruiser yet at the same time be capable of operating multiple combat shuttlecraft squadrons. It also sports the same C3 suite as a dreadnought, permitting it to operate as fleet flagships in the event a command cruiser, dreadnought, or space control ship is unavailable.

*Midway's* armament is almost identical in both arrangement and power to that of an *Enterprise* class heavy cruiser, albeit uprated to dreadnought standards. This represents a major departure from past shuttlecarrier practice. The "wall of fire" concept behind older armament scheme has not performed in practice as well as in theory, with enemy combat shuttles simply retreating beyond range. This allowed the heavy weapons of their carrier or fleet support ships to do their dirty work for them before they swooped in to deliver the final *coup de grace*. The addition of self-contained heavy weapons capability, in the form of dual photon torpedo tubes, also makes *Midway* the operational equivalent (or superior) of its Klingon and Romulan contemporaries, thus allowing it to go toe-to-toe with any foe while their fighters battle among themselves. The design's main drawback is its shuttle bay arrangement, with split launch and retrieval flight decks. Many critics of the *Midway* point out that the lack of a proper through-deck design sets *Midway* up for the same kind of combat catastrophe that befell earlier Federation shuttlecarriers in combat during the Four Years War.

*Midway's* unique LN-80 warp engines are a somewhat smaller variant of the LN-70 developed for *Yamato*. Four of them are mounted in stacked pairs of two. The configuration was inspired by the *Cheetah* prototype fast cruiser. These make *Midway* almost as fast as *Excelsior* without having to resort to the use of costly FTWA-1 warp engines and provides superior warp performance and maneuverability to the layout employed on *Yamato*. These also give *Midway* both the speed and range to play a vital part in current and future fleet battle group operations.

Ten *Midway* class shuttlecarriers were initially authorized for construction in 2286. *Midway* (NCC-2200) and *Akagi* (NCC-2201) were the first to enter service in 2289 and 2291 respectively. *Ark Royal* (NCC-2202) entered service in 2293. *Illustrious* (NCC-2204) is named after Starfleet's very first shuttlecarrier (post Romulan War era) and is scheduled to enter service next year. Completion of *Nchtari* (NCC-2203) is on hold pending program review under the Starfleet Reorganization Order of 2295.

## VISUALS:



## SPECIFICATIONS:

Length:	626 m
Beam:	253.8 m
Draft:	91.3 m
Displacement:	1,053,600 DWT
Crew:	700 (plus 70 pilots)
Range:	20 light-years at L.Y.V.
Armament:	26 phasers (13 banks of 2 each) 2 photon torpedo tubes (both forward) 52 combat shuttlecraft (24 fighter, 24 attack, 4 ELINT)
Cruising speed:	warp 8
Maximum speed:	warp 16



# CONSTELLATION CLASS STAR CRUISER (EXPLORER)

**SERVICE ENTRY DATE (OLD CALENDAR): 2299 (est.)**



Starfleet's newest class of starship came about in the late 2280s as a natural outgrowth of the *Cheetah* fast cruiser prototype program. The idea was to create a high speed superscout starship capable of extended duration missions deep into uncharted space. The Starship Design Bureau reworked *Cheetah* into a long range survey cruiser, almost doubling the ship's internal volume by "pancaking" two extra decks into a modern Class I primary hull and adding two extra outer "rings" for additional support facilities, such as shuttle bays and extra science labs. The new hull form factor was promptly dubbed the "laminated hull" due to these extra layers. External hull blisters and fairings were added to help house the largest sensor and scanner suite ever intended for fitting onto a Class I starship. A full range of weaponry equivalent to that of a Class I command cruiser was also provided, ostensibly for defensive purposes. This would allow this new starship class to cope with any unknown and potentially hostile situations that might arise when deployed at extreme distances from any potential Starfleet support.

The new design is named *Constellation* after the famous Class I Program prototype heavy cruiser lost in 2262. The new "*Connie*" mounts four linear warp engines as does the *Midway* class shuttlecarrier. Its arrangement is different, eschewing the *Midway* dual-stack design following the *Cheetah's* inverted double-T. Dual impulse decks are included in part for mission redundancy and in part to the design requirements of the laminated hull configuration. *Constellation* will also enter service fitted with dual photon torpedo decks, one each nestled at both of the T-junctures for each warp engine pylon. Its multiple shuttle bays will allow it to carry up to 26 small craft of various types, each having access to a specific range of science facilities for improved EVA mission support.

*Constellation* is expected to enter service in 2299. As proposed it should have had the hull number NCC-1017-A in keeping with newly authorized Starfleet naming conventions. A registry of NCC-1974 had already been requested and approved by Starfleet Division's Aiken Facility on Luna for the new starship long before a name was given to the vessel. Starfleet offered to change the registry as a favor to the *Constellation* chapter of the Starfleet Association but the group declined, stating its preference to keep unique the hull number of the original *Connie*. Per its request Starfleet has permanently "retired" the registry of NCC-1017 from use by any future starships named *Constellation*.

## SPECIFICATIONS:

Length:	315 m
Beam:	168.1 m
Draft:	85.2 m
Displacement:	208,750 DWT
Crew:	530
Range:	25 light-years at L.Y.V.
Armament:	16 phasers (6 banks of 2 plus 4 single mounts)
	4 photon torpedo tubes (2 forward banks of 2)
Cruising speed:	warp 7
Maximum speed:	warp 11

## SCHEMATICS:

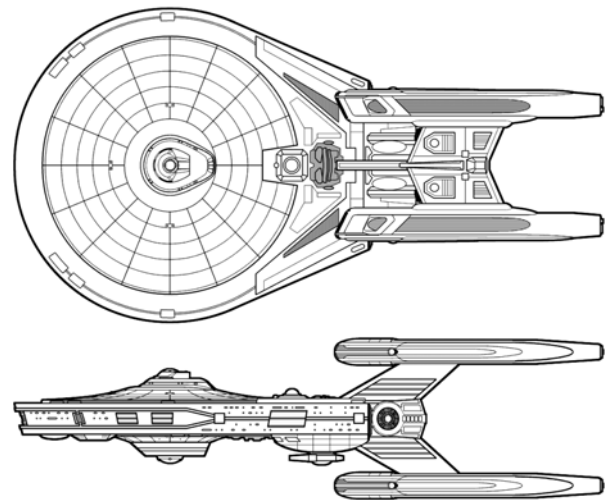

# ALIEN STARSHIPS

## W-1 SPARROWHAWK

(ROMULAN DESIGNATION *SAFRAM* – “SENATOR”)

SERVICE ENTRY DATE (ESTIMATED): 2276

DATE FIRST SIGHTED BY FEDERATION: 2280



In 2280 Starfleet Intelligence is said, according to one amusing report, to have “crapped in its collective pants” once it received its first solid intelligence about the *Sparrowhawk*. The report came from a starship spotter in the Triangle who had observed what was at first thought to be a typical row between Klingon and Romulan fleet elements – the type usually provoked when one side or the other wanted to test a new starship. When the fighting stopped only the Romulan ships remained; however, their lead ship was unlike anything that had ever been seen. This one ship, according to the report, had engaged three Klingon *K'tinga* class battlecruisers simultaneously and wound up destroying them all within minutes. Thus did the *Sparrowhawk*, lead ship of the Hawk Generation of Romulan starships, make its grand debut.

The *Sparrowhawk* is undisputably the best and most versatile light cruiser ever built by any of the major interstellar powers in modern times. In fact the term “light cruiser” is something of a misnomer, since it actually classes closer to a true cruiser in terms of armament and capabilities. It is as multi-mission capable as the best Starfleet vessels and its hull is specifically designed for adaptability. At least two dozen different versions of the *Sparrowhawk* exist, ranging from scout to commando cruiser and all the way through to heavily armed transport/tug. What makes a *Sparrowhawk* truly frightening, though, are two things. First, its new-generation cloaking device, which so thoroughly hides it from detection that only a tachyon net can find it. Second is its revolutionary new power source. The Romulan *Sparrowhawk* is the first starship ever known to be powered by an artificial quantum singularity. In layman’s terms this means that for the first time in the history of the Romulan Space Navy their starships have the capability to arm and hold plasma weapons (within system limits) while cloaked, enabling them to fire as soon as they come out of cloak. This ability has

already wreaked havoc with Klingon forces in the Triangle, causing Starfleet to rethink almost everything it has come up with to date concerning Romulan battle tactics.

The plasma weaponry on the *Sparrowhawk* also reflects a new approach by the Romulans in dealing with the traditionally long arming times for such systems. *Sparrowhawk* is equipped with one heavy and two light plasma torpedo generator systems. The heavy system packs twice the wallop of older plasma torpedo systems and consequently has a longer arming time. The two light systems take far less time to charge up and have firepower equivalent to the old postwar plasma cannons. Also, an *Sparrowhawk* can hold these new light plasma torpedos indefinitely in their tubes once they are charged even while cloaked, thanks to its artificial singularity power system. Current plasma technology limits the hold time of the heavy system; however, the Romulans are already said to be well on their way to overcoming that particular obstacle.

According to Starfleet Intelligence the lead ship in the *Sparrowhawk* class is named *Safraam*, which roughly translates to *senator*. For this reason it is sometimes referenced as the *Senator* class in certain reference works.

### SPECIFICATIONS:

Length:	366.7 m
Beam:	150.6 m
Draft:	59.4 m
Mass:	175,000 DWT
Crew:	135
Armament:	1 heavy plasma torpedo tube 2 light plasma torpedo tubes 5 standard disruptors 4 point-defense disruptors 1 tricobalt mine rack (*)
Cruising speed:	warp 8.0
Maximum speed:	warp 12.0

(\*) *Sparrowhawks* have been observed dropping tricobalt mines out of a fantail port to discourage pursuers. This is believed to be a multi-purpose rack that could also be fitted for drones or other similar weaponry.

#### Innovations:

- First post-treaty (S'marba) Romulan starship class













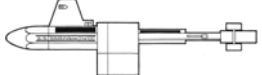
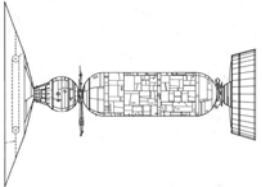
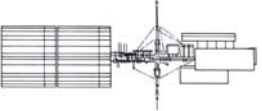
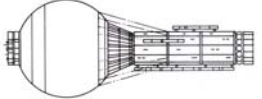
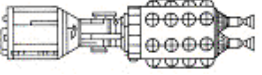
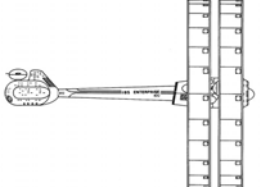
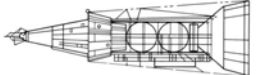

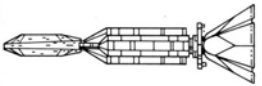

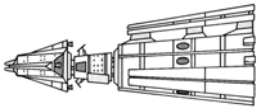
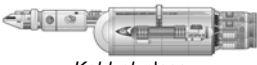
"Captain's log, stardate 9529.1. This is the final cruise of the starship *Enterprise* under my command. This ship and her history will shortly become the care of another crew. To them and their posterity will we commit our future. They will continue the voyages we have begun and journey to all the undiscovered countries, boldly going where no man, where no one, has gone before."

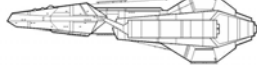
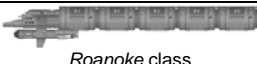
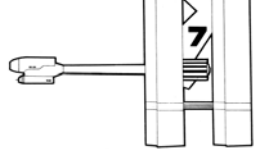
- Captain James T. Kirk (2291)



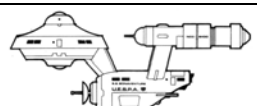



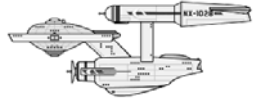

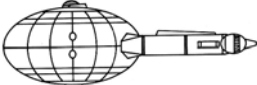
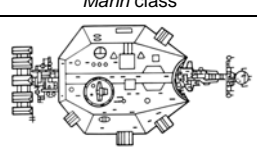

# KEY HISTORICAL STARSHIPS

## 1957-2295 – TERRAN PERSPECTIVE

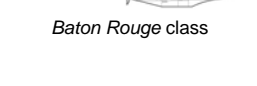
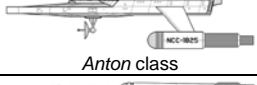
VISUAL	DATE	LENGTH	MASS (DWT)	CREW	PROPULSION	MAX SPEED	KEY FACTS TO REMEMBER
 Apollo (with Saturn V launch vehicle)	1968	110.8 m	3,400	3	chemical rocket	0.13c	First manned vehicle to leave Terran orbit and deliver crew to an off-world location (Luna)
 OV-100 Space Shuttle	1980	37.2 m	68	7	chemical rocket	335 km/h	First reusable Terran spacecraft
 DY-100 (production model)	1990	108 m	27,200	20	Amjet I fusion drive	0.2c	First manned interplanetary commercial Terran spacecraft
 Marilee (typical Bussard ramjet colonization ship)	2010	760 m	162,500	20 (+200 in deep cryo-sleep)	Bussard ramjet	0.13c (est)	Early Terran interplanetary colonizer; had to be accelerated to 0.06c by fusion drive before ramjet could be used; deliberately crashed on Perry's Planet after all crew and colonists disembarked; wreckage used to build colony
 Aventeur class	2018	125 m	28,100	109	Amjet V fusion drive	0.2c	First Terran long-range interplanetary exploration spacecraft
 Galileo class	2028	300 m	48,400 (full load)	98	Space Op fusion drive	0.3c	One of the most popular and long-lived Terran transports of its era
 Companion class	2033	156 m	65,000	20	Space Op fusion drive	0.5c	First UESF warship class
 Declaration class	2038	300 m	52,700	100	CeleSys impulse drive	0.4c	First successful, purpose-built Terran starship (manned interstellar spacecraft)
 Columbus class	2040	120 m	8,600	40	Singh-Newton spiked antimatter	0.75c	First Terran starship class to reach another inhabited planet; first with spiked antimatter engines
 DY-X	2057	167 m	23,000	94	Kashishowa CDP "jump drive"	0.65c (+12sec warp 1.2 jumps)	Best all-around UESF starship of the Earth-Kzin Wars; first Terran starship designed for faster-than-light travel
 Bonaventure (Cochrane class, as built)	2060	206 m	19,400	45	Cochrane first-generation warp drive	warp 2	First production Terran starship to maintain a cruising velocity in excess of the speed of light; first starship fitted with Cochrane warp drive

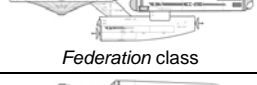
<b>VISUAL</b>	<b>DATE</b>	<b>LENGTH</b>	<b>MASS (DWT)</b>	<b>CREW</b>	<b>PROPULSION</b>	<b>MAX SPEED</b>	<b>KEY FACTS TO REMEMBER</b>
 <i>Verne class</i>	2064	235.9 m	25,000	112	Korngold-McHale first-generation warp drive	warp 2.5	First Terran starship to reach a non-human inhabited world; first starship with three warp engines
 <i>Keldysh class</i>	2064	97 m	16,500	80	United Space Systems first-generation warp drive	warp 2.1	First Terran explorer class starship; first Terran vessel to encounter the Galactic Barrier; first starship jointly designed by cultures from different worlds (Terra and Alpha Centauri IV)
 <i>Conestoga class</i>	2069	197.2 m	23,800	25 (+200)	Westinghouse 4W900 first-generation warp drive	warp 2.0	First Terran colonizer equipped with warp drive
 <i>Messier class</i>	2078	258 m	27,700	183	first-generation warp drive	warp 2.9	First Terran starship with non-human crew members; oldest UESF warship class to serve in the Romulan War
 <i>Roanoke class</i>	2105	76.2 (unladen)	19,400 (unladen)	20	GSC-1400 first-generation warp drive	warp 2.2	First of the Class J cargo ships
 <i>Prometheus class (ringship)</i>	2105	320 m	57,500	115	CeleSys-Cochrane toroidal warp drive	warp 3.2	Last major Terran ringship class produced prior to the Romulan War
 <i>Cavalry class</i>	2141	130 m	14,900	80	Cochrane S66D warp drive	warp 3.1	Second warship class of the Federation Star Fleet; direct ancestor of the Class I destroyer and scout designs
 <i>Horizon class</i>	2146	280 m	38,500	224	second generation warp drive	warp 3.25	First exploratory starship class of the Federation Star Fleet
 <i>Armstrong class</i>	2146	207 m	38,000	175	Cochrane PB-1	warp 3.6	First joint Terran-Centaurean-Andorian starship; direct ancestor of the <i>Loknar</i> class frigate (NOTE: takes place of NX-Program <i>Enterprise</i> in Prime One timeline)
 <i>Jeffries Project prototype</i>	2155	50 m	8,750	14	Shuunvijalis RV-260 warp drive	warp 3.8	Direct ancestor of the <i>Baton Rouge</i> and <i>Constitution</i> class starships
 <i>Marshall class</i>	2157	225 m	22,700	157	Westinghouse SEMT warp drive	warp 3.8	First starship class fitted with force field screens; best known Federation Star Fleet class from the Romulan war
 <i>Daedalus class</i>	2158	114.5 m	27,500	120	Cochrane PB-2 "Quantum"	warp 3.9	First starship class built using data gleaned from the Jeffries Project
 <i>Olympus class</i>	2158	182.2 m	411,300	806	warp drive	warp 3.5	Typical CS-series starship (aka "cylinder ship") from the Romulan War era; the largest Federation starship in terms of mass tonnage produced during this era
 <i>Bonaventure rebuild</i>	2165	198 m	115,000	190	Cochrane PB-6 "Quantum II"	warp 3.9	First time an existing starship was broken down and rewoven into a new type of vessel; first full-blown Federation starship to employ a disc-like primary hull

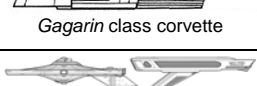
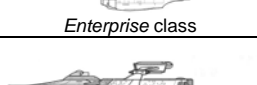

VISUAL	DATE	LENGTH	MASS (DWT)	CREW	PROPULSION	MAX SPEED	KEY FACTS TO REMEMBER
 Texas class	2175	189.9 m	112,000	140	Cochrane PB-8 "Quantum III"	warp 3.6	Last production Federation starship fitted with ablative armor; longest-serving starship class as of this date (110 years)
 Tritium class	2188	202 m	476,000	250	Cochrane PB-8 "Quantum III" (modified)	warp 3.6	Most expensive failure in Federation starship history
 Mann class	2192	185 m	54,000	294	Vickers J27-A	warp 4.5	First Federation starship to break the Warp 4 barrier for sustained FTL cruising speeds; first with 1:1 matter/antimatter mix ratio for its warp engines; first fitted with dual purpose deflector/sensor grid on hull
 Illustrious class	2198	1200 m	1,989,000	600	multiple Cochrane PB-10E "Klepton"	warp 3.5	First (and still largest) shuttlecarrier in Federation history
 Baton Rouge class	2205	245 m	92,500	344	Kloratis VX-28 "Pegasys"	warp 5.2	First major Federation warship build program since the end of the Romulan War; first starship class with a true disc-shaped primary hull; first starship class built using modular component construction techniques; first starship class fitted with transporter technology and duotronic computer systems; lead starship class of its generation
 Anton class	2210	185 m	146,500	290	Kloratis VX-28 "Pegasys"	warp 4.8	First Federation starship with "modular hull;" direct ancestor of the <i>Surya</i> , <i>Coventry</i> , <i>Miranda</i> , and <i>Avenger</i> classes
 Constitution class	2222	290 m	190,000	430	Cochrane PB-18 "Perth"	warp 8	First starship class of the Class I program; most famous and recognizable starship class in Federation history
 Federation class	2255	320 m	285,000	500	Cochrane PB-47 "Titiac II"	warp 10	First stable tri-nacelled starship design in Federation history; first starship with a warp-capable primary hull after emergency separation; most powerful Federation warship of its time
 Endeavour prototype	2260	279.5 m	175,000	430	Leeding (Cochrane) LN-40	warp 10	One of the first Federation linear warp technology testbeds (along with the scout <i>Monoceros</i> and the tug <i>Keppler</i> )
 Gagarin class corvette	2266	120 m	22,500	24	Kloratis (Cochrane) FWB	warp 7.6	First multimission auxiliary starship class, with many variations developed for a variety of purposes from the base <i>Gagarin</i> design
 Enterprise class	2267	304.8 m	210,000	500	Leeding (Cochrane) LN-62	warp 12	First in-service starship conversion of the linear warp generation; lead ship for the linear warp upgrade and building programs of the 2270s and 2280s
 Avenger (uprated <i>Miranda</i> )	2275	234.0	180,000	395	Leeding (Cochrane) LN-62	warp 12	Linear warp upgrade of earlier <i>Miranda</i> class (an <i>Anton</i> descendant); first starship class fitted with megaphaser cannon; only starship class in service to rival <i>Constitution/Enterprise</i> in terms of mission capability and design flexibility
 Excelsior class	2288	511.3	386,500	780	Leeding (Cochrane) FTWA-1	warp 20	Testbed for (unsuccessful) transwarp program; first Federation "superheavy" starship class, lead ship of its generation of starship designs

# ACKNOWLEDGEMENTS

## FIRST EDITION – COMPILATION VERSION

---

### SPECIAL THANKS TO:

---

Jason Bogue  
Eric “Jackill” Kristiansen  
Neale Davidson  
Aerian Ferro  
Bernard Guignand  
Jan Hendrik Kobarg  
Timo Saloniemi  
Aridas Sofia

### ADDITIONAL THANKS TO:

---

Amarillo Design Bureau  
Manny Coto  
Curt Danhauser  
James Dixon  
Diane Duane and Peter Norwood  
Doug Drexler  
Encyclopedia Astronautica  
FASA Corporation  
Fox Entertainment  
Alan Dean Foster  
Stan and Fred Goldstein  
Todd Guenther  
Greg Jein  
Shane Johnson  
Walter Irwin and G.B. Love  
ITC Entertainment  
Court Jones  
Geoffery Mandel  
Sandra Marshak and Myrna Culbreath  
Memory Alpha and Memory Beta  
Mike and Denise Okuda  
National Aeronautics and Space Administration  
Larry Niven  
New Eye Studio  
Paramount Pictures  
Alexander Rosenzweig  
David Schmidt  
Bernd Schnieder (Ex Astris Scienta)  
The Starship Schematic Database  
The TrekBBS  
The United States Armed Forces  
Universal Pictures  
Wikipedia

### FICTIONAL STARSHIP DESIGNERS/SOURCES (BY ALPHA):

---

Activision Games  
*Missouri* and *Yamato* class battleships  
*Midway* class shuttlecarrier  
(from the *Klingon Academy* and *Starfleet Command* series of computer videogames)

Atolm  
Kzinti destroyer  
(an original design created by request)

Steve Baron  
*Patton* class destroyer  
(modified from Rick Sternbach’s *Marshall*)

Julian Bolinger  
*Fa-Xian* class explorer  
(an original design created for FASA’s *STAR TREK: The Role-Playing Game*)

Forrest Brown and Dana Knutson  
*Cavalry* class destroyer  
*Armstrong* class heavy cruiser  
*Djartanna* class Centaurean destroyer  
*Degbraxis* class Tellarite “free trader”  
*Anton* class cruiser  
*Larson* class destroyer  
*Nelson* class scout  
*Loknar* class frigate  
*Lotus Flower* class transport  
(from assorted materials created for *STAR TREK: The Role-Playing Game* by FASA Corporation; certain data modified to conform with the *STAR TREK RPG* by Decipher/Last Unicorn Games; selected materials later modified for use on screen as broadcast in *STAR TREK: The Next Generation*)

David Carson (with the staff of Industrial Light & Magic)  
*Oberth* class research ship  
(as first depicted on screen in *STAR TREK III: The Search for Spock*)

Wah Ming Chang  
*Romulan Warbird*  
(from the original *STAR TREK* TV series; additional notes and designations by Masao Osasaki for the Starfleet Museum website)  
*Aurora* class space cruiser  
(from the original *STAR TREK* TV series, with additional data courtesy of Michael McMaster’s fandom blueprints)

Christanson, Don

*Sherman* class cargo drone

(from the animated *STAR TREK* series episode "More Tribbles, More Troubles," with additional data suggested by the fandom efforts of Geoffery Mandel, Doug Drexler, Todd Guenther, and Aridas Sofia)

Cochrane Industries Mark IV one-man scout

(from the animated *STAR TREK* series episode "Mudd's Passion," with additional data suggested by the fandom efforts of Geoffery Mandel and Doug Drexler – the ship is only visible for a brief moment in the *Enterprise* hangar bay and is largely obscured; however, Filmatation provided two excellent line drawings of the ship in full to Bjo Trimble for her *Star Trek Concordance*, and these were the basis for Mandel and Drexler's fandom material)

*S.S. Bonaventure*

*Bering* class automated tanker

*Hopi* class science vessel

(from the animated *STAR TREK* series episode "The Time Trap," with additional data courtesy of Neale Davidson's, Aridas Sofia's, and Federation Frontiers' fandom efforts)

*Independence* class transport

(from the animated *STAR TREK* series episode "The Pirates of Orion," with additional data suggested by the fandom efforts of Geoffery Mandel, Doug Drexler, Todd Guenther, and Aridas Sofia)

Stephen V. Cole and the Amarillo Design Bureau Staff

*Texas* class light cruiser

*Kearsarge* class "war" cruiser

Romulan *Sparrowhawk* light cruiser

(from the *Star Fleet Battles* wargame simulation, which served as the basis for Activision's *Starfleet Command* series of videogames; selected background data modified due to timeline differences)

Neale Davidson (Pixel Sagas)

Many *Baton Rouge* generation derivative designs

(Neale's fandom efforts are based on the prior efforts of several others, including Franz Joseph Schnaubelt, Masao Osasaki, Stephen V. Cole, and more; however, he deserves the main credit for fleshing out the *Baton Rouge* generation more than any of my other sources, including Sternbach himself)

*Manhattan* class automated transport

(derived from Don Christianson's *Sherman*)

Doug Drexler

*Conestoga* class warp colonizer

*Roanoke* class transport

*Sr'nari* class Vulcan survey cruiser

*Kumari* class Andorian cruiser

(modified from the *Enterprise* TV series; additional information from Timo Saloniemi's *Hobbyist's Guide to the UFP Starfleet*)

Industrial Light and Magic

*Whorfin* class transport

(as seen on screen in the *Enterprise-B* Nexus rescue scenes from *STAR TREK: Generations*)

Walter Matthew Jeffries

*Declaration* and *Prometheus* class starliners

*Daedalus* class survey cruiser

*Ranger* class survey cruiser

(from concept drawings made while developing the original series *Enterprise*)

*Constitution* class heavy cruiser

Klingon battlecruiser (all versions)

DY-100 series spacecraft

(from the original *STAR TREK* TV series)

*Leif Ericsson* "DY-X" class cruiser

(custom design for AMT/Ertl Models, also appears in an unused TAS storyboard per Mike Okuda)

Walter Matthew Jefferies – with Mike Minor, Richard Taylor, Andrew Probert, and Joe Jennings

*Enterprise* and *Tikapai* class heavy cruisers

(as depicted on screen and in preproduction artwork and illustrations for *STAR TREK: The Motion Picture* as well as all *TREK* feature films through to *The Undiscovered Country*; selected additional material suggested by Todd Guenther and Aridas Sofia)

Greg Jein

*S.S. Marco Polo*

(custom model seen in many background shots and used for various purposes in DS9)

*Sydney* class transport

(as featured in the TNG episode "Relics")

Greg Jein and Mike Okuda

Warp 1 testbed

*Keldysh* class explorer

(custom creations for the first edition of the *STAR TREK Encyclopedia*)

Joe Jennings and Mike Minor

*Miranda* class cruiser

(as first depicted on screen in *STAR TREK II: The Wrath of Khan* – the evolution of the pre-TOS *Miranda* is another matter; see notes at bottom of this section)

Eric "Jackill" Kristiansen  
*Pershing* class automated transport  
 (derived from Don Christianson's *Sherman*)  
*Star League* class dreadnought  
 (derived from Franz Joseph Schnaubelt's  
*Federation*)

Paul Lloyd  
 Kzinti patrol cruiser  
*Searcher* class explorer  
 (reversioned from his *Angel's Pencil* and Kzinti  
 cruiser conceptual meshes based on Larry  
 Niven's Kzin short story "The Warriors")

Richard Mandel  
*Mahan* class heavy cruiser  
 (derived from Rick Sternbach's *Companion* class  
 escort from the *Space Flight Chronology*, with  
 additional modifications based on the *Sulaco* from  
*Aliens* and the Omega class destroyer from the  
*Babylon 5* TV series – *Sulaco* visuals used in text  
 due to lack of a proper 3D mesh, my apologies!)

Geoffery Mandel  
 "UESPA *Bonaventure*" galactic survey cruiser  
 (from Mandel's fandom *U.S.S. Enterprise*  
*Officer's Manual*)

Lawrence Miller  
 assorted redrawings and reversionings of many of Rick  
 Sternbach's original *Space Flight Chronology* designs  
 as published in Miller's *Starfleet Tactical Database 2*  
 comparison charts

Michael Morrisette  
 DY-200, 300, and 400 series designs  
 (from his fandom DY-series development chart)

Masao Osasaki  
 All Federation Star Fleet "cylinder ship" designs  
 (reproduced and background stories modified  
 somewhat, by permission, from the Starfleet  
 Museum website)

Franz Joseph Schnaubelt (aka Franz Joseph Designs)  
*Federation* class dreadnought  
*Ptolemy* class transport/tug  
*Saladin* class destroyer  
*Hermes* class scout  
 (from the *Star Fleet Technical Manual*)

Thomas Models  
*Narsh* class Andorian cruiser

"Reverend Trigster"  
 DY-245 series "stretch" transport  
 DY-430 series "oversized DY-500" transport  
 (original fandom designs based on an on-screen  
 reference in the TNG episode "Up the Long  
 Ladder")

Nilos Rodios and Bill George (with John Eaves)  
*Excelsior* (and modified *Excelsior*) class starships  
 (as first seen in *STAR TREK III: The Search For*  
*Spock* and subsequently seen, in both original and  
 modified "B" form, in other *TREK* series and  
 feature films)

David Schmidt and Eric "Jackill" Christiansen  
*Oberth/Gagarin* class derivatives  
 (between these two gentlemen there are enough  
 derivative fandom designs based on *STIII's Oberth*  
 to build their own fleet – you have to consult  
 their respective fandom publications, *Starfleet*  
*Prototype* and *Jackill's Starfleet Reference Series*  
 #3 to sort out who gets credit for what)

Rick Sternbach  
 DY-100 *Copernicus* prototype  
 DY-350 series prototype (aka "Woden class DY-500")  
*Galileo* class transport  
*Ares IV* space probe  
*Companion* class escort  
*Columbus* class escort  
 DY- 550 series spacecraft  
*Magellan* class spaceliner  
*Liberty* class cruiser  
*Cochrane* class cruiser  
*Verne* class survey cruiser  
 Industrial space ark, *Terra* series  
*Franklin* class scout  
*Messier* class cruiser  
*Cosmos* class scout  
*Edison* class cruiser (DY-1000)  
*Vanguard* class transport  
*Horizon* class survey cruiser  
*Gallant* class star fighter  
*Mercury* and *Doppler* class scouts  
*Marshall* class destroyer  
*Goliath* class battlecruiser  
*Boyden* class automated transport  
*Watt* class transport  
*Tritium* class battlecruiser  
 Mobile space refinery  
*Stellarford* class starliner  
*Mann* class survey cruiser  
*Rickenbacker* class transport  
*Lowell* class scout  
 CR594 mobile construction rig  
*Baton Rouge* class cruiser  
*Bode* class scout  
*Provider* class space tug  
 (created for the *Star Trek Space Flight*  
*Chronology* by Stan and Fred Goldstein; selected  
 materials later modified for use on screen as  
 broadcast in *STAR TREK: The Next Generation*;  
 selected materials also modified by Steve Baron  
 and Timo Saloniemi)

Rick Sternbach (cont.)

DY-500 series spacecraft

(as depicted on screen in TNG's "Up the Long Ladder," with additional data and views by Roger Sorensen for the Journal for Applied Trekology)

Rick Sternbach, with Andrew Probert and Greg Jein

*Constellation* class star cruiser

(as first seen on screen in TNG's "The Battle," with additional fandom material suggested by David Schmidt, James Dixon, and Eric "Jackill" Kristiansen)

---

### Notes on the TOS-era *Miranda*

Proper credit for the concept of the TOS-era *Miranda* predecessor depends on who is asked. To be fair, Aridas Sofia deserves credit for being the first with the concept with his fandom *Surya* class frigate design. Evan Mayerlie's fandom *Coventry* came next, and was actually the closest (in fandom terms) of matching a TOS-era *Miranda* design. Around the same time came Brown and Knutson's *Anton* for the FASA RPG (which was actually too big to be a true *Miranda* predecessor). If you backtrack the publication dates, though, the evidence is clear that Sofia was first with the *Surya*, which was included as an extra on the last sheet of Todd Guenther's *Wrath of Khan* era *Avenger Class Blueprints*. Be that as it may, the Keepers of the Franchise refuse to acknowledge either the *Surya* or *Coventry* as legitimate despite widespread fandom acceptance and popularity. Therefore credit for the first "licensed" TOS-era *Miranda* predecessor goes to Dan Abnett, Ian Edgington, and Patrick Zircher of Marvel Comics. Their *U.S.S. Cortez* featured prominently in the Marvel *Early Voyages* storyline "Cloak and Dagger." Let me be clear, however, that I am drawing a distinction between who was first with a design as opposed to who was first with a *licensed* design. The Franchise is known to be picky on those points.

One final wrench to throw in the works. Rick Sternbach has been quoted on several *TREK*-affiliated web sites as saying that a TOS-era *Miranda* doesn't exist as far as he's concerned. That may be why the excellent fandom blueprint set by Federation Frontiers also discounts the notion of a TOS-era *Miranda* in its backstory.

## **VISUALS SOURCES:**

---

Part 1 – 1900-2000: The Saga Begins

*Aviation Week and Space Technology*

Dr. Richard Hoagland and the Enterprise Institute  
National Aeronautics and Space Administration

The National Archives

OrbiterMods

Paramount Pictures

The United States Armed Forces Archives

Part 2 – 2001-2025: Breaking the Bonds of Sol

Jeff Bateman

Joe Bergeron

Chris Butler

Michael Carrell

Don Davis

M. J. Graham

Tom Newsom

Rick Sternbach

Part 3 – 2026-2050: The Road to the Stars

Reimund Bertrams

Baen Books

Erik Holman

Greg Jein

Court Jones

Paul Lloyd

MGM/UA Entertainment

The SpaceArt Archives

The TrekBBS (Warped9 in particular)

Part 4 – 2049-2065: The Earth-Kzin Wars

The ArcBuilder and Celestra web sites

Atolm

Bandai Entertainment

Bastei-Lubbe GmbH

R. J. Bartop

Winchell Chung

Gabriel Cubos

Don Davis

D. T. Ericcson

Maeteen Greenway

Greg Jein

Court Jones

Eric Peterson

Part 5 – 2066-2100: Joining the Local Group

Reimund Bertrams

Dan Carlson

Maeteen Greenway

Greg Jein

Mike Okuda

Nightscape Creations

TallGuy Productions



Part 6 – 2101-2150: The Birth of the Federation

Steve Baron  
DarthMagus  
Don Dixon  
FASA Corporation  
Andrew J. Hodges  
SciFi Meshes  
"Reverend Trigster"  
TallGuy Productions  
The TrekBBS  
The SpaceArt Archives  
Christian Zaber

Part 7 – 2151-2165: War in the Stars

Steve Baron  
Battleclinic.com  
Julian Bolinger  
Agartha Chamberlain  
"DarkDrone"  
FASA Corporation  
Maeteen Greenway  
Adam Heinbuch  
Kevin Mullen  
Phoenix Experimental Shipyards  
Sean Robertson  
Universal Entertainment

Part 8 – 2166-2190: The Difficult Days

3D Starships  
Randy Asplund  
Steve Baron  
Adam Burch  
Var Cauist  
Ted W. Giebel (SFB Nexus)  
David Klein  
Paul Lloyd  
Starship Modeler  
Michael Newlyn  
Sean Robertson  
Allen B. Ury

Part 9 – 2191-2220: A New Direction

3D Gladiators  
Randy Asplund  
Atolm  
Battleclinic.com  
Harry Doddema  
Lauren Oliver (for Starship Modeler)  
Michael Newlyn  
Bernd Schnieder (Ex Astris Scienta)  
The Starship Art website

Part 10 – 2221-2250: The Class I Era

3D Gladiators  
Activision Games  
Atrahasis (OutaLance Shipyards)  
AxeMan 3D  
Michael Bartel  
Battleclinc.com  
W. J. Casmir  
Heath Coop  
Doug Drexler  
D. T. Ericcson  
Lee Fleer  
Ted W. Giebel (SFB Nexus)  
Maeteen Greenway  
Darrell Lawrence  
Cyrille Lefevre  
Chris Martin  
Terry Miesle  
Paramount Pictures  
"The Red Admiral"  
Chris Ricci  
Starship Modeler  
Adam Turner

Part 11 – 2251-2275: The Linear Warp Revolution

Activision Games  
Atrahasis (OutaLance Shipyards)  
W. J. Casmir  
William S. Cullars  
Demon Renegade Studios  
The "Duct Tape Wonder"  
Ted W. Giebel (SFB Nexus)  
Glitchwerk Studios  
Maeteen Greenway  
Andrew J. Hodges  
Industrial Light and Magic  
Rick "Pneunomic81" Knox  
The Light Works  
Chris Martin  
Masao Osasaki  
Paramount Pictures  
The Stress Puppy  
TallGuy Productions  
Adam Turner  
Warped9

Part 12 – 2276-2295: Towards the Future

Activision Games  
Atrahasis (OutaLance Shipyards)  
Demon Renegade Studios  
Andrew J. Hodges  
Jay Hurst  
Brian Minsoh  
Paramount Pictures

