

Guide to the Klingon Fleet

The standard reference guide to the starships of the Klingon Empire



2300-2301

Part of the *Mandel's Fighting Starships* series

Guide to the Klingon Fleet

Selected Starships and Small Craft - 2300-2301

by **Richard E. Mandel**

Manuscript copyright © 2007 by Richard E. Mandel

STAR TREK, its on-screen derivatives, and all associated materials are the property of CBS Paramount. Multiple references in this document are given under the terms of fair use with regard to international copyright and trademark law. This is a free scholarly reference work intended to explain the background and historical aspects of *STAR TREK* and its spacecraft technology and is not sponsored, approved, or authorized by CBS Paramount and its affiliated licensees.

All visual materials included herein are protected by either implied or statutory copyright and are reproduced either with the permission of the copyright holder or under the terms of fair use as defined under current international copyright law.

Mastercom/SFHQ catalog number RS:905802

For Neale ...

Might does not make right. Might makes an empire. Might builds it, solidifies it, reinforces and protects it. Without might no empire can last. It will either fall to its enemies or rot from within.

Might made this Empire. Might will ensure that it lasts. Unless we are willing to bring that might down upon the necks of our enemies, and strike them without mercy, then we are not worthy to wield it. Without the willing and deliberate exercise of our might this Empire will surely fall.

– *Chancellor Kessa*
War Address to the Klingon High Council
prior to the Organian Incursion (2267)

Table of Contents

Preface	
Foreward	
State of the Klingon Fleet	
Klingon Hull Types	
1 Battleships	15
2 Pocket Battleships	16
3 Dreadnoughts	17
4 Shuttlecarriers	18
5 Heavy Cruisers	19
6 Battlecruisers	Fleet Transports
7 Other Cruisers	Fleet Auxiliaries
8 Assault Ships	Selected Shuttlecraft and Small Craft
9 Destroyers	Other Klingon Starship Designs
10 Frigates	The Future of the Klingon Fleet
11 Scouts	
12 Escorts	Appendices
13 Monitors	Klingon Shipyards and Ordinance Manufacturers
14 Patrol Craft	Glossary of Terms
	Afterword

Foreward

This one hundred and sixth edition of *Guide to the Klingon Fleet* comes at a time when its subject matter is in something of a state of flux. In order to match Starfleet's linear warp upgrade program the Klingons have likewise begun to upgrade the rest of their own fleet. Per standard Klingon fleet practice the best of their older ship classes are being upgraded with the latest in technology. At the same several new ship types have been added to the ranks of Klingon forces. The impact of the trade protocols of the Treaty of S'marba continues to make itself felt with certain of these new types, as well as with Klingon fleet operations. The excellent *B'rel* class escort, which was derived in part from a Romulan design, may be the forerunner of a whole new generation of Klingon starship designs to come. All of this and more is designed to match the Federation ship for ship in its recent upsizing of Starfleet, not to mention any other unknown foes along the far borders of Klingon controlled space. At the rate the Klingon fleet is growing this may very well be the last edition of *Guide to the Klingon Fleet* that contains all of its data within a single volume.

Like the preceding volume, *Federation Fleet Review*, the information in this work is organized to enable the reader to quickly locate the data desired. The individual vessel listings (when known) appear in chart form. Included with each listing are its hull number, name, date existence was verified, current status, and any other information peculiar to a given vessel. The reader must bear in mind that all data on Klingon activity is gained second-hand, either through overt or covert intelligence. While we make every effort to be as accurate as possible we are necessarily limited by the amount and quality of Klingon intelligence data that Starfleet has been able to glean in its operations.

We have endeavored to follow the general system of presentation used in *Federation Fleet Review*. **GMT** (gross metric tonnage) is a measure of the actual physical mass of a starship. This is the mass measurement normally used by Starfleet Intelligence. **DWT** (deadweight metric tonnage) measures the mass of a starship in subspace as opposed to its true mass in normal space. Deadweight tonnage is the mass measurement used on an operational basis by Starfleet and likewise in most public and civilian publications. Commentary is provided regarding a specific vessel within a given class. Current status is fairly straightforward. **AUTH.** Is short for

"authorized," indicating a vessel that has been authorized but has not actually begun construction. **BUILDING** indicates a vessel that is under construction. **ACTIVE** indicates a vessel that is in service and has been detected in action within the past year. **LOST** is obvious, with confirmed wreckage from the ship having been spotted or recovered by the Klingons, Starfleet, or some other reputable agency; or for a vessel that the Klingons have admitted that they are unable to locate or find any trace thereof. **SOLD-X** indicates a vessel has been sold and is now in their service of interstellar power "X." Likewise, **CAPT-X** indicates a vessel that has been seized as a war prize and returned to service by interstellar power "X." **???** is for a vessel that was identified but whose current status remains unknown.

Unlike Starfleet vessels, Klingon starships have no distinctive class breakdowns or build group emblem. All hulls bear standard Klingon markings and nomenclature. Recently, though, some differentiation in paint schemes has been spotted. This seems to follow the pattern of the Klingon House that owns or operates the vessel in question. The only time this has happened before in all the history of the Federation's dealing with the Klingon Empire was with several rogue Houses in the years following the Organian Conflict. We have chosen to refrain from duplicating these schemes in this issue due to lack of data. We intend to incorporate this into a future edition or color supplement, once the extent of these new paint schemes and their origins is more fully understood.

Richard E. Mandel

State of the Klingon Fleet

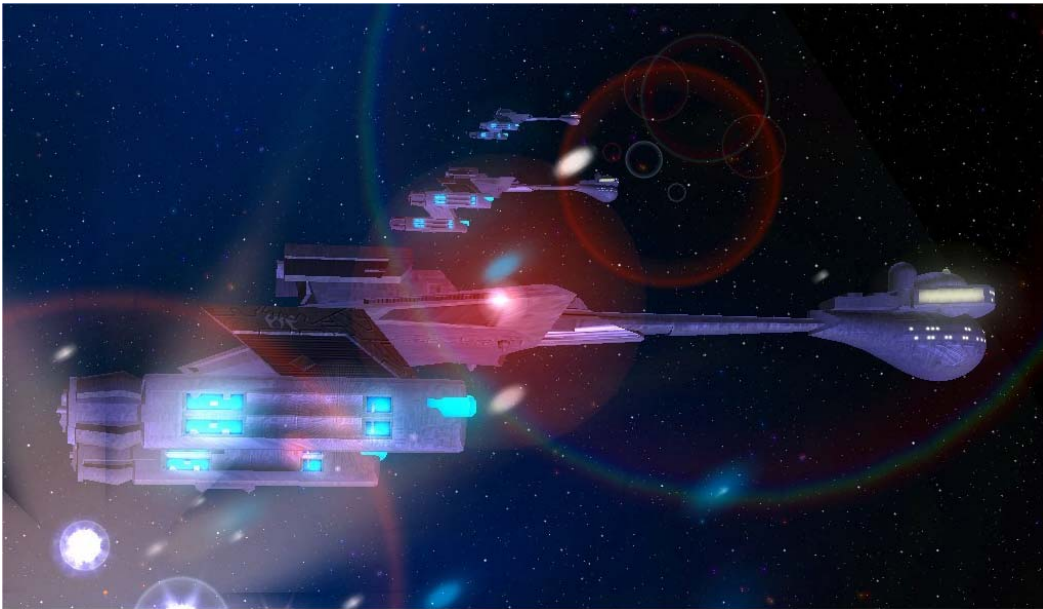

The end of the 23rd century, Terran Gregorian calendar, finds the Klingon Empire still in the process of rebuilding its internal infrastructure from the Praxis explosion of 2293. Seven years have passed since that event, yet the Klingon Imperial Fleet remains hamstrung by its consequences. It has been estimated that the Empire lost 85% of its starship building capacity, 73% of its repair and upgrade capability, and almost 64% of its starship support services infrastructure as a direct result of the Praxis explosion. It is small wonder then that the expansion and modernization of the Klingon fleet, which once set the standard for known space, has all but stopped. Production of new classes is extremely limited due to lack of sufficient yard availability. Likewise, the once-vaunted Klingon starship modernization program has practically slowed to a crawl.

The fault for this state of affairs lies in the deep-rooted tradition of paranoia that has been part of the Klingon psyche for centuries. In the 972th year of Imperial Reckoning (357 BCE), the Klingon home systems were conquered. Their new owners were the *Hur'q'* (tH. "outsider," the

Klingon name for the Karsid), a race of powerful aliens who saw Q'o'nos as yet another trophy in their growing interstellar empire. They slaughtered all Klingons who opposed them and looted Q'o'nos and its sister worlds. They moved on, so one account of the legend goes, only when there was nothing left of value. As those Klingons who survived crawled out of the ruins or returned from the hills, they swore as a culture that such a thing would never again happen to them. Thus was born the Fortress Doctrine that has been a part of Imperial military doctrine ever since the earliest days of the Empire. As the Empire expanded, it fortified its holdings. As new conquests were added, older ones were reinforced. Layer upon reinforced layer was built up over centuries, so that by the 23rd century one might describe the Klingon Empire as a concentric set of armed barriers, each more formidable than the last, until one reached the heaviest armed and most protected defenses located in and around the Klingon home and inner systems. It was a tactic guaranteed to slow, if not eventually stop, any attempt at armed invasion. What it did not foresee, what it could not have anticipated, was that the Empire's fortified heart would be gutted from within by a single, massive stroke of disastrous consequences. Thus the Praxis explosion of 2293 did what no would-be invader since the *Hur'q'* had done: it brought the Klingon Empire to its knees. With the ecosystem of Q'o'nos in shambles, not to mention those of three dozen other major Imperial inner systems; with the heart of its Imperial infrastructure in ruins and its ability to defend itself compromised, it is small wonder that the Klingons acted as they did and turned to the Federation for help. Starfleet had been a deadly enemy, yes, but always an honorable one. The same could not be said of the Empire's many other foes. Peace with the Federation would give the Empire the time it so desperately needed to rebuild, while it committed its remaining resources towards holding its other borders no matter what the cost.

The year 2300 still finds the Imperial Klingon Fleet a force to be reckoned with, with powerful starships of every class and type. The one thing it lacks – indeed, the one thing that always made it the terror of the stars – is the ability to double its numbers within a decade. This capability had always been the burden of the inner system shipyards, which had always proven themselves up to the task. As a consequence, shipbuilding

resources outside of the inner systems were not extensively developed save by civilian trade cartels or the odd House or Imperial naval facility seeking to escape prying eyes. With the loss of its inner systems infrastructure the burden of the Empire's starship production capabilities has now fallen on these rather limited, outer sector second-tier facilities. Less than a half-dozen have the capability to produce major starship classes, and none save the Gnuu Re' Spaceworks can produce them at the pre-Praxis rates of the now-wrecked inner system spaceyards. Even the most optimistic of estimates give the Klingons another decade before they regain a modest one-third of their original capital starship production capacity.

Perhaps it was a fortunate thing for the Empire that the Klingons were arming for a new war with the Federation. That effort had increased the size of the Imperial and House fleets by a combined total of approximately 35% by 2293. While that effort has stopped and all dreams of that war have been abandoned, nevertheless it has left the Klingons with a surplus of starships. This lessens the impact of losing most of its major shipyards at one fell blow. The Empire may not have the capacity to produce such numbers of starships for years to come; however, it has at hand a ready reserve of new vessels to maintain current border fleet numbers. The Khitomer Accords also play a major role in this new Klingon strategy. Peace with the Federation has bought the beleaguered Empire a breathing space for now, provided the Romulans, Tholians, Mirak, or some other major interstellar power do not decide the time is right for a full-scale invasion of the Klingon Empire. Should they make the attempt, however, the Klingons just so happen to be prepared for it – thanks to a planned war with the Federation that fate decreed would never happen.



What has proven to be a disaster for traditional backbone fleet classes, however, has proven to be a blessing in disguise for others. Production of smaller capital ships - most notably frigates, escorts, and patrol ships – has boomed considerably within the past seven years. This is as much acceptance of the current state of affairs as it is making the best of what production facilities are available. Smaller capital ship classes have always been cheaper than larger ones, and every Imperial House (no matter how poor) has at least one production facility devoted to such. Leading the charge, of course, is the ever popular Bird-of-Prey (*B'rel* class escort), which is well on its way to replacing the aging *Kuve* as the standard frigate class of the Empire. Behind it are a half-dozen other such classes, all capable of being produced at facilities outside the Klingon inner systems (and as such largely escaping the effects of the Praxis blast). On these ships, small but numerous, with their ranks constantly expanding, has fallen the brunt of the burden of defending the Empire. Some veteran starship spotters believe that in this effort can be seen the makings of a new Klingon fleet or defense force, no longer bound by Imperial tradition but on the valor and strength of the Houses themselves. Such musings are speculation at best; however, given the pragmatic nature of the Klingons and their penchant for adaptability to even the worst of circumstances. It is probably safe to say that anything is possible.



The Klingon battleship program was brought to a dead standstill by the Praxis Event. Almost all battleship facilities at both Chenwl Duj' and Klinzhai were destroyed save the spacedock holding the partially completed *fuQ'yn hg'Lhi*. Both starship and spacedock were considerably damaged but deemed salvageable, so the Klingon High Command concentrated its remaining battleship program resources into the effort. They even went so far as to dismantle the partially completed battleship dock at Kodai in order to repair the one at Klinzhai. This leaves the Treaty Zone defense complex at Mastocal as the only major Klingon naval facility outside of the Empire's inner systems with a spacedock large enough to accommodate a battleship. This also means that *fuQ'yn hg'Lhi* is currently the only battleship under construction by the Empire. All other battleship classes, including the current *pumwl'* and planned *WoQ'a'*, are on indefinite hold due to lack of production infrastructure.



The end of the 23rd century marks the beginning of a decline in the numbers and classes of *Drell*-type battlecruisers. This design and its many iterations has been the backbone of the Klingon starfleets for decades, possibly centuries. It was perfectly suited for its role of aggressive enforcement of the Empire's borders, as well as front-line vessel in wartime. Four major variations of the basic *Drell* battlecruiser design are still in service (*D'ama*, *Raxor*, *Klolode*, *Ktinga*) as well as a dreadnought variant (*Jul'kar/Kuyper*), a command cruiser (*betleH*), a light cruiser (*Hak'hyI*), and an export cruiser (*Dupat*). *Drell's* influence can also be seen in many other starship designs and classes, ranging from the *K'herr* class dreadnought all the way down to the *Morast* class fleet transport/tug. The simple truth of the matter is that *Drell* is an aging design, despite its excellence, which hit its peak with the *K'tinga* in the 2270s. By that point every major variation, almost every customization, and just about every tweak and twist that could be done with it been done. The Klingon High Council has apparently decided that the time has come to move on. Only one new *Drell*-type is on order (*chetvl'na*) and it is essentially little more than an enlarged *K'tinga*. Experiments such as the *Hega Das* class heavy destroyer, the weapons testbed *Molkatha*, and the upsized *K'vort* class "Bird-of-Prey" show that the Klingons have begun the quest for the heir to the *Drell* legacy in earnest. The successor will most likely be none of the above.



One constant remains in the Klingon inventory and that is the assault ship. These are cruiser-sized vessels with cruiser firepower designed for use in planetary assault operations. They have large interior barracks and holds especially designed to support the transport of troops, weapons, stores, and other ground combat materials, along with the transporters and shuttlecraft to field them. Tactically they are the equivalent of cruisers; however, that is not their primary mission. They lack sufficient shielding to stand up in interstellar combat for any length of time and their large interior spaces make them as susceptible to easy damage as a carrier. Their primary combat objective is to provide suppression barrages against ground targets, either in orbit or within a planetary atmosphere. For this they are equipped with double-strength forward shields and reinforced side shields (at the expense of aft arc protection).

This year the experimental *Khuled* design (derived from the successful *K'teremny*) becomes the fifth major Klingon assault cruiser class, joining the ranks of the *Daka*, *Mas to Gat*, *Na Raden*, and *pllogh HeH*.

Perhaps the greatest variety and versatility among Klingon starship combatant can be found in its lesser capital ship classes. No major interstellar power currently fields as many different basic destroyer, scout, frigate, and escort type starships as does the Klingon Empire. Part of this has to do with Klingon politics and fierce House competition, not always friendly, over these lesser but often highly profitable procurement contracts. A large empire requires many vessels to police, and there are many occasions where the use of larger capital ships is considered a waste of Imperial resources. The Klingons have also retained many older classes for reasons of reliability and versatility. Battle-proven designs almost a century old, such as the venerable *Kuve* class frigate and *Sekleth* class escort, are as at home in this environment as are the newer *Qud* and *Fih* classes. There is also the impact that the recent *B'rel* class escort, aka the infamous "Bird-of-Prey," has had in fleet operations. It has quickly become the favorite of Klingon starship captains because of its versatility. It is equally at home in space or in a planetary atmosphere, has a well-balanced mix of disruptor and torpedo weapons, is extremely maneuverable, and (most importantly) has the cloaking device. *B'rel* was the first Klingon combat starship class with this capability, and it is rapidly being backfitted throughout the fleet as time and resources permit. The Romulans have come to rue the day they shared this technology with the Klingons, as large numbers of cloak-equipped Klingon starships played a decisive role in their victory at the Battle of the Briar Patch. Its influence can be seen in the various Klingon attempts to improve upon the design in both large and small starship classes.



A lone *Klolode* hides in an asteroid field, waiting for the right moment to pounce on an unexpected victim.

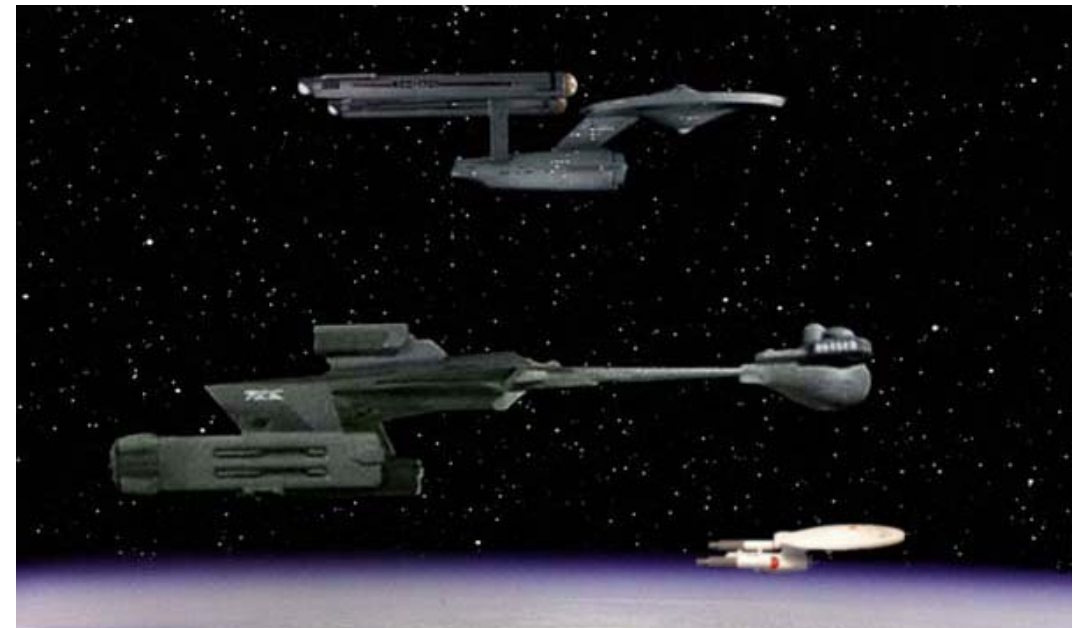

Korezima, the first *Klolode* ever captured intact, cruising under its own power after initial repairs by Starfleet personnel. Flying escort in the background are the Federation starships *Enterprise* (NCC-1701) and *Moscow* (NCC-1357).

One of the lessons that the Klingons have taught the Federation is the importance of a large, powerful, and well-armed auxiliary starship fleet. *Morast* was better by far than any warp-capable transport fielded by the Federation at that time of the Organian Conflict, and it still continues to play an important role in Imperial fleet operations today despite its age. Its successor, *Tormin*, was the most versatile fleet transport/tug of its day when it made its debut and still remains one of the best in service in any interstellar space fleet. The Klingons have since supplemented this capability with several *Drell* derived designs, as well as a host of lesser modern auxiliaries in various support roles. The groundbreaking Klingon MRF (Mobile Repair Facility, or “Murph”) continues to play as important a role in fleet support operations as it did during its spectacular debut a few decades ago. Starfleet has learned and continues to learn much from Klingon innovations with regards to auxiliary starship development.

Klingon Hull Types

Traditionally there have been three basic groups of starships (tH. *Duj*) that serve the Klingon Empire. These are capital ships, small craft, and auxiliaries. Per Klingon fleet nomenclature capital ships usually fell into one of nine divisions: battleships, dreadnoughts, carriers, first-tier cruisers (heavy cruisers and battlecruisers), second-tier cruisers (light and assault cruisers), destroyers, frigates, scouts, and escorts. Small craft fell into one of two divisions: patrol craft (which includes what we would term gunboats and corvettes) and shuttlecraft. Auxiliaries covered all noncombatant classes in Klingon service of comparable size to a capital ship that support fleet activities. Examples of these include fleet transports, repair tenders, tugs, and so on.

Readers will quickly note that this work does not follow the traditional Klingon hull type breakdowns. Changes in the past quarter-century have resulted in several new niche classes (pocket battleships and monitors, to name but two) that belie traditional Imperial naval classification. In addition, the numbers of patrol craft have swelled as new designs enter service, with roles blurring as they assume roles once traditionally held by escorts. This is reflected in this work's hull type breakdown.

The hull nomenclature currently in use is believed to have been devised by the Empire prior to the *Sentry* Incident of 2218. At that time hull type designations were listed in Klingonaase and Starfleet Intelligence keyed its own abbreviated system accordingly. There have been some efforts at starting a tHlingan hol based system of nomenclature in the past two decades but they have met with limited success. The current High Council has deemed it more practical to continue using the Klingonaase names for older ship classes while assigning tHlingan hol names for new ones.

For the sake of consistency this work defaults to the abbreviated Starfleet Intelligence system of Klingon hull nomenclature (Klingonaase-based) for all starship classes regardless of service entry date. tHlingan hol names for new hull types are listed along with their older Klingonaase equivalents. The following table should aid in reconciling these two different systems of Klingon hull nomenclature.

Hull group	Hull type	Abb.	Klingonaase	tHlingan hol
Capital ships	Battleship	B	<i>bur'd'kona</i>	<i>mayDuj'a'</i> (1)
	Pocket b.ship	L	<i>lat'd'kona</i>	<i>mayDujHom</i>
	Dreadnought	C	<i>chesis d'kleon</i>	<i>qughDuj'a'</i> (2)
	Shuttlecarrier	V	<i>vim ra'den</i>	<i>qengwIDuj</i>
	Heavy cruiser	D	<i>Drell</i>	<i>mayDuj tln</i>
	Battlecruiser	D	<i>Drell</i>	<i>mayDuj</i> (1)
	Cruiser	K	<i>kamalva</i> (3)	<i>qughDuj</i>
	Assault ship	T	<i>thala</i>	<i>neghDuj</i>
	Destroyer	D	<i>dakasta</i>	<i>QawIDuj</i>
	Frigate	F/L (4)	<i>fuwikh/lkah'kon</i>	<i>SuvwIDuj</i>
	Scout	S	<i>sirexa</i>	<i>ghoqDuj</i>
	Escort	E/K	<i>ethakan/kuwikh</i>	<i>DorDuj</i>
Monitor	K	<i>k'nel</i> (5)	<i>QitDuj</i> (6)	
Small craft	Patrol craft	G/K	<i>galasta/kuwikh</i>	<i>'avwIDuj</i>
	Shuttlecraft	W	<i>wisklan</i>	<i>lupDujHom</i>
Auxiliaries	Transport	G	<i>gavurta</i>	<i>HijDuj</i> (7)
	Transport/tug	N	<i>nivipav</i>	<i>HijDuj</i>
	Tender	S	<i>sarnall</i>	<i>tl'Duj</i>
	Tug	S	<i>grafqexa</i>	<i>yuvDuj</i> (8)

Translation notes:

- (1) *mayDuj* can be translated as both “battlecruiser” and “battleship” in Federation Standard. In formal reference Klingons use the modified *mayDuj’a’*, lit. “ultimate battlecruiser,” when referencing a battleship and *mayDuj* when referencing a standard battlecruiser. In practice Klingons reserve the tH. *mayDuj* for battleships and continue to use the Kl. *Drell* when referring to a battlecruiser.
- (2) Lit. “ultimate cruiser.” tHlingan hol has no word for “dreadnought.”
- (3) Lit. “strong starcraft,” i.e. “powerful starship.” This was the generic Klingonaase term for any cruiser-sized capital ship in the early 23rd century and as such corresponds to the modern tH. *qughDuj*, lit. “standard cruiser”
- (4) The F-series designation comes from the old *fuwikh* series 5 *Kuve* class frigate, which is one of the oldest hull types still in Imperial service. The L-series, or *lkah’kon* (Kl. “victory seeker”) were cruiser-sized vessels built starting in the 2260s to counter such Federation starship types as the uprated *Miranda*. It is from this later concept that the modern tH. *SuvwiDuj* (lit. “warrior’s ship”) is derived.
- (5) By the time the Kl. *k’nel* designation was introduced for monitors the Kl. term *kamalva* had fallen out of favor for cruisers. *Drell* was being used to refer to almost any Klingon cruiser regardless of size and mission profile, as it still is today. The Kl. *k’nel* translates as “luckless” or “spell-stricken.” It was the name for an older Klingon monitor class, a design with such bad luck that many of its crews claimed it was cursed.
- (6) Lit. “slow starship,” a less-than-tactful reference to its speed.
- (7) The tHlingan hol transport designation *HljDuj*, like that of the Federation, includes both general purpose transports (Kl. *gavurta*) and ones that can tow container pods for additional cargo capacity (Kl *nivipav*). The term “freighter” is usually reserved for Klingon civilian transports, although it is frequently used in a derisive sense by Imperial warriors when referring to transport crews (tH. *tongDuj pugh*, lit. “freighter scum”)
- (8) Lit. “starship pusher,” describing the function of a tug.



Demon Renegade Studios

Since 2230, Starfleet Intelligence has used an abbreviation system based on this nomenclature in order to quickly distinguish among the various Klingon starship classes. The general format for classes in Imperial service is as follows:

AB-1CD2

- AB - The major class to which the design belongs. The abbreviation used can be from either the older Klingonaase or newer tHlingan Hol systems of nomenclature. This is normally only one letter. The two-letter form is rarely used.
- 1 - The number for that particular design. This is usually tied to the nomenclature system in question.
- C - A primary variation on a given class. Common examples include the following:
 - A, B - standard in-service upgrades that make major systems modifications or alter visual appearance.
 - C - command ship conversion
 - D - drone missile conversion
 - E - scout conversion (post-2269 classes)
 - G - assault ship conversion
 - J - penal ship conversion
 - M - Hydran mauler beam weapon conversion
 - N - "diplomatic" conversion
 - P - patrol ship tender conversion
 - S - scout conversion (pre-2269 classes) or stasis field generator upgrade (post-2269 classes)
 - V - shuttlecarrier conversion
 - X - experimental
- D - A secondary variation on a given class. This position is also used to denote variants unique to a given house. In such cases an abbreviated form of the House name in parenthesis occupies this position. The abbreviations used for secondary variations are the same as for primary variations, or numbers can be used instead.
- 2 - A tertiary variation on a given class. Always a number.



Here are some examples based on this system:

- D-7 standard *Drell* type 7 battlecruiser (*Klolode* class)
- D-7A upgraded *Drell* type 7 battlecruiser (*gr'Oth* class)
- D-7C *Drell* type 7 command cruiser conversion (*betleH* class)
- D-7D *Drell* type 7 drone cruiser conversion (*G'vord* class)
- D-7N *Drell* type 7 diplomatic cruiser (*Zantai* class)
- D-7S *Drell* type 7 stasis cruiser conversion (*Oghwl* class)
- D-7V *Drell* type 7 shuttlecarrier conversion (*Kroree* class)
- D-7J *Drell* type 7 penal battlecruiser (*Valesa* class)

Nomenclature system modified from that used by Amarillo Design Bureau in its *Star Fleet Battles* role playing game and later expounded upon and modified by Activision Games for the *Starfleet Command* videogame series

Original D-6 and D-7 designations by William Shatner and Leonard Nimoy

Additional material derived from the efforts of Aridas Sofia, Todd Guenther, FASA Corporation, Brad Torgerson, Eric "Jackill" Kristiansen, and many others

ᐃᐃᐅᐅᐅᐅᐅᐅ

Battleships

bur'd'kona (Kl. “Hulking Brute”) and
mayDuj'a' (tH. “Bigger Battlecruiser”) series

Jul'kar

qughDuj'a' program predecessor (*bur'd'kona* type 1) [2238]

Specifications as built

Dimensions

Length:	242.3 meters
Beam:	152.4 meters
Height:	68.5 meters

Mass

Standard gross:	774,250 GMT
Subspace displacement:	195,000 DWT

Crew complement

Officers:	62
Enlisted:	336
Imperial Guards:	up to 250 (in support of assault operations)

Top velocity

Cruising speed:	warp 7.0
Rated maximum speed:	warp 12.0
Rated emergency speed:	warp 13.0

Endurance

Standard endurance:	estimated 3 years at L.Y.V.
Maximum endurance:	N/A

Armament

Disruptors:	9 standard disruptors (3 F, 2 ea P/S, 1 F/P, 1 F/S) 3 heavy disruptors (1 F/P, 1 F, 1 F/S)
Guided weapons:	2 drone racks (1 F, 1 A)



One of the first clear images of the original B-1 series *Jul'kar*. This was taken by the starship *Constitution* (NCC-1700), under the command of Garth of Izar, during the opening minutes of the First Battle of Axanar.

Known starships in Klingon service

Hull #	Name of starship	Builder	Status
KRB01-001	<i>Jul'kar</i> (<i>Hunting Lance</i>)	Vekah Shipyards	lost
KRB01-002	<i>TuQ Kurlt</i> (<i>House of Kurlt</i>)	Vekah Shipyards	lost
KRB01-009	<i>Hegh Ilingwl'</i> (<i>Meatgrinder</i>)	---	lost

Jul'kar is the original Klingon "battleship" per se; that is, the first to be labeled as *bur'd'kona* (Kl. "bigger battlecruiser") under the former Imperial system of nomenclature. Nowadays the few that remain are more properly classified as *qughDuj'a'* (tH. "ultimate cruiser," i.e. "dreadnought.") due to their size and armaments. Since *Jul'kar* was the first *bur'd'kona* as such to enter Imperial service, however, it is dealt with in this section.

Jul'kar is an old design, although not as old as some of the starships still limping along in Lesser House fleets. It was a contemporary of *Raxor*, entering service some five years after its more notable stablemate, and was considered at the time to be the ultimate expression of the *Drell* hull form. It saw its first major combat action against the Kinshaya during the Demon War (2249-2254). Production officially ended in 2260 in favor of additional *Klolode* class battlecruisers, which gave the same combat performance at less cost. *Jul'kar*s continued to serve as the ceremonial backbone of the Imperial Fleet until the 2270s, when more powerful and effective heavy capital ship designs such as *K'herr* and *Kuyper* began joining the fleet in numbers. Even before then, however, the Imperial High Command was already in the process of selling off its *Jul'kar*s to the Great Houses. All survivors of the class had been relegated to House fleets by 2278. By 2292 all remaining *Jul'kar*s were in the service of the Lesser Houses, having been replaced by the more effective *Suvwl'QeH* and (in some cases) *bet'leH*.

It can be rightly said that *Jul'kar* is the ancestor of all tri-nacelle Klingon starship designs, as it was the first. More properly, it is the direct ancestor of *Kuyper* and attempts to address its deficiencies lead to the larger *K'herr*. The secondary hull of *Klolode* is little more than that of *Jul'kar* with the centerline engine removed and a standard *Raxor*-style hangar deck installed. Derivative designs based on *Jul'kar* included the *bet'leH* and *Suvwl'QeH* command cruisers.

Star Fleet has engaged *Jul'kar*s on at least four different occasions between 2255 and 2275. The most notable was the short-lived Federation offensive during the Four Days War of 2267 (aka "the Organian Incident"), during which a Star Fleet task force destroyed one *Jul'kar* and severely damaged two others. All in all, *Jul'kar* proved to be, for all intents and purposes, a slightly beefed-up *Klolode*. Even so, the presence of a third *pijonta* was a significant factor in maintaining full shielding and weapons capability during combat. The two previous encounters with *Jul'kar* proved an important factor in the design of *Federation*, Star Fleet's first dreadnought, which was also of a tri-nacelle design.

Jul'kar, the lead ship of its class, was lost in action in 2253 during the final Klingon offensive of the Demon War. *TuQ Kurlt* fell victim to a vicious

crossfire from the Star Fleet dreadnoughts *Federation* (NCC-2100) and *Alliance* (NCC-2113) during the Four Days War of 2267. The aging *Hegh Ilingwl'*, which had been converted to an experimental testbed, was lost in 2271 during the V'Ger Incident. Its wreckage was discovered and surveyed by the starship *Enterprise* (NCC-1701) on stardate 7573.21.

At this time no *Jul'kar* remains in Imperial service. A dozen or so are still believed to be serving as the flagships of Lesser House fleets. Many of these have replaced their old fore-and-aft drone launchers with modern photon weaponry. Some are even reported to have undergone a full *Kuyper*-style weapons and shielding upgrade, but this has not been confirmed.



Final configuration of *Hegh Ilingwl'*, as projected from debris analysis from the sensor logs of the starship *Enterprise* (NCC-1701). The triangular wedges along the sides of the command boom are strap-on barracks for Imperial Guard battalions. The twin pods at the bottom are believed to be early versions of the Klingon heavy disruptor. *Hegh Ilingwl'*'s loss was not due to any action on V'Ger's part. Rather, its demise seems to have resulted from an overload in one or both of its heavy disruptor capacitors. It is believed that the overload came about as a combination of design flaws and rapid repeat firings.

Schematics

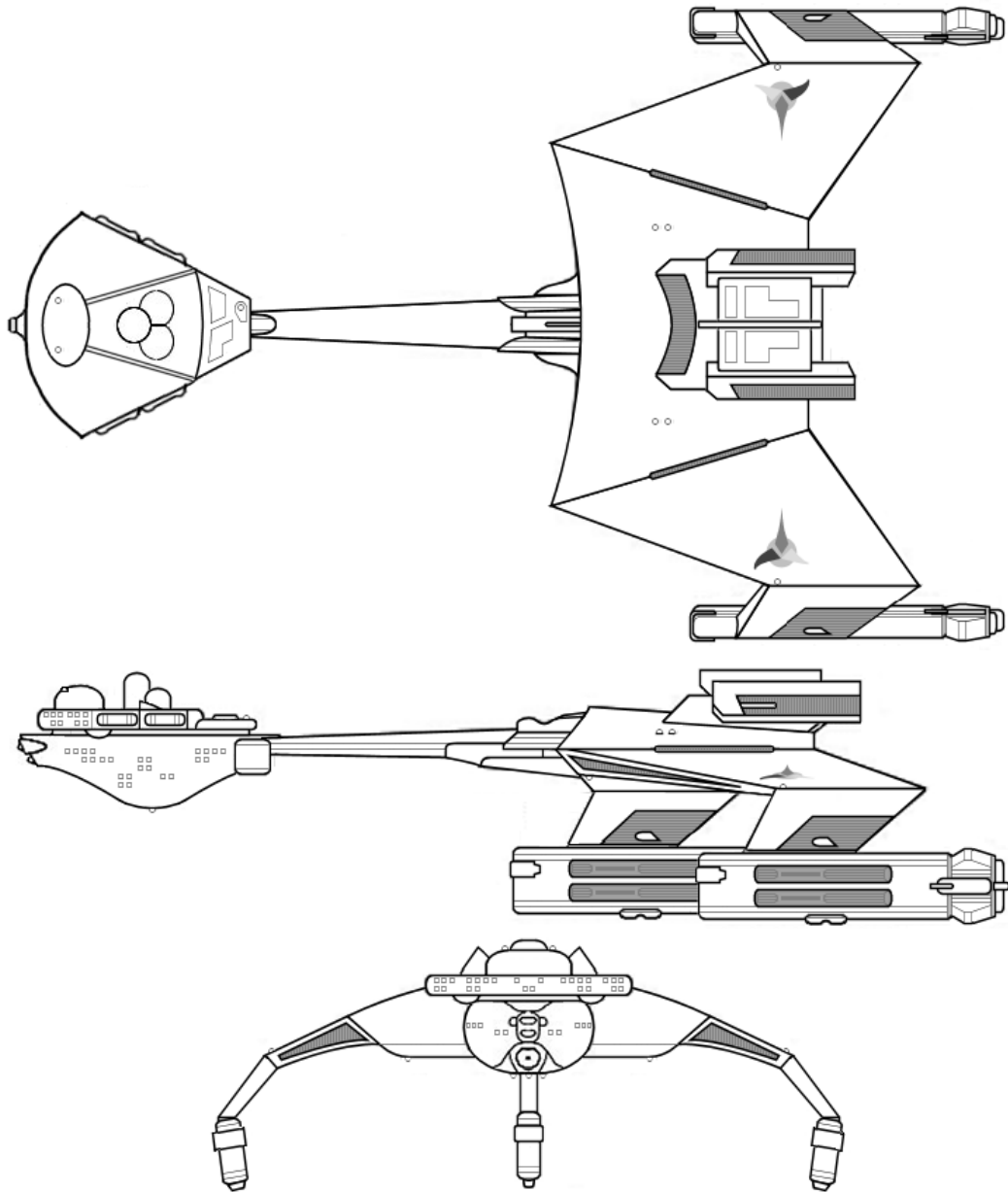

Jul'kar as launched (2238)



A look at a *Jul'kar* that has been modernized. The ship in question appears to belong to House Beszaga, one of the more affluent of the Lesser Houses. One can just barely make out a *K't'ara* style deflector grid upgrade on the hull. More obvious are the three Marine barracks clamped onto the command boom. *Jul'kar's Drell*-derived hull makes it compatible with almost all Imperial and House standard *Drell* upgrades and modifications. It is a fact of which many of its current owners have taken advantage.

***Jul'kar* class Klingon dreadnought created by Patrick Flannery as first published in Geoffery Mandel's *Star Fleet Handbook #13* fanzine with additional modifications and developments by Eric "Jackill" Kristiansen, Terradhyne, and Atrahasis**

Additional background material courtesy of James Dixon "Klingon gunship" encounter derived from the works of D.C. Comics, Amarillo Design Bureau, and Atrahasis

Schematic by Richard E. Mandel and Neale Davidson

Visuals courtesy of Atrahasis

Kar`hamer

mayDuj prototype (bur`d`kona type 10) **[2279]**

Specifications as built

Dimensions

Length: 340 meters
Beam: 352 meters
Height: 141 meters

Mass

Standard gross: 1,263,500 GMT
Subspace displacement: 332,500 DWT

Crew complement

Officers: 105
Enlisted: 707
Imperial Guards: up to 400 (in support of assault operations)*

Top velocity

Cruising speed: warp 10
Rated maximum speed: warp 12

Endurance

Standard endurance: estimated 2 years at L.Y.V.

Armament

Disruptors: 20 standard disruptors (6 F, 6 A, 4 ea P/S)
4 heavy disruptors (F only)
1 assault disruptor (F only, embedded in hull)

Guided weapons: 3 photon torpedo tubes (2 F, 1 A)
4 drone racks

Other: 2 stasis field generators
cloaking device
8 fighter shuttles

(*) These capabilities will be available only after *Kar`hamer* completes its current service life extension overhaul at Mastocal.

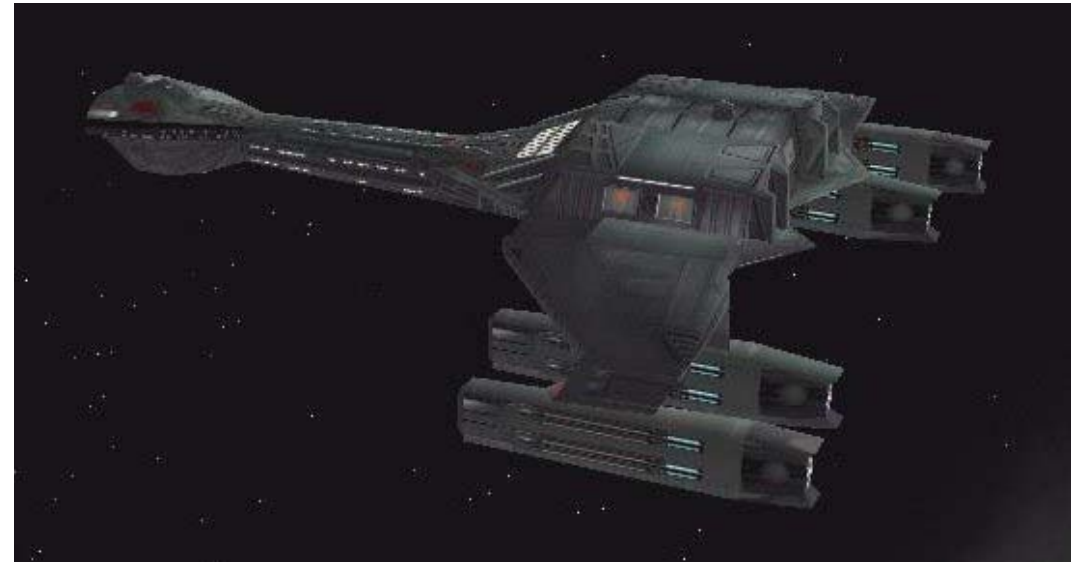

Known starships

Hull #	Name of starship	Builder	Status
KRB10-001	<i>Kar`hamer (March of Death)</i>	Vekah/Mastocal	active

No starship development program in the known history of the Klingon Empire was as fraught with as much turmoil as *Kar'hamer*, first of the modern Klingon battleships. It took almost two decades to build, with a construction history wrought by political infighting, questions over the program's validity, and continual delays due to constant changes in its design. In the end, it was launched not because it was ready but because the current Klingon government simply got tired of working on it and was ready to move on.

In 2257 Vekah Shipyards won the contract to build all six vessels of Kareli Design Bureau's new *Kar'hamer* class for the glory of the Empire. Ten years later, when *Kar'hamer* was about 80% complete, the excellence of the Federation Starfleet's own *Federation* class dreadnoughts was graphically demonstrated during the Organian Incident of 2267. During the four brief days of fighting, before the Organians intervened and put a stop to all hostilities, a battle fleet led by just two *Federations* had fought its way to the border of the Klingon inner systems. This graphically demonstrated the superiority of Federation starship technology for all to see. The Klingons, whose culture still bore the scars of the Hur'q invasion thousands of years ago, had sworn that their home systems would forever remain inviolate. It therefore came as quite a shock to the collective Klingon psyche that a Federation fleet had managed to fight its way so close to the Klingon home systems in so short a time.

The Klingons were secretly grateful that the Organians intervened when they did, although they would never openly admit it. Instead, combat data gathered on *Federation's* performance was eagerly examined to see what had to be done to improve the performance of Klingon designs. As a result the nearly complete *Kar'hamer* was stripped back down to its base frame and rebuilt anew. This time, it would be carrying the firepower of a starbase on an upsized *Drell* type hull with a cruising speed superior to the best that the Federation had to offer. Therein lay its problem. It was the same problem that had killed the Federation's own *Goliath* battlecruiser after the end of the Romulan War in the mid-22nd century. *Kar'hamer* was simply too big a starship to build properly given the facilities and technology available to Vekah at the time. Its engines were not powerful enough to push the mass intended for them, let alone power the weapons load, shielding systems, or for that matter the interior lights throughout the entire vessel. Within the next five years of construction work was twice rebooted in response to changing requirements from the Klingon High Command. Its *pljonta'* were upgraded three times and its interior power grid was completely ripped out and replaced in order to better support the massive assault disruptor that had been planned for mounting. That was just the beginning. Even as the ship's new form slowly took shape within its spacedock, its sensor and scanner suite was updated a number of times,

its disruptors were dismantled and replaced with new models at least three times, extended shuttle bays for carrier-type operations were constantly being installed and then removed again according to fleet leadership whims, and the planned assault disruptor system was almost abandoned due to numerous developmental delays with its design. Entire deck and compartment sections would be built only to be ripped out months later in order to make way for even more design changes, and so on. The end result of all of this was that *Kar'hamer* had gone from being the intended *magnum opus* of the Klingon fleet to the dock-bound equivalent of a gargantuan *targ*. Thus *Kar'hamer* languished in drydock in an unfinished state for another decade. Vekah Shipyards simply could not keep up with the ever-changing state of starship technology, the ever-changing vagrancies of the Klingon High Command and the political winds buffeting the Empire during the time of its long-delayed building.

The best thing that could have ever happened to *Kar'hamer* was when Chancellor Lotar yanked Vekah's construction contract in 2274. He then had the 75% complete hull towed to the nearby Imperial naval base at Mastocal for completion. He also ordered Mastocal's starship engineers to complete and launch *Kar'hamer* without delay, as soon as possible, by any means necessary – and it had better be operational, else heads would most certainly roll. It is not surprising then that *Kar'hamer* finally entered service in 2279, over two decades after the *bur'd'kona* project was first conceived and after certain materials procurement issues were resolved. Its sister ship *Ribursli* would receive similar treatment, whereas the remaining four *Kar'hamer* space frames were scrapped for parts and materials.

Kar'hamer was the largest starship ever built by a known humanoid species at the time it entered service. While it may be hard to miss in a firefight, given its size and mass, *Kar'hamer* is no slow-moving leviathan. It is a starship designed for the purpose of both giving and taking abuse in extremely large doses, more so than almost any other starship fielded by any of the other major interstellar powers in its day. It is not a threat to be taken lightly, even if it is the only ship in its class.

Kar'hamer as completed bears only the faintest resemblance to its original design. Apart from its angled lines (an influence of the so-called "Taldren generation" of Klingon starship design), the difference between *Kar'hamer* as designed and as launched is in the placement of its *pljonta'*. The original design called for a warp-capable boom with twin *pljonta'* mounted in a fashion similar to the old *K'herr* proposal. By the time the incomplete *Kar'hamer* wound up at Mastocal the warp-capable boom had fallen out of favor with the Klingon High Command, who now viewed it as a means of enabling captains with cowardly streaks to escape a difficult fight. In addition, initial testing with the assault disruptor prototype

platform *Molkatha* indicated that at least three *pljonta'* would be required as part of the secondary hull power grid in order to provide sufficient power to speedily arm the weapon. The resultant 1+3 engine configuration violated the warp dynamics of *Kar'hamer's* Drell-derived hull, as it resulted in two *pljonta'* being in direct line with each other, so all four *pljonta'* were moved to the secondary hull. This provided a stable *pljonta'* arrangement for warp travel (twin pairs of two) as well as providing ample power for *Kar'hamer's* assault disruptor. The four-under *pljonta'* arrangement was subsequently adapted for use in the later *mayDuj'a'* programs.

For many years *Kar'hamer* was the most warp dynamic of all Klingon battleships either currently in service or under construction. It was more maneuverable in warp than the average Federation starship, which was astounding given the ship's stated gross mass. The reason behind this was simple. Almost 60% of its interior was nothing but empty space. These hull voids were initially misinterpreted as cargo holds by data received from a Starfleet sensor probe that was the first to observe *Kar'hamer* in 2281. Subsequent reanalysis of that data revealed an astounding fact. *Kar'hamer* had no decks or compartments within its frame members save for those absolutely necessary or essential for ship operations and weapons systems. It was believed that in order to save time (and their heads) the starship engineers at Mastocal focused their construction efforts only on those parts of the ship that were absolutely required either for combat or normal operations. The apparent intent was to finish work on the rest of the ship in between deployments. This was what gave so massive a vessel such an abnormally low displacement in subspace, resulting in a warp field signature comparable to a Romulan Firehawk. *Kar'hamer's* abnormal mass-to-displacement ration eventually dropped to a normal level as time passed and remaining interior work was completed.

Upon its entry into service *Kar'hamer* served as the flagship of the Klingon's Romulan Border Deep Space Fleet, leading Klingon forces on missions in and around Triangle space. It was replaced in this role by *wo' Hubwl* in 2293. *Kar'hamer* has since been reassigned as the flagship of the Kinshaya Border Deep Space Fleet. The change in mission profiles has also given Mastocal several opportunities to finish its interior spaces during routine in-service overhauls. *Kar'hamer* is currently in spacedock at Mastocal undergoing its first major service life extension overhaul, during which what little interior work remains will most likely be completed.



A Starfleet Intelligence "best guess" projection at how the upgraded *Kar'hamer* will appear once it rejoins the Imperial fleet sometime near the end of 2294.

***Kar'hamer* class Klingon battleship created by Steven V. Cole for Amarillo Design Bureau's *Star Fleet Battles* role-playing game "Taldren generation" modifications by Models Please (OutaLance Shipyards)**

Additional background material courtesy of Amarillo Design Bureau, Activision Games, Klingon Fanatic, and James Dixon

**Visuals courtesy of Models Please (OutaLance Shipyards)
Color schematics courtesy of Rick "Pneumonic81" Knox**

pumwl¹

***mayDuj'a'* type 1 (*bur'd'kona* type 11) (2280)**

Specifications as built

Dimensions

Length: 480 meters
Beam: 379 meters
Height: 126 meters

Mass

Standard gross: 1,325,000 GMT
Subspace displacement: 350,000 DWT

Crew complement

Officers: 110
Enlisted: 590
Imperial Guards: 60 (in support of assault operations)

Top velocity

Cruising speed: warp 12
Rated maximum speed: warp 15

Endurance

Standard endurance: estimated 2 years at L.Y.V.

Armament

Disruptors: 14 standard disruptors (5 F, 4 A, 2 ea P/S)
Guided weapons: 3 heavy photon torpedo tubes (2 F/1 A)
6 drone racks
Other: 2 stasis field generators
1 AMFP generator
cloaking device

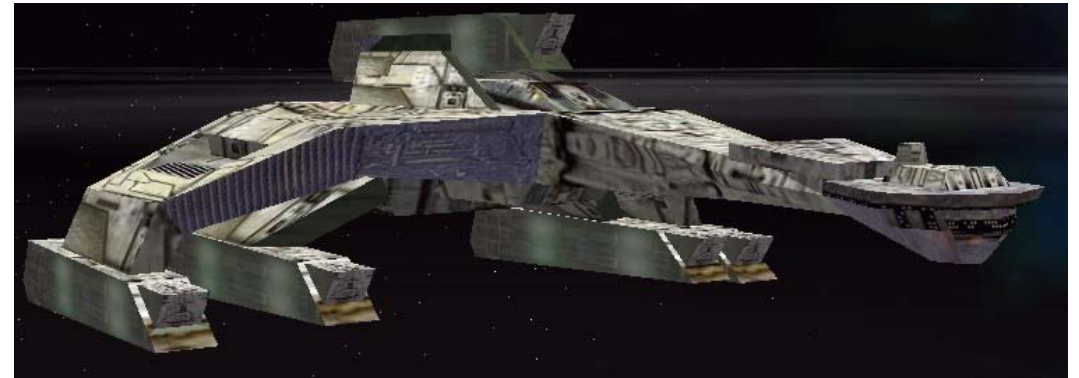

Known starships

Hull #	Name of starship	Builder	Status
KRB11-001	<i>pumwl' (Accuser)</i>	Taamar Shipyards	lost
KRB11-013	<i>pumwl' II (Accuser)*</i>	Taamar Shipyards	lost

(*) Replacement for class ship, lost with all hands during an ion storm in 2281.

In late 2272, the Tholians sent a new ship to test Klingon strength along their shared border. This ship was more than a match for the best Klingon starships on border patrol, destroying or crippling most as well as destroying several key border outposts in short order. It took three months for the Empire to finally corner and destroy this new Tholian juggernaut, and even then was only able to do so with a battle fleet scrapped together from what was left of Tholian border forces and reinforcements newly arrived on the scene. The Empire paid a high price in warriors, starships, and resources during this encounter, forcing the High Command to rethink its long term strategies in this regard. The one thing that had kept the Empire from stopping the Tholians in their tracks was the lack of a large capital ship with heavy forward firepower, similar to certain concepts already explored by both the Federation and the Romulans, that could knock down any attacker and possibly destroy it with its opening salvo. At the same time fleet coordination was needed for other supporting vessels in the area that could be rallied for a second assault if need be – something that the Klingons have previously not been very good at doing. Individual glory in battle was the norm, and the thought of coordinating starships to act as a unified force ran against basic Klingon nature. Nevertheless, what had to be done would be done in order to maintain the glory and honor of the Empire, and in that the wounded pride of individual warriors could be mollified.

The following year the *pumwl'* design was submitted by Taamar Shipyards' Jevghom Design Bureau as the solution to the problem. It borrowed heavily from the *K'herr* class dreadnoughts, which had only just received approval from the High Council and were preparing to begin construction. The main visual differences was that the warp-capable boom was ditched in favor of an all-or-nothing high-power approach, with no less than five *pljonta'* attached to *pumwl's* oversized secondary hull in a one-up, four-down arrangement. This was two more than *K'herr* and required both a redesign and upsizing of the secondary hull in order to accommodate reinforced frame supports for the extra *pljonta'*. This extra power would be used for *pumwl's* beefed-up armaments, which saw the first deployment of multiple heavy photon torpedo tubes on a Klingon vessel. *pumwl'* had three of these systems, each wielding photon torpedoes that were double the strength of Federation Starfleet versions. Two were fitted side-by-side in the traditional command boom nose mount, while the third was placed in a *K't'inga*-style aft mount between the impulse engines. *pumwl'* was also given a full C3 command suite almost identical to that of *K'herr* as befitting its role as a fleet command ship.

The class name, *pumwl'* (tH. "accuser"), comes from the fact that much Klingon blood was shed over the design before one beam had been laid on its keel. The speed at which Jevghom both submitted its design and won

approval, due largely to its outstanding excellence in simulation, cause some in other Houses to suspect complicity with the Tholians in creating a false need for the class. Many duels of honor were fought over these accusations before the High Council settled the matter; hence the name "accuser" for the lead ship in the class.

At the time *pumwl'* entered service it was classified as a *moch' qughDuj'a'* (tH "super dreadnought"). It was reclassified once the *mayDuj'a'* program was formally recognized as part of the Imperial fleet. Initial size estimates by Starfleet Intelligence had also made it out to be almost as large as later *may'Duj'a'* – an error that has since been corrected.

The antimatter field projector (AMFP) generator is a weapon system unique to this class. It is analogous to the Hydran Mauler and is believed to have been adapted from captured Hydran technology. *pumwl's* AMFP works by generating a forced, highly-charged antimatter dump from special vents in the forward caps of its *pljonta'* in much the same way that plasma is vented from Federation ships. This antimatter discharge is vented into a miniaturized warp containment field that is then expelled at maximum warp speed from the ship at any target within its forward firing arcs. Once the field has reached its target then it is deactivated, causing the antimatter to react with matter (interstellar dust and gases) and detonate instantly. The result is devastating on an unshielded vessel and has the potential of completely collapsing the affected area shields of a shielded vessel, with any leftover energy from the discharge damaging the ship itself. Both its power requirements and the AMFP system itself limit its use to forward fire only; also, the massive power requirements dictate that it can only be fitted onto a modern *mayDuj'a'* or comparable vessel. Also, one potential drawback (which has only been explored in simulation) is that a premature detonation of an AMFP discharge would damage the firing ship itself instead of its intended target. These factors appear to have precluded the use of the AMPF system in newer *mayDuj'a'*, such as the *qeyliS BetleH* and *WoQ'a'* classes.

As this document went to press there are reports that a fleetwide upgrade is taking place for all *pumwl'* class battleships. The most noticeable part of this upgrade are new *pljonta'* that somewhat resemble those of the planned *WoQ'a'* class of battleships.

pumwl' was launched in 2280, and as might be expected it was immediately dispatched to the Tholian border. Two short months later *pumwl'* and its escorts routed and destroyed a Tholian task force that had been supporting a clandestine dilithium mining operation within Klingon space inside the Thaleris asteroid belt. Victory celebrations were cut short a mere three months later when *pumwl'*, champion of the Battle of Thaleris,

was lost with all hands in an ion storm. The High Council has since authorized the building of a replacement, which will also be named *pumwl'* in honor of the original.

Currently there are six *pumwl'* class *mayDuj'a'* in service. One has been lost, six more are in varying stages of construction, and one more has been authorized for a total of seven additional hulls. Construction of these remaining seven has been put on indefinite hold due to the Praxis explosion of 2293. That event also forced the High Council to put on hold plans to authorize an additional thirty more *pumwl's*, which would have replaced older dreadnoughts and pocket battleships in Imperial service.

Schematics





***pumwl'* class Klingon battleship created by created by 18 Degrees East
for the *Klingon Academy* and *Starfleet Command* series of licensed videogames**

**Additional background material courtesy of Amarillo Design Bureau,
Activision Games, the *Klingon Academy* Forums, and Hidden Agenda**

Visuals courtesy of Taldren, Desty Nova, and Demon Renegade Studios

Schematics courtesy of Taldren

qeyliS betleH

***mayDuj'a'* type 2 (bur'd'kona type 12) (2285)**

Specifications as built

Dimensions

Length:	686 meters
Beam:	532 meters
Height:	240 meters

Mass

Standard gross:	2,997,000 GMT
Subspace displacement:	795,000 DWT

Crew complement

Officers:	123
Enlisted:	507
Imperial Guards:	70 (in support of assault operations)

Top velocity

Cruising speed:	warp 14
Rated maximum speed:	warp 16

Endurance

Standard endurance:	estimated 4 years at L.Y.V.
---------------------	-----------------------------

Armament

Disruptors:	19 standard disruptor banks (6 F, 4 each P/S, 5 A)
Guided weapons:	6 heavy disruptors (all F) 1 assault disruptor (F) 6 heavy photon torpedo tubes (4 F/2 A) 6 drone racks*

(*) A *mayDuj'a's* drone racks are located in the upper wing pylon notches on both sides of the ship. This makes them part of any oversized Balth-type hull modules that could be removed and replaced with those of other types. *wo'Hubwl* has no drone racks, reflecting its possible reconfiguration as a space control ship.

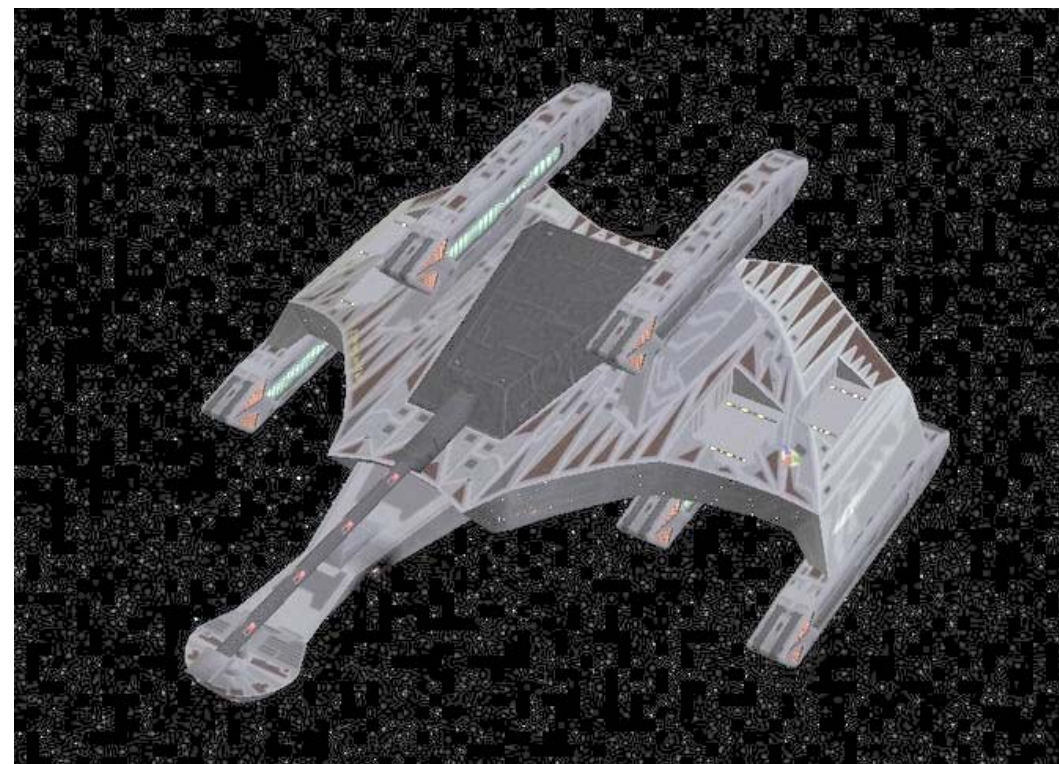

Known starships

Hull #	Name of starship	Builder	Status
KRB12-001	<i>qeyliS betleH (Sword of Kahless)</i>	Klinzhai Shipyards	active
KRB12-002	<i>yejquv ghop (Hand of the High Council)</i>	Klinzhai Shipyards	active
KRB12-003	<i>wo' Hubwl (Defender of the Empire)</i>	Klinzhai Shipyards	active
KRB12-004	<i>FuQ'yn hg'Lhi (Unstoppable)</i>	Klinzhai Shipyards	building

qeyliS BetleH is currently the largest starship in terms of size in Imperial service. It is also one of the largest fielded by any major interstellar power in known space. It is the spacegoing equivalent of a small, warp capable starbase and can destroy most starships with just a few salvos from its extraordinary array of weaponry.

This class arose in the wake of the scandal following the near-collapse of the earlier *bur'd'kona* program. It had started in the 2260s with the goal of producing the Empire's first spacegoing battleship class but had become mired in scandal, corruption, yard delays, and the rapid evolution of starship technology that took place in the 2270s. By 2274 an infuriated Chancellor Lorak cancelled Vekah Shipyard's construction contract and had its two incomplete hulls towed to the Imperial facility at Mastocal for completion. Both ships were years behind schedule and would be obsolete if finished per their current design. Mastocal's job was to salvage these hulls any way it could and get them into service so that valuable Imperial resources expended on them would not go to waste. In the meantime, Chancellor Lorak decided that a complete reboot of the *bur'd'kona* program was in order. It would be two more years before Lorak and the High Council came to a consensus as to the new direction Klingon battleship design should take.

In late 2275 master shipbuilder Hogh Balth of House Birok'ken, designer of the remarkable *pIH* class frigate, was appointed by the High Council as the lead designer for the new battleship program for the Imperial fleet. The new program was codenamed *mayDuj'a'* (tH. "monster ship"), and it was even more ambitious than had been its troubled predecessor. Two important differences set apart *mayDuj'a'* from the earlier *bur'd'kona*. First, Balth was keenly aware of the burden that had just been placed upon him and the consequences of potential failure. Second, Balth was an acknowledged shipbuilding genius known for starship designs that performed well with as minimum impact on Imperial resources as possible in their construction. If there was any Klingon in the Empire that could salvage the battleship program, it was Hogh Balth. His design was finished, simulator tested, and submitted to Chancellor Lorak a few short months into 2276. Balth's design was almost immediately approved by the High Council.

The original intent was for two of the Empire's best shipyards to build two each of the massive *mayDuj'a'* for a total of four, one each for "the four corners of the Empire." The contractors chose were the Imperial Klinzhai Shipards at Mempa and the Chenwl' Duj Yards at Qo'nos itself. This represented a political compromise worked out between two rival factions within the Council, House Birok'ken and House Yok'tu, each of which wanted the sole glory for building the *mayDuj'a'* for the Empire. Chancellor Lorak realized that either House had the resources to take on the program

alone; however, he wanted to avoid committing the same mistake as had his predecessors with the *bur'd'kona*. By splitting the program between the two he hoped to ensure that at least one of them would follow through with their commitment. If both did, then so much the better.

qeyliS BetleH was launched from the Klinzhai Shipyards in 2285 just over seven years after its keel had been laid. Its commissioning into Imperial service was as much at triumph for House Birok'ken as it was the Empire. It had channeled its aggression for the contract, aggression that had almost resulted in blood being spilled in the Council Chamber between the eldest sons of both houses years before, into making sure that *qeyliS BetleH* could and would be launched. Many other shipbuilding programs at the Klinzhai Shipyards were either idled or placed on low priority in order that the massive battleship be completed ahead of schedule. In this it was racing its rival, House Yok'tu and its legendary Chenwl' Duj Yards. House Yok'tu had secured many of the most prestigious shipbuilding contracts in the Empire and *qeyliS BetleH* was supposed to have been its crowning achievement. There was no love lost between the two as the race to finish the *mayDuj'a'* proceeded throughout the 2280s. The fact that House Birok'ken beat a more powerful rival in launching the Empire's first modern battleship would be forever remembered in Imperial history and added much honor and prestige to its reputation.

As it turned out, though, there was no need for House Birok'ken to have been in such a hurry. House Yok'tu might have had most of the shipbuilding contracts for the Imperial fleet but that very fact would prove to be its undoing. Its resources were already being pushed to their limits and the addition of the burden of building two of the massive *mayDuj'a'* was too much for the Chenwl' Duj Yards to handle. House Yok'tu's precarious situation was also exacerbated by a tangled web of corruption and greed within Chenwl' Duj and its subcontractors, one that eventually resulted in the same kind of delays that had all but killed the *bur'd'kona* program decades before. The situation got so bad that in 2287 Chancellor Lorak was forced to take action. He not only yanked the *mayDuj'a'* contract from House Yok'tu but most of their other shipbuilding contracts as well and expelled Councilor Yok'tu himself from the High Council. To add insult to injury Lorak then ordered that both of Yok'tu's incomplete *mayDuj'a'* hulls be towed to the Klinzhai Shipyards of House Birok'ken "because I know *they* will build them." Most of House Yok'tu's cancelled shipbuilding contracts have since been farmed out to other shipyards.

As for *qeyliS BetleH*, the lead ship in a new generation of Klingon battleships, it is not only a symbol of pride but also the flagship of the Klingon Empire. While it has since been joined by two sister ships, with a third building, nothing can take from it the honor of being the first "true" *mayDuj'a'* in Imperial service. Postings to *qeyliS BetleH* are eagerly sought,

even if only for temporary details, for a warrior who serves on the Empire's prime *mayDuj'a'* is giving his best to the best and most powerful starship that the Empire wields.

qeyliS BetleH shares the common drawback of all modern era Klingon battleships. It is too large to be effectively covered by current cloaking devices. Both the Klingons and Romulans are said to be working on cloaking devices that can generate a 1000 meter diameter field, more than enough to cloak *qeyliS BetleH*, but the technology is still far from perfect. Most Federation analysis believe that neither power will be able to overcome the power requirements for a starship to generate such a large field for at least another two decades.

This is one of only three modern Klingon starship classes that mounts an assault disruptor. The other two are *Kar'hamer* and *WoQ'a'*, its predecessor and successor in the *mayDuj'a'* program.

qeyliS BetleH launched in 2285. It currently serves as the flagship of the Qo'nos Home Fleet, protecting the Klingon home systems from any potential armed attack. It is named for the *betleH*, the legendary Klingon curved combat blade said to have been invented by Kahless himself.

yejquv ghop launched in 2288. It currently serves as the flagship of the Federation Treaty Zone Deep Space Fleet. Its name is a nod to the Klingon High Council for giving the Imperial battleship program a second chance.

wo' Hubwl launched in 2293. It escaped the Praxis explosion by nine days, thus avoiding the fate of being destroyed in its own slip that befell so many other Klingon starships under construction at that time. It currently serves as the flagship of the Romulan Border Deep Space Fleet. As the latest *mayDuj'a'* to enter service it has some significant differences in comparison to its stablemates. For one, it apparently uses the same *pljonta'* that are intended for the planned *WoQ'a'* class. The reason for this is unclear and two theories have been proposed. The first posits the notion that House Birok'ken had to farm out the contract for the warp engines after taking on the burden of building all four *mayDuj'a'* for the Empire. The second and most likely points to design problems with the original warp engine design that did not surface until after *qeyliS BetleH* had already entered service. Also, according to intelligence reports, *wo' Hubwl's* configuration more closely approximates that of a space control ship than a dedicated battleship, with extra shuttlecraft hangar bays and additional docking latches for patrol craft servicing. These changes are reflected in a reconfigured hull, deleting its drone racks and replacing hull spaces previously thought to be dedicated cargo holds and Imperial Guard barracks. The nature of this reconfiguring would seem to indicate that the *mayDuj'a'* share the same modular hull section design that is common to Hogh Balth's other starship designs, only on a larger scale. The strategic

implications are profound, as this potential capability considerably expands the mission profiles that would be available to a modern *mayDuj'a'*. It is not known if similar shuttle bay and patrol craft support modules have been constructed for the other battleships in the *mayDuj'a'* program.

fuQ'yn hg'Lhi was about 35% complete in 2293 when debris from the Praxis explosion tore through the Klinzhai Shipyards orbital complex, severely damaging the unbuilt battleship. Most of the damage has since been repaired and work on *fuQ'yn hg'Lhi* appears to have recently restarted. Best estimates place its completion sometime around 2306. It is named after a legendary Klingon starship, which roughly translates from the Klingon Old Tongue into Federation Standard as "Imperial Ass-Kicker."

Schematics



qeyliS betleH class Klingon battleship created by 18 Degrees East for the *Klingon Academy* and *Starfleet Command* series of licensed videogames and inspired by material created by Stephen V. Cole for *Star Fleet Battles*

Additional background material courtesy of Activision Games, the *Klingon Academy* Forums, Hidden Agenda, Ed McShillay, and James Dixon

Visuals courtesy of Zambie Zan and Demon Renegade Studios

Schematics courtesy of Taldren

WoQ`a`

***mayDuj'a' type 3* [bur'd'kona type 14]** **[proposed - est. 2325]**

Specifications as built

Dimensions

Length: 680 meters
Beam: 528 meters
Height: 238 meters

Mass

Standard gross: 2,750,000 GMT (estimated)
Subspace displacement: 730,000 DWT (estimated)

Crew complement

Officers: 65
Enlisted: 615
Imperial Guards: 70 (in support of assault operations)

Top velocity

Cruising speed: warp 14 (estimated)
Rated maximum speed: warp 16 (estimated)

Endurance

Standard endurance: estimated 2 years at L.Y.V.

Armament

Disruptors: 22 standard disruptor banks
(6 F, 5 each P/S, 4 A)
Guided weapons: 6 heavy disruptors (all F)
1 assault disruptor (F)
8 heavy photon torpedo tubes (4 F/4 A)
6 drone racks*

(*) A *mayDuj'a's* drone racks are located in the upper wing pylon notches on both sides of the ship. This makes them part of any oversized Balth-type hull modules that could be removed and replaced with those of other types.

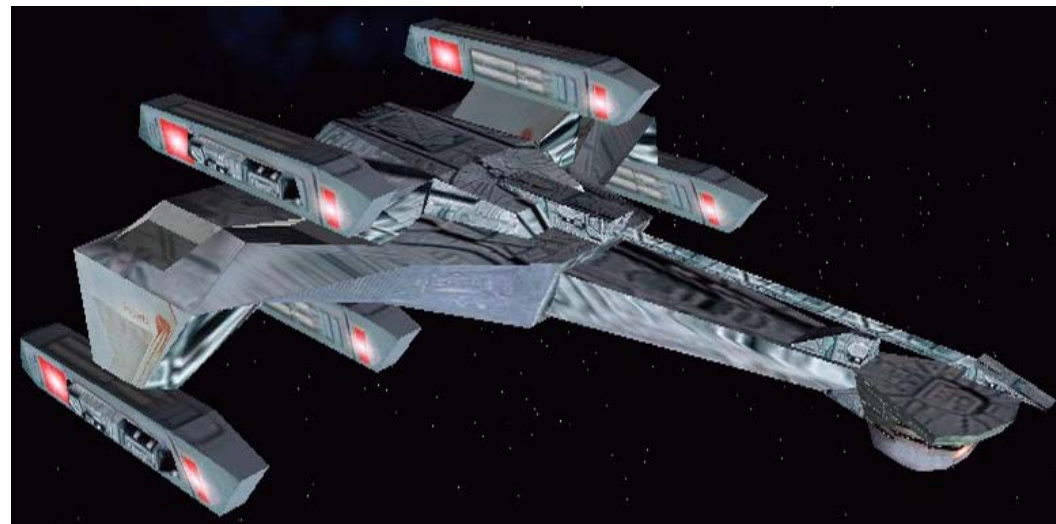

Known starships

Hull #	Name of starship	Builder	Status
KRB14-001	<i>WoQ`a' (Ultimate Power)</i>	Klinzhai Shipyards	pending
KRB14-002	<i>WoQ'uch (Ultimate Warrior)</i>	Klinzhai Shipyards	pending

The best way to describe *WoQ'a'* is as a slightly retooled *qeyliS BetleH*, redesigned in order to carry the *mayDuj'a'* program into the 24th century. Authorized in 2288, *WoQ'a'* has been placed on indefinite hold following the Praxis explosion of 2293. The High Council has understandably balked at such an expensive shipbuilding program, given the widespread devastation to home system resources caused by the Praxis Event.

A cursory glance of the proposed *WoQ'a'* specifications will immediately reveal a significant reduction in gross mass. This represents a reduced form factor secondary hull. It is more angular in configuration than that of its predecessor, hearkening back to the lines of the traditional *Drell*-type hull design. The *pljonta'* support pylons are noticeably thinner and the thickness of the outer wings appears to have been reduced by about 10% in volume in the affected sections. This new secondary hull still has plenty of room in its core for the theorized Balth modular hull component system. It would also appear that *WoQ'a'* could in theory use the same modules as *qeyliS BetleH*. One can only assume that improved construction techniques have eliminated the need for the older and thicker secondary hull members. Even with this reduction in volume *WoQ'a'*'s designers have managed to squeeze in extra disruptor mounts and heavy photon tubes, most likely in response to reports about the Federation *Yamato*.

It is very easy to confuse *WoQ'a'* with the earlier *qeyliS BetleH*, since the two have almost identical visuals. The key difference will be in the engines. *WoQ'a'* is supposed to have redesigned *pljonta'* that reflect improvements to the ones originally custom-built for *qeyliS BetleH*. They will also incorporate all of the modifications that had to be made to those of the three original *qeyliS BetleHs*, which gained a certain notoriety for irregular plasma flows during their first few years in Imperial service. According to reports these irregularities, the result of an overlooked design flaw, occurred whenever the ship's assault disruptor was being armed. They were sometimes so severe that power had to be shut down in selected sections of the ship in order to have enough energy to complete the arming sequence. *WoQ'a'*'s redesigned engines supposedly correct this issue as well as providing more efficient energy regulation, resulting in a reported 4% increase in available power during combat.

Starfleet Intelligence reports that the *WoQ'a'* class will be fitted with two technologies that are a first for a Klingon capital ship. The first is an anti-cloaking sensor system so powerful that it can accurately detect the location a cloaked ship of any size, even as small as a gunboat, within range of its disruptors. Existence of the development of such a system was first learned during the abortive Operation Dixie and more recent news from within the Empire claims that it is almost operational. This would be a

disturbing development for the Romulans if true, since even the most advanced tachyon net in use (by the Federation Starfleet) is at best a passive system that can only detect where a cloaked ship has been, not where it is now. The second is known simply as *mu'a'vomu* (tH. "glory"). In simplest terms it is reported to be a hyped-up self-destruct system so powerful that it can take out an asteroid or small planetoid at a reported range up to 100,000 kilometers. The typically fatalistic Klingon notion behind such a device is that if a *WoQ'a'* ever gets in a fight that it cannot win, it can at least take all of its attackers down with it. Most serious starship spotters tend to scoff at reports on the *mu'avomu* system. They debunk it as nothing more than Klingon propaganda – an attempt at creating a fictional Klingon kamikaze weapon in the same vein as Captain Kirk's famed corbomite bluff of 2266.

The Imperial High Command hopes to begin construction on up to 30 *WoQ'a'* class battleships once the Empire's internal infrastructure has sufficiently recovered from the Praxis explosion.

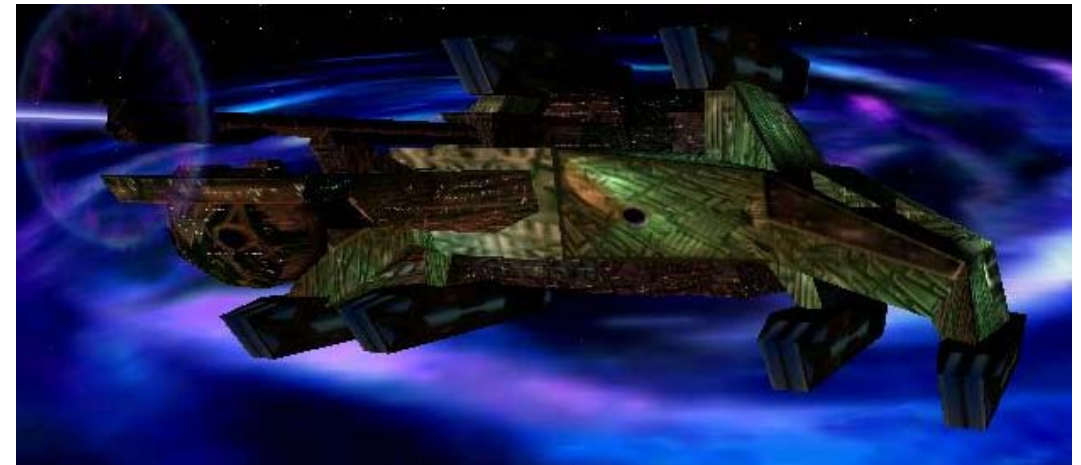

WoQ'a'* class Klingon battleship created by 18 Degrees East for the *Klingon Academy* and *Starfleet Command* series of licensed videogames based on material created by Stephen V. Cole for *Star Fleet Battles

Additional background material courtesy of Amarillo Design Bureau, Activision Games, the *Klingon Academy* Forums, Hidden Agenda, Edd McShillay, and James Dixon

Visuals courtesy of Anduril and Taldren

འཇམ་ཇུ་མོ་ལྷོ་ལྷོ་

Pocket Battleships

lat'd'kona (Kl. “Little Brute”) and
mayDujHom (tH. “Small Battleship”) series

Pocket Battleships

The *lat'd'kona* series “pocket battleships” may be smaller than their massive *bur'd'kona* brethren; nevertheless they are still battleships by design. The term roughly translates as “little brute” in Klingonaase, which is the role that the leaders of the Great Houses had in mind for them. The reduced size was meant to both ease construction and avoid the pitfalls that had plagued *bur'd'kona* type construction. Each of the *lat'd'kona* series battleships would serve to defend the glory of the Empire and increase the prestige of the House that developed it – and often built it as well, reaping a handsome profit for House coffers from the Imperial treasury in the process.

The actual performance of the various *lat'd'kona* series has been mixed. The drawbacks of the older *lat'd'kona* series 13 “Fat Man” are well documented. It is reported that the Great House that developed it fell out of favor with the Empire for at least a decade after early disastrous performances by the “Fat Man” against Romulan forces in the Triangle. The excellent *lat'd'kona* series 20 “Fang-Filled Maw” has been hampered only by its reportedly prohibitive construction costs. The newer *lat'd'kona* series 24 “Ever Victorious,” on the other hand, is widely regarded as one of the most balanced starship designs ever produced for its size. Starfleet Intelligence has come to respect this particular Klingon pocket battleship design, according it due measure whenever one is encountered on the borders of Klingon space.

It is reasonable to assume that more *lat'd'kona* series designs are in development, possibly building, in remote corners of the Empire far away from prying eyes.



A pair of *Lat'd'kona* series 24 *Komo Val* class battleships in formation. The one on the bottom is factory standard. The one on top has been modified with a third amidships warp engine, an improved armor and deflector grid, and additional photon weaponry. This was the first known image of the *Komo Val* “torpedo cruiser” modification at the time it was taken.

Kel ri`nada

***mayDujHom* type 1 (*lat'd'kona* type 13) [2271]**

Specifications as built

Dimensions

Length: 242 meters
Beam: 147 meters
Height: 110 meters

Mass

Standard: 629,250 GMT
Displacement: 158,900 DWT

Crew complement

Officers: 160
Enlisted: 878
Imperial Guards: up to 400 (in support of assault operations)

Top velocity

Cruising speed: warp 6.0
Rated maximum speed: warp 8.0

Endurance

Standard endurance: estimated 3 years at L.Y.V.

Armament

Disruptors: 12 standard disruptors (3 F/3 P/3 S/3 A)
4 heavy disruptors (all F)
Guided weapons: 2 photon torpedo tubes (1 F/1 A)
4 drone racks

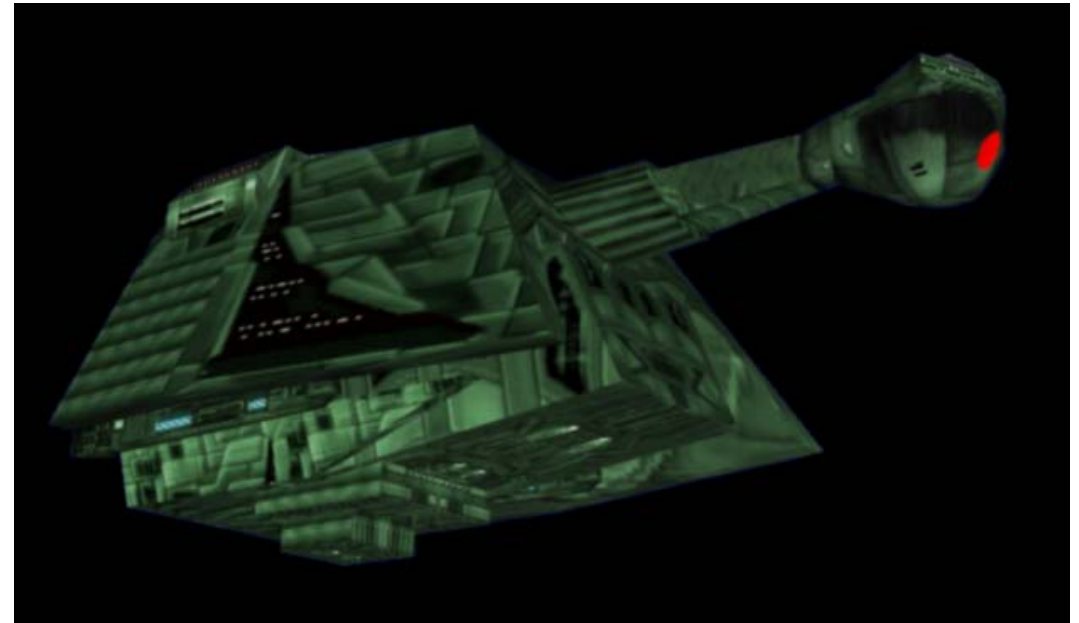

Known starships

Hull #	Name of starship	Builder	Status
KRL13-001	<i>Kel ri`nada</i> (<i>Dangerous Fat Man</i>)	Taamar Shipyards	active

The *lat'd'kona* series 13 “Fat Man” was the first real attempt by any of the Great Houses at fielding a battleship class worthy of Imperial service. Most of the previous designs had not even made it off the drawing boards and only a fortunate few, such as the L-11 *bi'IQ'a veq'larga* (tH. “Leviathan”) had made it to prototype stage before they were ultimately abandoned. The “Fat Man” was the only one that cleared all of the design, prototype, and acceptance hurdles laid before it by the Klingon High Command. It was the first battleship class since the end of the Four Years War to enter Imperial service, with the class ship being commissioned on 6 February 2266. In retrospect, perhaps it should not have entered at all.

On 14 April 2271 the *Kel ri'nada*, accompanied by six Klingon destroyers, attacked a Romulan border fleet near the Triangle without provocation. The Klingon fleet commander was eager to see the capabilities of his brand new battleship tested in combat. His overconfidence was a mistake that almost cost him his life. By the time hastily called Klingon reinforcements arrived to help their fleet disengage the Romulans had seriously damaged the *Kel ri'nada* and destroyed three of its escorts. The Romulans lost only one destroyer, with one other and one of its cruisers taking moderate damage. To add insult to injury the Romulans returned to the field of battle shortly after the Klingon retreat and managed to tow away a damaged *Jul'kar* (from the reinforcement fleet) that had been disabled covering the *Kel ri'nada's* retreat. The commander of the *Kel ri'nada* was promptly sacked and sentenced to command of a penal frigate on the Cardassian border, where (according to reports) his eventual death was swift and inglorious.

It is now widely believed that the only reason the “Fat Man” was ever allowed to enter service was to prove that a Great House was capable of both designing and building a battleship-class starship. More successful designs, in particular that of the House of Kinzan, would follow in the years to come.

The “Fat Man” is nowadays considered more of a nuisance than a true threat. It is the butt of many jokes within the Empire and without. The Klingons have taken to referring to the class as the *epetai-ri'nada* (Kl. “glorious fat man”), which in Klingonaese is a rather nasty commentary on its combat performance. Starfleet crews have their own nickname for it: the “space turtle.” It is slow, fairly unmaneuverable, and has poor weapons arcs despite numerous upgrades. It is better at taking abuse than receiving it; however, this fact has been turned to Klingon advantage.

A favorite Klingon tactic of the late 2270s was to send a lone, unprotected *Kel ri'nada* into a part of space where the Klingons knew it would be attacked. This tactic would usually draw out most combat-eager enemy forces in the area hoping for the chance to take out a major Klingon

capital ship. The *Kel ri'nada's* ability to take tremendous amounts of punishment meant that it would last long enough for Klingon reinforcements to arrive and sweep the field clear of the enemy. This tactic is still used, albeit with other starship classes, to bait unsuspecting enemy forces along all Klingon borders. This is known as the Triangle Gambit, so named after the *Kel ri'nada's* first combat encounter.

The thorough routing of its newest starship class by a supposedly inferior Romulan force caused the House of Ghamzal to halt *Kel ri'nada* production in mid-stride in May of 2271 after only four vessels. *Kel ri'nada* itself was rebuilt to a modified design (due to battle damage reconstruction) quite unlike the rest of her class. For this she was given the *Lat'd'kona* series 13B designation by Starfleet Intelligence. The other three *Kel ri'nadas* already constructed were hastily refitted with improved warp engines and more powerful disruptors, forming the series 13C sub-class. The remaining seventeen *Kel ri'nadas* eventually constructed were of the series 13D design, with even more changes and improvements.

Only one *Kel ri'nada* has been lost, and that was when its “rescuers” failed to arrive in a timely manner. The remaining twenty continue to operate in the service of the Empire. One or more *Kel ri'nadas* can be found in every Klingon border and internal defense fleet save the Bloodwatch. They are considered sub-par by modern standards and normally employed as dreadnought and battleship training vessels. It is also not uncommon to find a *Kel Re'nada* operating as a command ship during fleet operations when more modern vessels of its size class are otherwise engaged. In such cases one will find it always to the rear, with faster and more capable designs deployed to protect it. On rare occasions a *Kel ri'nada* can be found on “planet punishment” missions where threats by outside forces are considered insignificant.

***Kel ri'nada* class Klingon battleship created by Forrest G. Brown and Dana Knutson for FASA Corporation's STAR TREK – The Role-Playing Game under license from Paramount Pictures**

Additional background material courtesy of Brad Torgerson

Visual courtesy of Lord Delakhan

Keth Ke Se

***mayDujHom* type 2 (lat'd'kona type 20) (2272)**

Specifications as built

Dimensions

Length: 250 meters
Beam: 181 meters
Height: 70 meters

Mass

Standard: 616,250 GMT
Displacement: 156,380 DWT

Crew complement

Officers: 57
Enlisted: 430
Imperial Guards: up to 200 (in support of assault operations)

Top velocity

Cruising speed: warp 8.0
Rated maximum speed: warp 11.2

Endurance

Standard endurance: 3 years at L.Y.V.

Armament

Disruptors: 8 standard disruptors (2 F, 2 A, 2 ea. P/S)
2 heavy disruptors (both F)
Guided weapons: 3 photon torpedo tubes (1 F, 2 A)
4 drone racks

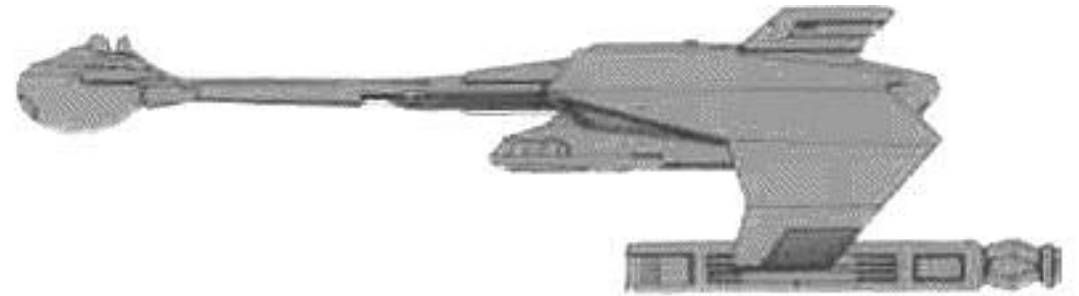

Known starships

Hull #	Name of starship	Builder	Status
KRL20-001	<i>Keth Ke Se (Fang-Filled Maw)</i>	Mustaka Shipyards	active
KRL20-002	<i>Virkon (King of Battle)</i>	Mustaka Shipyards	active
KRL20-003	<i>Q'o'nos Cha? (Kronos Two?)</i>	Mustaka Shipyards	active

While the Klingon pocket battleship program had its faults, such as the *Lat'd'kona* type 13 "Fat Man," it also had its brighter moments. The brightest of these was the *lat'd'kona* type 20 *Keth Ke Se* (Kl. "Fang-Filled Maw"), arguably the best Klingon pocket battleship of its generation. Its successes would go on to inspire the subsequent type 23 *Komo Val* series.

Keth Ke Se was the most expensive ship in the history of the Klingon Empire at the time of its completion in July of 2272. It was the product of the House of Kinzan and designed by its foremost warrior, Captain Kangar (sutai Kinzan). Kangar had one goal in mind when he created the *Keth Ke Se*. It was to outgun and outperform both Starfleet's *Federation* class dreadnought and any potential successor by the time *Keth Ke Se* was ready to launch. His guiding design principle was simple: if cost was no object, then anything was possible.

The House of Kinzan used up a considerable portion of its treasury in building *Keth Ke Se*. This enormous outlay of resources justified itself almost immediately after the starship was launched. It was promptly sent into the Triangle looking for a fight in the same manner as had been the less fortunate *Kel ri'nada* only days before. This time, however, the outcome was quite different. The *Keth Ke Se* and her fleet completely wiped out a Romulan squadron down to the last ship and crewmember. The new battleship was credited with three kills of its own, those being both of the Romulan squadron's heavy cruisers and one of its support vessels. *Keth Ke Se* emerged without a scratch, thus immediately establishing a record of excellence for its design that continues to this day.

Keth Ke Se is the direct ancestor of the highly regarded *Komo Val*. It is not as versatile as its successor; however, as a pure combat vessel it is still one of the best in the Klingon fleet. The number and strength of its main disruptor batteries alone are capable of crippling most capital ships if brought to bear in quantity. Multiple fore and aft photon torpedo tubes (the technology was still something of an innovation for the Klingons at the time of launch) add a deadly finishing punch to this one-two assault combination. *Keth Ke Se* is fully capable of destroying any vessel of light cruiser size or smaller from almost any firing angle with its armaments, just as designed, thus truly earning its name of the "Bite of Many Fangs."

Oversized warp and impulse engines were deliberately fitted to the *Keth Ke Se* for both ample power and in anticipation of remaining a combat-capable vessel within its classification for decades after its launch. Captain Kangar's choice was wise, if expensive, because it gave his ship power to spare for all of its onboard systems. This was both a luxury and novelty for Klingon vessels at the time; however, the continued,

consistently excellent performance of both *Keth Ke Se* and its successor *Komo Val* have caused the Klingons to rethink the concept.

There is only one known variation of the *Keth Ke Se* to date. The *Virkon* (Kl. "King of Battle" is only the second ship of this class ever spotted. It appears to have been built by the House of Kinzan on special order for the Imperial Fleet in response for lending technical assistance in development of the *Komo Val*. It apparently entered Imperial service in 2279. It differed from the original *Keth Ke Se* design in that an enlarged, through-deck shuttle bay had been fitted to the underside of the secondary hull. The design was such in that it remained well clear of the design's warp engines, thus allowing the *Virkon* to retain normal *Drell* type hull warp dynamics. *Keth Ke Se* was backfitted with a similar hanger in 2281. The hanger modification appears to have been developed in response to the space control ship capabilities of the Federation *Excelsior*.

Both *Keth Ke Se* and *Virkon* remain in active Imperial service as of this date. There are also unconfirmed reports that a third hull has been ordered. As with the *Virkon* it is reported to be a custom job. This time the buyer is none other than the Chancellor's Office. The intention appears to be for this third *Keth Ke Se* to replace *Kronos One* as the flagship of the Empire. This third *Keth Ke Se* has been unofficially dubbed *Kronos Two* by Starfleet Intelligence, although its true name remains unknown.

It is unlikely that more *Keth Ke Ses* will be built any time soon or in great quantity. *Komo Val* was designed to be a more cost-effective alternative to *Keth Ke Se*, yielding similar performance without its high maintenance and crew training issues. Bear in mind that the House of Kinzan designed *Keth Ke Se* as the ultimate *Drell* refinement in terms of maximum firepower with only limited sacrifices in acceleration or agility. Furthermore, each *Keth Ke Se* is custom built and always integrates the latest in Klingon starship technology so that it can remain a viable ship of the line for far longer than its typical Imperial counterpart.

Schematics

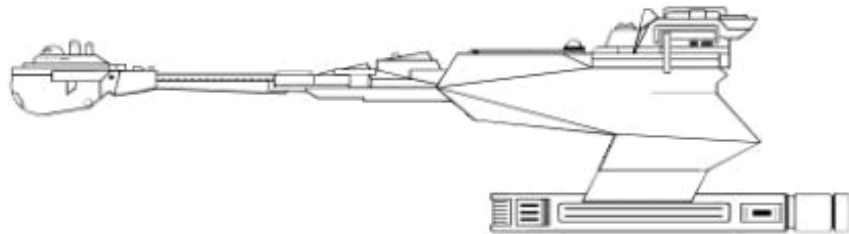
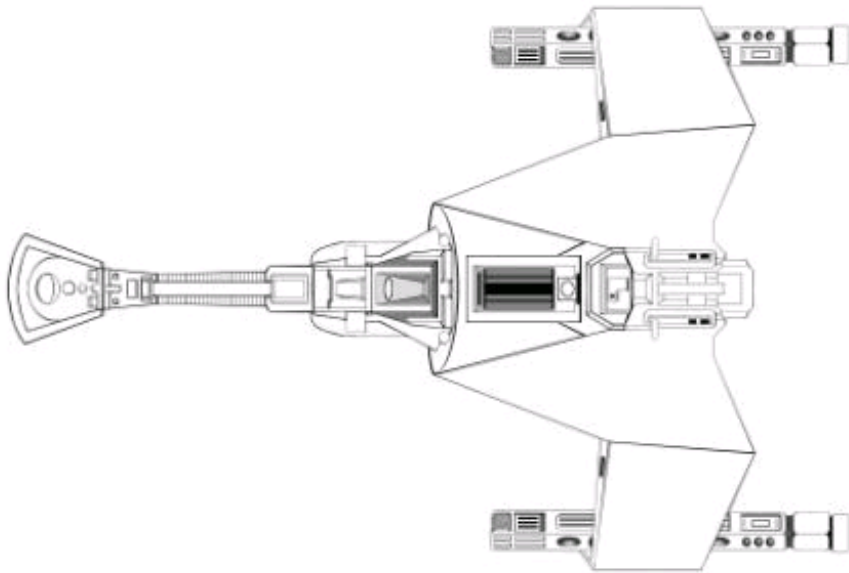

Keth Ke Se as launched (2272)

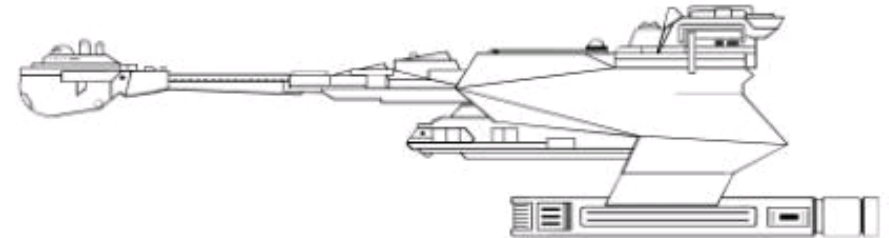
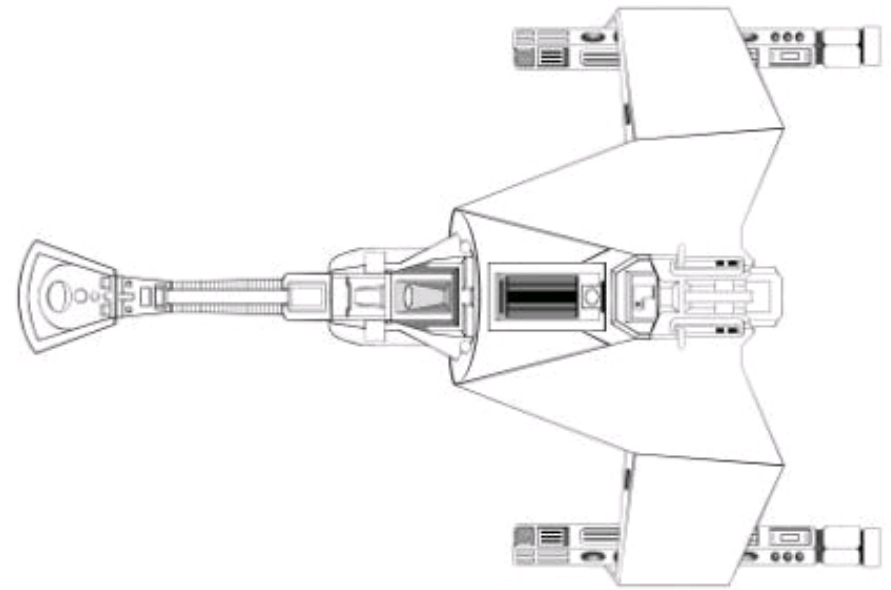

Virkon as launched (2279). Note the addition of the ventral hangar bay.

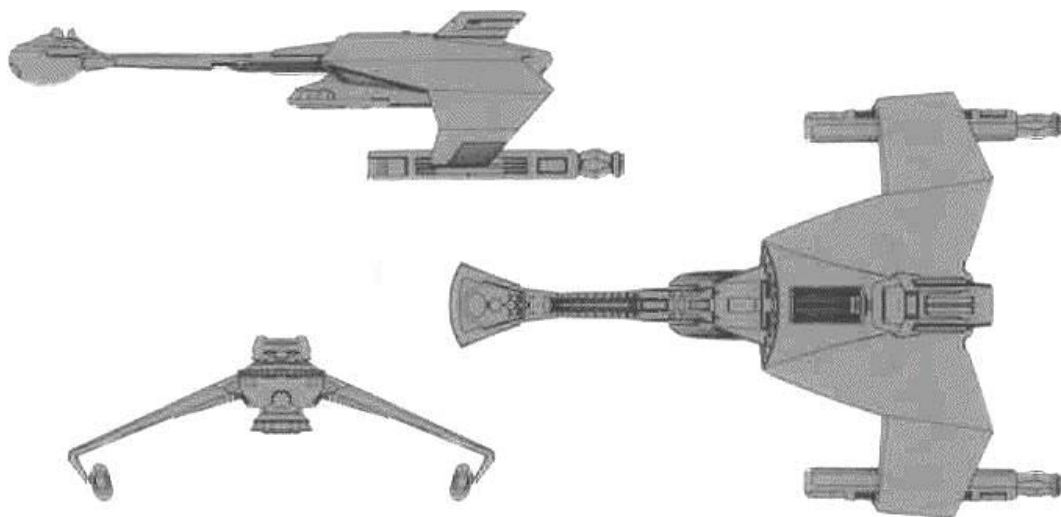

***Keth Ke Se* class Klingon battleship created by Forrest G. Brown and John Stevens for FASA Corporation's *STAR TREK – The Role-Playing Game* under license from Paramount Pictures**

Additional background material courtesy of Brad Torgerson and Bernard Guignard

Schematics by Dana Knutson (FASA) and James H. Smith (redraws)

Komo Val

mayDujHom type 3 (*lat'd'kona* type 24) (2287)

Specifications as built

Dimensions

Length: 320 meters
Beam: 190 meters
Height: 105 meters

Mass

Standard: 813,200 GMT
Displacement: 214,000 DWT

Crew complement

Officers: 113
Enlisted: 837
Imperial Guards: up to 480 (in support of assault operations)

Top velocity

Cruising speed: warp 7.0 (8.5 for "torpedo cruiser")
Rated maximum speed: warp 9.0 (10.5 for "torpedo cruiser")

Endurance

Standard endurance: 5 years at L.Y.V.

Armament

Disruptors: 16 standard disruptors (standard configuration,
4 always available in cont. coverage arcs)
4 heavy disruptors (2 F/1 F&P/1 F&S)
Guided weapons: 4 photon torpedo tubes (2 F/2 A)
4 extra photon torpedo tubes (4 F)
("torpedo cruiser" mod only, see notes)



Known starships

Hull #	Name of starship	Builder	Status
KRL24-001	<i>Komo Val (Eternal Victory)</i>	Taamar Shipyards	active
KRL24-002	<i>Komo Gal (Eternal Glory)</i>	Taamar Shipyards	active
KRL24-003	<i>Komo Lar (Eternal Defender)</i>	Taamar Shipyards	active
KRL24-004	<i>Komo Mara (Eternal Justice)</i>	Taamar Shipyards	active
KRL24-005	<i>Komo Sarza (Eternal Swiftness)</i>	Taamar Shipyards	active
KRL24-006	<i>Komo Hesta (Eternal Provocateur)</i>	Taamar Shipyards	lost
KRL24-007	<i>ta'Oeh (Emperor's Anger)</i>	B'Treliq Shipyards	active
KRL24-008	<i>baHjev (Firestorm)</i>	B'Treliq Shipyards	active

While the Imperial Klingon fleet was impressed with the House of Kinzan's *Keth Ke Se* design, it was still not quite the heavy capital ship they wanted to fill the "battleship gap" caused by the innumerable delays in the *Kar'hamer* program. To meet the need they enlisted the aid of the House of Kinzan in designing a Klingon ship of the line larger than the *K'herr* class dreadnought but as agile as a *Drell* type battlecruiser. *Keth Ke Se* was used as the basis for this design, upsized and altered slightly in hull form to meet Imperial fleet requirements. The end result was *Komo Val* (Kl. "Eternal Victory"), widely regarded as one of the best Klingon "fast battleships" ever put into production.

Komo Val entered service just before the Federation began final testing of its *Excelsior* class space control ship. For a brief time, until *Excelsior* production actually commenced, the Klingons fielded the most powerful capital ship in known space. *Komo Val* is still a formidable opponent for any starship of similar class, although more recent Federation designs such as the *Missouri* have left it behind.

The design debt that *Komo Val* owes to its predecessor *Keth Ke Se* is obvious when one views the schematic. It has some of the cleanest lines for a Klingon fleet "heavy," thus avoiding the acceleration and performance losses suffered by its larger *bur'd'kona* brethren. It is in effect an enlarged *Keth Ke Se* with a "bulged" secondary hull. The extra hull volume is used to mount additional weaponry and extra ship's systems that could not be fitted into *Keth Ke Se's* *Drell* configuration, thus increasing its operational versatility. Among the items added was an exact copy of the *K'herr's* C3 fleet operations suite, thus enabling *Komo Val* to act as both command ship and operations center for fleet-sized exercises.

The layout of *Komo Val's* disruptor banks was designed to provide continuous coverage with at least four banks available from any angle. In other words, it has no blind spots in its disruptor firing arcs, only the "traditional" aft weak spot where its heavy disruptors cannot track (and this is protected by photon torpedo coverage). Extra heavy weapons, in the form of heavy disruptors, are used in conjunction with photon torpedoes to provide the required forward punch of traditional Klingon naval designs.

In tactical terms the *Komo Val* is an even match for a *Excelsior*. Upgrades have allowed it to keep pace with *Excelsior's* own, thus maintaining parity between these two spacegoing ships of the line.

There are at least two documented variations to date on the base *Komo Val* design. There is a fleet standard weapons and engines upgrade that was first observed last year. There is also the "torpedo cruiser" variant, which adds four additional photon torpedo systems (at the expense of its amidships disruptor battery and troop barracks) as well as a third warp

engine to help power them. Starfleet Intelligence speculates that the rest of the *Komo Val* class will eventually be backfitted to this configuration or a modification thereof.

Schematics

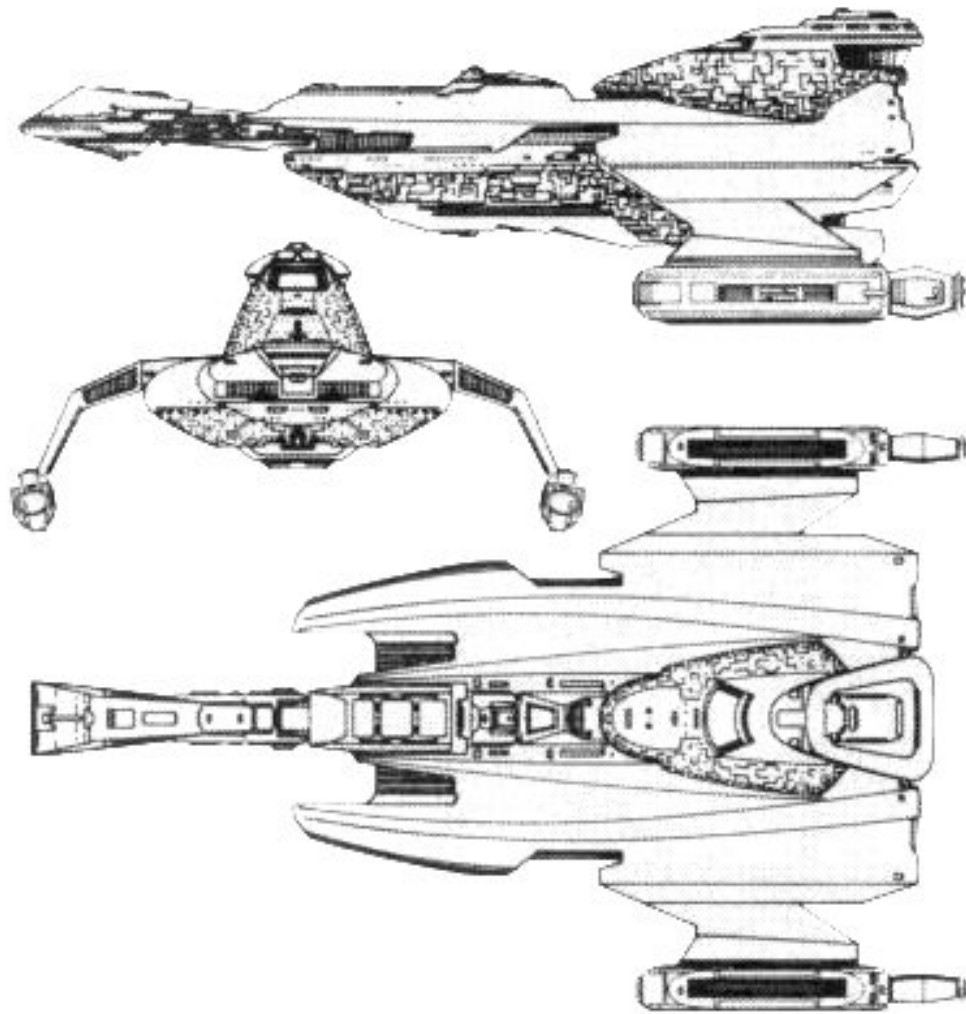

Komo Val as launched (2287)



Komo Val "torpedo cruiser" variant. The inclusion of the third warp engine and additional photon torpedo systems breaks up the continuous coverage arcs of the ship's disruptors in the original design. The power and offensive punch gained by the modification is believed to more than make up the difference.

***Komo Val* class Klingon battleship created by Forrest G. Brown and Dana Knutson for FASA Corporation's *STAR TREK – The Role-Playing Game* under license from Paramount Picture**

"K-24C torpedo cruiser" variant by Daniel Haughton

Additional background material courtesy of Amarillo Design Bureau, Activision Games, the *Klingon Academy* Forums, Daniel Haughton, and James Dixon

Visuals courtesy of Atrahasis and Starforce Productions

Schematics by Dana Knutson



Dreadnoughts

chesis d'kleon (Kl. “Havoc Wrecker”) and
qughDuj'a' (tH. “Ultimate Cruiser”) series

Dreadnoughts



Jul'kar, precursor of the modern Klingon dreadnought

The Klingon Empire deserves credit for creating the modern starship dreadnought. The *Jul'kar* class was originally built as the first Klingon *bur'd'kona* (battleship) as a means of overpowering the superior designs of Federation starships. The limited Klingon starship technology of its day, however, coupled with a critical design flaw (the layout of its warp engines) instead resulted in a vessel that was merely the equivalent of Starfleet's best -- the *Constitution* class heavy cruiser. *Jul'kar* would remain at the forefront of the Klingon forces for many years; however, Klingon designers were already looking beyond its flaws to the next generation.

Starfleet Command had always looked askance at Klingon attempts to create a starship larger than a battlecruiser, based on experience with the *Jul'kar* and available intelligence reports. It is not surprising, then, that the spectacular debut of the *K'herr* class dreadnought in 2278 caught them

completely flat-footed. Not even Starfleet's new *Enterprise* class heavy cruisers, with their advanced linear warp technology, were capable of taking on a *K'herr* in single combat with any hope of surviving the encounter. There was nothing in Starfleet's inventory of vessels that came even close to matching the *K'herr* in terms of firepower or overall combat performance. *K'herr* set the new standard for interstellar dreadnoughts, and it would not be long before the Federation would respond with *Excelsior*. In the meantime, however, the entry of the *K'herr* into Imperial service finally gave the Klingon High Command the time they needed to sort out their affairs with the politicians and get the long-delayed *bur'd'kona* program back on track.

The success of the *K'herr* prompted the Klingons to develop a successor class. *Vodleh* (tH. "Emperor") is often referenced by the Klingons themselves as a heavy battlecruiser, yet it more properly falls under the definition of dreadnought. Its role is certainly such, replacing *K'herr* on the production schedule and apparently scheduled to assume the fleet service duties once held by *K'herr* class dreadnoughts. This dreadnought class, scaled-down take on the *WoQ'a* is widely regarded as one of several starship classes that are believed to show the way towards the future of Klingon designs regarding possible 24th century ships of the line.

Kuyper, the upgraded form of the original *Jul'kar*, is still serving today in its new role as a *chesis d'kleon*. Although the base design is no longer the front-line "heavy" of its youth, it has been extensively upgraded for modern starship combat. It has found new life as a fleet dreadnought, and its technology upgrades still make it a fearsome opponent for all but the most modern and heaviest armed enemy vessels. Both *Jul'kars* and *Kuypers* remain quite popular with the lesser Klingon Houses as flagships for house fleets. This is due to the simple fact that they cannot afford newer and more powerful designs, such as *K'herr* or *Komo Val*. It is in this regard that one can still come across both *Jul'kars* and *Kuypers* leading patrol fleets along the Klingon borders.

Kuyper

qughDuj'a' type 1 (*chesis d'kleon* type 5) [2274]

Specifications as built

Dimensions

Length: 242 meters
Beam: 142 meters
Height: 69 meters

Mass

Standard gross: 774,250 GMT
Subspace displacement: 195,000 DWT

Crew complement

Officers: 62
Enlisted: 336
Imperial Guards: up to 50 (in support of assault operations)

Top velocity

Cruising speed: warp 9
Rated maximum speed: warp 12

Endurance

Standard endurance: estimated 3 years at L.Y.V.

Armament

Disruptors: 9 standard disruptors
Guided weapons: 3 photon torpedo tubes
2 drone racks
cloaking device



Known starships

Hull #	Name of starship	Builder	Status
KRC05-001	<i>Khamin Kuyper</i> (Captain Kuyper)	Taamar Shipyards	active
KRC05-002	<i>Khamin Kurtl</i> (Captain Kurtl)	Taamar Shipyards	active

Tactically *Kuyper* is nothing more than an upgunned battlecruiser. It is sometimes referenced as a light dreadnought by Starfleet Intelligence in comparison to newer and more powerful classes. In fact *Kuyper* is an aging design, based on the B-1 *Jul'kar* battleship of the 2250s, whose best days are behind it. It has long since been surpassed by superior designs in almost every category. In spite of this the Klingons still find it useful, and its operational similarities to other *Drell*-derived types practically ensured its continued use. *Kuypers* are present on every border and serve in a variety of roles.

In 2272 the Klingon High Command commissioned the production of 24 new uprated versions of the older *Jul'kar*, this time of *chesis d'kleon* classification, to beef up fleet "heavy" numbers. Several reasons were named for this move: the loss of over a dozen original *Jul'kars* in various wars over the decades, delays in the *bur'd'kona* program, problems with the *lat'd'kona* program (and the *Kel ri'nada* in particular), delays in developing a new *chesis d'kleon*, and (above all) the relative cheapness in producing a modernized *Jul'kar*. The fact that an old-style *Jul'kar* fitted with an experimental heavy weapons system had been handily destroyed in 2272 by the V'ger entity (during its trip through Klingon space) appears to have been a major factor behind this decision, although the Klingons have yet to admit this. These new hulls would enter service as the C-5 *Kuyper* class *chesis d'kleon*. This move was seen as a stopgap measure while *K'herr*, the "real" *chesis d'kleon*, transitioned from the development stage to actual construction.

Externally *Kuyper* bears a striking resemblance to the contemporary *K't'inga* and *Suwvl'qeh* classes, with their extensive armor/deflector plating and new warp engines. Internals were simplified considerably thanks to advances in Klingon starship technology over the past 2½ decades, reducing crew requirements from *Jul'kar's* 500 to *Kuyper's* 408. The extra space was used for the fitting of barracks and cryosleep facilities in order to support troop operations. Modern warp engines and weapons systems from the ongoing *K't'inga* program were also installed. Finally, the old-style heavy disruptor mounts were traded for the Klingon version of photon torpedoes, which had already proven themselves to be more effective weapons in combat.

A number of *Kuyper* style conversions were discussed for older B-1 *Jul'kars* in order to maintain their service with the Empire for as long as possible. None of these were ever officially carried out insofar as is known. Unconfirmed reports indicate that many of the older *Jul'kars* owned by the Lesser Houses have been uprated to as close to the *Kuyper* standard as their aged frames and House treasuries will permit.

Production of *Kuyper* commenced in 2272, with the lead ship joining the fleet in 2274. The last entered Imperial service in 2284. *Kuypers* in Imperial service are named for famous fleet commanders. The naming of House-owned *Kuypers* tends to follow in similar fashion, typically names after famous warriors or heroic figures in House history.

Of the 24 *Kuypers* known to have been built, at least 4 have been destroyed or lost on various missions, cause undetermined. The rest remain in service, supplementing the fleet's newer dreadnoughts or serving as flagships for the fleets of the Lesser Houses. No more are planned, as *Kuyper* was long ago surpassed by newer and more capable designs.

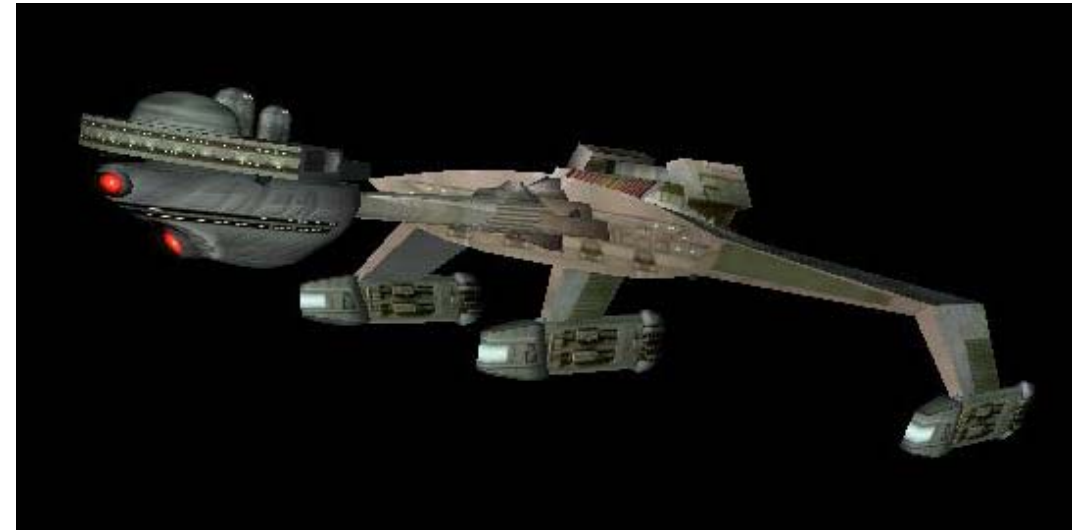

Jul'kar class Klingon battleship originally created by Patrick Flannery
for the *Star Fleet Handbook* fanzine by Geoffery Mandel
Kuyper TMP-era upgrade configuration by Terradyhne

Jul'kar class designation by Eric Kristiansen (*Jackill's*)

Star Fleet Battles C-5 "light dreadnought" conversion by Amarillo Design Bureau

Additional background material courtesy of Amarillo Design Bureau,
Marvel Comics, James Dixon, and Atrahasis

Visuals courtesy of Terradyhne

K'herr

***qughDuj'a'* type 2 [*chesis d'kleon* type 8]** **[2278]**

Specifications as built

Dimensions

Length: 337 meters
Beam: 220 meters
Height: 90 meters

Mass

Standard gross: 861,750 GMT
Subspace displacement: 225,000 DWT

Crew complement

Officers: 100
Enlisted: 425
Imperial Guards: up to 100 (in support of assault operations)

Top velocity

Cruising speed: warp 9
Rated maximum speed: warp 13

Endurance

Standard endurance: estimated 3 years at L.Y.V.

Armament

Disruptors: 14 standard disruptors
3 heavy disruptors
Guided weapons: 2 photon torpedo tubes
4 drone racks
cloaking device



Known starships

Hull #	Name of starship	Builder	Status
KRC08-001	<i>TuQ K'herr (House of K'herr)</i>	Taamar Shipyards	active
KRC08-002	<i>TuQ Kang (House of Kang)</i>	Chenwl' Duj Shipyards	active
KRC08-003	<i>TuQ Mortak (House of Mortak)</i>	Taamar Shipyards	active
KRC08-004	<i>(Vindicator)</i>	Taamar Shipyards	active
KRC08-005	<i>(Harbinger)</i>	Chenwl' Duj Shipyards	active
KRC08-006	<i>(Terror)</i>	Chenwl' Duj Shipyards	active
KRC09-001	<i>Qapchu' (Decisive Victory)</i>	Taamar Shipyards	active
CHRC09-02	<i>veQlargh (Demon Beast)</i>	Chenwl' Duj Shipyards	sold-R
KRC09-003	<i>(Atrocity)</i>	Taamar Shipyards	active
KRC09-004	<i>TuQ K'lalek (House of K'lalek)</i>	Chenwl' Duj Shipyards	active
KRC09-005	<i>TuQ Kruge (House of Kruge)</i>	Chenwl' Duj Shipyards	active

The *K'herr* class represents a substantial improvement over the *Jul'kar* class, staking a solid middle ground between the *Jul'Kar* and *bur'd'kona/lat'd'kona* series as the definitive *chesis d'kleon* design.

The design for the *K'herr* class is said to have been inspired by the *betleH*, a former *Jul'kar* class battleship whose command boom was destroyed during a fierce battle with Federation forces in 2252. Its owner, lacking the resources to obtain another *Jul'kar* boom, simply had a *Drell*-type boom installed in its place and continued to use the *betleH* as a command cruiser instead. Not long after the Klingon High Command became enamored of the notion of an upsized, upgunned *betleH*, one that might serve ably as a *bur'd'kona* in its own right. Once the *Kar'hamer* program ran into numerous delays then the Klingon High Command began to reconsider its approach. The increasing age of *Jul'kar* also made it clear that there would be a "battleship gap" with the Federation and the Romulans within a very short time. The last straw in the Klingon hat, so to speak, was V'Ger's unchecked flight straight through several of the key systems of the Klingon Empire despite their best efforts to stop it. The Klingons threw the best they had at it, including a squadron of their new *K't'inga* class battlecruisers and a *Jul'kar* refitted for experimental weapons testing. This accomplished nothing except the loss of every single ship sent after V'Ger. Once again Klingon pride was wounded, as if salt were being rubbed into the wounds of its collective psyche suffered during the invasion of the Hurq centuries before. Given this, one should not be surprised at the rapid development of Klingon "heavies" in the 2270s and 2280s. *K'herr* was but one of these designs, worked out years before, awaiting only the opportunity for development. The new *chesis d'kleon* program, created in the wake of V'Ger's passing, ensured that *K'herr* would soon see Imperial service, and it would quickly establish itself as the standard by which all other dreadnoughts would be measured.

K'herr is essentially an upsized and upgunned *Kuyper* for all intents and purposes. The problems inherent with *Kuyper's* tri-engine design have been overcome with a new generation of *pljonta'* that can adjust for the warp field imbalances created by such a configuration.

As proposed *K'herr* would have had its center *pljonta'* mounted on the command boom itself. This would have provided it with the first warp-capable command boom in the history of the Empire, and was a feature obviously copied from Starfleet's *Federation* class dreadnought. This configuration was abandoned on the personal order of Chancellor Lotar, who did not want "to give commanders with no honor any chance of fleeing a fight." It is widely believed that at least one such *K'herr* prototype, the *Kragg Dor* (a *Kuyper* modified with a warp-capable boom)

was completed prior to Lotar's orders based on currently available intelligence; however, its current whereabouts remain unknown.

Certain of the starships in the *K'herr* class are named for the Greater Houses of the Empire. Per Klingon fleet nomenclature the full title of such a ship would include "House of," such as *TuQ K'herr* (tH. "House of K'herr"). The "House of" is usually dropped for informal reference, purposes of discussion, or normal starship operations.

There are two major design variations of the basic *K'herr* design. *Chesis d'kleon* type 8 is the more popular and common of the two, being the more heavily armed. *Chesis d'kleon* type 9 trades selected armaments for extra storage holds, increasing cargo capacity and thus extending the ship's potential range. This latter version was originally extended to operate on the far reaches of the Empire, such as the Treaty Zone with the Federation; however, with the Federation commencing fleet-wide upgrades of its own starships the *chesis d'kleon* type 9 has largely fallen out of favor. Most of them have since been converted back to a type 8 configuration or to one or more specialty sub-variants.

There are almost a half-dozen known *K'herr* variants in Klingon service. Almost all of these involve only one or two vessels and are usually House modifications designed to suit the needs of their owners. Type 9 hulls are the ones most frequently converted for reasons mentioned above, although the occasional type 8 conversion is not unknown. Known variants include heavy fleet carrier, space control ship, "stasis dreadnought," and "heavy gunship." At least one, *veQlarch* (tH "Demon Beast," hull number CHR09-002) was sold to the Romulans and refitted with plasma weaponry to suit their operational needs. Other minor modifications exist and vary from House to House. A fleetwide *K'herr* upgrade is reportedly planned for the turn of the century in order to maintain theoretical superiority over comparable Federation and Romulan designs.

There are reports that *Kolor*, a new design based on *K'herr*, is being developed as the Klingon empire's first dedicated 24th century dreadnought. There are also reports that *Kolor* will field heavy photon torpedoes in place of the standard versions employed on all *K'herrs* in Klingon service.

Ten of the eleven *K'herrs* known to have been built continue in Imperial service as of this date. *veQlarch* remains a one-of-a-kind vessel in the Romulan Space Navy due to the collapse of the Klingon-Romulan alliance. The whereabouts of *Kragg Dor*, the supposed *K'herr* prototype with its warp-capable command boom, remain unknown as of the date of this document's publication.

Schematics



K'herr class Klingon dreadnought created by Steven V. Cole for Amarillo Design Bureau's *Star Fleet Battles* role-playing game *Klingon Academy* conversion and visuals by Hidden Agenda

Kragg Dor prototype and visuals by Scottish Andy and Klingon Fanatic
Derived from the B-1 *Jul'kar* by Patrick Flannery

Additional background material courtesy of Amarillo Design Bureau

Schematics courtesy of the STCSS II web site.

Visuals courtesy of Battleclinic.com

voDleH

***qughDuj'a'* type 3 [*chesis d'kleon* type 10]** **[2283]**

Specifications as built

Dimensions

Length: 412 meters
Beam: 223 meters
Height: 120 meters

Mass

Standard gross: 915,000 GMT
Subspace displacement: 235,000 DWT

Crew complement

Officers: 90
Enlisted: 360
Imperial Guards: up to 55 (in support of assault operations)

Top velocity

Cruising speed: warp 10
Rated maximum speed: warp 14

Endurance

Standard endurance: estimated 3 years at L.Y.V.

Armament

Disruptors: 13 standard disruptors (4 F, 3 A, 3 ea. P/S)
Guided weapons: 1 heavy photon torpedo tubes
2 drone racks
Other: 4 FMPA generators (2 F, 2 A)
cloaking device

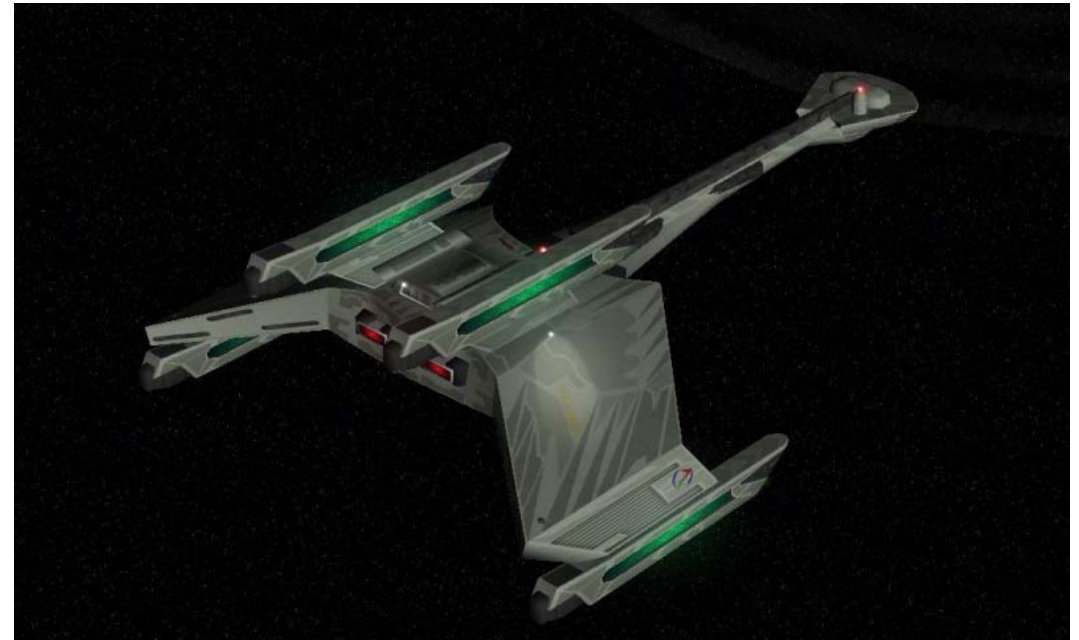

Known starships

Hull #	Name of starship	Builder	Status
KRC10-001	<i>voDleH (Emperor)</i>	Chenwl' Duj Shipyards	active
KRC10-002	<i>charghwI' (Conqueror)</i>	Chenwl' Duj Shipyards	active
KRC10-004	<i>tiQghoB (Inescapable)</i>	Chenwl' Duj Shipyards	active
KRC10-007	<i>ghalthI' (Dominator)</i>	Chenwl' Duj Shipyards	active
KRC10-009	<i>qeyliS (Kahless)</i>	Chenwl' Duj Shipyards	active
KRC10-014	<i>toy'wImoH (Subjugator)</i>	Chenwl' Duj Shipyards	active
KRC10-019	<i>Kolor (Dangerous Warrior)</i>	Chenwl' Duj Shipyards	susp.

voDieH is the successor to *K'herr*, the most formidable dreadnought of its time and which has spawned an even more formidable descendant. It is essentially a quad-engined *K'herr*, with four *pljonta'* instead of *K'herr's* three and with uprated armament to match. The fact that it followed less than a decade after *K'herr's* dramatic unveiling (and from the same shipyard, no less) indicates that the concept for *voDieH* was already brewing in its designer's mind even as Starfleet's linear warp generation was beginning to make its presence felt on the interstellar field of battle.

In 2280, a mere three years after *K'herr* first struck fear into the hearts of the Empire's foes, its designer submitted the plans for *voDieH* to House Yok'tu. Master designer Jogh Kenka was the genius behind the *K'herr*, which had proven to be an ideal union of a new dreadnought type hull with existing starship components, such as fleet standard disruptors and *pljonta'*. At heart, though, Kenka wanted to build an all-new starship that would not be limited by current technology. His new *voDieH* design was based on *K'herr*; however, it would be lighter and built using Klingon starship technology that was still in the development and testing phase. It was a risky gamble, to be sure, but Jogh Kenka had a reputation for producing excellent starship designs. He also knew the master of his House. Yok'tu son of QI was arrogant, power-hungry and had managed to win the lion's share of the most prime Imperial starship construction contracts by any means possible – including lies, trickery, deceit, and the occasional duel for honor. His Chewl' Duj Shipyards had reaped enormous profits for House Yok'tu and was thus in a perfect position to sponsor Kenka's design. Thus it was that two short months later, after the design had been finalized and simulation testing completed, Kenka braved the legendary temper of his master Yok'tu and requested an audience.

It is said that Yok'tu was so taken by the idea of having a starship that would be superior to the Imperial *K'herr* that he immediately ordered the construction of a prototype without bothering to look at Kenka's simulation studies. The details did not concern him, only the results. House Yok'tu would fund the construction of the *voDieH*, prototype for Kenka's new dreadnought, from its own House treasury, thus avoiding the strings (and inevitable questions) that Imperial funding would bring with it. To further conceal his project from prying eyes as long as possible Yok'tu described *voDieH* as a "heavy battlecruiser" -- a term that eventually found its way into early Starfleet Intelligence reports about the new class. Construction commenced immediately in 2280 with the laying of the keel in spacedock, and *voDieH* launched just under three years later in the spring of 2283.

Although Chewl' Duj had not as yet fallen so far under the spell of corruption and graft as to fall behind schedule, *voDieH's* construction was not without its problems. Within a year's time Yok'tu's secret was out and

the other Great Houses were infuriated. They did everything they could to interfere with *voDieH's* construction, even going so far as to snarl up the procurement process for the experimental weapons systems and engines that Kenka had intended for the ship. It is said that Kenka himself went to the offices of each and every firm involved and fought with their masters, both with word and with blade, until they acquiesced to House Yok'tu's requests for their materials. This was *his* ship, *his* creation, and he was not about to let some Imperial *pagh* or fat House *targ* stop *his voDieH* from being built. As for his sponsor, Yok'tu son of QI was content to let Kenka fight his battles for him, thus insuring that *his* dreadnought would be built to the glory of *his* House and *his* advancement within the ranks of the High Council. It was a classic study in Klingon politics, with Kenka's dream slowly but surely gaining form and substance amid the insults and spilled blood.

VoDieH launched without a hitch on 19 April 2283 from the Chewl' Duj Shipyards of House Yok'tu. All eyes on both the High Council and the fleet High Command were on it as it commenced its shakedown cruise and took part in House fleet exercises. It was quite an impressive performance, by all accounts. The *piece de resistance* was its defeat of the *K'herr* class dreadnought *Mortak* in a simulated one-on-one duel of heavy capital ships. Yok'tu's gamble had paid off. The Klingon High Command immediately requested a full construction contract for 36 *voDieHs*. The High Command approved on two conditions. First, the number would be reduced to 30 due to prior commitments with *K'herr*. Second, *voDieH* construction would be phased in as *K'herr* production wound down in order to lessen the strain on Imperial resources. *chargwl'*, the first production *voDieH'*, entered Imperial service on 29 June 2286. New vessels followed approximately six to eight months thereafter until 2292, when the construction rate increased to four per year.

Master designer Jogh Kenka, less an eye and three fingers lost in the fight to get *voDieH* built, retired from Chewl' Duj soon after the *voDieH* contract was secured. He was getting old even for a Klingon; however, his dream had taken form and flight. The fact that House Yok'tu had rewarded him handsomely for his accomplishment was another major factor in his departure from Chewl' Duj. Kenka now works as an advisor to the High Council on matters of Imperial fleet procurement and starship construction.

It is fair to say that *voDieH* is the best all-around starship in its class in Imperial service at this time. It mixes dreadnought firepower with agility and acceleration approaching that of smaller *Drell*-type battlecruisers. Its use of the cloaking device is another important factor to consider. *voDieH* is more than a match for all but the newest starships in Starfleet, and even

they (with the possible exception of *Yamato*) will find themselves with a fierce fight on their hands in any combat encounter.

voDieH was the first Klingon starship to field the new heavy photon torpedo. It was also the first fitted with frequency-modulated meson particle accelerator (FMPA) generators. This experimental weapon is designed to knock down an enemy's energy shielding system by flooding it with meson particles. These follow the natural frequency resonances of an enemy ship's shielding grid and collect at its weakest points. The telltale energy buildup is then targeted and detonated with a microsecond pulse of Eichner radiation. The resulting energy shockwave puts so much stress on the affected ship's shielding generators that all but the strongest will instantly overload, and even the latter can take only a few such bursts before they too will fail. The FMPA system is tied to *voDieH*'s unique *pljonta'*, which were custom-designed to deliver the energy required for its meson particle cannons. It is possible that FMPA generators might be incorporated into future Klingon capital ship designs of the 24th century and beyond. Fortunately for the Federation and other major interstellar powers, the Praxis explosion and its aftermath have apparently delayed any plans by the Klingon High Command in this regard.

There are two documented Imperial variants, five House variants, and one Bloodwatch variant of the basic *voDieH* design. All save the Bloodwatch variant are almost exclusively devoted to changes in weaponry – either the addition of for more firepower (within hull and power limits) or the removal of for other systems (such as stasis field generators, fighter shuttle bays, and so on).

tiQghoB, the Bloodwatch variant, deserves special mention. It is the largest starship in the Bloodwatch inventory and was obtained by special dispensation from Chancellor Lorak. It acts as a mobile command facility for extended Bloodwatch operations and as such has some rather unique features not normally associated with an Imperial capital ship. Expanded brigs and several high-power agonizer booths take the place of its Imperial Guard barracks. It has also been fitted with an Imperial class Justice Examination Facility for the interrogation and pacification of criminals and other enemies of the Empire. To the common Klingon it is known as the Torture Ship (th. *JoyDuj'a*), and it is said that one who has been taken offworld by the Torture Ship will never return. It is easily distinguished from other *voDieHs* by its black paint scheme, which is the trademark of the Black Fleet of the Bloodwatch (tH *bej/w yo'be*).

Only 16 of the 30 *voDieHs* ordered had entered Imperial service by the time of the Praxis explosion in 2293. Three hulls in varying stages of construction were destroyed in their slips by rubble from the blast, while a

fourth miraculously survived without major harm. The current economic situation with the Empire has effectively halted dreadnought and battleship construction. *Kolor*, the only *voDieH* under construction to survive the Praxis blast, has thus languished untouched at 65% completion for the past seven years. A remarkable proposal has been put forward to use *Kolor* as the basis for a new 24th century dreadnought class, one that harkens back to its *K'herr* ancestry but retooled with the latest in Klingon starship technology. Approval of the new *Kolor* class would require the cancellation of the remaining *voDieH* construction order. The High Council is unlikely to render a decision on *Kolor* at this time, given the resources required to clean up and restore the Empire's devastated inner systems infrastructure.



voDieH class Klingon dreadnought created by Taldren (Activision Games) for the *Klingon Academy* and *Starfleet Command* series of licensed videogames

Additional background material courtesy of Amarillo Design Bureau, Activision Games, the *Klingon Academy* Forums, and Donald Burns *Kolor* proposal inspired by the Klingon “Lost Years” C-9 upgrade by Atolm

Visuals courtesy of Wicked Zombie and Demon Renegade Studios



Shuttlecarriers

vim ra'den (Kl. “Carrier of Small Craft”) and
qengwIDuj (tH. “Carrier Ship”) series

Shuttlecarriers

For as long as they have been known the Klingons have always taken delight in small craft operations. This comes as no surprise given their warrior culture, with its emphasis on personal glory and deeds accomplished by individual exploits. Small craft are a perfect opportunity for such, even if the odds are rather stacked. Klingons by nature warm to such encounters, and they will think nothing of piloting an armed small craft against a starship despite the obvious discrepancies in size, mass, and firepower. If said Klingon is lucky enough to survive such an encounter, then it automatically enhances his glory and reputation. If he inflicts damage on the enemy in the process, then so much the better. If by some incredible stroke of luck his craft is the one that strikes the deathblow, then he or she is almost certainly guaranteed a promotion, a new command, and honor and glory fit for a war hero. Such is the Klingon way. One need only look to the loss of the legendary starship *Enterprise* for such an example. True, the ship was severely undermanned and had been taken over by mutineers. Even so, the fact that a single Klingon Bird-of-Prey was able to cripple it and force its self-destruction was the cause of celebration and rejoicing within the Empire. The House of Kruge, which sired the Bird-of-Prey's late commander, was given the gift of a new *K'herr* class dreadnought as reward for this seemingly impossible feat. Such is the regard with which Klingons hold the accomplishments of small craft pilots and commanders. The various small craft types, from armed shuttlecraft on up to gunboats and escorts, are dealt with in various other sections. It is to a particular kind of small craft support vessel that this section devotes itself: *vimraden* (Kl. "small craft transporter"), the modern Klingon shuttlecarrier.

Until fairly recently the Klingons have not fielded any dedicated shuttlecarrier type starships. The reason for this is quite simple. With their plethora of older starship hulls, the Klingons have always found it easier to convert or adapt existing starships for the carrier role. For almost every major Klingon ship of the line built prior to 2275, with the exception of fleet escorts, there is at least one carrier conversion. The most popular types for these conversions were the *Raxor* class battlecruiser for fleet carriers and the *Kuve* class frigate for escort carriers. Carrier pods were also developed for both generations of Klingon transport container systems that could quickly adapt any fleet transport/tug into a carrier. This system

worked well enough against the few enemies on Klingon borders, such as the Mirak Star League, who had also made small craft operations part of their operational fleet doctrine. The excellent performance of Mirak shuttlecarriers in combat against both Imperial and House fleet elements caused the Klingons to begin developing starship carrier conversions of their own. Once the Federation began development of their own modern dedicated fleet shuttlecarriers, though, the Klingons had no choice but to follow suit. The Klingons had always ridiculed such efforts, noting Federation indecision on what role such a starship class would play in its peacetime fleet. Their derision was quelled once the Federation launched *Napoleon*, arguably the best all-around shuttlecarrier of its day. This began a design effort on Starfleet's part that culminated in the modern *Midway* class fleet shuttlecarrier of today. The Klingon reaction to this effort was predictable. Anything the Federation could do they could do better.

So it is that finally, after decades of lagging behind its interstellar neighbors in this regard, the Klingon Empire has at last begun construction of its own dedicated shuttlecarriers. Two unique individual shuttlecarriers exist (*K'pliahk*, *Riburshi*) and at least one full class is known to be under construction. As much data is currently available is presented on all three types. This will hopefully give some indication of what the Federation is about to face in the near future.

K`pliahk

qengw/Duj type 1 (*vim ra'den* type 1) [2280]

Specifications as built

Dimensions

Length: x meters
 Beam: x meters
 Height: x meters

Mass

Standard: x GMT
 Subspace displacement: x DWT

Crew complement

Officers: x
 Enlisted: x
 Imperial Guards: up to x (in support of assault operations)

Top velocity

Cruising speed: warp x.0
 Rated maximum speed: warp x.0
 Rated emergency speed: warp x.0

Endurance

Standard endurance: estimated x years at L.Y.V.
 Maximum endurance: N/A

Armament

Disruptors: x
 x
 Guided weapons: x
 x

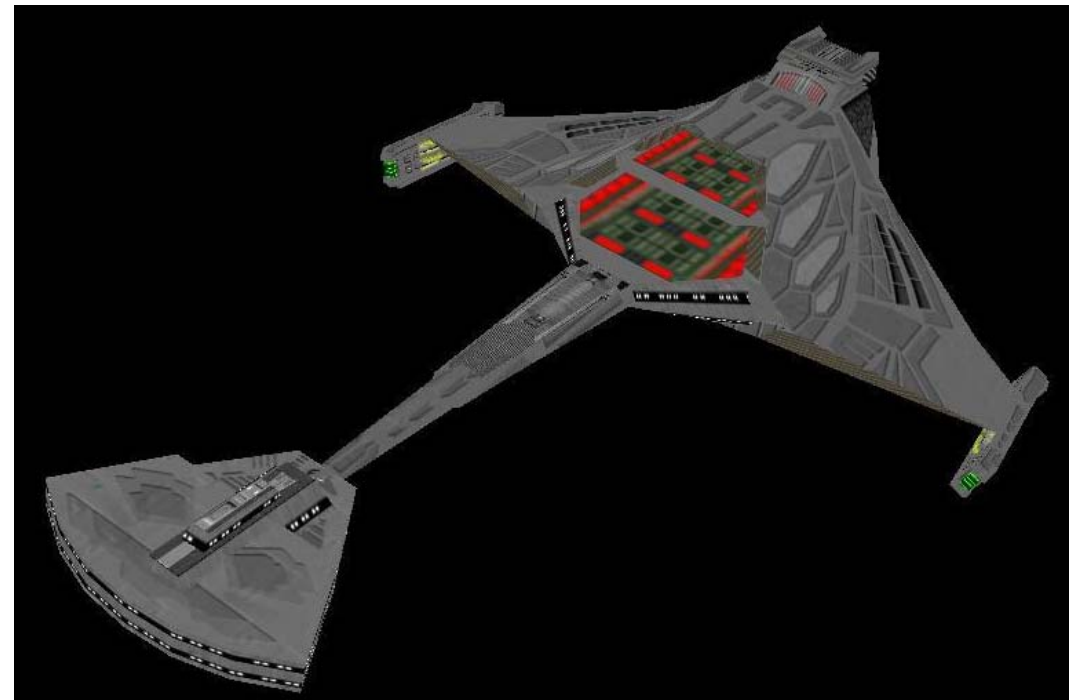

Known starships in Klingon service

Hull #	Name of starship	Comments	Status
KRV01-001	<i>K'pliahk (Carrier of Great Burden)</i>	class ship	active

K'pliahk (tH. "Carrier of Great Burden") is the largest dedicated shuttlecarrier ever built by any of the major interstellar powers in known space. It also has the largest capacity of any known shuttlecarrier, with the capability of wielding over 200 small craft into any battle.

Until the 2280s, the Klingons had always lacked a dedicated shuttlecarrier class. There was simply no need for them, as ample older hulls were available for carrier conversions. Even the carrier-wielding *Mirak* did not spur the Klingons on in this regard, as the aforementioned carrier conversions usually proved sufficient in fighting them. It was not until its most powerful enemy, the United Federation of Planets, began fielding its own dedicated shuttlecarriers did the Klingon High Command sit up and take notice. The impressive performance of Star Fleet's *Napoleon* class shuttlecarriers in the late 2260s finally convinced them that they needed dedicated shuttlecarriers of their own. Naturally, as one would expect from Klingons, anything the Federation could do they could do better.

Work on *K'pliahk* began in 2273 and was completed by mid-2280. It entered Imperial service at the end of the year after a troublesome shakedown cruise, during which both its crew and pilots had trouble getting used to their new ship. The new design, inspired in equal parts by contemporary Federation and *Mirak* carrier doctrine, was something to which Klingon veterans were unused and it took a fair amount of time to adapt. The ship was destined to be an orphan, though, given the massive cost overruns (due largely to yard corruption) that plagued its building. An order for four more *K'pliahks* was cancelled in 2281. The official reason given was that shipbuilder Chenwl Duj' needed the yard space in order to fulfill its contract as a supplemental *pumwl'* provider.

<combat considerations>

<current status>

Schematics

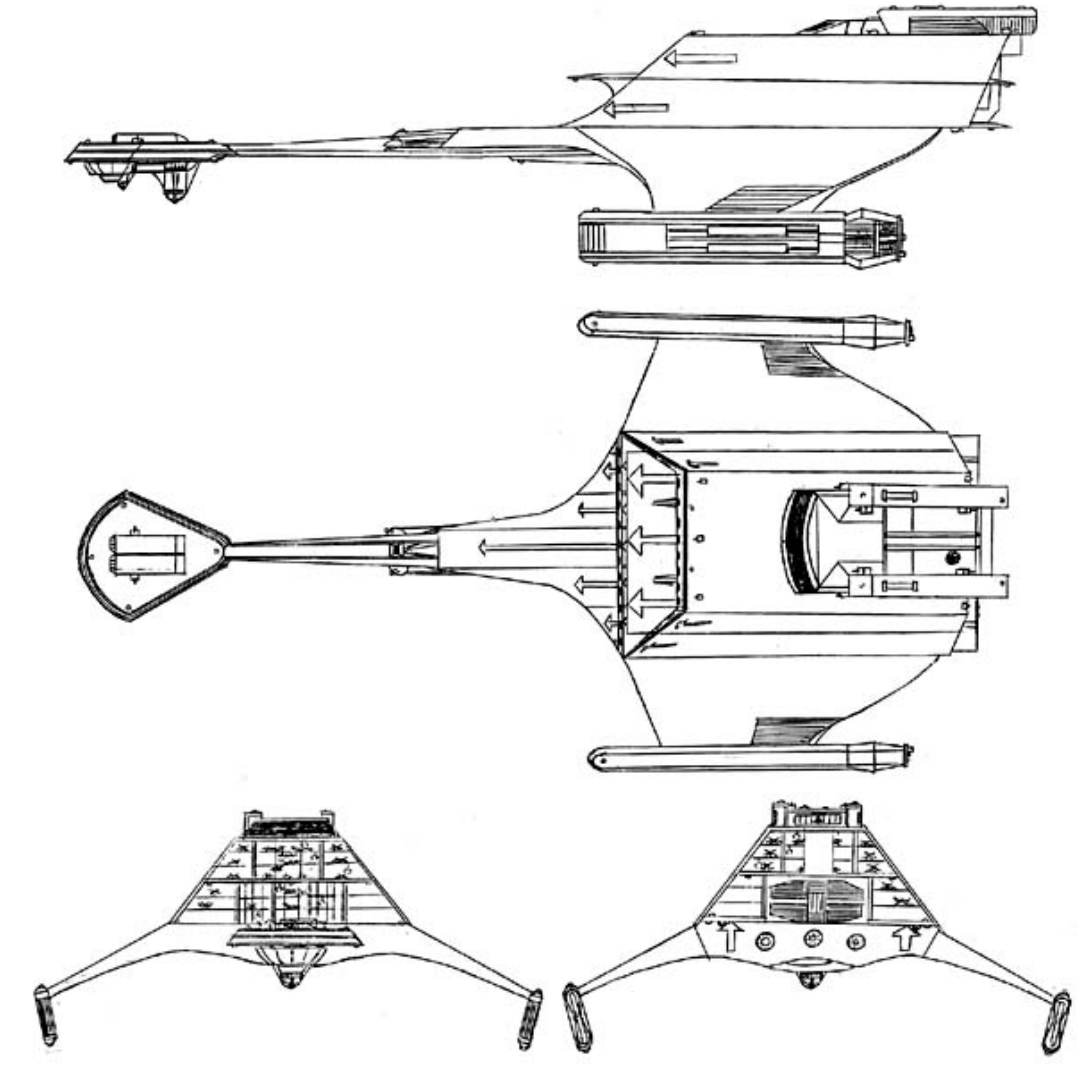

K'pliahk class Klingon fleet shuttlecarrier created by James M. Stevenson

Additional background material courtesy
of Battleclinic.com and Outalance Shipyards

Visuals courtesy of Klingon Fanatic and Models Please (Outalance Shipyards)

Hajwe'

qengwIDuj type 2 (*vim ra'den* type 2) (2285)

Specifications as built

Dimensions

Length: x meters
Beam: x meters
Height: x meters

Mass

Standard: x GMT
Subspace displacement: x DWT

Crew complement

Officers: x
Enlisted: x
Imperial Guards: up to x (in support of assault operations)

Top velocity

Cruising speed: warp x.0
Rated maximum speed: warp x.0
Rated emergency speed: warp x.0

Endurance

Standard endurance: estimated x years at L.Y.V.
Maximum endurance: N/A

Armament

Disruptors: x
x
Guided weapons: x
x

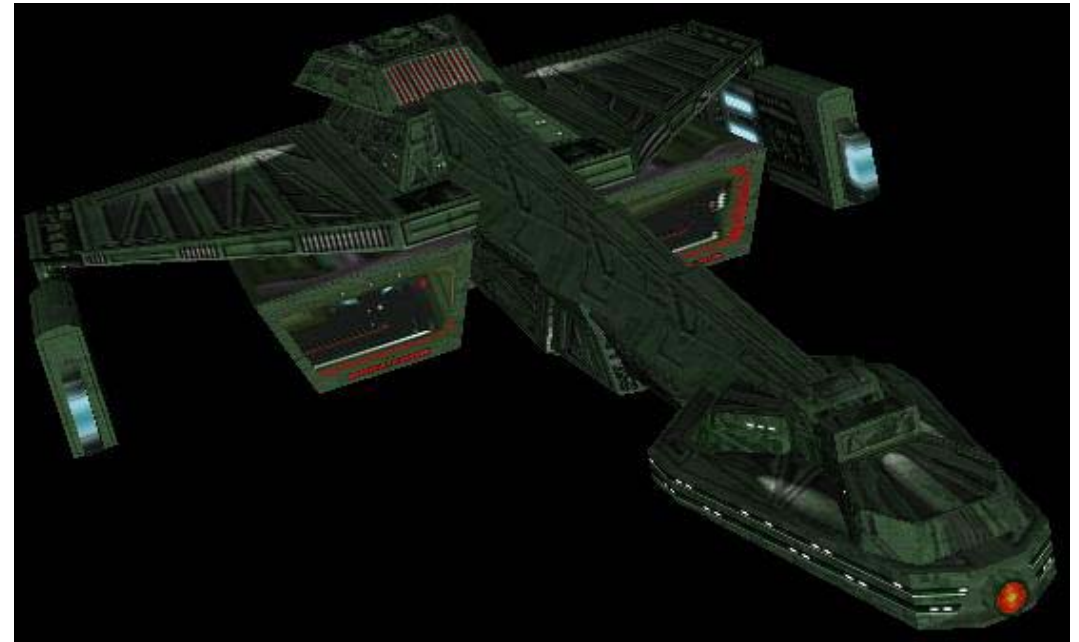

Known starships in Klingon service

Hull #	Name of starship	Comments	Status
KRV02-001	<i>Hajwe' (The Dreaded One)</i>	class ship	active
KRV02-004	<i>cha'Qi (Glimpse of Heaven)</i>	---	lost

Hajwe' is derived from the *Kleev*, an experimental battlecruiser design that once competed with *K't'inga* as the new backbone cruiser of the Imperial fleet. While *Kleev* eventually lost that competition, it found new life in two new roles: that of heavy destroyer (*tel'lw*) and strike carrier (*Hajwe'*).

Hajwe''s entry into service comes at a time when the Klingon Empire is having to dramatically beef up its armed shuttlecraft operations in light of similar moves by both the Federation and the Mirak. As such its design reflects combat experience gained against the vessels of both opponents. Its dual through-deck shuttlecraft bays are a nod to Federation designs, while its heavy dedicated armaments and capability to "slug it out" with enemy capital ships is an obvious Mirak influence. The latter is where *Hajwe'* benefited greatly from *Kleev*, retaining both the armaments and hull hardpoints of its prototype ancestor. It also has the unusual ability to jettison both of its shuttlecraft bays in an emergency, although such a practice is generally frowned upon by the Klingon High Command save in cases of extreme emergency. There are reports that the controls for this action have even been removed from certain vessels formerly commanded by "cowards" in order to discourage the practice by their successors.

At the time *Hajwe'* entered service was the most modern shuttlecarrier design fielded by any of the known major interstellar powers.

Hajwe' can best be compared to a Federation *Miranda* class cruiser in terms of firepower, small craft capability, and overall combat performance. Its *Drell* heritage combined with its dozen small craft (usually two squadrons of six Z-2 fighter shuttles) make it a challenging opponent in battle.

The shuttle bays of a *Hajwe'* are little more than refined versions of the Imperial fleet standard *bobcho'Dub* "clamp-on" bays in use by *Drell* hull types for almost a decade. The only real difference is that *Hajwe'*s possess certain refinements befitting their use as dedicated bays (as opposed to optional ones). They also retain the jettisonable nature of their ancestors, albeit with limitations (as noted above). Because of this any damage that a *Hajwe'* takes in its shuttle bays is not as crippling as would be the case with a hull conversion, say for instance a D-6V *Raxor* with its single internal bay. The only way to cripple a *Hajwe'* through a shuttle bay attack is to catch it when it is in the process of flight recovery operations or prepping its small craft for attack. In either of these cases many (if not all) of its small craft will be loaded with fuel and munitions. Targeting a *Hajwe'*'s open shuttle bays in either of these cases will usually result in a chain-reaction explosion strong enough to cripple the ship, if not destroy it outright. The trick, of course, is to catch a *Hajwe'* at such a time. This has only been accomplished three times, with the most notable being the ambush and

destruction of a Klingon shuttlecarrier group by a Mirak task force in 2297. The *Hajwe'* class strike carrier *cha'Qi* was completely destroyed when it was caught by surprise by four squadrons of Mirak fighter and assault shuttles as it and four escort carriers were prepping their own small craft for their own intended attack. *cha'Qi* took three direct hits by Mirak drones in its port shuttle bay, setting off a chain-reaction explosion among its fully loaded small craft so powerful that it tore off the *cha'Qi*'s port wing and sent it spinning out of control into two neighboring vessels. All three vessels were destroyed in a single great fireball that the attacking Mirak forces took as a sign. They then drove the attack home on the stricken Klingon fleet, and in the end only two escorts and a badly damaged destroyer escaped to tell the tale of the Mirak victory.

There are only two known variants of *Hajwe'*: the original production model and a fleet-wide upgrade that began entering service this year. The improved *Hajwe'* features, among other things, extra low-power point-defense disruptors (one each fore and back) and improved localized shielding for both of its shuttle bays. This upgrade appears to be designed to prevent a repeat of the Mirak encounter of 2288.

As of this date there are 17 *Hajwe'* class strike carriers in Klingon service out of 20 built, with 3 lost in combat. Construction was suspended due to the Praxis Event of 2293 and has yet to resume. At least 7 more hulls exist in varying stages of construction and at 3-5 more may be on order.





Image of a typical *Hajwe'* class strike carrier. The term is derived from the concept that a “strike carrier” accompanies its small craft into battle, augmenting their firepower with its own heavy weapons. Such tactics have part of Klingon carrier doctrine for as long as they have operated them and *Hajwe'* is no exception. It is the equivalent of a *K'tinga* class battlecruiser and the combined firepower of its small craft pack similar punch. This means that any encounter with a *Hajwe'* that has already launched its small craft is the equivalent of fighting two Klingon battlecruisers at once.

***Hajwe'* class Klingon strike carrier
derived on the *Kleev* class experimental cruiser by Don Woligroski
as featured in *Starfleet Command II: Orion Pirates* by Activision Games**

**Additional background material courtesy
of Battleclinic.com and Outalance Shipyards**

Visuals courtesy of ModelsPlease (Outalance Shipyards)

Ribursli

***qengwIDuj* type 3 (*vim ra'den* type 3) [2288]**

Specifications as built

Dimensions

Length: 370 meters
Beam: 381 meters
Height: 140 meters

Mass

Standard gross: 1,380,000 GMT
Subspace displacement: 346,750 DWT

Crew complement

Officers: 113
Enlisted: 590
Shuttle pilots: 100
Imperial Guards: up to 100 (in support of assault operations)

Top velocity

Cruising speed: warp 9
Rated maximum speed: warp 12

Endurance

Standard endurance: estimated 2 years at L.Y.V.

Armament

Disruptors: 20 standard disruptors (6 F, 6 A, 4 ea P/S)
4 heavy disruptors (F only)
Guided weapons: 2 photon torpedo tubes (F only)
4 drone racks
Other: 24 fighter shuttles (6 per bay)
8 attack shuttles (2 per bay)
(or 1 small fast patrol craft per hangar bay)



Known starships

Hull #	Name of starship	Builder	Status
KRV02-001	<i>Ribursli (Behemoth)</i>	Vekah/Mastocal	active

Ribursli, the Klingon empire's second dedicated heavy shuttlecarrier, is a conversion of an unfinished *bur'd'kona* hull that had been started by the disgraced Vekah Shipyards in 2265. By 2278 Vekah's *bur'd'kona* program had become so far behind schedule and so over budget that Chancellor Lotar terminated the contract. Both of the unfinished *bur'd'kona* hulls were then towed to the nearby Imperial fleet base at Mastocal, which was then ordered to finish them as best it could by any means possible in order to get them into service as soon as it could. This proved to be fairly easy in the case of *Kar'hamer*, whose 75% hull was already fairly complete (save for non-essential interior sections) and only needed installation of modern weaponry, engines, and support systems to make it operational. *Ribursli*, the second hull, was a different case altogether. Work on it had stalled at 45% completion for over a decade, with large sections of its outer hull and decks missing and no engines or weapons fitted, while Vekah tried in vain to complete *Kar'hamer* before the wrath of the Chancellor and the High Council descended upon it. That attempt eventually failed, leaving Mastocal with the problem of finishing a *bur'd'kona* per Chancellor Lotar's direct order that was, to be honest, in no shape to be finished per the original design requirements any time soon. Their first instinct was to claim that *Ribursli* could not be finished and move that it be scrapped along with the other four incomplete *bur'd'kona* space frames. A young designer named Qtugh spoke up asked that he be given a chance to save *Ribursli* from the scrapper's torch.

The fact that *Ribursli's* hull was incomplete had prompted Qtugh to begin thinking along non-traditional design lines. To him, the large gaps in the secondary hull were perfect for the fitting of large shuttlecraft hangar bays along the lines of those fitted inside Imperial carrier pods for fleet tugs. By removing even more of the appropriate sections of the incomplete secondary hull he could graft enough of these hangar bays onto *Ribursli* to give it the same shuttle capacity as the new Federation fleet carrier that Starfleet was rumored to be considering. Not all of this recovered material would be required to build around the new hangar bays, leaving a considerable portion free that could be used to fix the gaps in the keel and command boom. Therefore, the only major costs involved in completing *Ribursli* would be for the procurement and installation of its *pljonta*, weapons systems, and additional support systems, plus the procurement and installation of the hangar bays and any additional materials required to complete the hull. Once the other starship engineers had looked over Qtugh's proposal and crunched the numbers, they realized that they just might be able to get away with his proposal after all. Construction costs were further reduced by "appropriating" several older G-type carrier pods pulled from service due to "maintenance issues." These were then gutted for the *Ribursli* project. Next, four *pljonta'* originally

intended for new-build *voDleHs* at Chenwl' Duj somehow wound up at Mastocal instead, thanks to some sleight-of-hand bookkeeping on the part of its quartermaster division. When House Yok'tu objected, Mastocal commander Admial Vehkon threaten to expose certain irregularities in bookkeeping that were becoming all too evident in Chenwl' Duj's records. House Yok'tu promptly backed down, thus clearing the final major hurdle toward *Ribursli's* completion. The massive vessel cleared her moorings two years later and entering Imperial service on 15 March 2288.

As noted before, *Ribursli's* unique design is due to a combination of construction incompetence offset by engineering wizardry, both in the best Klingon tradition. Some have likened it to a "Frankenstein ship," with its unorthodox splayed *pljonta'*, unorthodox secondary hull, and battleship command boom. Others have called it "a *B'rel* on acid," as its engine arrangement and keel-mounted hangar bays (a first at the time), which run almost the length of the secondary hull, suggest an uncomfortably eerie likeness to a bloated Bird-of-Prey. Opinions aside, *Ribursli* is a competent if not exactly attractive shuttlecarrier that is perfectly capable of carrying out its designed mission profile. In fact, one distinct advantage it has over traditional Klingon designs of its type is that the size of its extended through-deck hangar bays (built around two G-type hangar bays attached back-to-back, with their connecting bulkheads knocked out) give it the capability of operating the smaller patrol craft types in addition to its own shuttlecraft. This makes *Ribursli* unique among Klingon shuttlecarriers in that it has a limited space control ship capability. Most claim this feature happened by sheer accident, but some point to the design genius of young Qtugh of Mastocal and his ability to make the best of a bad situation.

Ribursli also makes for an interesting comparison with *K'pliahk*, which is to date the only other dedicated shuttlecarrier design of comparable size to enter Imperial service. *K'pliahk* is unquestionably the superior of the two in terms of pure shuttlecarrier operations. It can hold more craft and is better suited for traditional shuttlecarrier battle tactics. At the same time, though, when it comes to survival in close quarters combat *Ribursli* is clearly superior. Its origins as a cancelled *bur'd'kona* allow it to absorb and survive damage that would cripple or even destroy *K'pliahk*. Moreover, since its hangar bays are external to the main ship itself, *Ribursli* can jettison them in the event of any emergency – such as uncontrolled fires in one or more of the bays. It makes for an interesting comparison in Klingon wargames exercises: *K'pliahk* is the better of the two at starting a fight and sustaining it at long range, but *Ribursli* is by far the superior choice for closing for the kill or surviving against unfavorable odds to fight another day.

It should be noted that *Ribursli's* successful conversion to a fleet shuttlecarrier helped to bring about the *bobcho'Dub qengwl* program (tH

“carrier upgrade module”). In essence this consists of a series of external shuttlecraft hangars, sized for various Klingon hulls, that can be quickly “tacked on” to an existing starship and thus turn it into a shuttlecarrier. These *bobcho'Dub* are designed to be mounted either centerline on the keel or in matched pairs under the “wings” of a suitably strong secondary hull. The first *bobcho'Dub* were produced in 2289, the year following *Ribursli's* commissioning into Imperial service. They proved highly popular, as they were far cheaper to mount and use than the cost of converting a starship to the dedicated shuttlecarrier role. *Ribursli*-style *bobcho'Dub* conversions are commonplace nowadays with traditional *Drell*-type hulls, most notably *Hak'hyl*, *Raxor*, *Klolode*, and *Kteremny*. The newest *bobcho'Dub* *qengwl* is *Hajwe'*, which is covered in a separate entry. Small-hull *bobcho'Dub* have also been spotted attached to *Vkar Zadans*, *Desta Kars*, and upgraded *Kuves*.

Prior to the Praxis Event the High Council is reported to have been seriously considering funding construction of a new dedicated shuttlecarrier class along the lines of *Ribursli*, but with a greater emphasis on *K'pliahk*-type capabilities. The design would have been refined for mass production, possibly based on one of the current *mayDuj'a'* or *qughDuj'a'* hull forms. The final decision on this new class appears to have been postponed for the time being while the Empire recovers from the aftermath of the Praxis explosion. Until that time comes, however, *Ribursli* remains the lone example of its type.



Ribursli class Klingon fleet shuttlecarrier created by Taldren for the *Klingon Academy* and *Starfleet Command* videogames (Activision)

inspired by the B-10V *Insaitable* as created by Amarillo Design Bureau for the *Star Fleet Battles* role-playing game (*Captain's Log #6*)

K'pliahk fleet shuttlecarrier by Don “Cleeve” Woligroski

Visuals courtesy of Taldren

Riskadh

mayDuj tIn type 6 (*Drell* type 10) (2269)

Specifications as built

Dimensions

Length: 264 meters
Beam: 157 meters
Height: 32 meters

Mass

Standard gross: 556,750 GMT
Subspace displacement: 142,400 DWT

Crew complement

Officers: 98
Enlisted: 422
Imperial Guards: up to 320 (in support of assault operations)

Top velocity

Cruising speed: warp 8
Rated maximum speed: warp 12

Endurance

Standard endurance: estimated 3 years at L.Y.V.

Armament

Disruptors: 8 standard disruptors (2 ea F/A, 2 ea P/S)
2 heavy disruptors (F only)
1 assault disruptor (*Molkatha* only)

Guided weapons: 2 photon torpedo tubes (1 ea F/A)
2 drone racks

Other: cloaking device



Known starships

Hull #	Name of starship	Builder	Status
KRD10-001	<i>TuQ Riskadh (House of Riskadh)</i>	Taamar Shipyards	active
KRD10-048	<i>Molkatha (Fate's Hand)</i>	Fonawl Shipyards	active

On 9 June 2269 the Klingon Imperial Fleet commissioned its first modern heavy cruiser class. Whereas *K't'inga* had been built to match the best of Starfleet's next generation of starships, *Riskadh* was designed to be unquestionably superior. For this purpose the classic *Drell* secondary hull was replaced with an oversized angular hull designed by the legendary Hogh Balth. This new hull provided *Riskadh* with ample room for features that had not been previously available in a classic *Drell* design, such as dreadnought-class energy shielding and an extended arsenal of on-board weaponry. The extra room would also be used to house three companies of Imperial Guards along with storage light ground assault vehicles and two oversized shuttle bays that could operate the full range of Klingon small craft (including fighter and assault shuttles). Initial construction costs for *Riskadh* were partially offset by the reuse of *K't'inga's* *pljonta'* and command boom.

Riskadh is widely considered to be the best original design of the so-called "*K't'inga* generation" (tH. *puqpu K't'inga*) of Klingon starships. It has a well-balanced mix of standard disruptors and heavy weaponry, including both heavy disruptors and photon torpedoes.

Balth had originally designed *Riskadh's* Guard barracks and shuttle bays as continuous removeable hull modules, one on each side of its secondary hull, in the same manner as his contemporary *plH* class frigate. Unfortunately, the Klingon High Command turned down the idea as impractical given the size of the ship. Instead, the secondary hull was built as a continuous whole. One odd feature of the new design was that the shuttle bays could only be accessed by lifts built into the upper part of the secondary hull. The High Command apparently rethought this decision in later years, especially after the bay lift design proved faulty and developed an annoying tendency to jam shut after newly launched *Riskadhs* had been only a few months in service. Later *Riskadh* build groups would feature a Balth modular hull, per the original proposal, as the means to correct this problem. These hull modules can be inserted and removed from the aft section of the secondary hull by any spaceyard or Imperial base with the necessary facilities.

A standard *Riskadh* features two Balth D-10A hull modules. Each has storage space for ground assault vehicles, multi-pad troop transporters, and 150 individual Imperial Guards cryosleep capsules each. Each also has a full sized shuttlebay, comparable to those of early *Riskadhs*, with hangar doors on the back of the secondary hull as opposed to the topside lifts of the original. At least seven other standard Imperial *Riskadh* hull module types (along with numerous House customizations) have been observed in operation since the Balth system was introduced for the class. These are capable of transforming a *Riskadh* into anything from a dedicated

shuttlecarrier (type D-10C) to an armed transport (type D-10T). The numbers and types of *Riskadh* hull modules are limited due to their high cost, plus the fact that at least one D-10A (or D-10C) module has to be retained for a *Riskadh* to continue to have any kind of small craft or troop operations capability. Standard D-10A modules are cheap and plentiful, since they are installed at the yard during construction. Specialized modules such as the ELINT/scout model (type D-10E) and the research cruiser conversion (type D-10R) are expensive and not readily available outside Imperial service or the fleets of the Greater Houses. House customized modules are limited to no more than a half-dozen per type (usually one or two) due to high cost of production and/or conversion for specific House needs. It is usually easier and cheaper to convert an existing older battlecruiser to fit House mission requirements than it is to produce customized *Riskadh* hull modules, and such is frequently the case.

There is at least one major variant of *Riskadh* in service in addition to the usual standard Imperial weapons and power system upgrades. A modified D-10 was first spotted operating along the Treaty Zone in 2283. It sported a *Sivista*-style command boom and had other Taldren-like modifications to its hull and engines. It was fitted with D-10A standard Balth hull modules that appeared to now be fixed in place. Since then a total of 32 modified *Riskadhs* have been spotted, all of which appear to be coming from the Z'hai Shipyards. It is widely believed that these design changes were made primarily to reduce construction costs.

Deserving of mention at this point is the *Molkatha*. It is an Imperial *Riskadh* that was removed from fleet duty in 2275 to serve as the Empire's prime experimental technologies platform. It has been rebuilt several times over the past quarter-century for the fitting of new weapons, various *pljonta'*, and ship's support systems that are undergoing evaluation trials.

The first of these rebuildings took place in 2277, when it was used to test the feasibility of mounting assault disruptors on large starship hulls. Other experimental systems were tested around the same time, many of which wound up in the various *mayDuj'a'* and *qengwIDuj* programs. *Molkatha* retained its 2277 prototype assault disruptor until its last rebuilding in 2290. The high power requirements of the weapon, combined with the limits of *Molkatha's* twin *pljonta'*, gave it the slowest assault disruptor arm rate of any Klingon starship in service so equipped. In its current configuration *Molkatha* has been fitted with an



experimental command boom, experimental *pljonta'*, an experimental impulse engine deck, and a "T-bar" sensor pod. *Molkatha's* current appearance is sometimes referenced as a KCX (Klingon Experimental Cruiser) in Starfleet Intelligence reports.

Five major Klingon shipyards contributed to *Riskadh* production from 2269 until 2293. These were Taamar, Gnuu Re', Fonawl, Z'hai, and Mustaka. By the time of the Praxis explosion the combined facilities of all five spaceyards were producing *Riskadhs* at the impressive rate of 36 per year. The Praxis Event eventually brought about the end of all *Riskadh* production even though only 112 of the intended 455 total hulls were built. The crippled Klingon economy combined with its wrecked inner systems infrastructure simply could no longer support production of such a large and expensive starship at such an incredible rate. Production had slowed to a trickle by 2298, with Z'hai being the only spaceyard left still manufacturing *Riskadh* hulls, when the remainder of the contract was abruptly cancelled by the High Council. The design has since been replaced on the production schedule by *chetv'na*.

Riskadh's high production and operational costs have also limited its use in House fleets. Because of this the majority of *Riskadhs* produced remain in Imperial service – save those that have been destroyed, lost by other means, or captured by other powers (such as the Romulans and the Federation). A recent attempt to market *Riskadh* as an export design has since been deemed a "notable failure." Most buyers expressed the opinion that *Riskadh's* best days are behind it now and that the asking price was too high for such a dated design. Only three were sold according to most accounts, all to interested parties within the Triangle.

Riskadh, the class ship, was named after House Riskadh, the same that sired Kahless the Unforgettable of legend and lore. The House officially died with Khaless, thus ending the First Line of Klingon Emperors.

Schematics

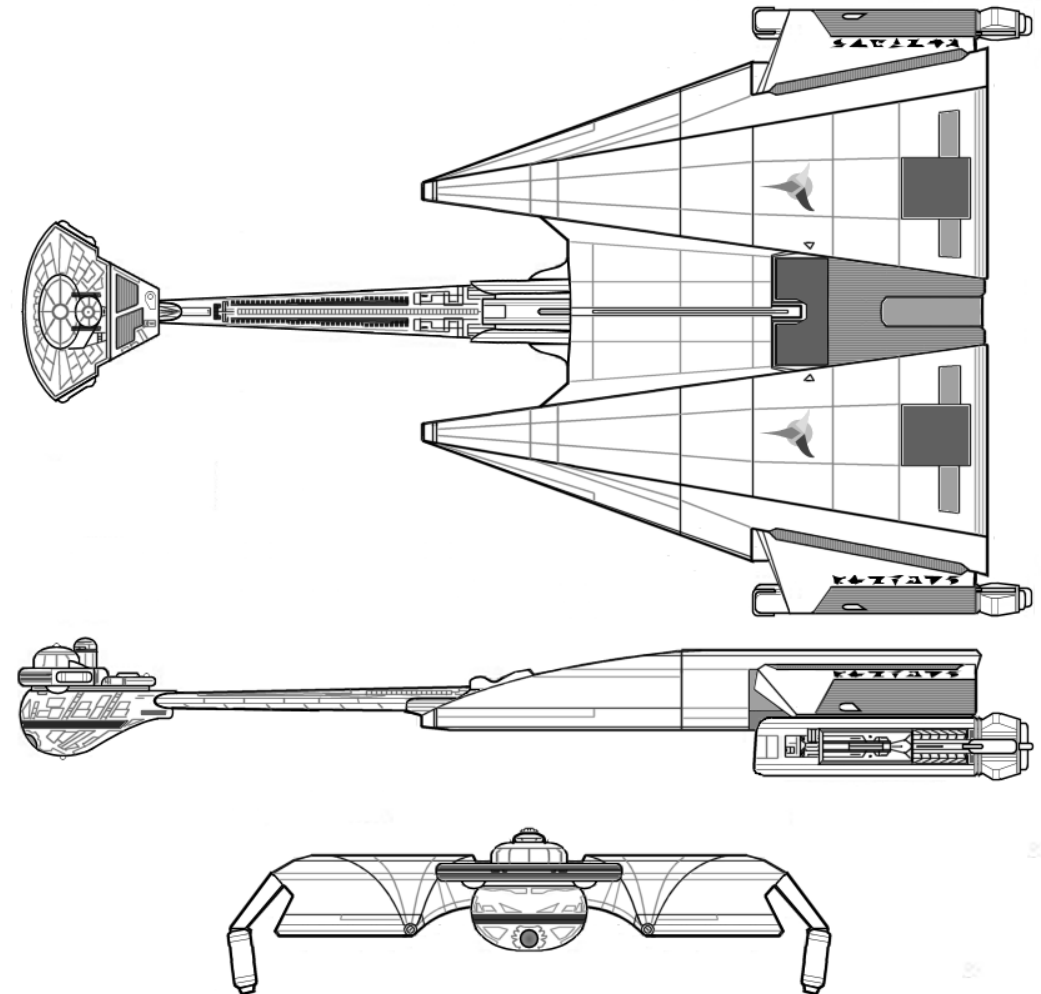

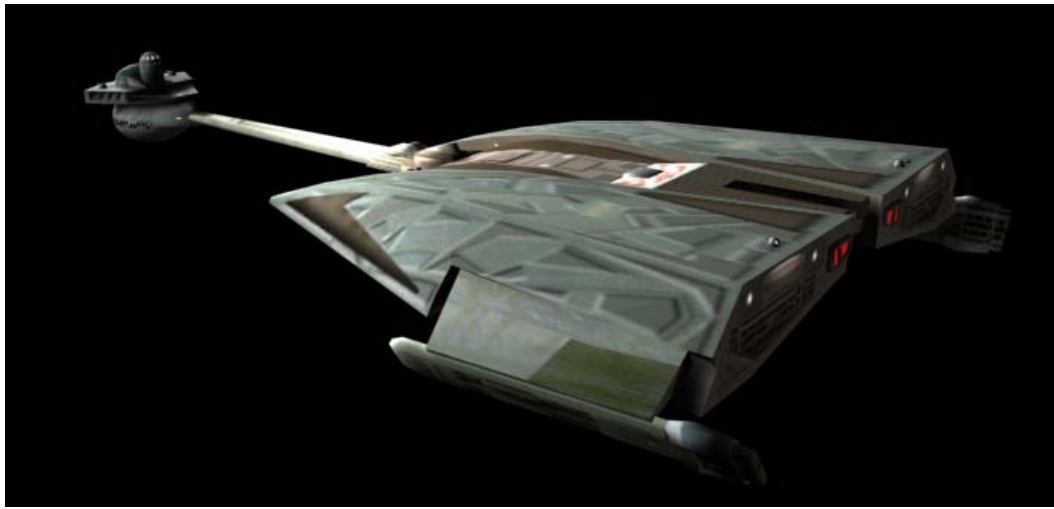

Riskadh class Klingon heavy cruiser
created by Forrest G. Brown and Dana Kuntson
for *STAR TREK – The Role-Playing Game* by FASA Corporation

Molkatha variant by OutaLance Shipyards
(Klingon Fanatic, Atrahasis, Wicked Zombie, and Don “Cleeve” Woligroski)

Additional background materials courtesy of James Dixon and Battleclinic.com

Visuals courtesy of Atrahasis

Schematics by Richard Mandel
based on the work of Neale Davidson (Pixel Sagas)

chetvl`na

mayDuj tln type 7 (chesis d'kleon type 7) **[2292]**

Specifications as built

Dimensions

Length: 349.5 meters
Beam: 251.8 meters
Height: 98.4 meters

Mass

Standard gross: 760,000 GMT
Subspace displacement: 188,500 DWT

Crew complement

Officers: 125
Enlisted: 575
Imperial Guards: up to 200 (in support of assault operations)

Top velocity

Cruising speed: warp 9
Rated maximum speed: warp 14

Endurance

Standard endurance: estimated 5 years at L.Y.V.

Armament

Disruptors: 8 standard disruptors (2 F, 2 A, 2 ea. P/S)
2 heavy disruptors (F only)
Guided weapons: 2 heavy photon torpedo tubes (F/A)
2 drone racks
Other: 1 stasis field generator
cloaking device



Known starships

Hull #	Name of starship	Builder	Status
KRC07-001	<i>chetvl`na (Torturer)</i>	Chenwl' Duj Shipyards	active
KRC07-002	<i>la'quv (Supreme Commander)</i>	Chenwl' Duj Shipyards	lost
KRC07-003	<i>bljwl (Punisher)</i>	Chenwl' Duj Shipyards	lost
KRC07-004	<i>mup Hegh (Death Blow)</i>	Chenwl' Duj Shipyards	auth.

chetvl'na will be the Empire's heavy cruiser class of the near future. It is slated to take over *Riskadh's* place on the Imperial production schedule once the Empire sufficiently recovers from the Praxis explosion of 2293. Until that time, this lone vessel gives us our only clue as to how the Empire intends to evolve the classic *Drell* design into the 24th century and possibly beyond.

chetvl'na's C-7 designation comes from the fact that it was authorized under an old dreadnought contract. This was the only politically expedient way for Chenwl' Duj to be granted permission to build a new battlecruiser class, given the ban put on them by the High Council in 2287 for widespread corruption and graft. The ban was supposed to last 20 years; however, it only affected new builds. A close examination of Imperial fleet naval construction contracts revealed that the *chesis d'kleon* type 7 contract of 2274 was still active. It had been suspended due to perceived lack of need at the time; however, it had never been cancelled due to the commotion caused by the 2278 scandal – the same that had brought about the ban on Chenwl' Duj in the first place. This allowed the High Council to neatly sidestep their own ban by reactivating this contract and awarding it to Chenwl' Duj, thus giving its owner House Yok'tu a chance to redeem its honor. In an ironic turn of events Chenwl' Duj engineers designed their new *chetvl'na* class heavy cruiser as an enlarged *K't'inga* based on their proven *K'herr/voDieH* dreadnought space frame. This is why *chetvl'na's* proportions are somewhat larger than *K't'inga* even though both look the same. It is due to its dreadnought design heritage that *chetvl'na* was given the C-7 designation in Starfleet Intelligence reports, even though technically it is a heavy cruiser and not a true *chesis d'kleon*.

At this time *chetvl'na* is a one-of-a-kind vessel. Two others were under construction in 2293 (*la'quv* – 85%, *bljwl'* – 20%) when flying debris from the Praxis explosion destroyed them along with their spacedocks. Yard space had been prepared for a fourth; however, it had not started building at the time of the event. Most of the materials that had been gathered for its construction were lost along with the other two vessels, forcing Chenwl' Duj to reboot construction of the rest of the class from scratch.

It is believed that Chenwl' Duj is set to begin construction on *mup Hegh*, previously the fourth and now the second *chetvl'na*, as soon as it is able – once materials have been gathered and an appropriate spacedock repaired and made ready. Current intelligence places *mup Hegh's* construction start date around 2306, with some private analysts dating the event as early as 2302. It is a given that *mup Hegh* will probably incorporate any Klingon starship technology advances that have been made by that time.



chetvl'na class Klingon heavy cruiser created by Steven V. Cole for the *Star Fleet Battles* role-playing game by Amarillo Design Bureau

Class specifications and other selected materials derived from the “enlarged *K't'inga*” as depicted on screen in *STAR TREK – Deep Space Nine* and posited by Doug Drexler in the *Deep Space Nine Technical Manual*

Additional background material courtesy of Amarillo Design Bureau

Visuals courtesy of OutaLance Shipyards



Battlecruisers

Drell (KI. “Nimble Lizard”) and
mayDuj (tH. “Battlecruiser”) series

Battlecruisers



For almost two centuries the *Drell* series battlecruiser has been synonymous with the Empire itself. According to Klingon lore the basic design came from a race of intelligent lizards that the Klingons called the Drell (Kl. “nimble lizard”). They were conquered in their turn by the Klingons; however, they put up one of the stiffest fights of all early Klingon servitor races and their starships were more advanced and maneuverable than their conquerors. The Klingons apparently defeated them by the generous employment of sheer numbers and brute force. It is said that the basic *Drell* hull shape is adapted directly from original Drell cruisers that the Klingons captured and studied during that era, modifying and adapting the design to suit their own needs.

The very first *Drell* ever encountered by the Federation was the *Dama* class starship *Bon'chuune* on 23 May 2151 as recorded by the *Enterprise*, an early warp 4 starship of the Terran Star Fleet. This was the same Terran

vessel that had also earned the privilege of first contact with the Klingon homeworld. It was among the most advanced starships of the day and easily outclassed the Terran vessel. The Terran Star Fleet promptly began a crash development program for new weapons, shielding, and warp technologies. The following two years saw encounters with more and more Klingon starship types, from cruisers and tankers all the way down to nimble scouting vessels. By 2153 the Terran Star Fleet had photonic torpedoes and improved ablative armor; however, they were still no match for a Klingon starship of comparable class in a one-on-one fight. The outbreak of the Romulan War in 2156 put an end to all clashes with the Klingons for the time being; however, this early technology disparity would be remembered once the Federation Starfleet came into being. It would in time become one of the motivating factors behind the development of the *Baton Rouge* generation and Class I Program of starships in the early and middle 23rd century.

The next two major iterations of the *Drell* made their respective debuts on the Federation border in the early and mid-23rd century. The *Raxor* class battlecruiser wrought havoc with Federation border forces in a series of incidents leading up to the Battles of Axanar and Donatu V. The Klingons were eventually driven back to the border, but by this time the exploits of the *Raxor* were legend. The postwar *Klolode* would share in this legacy, becoming so identified with the Klingon Empire that by the 2260s it had become a pop icon of sorts within the Federation.. The Romulans were so impressed with the Klingon *Drell* lineage that they managed to negotiate for the rights to purchase 173 worn-out *Raxor* and *Klolode* class battlecruisers in 2267 under the terms of the Treaty of S'marba. These would in turn, after considerable repair and rebuilding, become the basis for the modern Romulan Space Navy.

The *Drell* design eventually hit its peak with the *K't'inga* class battlecruiser of the 2270s. This was arguably the most powerful, most heavily armed, and most balanced version of the *Drell* ever built until the contract for the *chetv'na* heavy cruiser was secured by Chenwl Duj'. This is little more than an *K't'inga* upsized to a dreadnought class hull; however, it will ensure that the *Drell* design legacy continues along with the Empire itself.

D`ama

***mayDuj* type 1 (*Drell* type 4 mod 10) [2136?]**

Specifications as built

Dimensions

Length: 205 meters
Beam: 130 meters
Height: 45 meters

Mass

Standard: 342,500 GMT
Displacement: 84,600 DWT

Crew complement

Officers: 85
Enlisted: 215
Imperial Guards: none

Top velocity

Cruising speed: warp 8
Rated maximum speed: warp 11

Endurance

Standard endurance: estimated 3 years at L.Y.V.

Armament

Disruptors: 5 standard disruptors (2 F, 1 A, 1 ea. P/S)
2 heavy disruptors (F)
Guided weapons: 1 photon torpedo tubes (F)
2 drone racks

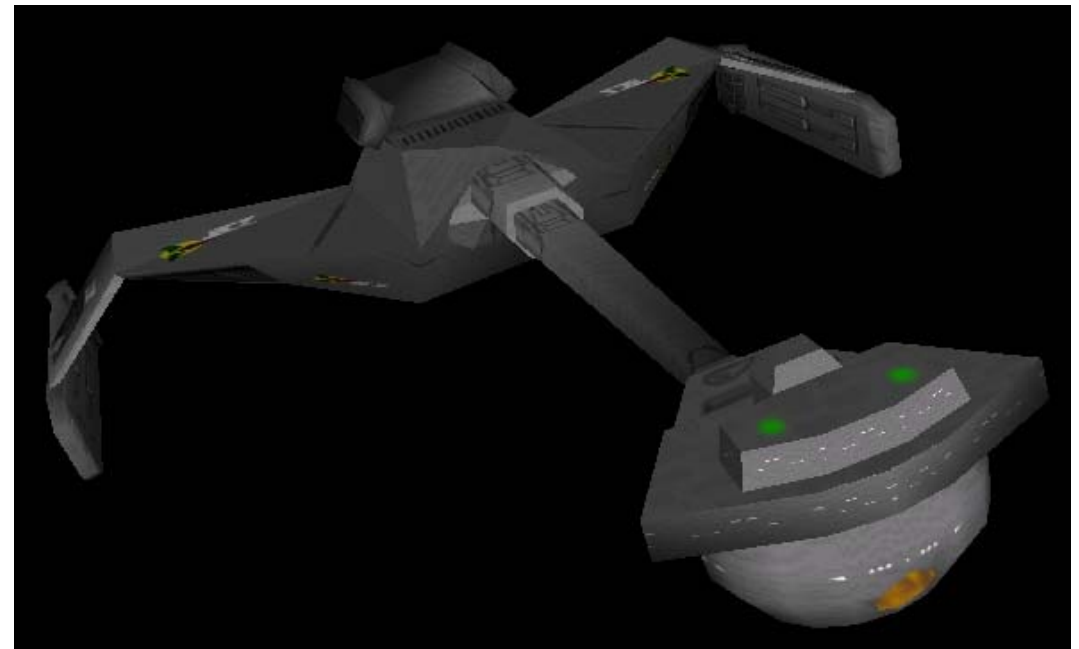

Known starships

Hull #	Name of starship	Builder	Status
KRD04-001	<i>Dama (Predator)</i>	---	active
KRD04-006	<i>K'taal (Oblivious to Pain)</i>	---	---
KRD04-015	<i>Bon'chuune (Lancer)</i>	---	---
KRD04-016	<i>Cha'nItlh (Two Fingers)</i>	---	---
KRD04-120	<i>QuISuD (Blue Fire)</i>	---	---
KRD04-261	<i>ghop Hegh (Death Hand)</i>	---	---

D'ama was the first of the modern Klingon *Drell* type battlecruisers. It is believed to be the first production model in Imperial service, although it was not the first built. The Klingons had made three prior attempts at duplicating a version of the starships used by the lizard-like Drell suited to their tastes and tactical sensibilities. It was not until *D'ama* that they succeeded. *D'ama* was the first *Drell* type ever in Imperial service and the first starship in Klingon service to employ the now-familiar long-necked forward command boom. There would be many more *Drell* types in the decades to follow.

In their heyday *D'ama* class battlecruisers were being produced by the Klingons at the rate of one per month. It is believed that such a large number of advanced starships at the Klingon's disposal deterred any thoughts of Romulan attacks during the era of the Romulan War (2156-2160). On the other hand, it put the Klingons in a perfect position to take advantage of depleted Romulan fleet strength once the war ended, and that is exactly what they did. *D'ama* saw extensive action against the Romulan in the postwar years, and remained a frontline battlecruiser until the Battle of Verruca II in 2223. *D'ama* was blamed for the Klingon rout in that confrontation, with the now-disgraced design withdrawn from front-line service in favor of newer *Drell* designs. It returned in to service during the Klingon fleet ramp-up against the Federation in the 2250s in the role of a light cruiser, supplementing the *Raxor* in fleet operations against Federation forces. It has continued in this role ever since.

D'ama is the oldest *Drell* type battlecruiser still in active Imperial service. Even so it makes for a fair comparison to its descendants save in range and weaponry. Its engines are not as powerful as newer *Drell* types and the frame is not designed to handle modern *pljonta'*. While there have been some improvements, mostly in engine efficiency and speed, the power and range of a modern *D'ama* is still far below that of a modern *Drell*. It is also not as heavily armed, lacking sufficient hard points for anything beyond a *Raxor*-style disruptor layout and a single, forward-mounted photon torpedo. There are heavier armed *D'ama* customizations in service with some houses but these are quite rare and involve heavily modified frames. No such *D'amas* are in service with the Imperial fleet.

There is only one shipyard left in all the Empire that still services the *D'ama*. The House of Vakhdon obtained most of the toolings, molds, and equipment used to originally produce the *D'ama* after the last of the originals entered service sometime around 2170. At the time it was one of the Lesser Houses, with the cost of acquisition of the *D'ama* production equipment almost breaking the House treasury. The investment proved to be well worth the cost, though. At first it used the equipment to keep its own *D'amas* in good order; however, a few years later it began servicing

those of other Houses. By the time Chancellor Kessa's Imperial fleet ramp-up began against the Federation, House Vakhdon was in a perfect position to supply it with rebuilt *D'amas* at reasonable prices in order to increase available combat forces. The bounty it reaped was enough to propel House Vakhdon into the lower echelons of the Great Houses; however, it never forgot its roots. Modernized *D'ama* conversions still remain available from House Vakhdon for purchase by the Lesser Houses. The Imperial Fleet will also occasionally order a modernized *D'ama* to replace one of its own, which are now over a century old. House Vakhdon receives the older Imperial *D'ama* as part of the purchase. It will then stress test the vessel to see whether or not it is a candidate for the modernization process or for the Vakhdon *D'ama* boneyard.

According to Starfleet Intelligence "about 300" *D'amas* were built from 2146 to 2170. 48 modernized hulls remain in Imperial service, while 28 modernized ones remain in service with the Lesser Houses. Most of the rest were destroyed in the service of the Empire over the past 150 years. Starfleet possess nine captured *D'amas*, which it uses as part of its Adversary Squadron for Command School training purposes. At least 11 have spotted in use by interstellar pirates.

At the time of publication *D'ama*, the class ship, was the oldest *Drell* type cruiser still in active Imperial service.

Schematics

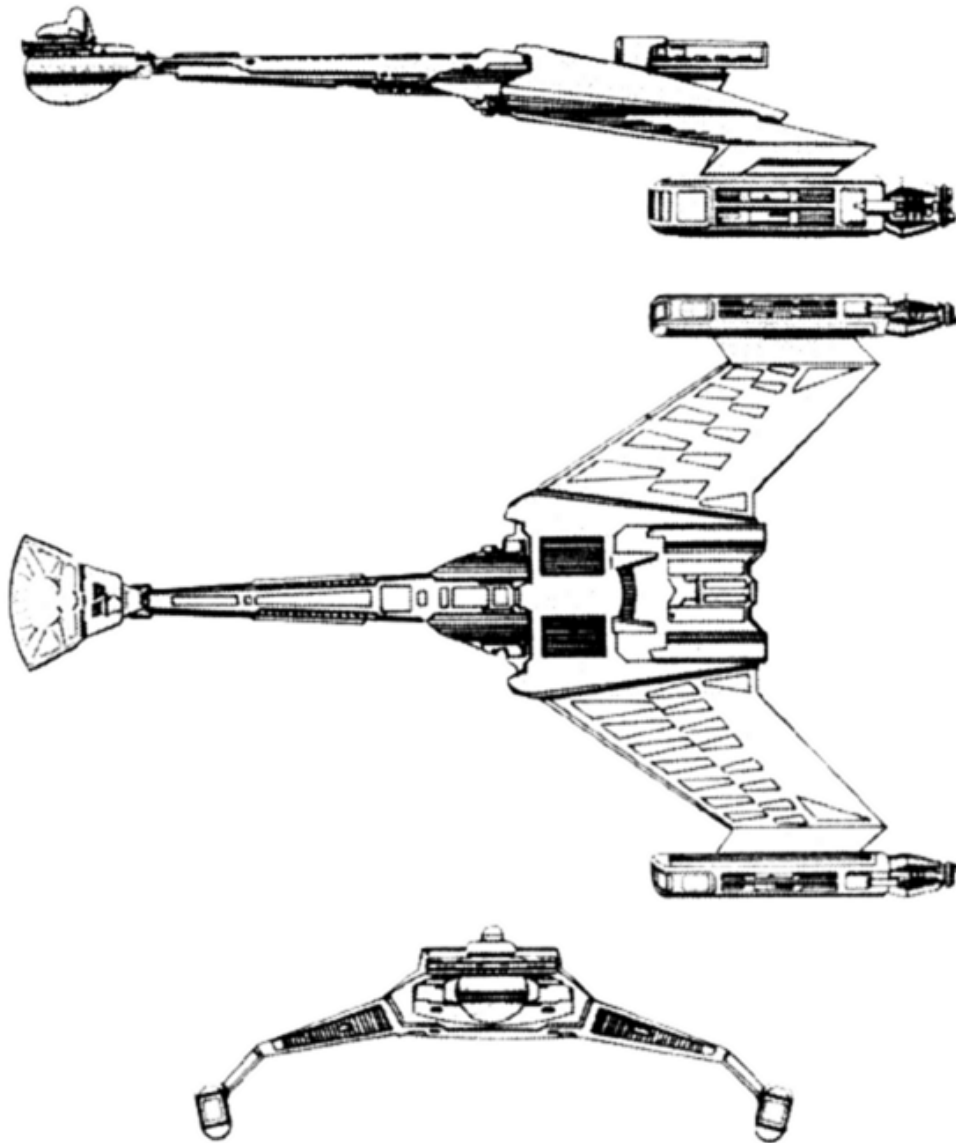

D'ama class Klingon battlecruiser created by Forrest G. Brown and Dana Knutson for FASA Corporation's *STAR TREK – The Role-Playing Game*. Additional background material courtesy of Brad Torgerson, John Ford, and Rob Bonchuune

Images courtesy of Firehawk

Schematics by Dana Knutson

D'ama in its current configuration (c.2280)

Hak'hyl

***mayDuj* type 2 (*Drell* type 5) (2233)**

Specifications as built

Dimensions

Length: 182.7 meters
Beam: 154.4 meters
Height: 55.3 meters

Mass

Standard gross: 361,725 GMT
Subspace displacement: 92,750 DWT

Crew complement

Officers: 20
Enlisted: 235
Imperial Guards: none

Top velocity

Cruising speed: warp 7
Rated maximum speed: warp 10

Endurance

Standard endurance: estimated 1 year at L.Y.V.

Armament

Disruptors: 8 standard disruptors (2 F, 2 A, 2 ea. P/S)
2 heavy disruptors (F only)
Guided weapons: 2 photon torpedo tubes
1 drone rack
Other: cloaking device



Known starships

Hull #	Name of starship	Builder	Status
KRD05-001	<i>Hak'hyl (Surgical Strike)</i>	Kareli Design	---

For every proven cruiser design there is a cheaper light cruiser favored by the bureaucrats, or so the old Terran saying goes. This is not the same situation that one finds in the Klingon Empire. The only things “light” about a Klingon light cruiser are that they are usually either older cruiser designs relegated to the light cruiser role (*D’ama*, *bortaS*, *qa’HoS*) or “budget” versions of existing cruisers that are just as heavily armed but stripped down in other areas in order to speed production. The latter is true of *Hak’hyl*, which is better known in Starfleet Intelligence circles as the Klingon “war cruiser.” It is a compact version of *Klolode* with a reduced form-factor hull, intended for continuous production during times of war. Visually it is almost identical to *Klolode* (or *K’t’inga* in the case of uprated versions) save in two key aspects: its slightly smaller secondary hull and its shorter command boom.

Hak’hyl was based on the older K-5 *Dupat* class cruiser, itself an offshoot of the classic *Drell* design lineage. Both were products of the Kareli Design Bureau, one of the more storied groups of starship designers in Klingon history. *Hak’hyl* entered service in 2233 as a “light cruiser” contemporary of *Raxor*. It did not enter widespread production until Chancellor Kessa’s buildup of the Imperial Fleet that lead directly into the Organian Conflict of 2267. It is believed that some 250-300 *Hak’hyls* had entered service by the time war broke out above Organia, with Imperial and House shipyards producing them at the rate of approximately 18 per year. Production dwindled considerably in the decades that followed. The last major surge in *Hak’hyl* production was from 2278 to 2291. Production capability remains, though, since any shipyard capable of building a *K’t’inga* can also build a *Hak’hyl* in roughly two-thirds the time.

A modern *Hak’hyl* is the functional equivalent of an uprated *Klolode* in almost every aspect. Its only drawback is limited range due to lack of sufficient storage space to take on supplies and fuel for a mission of extended duration. This is usually not considered a major drawback. *Hak’hyl* patrols, both single-ship and “wolf pack” squadrons, are normally based at major Klingon supply bases and port facilities. It is rare for them to be sent on missions of extended duration due to their lack of range, and such is normally done only when some form of resupply awaits them at journey’s end. Bear in mind that this is the Klingon Empire being discussed, though, and that “form of supply” could very well mean a resource-rich target ripe for the picking at their intended destination. Such tactics are not unknown in the history of Klingon interstellar expansion.

Hak’hyl variants are numerous, especially among those in service of the Houses. The relative low cost of *Hak’hyl* (as compared to a *K’t’inga* or uprated *Klolode*) have made it a popular choice for House fleets, especially after the current 2270 modernized version was introduced into service.

Schematics

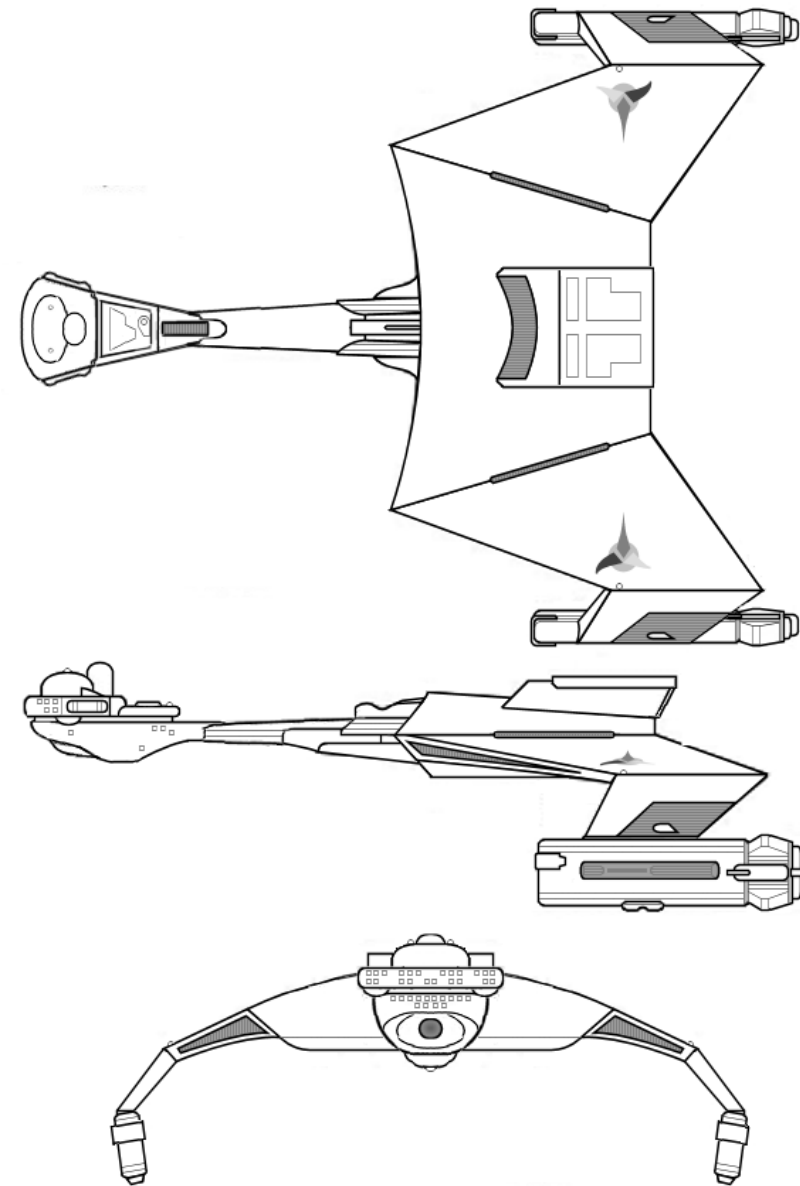

Hak’hyl as launched (c. 2233). This particular style of command boom is unique to only two hull forms: the original *Hak’hyl* and *Lecthu/Sho’tar*. It is believed to be an economy model. Very few examples of the original *Hak’hyl* remain in service in any capacity.

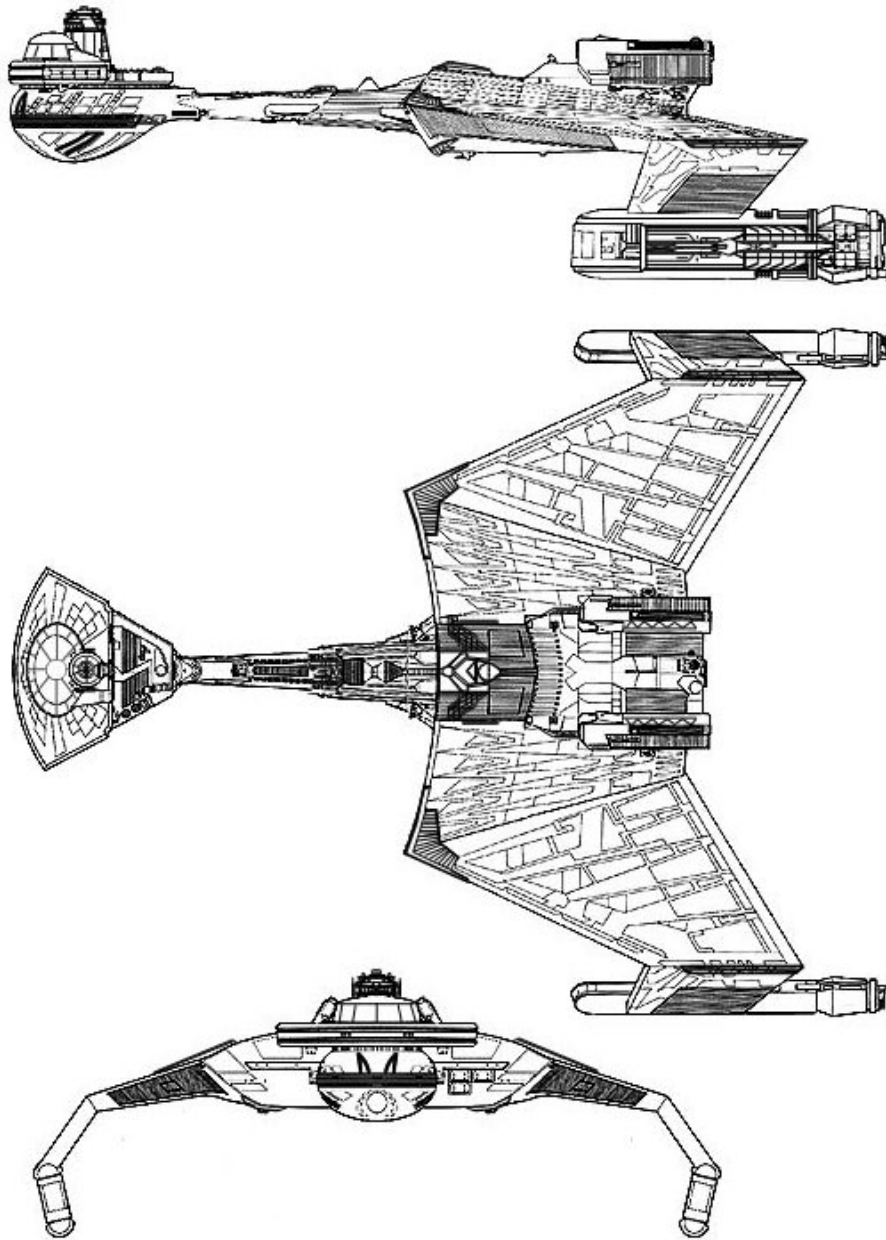

***Hak'hyl* class Klingon “war cruiser” created by Steven V. Cole for the *Star Fleet Battles* role-playing game by Amarillo Design Bureau**

Additional background material courtesy of Amarillo Design Bureau, Patrick Flannery, and Geoffery Mandel

Visuals courtesy of jrstandfast (Battleclinic.com)

Hak'hyl in its post-*K'tinga* upgraded form. Extensive upgrades have made it essentially identical to its newer sibling (*K'tinga*) in every category save range. The only physical difference remaining between these two classes is *Hak'hyl's* shorter command boom.

Raxor

mayDuj type 3 (*Drell* type 6) (2233)

Specifications as built

Dimensions

Length:	205.2 meters
Beam:	152.4 meters
Height:	55.3 meters

Mass

Standard gross:	413,000 GMT
Subspace displacement:	102,500 DWT

Crew complement

Officers:	20
Enlisted:	390

Top velocity

Cruising speed:	warp 5.8
Maximum speed:	warp 7.3

Endurance

Standard endurance:	estimated 2.2 years at L.Y.V.
---------------------	-------------------------------

Armament

Disruptors:	6 standard disruptors (2 F, 2. ea P/S) 2 heavy disruptors (both F)
Guided weapons:	1 photon torpedo (F)

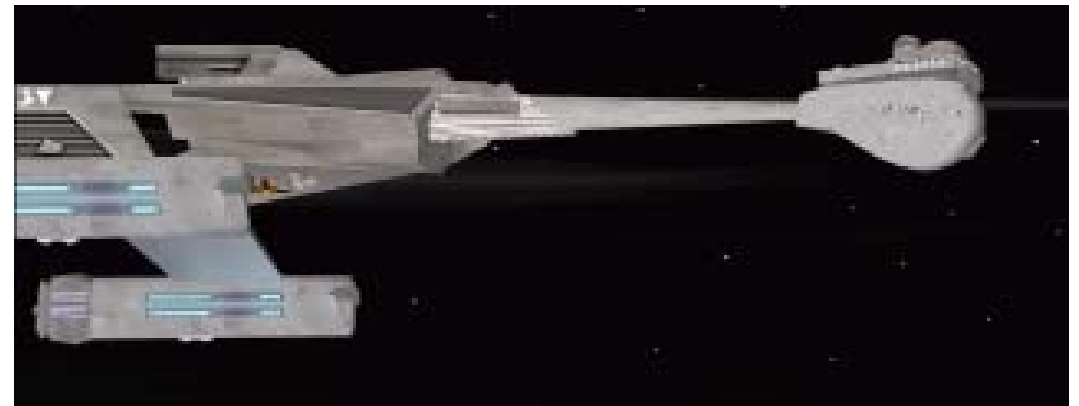

Known starships in Klingon service

Hull #	Name of starship	Builder	Status
KRD6-001	<i>Raxor</i>	class ship	---
KRD6-004	<i>GhaSor'a (Havoc)</i>	---	---
KRD6-005	<i>Wa'lv'thlobtu (Investigator)</i>	---	---
KRD6-007	<i>QeH (Furious)</i>	---	---
KRD6-019	<i>MoB'u (Desolation)</i>	---	---
KRD6-023	<i>Ho'Du'Sop (Gnasher)</i>	---	---
KRD6-024	<i>Qih'ta (Destruction)</i>	---	---
KRD6-046	<i>Chotwl' (Murderous)</i>	---	---
KRD6-047	<i>MuSqu' (Despicable)</i>	---	---
KRD6-051	<i>Rop'a (Plague)</i>	---	---
KRD6-078	<i>Kut'luch (Assassin's Blade)</i>	---	---
KRD6-042	<i>So'chu (Devastation)</i>	---	---
KRD6-143	<i>Hegh'wamwl (Deathstalker)</i>	---	---

Raxor was the third incarnation of the classic *Drell* type battlecruiser hull to enter Klingon service. It represented a major improvement over the older types 4 (*D'ama*) that preceded it. It is the direct ancestor of the *Drell* types 7 (*Klolode*) and 8 (*K't'inga*).

These starships were initially conceived as the backbone battlecruisers of the Imperial Fleet, replacing the aging *D'ama* in that role. Their service record is a long and storied one. The class received its virtual baptism of fire during the Demon War, where it was commonly deployed against Kinshaya void-spheres in standard Klingon "wolf packs" of three. The war eventually ended in a stalemate; however, the battleworthiness of this newest iteration of the *Drell* had eventually proven itself beyond any shadow of a doubt. Its next chance at glory came against Starfleet forces in the 2240s and 2250s.

Starfleet Intelligence had completely miscast the combat capabilities of the *Raxor* based on faulty data, and many a Starfleet commander found himself outmaneuvered and outgunned by *Raxor* wolf packs during those early encounters. It was Captain Kelvar Garth who demonstrated the deficiencies of the *Raxor* at the Battle of Axanar. Just as had the Kinshaya before him, Garth proved that *Raxor's* main strength was also its main weakness. It had been designed to deliver a staggering first punch with forward weapons fire, after which it was supposed to use its agility to swing back around for a second attack before its opponent could recover from the first one. Therein lay its problem: it lacked adequate weapons coverage and shielding to its underside and rear. Klingon commanders were well aware of this issue; hence the development of the "wolf pack" tactic in an early effort to offset it. Captain Garth repeatedly demonstrated that if a *Raxor* could be isolated, then the superior weapon arcs of the better balanced Starfleet designs could be brought to bear on the *Raxor's* underprotected rear. His simple response to a *Raxor* wolf pack attack was to reinforce his forward shields and then let them have their first shot, after which he would pound them with his aft-firing weapons as they passed by. *Raxor's* weak aft shields would almost guarantee a hull hit every time. Since the *Raxor's* impulse deck just so happened to be in this critical zone, a well-placed volley could cripple a *Raxor's* sub-light maneuverability right at the start of any engagement. Garth's tactic was quickly adopted by other Starfleet starship captains and proved to be one of the factors in eventually stopping Klingon aggressiveness at that time. This would force the Klingons to abandon the *Raxor* wolf pack attack in fleet engagements. They also hastily backfitted the class with beefed-up aft shield generators.

Raxor ended production in 2254, just as production on its successor *Klolode* began to ramp up. Despite this it remains in the service of the Empire to this day. Almost all of its components are identical to *Klolode*,

its newer and improved stablemate, and an upgraded *Raxor* can always fill in for a *Klolode* if need be. While the design is now considered dated, these hulls are useful enough to have been converted to dozens of different variations. Among the most notorious of these are the D-6J penal ships, crewed by Klingon prisoners-of-war and incarcerated criminals, who are given the chance to work off their sentences in the service of the Empire.

At least 90 older *Raxors* are believed to have been sold to the Romulans under the terms of the Treaty of S'marba. Used *Raxors* have also popped up in quantity in the fleets of allied Klingon powers, and at least two captured ones are in the hands of lesser powers. At least one is known to be in Orion hands. Starfleet maintains its own fleet of some two dozen or so *Raxors*, either captured or rebuilt from wrecks during various conflicts as well as a few newer acquisitions such as the nearly intact *Conquest*. These form the core of the Klingon wing of its famed Adversary Squadron for war games exercises.

Schematics

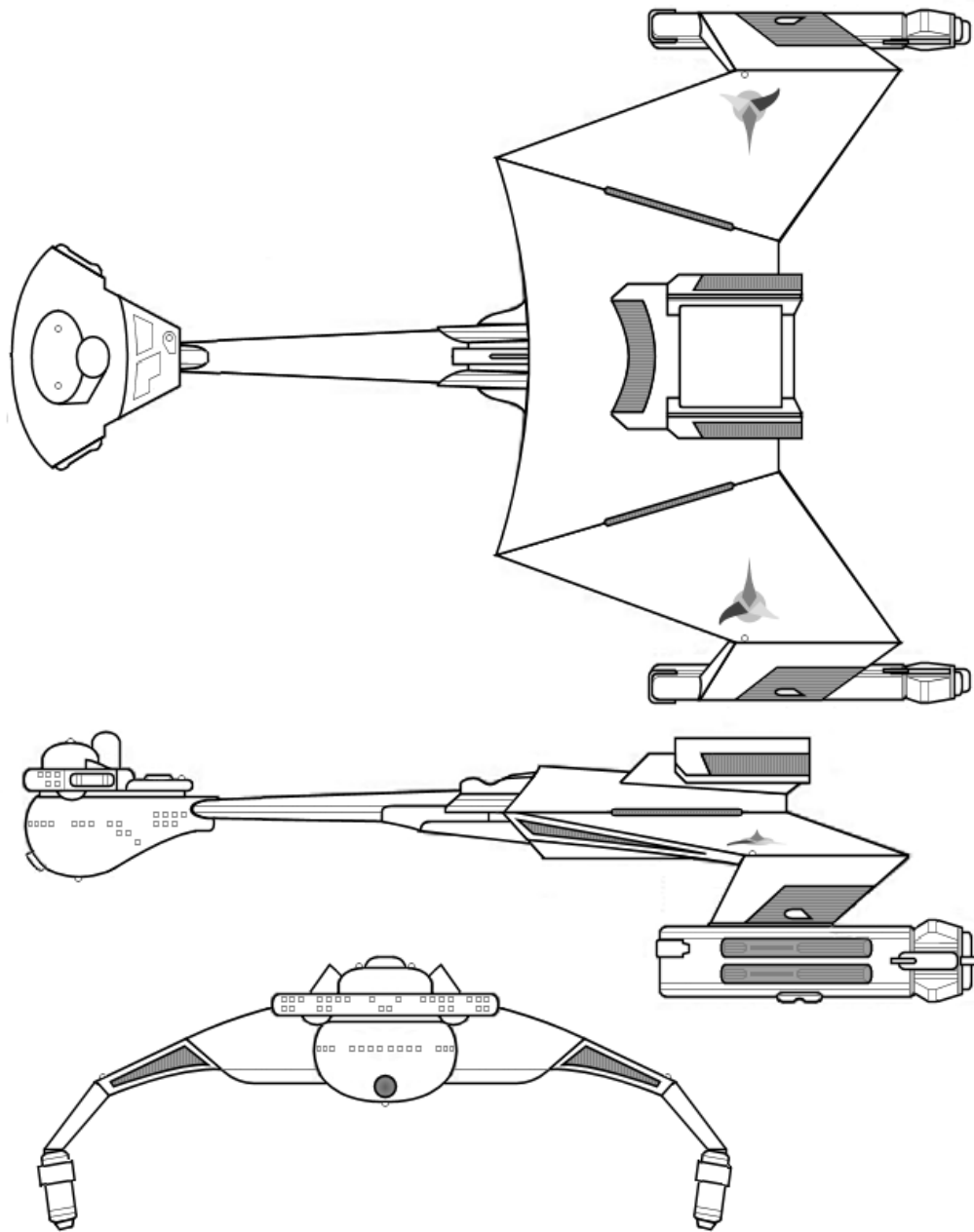

Klolode class Klingon battlecruiser created by Walter Matthew Jeffries
Raxor modifications from the Klingon battlecruiser model by AMT Corporation

Additional background material courtesy of James Dixon, Stephen V. Cole,
Michael McMaster, and the *STAR TREK* Expanded Universe wiki

Visuals courtesy of Atrahasis

Schematics by Richard Mandel
based on the work of Neale Davidson (Pixel Sagas)

Klolode

mayDuj type 4 (*Drell* type 7) [2253]

Specifications as built

Dimensions

Length:	216.4 meters
Beam:	152.4 meters
Height:	55.2 meters

Mass

Standard gross:	434,500 GMT
Subspace displacement:	110,000 DWT

Crew complement

Officers:	64
Enlisted:	340
Imperial Guards:	up to 50 (in support of assault operations)

Top velocity

Cruising speed:	warp 7
Rated maximum speed:	warp 9

Endurance

Standard endurance:	estimated 3 years at L.Y.V.
---------------------	-----------------------------

Armament

Disruptors:	8 standard disruptors (2 F, 2 A, 2 ea. P/S) 2 heavy disruptors (F only)
Guided weapons:	1 photon torpedo tube (F) drone racks (*)
Other:	see notes

(*) Spotted only on selected House models. These come at the expense of other on-board weapons, usually replacing the heavy disruptors (2:1 basis) or the standard disruptors on the secondary hull (3:2 basis).

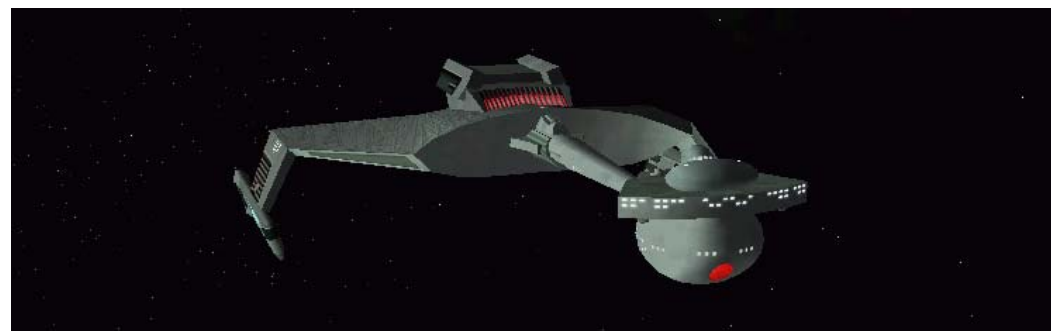

Known starships

Hull #	Name of starship	Builder	Status
KRD07-001	<i>Klolode (Death Grip)</i>	---	lost
KRD07-002	<i>Varchas (Maw of Death)</i>	---	active
KRD07-009	<i>Klothos (Close-In Strike)</i>	---	active
KRD07-034	<i>Akif (Deadly Spike)</i>	---	trans-R
KRD07-192	<i>Gr'oth (Unbreakable)</i>	---	active
KRD07-486	<i>Korezima (Eternal Victor)</i>	---	capt-F
KRD07-818	<i>Ekkava (Blade of My Strength)</i>	---	active
KRD07-1017	<i>Hakkari (Vanguard)</i>	---	active
KRD07-1018	<i>Tarkan (Swordpoint)</i>	---	active
?	<i>Falchion (Fight of the Many)</i>	---	active
?	<i>Fe'l'rin Tor (Fire Blossom)</i>	---	active
?	<i>Ghargh (Serpent)</i>	---	active
?	<i>Kormak (Little Scavenger)</i>	---	active
?	<i>Rapache (Carrion)</i>	---	active
?	<i>Toramaal (Star Destroyer)</i>	---	active
?	<i>Susjev (Stormwind)</i>	---	active
?	<i>Taj' (Knife)</i>	---	active
?	<i>Varchas (Maw of Death)</i>	---	active
?	<i>vo'taQ (Exotic Motion?)</i>	---	active

For almost five decades *Klolode* has remained the definitive *Drell*-based Klingon battlecruiser design. Its maneuverability and acceleration remain among the most impressive for starship of its size and mass. Its heavy armaments make the equal, sometimes the superior, of comparable starship classes along all Klingon borders. Its reputation is legend, having served as the backbone of the Imperial fleet ever since its introduction in 2253. It directly inspired the design of its own successors, *K't'inga* and *chetvi'na*. Even with the introduction of the popular *B'rel*, the venerable *Klolode* still remains the symbol of the Klingon Empire in the hearts and minds of many still today.

Klolode began life as a project intended to address the known deficiencies of *Raxor*, its immediate predecessor in the *Drell*-type battlecruiser lineage. *Raxor* had not performed as well as had been hoped against the Kinshaya during the Demon War, and this was largely due to its weapons and shieldings arcs. Like most Klingon starships of the era *Raxor* had been build with a head-on attack in mind. Klingon battle tactics called for *Raxors* to operate in three-starship "wolf packs," thus partially offsetting their poor weapons and shielding coverage on their sides. The Klingons had not anticipated the possibility that Kinshaya vessels would have superior shielding capabilities, with all possible firing arcs covered. Kinshaya battle tactics quickly developed into a one-two punch of first breaking up Klingon battlecruiser wolf packs and then firing on individual ships on their poorly protected flanks. This tactic did not work on the Klingon battleship of the era, though, since *Jul'kar* had superior flank and aft weapons and shielding coverage than did *Raxor*. Klingon designers took note of this and decided to incorporate *Jul'kar* shielding generators and additional weapons systems into the next generation of *Drell*-type battlecruisers. This would turn out to be the *Drell* type 7, better known as the *Klolode* class battlecruiser.

Klolode is undoubtedly the best known of the various *Drell* designs. For over two decades it was the primary Klingon battlecruiser serving along the border with the Federation. During that time it made quite an impression on the Federation, both Starfleet personnel and civilians alike. It was an almost perfectly balanced mix of weaponry, maneuverability, and acceleration. Its only real drawback was that it was slightly slower at maximum warp than its Federation counterpart, Starfleet's legendary *Constitution* class starships.

In 2268 *Akif* and 172 other older *Klolode* and *Raxor* class battlecruisers were given to the Romulans under the terms of the Treaty of S'marba. This was a significant technology exchange for both parties: the Romulans gaining a modern fleet of starships and the Klingons getting cloaking

device technology in return. This select group of *Drell*-type hulls is often known as the *Akif* sub-class in reference works dealing with the Treaty of S'marba and Klingon starship transfers to Romulan service. The *Akif* sub-class was the first and largest such transfer, comprised entirely of well-worn but serviceable Klingon D-6 and D-7 battlecruisers from which the photon torpedo and heavy disruptor systems had been stripped. The entire *Akif* sub-class would be converted by the Romulans into the V-11 "Stormbird" configuration, complete with cloaking devices and plasma weaponry.

Gr'oth (tH. "Unbreakable") was the first upgraded *Klolode* ever to be observed by the Federation. It paid a courtesy call to Federation Deep Space Station K-7 in 2267. As it left the station *Gr'oth* suffered "a massive infestation of tribbles" that had been beamed aboard the ship by Lt. Commander Montgomery Scott, chief engineer of the starship *Enterprise*, which was also visiting the station at the time. Scott's action was in response to his captain's order to clear a similar infestation off of the *Enterprise*, although some have theorized that he may have been motivated by a bar fight between his ship's crew and that of the *Gr'oth* the day before aboard K-7. The last confirmed transmission from the *Gr'oth* had its crew fighting valiantly to regain control of their vessel from hundreds of thousands of fast-breeding tribbles filling the ship's decks and holds. The battle to save the ship was severely hampered by the fact that "Klingons and tribbles don't like each other." A second minor modification to *Gr'oth* was noted upon a return trip to the Treaty Zone in 2269, when it became the first Klingon warship to use a stasis field generator in combat with a Starfleet vessel. The results of that encounter were mixed; however, it paved the way for the improved stasis field generators later fitted on larger Klingon capital ship classes.

Starfleet has only one example of a *Klolode* in its Adversary Squadron. *Korezima* was recovered by Starfleet in 2269 as an abandoned yet largely intact hulk. Its position had been reported to the starship *Moscow* (NCC-1357) by the starship *Enterprise* (NCC-1701) not long after the *Korezima* had come out on the losing end of an encounter with a Chatalia generation ship. *Korezima's* self-destruct had failed to activate properly, leaving the Klingon ship damaged but not destroyed. Most of the damage was internal, aside from some minor hull breaches in the engineering sections. *Moscow* towed the *Korezima* until a prize crew could affect sufficient repairs, after which it proceeded under its own power to the nearest Federation port. This was *Moscow's* last action before ending its career as one of the oldest cruisers in Starfleet service. After extensive analysis by Starfleet Intelligence, *Korezima* was fully repaired and eventually refitted for Starfleet adversary training.

Schematics

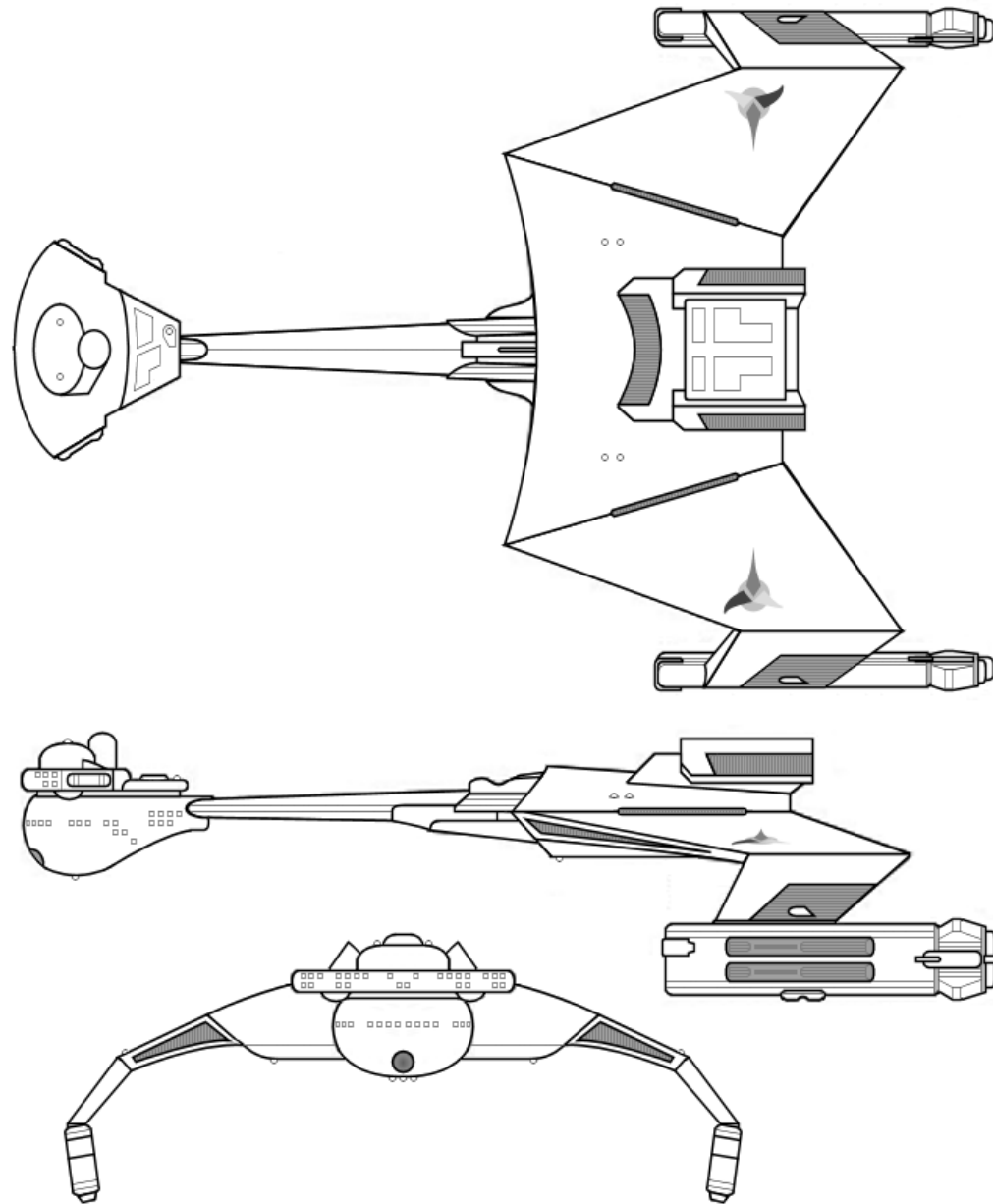

***Klolode* class Klingon battlecruiser created by Walter Matthew Jeffries as seen on screen in *STAR TREK TOS* (“Elaan of Troyius,” “Day of the Dove”) and *Deep Space Nine* (“Trials and Tribble-ations”) *Deep Space Nine* “uprated *Klolode*” by Greg Jein**

***Klolode* class name from the *Star Trek Log* series of books by Alan Dean Foster**

Selected *Klolode* class starship names derived from both on screen and licensed (novel, comic, & game) sources

Name translations based on Mark Okrand’s *The Klingon Dictionary* and various online Klingonaase compilations

Additional material courtesy of Memory Alpha, Memory Beta, Doug Drexler, Aridas Sofia, and the various authors of other referenced licensed works

Visuals courtesy of Atrahasis, Andrew J. Hodges, Warped9, and Starship Modeler

Schematics by Neale Davidson (Pixel Sagas)

K`t`inga

***mayDuj* type 5 (*Drell* type 8 mod 4) (2268)**

Specifications as built

Dimensions

Length: 214.3 meters
Beam: 152.4 meters
Height: 57.3 meters

Mass

Standard gross: 490,750 GMT
Subspace displacement: 120,000 DWT

Crew complement

Officers: 45
Enlisted: 230
Imperial Guards: up to 50 (in support of assault operations)

Top velocity

Cruising speed: warp 8
Rated maximum speed: warp 11

Endurance

Standard endurance: estimated 3 years at L.Y.V.

Armament

Disruptors: 8 standard disruptors (4 F, 2 A, 2 ea. P/S)
2 heavy disruptors (F only)
Guided weapons: 2 photon torpedo tubes (1 ea F/A)
Other: cloaking device



Known starships

Hull #	Name of starship	Builder	Status
KRD08-000	<i>Koro (Vigilance)</i>	Taamar Shipyards	ptype
KRD08-001	<i>K't'inga (Skillful Demon)</i>	Taamar Shipyards	active
KRD08-023	<i>Amar (Hunter)</i>	Iosia Shipyards	lost
KRD08-065	<i>Qo'Nos wa' (Kronos One)</i>	Gnuu Re' Shipyards	active
KRD08-072	<i>T'Ong (Venerated Vessel)</i>	Z'hai Shipyards	active

For almost two centuries the *Drell* type battlecruiser has been the mainstay of the Klingon fleet. It is a proven design, whose maneuverability and many exploits in battle are legend. The *Drell* type hull is the trademark form for Klingon starships, and every class produced since its introduction sometime prior to Federation first contact has been influenced by it to some degree. *K't'inga* is but the latest incarnation of the *Drell* legacy, refitted with the latest in Klingon starship technology and weapons systems in order to match the best that other interstellar powers have to offer. It will no doubt serve the Empire in the years to come as ably as its venerated predecessors have done in the past.

K't'inga started out life as an extended refit of the venerable D-7 *Klolode* class battlecruiser. An early form of this refit was first observed on the *Gr'oth*, a D-7 under the command of Captain Koloth and assigned to the Federation Treaty Zone Defense Fleet. It paid a courtesy call to Federation Deep Space Station K-7 for purposes of shore leave under the terms of the Organian Peace Treaty. Station Manager Lurry had no choice but to accept Koloth's request for shore leave, but did so under conditions laid down by Captain James T. Kirk, the senior Starfleet officer present in the area. Kirk and his crew had ample time to take detailed sensor scans of the *Gr'oth* and its apparent upgrades, which were then forwarded on to Starfleet Intelligence. While not a true *K't'inga* in the modern sense, *Gr'oth* did give some indication of how *K't'inga* was going to develop. Its shielding grid had been significantly advanced and it mounted a new version of Klingon standard disruptors. It was also the first Klingon battlecruiser ever observed fitted with a modern photon torpedo system (although Klingons have had various forms of photonic weaponry for over a century). This eventually replaced heavy disruptors as the preferred heavy weapon of choice for *Drell* types and their derivatives, although heavy disruptors still have their place in the Empire's arsenal of starship weaponry.

The *K't'inga* class proper, meaning new builds as opposed to upgraded older hulls, appears to have entered service sometime in 2268, either around or shortly after the Klingon-Romulan Alliance was formalized. The earliest indication of this was during Operation Purloin on the Romulan Border, when D-7s in Romulan service were encountered for the first time. These lacked the upgrades observed on the *Gr'oth* the year before, suggesting (correctly) that the Klingons had sold off a fair portion of their older battlecruisers to help pay for a new class. That class turned out to be *K't'inga*, which pushed the classic *Drell* hull to its uppermost limits in terms of system upgrades and technology changeouts. The existence of the class remained rumor until the Vger Incident of 2272, when a squadron of three *K't'ingas* unsuccessfully attempted to intercept the Intruder as it made through Klingon space. All three battlecruisers were destroyed in quick succession. The nearby Epsilon Nine monitor station managed to transmit a

full record of the encounter along with its scans of all three *K't'ingas* before it too was destroyed by the Intruder. The Epsilon Nine scan data provided most of what is known about *K't'inga* today.

The Vger Incident, combined with the total loss of every Klingon starship and squadron sent to intercept it (in particular the aforementioned *K't'inga* squadron), was considered a loss of face by the Klingon High Council. *K't'inga* production was actually suspended for a period of time while new designs were toyed with as potential replacements. In the end, though, the High Council quietly admitted to the inevitable defeat of whatever vessels they would have sent against the Intruder and quit blaming non-existent weaknesses in their design. *K't'inga* production has since resumed, although not quite on the same scale as before, and it is expected to remain in production until the new chetvl' class heavy cruisers can begin production.

K't'inga was originally classed as a *Drell* type 8 hull per its naval construction contract -- or to be more specific, *Drell* division 8 type 4 (model 4) per the translation. When it was commissioned into fleet service, however, it was repeatedly referred to by the Klingon High Command as a *Drell* type 7 due to its visual similarities with its upgraded predecessor. This practice was so widespread that the terminology has since "stuck," meaning that both *K't'inga* and upgraded *Klolode* class battlecruisers are called D-7 battlecruisers in contemporary Klingon action reports (tH. *Soch mayDuj'h*, lit. "type D-7 battlecruiser"). This practice has caused no end of confusion for both Starfleet Intelligence and civilian starship spotters alike.

The fact that *K't'inga* conforms to the basic *Drell* hull shape has meant that it has been the subject of many conversions and custom configurations, even as its predecessors were. While they do not come close to the record set by the *Kuve* class frigate, nevertheless it is fair to say that for every major mission profile possible there is a specialized *K't'inga* to match. Every one of the Great Houses and many of the Lesser Houses have produced their own customized *K't'ingas* or unique *K't'inga*-based hybrids. At least a dozen *K't'ingas* were also pulled from active service and used as testbeds for those experimental technologies that were eventually fitted to the new "Taldren generation" of Klingon warships.

Unlike its predecessors, *K't'inga* comes equipped with a cloaking device as a standard feature. It was one of the first Klingon starship classes to be launched from the yard with this Romulan-derived device as a standard feature. This can render a starship almost invisible to the naked eye and most forms of active scanning. This immediately makes *K't'inga* an even more deadly opponent than its legendary predecessors or Romulan counterparts.

There are almost a dozen major shipyards and some half-dozen minor ones within the Empire that manufacture *Drell* type battlecruisers. Most of these are now wholly dedicated to *K'tinga* production. Only one, H'rez, still builds *Klolode* in its modernized, pre-*K'tinga* form. Both Taamar and Iosia offer the three-nacelled *betleH* command cruiser conversion as an option for House fleets as part of their respective *K'tinga* shipbuilding efforts. Both of these programs are believed to be privately funded House efforts. At least one major *K'tinga* producer, Chenwl' Duj, has been authorized to produce *K'tinga* intended successor, *chetvl'na*. The others are expected to follow as soon as possible once the Empire's economy recovers sufficiently from the aftereffects of the Praxis Event of 2293.

The name *K'tinga* is a clipped form of *Kh'ta'ngan*, a word carried over from the Klingon Old Tongue according to the lore of the monks of Boreth. In their records of Klingon mythlore *Kh'ta'ngan* is the most powerful warrior among Klingon demons. He can change his form at will and is equally skilled with all known weapons. Kahless is said to have fought *Kh'ta'ngan* over his right to enter *Sto-Vo-Kor*, the Klingon paradise. After Kahless managed to defeat *Kh'ta'ngan* (the exact manner is not made clear) the demon warrior acknowledged his valor and became his friend. *Kh'ta'ngan* then joined Kahless on his journey to *Sto-Vo-Kor*, helping him to win many other battles along the way. *Kh'ta'ngan* could not enter *Sto-Vo-Kor* because he was a demon, so Kahless asked him to stand guard over his Empire until he could return. Thus the spirit of Kahless referred to so often in Klingon culture is actually that of his proxy *Kh'ta'ngan*, who is said to visit the best of young Klingon warriors in their dreams in the guise of his friend Kahless. In this manner *Kh'ta'ngan* keeps his promise to Kahless by ensuring the future warriors of the Empire will be inspired to continue walking the path Kahless first laid down for them – the “warrior's way” of the Klingon Empire.

Schematics

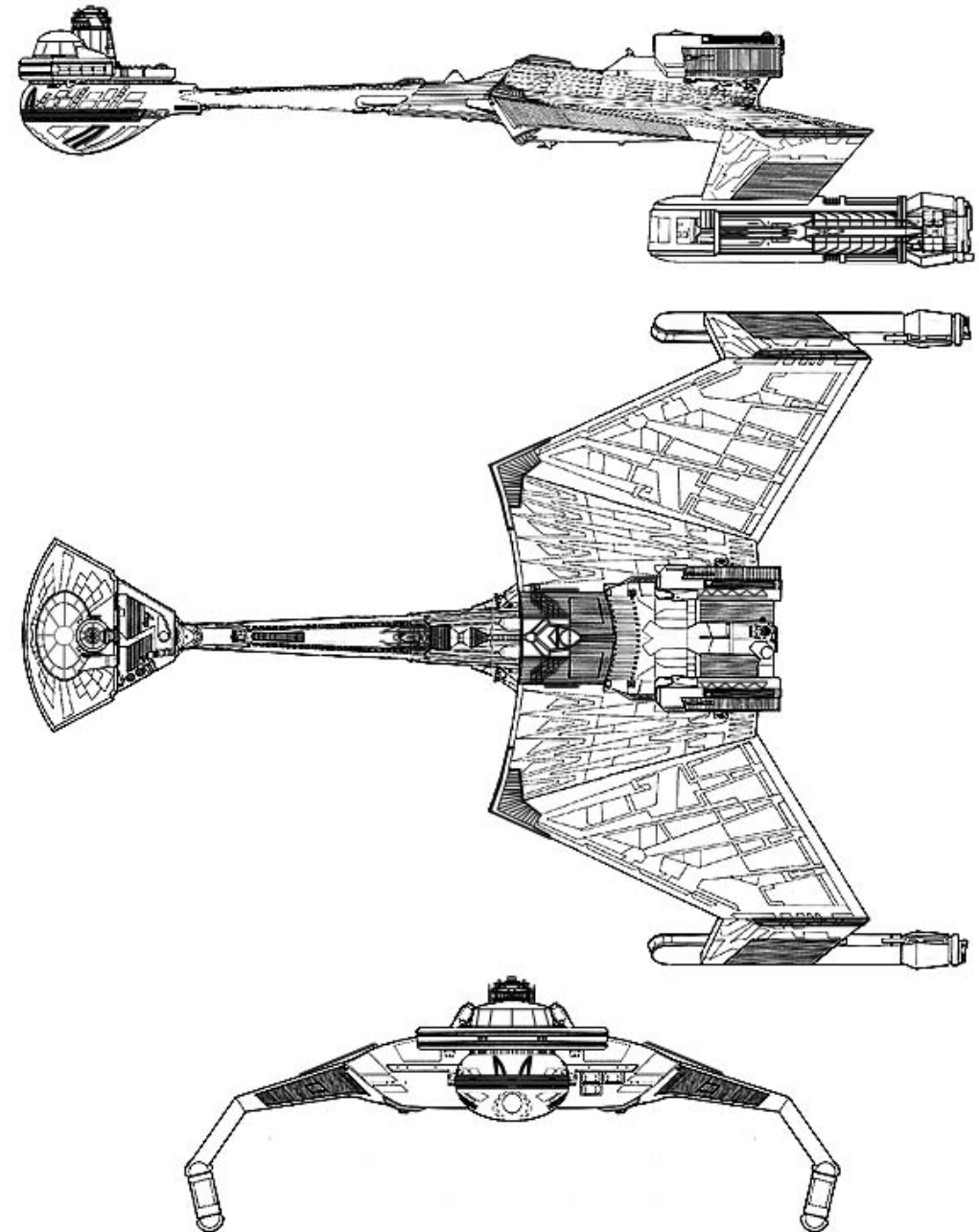

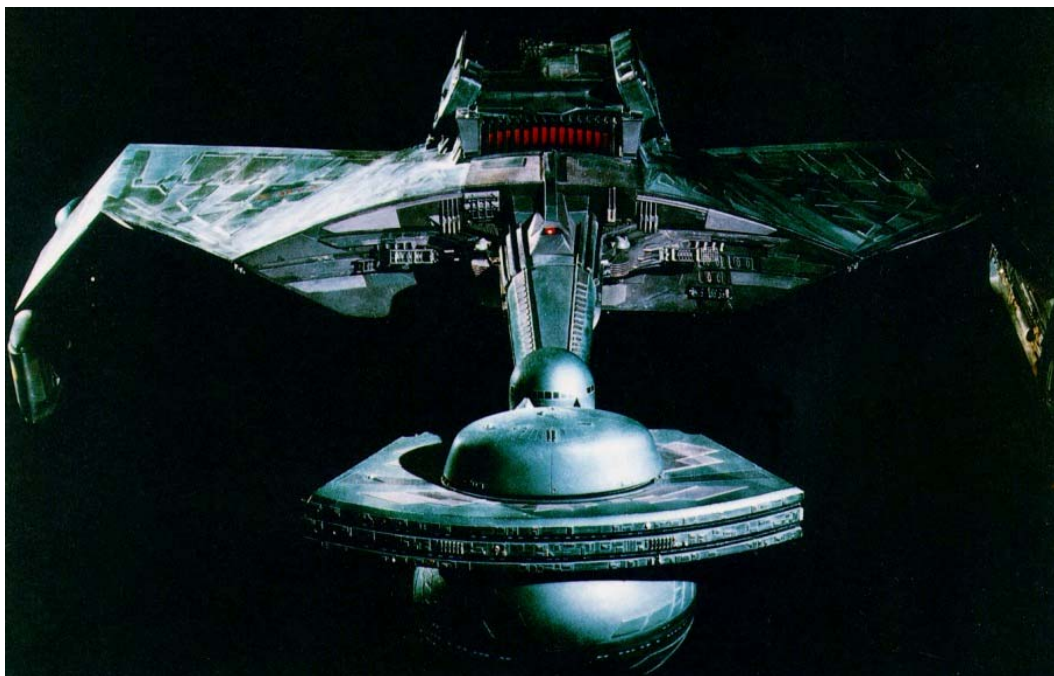

K't'inga class battlecruiser created by Walter Matthew Jeffries and Apogee, Inc.
as first depicted in the feature film *STAR TREK – The Motion Picture*

Kl'olode class name from the *Star Trek Log* series of books by Alan Dean Foster

Additional background material courtesy of CBS Paramount, Alan Dean Foster,
Harold Livingstone, Activision Games, and FASA Corporation

Visuals courtesy of CBS Paramount

Schematics by Todd Guenther and Aridas Sofia
(*Federation Reference Series, Starship Design*)

betleH

***mayDuj* type 6 (*Drell* type 8 mod 5) (2269)**

Specifications as built

Dimensions

Length: 214.3 meters
Beam: 157.4 meters
Height: 57.3 meters

Mass

Standard gross: 520,750 GMT
Subspace displacement: 128,500 DWT

Crew complement

Officers: 45
Enlisted: 230
Imperial Guards: up to 12 (special case, see description)

Top velocity

Cruising speed: warp 9
Rated maximum speed: warp 12

Endurance

Standard endurance: estimated 3 years at L.Y.V.

Armament

Disruptors: 8 standard disruptors (2 F, 2 A, 2 ea P/S)
2 heavy disruptors (both F)
Guided weapons: 2 photon torpedo tubes (1 ea F/A)
1 drone rack
cloaking device



Known starships

Hull #	Name of starship	Builder	Status
KRB01-022	<i>betleH</i> (<i>Great Curved Sword</i>)	Vekah Shipyards	active
KRD08-109	<i>Valkatha</i> (<i>Eternal Protector</i>)	Iosia Shipyards	active

betleH is named for the first Klingon starship, a modified B-1 *Jul'kar*, to be rebuilt to this unique design. Its boom had been destroyed in combat and its owner could not afford a new *Jul'kar* boom. Rather than lose the most powerful starship in his House fleet, so the story goes, he simply tacked on the boom from a crippled *Raxor* and sent it back into service. The modern *betleH* follows this heritage, in a sense, in that all of the members of its class follow this same conversion pattern. Every *betleH* in service has been converted from an existing *K't'inga* or uprated *Klolode*. This conversion is offered by the Taamar and Iosia shipyards primarily for Lesser Houses who can't afford any of the newer Imperial fleet heavy designs. It has also found its way, albeit in limited form, into the Imperial fleet as a *Suvwl'QeH* backup. Imperial *betleHs* can most often be found operating in areas too remote (or sometimes too contested) for a *Suvwl'QeH* to be "wasted" upon. House *betleHs* are almost always found operating as flagships for the fleets of Lesser Houses.

The origin of the *betleH* conversion parallels the development of the *Suvwl'QeH* class command cruisers. These conversions began entering Imperial service a full year before the first production *Suvwl'QeH* was built in 2270. It seems to have been a Klingon case of "gotta have it now," given the original *Suvwl'QeHs* impressive combat performance in 2268. *betleH* conversions were a quick-and-dirty means of producing a modified battlecruiser that approached *Suvwl'QeHs* performance in a minimum amount of time.

Perhaps the most unusual aspect of *betleH* is the use of its third *pljonta'*. It is mounted in the same style as that of *Jul'kar/Kuyper*. This of course causes unnatural distortion in *Drell* hull warp harmonics. In theory *betleH* should have had a cruising speed of warp 10; however, the warp field aberrations caused by its *pljonta'* configuration places a practical limit of warp 9 on its sustainable cruising speed. In practice what happens is that *betleH* commanders reserve their third *pljonta'* for the exclusive use of their ship's shielding systems. The "original" two *pljonta'* are used to power propulsion, ship's systems, and weaponry while the third maintains the ship's shields at full strength. In this manner a *betleH* can remain in the thick of battle far longer than can a regular *K't'inga* or uprated *Klolode*. This practice has since been copied to combat operations for other similar Klingon starship designs, such as *K'herr* and *Suvwl'QeH*.

Imperial Guard barracks are removed on all *betleH* conversions in order to provide room for a C3 suite. It is known that some *betleH* commanders have replaced a dozen of their own security personnel with a single squad of Imperial Guards. This allows these vessels to retain a minimal boarding party combat capability with warriors more suited for such a task.

At this date only 27 *betleH* conversions are known to exist. 11 of these are in Imperial service. 10 head the fleets of various Lesser Houses, while the rest serve in various capacities with the Greater Houses.

Schematics

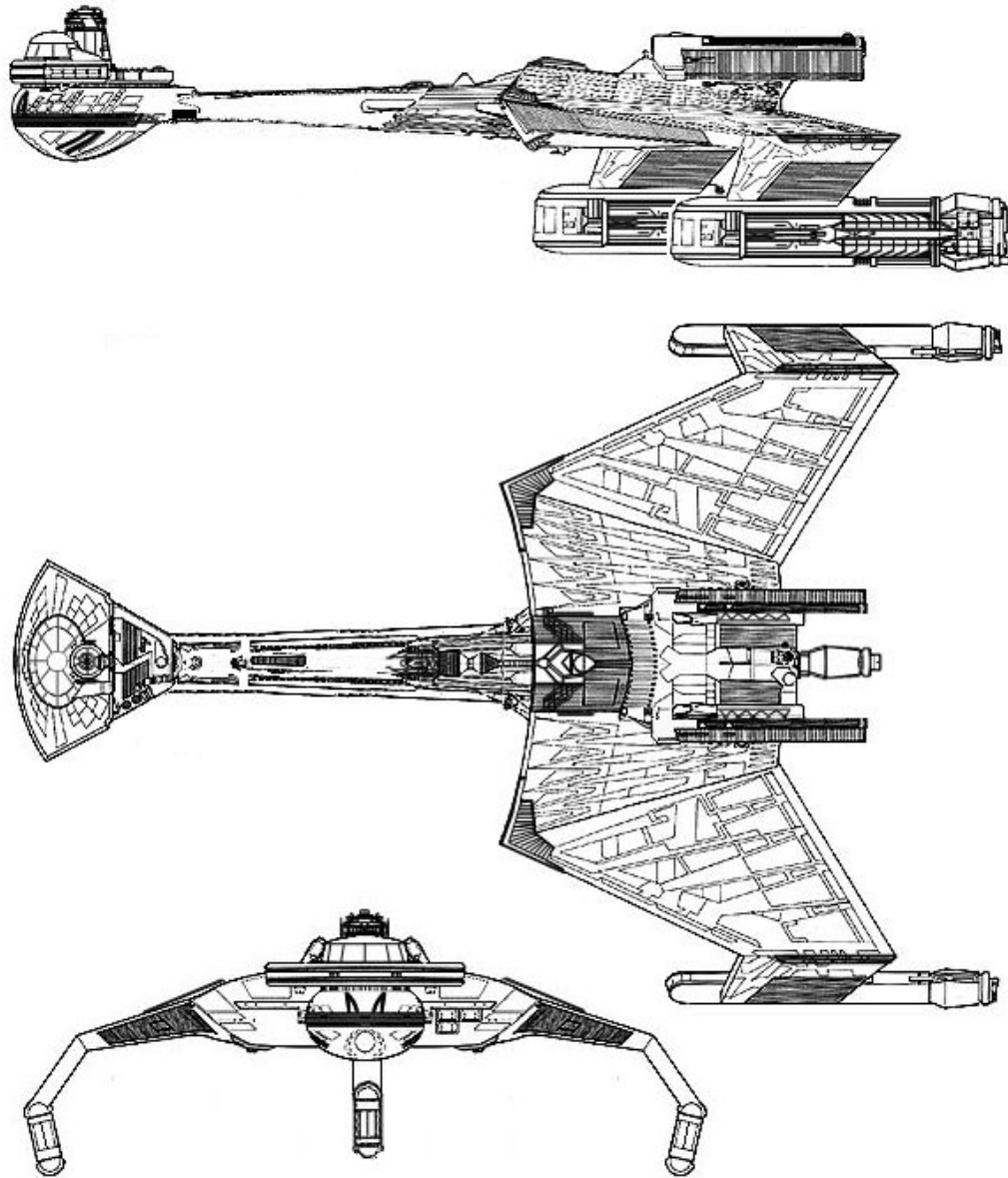

betleH class Klingon command cruiser by W. J. Casmir
derived from the work of Walter Matthew Jeffries and Patrick Flannery

Additional background material courtesy of Activision Games (*Klingon Academy*),
Desty Nova, and Amarillo Design Bureau (*Star Fleet Battles*)

Visuals courtesy of Terradhyne

Z`gal

***mayDuj* type 7 (*Drell* type 9) (2269)**

Specifications as built

Dimensions

Length: 160 meters
Beam: 110 meters
Height: 24 meters

Mass

Standard gross: 430,500 GMT
Subspace displacement: 105,000 DWT

Crew complement

Officers: 60
Enlisted: 320
Imperial Guards: up to 40 (in support of assault operations)

Top velocity

Cruising speed: warp 8
Rated maximum speed: warp 12

Endurance

Standard endurance: estimated 5 years at L.Y.V.

Armament

Disruptors: 4 standard disruptors (2 F, 2 P/S)
2 heavy disruptors (F only)
Guided weapons: 1 photon torpedo tube (F only)
Other: cloaking device



Known starships

Hull #	Name of starship	Builder	Status
KRD09-001	<i>Z`gal</i> (<i>Seeker</i>)	Gnuu Re' Shipyards	active

Z'gal is the closest that the Klingon Empire has ever come to building a dedicated exploratory cruiser. Make no mistake – *Z'gal* is a typical Klingon *Drell*-type battlecruiser, armed to the teeth and ready for a fight. It is just that certain of its internal systems and spaces are not what you would expect to find aboard a typical Klingon starship.

According to most reports *Z'gal* was designed for missions in the spinward borders of the Empire, which in the mid-23rd century were reportedly largely unexplored. It was essentially a scaled-down version of the old *D'aka* assault cruiser reconfigured for the deep space explorer role. Its enlarged secondary hull “bulge” was fitted with a wide range of science and research facilities suitable for the long-term exploration of deep space. As befitting a Klingon vessel, though, *Z'gal* also carried battlecruiser firepower. Many of the unknowns in space were dangerous, and some might even prove hostile to Klingon expansionist aims. The goal of *Z'gal* was to further the spread of the Empire – by non-violent exploration when possible, by armed force whenever the need became apparent. As such *Z'gal* was ideally suited for the intended mission profile. In fact, the design proved so successful that more were produced for similar roles on the other borders of the Empire, as well as exploring strange and mysterious phenomena within Imperial space itself.

Z'gal officially ended production in 2288. This was done because the Klingons felt they didn't need any more *Z'gals*. Theirs was and still is primarily a warrior's culture. Such things as science and exploration for the sake of adventure itself held no glory for warriors trained in and looking for battle. Such tasks were for the *pujwl'* (tH. “weaklings”) incapable (or in some cases no longer capable) of serving on a real warship. Troubles with the Federation were brewing, and other enemies both old and new were again testing the Empire's borders. What was needed were less *Z'gals* and more *drells* and *dakastas*. The end of *Z'gal* production thus left *Z'gal* an orphan – the only explorer-type starship class ever built by the Klingon Empire to date.

A total of 32 *Z'gals* were built at the Gnuu Re Shipyards from 2269 to 2288. Of these, 18 remain in active service, with all receiving the equivalent of a modified *Kl'olode* upgrade as of 2290. 12 are lost (9 destroyed, 3 missing), and 2 disarmed versions have been sold to private interests within the Triangle.

Schematics

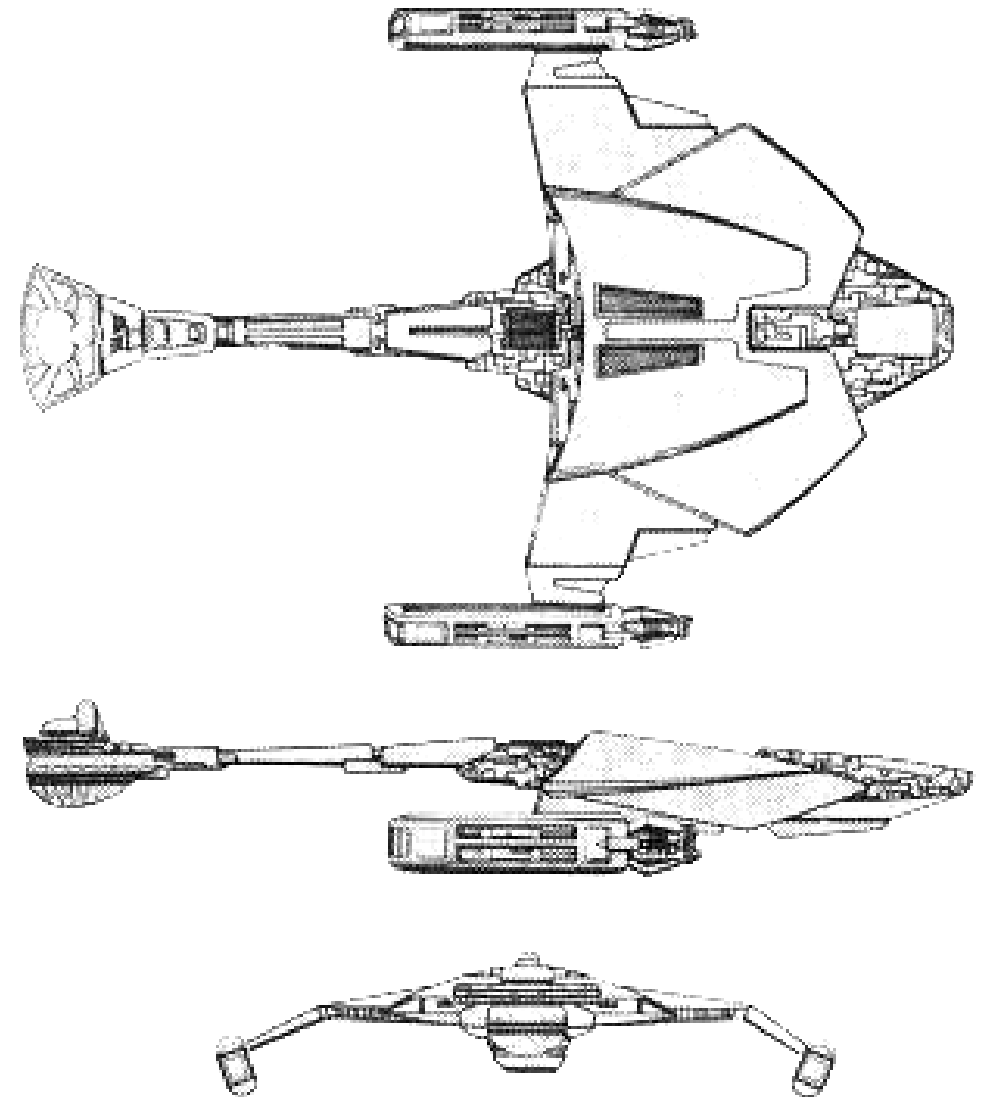

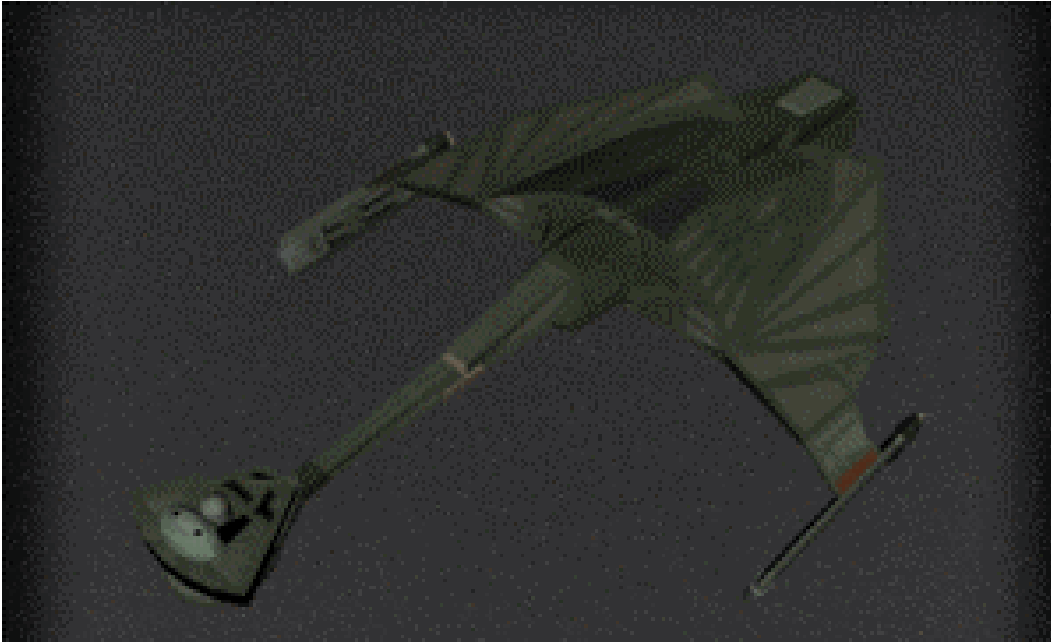

***Z'gal* class Klingon battlecruiser
created by Forrest G. Brown and Dana Knutson
for *STAR TREK – The Role-Playing Game* by FASA Corporation**

Additional background material courtesy of Brad Torgerson

Visuals courtesy of Paul Brown, Tyrel Lohr, and Korah

Schematics by Dana Knutson

Suvwl' QeH

mayDuj type 8 (*Drell* type 11) (2270)

Specifications as built

Dimensions

Length: 336 meters
Beam: 156 meters
Height: 78 meters

Mass

Standard gross: 806,000 GMT
Subspace displacement: 200,000 DWT

Crew complement

Officers: 84
Enlisted: 266
Imperial Guards: up to 45 (in support of assault operations)

Top velocity

Cruising speed: warp 9.4
Rated maximum speed: warp 14.6

Endurance

Standard endurance: estimated 3 years at L.Y.V.

Armament

Disruptors: 8 standard disruptors (2 F, 2 A, 2 ea. P/S)
Guided weapons: 3 photon torpedo tubes (2 F, 1 A)
2 drone racks (1 ea P/S)
Other: GHRC pulse generator
(tied into disruptor and tractor systems)



Known starships

Hull #	Name of starship	Builder	Status
KRD08-134	<i>Suvwl'QeH (Warrior's Anger)</i>	H'rez Imperial Yards (conv.)	active
KRD09-001	<i>Kroj'duH (Blissful Demon)</i>	Gnuu Re Shipyards	active
KRD09-003	<i>tpuy'egh (Decimation)</i>	Gnuu Re Shipyards	active
KRD09-004	<i>buQ'a' (Ultimate Menace)</i>	Gnuu Re Shipyards	active
KRD09-011	<i>K'tanco (Exorcist)</i>	Gnuu Re Shipyards	active

Suvwl'QeH followed close on the heels of the D-8C *betleH* command cruiser. In fact, the D-8C modification was inspired by the original *Suvwl'QeH*, an extensively modified *K't'inga* that was the personal vessel of Doj'kan of House Gorthas. *Suvwl'QeH* quickly proved itself superior to *betleH* conversions once the class entered Imperial service. Since its introduction in 2270 it has quickly replaced the *betleH* as the command ship of choice in all Klingon border fleets and patrol squadrons, while its predecessor has been relegated to lesser roles.

This class already had a storied history long before it entered Imperial service. The Klingons call it *vav bortaS* (tH. "father's revenge"), since the original *Suvwl'QeH* conversion was commissioned as an act of vengeance. Kroj'duH son of Doj'kan had been a promising young warrior when he was killed along with many of his fellows in a training accident in early 2268 on an old frigate that resulted from negligence on the part of Krang son of Galtz, cadet chief engineer of the training ship to which Kroj'duH had been assigned. Rather than accept the responsibility for his son's incompetence Galtz conspired with other members of the House of Moltak to cover up Krang's blunder and shift the blame to the deceased Kroj'duH. Dok'jan, who had been a starship engineer for decades and served as chief engineer on several vessels before ascending to the leadership of his House, refused to believe that the son he had personally trained would be capable of so blatant an error as what had been charged in the official reports. It took some time, considerable effort, and the redeeming of many favors; however, Dok'jan ultimately learned the truth about the coverup. The infuriated officer also learned that Krang son of Galtz would be granted the honor of commanding of his father's battlecruiser after completing his basic starship training in half a year's time. Blinded with rage and the desire to avenge the honor of his son, Doj'kan used all of his talents and much of the resources of House Gorthas to convert his personal battlecruiser *Suvwl'QeH* into the instrument of his vengeance. The conversion was carried out in secret at the H'rez Imperial Yards, a minor shipbuilding facility that owed House Gorthas several favors, and the vessel was completed within the time required for Doj'kan to act on his desire.

Just over six months later Galtz, his brother Mortak, and most of the leadership of House Mortak was on hand as Krang son of Galtz took command of his father's *K't'inga* class battlecruiser after it had completed a routine maintenance overhaul. They were on their way back to port from a brief shakedown cruise when they were intercepted by a Klingon starship of unfamiliar design. Krang followed Imperial procedure and hailed the ship but was greeted in return by a broadcast that turned his blood cold. It was the spoken testimony of one of the bridge officers of the training frigate relating the true account of how Krang was responsible for the deaths of Kroj'duH and his fellow cadets. His infuriated uncle Mortak interrupted the

broadcast and demanded to know who was commanding the ship before him. Dok'jan showed himself and challenged Mortak and his house to ship-to-ship combat in a blood duel over the lost honor of his son. Mortak was quick to realize that Dok'jan's new ship was most likely more powerful than his own and attempted to back down, but his nephew Krang would have none of it and ordered his crew to open fire. Krang's act cost him not only his life but the deaths of his entire crew and all members of House Mortak that were on board his ship, including his father Galtz and uncle Mortak. The *Suvwl'QeH* made short work of the *K't'inga*, which at the end feebly attempted to flee on impulse power, its shields and weapons destroyed and its *pljonta'* blown off of their pylons. It is said that just before the final blow was delivered Dok'jan called Krang one last time. He said simply, "My son is now avenged" before sending one last spread of photon torpedoes into his doomed prey.

In the end the High Council ruled that Dok'jan's actions had been justified. The Klingon High Command was understandably impressed by the data recordings Dok'jan made of the battle. A number of *K't'ingas* were hurriedly converted to a derivative design (*betleH*) while arrangements were made for construction of a true *Suvwl'QeH* class for Imperial service. Construction was eased by the fact that existing *K't'inga* base space frames were easily adapted to the new design, thus saving both time and valuable Imperial resources.

Suvwl'QeH should not be viewed merely as an improved *betleH*. Doj'kan's redesign also implemented captured Gorn weapons technology, turning this vessel into a formidable opponent that can hold its own against a Federation *Excelsior* despite being the smaller of the two vessels.

The weapon that makes *Suvwl'QeH* rise above the ranks of other Klingon battlecruisers is the gravimetric harmonic resonance cannon (GHRC). It synchronizes the ship's tractor beams with its disruptor cannon to produce an eight-second, rapidly modulated series of switched tractor and repulsor beam pulses. The net effect of a GHRC blast is to literally begin shaking apart any object it strikes, with energy shields providing only minimal protection. The main drawback of the GHRC system is that any damage to any portion of a *Suvwl'QeH's* tractor beam emitter grid or disruptor arrays disables the GHRC. The drawbacks of the GHRC system have worked against its installation in other Imperial starship classes; however, House modifications on starships with sufficient power available (triple *pljonta'* designs or larger) are not unknown. One odd benefit is that firing a GHRC pulse, even if it is not targeted at anything, will instantly break a tractor beam of any strength that is locked onto a *Suvwl'QeH*. This feature of the GHRC system has been used by Klingon *Suvwl'QeH* captains to their advantage in several recent battles.

While these ships are fast growing in number within the Empire they have not been a common sight on the Federation border. It is believed that the larger and more heavily armed *voDleH* is being deployed as a command ship against Federation border fleets in *Suvwl'QeH's* place. If true this would be tacit recognition of the power of the post-*Excelsior* generation of starships that the Federation Starfleet is currently bringing into service, such as the recent *Lexington* and *Missouri* classes.

Suvwl'QeH's unique modified *Drell* hull form factor, with its curved (as opposed to angled) secondary hull and redesigned command boom, has set something of a standard for the generation of Klingon capital ship classes that followed in its wake. While not a clean break from the *Drell* it shows that contemporary Klingon starship designers, to borrow a Terran expression, are not afraid to think outside of the box when it comes to upgrading traditional starship designs. It is widely considered the first of the Taldren generation, or *puqpu' thIDrn* (tH. "children of my insight") of Klingon starships. The Taldren generation represents the best of both the hands and minds of most talented starship designers and builders that the Empire currently has to offer.

The first ship in the new *Suvwl'QeH* class command cruisers was named *Krod'juH* in honor of its designer Doj'kan's lost son. It entered Imperial service on 28 November 2270. Three more entered service in 2271, after which class construction proceeded at the rate of four per year. It is reported that the class will total 75 hulls once completed. In comparison, *betleH* conversions virtually ceased once *Suvwl'QeH* production began in earnest, save for the occasional requested House conversion.

Suvwl'QeH is the largest Klingon starship class that has managed to remain in constant production since the destruction of Praxis in 2293. This is due to the fact that the Gnuu Re' Shipyards, the primary contractor for the class, is located outside the Klingon home systems.

Schematics





***Suvwl'QeH* class Klingon command cruiser created by Taldren
for Activisions's *Klingon Academy* role-playing game**

Additional background material courtesy of Activision Studios and Donald Burns

Visuals courtesy of Moonraker and Wicked Zombie

Schematics courtesy of Taldren

Qu`Hegh

***mayDuj* type 10 (*Drell* type 20) [2284]**

Specifications as built

Dimensions

Length: 160 meters
Beam: 110 meters
Height: 24 meters

Mass

Standard gross: 380,500 GMT
Subspace displacement: 95,600 DWT

Crew complement

Officers: 30
Enlisted: 310
Imperial Guards: up to 400 (in support of assault operations)

Top velocity

Cruising speed: warp 8.0
Rated maximum speed: warp 9.4

Endurance

Standard endurance: estimated 2.5 years at L.Y.V.

Armament

Disruptors: 7 standard disruptors (2 F, 2 ea. P/S, 1 A)
2 heavy disruptors (F only)
Guided weapons: 1 photon torpedo tube (F)



Known starships

Hull #	Name of starship	Builder	Status
KRD20-001	<i>Qu`Hegh</i> (<i>Death Rite</i>)	Gnuu Re' Shipyards	active
KRD20-060	<i>jat`lyn</i> (<i>Soul Stealer</i>)	H'rez Imperial Yards	lost

Qu'Hegh was originally conceived two decades ago as the Empire's new "war cruiser" class, replacing the efficient yet derivative *Hak'hyl* in that role. It was believed that a dedicated design, as opposed to being just a *Drell*-type derivative, might spur innovation and provide more operational flexibility than the known limits of *Hak'hyl*. The results of *Qu'Hegh's* initial years in Imperial service have been a mixed lot. Operational duration and range were both increased at the cost of a weakened superstructure. Every other frame support bulkhead within the secondary hull was eliminated in order to provide just enough room for additional cargo holds – storage spaces that *Hak'hyl* decidedly lacked. The end result was a "war cruiser" that had almost the same firepower, shielding, and maneuverability as a battlecruiser; however, one or two well-placed heavy weapons salvos could destroy it. This is why the original 2270s era design was placed on the back burner for another decade while efforts were made at turning two prototype *Qu'Heghs* into better combat vessels.

The long-delayed improved *Qu'Hegh* finally entered service in mid-2284. It benefited from the technology advances that were being made with the Taldren generation of Klingon starships. One of these was completely redesigned base frame that provided the same support as the one that had been originally recommended while restoring only 35% of the support bulkheads eliminated in the original design. Another was the availability of the new *pljonta'*, which when combined with *Qu'Hegh's* lighter mass made it more maneuverable in combat than the legendary *Klolode* class battlecruiser. Improvements in weapons technology also enabled the new *Qu'Hegh* to sport an arsenal almost matching that of the mighty *K't'inga*.

To put it bluntly, *Qu'Hegh* packs battlecruiser firepower on a light cruiser hull. That is both its strength and its weakness. It can be a powerful opponent in a one-on-one fight; however, it can still be dispatched fairly quickly by targeting a series of carefully timed heavy weapons salvos at key points on its superstructure. This will take some doing, though, thanks largely to the beefed-up shield generators that the Klingons thoughtfully installed on the production model. As long as a *Qu'Hegh* can maintain its shields then it is as dangerous an adversary as any Klingon battlecruiser. Once its shields are knocked down, though, and provided its opponent knows its weak spots, then it can be put out of action in short order.

Qu'Hegh was being produced at both Gnuu Re' and H'rez prior to the Praxis explosion of 2293. After that even production shifted entirely to Gnuu Re', as its facilities were shielded by its solar system's own sun from the shockwaves and blast debris. On the other hand, fully three-quarters of the shipbuilding facilities at H'rez were devastated by the Praxis Event, with the loss of almost a hundred hulls of various classes and in

various stages of completion. One of the hardest losses to take was the brand new *Qu'Hegh* class starship *jat'lyn* (tH. "Soul Stealer"). It had just cleared its moorings in a desperate attempt to escape its impending doom. The starship was almost immediately smashed to oblivion before it could go to warp when it was hit by an asteroid three times its size. This asteroid and its many companions, both large and small, then went on to carve a kilometers-wide path of death and destruction through the H'rez shipyards and adjacent orbital complexes.

The name *Qu'Hegh* comes from a form of ritual suicide offered by the Klingons to captured foes that had fought well during the old days of the Empire. A ceremonial silver dagger, the *Qu'Hegh* (tH. "death rite blade") was presented to the captive, who was then granted privacy to commit death by self-disembowelment. The *Qu'Hegh* ritual was considered the most noble way for a captive to die and had an immediate benefit as well. For Klingons and non-Klingons alike those who were taken prisoner along with the captive dying by *Qu'Hegh*, as well as any friends or family already held prisoner or hostage, were set free without restraint or condition of any kind once the *Qu'Hegh* ritual was completed. In most cases they were even returned to their homes or the places from which they were taken prisoner in the first place. This was done to honor the valor of the captive who had been granted death by *Qu'Hegh*. On the other side of the ritual, the granting of *Qu'Hegh* was considered a sacred duty by the leaders of the Imperial Houses. Only the House Lord or Lady that held the captive could grant *Qu'Hegh*, and then only to the noblest of the most noble of the Empire's captives. Each House had its own unique *Qu'Hegh* blade, handed down from one generation to the next. In full-tilt House blood feuds it was standard practice to kill the last surviving member of a House with its own *Qu'Hegh* (if he or she wouldn't or couldn't do the act on their own), after which it was broken and the hilt present to the Klingon High Council. A collection of *Qu'Hegh* hilts from all of the Houses that no longer exists, save one, is on public display in the foyer of the old Imperial Senate building on Q'o'nos. The one that is missing is that of House Riskadh, sires of Kahless the Unforgettable. It was never recovered after his line ended.

Schematics

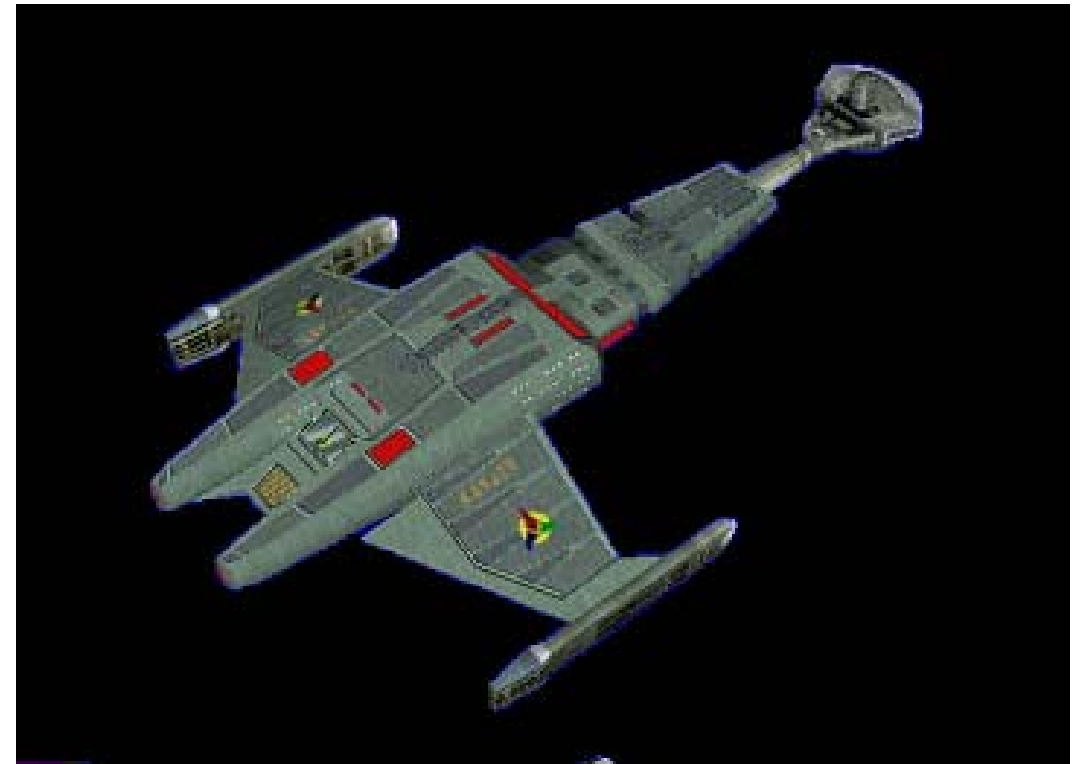
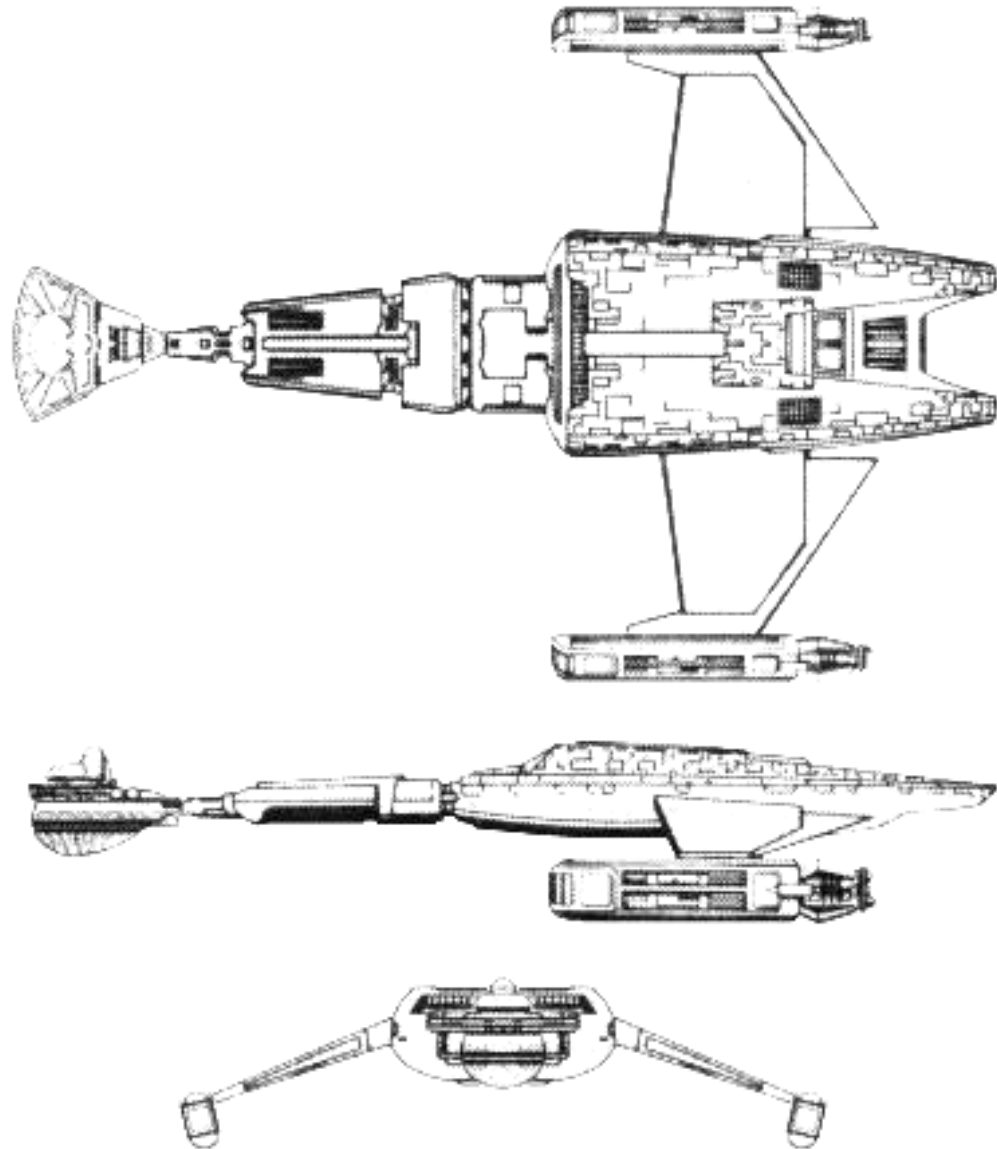

Qu'Heh class Klingon battlecruiser
created by Forrest G. Brown and Dana Knutson
for *STAR TREK – The Role-Playing Game* by FASA Corporation

Additional background material courtesy of Brad Torgerson

Schematic by Dana Knutson

Visuals courtesy of Paul Brown, Tyrel Lohr, and Terradhyne

Qu'Heh as launched (2284)

Hegh daS

***mayDuj* type 9 (*chu'Duj* type 1) (2290)**

Specifications as built

Dimensions

Length: 220 meters
Beam: 145 meters
Height: 36 meters

Mass

Standard gross: 500,000 GMT (estimated)
Subspace displacement: 125,000 DWT (estimated)

Crew complement

Officers: 85
Enlisted: 335
Imperial Guards: up to 250 (in support of assault operations)

Top velocity

Cruising speed: warp 9 (estimated)
Rated maximum speed: warp 12 (estimated)

Endurance

Standard endurance: estimated 3 years at L.Y.V.

Armament (*)

Disruptors: 6 standard disruptors (2 F/P, 2 F/S, 2 A)
Guided weapons: 2 uprated? photon torpedo tubes (1 ea. F/A)
Other: cloaking device

(*) Reflects mix observed by intelligence sources.



Known starships

Hull #	Name of starship	Builder	Status
KRD12-001	<i>Hegh daS (Death Boot)</i>	Mustaka Shipyards	active
KRD12-002	<i>Hegh yov (Kamikaze)</i>	Mustaka Shipyards	lost

Hegh daS (tH. “Death Boot,” i.e. “the kick of death”) was apparently the last major Klingon battlecruiser type to enter the service of the Empire prior to the Praxis Event of 2293. Only one had been commissioned by that time, while a second, nearly complete one was smashed to pieces in its spacedock. According to most intelligence reports *Hegh daS* production is in the process of being transferred to Z’hai and will resume “as early as 2302.” These same reports are also the only source of information on the type, as *Hegh daS* has yet to be encountered by any Federation starship.

With *Hegh daS* the Empire may very well be on the edge of commencing a clean break from the traditional *Drell*-type designs that have served it for generations. In certain ways *Hegh daS* is also a throwback of sorts, hearkening back to the beloved but obsolete *bortaS* and the still-popular but aged *Hla’bah*. The boom-and-wing *Drell* approach has been abandoned for a unibody hull with twin *pljonta’* mounted in *Lara’atan*-like fashion. At the same time a new type of combined deflector grid and ablative armor system appears to have been incorporated into the hull exterior, as well as the use of disruptor mounts unlike any seen in service before. New Klingon-style phototorp systems appear to be unique to the class – somewhat larger than standard tubes but nowhere near as large as current heavy phototorp systems. Even the traditional “bridge bulb” is gone, a move that was no doubt dictated by the new unibody hull. To sum it up, just about everything concerning the exterior of *Hegh daS* is different from any contemporary Klingon battlecruiser currently serving the Empire. Differences concerning its interior remain to be seen as additional intelligence becomes available. How it will fare against comparable vessels of other powers remains to be seen.

No heavy disruptors appear to be mounted to the engines of *Hegh daS*. This would be something of a first for a modern Klingon battlecruiser design. It has been suggested that the power of its new photon torpedo system may be such that the Empire believes retaining heavy disruptors would be both needless and redundant.

It should be noted that some current civilian publications list *Hegh daS* as a *Kh’exrillin* class type 12 *dakasta*. This comes from an older heavy destroyer design proposal of the same name. It was rejected by Chancellor Lotar during the early 2270s as underarmed and underpowered. That slot was eventually allocated to *K’teremny*. There is evidence to indicate that *Hegh daS* might be a cruiser-sized revamping of the earlier concept.

Schematics

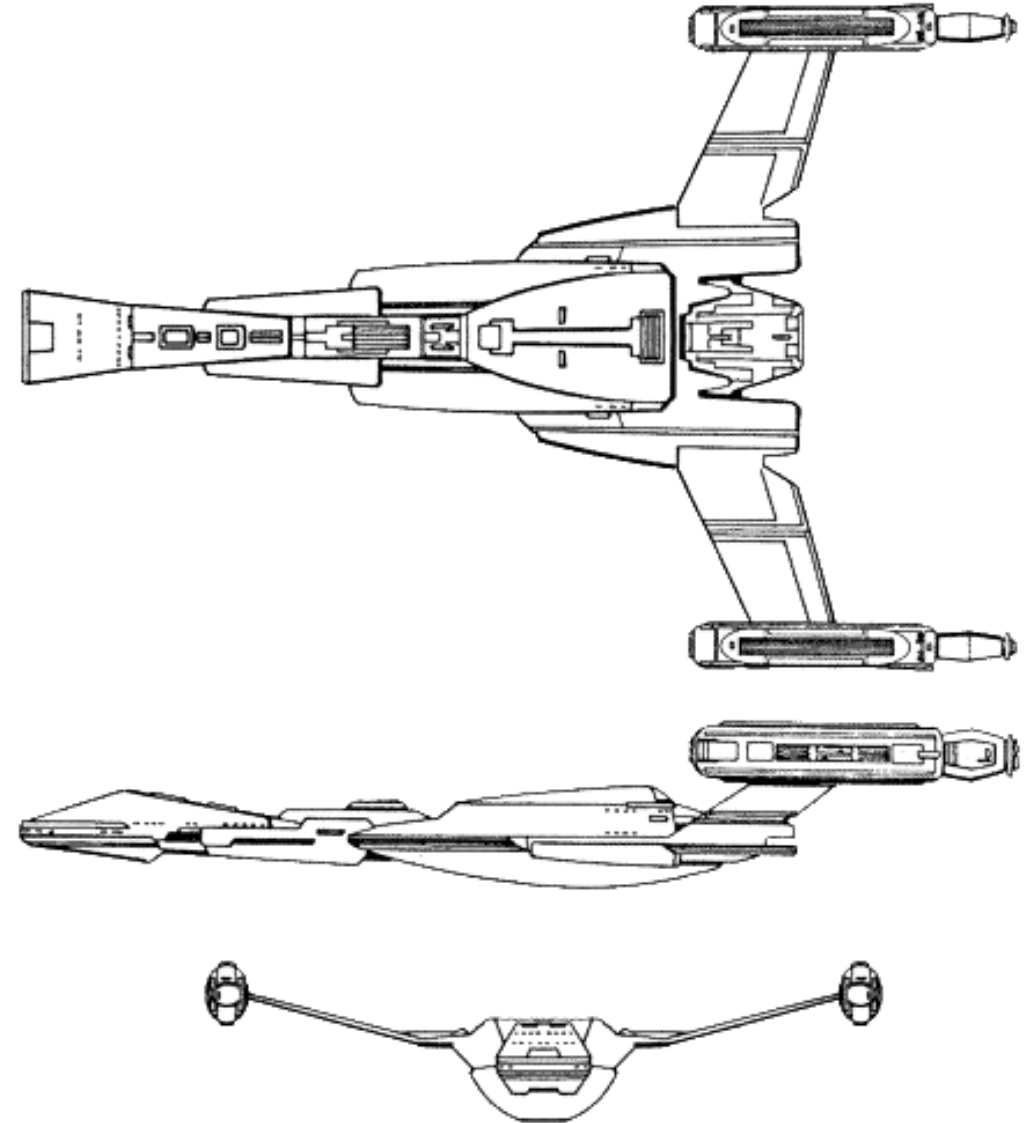

Starfleet Intelligence schematic made of the D-12 *Kh’exrillin*. This is the abandoned destroyer design on which *Hegh daS* is based. Note how the overall lines are the same. Most of the changes appear to be Taldren generation influences. These have apparently made for a vessel more acceptable to the Klingon High Command.



Hegh daS (Kh'exrilin) class Klingon battlecruiser created by John Spencer
as originally published in FASA's "Jaynz' Ships of the Galaxy"
(*STARDATE* magazine)

tHIngan hol class name and TNG-inspired reworking by Korah

Additional background material courtesy of Brad Torgerson and Battleclinic.com

Kh'exrilin schematic by John Spencer

Hegh daS visuals courtesy of Korah



Other Cruisers

kamalva (Kl. “Powerful Starship”) and
qughDuj (tH. “Cruiser”) series

bortaS

***qughDuj* type 1 (*kamalva* type 2) [2136?]**

Specifications as built

Dimensions

Length: 143.7 meters
Beam: 114.1 meters
Height: 32.3 meters

Mass

Standard gross: 327,250 GMT
Subspace displacement: 83,000 DWT

Crew complement

Officers: 20
Enlisted: 255
Imperial Guards: up to 20 (in support of assault operations)

Top velocity

Cruising speed: warp 5.0
Rated maximum speed: warp 6.0

Endurance

Standard endurance: estimated 2 years at L.Y.V.

Armament

Disruptors: 4 standard disruptors (2 F, 1 ea. P/S)
2 heavy disruptors (1 ea. F/A)
Guided weapons: 1 photon torpedo tube (F)



Known starships

Hull #	Name of starship	Builder	Status
KRK02-001	<i>bortaS (Revenge)</i>	Chenwl Duj' Shipyards	scrapped

bortaS was one of the first Klingon starships ever encountered by humanity during its interstellar expansion in the mid-22nd century. At that time, as has since been learned, it had only been in service with the Klingon Empire for just four years. It was the Empire's original light cruiser and remained in that role until the 2250, when it was replaced by *Hak'hyl*. After that, all hulls in Imperial service were either sold off to the Lesser Houses or systematically rotated to secondary roles over the following two decades until all had been replaced as ships of the line by newer designs.

The design is basically a retooled *Hla'bah* upsized to a cruiser class starship. It is believed that *bortaS* was originally conceived as a competitor to *D'ama* in the role of fleet battlecruiser. When *D'ama* proved the superior design in space trials, *bortaS* and its offspring were relegated to the light cruiser role. Some *bortaS* hulls even suffered the indignity of being converted to deuterium tankers, stripped of most weaponry and complete with external slush tanks, in the service of the Empire. The first such conversion was observed by the Vulcans in 2149.

This design is listed as the D-5 type Klingon cruiser in many Terran and Federation reference works of the period. It should not be confused with the later D-5 *Hak'hyl* or K-5 *Dupat* classes. Both of the latter are *Drell* derivatives. *BortaS* has its own unique design lineage that it shares with the *Hla'bah* class scout. The earlier D-5 designation is believed to have arisen from a translation error on the part of early Terran Starfleet intelligence analysts.

By 2270 *bortaS* was considered obsolete even by its staunchest advocates. This was because of its design, which was not compatible with the Empire's extensive fleet modernization programs of the 2270s and 2280s. In 2280 the Klingon High Council declared it officially obsolete. As a result all 30 remaining hulls in Imperial service were retired or sold off by 2290. The last confirmed sighting of a *bortaS* was in 2292.

It is believed that at least 14 starships of the *bortaS* class still continue in service with the Lesser Houses, in particular those that are unable to afford more modern designs.



***bortaS* class Klingon cruiser created by John Eaves and Robert Bonchune as depicted on screen in the *STAR TREK – Enterprise* episodes “Judgement,” “Once More Into The Breach,” and “Marauders”**

Additional background material courtesy of Graham Kennedy, Memory Alpha, and Ex Astris Scientia

Visuals courtesy of CBS Paramount

qa'HoS

***qughDuj* type 2 (kamalva type 4) [2218]**

Specifications as built

Dimensions

Length: 198 meters
Beam: 105 meters
Height: 73 meters

Mass

Standard gross: 461,250 GMT
Subspace displacement: 115,000 DWT

Crew complement

Officers: 77
Enlisted: 173
Imperial Guards: Up to 30 (in support of assault operations)

Top velocity

Cruising speed: warp 6.1
Rated maximum speed: warp 7.4

Endurance

Standard endurance: estimated 6 years at L.Y.V.

Armament

Disruptors: 10 standard disruptors (4 F, 2 A, 2 ea. P/S)
Guided weapons: 1 photon torpedo tube (F)*
1 drone rack (C/L)

(*) Installed during the 2275 fleetwide refit. Prior to this *qa'HoS* was fitted with a single engine-mounted heavy disruptor per early 23rd century fleet practice. A common House modification adds a second aft-firing photon torpedo tube. This requires the removal and replacement of its impulse engines with smaller and less efficient models, significantly reducing *qa'HoS*' sublight acceleration and maneuverability.



Known starships

Hull #	Name of starship	Builder	Status
KRQ04-001	<i>qa'HoS (Relentless)</i>	Taamar Shipyards	active
KRQ04-012	<i>vaQl' (Aggressor)</i>	Taamar Shipyards	active
KRQ04-029	<i>Qobtaj (Dagger of Death)</i>	Taamar Shipyards	active
KRQ04-035	<i>tlhIv (Insurrection)</i>	Taamar Shipyards	lost
KRQ04-072	<i>qorl' (Scavenger)</i>	Taamar Shipyards	lost
KRQ04-093	<i>Sangl' (Obliterator)</i>	Taamar Shipyards	active

qa'HoS has been one of the most popular second-tier workhorse cruisers of the Imperial fleet ever since its introduction in 2218. The exploits and fame of its more famous battlecruiser brethren long ago eclipsed it; however, it is a tried and true (if rather unremarkable) Klingon starship design. It was also the first true multi-mission starship in Imperial service. Because of this, it has remained in service long after many of its more storied contemporaries were retired. It is a nostalgic favorite of older Klingon warriors and many a Dahar Master can be found serving the Empire as the commander of a *qa'HoS*. Their hulls may be old, but they are still potent warships when commanded by such experienced warriors.

These were originally launched as “economy” battlecruisers, designed to provide a buffer for the Empire’s interior systems while the battlecruisers went to the borders to challenge the newly discovered Federation. At that time they were produced at the same rate as *Drell* type battlecruisers. Production appears to have ceased around the same time that the *Hak'hyl* entered service. Even so, the sheer number of *qa'HoS* hulls built guarantee they will continue to serve the Empire for decades to come.

qa'HoS has a reputation for reliability and survivability that is well deserved, given its 80+ years in Imperial service. Stories abound of *qa'HoS* captians bringing their wrecked ships back into port after tangling with pirates or unexpected battles with enemy combatants, trailing vented plasma plumes kilometers long and with hull breaches and and shattered frame braces that would have doomed almost any other Imperial design to a quick and merciless death. This is because it was one of the first Klingon starship designs to employ a form of compartmentalized design and system redundancy. This was named *brak'lul* (tH. “vital organ redundancy”) after the Klingon’s own physiology, which is known for its reinforced skeletal structure and duplicate vital organs. Given this record for survivability it is odd that *brak'lul* was not employed more extensively in other Imperial designs, but such appears to have been the case. It would not be until the introduction of the *K't'orr* class destroyer almost 60 years later that another Klingon starship would enter service with a *brak'lul* capacity like that of *qa'HoS*. It is still a rare event to see a *qa'HoS* in dock undergoing repairs or refits of any kind save those ordered by the Klingon High Command. Most *qa'HoS* commanders shrug off whatever minor damage received while on patrol, repairing it in the field at their leisure.

These days the surviving members of the *qa'HoS* class can be found on border patrol duties, supplementing the ranks of their battlecruiser brethren. Their original mission of protecting the inner systems of the Empire has been taken over by newer designs. The majority of them operate in the Triangle against Romulan forces. The second largest group can be found operating along the Federation Treaty Zone as part of many local Zone

Patrol Fleets. These are usually comprised of one battlecruiser (*K't'inga* or *Riskadh* series), one or two lesser cruisers (*qa'HoS*, *Hak'hyl*, or *Raxor/Klolode*), and up to three smaller vessels (most commonly *B'rels*).

In 2275 a fleetwide refit program was enacted to bring the aged *qa'HoS* into the modern starship era. These include an upgraded warp engine, enhanced armor/deflector plating, and a Klingon-style cloaking device. This will probably be the last such refit *qa'HoS* will ever receive. Only a handful of its contemporary classes at the time of its building remain in Imperial service and their numbers continue to shrink with each passing year. The High Council was considering decommissioning the class as a whole and replacing them with new-build designs prior to the Praxis explosion of 2293. The latter event has forced the aged *qa'HoS* to soldier on as is, with no replacement in sight for at least another decade.

qa'HoS, the lead ship of its class, was launched from the prestigious Taamar Shipyards in early 2218. It is the oldest second-tier cruiser still in Imperial service at the time this document was published.

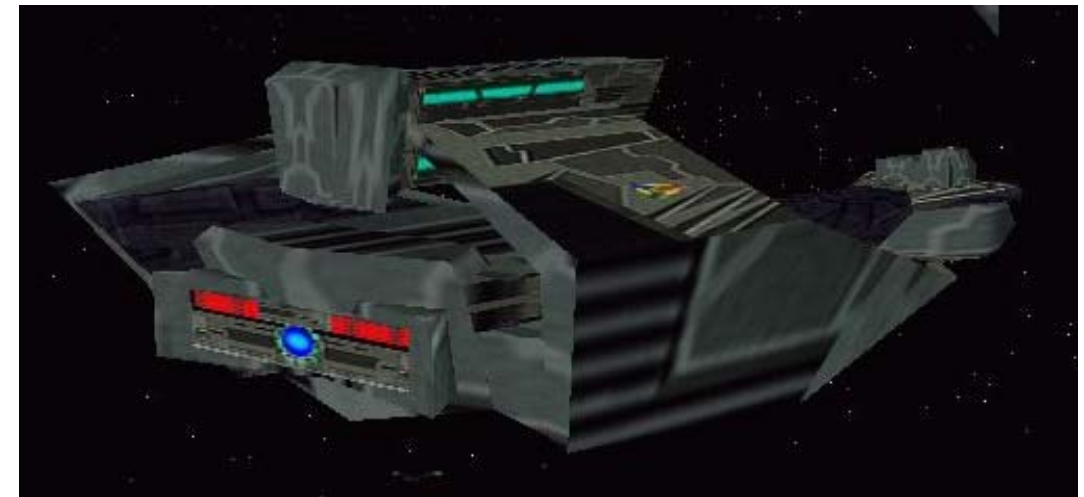

***qa'HoS* class Klingon light cruiser created by Taldren (Activision Games) for the *Klingon Academy* and *Starfleet Command* series of licensed videogames**

Additional background material courtesy of Activision Games and the *Klingon Academy* Forums

Visuals courtesy of Taldren

Dupat

qughDuj type 3 (*kamalva* type 5) [2230]

Specifications as built

Dimensions

Length:	184.5 meters
Beam:	134.7 meters
Height:	55.3 meters

Mass

Standard:	371,300 GMT
Subspace displacement:	94,000 DWT

Crew complement

Officers:	75
Enlisted:	185
Imperial Guards:	up to 59 (in support of assault operations)

Top velocity

Cruising speed:	warp 4.0
Rated maximum speed:	warp 6.0
Rated emergency speed:	warp 7.0

Endurance

Standard endurance:	estimated 2 years at L.Y.V.
---------------------	-----------------------------

Armament (*)

Disruptors:	6 standard disruptors 2 heavy disruptors
-------------	---

(*) Configuration as built. Most existing models have either been upgraded or heavily customized. The most common weapons configuration encountered at present is 6 standard disruptors (2 F, 2 ea P/S) and 2 heavy disruptors (1 ea P/S). A common variant trades the heavy disruptors for photo torpedoes (1 ea F/A). Drones are also popular.



Known starships in Klingon service

Hull #	Name of starship	Builder	Status
KRK05-001	<i>Dupat (Reversal of Fortune)</i>	Gnuu Re' Shipyards	sold
KRK05-003	<i>Serpant (Mirror)</i>	Gnuu Re' Shipyards	sold
KRK05-014	<i>Malvista (Starsword)</i>	Gnuu Re' Shipyards	sold

Dupat's combat performance has often been compared with that of the Federation's *Kearsarge* or *Larson* starship classes. In armaments and available power it is a close match for *Kearsarge*, but its *Drell* hull dynamics give it maneuverability approaching that of *Larson*. In past combat encounters Klingons often employed *Dupats* as wing cruisers for "wolf pack" battlecruiser squadrons or in the destroyer leader role for destroyer squadrons. It has one major difference from the contemporary *Hak'hyl*, and that is cruising range. Weapons and protective systems have been sacrificed for spaces necessary for the systems and storage for long-term missions. This also made *Dupat* ideal as a picket cruiser, and as such it was often found deployed along the Empire's borders during its time in Imperial service. This added capability also found it employed as a "diplomatic" vessel on those rare occasions when the Empire chose to talk rather than fight.

The *IKV Serpant*, a brand new *Dupat* class cruiser commanded by Captain Krenn, was the first-ever Klingon vessel to be allowed to enter Federation space in 2231. It is believed that the Klingon High Council permitted this, knowing the Federation would extensively probe and scan it, because it already had a more powerful battlecruiser in the works (*Raxor*).

There are two major visual differences between *Dupat* and *Hak'hyl*. The first is its command boom, which is identical to that of the *Morast* fleet transport/tug. This is an excellent example of Klingon thriftiness at work, as the more sophisticated *Raxor* boom was unnecessary for *Dupat's* intended function. The second is in its *pijonta'*, which are the same as those on *Raxor*. On paper this made *Dupat* more capable than *Hak'hyl*, with the extra power and extended range which *Hak'hyl* lacked. In practice this difference was insignificant, as *Dupat* was never designed nor intended for the type of high-profile combat missions on which *Hak'hyl* was usually deployed.

Practically all of the *Dupats* still in existence have been modified to one degree or another by their current owners. Some have been completely rebuilt according to modern standards, while some have received only marginal upgrades.

Common upgrades include the installation of modern and more powerful *pijonta'*, additional standard disruptor banks, and replacing the old heavy disruptors with photon weaponry. Installation of multiple drone racks represents a cheap but effective weapons upgrade and is quite common in *Dupats* operated by the Triangle powers. Several under the ownership of allied Klingon powers or vassal states have received the

equivalent of a *K't'kara* or *K't'inga* level overhaul, making them practically equal to the modernized Imperial *Hak'hyl* in terms of combat capability.

To detail each and every variant would be beyond the scope of this work. Instead, readers are directed to the definitive work on the subject: *The Klingon K-5 Star Cruiser* by Devold Bringham (Starport City, Proxima Centauri, 2288).

At one time *Dupat* was the centerpiece of the Imperial *tokhesa kasse'ha* (Kl. "deliberate giveaway," i.e. "export program") of the mid-23rd century. One out of every five former Imperial starships sold or awarded to client powers was a *Dupat*. Those who couldn't afford a *Raxor* for their local fleets would often settle for a *Dupat*, as its hull held the promise of later upgrading to near-*Raxor* specifications. It is for this reason that *Dupat* is still frequently encountered both in and around the Triangle as well as Klingon allies near the Treaty Zone. Many of these have been upgraded to *Raxor* or even modernized *Hak'hyl* specifications by their current owners.

A total of 63 *Dupats* are believed to have been built between 2230 and 2250. 27 of these still exist in the fleets of allied Klingon powers, and at least 18 have been spotted operating with the fleets of various Triangle powers. The Star Fleet Adversary Squadron has 2 rebuilt *Dupats*, while the Orion pirate cartels are known to have at least 3. It is reported that the WYN Consortium may also have a *Dupat*, but this has never been confirmed.

Schematics

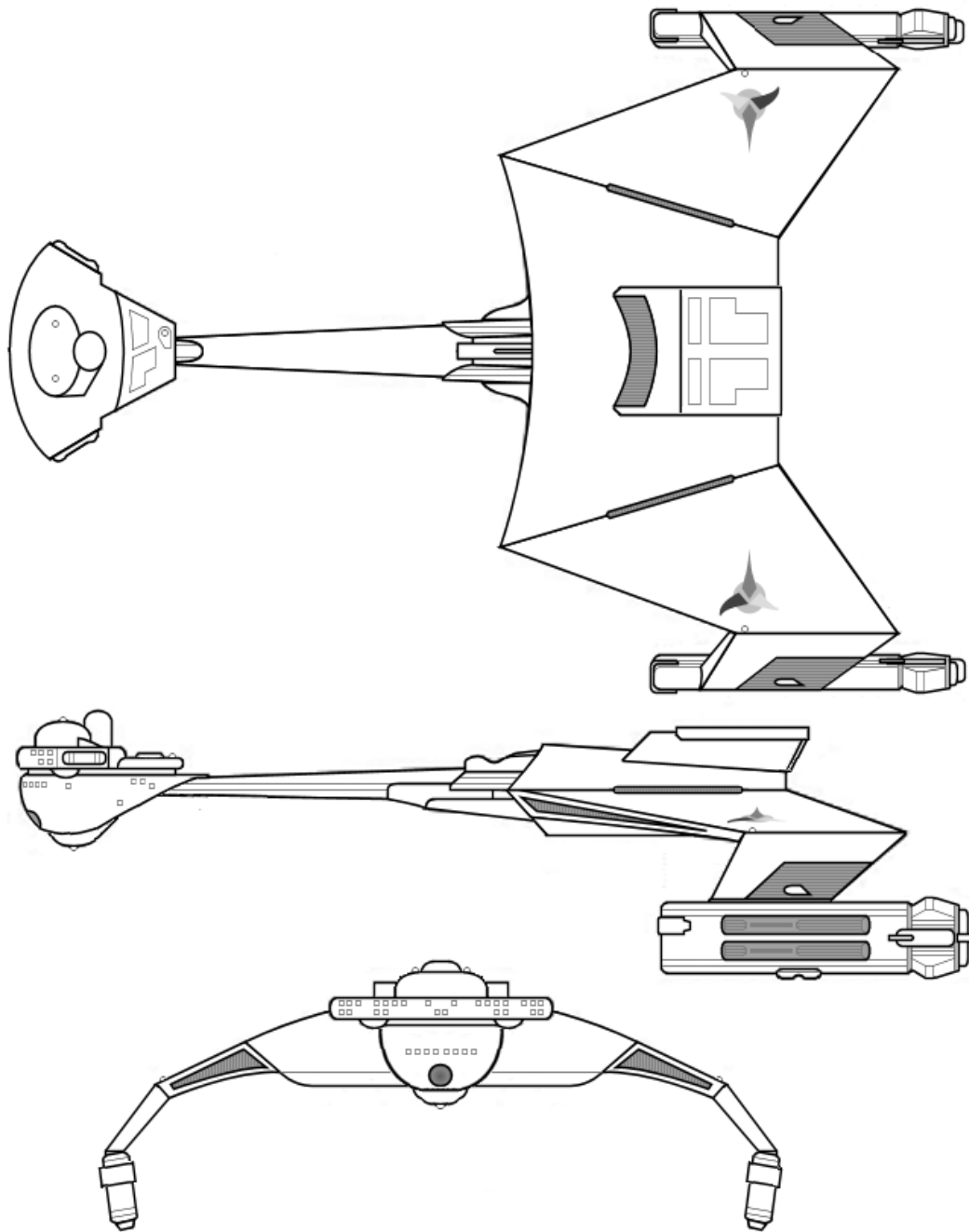

IKV Serpant on approach to Earth (2231)

***Dupat* class Klingon cruiser created by Patrick Flannery as first published in Geoffery Mandel's *Star Fleet Handbook #13* fanzine with additional modifications and developments by Eric "Jackill" Kristiansen**

Additional background material courtesy of Richard Mandel, John Ford, Eric Kristiansen, and Atrahasis

Schematic by Richard E. Mandel and Neale Davidson

Visuals courtesy of Atrahasis



Assault Ships

thala (Kl. “Assailant”) and
neghDuj (tH. “Assault Ship”) series

D'aka

***neghDuj* type 1 [*thala* type 3] (2247)**

Specifications as built

Dimensions

Length: 250 meters
Beam: 150 meters
Height: 50 meters

Mass

Standard gross: 295,000 GMT
Subspace displacement: 73,800 DWT

Crew complement

Officers: 10
Enlisted: 52
Imperial Guards: up to 800 (in support of assault operations)

Top velocity

Cruising speed: warp 6.0
Rated maximum speed: warp 7.2

Endurance

Standard endurance: estimated 2 years at L.Y.V.

Armament

Disruptors: 8 standard disruptors (2 F, 2 A, 2 ea P/S)
Guided weapons: none
Other: 4 ground assault shuttles

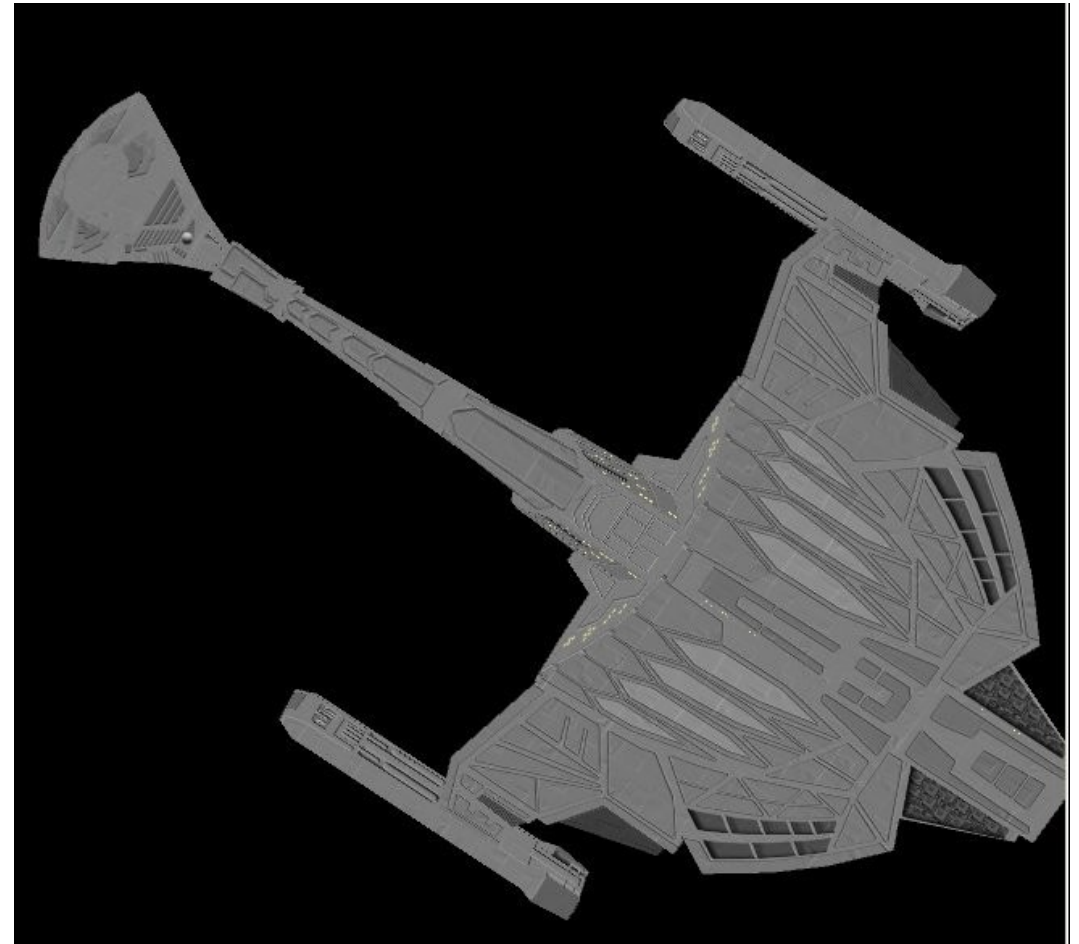

Known starships

Hull #	Name of starship	Builder	Status
KRT03-001	<i>D'aka (Mover)</i>	Mustaka Shipyards	active
KRT03-029	<i>Besz'tih (Battle Transport)</i>	Mustaka Shipyards	active

D'aka was developed in response to the need to transport large groups of Imperial Guards to planets needing occupation or "pacification" and then getting both them and their gear to the surface as quickly as possible. It can carry eight companies of Imperial guards in cryosleep along with 50,000 tons of cargo, usually ground assault vehicles and a full range of support gear -- such as munitions, spare hand weapon energy packs, field rations. Facilitating this capability are six combat transporters (22-man capacity) and six cargo transporters. With these resources the crew of a *D'aka* can transport its full load of Imperial Guards along with their supplies and equipment down to the surface within 15-20 minutes.

Normally such an insertion is done from low orbit; however, there are several accounts of a *D'aka* "dropping to the deck" for such operations in order to avoid being destroyed by orbital weaponry. At least one *D'aka*, the *Besz'tih* (Kl. "Battle Transport", lit. "the ship that moves troops into battle") survived the attempt to regain orbit, being fortunate enough to take part in an assault on a low gravity planet. All of the others that attempted the same on other worlds were destroyed in the process, not being designed for such a maneuver, but not before successfully offloading their troops and supplies before their subsequent destruction.

D'aka is little more than a *Klolode* with a "stretched" secondary hull, larger and even more elongated than the contemporary *Z'gal* research cruiser (with which it shares many design similarities). This provides the room for the extra cargo holds and troop barracks needed for full support of planetary assault operations.

Tactically speaking, *D'aka* is a sitting duck. Its assault ship nature plus its lack of heavy weaponry precludes it from being an effective starship combatant. Its armaments were intended to ward off attacks from small craft that might have penetrated fleet defensive perimeters, not enemy starships in long battles. It has limited maneuverability when fully laden, thus making it even more of a target. Once it has disgorged its troops and their supplies, though, it can perform almost as well as any other *Drell*-derived design. This feature more often than not allows it to escape potential ambushes by enemy starships during planetary assault operations.

There are no known variants of *D'aka*, not even among House models.

D'aka is no longer in production. During its heyday *D'aka* was manufactured at the Fonawl, Iosia, and Mustaka shipyards. A total of 41 were built, of which 11 were destroyed or lost. 27 remain in Imperial service, 2 have been recently placed in reserve, 5 have been scrapped, 2 are in the service of the Greater Houses, and 5 are in the service of the Lesser Houses.

Schematics

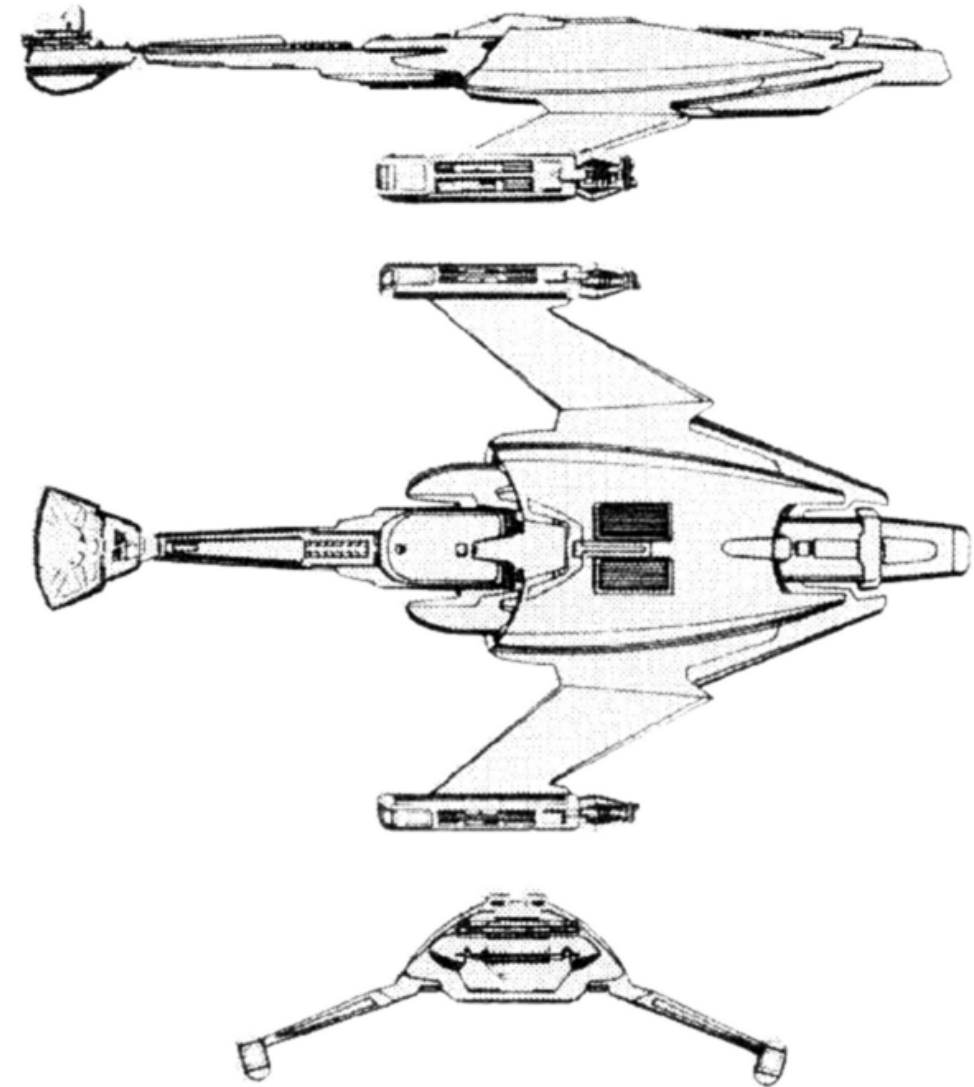

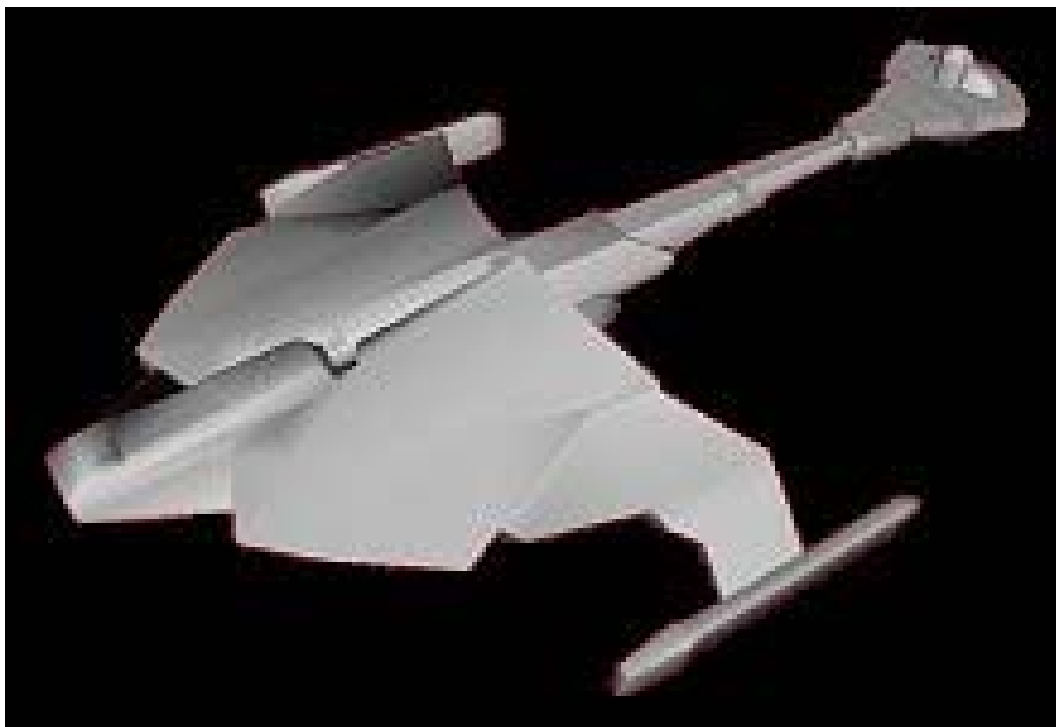

A typical Klingon boarding party operation in progress aboard an unidentified Federation vessel, which appears to be in the process of being captured.

***D'aka* class Klingon assault ship
created by Forrest G. Brown and Dana Knutson
for *STAR TREK – The Role-Playing Game* by FASA Corporation**

Additional background material courtesy of Brad Torgerson

Visuals courtesy of Klingon Fanatic

Schematics by Dana Knutson



A view from inside the helmet of an Imperial guard after a “pacification” exercise.

Mas to gal

***neghDuj* type 2 (*thala* type 5) [2261]**

Specifications as built

Dimensions

Length: 270 meters
Beam: 165 meters
Height: 60 meters

Mass

Standard gross: 353,000 GMT
Subspace displacement: 88,000 DWT

Crew complement

Officers: 10
Enlisted: 64
Imperial Guards: up to 1400 (in support of assault operations)

Top velocity

Cruising speed: warp 6
Rated maximum speed: warp 8

Endurance

Standard endurance: estimated 2 years at L.Y.V.

Armament

Disruptors: 6 standard disruptors (2 F, 2 A, 1 ea P/S)
Guided weapons: none
Other: 14 attack shuttles (8 fighter + 6 assault)
cloaking device



Known starships

Hull #	Name of starship	Builder	Status
KRT05-001	<i>Mas to gal (Throne Seeker)</i>	Mustaka Shipyards	active
KRT05-007	<i>Kaz'y'uth (Searing Spike)</i>	Fonawl Shipyards	active

Mas to gal is more lightly armed than its predecessor *D'aka* but makes up for it in terms of planetary assault support. The elimination of two disruptor banks (one each port and starboard) plus a dramatic bulging of the secondary hull gives *Mas to gal* almost twice the troop capability and almost double the shuttlecraft capacity of *D'aka*. The extra troop capacity means that *Mas to gal* is better able to occupy or "pacify" any planet that has been brought to the attention of the Klingon High Command. Thanks to additional combat and cargo transporters it can put all 1400 of its troops planetside, plus ground vehicles and supplies, in as little as 10 minutes. *Mas to gal's* enlarged shuttlecraft hangar is commonly used for fighter and assault shuttles in support of ground operations. This was a lesson learned from *D'aka* and those occasions in which one had to descend into a planetary atmosphere to provide covering fire for the troops it had just landed. In all but one of those occasions the *D'aka* involved could not reach orbit and crashed. Adding attack shuttle capacity equivalent to that of a small fleet carrier relieves *Mas to gal* of this possibility and allows it to better defend itself against possible attack.

The rate at which *Mas to gal* can insert its troops onto a planetary surface is nothing short of phenomenal. Assuming no interference (i.e. the ship doesn't come under attack), a *Mas to gal* can beam down 292 Imperial Guards, 8 light ground support vehicles, and 2 heavy ground assault vehicles every 2 minutes. Within 10 minutes it can disgorge all 1400 of its Imperial Guards, 32 light ground support vehicles, and 8 heavy ground assault vehicles. By that time all 14 of its small attack craft will have successfully penetrated planetary atmosphere and arrived on-site at the landing zone ready to support ground assault operations.

Mas to gal suffers from the same combat deficiencies as *D'aka*. It is an assault ship, not a battlecruiser, and its on-board weaponry is purely defensive. The biggest challenge when finding a *Mas to gal* in planetary orbit is not to just simply destroy it, but to find and destroy it *before* it can complete planetary assault operations. This is made all the harder by the fact that *Mas to gal* comes complete with cloaking device. This design change alone increased its combat survivability rate by 43% over that of the older *D'aka*.

The name *Mas to gal* (Kl. "Throne Seeker") is commonly confused with *Mastocal*. *Mastocal* is a Standardized form of the Klingonaase *Mas to kal* (Kl. "Searcher of the Night"), which is the name of the largest Imperial naval base closest to the Treaty Zone. The one-phoneme difference in the words has confused many a Federation civilian (and new Starfleet officer) over the years.

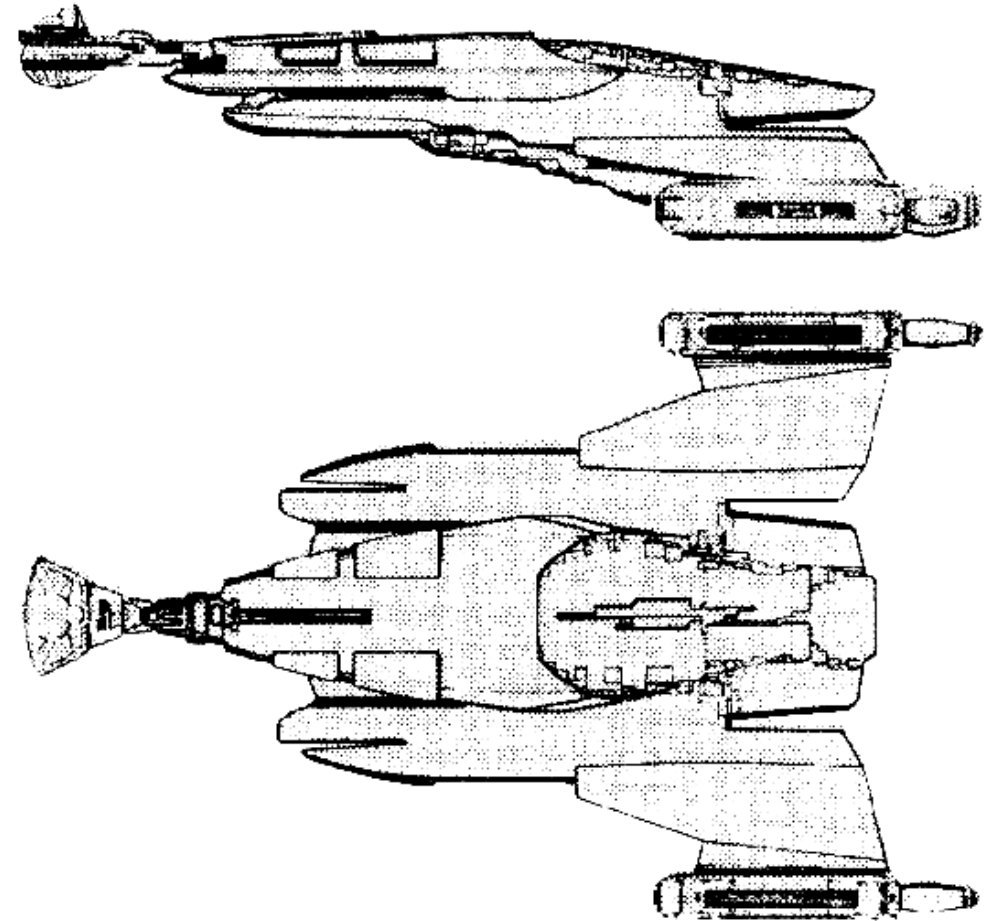

Mas to gal class Klingon assault ship
created by Forrest G. Brown and Dana Knutson
for *STAR TREK – The Role-Playing Game* by FASA Corporation

Additional background material courtesy of Brad Torgerson

Schematics courtesy of Dana Knutson

Na ra`den

***neghDuj* type 5 [*thala* type 12] [2270]**

Specifications as built

Dimensions

Length: 300 meters
Beam: 170 meters
Height: 65 meters

Mass

Standard gross: 499,750 GMT
Subspace displacement: 126,200 DWT

Crew complement

Officers: 10
Enlisted: 64
Imperial Guards: up to 1400 (in support of assault operations)

Top velocity

Cruising speed: warp 6
Rated maximum speed: warp 8

Endurance

Standard endurance: estimated 2 years at L.Y.V.

Armament

Disruptors: 6 standard disruptors (2 F, 2 A, 1 ea P/S)
Guided weapons: none
Other: 14 attack shuttles (8 fighter + 6 assault)
cloaking device



Known starships

Hull #	Name of starship	Builder	Status
KRT05-001	<i>Mas to gal (Throne Seeker)</i>	Mustaka Shipyards	active
KRT05-007	<i>Kaz'y'uth (Searing Spike)</i>	Fonawl Shipyards	active

Na ra'den is often called the “dreadnought” of Klingon assault ships, comparing to its fellows in the same way as a *K'herr* would compare to a *K't'inga*. The reference is not only to its sheer size but also to its planetary assault capabilities, which are the largest and most capable of any Klingon assault ship design.

Na ra'den can transport an impressive 160,000 tons of personnel and combat materials to any destination. This is over three times the capacity of *D'aka*. It also carries 12 attack craft in the form of 2 troop shuttles (for battlefield recon), 4 assault shuttles (fire support), and 6 fighter shuttles (air cover). Its transporter capacity can put its entire contingent of 2400 troops (2 full Imperial Guard battalions plus support personnel) on the ground with full gear, equipment, and vehicles in less than 15 minutes. To make matters worse for potential foes *Na ra'dens* usually operate in squadrons of three for assaults on major planetary targets. This means that within the short span of 15 minutes after orbital insertion, local ground commanders are forced to face a fully armed, armored, and mobile Klingon ground force over 7,000 strong with appropriate air cover incoming. Only the strongest of planetary ground defenses can hold up against such an assault for long.

The largest Klingon planetary assault operation to date took place in 2283 just outside the Treaty Zone. It involved a fleet of 24 assault ships, mostly *Na ra'dens*, along with a screening force of 44 other combat starships (frigates, destroyers, and escorts) in the successful conquest of the planet Mrzicann. Its standing army of 800,000 was caught completely by surprise. This was due entirely to the speed at which the Klingons were able to put a fully equipped army of 50,000 combat-ready Imperial Guards, complete with armor and air cover, on the planet's surface. The planetary government of Mrzicann was forced to surrender with 12 hours after the landing had been completed. Because of this Starfleet now keeps careful track of the current locations of all Klingon assault ships. This is to prevent such an event from happening on Federation soil.

Na ra'den's transporter capabilities are as impressive as *Mas to gal's*. The only real difference is the volume of the troop formations and support equipment being transported. A *Na ra'den*, on the average, can transport its entire complement of two full Imperial Guard battalions (2400 troops and support personnel), 56 ground transports and light assault craft, and 28 heavy ground craft in less than 15 minutes.

As will all Klingon assault ship designs, *Na ra'den's* armaments are intended primarily for defense. It carries an impressive array of eight standard disruptor banks, the same as a light cruiser; however, it lacks any kind of heavy weapons. Furthermore, *Na ra'den's* non-standard hull design limits its maneuverability in close-in combat. “It wallows like a *targ* in *yavyiQ* (tH. “mud”)” is a common Klingon description of *Na ra'den's* agility.

Na ra'den construction was abruptly halted in 2293 as a direct result of the explosion of Praxis. The assault ship spacedocks at all three spaceyards with the contract – Mustaka, Iosia, and Fonawl – were in the outer band of their orbital facilities and as such bore the brunt of the initial Praxis shockwave and subsequent debris strikes. Every single *Na ra'den* hull under construction was either destroyed or damaged beyond repair. Assault ship production has since shifted to the smaller and less expensive *pllogh HeH*.

***Na ra'den* class Klingon assault ship
created by Forrest G. Brown and Dana Knutson
for STAR TREK – The Role-Playing Game by FASA Corporation**

Additional background material courtesy of Brad Torgerson

Visual by Major Racial

pllogh HeH

***neghDuj* type 6 (*thala* type 8) (2283)**

Specifications as built

Dimensions

Length: 145 meters
Beam: 132 meters
Height: 42 meters

Mass

Standard gross: 307,500 GMT
Subspace displacement: 75,000 DWT

Crew complement

Officers: 23
Enlisted: 152
Imperial Guards: up to 1400 (in support of assault operations)

Top velocity

Cruising speed: warp 6
Rated maximum speed: warp 7

Endurance

Standard endurance: estimated 2 years at L.Y.V.

Armament

Disruptors: 2 standard disruptors (1 F/P/S, 1 A/P/S)
1 heavy disruptor (F)
Guided weapons: none
Other: 2 drone racks (1 under each assault pod)
22 attack shuttles
(10 troop + 6 fighter + 6 assault)
cloaking device

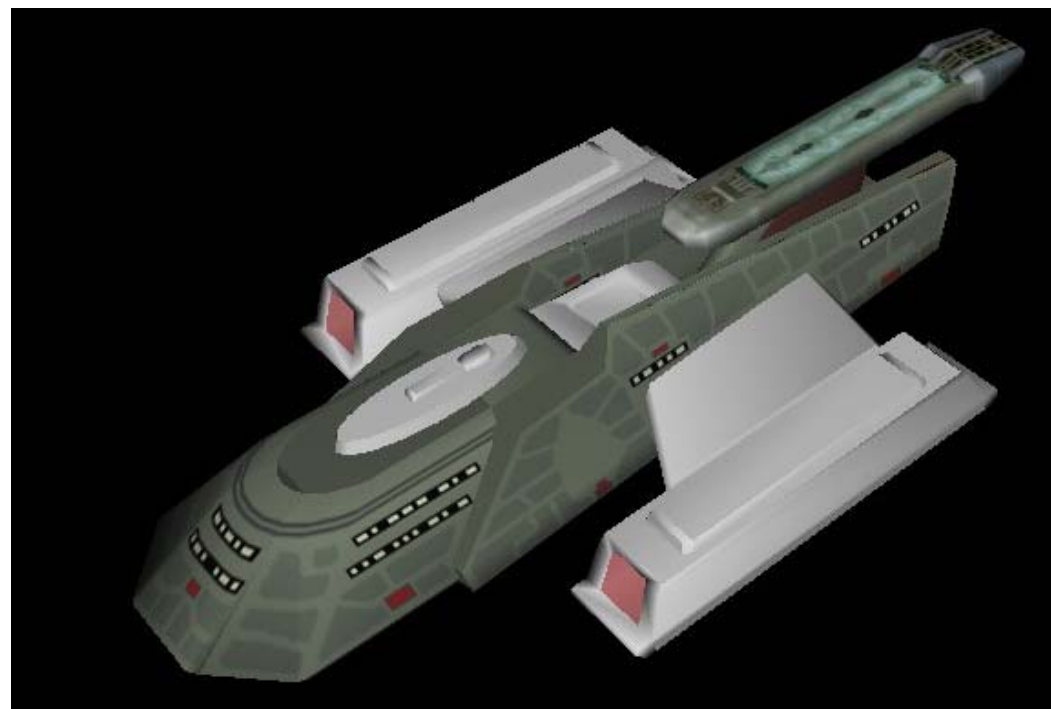

Known starships

Hull #	Name of starship	Builder	Status
KRT08-001	<i>pllogh Heh</i> (<i>Frontier</i>)	Fonawl Shipyards	active

pllogh HeH, like many other revolutionary Klingon starship designs of the 2270s and 2280s, was the brainchild of master starship designer Hogh Balth. It was the next project on his table after completing the design for *qeylls betleH*, the Empire's premier battleship class. It is smaller than its predecessors; however, most Klingon starships experts tend to agree that *pllogh HeH* is the best Klingon assault ship design to date.

Balth based his design on *Estahai*, an old *thala* type 8 assault ship design that had been submitted not long after *Mas to gal* had formally entered service. What intrigued him the most about it were its wing-mounted "assault pods," which reminded him of his own Balth-type modular hull designs. They were there to give the smaller *Estahai* even greater small craft capability than *Mas to gal* – almost the same as that of a Imperial shuttlecarrier. The design had originally been rejected because it was underpowered; however, Balth was able to overcome that with the latest in Klingon warp engine technology plus a few tweaks of his own, such as internal auxiliary power reactors. The hull had to be lengthened to accommodate the design changes; otherwise the basic *Estahai* configuration was left unchanged. This time around the design had the backing of the best starship designer in the Klingon Empire. Small then that it was approved for construction, with the first vessel (*pllogh Heh*) entering service in 2283.

The biggest difference between *pllogh HeH* and its predecessors, aside from the twin assault pods, is in its armament. It was the first Klingon assault ship to sport a heavy disruptor system. While not quite as powerful as photon torpedoes, heavy disruptors are capable of almost the same punch (albeit at shorter range). Heavy disruptors are also capable of penetrating class M planetary atmospheres while maintaining 93% cohesion, thus giving *pllogh HeH* a more effective means of supporting planetary assault operations than standard disruptors alone.

As mentioned earlier, the twin assault pods, one on each side of the ship, give *pllogh HeH* almost the same shuttlecraft capacity as an Imperial fleet shuttlecarrier. The standard mix is usually 10 troop transport shuttles and 6 each fighter and assault shuttles, although this has been known to vary given the tastes of individual commanders. Another first for a Klingon assault ship is the design of *pllogh HeH's* assault pods. *pllogh HeH* was the first Klingon capital ship to utilize a through-deck design for its shuttlecraft hangars as opposed to traditional enclosed designs. Most experts believe this was copied from contemporary Federation shuttlecarrier designs. This gives *pllogh HeH* the unusual capability of both landing and launching its small craft at the same time, something no other Klingon assault ship design can do. The success of Hogh Balth's modified assault pod design quickly proved itself and was later imitated by the through-

deck, clamp-on "shuttle pods" that have quickly become available for standard *Drell*-based designs.

pllogh HeH was the first Klingon assault ship to sport a 50-man transporter for combat operations. This gave it the capability of transporting its entire contingent of 800 troops down to a planetary surface in less than 6 minutes. The one drawback is that the power drain on the ship during landing operations is enormous, and in early evaluations *pllogh HeH* was left without sufficient power for weapons or shields. Hogh Balth rectified this by fitting a dreadnought-class *pljonta'* to the ship. In addition, a couple of drone racks were subsequently added to the design. These are mounted under the assault pods, one under each pod, and provide defensive capability independent of the ship's main power systems. It is reported, however, that the Klingons continue to experience problems with the original design's unique 50-man combat transporter and have reverted to proven 22-man models in newer *pllogh HeHs*.

The angular, non-standard hull design of *pllogh HeH* allows it to transport up to 100,000 tons of cargo to any destination. This is the largest capacity for any Klingon assault ship design save *Na ra'den* and is quite surprising given its size.

A total of 56 hulls are believed to have been authorized for this class. Fonawl is listed the primary contractor. Mustaka, another Klingon shipyard long associated with assault ship construction, is providing support in the way of prefabricated components, such as the *pljonta'* assembly and the wing assault pods. Construction was temporarily by the Praxis explosion of 2293 but has since resumed at a reduced rate.

The Klingon name for this class, *pllogh HeH* (tH. "Frontier") literally means "the edge of Klingon space." It is an approximate translation of *Estahai* (Kl. "the place where planets stop"), the original Klingonaase name for the design. *pllogh Heh* is more commonly known as the *Frontier* class in Starfleet Intelligence threat assessments

Schematics

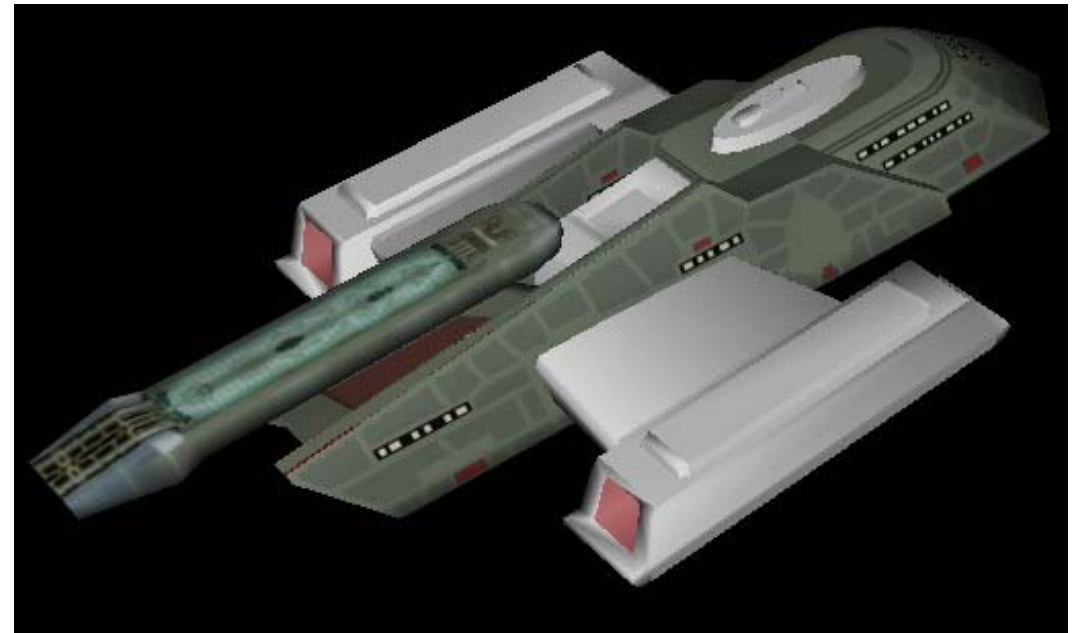
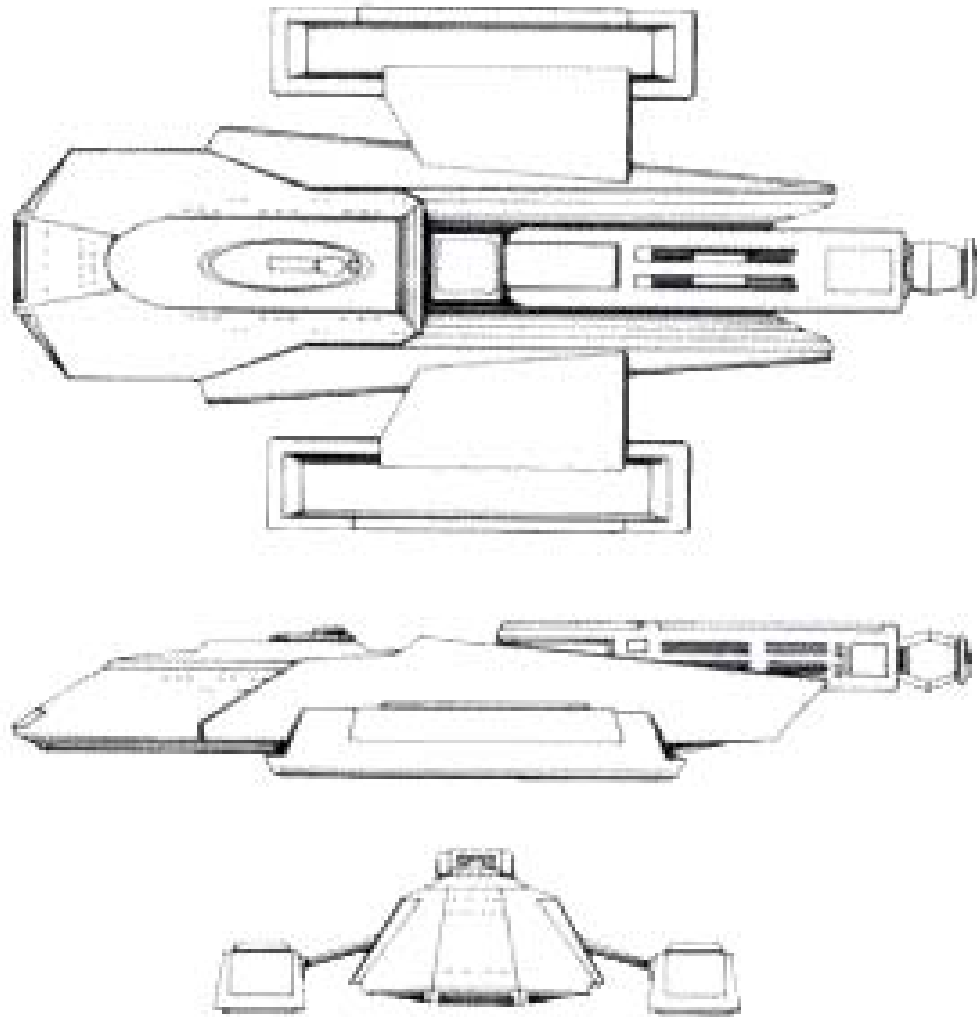

pllogh HeH (aka "Frontier") class Klingon assault ship
created by Forrest G. Brown and Dana Knutson
for *STAR TREK – The Role-Playing Game* by FASA Corporation

Additional background material courtesy of
Brad Torgerson and Bernard Guignard

Visuals courtesy of Terradyhne

pllogh Heh as launched (2283)



Destroyers

dakasta (Kl. “Swift One”) and
QawDuj (tH. “Destroyer”) series

Destroyers

The Klingons see destroyer class starships in a different light than does the Federation. Traditionally destroyers play the patrol or fleet escort roles, yet such is not their place in the Imperial Fleet. In Klingon naval tradition, a destroyer is in effect a heavily armed commerce raider – a large, high-speed attack vessel designed for swift, penetrating attacks. The Klingon series name *dakasta* literally means “Swift One” in Klingonaase. It finds its closest parallel in the old Andorian concept of a fast battlecruiser; i.e., a fighting ship optimized for high-speed attacks against presumably lesser targets. It should come as no surprise, then, to learn that destroyers make up the second largest group of spacefaring combatants in the Klingon Imperial Fleet.

Such was not always the case, though. As recently as the 2260s the Kessa Destroyer Doctrine relegated Klingon destroyers to the role of combat support vessels, “cleaning up” after larger and more powerful capital ships had already beaten down the designated target or targets. Many Klingon destroyer captains tried to ignore this as best they could; however, the classes they were provided were not always up to par with their desires. *Lechtu* and *Desta Kar* are the only widely accepted examples of good Klingon destroyers produced under the Kessa Doctrine. *Kortak* is universally reviled, *Vkar zadan* was merely tolerated by its commanders, and the unique *Dath d’lan* fell in a special category of contempt all by itself. The design joke that was *Kl’sarza* was evident to all but the Klingon High Command. It was not until Colonel Galt’nah’s sensational war games exercises of 2280 that the folly of the Kessa Destroyer Doctrine was exposed. By that time, however, many Klingon destroyers had fallen prey to their foes and morale among the surviving captains was low. It would take a new shipbuilding program along with Colonel Galt’nah’s unflagging support to restore the Klingon destroyer fleet to its former glory.

As of this date the ranks Klingon destroyer squadrons have swelled once again with new designs such as *QuD* and *Lara’atan*. Experimental designs such as *K’teremny* and *tel’lw* also show a willingness on the part of the Klingon High Command to trod the “heavy destroyer” road more thoroughly explored by Federation designs. Klingon destroyers, both new and old, are once again resuming their time-honored places as “the scourges of the spaceways.”



Kortak

***DorDuj* type 1 (*dakasta* type 1) [2251]**

Specifications as built

Dimensions

Length: 116 meters
Beam: 17 meters
Height: 25 meters

Mass

Subspace displacement: 23,000 DWT

Crew complement

Officers: 23
Enlisted: 77
Imperial Guards: none

Top velocity

Cruising speed: warp 4
Rated maximum speed: warp 7

Endurance

Standard endurance: estimated 1 year at L.Y.V.

Armament (*)

Disruptors: 2 standard disruptors (both F)
1 heavy disruptor bank (F)

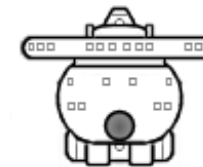
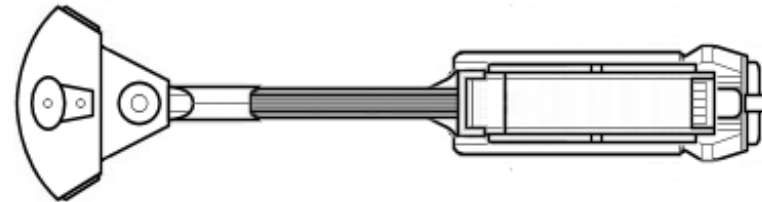

Known starships

Hull #	Name of starship	Builder	Status
KRD01-001	<i>Kortak (Accomplishment)</i>	Taamar Shipyards	active
KRD01-212	<i>Yutharval (Fortune's Point)</i>	Iosia Shipyards	lost

Kortak was officially redesignated as an escort class (*DorDuj*) during Chancellor Kessa's ramp-up of Klingon fleet strength in the 2260s. This was a natural move, given its smaller size and limited capabilities in comparison to more modern destroyer designs. Even so, it was officially the Klingon Empire's first modern destroyer class and is still referenced as such in many works. It is because of its historical significance, not its current status, that we have placed *Kortak* here in the destroyers section of this work.

The name for this particular class of destroyers is considered something of a joke by modern Klingons. *Kortak* in the original Klingonaase can be loosely translated as "accomplishment," but the word entails more than just that. It implies a singular, personal triumph that was hard-won in some great cause or endeavor. Thus the accomplishment is an individual one and always of great merit. This stands in stark contrast to the bad reputation of the starship class that bears this name. *Kortak* is widely regarded as the single worst destroyer design ever produced by the Empire. How it came about, how it came into Imperial Service, and why it has remained an active starship class for so long is quite a story.

Kortak came about as part of Chancellor Kar'hamer's long-range plans for an all-out war with the Federation in the 2260s. It was conceived as a auxiliary combat vessel of simplified design, one that could be produced cheaply and in mass numbers. It was part of Chancellor Kar'hamer's strategy to throw massed squadrons of these new small ships, these *dakastas* (Kl. "Fast-Moving Tool") against the Federation's large capital ships. Sheer numbers would offset any technological edge that Star Fleet might still possess. In addition, it was projected that squadrons of *dakastas* would roll across Federation shipping lanes, overwhelming their escorts and destroying any and all Federation transports in sight. Fate also played into *Kortak's* favor. The sudden and unexpected outbreak of the Demon War in 2249 put such a strain on Klingon shipyards, repairing damaged vessels and building new ones, that any design that could be rushed to combat was quickly put into production. *Kortak* fit the bill, and Taamar Shipyards was immediately given a contract to build as many as its yard capacity would permit without even prototype testing. Work was quickly farmed out to what would become the Empire's other major destroyer shipyards, Iosia and Fonawal, and soon all three were churning out *Kortaks* at a record pace.

The haste and press-of-need at which *Kortaks* were built was a clear invitation for trouble, and it soon appeared. Performance of secondary systems was often erratic. On some vessels, it became so bad that many *Kortak* crews took to wearing life support equipment all the time, just in case the life support system decided to "go on the fritz," to borrow a Terran expression. The structural support frame was so basic that each *Kortak* had

a noticeable "shudder" whenever it was at warp. The higher the warp speed, the more the ship would shake. There were at least two recorded instances of a *Kortak* literally shaking itself to pieces in trying to escape from pursuing Kinshaya void-spheres. The sole survivor of one of these, the *Yutharval*, likened the experience to "rolling down a mountain inside a metal shipping crate." Exacerbating this were a number of faulty welds in the earliest *Kortak* production runs, most likely due to the forced rate of production. These and many more factors soon combined to give the *Kortak* the unwelcome reputation of the worst starship class in the Imperial Fleet. Indeed, it was during this time that *Kortak* earned what would become its time-honored unofficial nickname – *gozhe l'il dlach'tat* (Kl. lit. "shit on a shingle").

Under normal circumstances, the Klingon High Command would have probably ditched *Kortak* as soon as it could and reboot the *dakasta* program with another design. The Demon War, fought against the Kinshaya, fiercest of Klingon foes, prevented this. The Klingons were hip-deep in a massive, multi-front war and they were losing badly. Instead, most of the production problems were quickly resolved in the best Klingon manner. Blood was spilled, heads rolled, and at least one *Qu'Hegh* ritual was carried out against a recalcitrant Lesser House. *Kortak* production would continue, albeit with a modified design, and this time there would be NO failures – else more heads would roll at Taamar, Iosia, and Fonawal.

It is unclear whether or not the masses of *Kortak* and its scout variant *Akh'ist* produced during the Demon War made any difference in the final result. The war ended in a stalemate and truce, with both sides essentially having ground each other down to the point of exhaustion. In the end, the Klingons had regained most of their lost territory and had taken enough Kinshaya territory to make up the difference. Both sides agreed to restore the old border and the Kinshaya returned back to the Demon's Rift, from which they have yet to return. The war was over. With peace in hand – relative peace, that is, given minor conflicts and skirmishes on other Klingon borders – the issue of the problem-plagued *Kortak* could be raised once again. The *dakasta* program was eventually rebooted in the 2260s with *V'kar zadan* by Chancellor Kessa, successor to the assassinated Kar'hamer. This left several hundred *Kortak* and *Akh'ist* hulls, most of which were still serviceable. Indeed, the final two production batches, completed before the program was officially cancelled in 2265, had never seen combat. What was to be done with a class of starships that almost every Klingon warrior, from the grandest admiral to the lowest warrior, so thoroughly despised?

The solution seized upon by the Klingon High Command was both simple and elegant. *Kortak* would be reclassified as an escort and relegated to escort-level assignments. These were more in keeping with its design

limitations. *Akh'ist* would continue in its role as a fleet scout for the time being, until larger numbers of more modern designs became available. Not just any crew would man these ships, however. All berths on *Kortak* and *Akh'ist* were reserved for the malcontents of the Imperial Fleet – those warriors who, regardless of rank or status, deserved special discipline for their misdeeds. Being assigned to the worst class of starship in the fleet was meant as a humbling blow, but it was also a chance at redemption. *Kortak* might be old, undergunned, and underpowered, but it was after all a warship. It was one final chance at redemption, a last opportunity to reclaim glory and honor in battle against a valiant foe. As one grizzled Klingon veteran later confided to a Terran acquaintance, “It beat the hell out of being sent to a penal colony.”

So it was, and so it still is that the despised and reviled *Kortak* found a new lease on life as the Imperial Fleet's unofficial “punishment ship” (tH. *BlijHom*). Every sector of Klingon space has at least one *Kortak* class destroyer or *Akh'ist* class scout. Every one of these vessels, from deck personnel to their captains, are crewed by warriors serving out sentences for various crimes committed against the Empire. Most of the Greater Houses have followed suit with their own *Kortaks*, or in some cases substituting other older vessels in their place when no *Kortak* is available. Every warrior on board one of these ships knows it is their last chance at salvaging their honor and Klingon pride. It is not surprising then, that many force and subsequently die in desperate battles so they can shine with glory one last time before making their journey to Sto-Vo-Kor.

There is little to say regarding *Kortak's* design and combat performance. It is basically a *Kuve* command boom with a single, strap-on *pljonta'* and rudimentary impulse drive. A small and extremely cramped secondary hull does little more than provide the bracing and conduits for the necessary connections. As built *Kortak's* single *pljonta'* was woefully underpowered and frequently failed in operation. It was replaced with a more powerful and reliable model after the Demon War was concluded, but total drive failure at high warp is still a common occurrence. The weapons mix has remained the same throughout its service life, consisting of three boom-mounted standard disruptor banks (only two in *Akh'ist*) and a pair of engine-mounted heavy disruptors (only one in *Akh'ist*). Oftentimes there is not enough power available to fire all weapons simultaneously and maintain full shield integrity, even with the impulse engine engaged.

Combat tactics for *Kortak* are fairly straightforward. Approach at as high warp as the aged *pljonta'* will permit without breaking down (usually warp 4 or 5), get in the first shot, make it a good one, and then conduct “a rapid strategic withdrawal to reassess the situation.” In short, shoot first and then run away as fast as you can, although no Klingon in their right mind would

ever say this openly. *Kortak* lacks both the power and the weaponry to engage in a protracted fight with any modern starship and can conceivably even have trouble with some of the heavier armed civilian designs. It is for this reason that *Kortaks* can often be found patrolling in squadrons of three to six ships, frequently operating in the same manner as modern gunboat or patrol ship squadrons.

It is not unknown for *Kortak* commanders to modify their vessels in order to improve their dismal combat performance. Such modifications are officially frowned upon but are almost always permitted, provided the ship's captain and crew have somehow managed to overcome their ship and have scored a few successes in combat – more often than not against overwhelming odds. The most common modification involves adding an additional pair of standard disruptors, one port and one starboard, clamped to the exterior of the secondary hull. In many cases point-defense disruptors, which consume less power and are almost as effective at close range, are substituted for both stock and additional standard disruptor mounts. Drone racks are a frequent and inexpensive substitute for the additional disruptors. Another popular location for an additional drone rack is inside the ship's shuttle bay, where it can be safely concealed merely by keeping the hangar bay doors closed. The weakness of the ship's frame prevents the installing of modern *pljonta'*; however, there have been occasions where an enterprising *Kortak* commander has managed to obtain and install an old-fashioned auxiliary power reactor for some much-needed “extra juice.” This too is one of several “shuttle bay mods” that can be found on many a *Kortak* operating on the Empire's borders.

There has been only one fleetwide refit applied to *Kortak*. All vessels in Imperial service received a standard 2260s shielding and support systems refit. Many of the Houses that still operated *Kortaks* promptly followed suit. Most Klingon warriors privately muttered that it was a waste of effort and resources, but the High Command apparently thought differently. It seems that they intend to keep *Kortak* around for a long, long time. It has ideally served its new purpose, and its presence is a constant reminder that a warrior's honor is both easily lost and hard to regain.

***Kortak* class Klingon destroyer created by
Patrick Flannery (*Star Fleet Handbook* #10)**

Class name by Eric “Jackill” Kristiansen

Background material and schematic courtesy of Richard Mandel

V`kar zadan

***QawDuj* type 1 (*dakasta* type 2) (2269)**

Specifications as built

Dimensions

Length:	205 meters
Beam:	135 meters
Height:	30 meters

Mass

Standard gross:	211,500 GMT
Subspace displacement:	74,500 DWT

Crew complement

Officers:	30
Enlisted:	190
Imperial Guards:	none

Top velocity

Cruising speed:	warp 7
Rated maximum speed:	warp 8

Endurance

Standard endurance:	estimated 1 year at L.Y.V.
---------------------	----------------------------

Armament

Disruptors:	2 standard disruptors (1 F/P, 1 F/S) (*)
Guided weapons:	4 photon torpedo tubes (all F) (*)
Other:	none (*)

(*) Beginning in 2275 a major refit program was applied to all existing hulls as well as hulls under construction from that year onward until production was brought to a halt in 2280. Part of this refit program included the addition of a third aft-firing disruptor mounted in a keel bulge, as well as the replacement of one pair of photon torpedo tubes with either two standard disruptors or two drone racks. Cloaking devices were also backfitted to all surviving hulls after their transfer to the service of the Lesser Houses.



Known starships

Hull #	Name of starship	Builder	Status
KRQ02-001	<i>V`kar zadan</i> (<i>Stingtongue</i>)	H'renn Shipbuilders	active

V'kar zadan was one of the results of Chancellor Kessa's efforts to build up the Imperial fleet for an all-out war with the Federation commencing no later than 2270. The Organians eventually put a stop to that dream; however, the effort produced a whole new generation of starships to replace the aging Imperial designs of the 22nd and early 23rd century. The *V'kar zadan* class destroyer was one of these – a new design to fill the need for a modern “middle” capital ship design. It entered service too late to see action in the Organian Incident; however, it soon got its chance in the Triangle fighting the Romulans and on other borders with foes of other races. It even got its chance to prove its worth against the Federation on several occasions.

The unusual design of *V'kar zadan* reflects changes in Klingon destroyer tactical doctrine made at the time it was under development. Instead of playing the traditional roles of fleet escort and commerce raider, Kessa believed destroyers best served the Empire as fast and highly maneuverable firepower augmentation platforms. Structural integrity would have to be compromised, yet such would not matter in the short haul per Kessa and his advisors. Their new destroyers, such as *V'kar zadan*, would be follow-up craft, designed to sweep in and quickly finish off a wounded enemy after the better protected battlecruisers knocked down his defenses. “Modern” destroyers would be built to deliver the *coup de grace*, not stike first blows. The folly of this tactical doctrine would eventually be exposed by Colonel Galt'naH in the Klingon war games simulations of 2280; however, it would come too late for *V'kar zadan* and other destroyers of its generation.

The Kessa Destroyer Doctrine explains the unusual weapons loadout of *V'kar zadan*. It is built entirely for offense, with little thought given to its own protection or that of its crew. In order to carry out its intended role it mounts an impressive array of four standard photon torpedo tubes, augmented by two standard disruptors (obstensibly for self-defense). There is no weapons coverage of any kind aft, not even with its own disruptors. The Kessa Destroyer Doctrine dictated that a destroyer would not need aft quarter coverage, since its opponent in theory would be incapable of fighting back (or preferably destroyed) by the time it finished its attack run.

Fate was not kind to *V'kar zadan*. It did well enough in the types of battles for which it was designed; however, those tended to be few and far between. Lone *V'kar zadan*s often wound up as prey rather than hunters due to the fact that they were being used as standard patrol ships – a mission profile that ran counter to their basic design. The inherent weaknesses of *V'kar zadan* were graphically illustrated during the Torana Conflict of 2274, when seven entire squadrons of *V'kar zadan*s were wiped

out by Romulan forces within eight minutes. To make a long story short, the Romulan ships uncloaked directly astern in their blind spots and opened fire. Not a single Klingon vessel survived.

Beginning in 2275 all surviving *V'kar zadan*s received extensive shielding refits to prevent a repeat of the staggering losses of its class members during the Torana Conflict. This refit was also reflected in modifications made to *V'kar zadan*s under construction and built after this date. A third disruptor was bulge-mounted to cover the ship's vulnerable aft quarter. Two of the photon torpedo systems (port and starboard) were removed and replaced with either two more standard disruptors or drone racks, depending on the intended theater of operations. Disruptor-modified *V'kar zadan*s went to the Federation and Romulan borders, whereas drone-modified models went to the Mirak and Lyran borders. The end result of these weapons and shielding modifications was a better destroyer, although it still lacked in capabilities when compared to its contemporaries serving with other interstellar powers.

V'kar zadan production ended in 2280. Of the 129 that were built, only 35 remained in the service of the Empire by 2290. One was captured by the Romulans, two by the Federation, and one by the Mirak. The rest were all either lost or missing, presumed lost. The surviving *V'kar zadan*s are all modified versions, either sporting the 2275 refit or having similar modifications installed during construction. The class was removed from Imperial service in 2293 and subsequently “donated” to the Lesser Houses for disposition. All 35 surviving *V'kar zadan*s continue to serve the Empire in their new roles with the Lesser House fleets.

The class name, which translates from Klingonaase into Standard as “Stingtongue,” comes from a type of snake found in the Klingon deserts. It is not poisonous, yet its venom is potent enough to cause a sharp stinging sensation along with localized paralysis whenever one is bitten. It has even been known to kill on three documented occasions via bites to an unprotected jugular vein.

***V'kar zadan* class Klingon destroyer
created by Forrest G. Brown and Dana Knutson
for STAR TREK – The Role-Playing Game by FASA Corporation**

**Additional background material courtesy of Brad Torgerson
and Taldren (Activision Games)**

Visuals courtesy of Paul Brown and Tyrel Lohr

Dath d`lan

***QawDuj* type 2 (*dakasta* type 11) (2262)**

Specifications as built

Dimensions

Length:	234 meters
Beam:	128 meters
Height:	45 meters

Mass

Standard gross:	343,750 GMT
Subspace displacement:	85,500 DWT

Crew complement

Officers:	27
Enlisted:	193
Imperial Guards:	none

Top velocity

Cruising speed:	warp 8
Rated maximum speed:	warp 11

Endurance

Standard endurance:	estimated 3 years at L.Y.V.
---------------------	-----------------------------

Armament

Disruptors:	8 standard disruptors (non-standard firing arcs)
Guided weapons:	2 photon torpedo tubes (1 ea F/A) 2 drone racks (*)
Other:	cloaking device (2272 backfit)

(*) Dual drone racks are included because the recessed design of the *pljonta'* mounts makes it impossible to install heavy disruptors on *Dath d`lan* without major modifications. Some hulls received an extra pair of drone racks during the 2272 cloaking device backfits; however, this was not a fleetwide modification.



Known starships

Hull #	Name of starship	Builder	Status
KRD11-001	<i>Dath d`lan (One Wing)</i>	H`renn Shipbuilders	---

Dath d'lan was the brainchild of Quypu loDogh, the chief starship designer for H'renn Shipyards during the 2260s. A student of the legendary Jogh Kenka, loDogh specialized in unusual and extraordinary spacecraft designs. Most of his fellow engineers believed him to be touched or even crazed, however, House Cho'dak recognized his "mad" genius and hired him as a starship design engineer in 2244. The improvements he made to designs on their existing schedules significantly increased production and design reliability, and by 2256 the young loDogh found himself as the newly installed head of the H'renn Design Bureau. His new position and power gave him the authority to finally put forth a warship design that he had been toying with since the days of his apprenticeship with Kenka. It was destined to go down as the oddest starship designs ever to see service with the Empire, and it would earn loDogh his own unique entry in the annals of Klingon history.

What made loDogh's proposal unique among the many others submitted for new fleet destroyers submitted in 2257 was its asymmetrical design. It quickly earned the name *dath d'lan* (Kl. "One Wing") among loDogh's fellows at the H'renn Design Bureau. Others within the Imperial fleet procurement system had other names for it, and most of them were not kind. It lacked the sleek lines of 22nd century vessels, or the unspoken aggressiveness found in 23rd century *Drell* derivatives. *Dath d'lan* was definitely in a class by itself. It was rumored that loDogh had taken his cue from the asymmetrical designs of the Breen, and quiet whispers spoke of an alien conspiracy unproven yet insinuated all the same. The gossip eventually became so bad that the Klingon High Command took the unusual step of calling the H'renn Design Bureau before it to answer charges of collusion. loDogh's many foes thought they had him until a surprise visitor was granted permission to sit in the observation gallery during the hearing. That visitor was none other than General Chang, Deputy Chief of Staff to Chancellor Kessa. All present knew that Chang's presence meant that Kessa had taken a personal interest in loDogh and his *dath d'lan* proposal. All charges of conspiracy and collusion were subsequently dropped, as they were groundless to begin with.

After the hearing was over it is said that General Chang called loDogh aside for a few private words. "Your design as it stands right now is *QI'yah* (tH. expletive)," he is reported to have said, "but it's original. I like that. You're trying to think outside the box, and that's good. You're just the sort of Klingon the Empire needs. Let's see what we can do about improving it." With that Chang wrote a personal letter of introduction for loDogh to master shipbuilder Hogh Balth, asking him to take a look at *Dath d'lan* and see if there was any way to turn it into a starship worthy of Imperial service. Balth's impression was the same as Chang's – it was original, to be sure, yet it still needed work to make it an effective design. His collaboration

with loDogh would make *Dath d'lan* even more unique than it already was to begin with.

Dath d'lan, the class prototype, finally cleared the H'renn slipways in 2261. It was a far cry from loDogh's original proposal. Gone was the ungainly unbalanced look that had caused such consternation in the first place. Instead, here was a destroyer class starship that defied all design sensibilities. In place of the standard command boom and secondary hull arrangement was a gracefully snaking hull that seemed to loop back on itself to compete the "one wing" effect. The only parts of it that were recognizable were its standard *Drell*-type forward command module (sans boom) and its engines. The rest was a unibody hull, starting with a curved forward section for the command module and ending in a broad-beamed aft section with its twin *pljonta'* mounted on either side. Most Klingon starship captains who were present at the prototype's space trials immediately scoffed at its looks. They did not scoff for long, though. In space trials *Dath d'lan* easily outperformed all other Klingon destroyer designs of its time, with maneuverability and acceleration ratings exceeding those of fleet battlecruisers. It also held up better than expected in combat trials, although commanders first had to get adjusted to its odd disruptor firing arcs. Unfortunately it took Klingon starship captains too long to get used to *Dath d'lan*. Whether it was due to its unusual design or simple foot-dragging will forever remain a matter of debate; however, the issue was strong enough that the design was withheld from general production. Even so, *Dath d'lan* still had a niche to serve in the Imperial fleet – the same that had brought about Chancellor Kessa's interest in the first place.

Dath d'lan entered limited production in 2262 as the first of the Empire's "destroyer leaders" (tH. *la'QawDuj*). In this role *Dath d'lan* functioned as a command ship for destroyer squadrons on extended border patrols. A scaled-down C3 suite suitable for squadron level operations took the place of what would normally have been Imperial Guard facilities. Patrol ship docking clamps and a special gangway-type boom dock (for larger vessels) were also installed in *Dath d'lan's* "docking hub," which curved from the command module back to what would have been the secondary hull. This allowed for both direct personnel and supply transfers as well as a limited capability to act as a patrol ship transport/tender. The net result of this was to free up Imperial dreadnoughts and command ships for other tasks more suited to their roles as large capital ships, instead of playing as mother ships for destroyer and patrol ship squadrons.

The tendency for the Imperial Houses to stick with tried and true (and therefore "more normal") designs meant that *Dath d'lan* never gained acceptance outside of the Imperial fleet. Only 39 of a planned 57 hulls were built before the construction contract was cancelled "in favor of newer

designs.” The last entered service in 2285. H’renn remained the primary contractor throughout the production run, although the Imperial facility at Tamaar provided support and even wound up building 8 hulls at its own facilities. *Dath d’lan* was retired from Imperial service in 2296 and the entire class was immediately put up for sale; however, to date not a single hull has been purchased by any of the Greater or Lesser Houses. Only 12 have been sold, all to private bidders from the Triangle. The rest remain laid in reserve at Mastocal, awaiting further decision from the High Council as to their ultimate fate.

Despite its odd appearance *Dath d’lan* is actually a sound warship. Its warp dynamics are an improvement over the basic *Drell* design in certain aspects, although the instabilities created by its asymmetrical design make it a tricky ship to handle. The asymmetrical design also makes for non-standard firing arcs for its disruptors, and it is an established “fact” that many Klingon starship commanders take a considerable amount of time “getting used to them” – usually at the threat of imminent court-martial.

The “docking ring” (as it is known by Starfleet Intelligence) is perhaps the most interesting aspect of its design -- one that has been sadly overlooked due to resistance by the Houses. This was Hogh Balth’s main contribution to *Dath d’lan*. Its placement is such that it can travel at warp with docked craft within the “ring” without penalty, since they do not protrude out into *Dath d’lan’s* warp field as they would on other similarly equipped designs. Experienced *Dath d’lan* commanders have been known to take advantage of this fact while in the field, always traveling with the maximum of docked small craft that the “hub” can hold. This way they always have a “heavy” small craft capability during missions, and it is a tactic that has time and again proven its soundness during many *Dath d’lan* deployments. Other possibilities suggest themselves, and it is fortunate for the Federation that the obstinacy of the Klingon Houses has prevented the Empire from following up on them.

Dath d’lan is a Klingon starship design about which the Empire has no middle ground. You either like it or you don’t. The few commanders who stuck with it sing its praises, while those who refuse anything to do with it continue to put it down as “not being a proper *Klingon* starship.” Two things are for certain, though. Its like will not be seen again in the Imperial feet any time soon. It has also earned Quypu loDogh a small yet permanent niche among the legends of Klingon starship design.



This image is a reconstruction of loDogh’s original *Dath d’lan* proposal. The inherent warp field instabilities in such a design made the original *Dath d’lan* almost as maneuverable as an escort; however, its weapons firing arcs were problematic – to say the least. Hogh Balth’s improved design essentially restored some of the symmetry by shifting the entire “secondary hull” halfway to starboard. This necessitated a “hooked command boom” in order for the command module to retain relative centerline symmetry with the rest of the ship. Hogh Balth’s redesign made for a more stable warp platform with minimal loss in maneuverability at both impulse and warp speeds.

***Dath d’lan* class Klingon destroyer
created by Forrest G. Brown and Dana Knutson
for STAR TREK – The Role-Playing Game by FASA Corporation
Redesigned version by Atolm**

**Additional background material courtesy of Brad Torgerson, Major Racal,
Atrahasis, Rod O’Neal, and Taldren (Activision Games)**

Visuals courtesy of Major Racal (redesign) and Firehawk (original)

Desta Kar

***QawDuj* type 3 (*dakasta* type 14) [2270]**

Specifications as built

Dimensions

Length: 220 meters
Beam: 170 meters
Height: 42 meters

Mass

Standard gross: 238,000 GMT
Subspace displacement: 60,100 DWT

Crew complement

Officers: 52
Enlisted: 248
Imperial Guards: none

Top velocity

Cruising speed: warp 6
Rated maximum speed: warp 7

Endurance

Standard endurance: estimated 1 year at L.Y.V.

Armament

Disruptors: 4 standard disruptors (arcs F, A, P/A)
2 heavy disruptors (F only)
Guided weapons: 2 photon torpedo tubes
Other: cloaking device



Known starships

Hull #	Name of starship	Builder	Status
KRQ14-001	<i>Desta Kar (Stinger)</i>	Tamaar Shipyards	---

Desta Kar was one of the last of the Kessa program destroyer classes to enter service. It was put forth by the Great Houses as the “real” Klingon destroyer leader (tH. *la’QawDuj*) as opposed to Quypu loDogh’s unconventional *Dath d’lan*. Because of this support there was little opposition to its approval and it practically sailed through the procurement process. Klingon politics of the day also made sure that it got the lion’s share of *la’QawDuj* funding, even though the High Council dared not cancel *Dath d’lan* outright for fears of reprisal from Chancellor Lotar, successor to Kessa and a good friend of General Chang, *Dath d’lan*’s chief champion. 61 were eventually built between 2270 and 2286, in comparison to only 39 *Dath d’lans*, although they were still far too few to properly fill the growing “destroyer gap” becoming evident in the Empire’s space fleets.

The late Colonel Galt’naH once called *Desta Kar* “the first decent *QawDuj* to enter service since the war” (the Organian Conflict of 2267 – ed.). It was the first modern Klingon destroyer design to have a fairly balanced mix of power, weaponry, and shielding. It was also the first to be fitted with the cloaking device as a standard feature during construction. As such it was also one of the few Klingon destroyer classes available for Galt’naH’s 2280 war games exercises that could perform the traditional destroyer roles of commerce raiding and fleet escort. His only real gripe with the design was that there were far too few of them available to properly serve the Empire’s long-range goals. This was of course a product of the failed Kessa Destroyer Doctrine, which had limited the number of “real” destroyers in favor of glorified heavy firepower platforms.

There was one major drawback to *Desta Kar* with regards to patrol ship operations. Its patrol ship docking clamps were located on the rear of the ship in an effort to minimize warp field interference. *Desta Kar* commanders soon discovered their ships had an unfortunate tendency to “shake off” any docked patrol ships at high warp. The docking clamps were eventually removed from all *Desta Kars* in service.

Colonel Galt’naH would remember *Desta Kar* when it came time to submit *QuD*, his own later modern destroyer proposal, and incorporated certain of its features into *QuD*’s design. As such *Desta Kar* is considered an ancestor of sorts for *QuD* by most Federation starship historians.

While *Desta Kar* has since been supplanted by more recent designs as a front line vessel, its overall excellence has assured its continued service with the Empire. None remain in Imperial service, however. All 33 surviving hulls can be found in House fleets. For the Great Houses they serve primarily as armed priority couriers. For the Lesser Houses they still continue in their originally designed role of destroyer leader.



Desta Kar class Klingon destroyer
created by Forrest G. Brown and Dana Knutson
for *STAR TREK – The Role-Playing Game* by FASA Corporation

Additional background material courtesy of Brad Torgerson
and Taldren (Activision Games)

Visuals courtesy of Paul Brown, Tyrel Lohr, and Korah

Lecthu

***QawDuj* type 4 (*dakasta* type 15) (2272)**

Specifications as built

Dimensions

Length: 146.5 meters
Beam: 50.3 meters
Height: 27.5 meters

Mass

Subspace displacement: 65,000 DWT

Crew complement

Officers: 40
Enlisted: 155
Imperial Guards: none

Top velocity

Cruising speed: warp 4.0
Rated maximum speed: warp 6.0

Endurance

Standard endurance: estimated 2 years at L.Y.V.

Armament

Disruptors: 7 standard disruptor banks (3 F, 2 ea P/S)
2 heavy disruptor banks (both F)

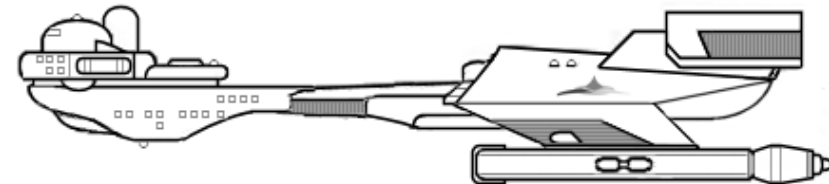
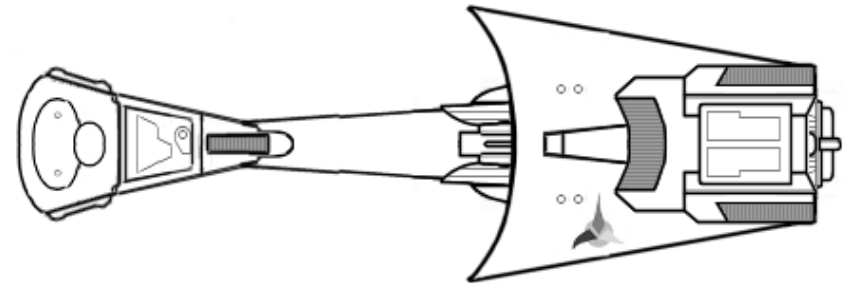

Known starships

Hull #	Name of starship	Builder	Status
KRQ04-001	<i>Lecthu (Bloody Spear)</i>	Iosia Shipyards	active
KRQ04-019	<i>Pach (Talon)</i>	Iosia Shipyards	active

Lecthu was the first of the post-Kessa destroyers built for Imperial service. It is also widely regarded as one of the most all-around balanced destroyer designs ever built by the Empire – which is not surprising, considering its origins. The reason why so few were built, in comparison to other Klingon destroyer classes, makes for yet another classic case study in Klingon starship design.

Lecthu's origins lie in a 2260 design study by none other than the legendary Hogh Batlh to address the well-known deficiencies of *Kortak*. Batlh apparently took his cue from the various attempts by the Federation Starfleet at making the most of the underpowered *Saladin*. His first move was to give the ship a decent secondary hull, upon which could be mounted a fleet standard S-2 *pljonta'*. Second, he opted for the slightly larger *pljonta* used on *Klolode* and *Jul'kar*, as opposed to those used on *Raxor* and *Hak'hyl*. This gave *Lecthu* the power necessary to both power its shields to full and effectively operate most of its weaponry. Second, he replaced *Kortak's* cramped *Kuve*-derived boom with the larger “economy” command boom first designed for *Hak'hyl*. This move proved wise in two respects. First, it provided much-needed interior storage space for the long-range commerce raiding missions for which *Lecthu* was designed. Second, it saved money. The *Hak'hyl* boom was already available and produced at several different shipyards. The same went for the *pljonta'* intended for the new destroyer. The only completely new component that would have to be built for *Lecthu* was the secondary hull.

It was not until 2271 that *Lecthu* was finally authorized. Work on the new *K't'orr* heavy destroyer was running into massive cost overruns, slowing construction to only one per year. The modernization program for *Hak'hyl* was also getting underway, and would leave the Imperial fleet with a surplus of older *Hak'hyl* command booms. It was around this time that Admiral Qin'neb, overall commander of the Imperial destroyer squadrons, recalled Batlh's *Lecthu* design study. He brought it back before the attention of the Klingon High Command. They were understandably delighted at the prospect of fielding a new warship class at minimal cost, and backed Qin'neb's proposal before the High Council. Another important backer was Colonel Galt'naH, one of the most brilliant tactical minds of his generation. He had long argued against what he perceived as a “destroyer gap” in both Imperial and House fleets caused by the Kessa Destroyer Doctrine. *Lecthu* would be a good start in filling it.

Lecthu, the first of the post-Kessa Klingon destroyers and the lead ship of its class, entered Imperial service in 2272. The production starship was almost identical to Batlh's original design study save for the implementation of *K't'inga* generation starship technology, such as the fleet-standard 2270s shielding and weapons refit as well as a STN-6 *pljonta'*. Unfortunately,

work on the rest of the class proceeded slowly – too slowly for Galt'naH's liking. The main problem was the slow speed of the fleetwide *Hak'hyl* upgrade program, from which *Lecthu* was sourcing its command booms. There was little chance of speeding this up, given the full schedules of both Imperial and House shipyards during this era. This frustrated both Galt'naH and Qin'neb to no end. *Lecthu's* shakedown cruise had demonstrated that the design was a winner, possibly the best Klingon destroyer of its generation, and yet its numbers were being hamstrung by factors beyond the program's control. The lack of sufficient numbers of *Lecthu* class destroyers in the fleet would be a telling factor in the Imperial war games exercises sponsored by Colonel Galt'naH's in 2280. By that time, there were only 37 *Lecthus* in service – a far cry from what was needed if the Klingons were to go to war with the Federation. The outcome of those wargames would help to speed *Lecthu* production somewhat, but it would remain hamstrung by the rate of *Hak'hyl* conversions until that program was completed.

Only 81 *Lecthus* were ever built. It is believed that about 30 or so of this number were eventually purchased for service in various Greater House fleets. A last batch of 14 was destroyed while under construction during the Praxis Event of 2293. No more are believed to be on order, although a number of older *Hak'hyl* command booms remain for such a contingency. Starfleet somehow managed to obtain the wreckage of one, the *Pach* (Th. “Talon”), which was recovered under still-classified circumstances from an encounter in the Triangle. *Pach* has since been rebuilt and now serves with Starfleet's Adversary Squadron.

***Lecthu* class Klingon destroyer created by Eric “Jackill” Kristiansen**

Background by Richard Mandel

**Schematics courtesy of Richard Mandel
Derived by permission from the originals by Eric Kristiansen
and from the work of Neale Davidson (Pixel Sagas)**

KI`sarza

***QawDuj* type 5 (*dakasta* type 16) (2277)**

Specifications as built

Dimensions

Length:	190 meters
Beam:	100 meters
Height:	28 meters

Mass

Standard gross:	280,500 GMT
Subspace displacement:	70,800 DWT

Crew complement

Officers:	23
Enlisted:	157
Imperial Guards:	up to 10 (in support of assault operations) (*)

Top velocity

Cruising speed:	warp 8
Rated maximum speed:	warp 12

Endurance

Standard endurance:	estimated 2 years at L.Y.V.
---------------------	-----------------------------

Armament

Disruptors:	4 standard disruptors (2 F, 1 ea P/S) (*)
Guided weapons:	none (*)
Other:	cloaking device

(*) The 2281 version adds 2 more disruptors (both P/A) and 2 photon torpedo tubes (1 ea F/A). The extra 2 standard disruptors come at the expense of the already limited Imperial Guard facilities. As with *qa'HoS* the aft tube is added via a redesigned impulse deck, installing smaller and somewhat less powerful impulse engines in order to provide room for the photon torpedo machinery. Some Houses have opted for wing-mounted twin impulse decks, *chetv'na* style, in order to have both the aft-firing photon and full impulse capability.

v



Known starships

Hull #	Name of starship	Builder	Status
KRQ16-001	<i>KI'sarza (Swiftwind)</i>	Iosia Shipyards	---

KI'sarza was originally the product of a backroom political deal by House Chungdak intened to keep most of the production facilities at its losia Shipyards from going idle. During the 2260s losia had seen most of the choice Imperial starship contracts go to other yards, most notably House Yok'tu's massive Chenwl Duj' spaceworks. By the time the 2270s rolled around losia's only two remaining major shipbuilding contracts were for the *K't'inga* and *Na ra'den*, and even on these it was an auxiliary yard as opposed to being the prime contractor. There simply were not enough major contracts left on its production schedule for losia to remain as a prime contender for warship classes much longer. Something had to be done to alleviate this situation, so House Chundak settled the matter in typical Klingon fashion. Deals were cut, bribes were paid, and even some blood was spilled in order to ensure losia's continued future. The end result of all of these House shenanigans was the creation of a new destroyer class. It was named *KI'sarza* (Kl. "Swiftwind") for the speed at which it went from submission to approval to the laying of the first keel at losia. *KI'sarza*, the lead ship of the class, entered Imperial service in 2277.

The initial impression that most beings get when first looking at *KI'sarza* is that it looks like an emaciated *K't'inga* with an extended command boom. This description is surprisingly close to the mark. Reuse of key *K't'inga* components helped speed *KI'sarza* development and production. The command boom extension provides room required for necessary support systems that was lost in *KI'sarza's* reduced form factor secondary hull, which is the only part of the ship unique to the class. This "stretched *Drell*" design gives *KI'sara* a decided edge over *K't'inga* in terms of acceleration and subspace inversion times, but it is the only advantage gained. In all other respects with regards to combat maneuverablity *KI'sarza* performs about as well as any other *Drell*-derived design.

The late Colonel Galt'naH did not have a very high opinion of *KI'sarza*. When asked about the class during the 2280 war games, he answered with one brief comment: *vll'oh' laHbe'* (tH. "utterly useless"). When asked to elaborate, he explained that it was an elegant design insofar as its *Drell* lineage was concerned, but that its lack of sufficient armament made it useless for the destroyer role. He didn't want "pretty ships," he wanted a combat capable destroyer. *KI'sarza* did not even qualify as a destroyer under the Kessa Doctrine due to its lack of heavy weaponry. He predicted that *KI'sarzas* would "fall like flies" during the subsequent war games exercises, and that is exactly what happened. Not surprisingly, *KI'sarza* production was halted immediately after the conclusion of the war games while House Chungduk incorporated a long laundry list of recommended improvements into the design. Production resumed at losia in late 2281,

and the first of the redesigned *KI'sarzas* entered service the following year. All existing *KI'sarzas* were accordingly refitted by 2285.

Despite its early development issues *KI'sarza* remains a favorite with House fleets. It sports the "classic" look of Klingon starships and the post-2280 improvements have actually turned it into a halfway decent destroyer. It still performs best in numbers, such as the classic Klingon three-ship "wolf pack" formation, but the addition of photon torpedo weaponry means that *KI'sarza* can now actually stand on its own as a warship if need be. Its low cost in comparasion to *K't'inga* means that its most popular customers are among the Lesser Houses, and the facilities at losia have remained busy fulfilling orders for them. *KI'sarza* constuction was halted for a time by the Praxis Event of 2293 but resumed in 2298 once sufficient repairs had been made to the losia facilities. House Chungduk expects to continue *KI'sarza* production "for as long as demand remains."



KI'sarza class Klingon destroyer
created by Forrest G. Brown and Dana Knutson
for *STAR TREK – The Role-Playing Game* by FASA Corporation

Additional background material courtesy of Brad Torgerson
and Taldren (Activision Games)

Visuals courtesy of Terradyhne

QuD

***QawDuj* type 6 (*dakasta* type 17)** **[2283]**

Specifications as built

Dimensions

Length:	157.8 meters
Beam:	196.4 meters
Height:	98.5 meters

Mass

Standard gross:	236,000 GMT
Subspace displacement:	89,300 DWT

Crew complement

Officers:	32
Enlisted:	110
Imperial Guards:	none

Top velocity

Cruising speed:	warp 7
Rated maximum speed:	warp 10

Endurance

Standard endurance:	estimated 1 year at L.Y.V.
---------------------	----------------------------

Armament

Disruptors:	6 standard disruptors (all F)
Guided weapons:	1 photon torpedo tube (F)
Other:	1 FMPA generator cloaking device

NOTE: A common modification reconfigures the disruptors into a 4 forward/2 aft arrangement. One out of every three *QuDs* observed in action sports this modified disruptor arrangement. The addition of a drone rack or second aft-firing photon torpedo tube, by means of a keel bulge, is less common but has also been observed on occasion. It is not known if either of these will be carried over to *K'vort*, *QuD*'s intended 24th century successor.



Known starships

Hull #	Name of starship	Builder	Status
KRQ25-000	<i>Mi'Qogh (Flail)</i>	Chenwl' Duj Shipyards	ptype
KRQ25-001	<i>QuD (Insurrection)</i>	Chenwl' Duj Shipyards	active

The year 2280 found the late Colonel Galt'naH in his final posting as an advisor on Federation battle tactics at the headquarters of the Klingon High Command on Qo'nos. Galt'naH, one of the most brilliant tactical minds of his generation and a starship historian to boot, had been one of the moving forces behind the creation of the modern "Bird-of-Prey" design, which had entered Imperial service just five years before. His new posting soon found him pulling duty as chief tactical advisor on a new computer war games simulation. It would pit the contemporary Klingon and Federation fleets against each other in a full-fledged General War exercise, winner take all. Galt'naH had access to all of the available and incoming data concerning the Federation Starfleet's new linear warp upgrade programs. This data was crucial to the realism of the simulation and it was his job to ensure that it was properly translated into the various war games programs. Galt'naH soon discovered, much to his growing irritation, that the newly uprated Federation destroyers were more than a match for the contemporary Klingon counterparts. Only the aged *Lecthu* came anywhere close to matching an uprated *Siva's* or *Larson's* combat performance in terms of acceleration and maneuverability, but it lacked both the raw power and weaponry to deal with *Siva's* formidable array of phasers and photon torpedoes. Most of the Empire's other destroyer designs were little more than battlecruisers stripped down almost to their bare frames (thus trading lightened mass for added maneuverability). Others were little more than glorified *veQDuj* (tH. "junk ships") such as the despised *Kor'tak*, a weak destroyer class that was so hated for its uselessness in combat that crew postings were frequently used to punish incompetence. Galt'naH knew how modern starship technology could revive old concepts, as he had proven with the Bird-of-Prey. In his opinion the modern Klingon fleet had an obvious destroyer gap, one that even large numbers of Klingon cruisers or pre-modern destroyer designs could not sufficiently fill.

Galt'naH's fears were confirmed by the time the first month of the simulated General War was finished. The vagrancies of the simulated war coupled with the lack of modern destroyers had placed such a burden on the Empire's cruisers that there were not enough to fend off two major Federation advances into Klingon space. Furthermore, the wartime burdens created by this situation placed such a strain on the Empire's simulated economy that cruisers were being taken out by Federation forces faster than they could be replaced. With this war game simulation data in hand Colonel Galt'naH decided it was high time to raise the issue of a modern destroyer class with the High Council. To Galt'naH's surprise, the High Council refused to listen. His proposal might have been heeded had not the leaders of certain of the Great Houses acted against him. They held the shipbuilding contracts for many of the cruisers and destroyers then in production. These vessels had been submitted by their own designers and

they had a complete lock on all profits, top to bottom, to be made from their naval construction contracts. To build a starship class that was not from their own House meant lost profits. To build one that was being proposed by someone who was not even a qualified starship designer was an insult. Galt'naH's arguments were quickly rebuffed, with the opposing Houses claiming that the simulation was wrong and that the Imperial fleet had more than enough cruisers and destroyers for a General War. When the enraged Galt'naH tried to press his point he was rebuked by Chancellor Lorak and quickly escorted out of the chamber. Once they were outside the building and alone Lorak bowed and apologized to Galt'naH. He privately agreed with Galt'naH; however, it would take more than computer reports to sway their opinion. "Feathers alone will not do the trick. It takes wings to ride the winds of change," he said to the colonel. "They need to see your wings before they can fly with you." Galt'naH took Lorak's words to heart and returned to his post, resolved to prove beyond all shadow of a doubt what he knew in his heart.

Several months later programming on the General War simulation was complete. The full High Council was on hand for an accelerated demonstration. As chief tactical advisor for the program it would be Colonel Galt'naH who would be in charge of that demonstration. With a pleasant smile he invited any of the councilors to command the Imperial fleet while he commanded Federation forces. Many quickly took up the challenge, including most of the foes of his destroyer proposal. Both Chancellor Lorak and Imperial Chief-of-Staff Gorkon watched as the simulated General Wars played out one after another in all-too-quick succession. The Empire lost the War within two years in every simulation run no matter who commanded its forces. The High Council was outraged and demanded an investigation, claiming fraud or trickery, but Lorak shook his head. It was Gorkon who answered the challenge. "I can vouch for the honor of all who set up the simulation," he said evenly. "There is no mistake or deceit. This is why this project was created in the first place: to find the problems with our fleets. Now that we know we have them, it is time we start finding solutions." He then turned to Galt'naH. "Any thoughts, Colonel?" he said quietly, but with a twinkle in his eye that only the colonel could see. Galt'naH then proceeded to add one more starship class to the Klingon forces – an upsized and modified Bird-of-Prey that would serve as a destroyer – after which he invited all of those who had lost the simulation to try their hand again. This time around, the Empire either held its own or won within four years about two-thirds of the time. The High Council was understandably impressed, and Yok'tu son of QI was the first to speak "That much of a difference?" he said. Galt'naH nodded. "Then I will be the first to swallow my pride and request the honor of buiding your ship," Yok'tu replied, striding forward and offering his hand to

the colonel in the traditional Klingon manner. Yok'tu, as ever the astute opportunist, was not about to let his foes seize a new naval contract before him if he could help it. Colonel Galt'naH returned his grip and the rest is history, or so they say. The new destroyer class would be built by House Yok'tu's famous Chenwl' Duj Shipyards, and it would be named *QuD* (tH. "Insurrection") in honor of Galt'naH's accomplishment of changing the High Council's mind on the manner.

Tactically *QuD* is nothing more than an upgunned and upsized *B'rel*. As such it magnifies all of the strengths and weaknesses inherent in the basic Bird-of-Prey design. It is a powerful ship with blistering forward firepower for its size plus the ability to cloak; yet it had no weapons capability in anything but the forward firing arcs. *QuD* battle tactics are essentially the same as those of *B'rel*: get in the first shot, make it a good one, and then cloak before your enemy can target you while you swing around for the next salvo. This strategy does not always work against experienced enemies, who could often predict where and when *QuD* would uncloak; however, good *QuD* commanders could usually make the most of their ship's inherent limitations in such battles.

QuD sightings have become quite common along the Treaty Zone. They serve in the traditional destroyer roles of patrol vessels, fleet picket ships, and heavy convoy escorts. Frequently a *QuD* will serve as a command ship for a House squadron on "extended patrol" (i.e. deep-penetration incursion and raiding missions). They were being produced at the incredible rate of one per month until Chenwl' Duj lost its shipbuilding contracts during a corruption scandal in 2287. Construction resumed in 2292 at three other facilities but was again halted by the Praxis explosion of 2293. Iosia finally resumed production in 2297, though at the dramatically reduced rate of only two per year.

Colonel Galt'naH, creator of the *QuD* and commander of the class vessel, was lost in a bloody battle with a Romulan battle fleet in the Triangle in 2292. Together he and his crew had racked up an impressive string of victories, with 72 confirmed enemy kills, before they cornered by superior Romulan forces. Surrounded and outnumbered three-to-one, Galt'naH's squadron had no choice but to turn and fight. Galt'naH's sacrifice, in which he rammed his crippled *QuD* into the bridge of the command Romulan Firehawk, saved the remnants of his squadron and allowed them to escape in the confusion that followed. *QuD* also took the Firehawk with it as Galt'naH and his crew began their glorious journey to Sto-Vo-Kor. Today Colonel Galt'naH is honored as one of the heroes of the Klingon Empire. The next production batch of *QuDs* will bear the names of Galt'naH and his command crew in honor of their final victory in this life.



***QuD* class Klingon destroyer created by Taldren (Activision Games) for the *Klingon Academy* and *Starfleet Command* series of licensed videogames**

Certain materials adapted for *QuD* from the works of Doug Drexler (*Deep Space Nine Technical Manual*) and FASA Corporation (*Klingon Ship Recognition Manual*)

Additional background material courtesy of Activision Games, Donald Burns, Battleclinic.com and the *Klingon Academy* Forums

Visuals courtesy of Taldren

Lara'atan

***QawDuj* type 8 (*dakasta* type 18) (2286)**

Specifications as built

Dimensions

Length: 212 meters
Beam: 159 meters
Height: 38 meters

Mass

Standard gross: 495,750 GMT
Subspace displacement: 125,800 DWT

Crew complement

Officers: 40
Enlisted: 240
Imperial Guards: up to 20 (in support of assault operations)

Top velocity

Cruising speed: warp 8
Rated maximum speed: warp 12

Endurance

Standard endurance: estimated 2 years at L.Y.V.

Armament

Disruptors: 6 standard disruptors (2 F, 1 F/P, 1 F/S)
2 heavy disruptors (F only) (*)
Guided weapons: 2 photon torpedo tubes (1 ea F/A)
Other: cloaking device

(*) Added to the design in 2290 after initial combat encounters with Federation and Romulan forces. These involve replacing the original *pljonta'* with a model that includes the heavy disruptor system in its forward section. It effectively transforms *Lara'atan* from a standard destroyer (tH *QawDuj*) into a heavy destroyer (tH *QawDuj'a*).



Known starships

Hull #	Name of starship	Builder	Status
KRQ18-001	<i>Lara'atan (Protector of Brothers)</i>	H'renn Shipbuilders	---

Since its introduction in 2288 *Lara'atan* has gone on to become both the most popular and the most successful Klingon destroyer design in modern times. It is almost as unconventional as the earlier *Dath d'lan*, although not as severe, but owes this to the acknowledged genius of the Taldren generation (tH. *puqpu' thIDrn*) of Klingon starship designers.

Lara'atan got its baptism of fire in late 2288, when the first three completed hulls to enter service were sent as a squadron on a special mission to the Triangle. Their orders were to intercept a Romulan supply colony and destroy every transport they could before Romulan reinforcements arrived. To their dismay, upon finding the convoy two Romulan escorts decloaked, both of a new design for which the Klingons had no information. The Klingons engaged anyway, hoping that the element of surprise would work in their favor. The new Romulan ships quickly destroyed one of the *Lara'atans* with a massive plasma torpedo volley and badly damaged another without suffering any apparent major damage in return. Realizing they were outgunned, the two surviving *Lara'atans* began a fighting withdrawal from the engagement in order to increase range and disengage by recloaking. The damaged *Lara'atan* sacrificed itself in a rearguard action so that the other undamaged ship could escape.

The combat debut of *Lara'atan* on the Federation border was a decidedly different affair. On 18 March 2289 the uprated Federation command cruiser *Kongo* (NCC-1710), escorted by the frigates *Halk* (NCC-2742) and *Rome* (NCC-2746) and under the overall command of Fleet Captain J. C. Fredriksen, responded to a distress call from a Federation outpost located in the Orion sector. Once they arrived they found the outpost had been destroyed three Klingon destroyers of a previously unknown configuration. The attack had been staged by Captain Kresz of House Kargon as a deliberate and cold-blooded means of directly evaluating *Lara'atan's* combat capabilities against the best that the Federation Starfleet had to offer. Kresz's fleet had apparently come off the worse for wear, though, with one *Lara'atan* drifting dead and space and two damaged ones attempting to render assistance. Fredriksen immediately ordered his ships to engage the two remaining *Lara'atans* before they could escape. Just as his fleet were about to close the range three more *Lara'atans* dropped out of warp directly behind the Starfleet vessels. At the same time the drifting *Lara'atan* began registering a massive power surge while the other two disengaged and quickly accelerated away. Realizing what was happening, Fredriksen ordered his ships to break off at once but it was too late. The drifting *Lara'atan* self-destructed, sending assorted debris flying at the Federation starships. *Kongo's* starboard warp nacelle was ripped off of its supports, its port nacelle damaged beyond repair, and both its primary and secondary hulls extensively damaged with multiple hull punctures. *Halk*,

which was the closer of the two frigates, suffered similar damage but somehow retained one operational warp engine. *Rome* was the farthest away and escaped major damage. *Rome* immediately came about and opened fire on the two fleeing damaged *Lara'atans*, trying desperately to open a gap in the ambush through which it and the damaged *Halk* could escape. The incoming three *Lara'atans* busied themselves with the crippled *Kongo*, firing volley after volley of photon torpedoes into the wrecked ship until it exploded. They then turned their attentions on the two frigates, which had almost succeeded in making good their escape. Both the *Halk* and the *Rome* were quickly dispatched by the three undamaged *Lara'atans*. News of the ambush did not reach Starfleet until three days later, when the coded signal of the *Rome's* recorder-marker was picked up by a passing patrol vessel. It is generally assumed that Captain Fredriksen and the crews of all three starships went down with their vessels, as no lifeboat pods were ever recovered and the surviving debris showed no sign of any having been jettisoned.

The most striking thing about *Lara'atan* is its unconventional design. Word has it that this is yet another of Quypu loDogh's creations, although this has never been confirmed. There is certainly nothing about it that even remotely resembles a traditional Klingon *Drell*-derived design. Instead, an angular Taldren-style command boom juts out of an angular, inverted form secondary hull with its *pljonta'* mounted over the horizontal centerline of the ship as opposed to under it. Several human officers in Starfleet have likened its appearance to the base stance of the Crane style of Terran martial arts. Ironically, *Lara'atan's* unique appearance is as deceptive as the martial arts stance in question. It is a powerful warship with amazing agility in combat, wielding cruiser-class firepower against any intended foes. The addition of the cloaking device only enhances its already impressive combat capabilities. The only times where *Lara'atan* has failed is when it found itself against superior opponents (as in the Romulan encounter of late 2288), but even in those situations it accounted for itself with honor before destruction.

Lara'atan has a surprisingly spacious secondary hull, which features (not surprisingly) a modular deck and component design. The apparent intent was to provide efficient compartmentalization in the event of battle damage (similar to that found on *K't'orn*) but it also lends itself to quick and easy customization. This feature, coupled with one of the roomiest shuttlecraft hangars to be found on a Klingon destroyer (room for up to 12 shuttlecraft), practically invites customization. At least 14 major *Lara'atan* variations have already been documented, ranging from auxiliary carrier to armed heavy scout/research ship. Oddly enough, there is even a *Lara'atan* armed hospital ship (one of the few in the Klingon fleet), designed to provide

medical facilities in support of planetary assault operations. More *Lara'atan* variations are expected in the years to come as their numbers increase in Imperial and House service.

Five of the Empire's major shipyards were granted new Imperial contracts for *Lara'atan* production after the Kargon Incident in order to step up production. 358 hulls were ordered under this new contract, in addition to the 82 already on order for H'renn and Iosia under the terms of the original contract. These include H'renn (the original primary contract holder), Iosia (the original secondary contract holder), Taamar, Fonawl, and Mustaka. It was expected that the combined *Lara'atan* production rate for all five spaceyards would be 18 per year, but this was prior to the Praxis explosion of 2293. As all five of these yards were located in the Klingon inner systems, and as all suffered major damage during the event, *Lara'atan* production was effectively halted for several years. It has since resumed on a limited basis (1 to 2 per year per facility) as the spaceyards in question restore sufficient capability to restart production. Mustaka was the first in 2296, with Taamar and Iosia recommencing in 2298 and 2299 respectively. Fonawl expects to restart *Lara'atan* production next year.

The Starfleet Intelligence code name for *Lara'atan* is "Gull," due to its unique appearance.

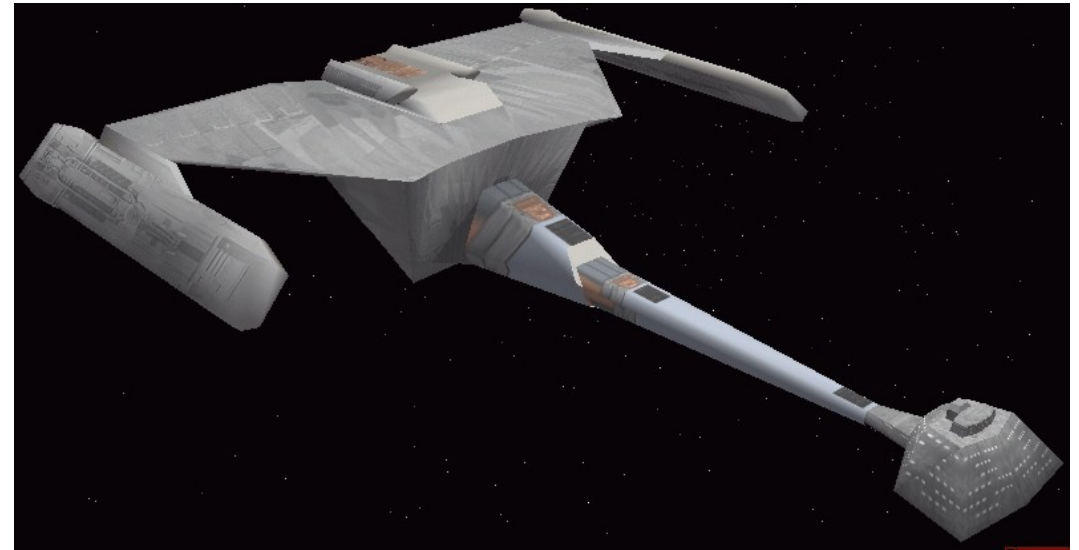

Lara'atan class Klingon destroyer
created by Forrest G. Brown and Dana Knutson
for *STAR TREK – The Role-Playing Game* by FASA Corporation

Additional background material courtesy of Brad Torgerson
and Taldren (Activision Games)

Visuals courtesy of Paul Brown, Tyrel Lohr, and Terradyhne

K^{teremny}

***QawDuj* type 9 (*dakasta* type 12) [2280]**

Specifications as built

Dimensions

Length: 251.2 meters
Beam: 174.9 meters
Height: 38.9 meters

Mass

Standard gross: 395,750 GMT
Subspace displacement: 111,000 DWT

Crew complement

Officers: 15
Enlisted: 380
Imperial Guards: up to 20 (in support of assault operations)

Top velocity

Cruising speed: warp 7.0
Rated maximum speed: warp 11.0
Rated emergency speed: warp 12.0

Endurance

Standard endurance: estimated 8 years at L.Y.V.

Armament

Disruptors: 10 standard disruptors
2 heavy disruptors (*)
Guided weapons: 2 photon torpedo tubes
1 drone missile rack (*)
Other: stasis field generator

(*) Post-2284 model/refit only

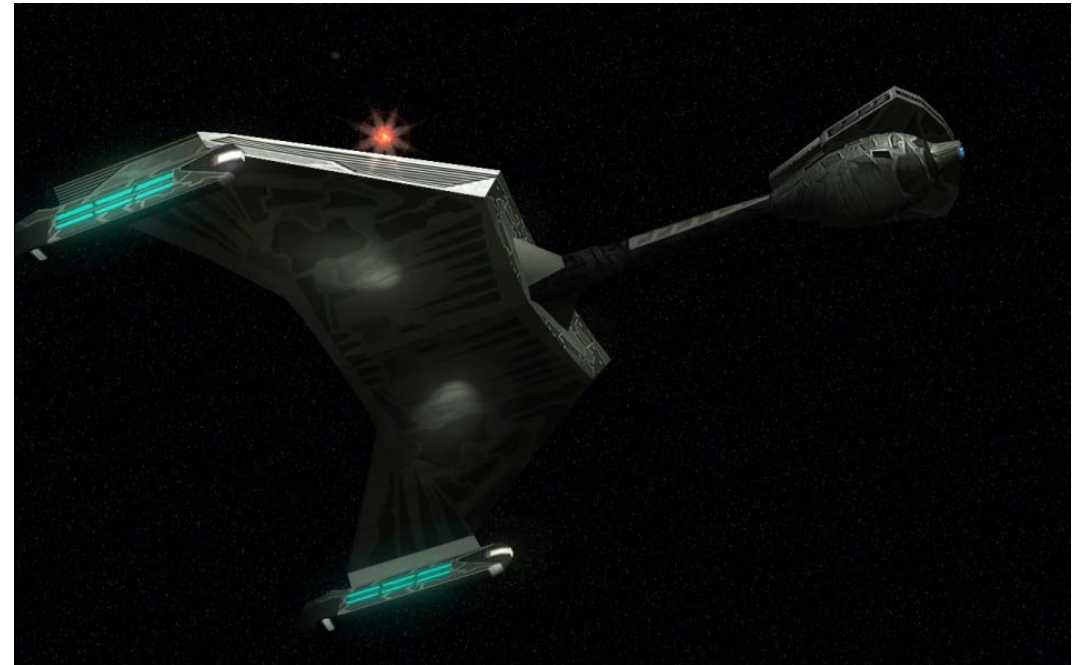

Known starships

Hull #	Name of starship	Builder	Status
KRQ9-001	<i>K'teremny (Great Slayer of Enemies)</i>	Kohl Imperial Spaceworks	active

K'teremny's current status reflects its reclassification as a type 9 *QawDuj*. At one time, though, it was the Empire's premiere heavy destroyer class. Designed during the era of the *puqpu K't'inga*, it was intended to be the ultimate answer to the Federation's upgraded *Loknar* and *Kearsarge* classes: a sleek and slender raider with destroyer agility but delivering battlecruiser firepower on its nimble hull.

The discrediting of the *Kh'exrillin* type 12 design in the mid-2260s, before a single hull had been built, prompted the need for a replacement. The Klingon High Command wanted something that could counter the capabilities of Starfleet's updated destroyer and light cruiser designs. There was also the need for a heavy raider with lightning penetration capability but with the firepower to fight its way out of any Starfleet ambush laid across its avenues of escape. The seizure of the Federation fleet tender *Acropolis* in 2265 had provided the Empire a veritable gold mine in Federation interior intelligence, most notably with regards to the systems used to operate and maintain its space buoys and subspace relay systems. *K'teremny* was designed to capitalize on all of this, as well as reflect the latest advances brought about by the *puqpu K't'inga* program.

Delays in funding, resource allocation, and the ever-changing political climate (not to mention the resistance and later assassination of Chancellor Kessa) delayed the *K'teremny* program for almost a full decade. It was not until 2279 that a prototype vessel was completed and launched. Almost immediately there occurred an event that might have laid a shadow over *K'teremny's* future. The prototype broke down during its shakedown cruise, leaving it helpless and drifting within easy reach of the Federation border. It did not take long for nearest Federation starship, the frigate *Knox* (NCC-1940) to detect the stricken *K'teremny* and dispatch a surveillance drone to its location. The disabled Klingon ship was unable even to destroy the drone, as its weapons systems were offline due to the accident. Thus, ironically, one intelligence coup was traded for another. For the first time in the history of Starfleet Intelligence it got a good look at a new Klingon starship class just as it was about to enter Imperial fleet service. This might have sprung the surprise the Klingons were planning for the Federation had not Starfleet Intelligence initially misread the drone data. It treated *K'teremny* as little more than an enhanced *K't'inga* despite "some unusual discrepancies" in the sensor drone data. Thus was Starfleet proper tragically misinformed about *K'teremny's* true potential as a warship.

In the following year the Federation strike cruiser *Bradley* (NCC-2502), responding to a distress call from a Federation research mission, became the first Starfleet vessel to engage a *K'teremny*. It arrived in star system UFC 24187 to find the heavy destroyer *Raga* already laying claim in the name of the Empire. *Bradley* challenged that claim and was immediately

attacked without provocation. *Raga* quickly proved the superior of the two starships in terms of agility and weapons coverage, but its captain's tactical skills were not up to those of *Bradley*. The Starfleet vessel was eventually able to disable and defeat *Raga*, although it was badly mauled in the process. *Raga*, unable to escape or defend itself, promptly self-destructed.

Starfleet's next major combat encounter with a *K'teremny* is often cited as the single worst defeat by a Federation starship battle group in modern times. In 2286 a Starfleet anti-piracy task force composed of the updated cruiser *Hood* (NCC-1707) and the updated destroyers *Achillies* (NCC-551) and *Ajax* (NCC-547) manage to corner a Klingon raider that had been playing havoc with Federation shipping near the Treaty Zone. The raider turned out to be the *K'teremny* class heavy destroyer *Qrish*. Confident of his greater numbers and available firepower, *Hood's* captain ordered an immediate attack in order to bring the Klingon ship to bay. What he did not expect was that he was dealing with a foe worthy of the ship he was commanding. In the disaster that followed, *Qrish* used its superior maneuverability and weapons coverage to score an undisputed victory against 3-to-1 odds. The end of the battle found the shattered hulk of the *Hood* lifeless and adrift, with *Ajax* crippled and *Achilles* suffering moderate damage. *Qrish* escaped with only minor damage.

The days of *K'teremny* as the scourge of the spaceways were numbered, however. In 2288 the Romulan heavy cruiser *Gallant Hand* single-handedly all but wiped out the Imperial 103rd Assault Flotilla in the CL-128 star system. The 103rd consisted primarily of two *K'teremny* squadrons, a *K't'inga* squadron, and associated support ships. The *Gallant Hand* had penetrated Klingon space on a retaliatory strike in response to Klingon actions several days before. Within the space of a standard hour the *Gallant Hand* had wiped out both *K'teremny* squadrons as well as the Klingon outpost at CL-128. Only the arrival of the *K't'inga* squadron caused the *Gallant Hand* to withdraw, and many Federation military analyst believe this was due more to battle damage and low power reserves on *Gallant Hand's* part than anything else. An Imperial board of inquiry later determined that this disgraceful defeat was solely the fault of the local starship commanders, whose overconfidence in *K'teremny's* capabilities was the root cause of their destruction. Improved Romulan plasma weaponry coupled with the Romulan commander's almost uncanny ability to predict when Klingon ships would drop their cloaks to fire were also cited in the report.

Although the loss was not the fault of the *K'teremny* design, this event is generally viewed as what caused it to fall from Imperial favor. *K'teremny* was quickly replaced by *Lara'atan* in the Imperial fleet procurement schedule and all standing orders for new builds were cancelled. It was not destined to end its days in the Imperial spotlight on a sour note, though,

for one last deed of greatness would be credited to *K'teremny*. In 2291 Admiral Komax, overall field commander of the Romulan Border Sector Fleet, attempted to defect in order to join with Klingon dissenter forces based within the Triangle. His flight towards the Neutral Zone in his flagship, the *Komo Val* class battleship *Komo Hesta*, was intercepted by the 281st Attack Squadron under the command of Captain Klevalt. The latter, a one-time pupil of Komax, had at his disposal a squadron of five battle-tested *K'teremny* class heavy destroyers. Klevalt put his lessons from Komax and the superior maneuverability of his force to good use against his more powerful opponent. The *Komo Hesta* was slowed up enough for Imperial reinforcements to arrive, after which it was promptly dispatched just short of the border. It was later learned that Admiral Komax was already dead by the time Imperial reinforcements arrived, allowing himself to be killed in battle with his former pupil as a matter of honor. The event did much to salvage *K'teremny's* damaged reputation in the eyes of the Klingon High Command, and it was restored to the Imperial procurement schedule the following year.

K'teremny remains one of the few major Klingon starship classes whose production has not been halted by the Praxis Event. As with the others, this is due to the fact that its manufacturer escaped serious damage from the blast. The spaceyards for Kohl Imperial Spaceworks, a minor shipbuilding firm specializing in custom designs, just happened to be in orbital opposition to the shockwave. With the bulk of a minor moon between it and the blast, Kohl suffered only minor damage to its outerworks. It was able to resume partial production almost immediately and full production within a month of the event. *K'teremny* production has been slowed due to Kohl taking on the burden of production for other major fleet classes, but it has remained continuous since the Praxis Event.

As of this date there are believed to be "about 200" or so *K'teremnys* in service, split almost equally between Imperial and House fleets. At least three unique House variants have been spotted, including of all things a modified transport/tug (possibly an impromptu shuttlecarrier conversion?). The previous pre-Event production rate of five per year, which was a far cry from its 2280s heyday, has been cut to only two due to Kohl's additional post-Event starship procurement burdens. The current production model sports several major improvements over the original, including more powerful engines, old-fashioned engine-mounted heavy disruptors (to supplement the photon torpedo batteries), and a centerline keel-mounted drone rack. These upgrades are being backfitted into older hulls as duty schedules permit.

Schematics

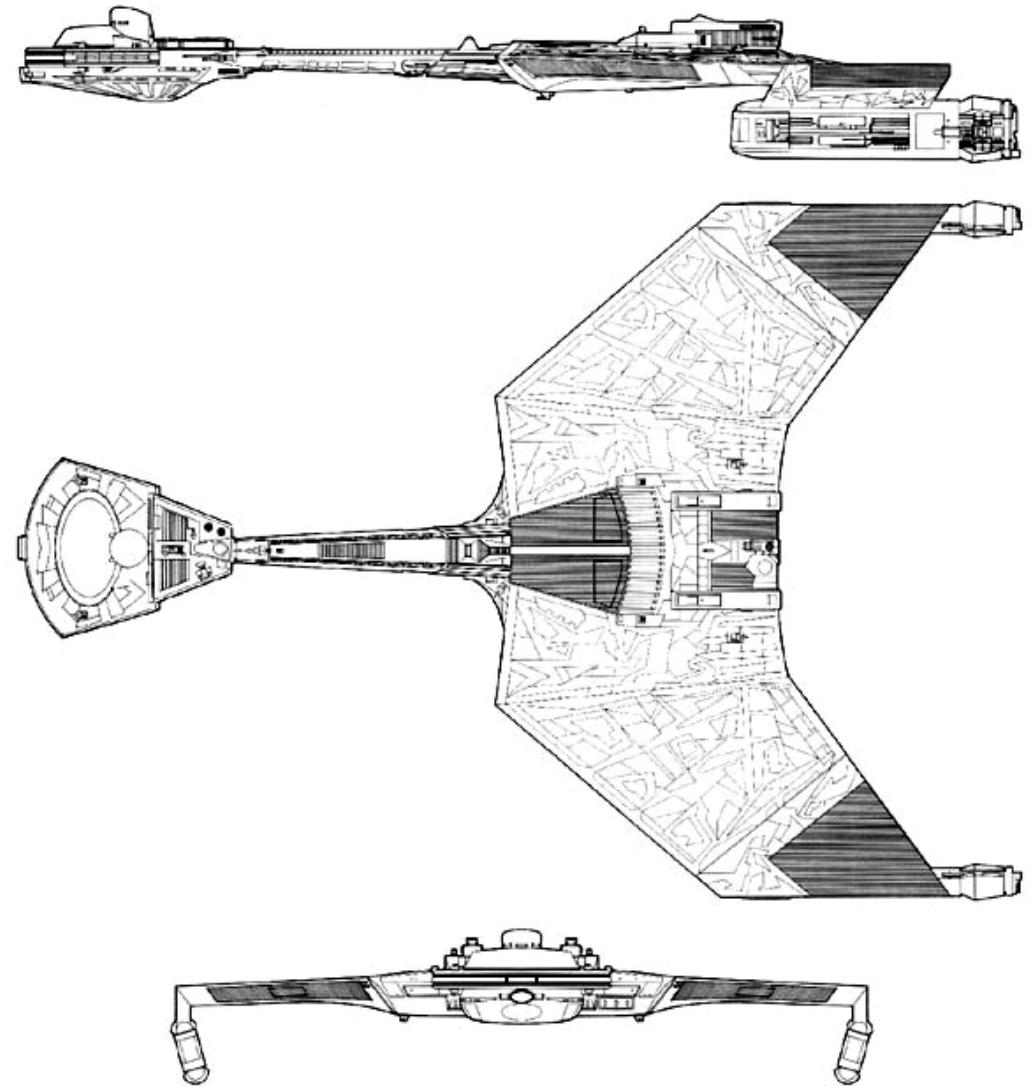

K'teremny as launched (c.2279)



***K'teremny* class Klingon heavy destroyer created by Todd Guenther
as first featured in *Starship Design* and later in the *Federation Reference Series***

**Additional background material courtesy of
Brad Torgerson, William Coley, and James Dixon**

Schematics by Todd Guenther

Visual(s) courtesy of Klingon Fanatic

K't'orr

***QawDuj* type 10 (*dakasta* type 13) [2280]**

Specifications as built

Dimensions

Length: 125.8 meters
Beam: 56.0 meters
Height: 21.3 meters

Mass

Standard gross: 258,400 GMT
Subspace displacement: 62,000 DWT

Crew complement

Officers: 20
Enlisted: 100
Imperial Guards: up to 12 (in support of assault operations)

Top velocity

Cruising speed: warp 7.0
Rated maximum speed: warp 9.0
Rated emergency speed: warp 10.0

Endurance

Standard endurance: estimated 3 years at L.Y.V.

Armament

Disruptors: 7 standard disruptors
Guided weapons: 1 photon torpedo tube



Known starships

Hull #	Name of starship	Builder	Status
KRQ10-001	<i>K't'orr (Confidence)</i>	shipyard where built	---

K't'orr was originally proposed in 2270 as a smaller class companion of *K'teremny*. The original proposal was for a replacement for the venerable *qaHos* class light cruiser, but it was reclassified as a destroyer at some point during the design study process. As with its elder sibling, *K't'orr* fell through the cracks in the Klingon procurement process, along with many other excellent designs, due largely to the politics of the day. Again, as with *K'teremny*, it took almost a full decade for the design to be authorized and to enter production. *K't'orr* production enjoyed the fallout from the wake of the Galt'nah war games of 2280, thus allowing its numbers to build rapidly.

K'torr makes for an interesting comparison with *Lecthu*, its contemporary from this period of Klingon destroyer design. There is little argument on the part of most starship experts that *Lecthu* is the more combat capable design. The one area in which *K't'orr* bests *Lecthu*, though is in *brakul* (tH. "vital organ redundancy"). *K't'orr's* origins as a *qaHos* replacement, with a design intended to perform the same type of long range, extended duration, and short supply missions, have resulted in a very durable destroyer. *K't'orr* can take the most battle damage of any current Klingon destroyer class, Imperial or House, while retaining a measure of combat capability. Its double and in some cases triple redundant systems allow it to absorb hits that would critically damage or even incapacitate larger combat vessels. In addition, its compartmentalized hull takes into account crew survival (something unique for a Klingon ship), as befitting a vessel operating on the deep frontiers of Klingon space. It has numerous sub-bulkheads that can seal off almost any section of the ship, and minimal emergency life support equipment can be found in almost every compartment. For these reasons *K't'orr* is quite popular with independent House captains, and almost every major House sports at least one three-to-six ship *K't'orr* destroyer squadron for frontier duties.

As of this date there are 236 known individual *K't'orr* hulls in the service of the Empire. The bulk of these can be found in the House fleets. They can often be found operating in concert with their *K'teremny* heavy destroyer brethren in fleet actions.



K't'orr class Klingon destroyer created by Marc Shamma'

Additional background material courtesy of James Dixon

Visual(s) courtesy of Terradhyne

tel'lw

***QawDuj* type 12 (*dakasta* type 24) [2290]**

Specifications as built

Dimensions

Length: 232 meters
Beam: 64 meters
Height: 54 meters

Mass

Standard: 665,000 GMT
Displacement: 175,000 DWT

Crew complement

Officers: 110
Enlisted: 320
Imperial Guards: up to 40 (in support of assault operations)

Top velocity

Cruising speed: warp 8
Rated maximum speed: warp 12

Endurance

Standard endurance: estimated 6 years at L.Y.V.

Armament (*)

Disruptors: 12 standard disruptors (see description)
Guided weapons: 2 uprated? photon torpedo tubes (1 ea. F/A)
Other: cloaking device

(*) Reflects mix observed by intelligence sources.



Known starships

Hull #	Name of starship	Builder	Status
KRD08-000	<i>Kleev (Bloodwing) - prototype</i>	Klinzhai Imperial Shipyards	active
KRD08-001	<i>tel'lw (Bloodwing)</i>	Klinzhai Imperial Shipyards	active
KRD08-002	<i>quyot'lw (Bloodbath)</i>	Klinzhai Imperial Shipyards	active
KRD08-003	<i>Soplu'lw (Blood Feast)</i>	Klinzhai Imperial Shipyards	building

tel'lw is the first new starship design to enter Imperial service since the Praxis Event of 2293. At first glance it would appear to be little more than a well-designed cross between *Lara'atan* and *K'teremny*, with a little *Hegh daS* thrown in for good measure. Unfortunately, as the only information available on *Tel'lw* so far comes from intelligence reports and third-party data, no firm assessment can yet be made of the design.

tel'lw shares one important asset with the older and larger *Komo Val* if the reports are true. A portion of its disruptor banks is always available for firing at any angle due to continuous coverage arcs. In *tel'lw's* case six disruptors are available, two more than *Komo Val*. *tel'lw* also appears to continue the trend started by *Hegh daS* in the use of updated photon torpedoes as well as the deletion of the traditional *pljonta'*-mounted heavy disruptors.

One report indicates that *tel'lw* was based on a design submitted by a Klingon named Kleev. Little else is known about Kleev save that he is a recent addition to the Jevghom Design Bureau and was one of the youngest ever admitted to its membership.

Starfleet Intelligence is tentatively classifying *tel'lw* as a heavy destroyer, based on its apparent loadout similarities to *K'teremny*, until more data becomes available.

(rewrite – improved production version of the *Kleev* prototype battlecruiser – many design similarities to the *Hajwe'* class strike carrier – replaced the disgraced *K'teremny* on the heavy destroyer production schedule)



***Kleev* class Klingon heavy destroyer created by Don “Cleeve” Woligroski for the *Starfleet Command* series of videogames by Activision Games**

Additional background material courtesy of Don “Cleeve” Woligroski and Taldren

Images courtesy of Terradyhne

ЗЕФЕУ

Frigates

Ikah'kon (Kl. “Seeker of Victory”),
fuwikh (Kl. “Small Vessel”) and
SuvwIDuj (tH. “Warrior’s Vessel”) series

Frigates

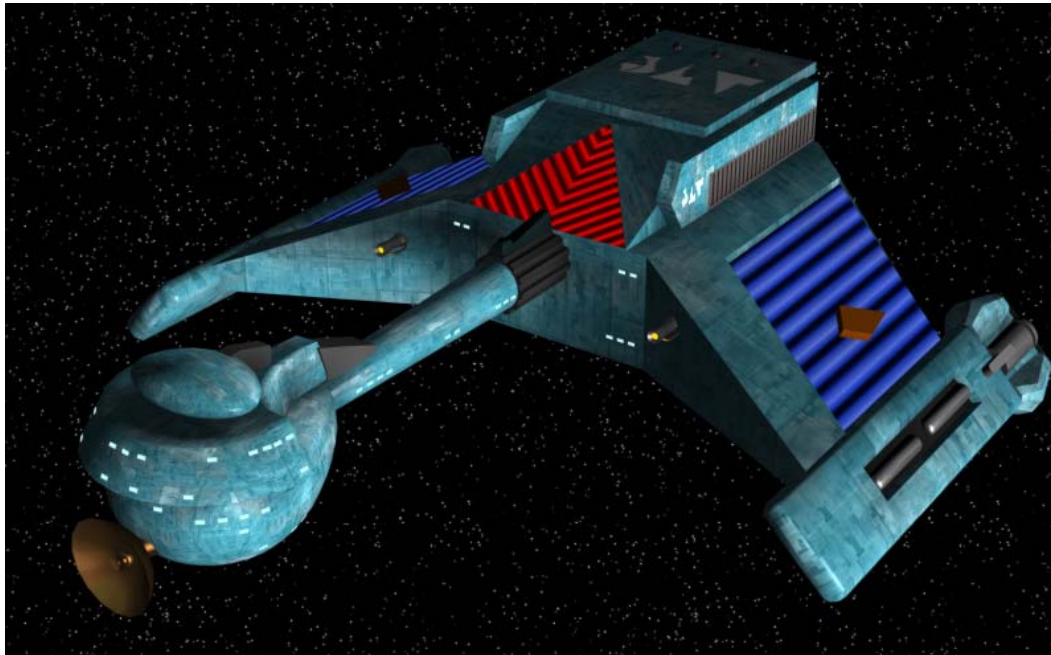

A *Kuve* in its pre-modern configuration, c.2250

Frigates are by far the most numerous type of vessel in the Klingon fleet. They are in effect Klingon light cruisers optimized for the combat role. “Battlecruiser lite” is the way some Terran military publications describe them, and the description is an apt one. Indeed, some of the newer Klingon *Ikah’kon* type heavy frigates are as powerful in terms of firepower as their battlecruiser brethren, lacking only the latter’s range and durability in extended battles.

There are two reasons why frigates make up the bulk of the Klingon fleet. First and foremost the reduced hull form (Kl. *fuwikh*, “small starship”) of typical frigates means that they are relatively cheap and easy to produce. Every major shipyard within the Empire and almost all of the minor ones produce at least one frigate class. Their inexpensiveness means that

frigates are also produced in quantity, in one form or another, by every House with the resources to build them. Second, Klingon frigates are vessels designed to bring maximum glory to their commander (and Houses of ownership) with minimum effort. This is from where the modern Klingon term for a heavy frigate, *Ikah’kon* (Kl. “Seeker of Victory”) originates. In short, a Klingon frigate is a combat-capable starship that can deliver maximum impact with minimum crew and resources. In this kind of environment the lion’s share of glory in battle almost always goes to the frigate’s commander.

It is small wonder then why frigates are so popular with Klingon ship captains. His command (or in infrequent cases *hers*) is very much “his ship” in almost every sense of the word. His House provided it to him, or in some cases he (or she) might have procured it himself. His crew is usually handpicked, perfectly suited both to his vessel and his personal whims. He and his crew know their frigate like the back of their hand, much as did Terran U-boat captains during that planet’s Second World War. Together, his crew and his ship provide capable Klingon frigate captains with an almost perfect interstellar combat machine that is the epitome of Klingon battle doctrine: swift, deadly, and efficient.

Kuve

***SuvwiDuj* type 1 [*fuwikh* type 5] [2177]**

Specifications as built

Dimensions

Length:	92 meters
Beam:	68 meters
Height:	38 meters

Mass

Standard gross:	72,800 GMT
Subspace displacement:	26,500 DWT

Crew complement

Officers:	19
Enlisted:	116
Imperial Guards:	none (*)

Top velocity

Cruising speed:	warp 4.0 (*)
Rated maximum speed:	warp 7.0 (*)

Endurance

Standard endurance:	estimated 2 years at L.Y.V. (*)
---------------------	---------------------------------

Armament

Disruptors:	5 standard disruptors (2 F, 3 omni) (*) 2 heavy disruptors (F only) (*)
Guided weapons:	none (*)
Other:	none (*)

(*) Dependent on level of customization. Listed values are for the stock production model (c. 2177-2270). All surviving *Kuves* in the service of the Empire were backfitted in the 2270s with modern weapons systems, modern *pljonta'*, and cloaking device technology. Many Imperial *Kuves* at that time also received a single forward-mounted photon torpedo system via a new command boom. Hull forms for refitted *Kuves* are slightly different than pre-refit models.



Known starships

Hull #	Name of starship	Builder	Status
KRF05-0001	<i>Kuve (Faithful Servant)</i>	Klinzhai Shipyards	---

No starship in the Klingon fleet has seen as much use, been in as many battles, undergone as many modifications and upgrades, or proven itself as versatile over the decades as the venerable *Kuve* class frigate. It is one of the oldest of all Klingon starship designs still in use, having faithfully served the Empire for over 120 years, and it will undoubtedly continue its service for as long as its spaceframe lasts.

The Klingon Imperial Fleet was not as complicated back in the days of the 22nd century as it is now. There were only five major fleet combatant classes at that time: cruisers, frigates, scouts, escorts, and patrol ships. The E/F-series space frame was developed by Klinzhai Shipyards in 2175 as a means of securing both the frigate and escort construction contracts. Both classes would be built on the same base frame, with Klinzhai's escort design (*Sekleth*) being little more than a slightly reduced version of its frigate (*Kuve*). The proposal quickly won approval from the High Council, due largely to its project low production costs, and an initial contract for 100 frigates and 225 escorts was granted to Klinzhai in 2176. Klinzhai was the primary contractor but a standard sub-clause granted it authority to subcontract work "to all other shipyards within the Empire as need requires." Little did the High Council of that era foresee that by the turn of the century every single shipyard within the Empire, both major and minor, would have at least one section devoted to Klinzhai E/F-series production.

Klinzhai's design proved to be an immediate success with both the Imperial fleet and the various House factions. It was a sturdy design, well armed for its size with sufficient power for all on-board systems, and just large enough for customization by those Houses that desired so. Demand for E/F series vessels soared accordingly, so much that by the time of the Sentry Incident in 2218 there were over a thousand *Kuve* class frigates and *Sekleth* class escorts in the service of the Empire. By the dawn of the modern starship era *over three thousand E/F series hulls* had been produced by the Klingon Empire – the largest such production run on record.

The aging *Kuve* was finally replaced by *pIH* on the Imperial production schedule in 2270. This did not preclude its removal from service, however. Sheer numbers alone dictated that *Kuve* was not going anywhere soon; plus its usefulness was proven. It had been adapted for practically every mission profile on the Imperial roster for a starship of its size, not to mention more than a few unconventional ones. It was easy to maintain and its design invited upgrades, as opposed to others of its contemporaries (such as the *bortaS* class cruiser). Also, to this date *pIH* has yet to gain the stature that *Kuve* had already won in the hearts and minds of Klingon warriors across the Empire. In fact, *B'rel* is the only modern starship design

of comparable class that has come close to matching *Kuve*'s reputation; however, the limitations of its hull render it incapable of the many variations for which *Kuve* has become legend.

There are 119 documented unique variations and customizations of the basic *Kuve* design. It currently holds the Klingon record for specialized variations, with only the newer *pIH* coming close at 62 (to date). Included among these are auxiliary carriers, priority transports, "drone" frigates (aka fire support vessels), penal frigates, research ships, stasis generator equipped frigates, various weapons system testbeds, various "battle" frigates (sporting a third *pljonta*), various "attack" frigates (with *B'rel*-type disruptor cannon), and so on. These are just the tip of the *Kuve* iceberg. For a complete listing of all 119 unique *Kuve* variants, along with a discussion of their merits, readers are recommended to consult *Jaynz' Guide to the Klingon Kuve*. It is considered by many to be the definitive Federation work on the subject. The full version is available for midshipmen through the Starfleet Academy Intranet; while a terser unclassified version is available for free via the civilian FedNet.



Kuve class Klingon frigate created by Steven V. Cole
for Amarillo Design Bureau's *Star Fleet Battles* role-playing game

Additional background material courtesy of Amarillo Design Bureau,
Activision Games, Klingon Fanatic, and James Dixon

Visuals courtesy of Battleclinic.com

Th'lar

SuvwiDuj'a' type 2 (Ikah'kon type 6) **[2249]**

Specifications as built

Dimensions

Length: 200 meters
Beam: 120 meters
Height: 42 meters

Mass

Standard gross: 490,500 GMT
Subspace displacement: 123,000 DWT

Crew complement

Officers: 40
Enlisted: 295
Imperial Guards: up to 320 (in support of assault operations)

Top velocity

Cruising speed: warp 7 (8 after upgrade)
Rated maximum speed: warp 10 (12 after upgrade)

Endurance

Standard endurance: estimated 2 years at L.Y.V.

Armament

Disruptors: 2 standard disruptors (4 F, 2 A, 1 F/P, 1 F/S)
2 heavy disruptors (F only)
Guided weapons: 2 photon torpedo tubes (upgrade, 1 ea. F/A)
cloaking device (upgrade)



Known starships

Hull #	Name of starship	Builder	Status
KRL06-001	<i>Th'lar (Defender)</i>	Kodal Imperial Spaceworks	active

Th'lar was the first of the Klingon heavy frigates (Kl. *Ikah'kon*, tH. *SuvwiDuj'a*). These came about in response to the new Federation frigate classes of the 2240s and 2250s. These had produced a whole new generation of Starfleet vessels, in particular the *Loknar* class frigate, that were superior to their Klingon counterparts. The Kodal Design Bureau developed *Th'lar* in response to High Command requirements for a new ship type – a so-called “heavy frigate” that could best the *Loknar* in any one-on-one encounter.

Starfleet first became aware of the *Th'lar* as a result of the *Eylau* Incident, which is known to Klingon historians as the Battle of Falgor. On 12 February 2252 a Federation border patrol fleet consisting of the destroyers *Eylau* (NCC-4317) and *Jutland* (NCC-4328) encountered what appeared to be a Klingon battlecruiser of unknown configuration (in truth a *Th'lar*) attempting to penetrate the border near the Falgor star system. The unknown vessel's apparent power was far above that of either of the two Starfleet destroyers acting alone. Captain Archibald Mason, commander of the *Jutland* and the senior Starfleet officer on the scene, immediately ordered both ships to engage the Klingon vessel and dispatched a priority call for assistance to the frigate *Proxima* (NCC-2713), a *Loknar* class frigate and the closest other Starfleet unit in the area. On its first salvo the Klingon ship disabled the *Eylau* and shook off the *Jutland's* first salvo as it turned to engage. *Eylau* managed to return fire with its remaining weapons while the Klingon was closing on the *Jutland*, disabling one of its warp engines. At that point the Klingon ship whirled about with amazing agility and cut loose with a second deadly salvo at point blank range. Multiple explosions tore through *Eylau's* hull as it spun away, out of control, from the battle. At the same time *Jutland* was attempting to close the gap and come to *Eylau's* rescue but the Klingon's weapons had greater range than its own. All it succeeded in doing was coming in range of the Klingon vessel, which wheeled about and delivered a devastating volley of standard and heavy disruptor fire. *Jutland's* forward shields collapsed and it took major damage to its primary hull, forcing it to break off its attack run.

Fortunately at that point the *Proxima* arrived on the scene and promptly opened fire with all weapons. The Klingon's starboard quarter shields were penetrated and it took major phaser and photon torpedo hits to its engineering hull. What the commander of the *Proxima* did not expect was that the Klingon would have aft-firing disruptors and it returned fire, penetrating *Proxima's* shields and scoring a direct hit on its bridge. By that time, however, *Jutland* had sufficiently recovered to rejoin the fight, having closed to weapons range and opening fire once more. The Klingon promptly went to warp and accelerated out of the area, leaving *Proxima* and the damaged *Jutland* behind. They promptly begin rescue operations at the still-burning wreck of the *Eylau*. The shattered hull of the destroyer

was declared a complete loss and scuttled on the spot after it was evacuated of all remaining crew, bodies of the dead, and personal effects. Out of a crew of 198 there were only 43 survivors. Lt. Commander Norosk, the *Eylau's* Andorian chief engineer, was the senior surviving officer.

The design of *Th'lar* is essentially a *Klolode* with a swept-forward secondary hull. This deliberately introduces instabilities into its warp field geometry that, when properly manipulated, results in its incredible acceleration and agility. The design has proved to be quite successful and has since been copied onto other designs, most notably the production version of the *Suvwi'QeH* command cruiser. The swept-forward design also allowed *Th'lar* to be fitted with less powerful engines than *Klolode* (those from the *Hak'hyl* and *Dupat*, in fact) while retaining its edge in both acceleration and maneuverability. The only drawback to their use, of course, was reduced top speeds and available power for maximum weapons and shield usage. The end result was that *Th'lar* was widely considered to be underpowered despite an impressive combat record – an issue that was rectified during a fleetwide refit for both Imperial and House *Th'lars* during the 2270s. At this time *K't'inga*-type *pljonta'* were installed, along with a modified *Klolode* style deflector grid and fore/aft photon torpedo systems. These considerably increased the combat potential of *Th'lar* at the expense of added strain on its swept-forward engineering hull. In later battles, uprated *Th'lars* have been known to disintegrate during fierce combat from seemingly minor hits due to this increased structural instability.

One unique aspect of *Th'lar* is its onboard provision for three full companies of Imperial Guards along with their command staff, field equipment, two troop transporters, four light assault craft, and two assault shuttles. *Th'lars* are frequently employed in support of ground assault operations, usually as primary escorts of an assault ship task force. In this manner they can both support planetary operations with their own troops while at the same time defending the assault force from attack while in orbit. This capability also has other uses. *Th'lars* are frequently employed in the commando cruiser role, striking selected ground targets on commando missions or engaging in protracted boarding party missions against enemy craft, space stations, and starbases. This has obviated the need for commando cruiser conversions of existing Klingon craft, even though some Houses are known to still do this anyway. It has also forced the many enemies of the Klingons to come up with similar craft of their own to combat this threat that *Th'lar* poses, either by conversion or dedicated construction.

All *Th'lars* already in Imperial service were equipped with cloaking devices as part of their 2270s refits. It comes as standard equipment on

new construction. Conversion of existing House *Th'lars* has proceeded at a somewhat slower pace, with some in the service of the Lesser Houses having yet to receive a cloaking device.

The unique design of *Th'lar* has precluded extensive modifications and conversions outside of the 2270s refit, although such are not unknown. In almost all cases these usually come at the expense of the onboard Imperial Guard facilities. At least one shuttlecarrier conversion is known, as well as two slightly different fire support ships (i.e. “drone cruisers”), a stasis generator equipped version, and a priority armed transport. It is also quite common for the Houses to operate their *Th'lars* as dedicated assault ships as opposed to purchasing true assault ship designs, such as the *Thala* series (tH. *NeghDuj*) used by the Imperial fleet. Such a practice precludes extensive *Th'lar* modifications, as doing so would significantly decrease House assault ship capabilities.

Th'lar has remained in continuous production since its introduction in 2249. At last report “about 300” hulls are believed to have entered service, with “about 50” destroyed in various border conflicts with the Romulan and Cardassians over the years. The rest can be found on every border of the Klingon Empire. It is the premiere starship class to be produced by Kodal Imperial Spaceworks, a firm whose location outside the Klingon home systems allowed it to escape the Praxis Event of 2293 completely unscathed. Since that time Kodal has taken on the added burden of other classes whose contractor’s spaceyards were ravaged by debris from the Praxis Event.

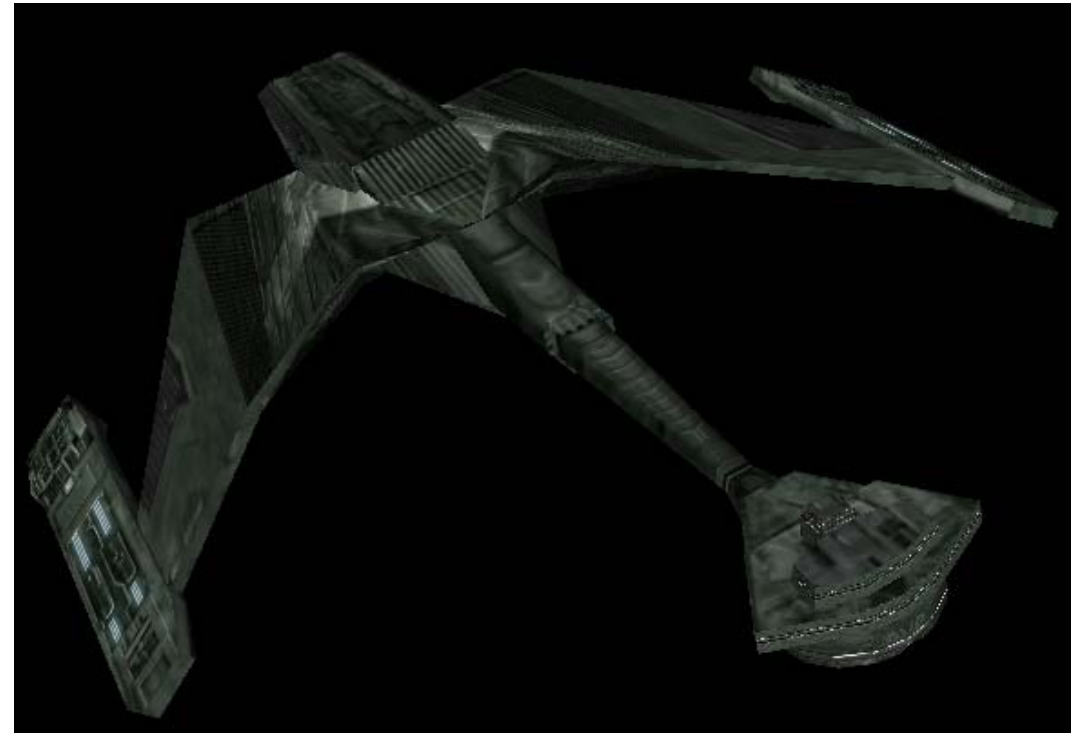

Th'lar class Klingon frigate
created by Forrest G. Brown and Dana Knutson
for *STAR TREK – The Role-Playing Game* by FASA Corporation

Additional background material courtesy of Brad Torgerson

Visual(s) courtesy of Paul Brown, Tyrel Lohr, and GhostFox

Sivista

***SuvwIDuj'a'* type 3 [*Ikah'kon* type 9]** **[2270]**

Specifications as built

Dimensions

Length: 224 meters
Beam: 106 meters
Height: 50 meters

Mass

Standard gross: 600,000 GMT
Subspace displacement: 150,000 DWT

Crew complement

Officers: 63
Enlisted: 337
Imperial Guards: up to 300 (in support of assault operations)

Top velocity

Cruising speed: warp 9
Rated maximum speed: warp 12

Endurance

Standard endurance: estimated 3 years at L.Y.V.

Armament

Disruptors: 8 standard disruptors (2 F, 2 A, 2 ea P/S)
2 heavy disruptors (F only)
Guided weapons: 2 photon torpedo tubes (1 ea F/A)
Other: cloaking device



Known starships

Hull #	Name of starship	Builder	Status
KRL09-001	<i>Sivista (Fastsword)</i>	Taamar Shipyards	active
KRL09-002	<i>Yan (Broadsword)</i>	Taamar Shipyards	active
KRL09-003	<i>meqleH (Half-Battleth)</i>	Taamar Shipyards	active
KRL09-011	<i>ja'chuq (Rite of Succession)</i>	Fonawl Shipyards	lost
KRL09-016	<i>nentay (Rite of Ascension)</i>	Fonawl Shipyards	active
KRL09-021	<i>Sonchly (Rite of Passage)</i>	Fonawl Shipyards	missing
KRL09-054	<i>chu'wl'a' (Hair Trigger)</i>	Gnuu Re' Shipyards	lost
KRL09-083	<i>Sud Dun'a' (Extreme Risk)</i>	Gnuu Re' Shipyards	active

Before the imposing *pumwl'* entered Imperial service, there was another starship design by which the Jevghom Design Bureau first became known. It is widely considered to be the best *lkah'kon* the Empire has ever produced, as well as being one of the most fearsome combat starships in its long and storied history. Only its unusual design and its cost have kept it from entering Imperial service in greater numbers than now exist. It was ahead of its time, being on the edge of the Taldren generation (tH. *puqpu' thIDrn*, i.e. "children of my insight") that have since gone on to form the core of the modern Klingon Imperial Fleet. It is perhaps fair to say that had not *Sivista* come first, then *pumwl'* and other many other modern Klingon starship designs might not have followed in its wake.

In 2266 the Jevghom Design Bureau met to discuss the latest reports handed down from Imperial Sector Intelligence. The Federation, it seemed, was fully prepared to match the upgrades that were being planned for the Klingon fleet, ship-for-ship, with a massive upgrade program of its own. This meant that the already powerful Federation starships built during the past two decades would become even more powerful. There were only a handful of current Klingon starship classes that could hold their own against Starfleet's best, and these would almost certainly have trouble against uprated designs until they themselves could be uprated. What was needed was a new combat starship, a vessel that could beat anything the Federation could put in the field within the next two decades. This would allow the Empire to ensure its borders while gaining the time necessary to complete its own fleetwide upgrade program. By the end of the year final plans were drawn up and simulation testing complete on *Sivista*. Both the Klingon High Command and the High Council approved the design the following year, with an initial construction contract for 32 hulls awarded to Taamar Shipyards, out of which Jevghom was based. Chancellor Kessa was particularly enthusiastic about *Sivista*, noting the design's combat capabilities and openly expressing the hope that it would be ready for the war he was planning with the Federation. Kessa's impatience got the better of him, though, with the so-called Four Days War breaking out over the planet Organina only days after he had signed off his final approval on *Sivista's* construction. The Organians themselves soon put an end to the conflict on both sides. Kessa himself committed ritual suicide for being so dishonored by "those Organian *pugh*." *Sivista* entered service three years later – too late for the war for which it had originally been authorized. This would not preclude it from future action against the ships of Starfleet and other enemies of the Empire.

Coincidentally, *Sivista* was built at the same time as *plH*. Both were classified as frigates (tH. *SuvwIDuj*) at the time of their entry into Imperial

service. At the same time, however, it was quite obvious that they were very different ships. *plH* was a natural follow-up to the aged *Kuve*, whereas *Sivista* was as large as a *Drell*-type battlecruiser. It is easy now to forget that *Sivista* was originally authorized as a "super *lkah'kon*" (tH. *SuvwIDuj'a*): a follow-up to *Th'lar* that would be able to easily best its opposite number in the Federation Starfleet.

Although most consider it one of the last of the Kessa Program starships, *Sivista* is considered by some starship historians to be among the first of the so-called "Taldren generation" (tH *puqpu' thIDrn*). Its unique design reflects the same level of innovation and ingenuity that typify Taldren-style Klingon starships. Its hull, with its angular structure and twin underhull *pljonta'*, was designed in such a way as to be deliberately unstable in flight. This required a sophisticated ship's computer system, the most powerful the Empire had ever installed on a starship, to be fitted to *Sivista* in order to maintain its flight control systems. The advantage gained was enormous. With its tendency to want to tumble and roll in almost any direction *Sivista* gains the maneuverability of a *Kuve*, its small and nimble ancestor, on a hull the size of *Th'lar*, its immediate predecessor. *Sivista* commanders and crews have to be specially trained to handle its flight control systems, but those that master it have gone on to become legends in their own time. *Sivista* can outmaneuver any other ship-of-the-line fielded by any other major interstellar power of the same (or larger) relative size and mass, as well as many of the smaller ones. Since its introduction in 2270 it has won 84% of all of its combat encounters, which is the highest rating of any starship class in Imperial service. Only the high costs associated with the design and its custom flight control systems prevent it from serving the Empire in greater numbers than currently exist.

Within Starfleet *Sivista* has earned the nickname of the Crouching Tiger. This is in reference both to its appearance, with its tucked-in *pljonta'*, and its formidable combat capability. Starfleet counts *Sivista* as the single most difficult modern Klingon capital starship design to defeat in a one-on-one encounter.* It can literally fly rings around every Starfleet capital ship class, from escort all the way up the line. The only sure way to gain an advantage, other than sheer firepower, is to somehow damage or disable *Sivista's* flight control systems. This is a difficult prospect, though, given that the ship's main computer core is not only buried at the heart of its secondary hull but also has its own dedicated shielding system (consisting of armored bulkheads and energy screens) that was designed for such an occasion. Short of a miracle, then, the only real way to defeat a *Sivista* in a combat encounter is to out-think its captain.

Only 141 of a planned total 193 *Sivistas* had entered service when the Praxis explosion of 2293 tore through the Klingon inner systems. The

event brought a halt to further construction. *Sivista* production facilities at Taamar and Fonawl, two of the three primary contractors for the class, were badly damaged during the event. The Klingon High Council ordered the remaining *Sivista* contractor, Gnuu Re' (located beyond the inner systems) to temporarily halt production as it directed badly needed resources elsewhere. The contract was suspended indefinitely in 2296 and revoked the following year. *Sivista* thus became a victim of economic necessity despite its excellent combat record. An updated design is reportedly under consideration for renewed production, once the Empire recovers sufficiently, "sometime around 2310."

Z'gal Shipyards was the primary subcontractor of *Sivista* command booms. Boom production still continues for custom upgrades of compatible craft, such as *Drell*-derived hull types and selected hulls of the Taldren generation.

Only 18 of the 141 *Sivistas* built have been lost. All but two were combat losses against superior opponents or during fleet actions; the last two are listed simply as "missing." Of the remainder 66 are in Imperial service and the rest split up among the various Houses, with the Greater Houses having the majority. At least one (*Sud Dun'a*) serves as the flagship of House Sang, one of the more notable of the Lesser Houses.

The name *sivista* (Kl. "fastsword") comes from a traditional Klingon combat sword popular with the Houses in the northern hemisphere of Q'o'nos. *Sivistas* were individually tailored according to the whims of the Houses that forged them; however, all shared the following in common. *Sivistas* were somewhat smaller and slimmer than the *yan* of the southern hemisphere Houses, their blade averaged 3.5 times longer than the hilt, they were double-edged after the fashion of a Terran Sheffield Bowie, and the upper quillon curved toward the blade while the lower bent back towards the grip. On some *sivistas* the lower quillon extended back towards the pommel in the form of a D-guard, while on others it was part of a true D-guard. All Klingon warriors learn the use of the *sivista*, along with the *yan*, *betleh*, and many other blades, as part of their basic blade weapons training. On dress occasions where a sword is required, the smaller *sivista* is preferred over the larger *yan* as a matter of convenience.

(*) *B'rel* is actually the most nimble of all Klingon capital ships; however it lacks *Sivista's* weaponry and all-around weapons coverage.



Sivista class Klingon frigate
created by Forrest G. Brown and Dana Knutson
for *STAR TREK – The Role-Playing Game* by FASA Corporation

Additional background material courtesy of Brad Torgerson
and Taldren (Activision Games)

Sivista description based on the Klingon swords used by Worf and K'Ehleyr
in the *STAR TREK – The Next Generation* episode "The Emmisary"
and on material written by John Ford for *The Final Reflection*

Visual(s) courtesy of Paul Brown & Tyrel Lohr (mesh) and Matt Hattfield (model)
Model image courtesy of Griffworks

***SuvwiDuj* type 4 [*Ikah'kon* type 10]** **[2270]**

Specifications as built

Dimensions

Length: 153 meters
Beam: 70 meters
Height: 40 meters

Mass

Standard gross: 455,000 GMT
Subspace displacement: 117,000 DWT

Crew complement

Officers: 7
Enlisted: 23
Imperial Guards: up to 15 (in support of assault operations)

Top velocity

Cruising speed: warp 7.0
Rated maximum speed: warp 9.0

Endurance

Standard endurance: estimated 3 years at L.Y.V.

Armament

Disruptors: 4 standard disruptors (2 ea. F/A)
2 heavy disruptors (both F)*
(other varies depending on configuration)
Guided weapons:
Other: cloaking device
(other varies depending on configuration)

(*) This represents the yard standard *PIH* assault frigate configuration. These are commonly deleted in most *PIH* modifications in order to free up the ship's roll bar for other systems.



Known starships

Hull #	Name of starship	Builder	Status
KRL12-001	<i>PIH (Suspicious)</i>	Graltha Shipyards	active
KRL12-357	<i>Dochok qlp (Fist of Dochok)</i>	Graltha Shipyards	active

pIH is the Empire's "throwaway ship." It was designed to be cheap and quick to build, thus giving the Empire the capability of quickly swelling or replenishing its ranks in time of war. It entered service in 2270 within months of the larger and more capable *Sivista* and thus shares certain design features, most notably its slab-sided hull and boxy command boom. These features have earned *pIH* the unofficial nickname of *loDnI'Daj jIv'Sta* (tH. "brother of *Sivista*). Despite this tag, and the fact that both vessels are classed as frigates, *pIH* is quite a different starship than *Sivista* – a difference that comes from more than just size alone.

In 2265 Chancellor Kessa commissioned Hogh Balth of House Birok'ken to come up with a successor to the legendary *Kuve* class frigate. At that time *Kuve* was the best and most capable "small" frigate in the Empire's starship inventories, yet it was also the oldest frigate class in service. Anticipating high losses, Kessa wanted a new design on hand to rebuild the frigate ranks in the Imperial fleet during the war he was planning against the Federation at that time. The new frigate had to be cheap and easy to build, capable of being produced in large numbers, and (most importantly) retain the *Kuve's* capability for role specific customizations. Hogh Balth's solution was a first in Klingon starship design history and has since become known as the Balth modularized hull.

Using an inverted *Lecthu* as the basis for his new design, Balth reworked the interior of the secondary hull so that as many essential systems and power conduits as possible ran along its upper sections and central core. This freed up a considerable amount of space between the core and the *pljonta'* support pylons. Into this space were fitted modular hull section mounts, one in each "wing" of the secondary hull, which could be inserted and removed from the keel. Reconfiguring Balth's new frigate design for a specific role (auxiliary carrier, ELINT, fire support, troop or cargo transport, etc.) or mission type would be a simple matter of removing and installing the appropriate hull modules. These could even be mixed, with one each of different types, if the mission so required. Balth also moved his new ship's heavy disruptors from their traditional mounts on the front part of the *pljonta'* to a new secondary hull "roll bar," where they could be changed out and be replaced with others compatible with the ship's power systems with minimal effort. This feature was inspired by a similar system used on the Federation's successful *Miranda* class cruiser.

Balth's new frigate design was named *pIH* (tH. "Suspicious") after a famed *Kuve* that had been lost in battle with Federation forces during the short-lived Organian Conflict of 2267. The class prototype was completed in 2268, with full scale production commencing the following year. *pIH* proved such a success that it replaced all other frigates save the *Sivista* on the Imperial fleet procurement schedule within a decade of commencing production. It would also make Hogh Balth a legend within the Klingon

starship design community, one that would be remembered by Kessa's successor Lotar once it came time to rescue the Empire's battleship program from its quagmire.

It took four more years for *pIH* to prove its worth to skeptical Klingon warriors. This happened during the Torana Conflict with the Romulans in 2274. A Romulan fleet had captured several key systems in the Triangle close to the Klingon border. They then launched an attack on the nearest Klingon border fleet in order to ensure that the Klingons did not get any ideas about trying to reclaim the systems in question. The Romulan fleet managed a stunning victory in its first battle with regular Imperial fleet units, with most of the Klingon capital ships in the area destroyed or badly damaged. The Klingon High Command had to call in fleet elements from other parts of the border in an effort to stem the tide. Graltha Shipyards was the nearest major facility that could service capital ships and soon found itself inundated with dozens of damaged Imperial and House vessels. At the same time it was working to repair the larger ships, Graltha began churning out *pIH* class frigates as fast as it could. Seventeen had entered Imperial service, being immediately dispatched to the trouble zone, by the time the Klingons had recovered from the initial Romulan advances. These seventeen *pIHs* helped turn the tide of battle in favor of the Klingons, who not only restored the border but also eventually reclaimed one of the Triangle worlds that the Romulans had attempted to seize. Amazingly, eleven of those seventeen *pIH* class frigates were new builds, going from keel laying to launch within four months (as opposed to the normal nine) in order to join the fight. The speed at which these vessels were built remains a Klingon record for a major combatant starship class to this day.

The Klingons themselves described *pIH* as "suspiciously unsuccessful" when it first entered service. This was both a play on the class name and a telling comment as to its greatest limitation. It was woefully underpowered, fielding the same class of *pljonta'* as the despised *Kortak* class destroyer. This meant that in combat situations *pIH* captains had to decide if they wanted shields and standard disruptors or shields and heavy disruptors, but not all three at once. Doing so would overload the engine, leaving them helpless and unprotected against any foe. Within three years *pIH's pljonta'* had been upgraded to the same used on *Sivista*, finally giving it enough power to use all three systems in combat (albeit barely so). This new *pljonta'* was what made possible *pIH's* success during the subsequent Tomara Conflict.

The modular design of *pIH*, plus its two roll bar hard points, means that it has an even greater potential reconfiguration capabilities than does the older *Kuve*. As matters stand now *pIH* is well on its way to surpassing *Kuve's* record for the most variations on record, with 62 total Imperial and

House conversions and customizations recorded to date (*Kuve* has 119). The three *pIH* variants most commonly encountered are the stock assault frigate, with its dual heavy disruptor cannon and extra auxiliary power generators; the stock fleet scout, which also doubles as a science probe vessel and requires a special “bridged” double module for its extensive sensor array; and a fast armed transport version that sees frequent use as a priority courier vessel in contested areas. Both of the latter two variants have had their heavy disruptors removed – the fleet scout to make room for more sensors and the transport to lighten the load for more cargo. Three less common but still noteworthy variations are the fire support frigate, fielding two assault modules fitted with multiple drone racks; the auxiliary carrier, which trades both heavy disruptors for two drone racks and adds a half-squadron of fighter shuttles; and the stasis frigate, which trades both heavy disruptors and both hull modules for a single stasis field generator (and associated support systems) for use in fleet actions. Three of the most notable House customizations are the commando transport (House Duras), replacing the heavy disruptors with standard ones and fielding two troop transport pods for quick-strike troop actions; the heavy frigate (House Kinzan), an experimental design that trades both heavy disruptors and both hull modules for a single FMPA generator system; and the “heavy photon frigate” (House Duchok), fitted with two forward-firing photon torpedo tubes on its roll bar and two heavy photons inside oversized custom hull modules.

Dochok qlp, House Duchok’s “heavy photon frigate” *pIH* customization deserves special mention because it exceeds the hull stress limits of the *pIH* design. It has reportedly required the installation of a dreadnought-sized *pljonta’* (for the power requirements involved) and additional frame bracing in order to keep from tearing itself apart whenever a heavy photon torpedo is fired. Even with these modifications *Dochok qlp* is known among the Houses for its pronounced “recoil roll” to whichever side of the ship has just fired a heavy photon torpedo. This is a weakness that has often been exploited in Klingon war games exercises among the House fleets. *Dochok qlp* is frequently cited as a prime example of the problems inherent in fitting heavy photon torpedoes to small starship hulls. No other such customization has been attempted since on a frigate-sized hull.

pIH, the lead ship of its class (pictured to the right), was converted to a long-range scout in 2273. It was frequently used as a deep probe vessel in this role in both the intelligence gathering and interstellar survey roles. It is believed to be currently assigned to the Empire’s coreward borders on a long-term survey mission whose nature remains undisclosed.



***pIH* class Klingon frigate created by Taldren (Activision Games) for the *Klingon Academy* and *Starfleet Command* series of licensed videogames**

Inspired in part by the *Kuve* class frigate created by Steven V. Cole for Amarillo Design Bureau’s *Star Fleet Battles* role-playing game

Additional background material courtesy of Activision Games, Donald Burns, and the *Klingon Academy* Forums

Visuals courtesy of Taldren

ᐅᓴᓴᓴᓴᓴᓴ
Scouts

sirexa (Kl. “Territorial Surveyor”) and
ghoqDuj (tH. “The Ship With Eyes”) series

Hla'bah

***ghoqDuj* type 1 (*sirexa* type 1) (2130?)**

Specifications as built

Dimensions

Length: 100 meters
Beam: 60 meters
Height: 18 meters

Mass

Standard gross: 125,000 GMT
Subspace displacement: 43,000 DWT

Crew complement

Officers: 2
Enlisted: 10
Imperial Guards: none

Top velocity

Cruising speed: warp 5.0
Rated maximum speed: warp 5.5

Endurance

Standard endurance: estimated 1 year at L.Y.V.

Armament

Disruptors: 2 standard disruptors (both F)
Guided weapons: 1 photon torpedo (F)
Other: cloaking device



Known starships

Hull #	Name of starship	Builder	Status
KRS02-016	<i>mIn So'pu' (Hidden Eye)</i>	Chenwl Duj' Shipyards	destroyed
KRS02-029	<i>buQ So'pu' (Hidden Threat)</i>	Chenwl Duj' Shipyards	active
KRS02-063	<i>bejwl' (Watcher)</i>	Chenwl Duj' Shipyards	active
KRS02-134	<i>Samragh (Skulker)</i>	Chenwl Duj' Shipyards	destroyed
KRS02-141	<i>ghoqwl'yep (Careful Spy)</i>	Chenwl Duj' Shipyards	destroyed

Hla'bah is the oldest Klingon starship design still fielded by the Empire. While none remain in Imperial fleet service, several have been reported still serving in the fleets of the Lesser Houses. The origin date for *Hla'bah* is conjecture. It had not been recorded by the Vulcans prior to first contact with humanity in 2063 but was known to them by 2145. It was the standard Klingon fleet scout of its era, occasionally performing in the commerce raiding role along contested borders.

Hla'bah is one of only two classes of Klingon starships named for reptilian life forms. The other, of course, is the *Drell* type battlecruiser and its many descendants and spinoffs. *Hla'bah* is a bastardized form of the word *Ho'law'Dlbah* (tH. "fanged animal"). It refers to a seven-foot tall bipedal reptilian predator native to Q'o'nos that has been a favorite of the hunt since Klingon antiquity. Once they became aware of the word's proper translation 22st century humans promptly pegged the design with the code name "Raptor," after a similar creature from Terran antiquity. It is still code-named Raptor by Starfleet even today.

Humanity first encountered the design in 2151, when a disabled *Hla'bah*, the *Samragh* (tH. "Skulker") was found adrift within the atmosphere of a gas giant by the Terran starship *Enterprise*. The vessel was subsequently rescued from being crushed by the planet's dense atmosphere. The opportunity afforded the fledgling Terran Starfleet its first look inside a Klingon starship, as boarding parties were required in order to repair the ship's damage and bring enough of its disabled systems back on line to successfully rescue the craft.

It is believed that all *Hla'bahs* still in service were backfitted with cloaking devices in the 2270s. These would be of the same type and size as those used in *B'rel*. This may in part explain why a *Hla'bah* has not been sighted in over three decades even though captured Imperial fleet records point to their continued service with the Lesser Houses.

Hla'bah was the first hard evidence that not all major Klingon capital ship classes were *Drell* derivatives. Another well-known example from the period is *bortaS*. Both were built during a time when Klingon starships were still evolving, hence their exposed cabling and externally applied ablative armor.

One of the most interesting discoveries made by the *Enterprise* boarding party in 2151 was the fact that the *Samragh* was equipped with photonic weaponry. A mistranslation made at the time has led many to falsely believe that the *Samragh* was armed with "photon torpedoes" in the modern sense. It is true that 23rd century *Hla'bahs* were so equipped; however, this was not the case in the 22nd century. Subsequent investigation has shown that the so-called "photon torpedoes" aboard the

Samragh were precursors of modern photonic weaponry, thus making them ancestors of the photon torpedo systems used by Klingon vessels today. These "primitive" photonic weapons were still far in advance of the spatial torpedoes used by human starships at the time. Data gathered from the *Samragh* would be used to develop photonic torpedoes by 2152 and true photon torpedoes by 2215. It is widely believed that this effort spurred later Klingon advances in photonic weaponry along the same lines.

Sightings of *Hla'bah* along the Federation-Klingon border have been rare since the turn of the 23rd century. The last such recorded sighting was in 2265. It is believed that *Hla'bah* is still in service with the Lesser Houses, though, based on Klingon fleet records captured in 2285. According to declassified data extracts at least 37 *Hla'bahs* (out of an estimated 144 built) remained in the service of the Empire at that time.



Hla'bah class Klingon scout created by John Eaves and Doug Drexler as seen on screen in the *STAR TREK – Enterprise* episode "Sleeping Dogs"

Additional background material courtesy of *STAR TREK – THE MAGAZINE*, Memory Alpha, Graham Kennedy, and Battleclinic.com

Visuals courtesy of the Stress Puppy and Atrahasis

Akh`ist

***ghoqDuj* type 2 (*sirexa* type 2) (2252)**

Specifications as built

Dimensions

Length: 116 meters
Beam: 17 meters
Height: 25 meters

Mass

Subspace displacement: 23,000 DWT

Crew complement

Officers: 23
Enlisted: 77
Imperial Guards: none

Top velocity

Cruising speed: warp 4
Rated maximum speed: warp 7

Endurance

Standard endurance: estimated 1 year at L.Y.V.

Armament (*)

Disruptors: 2 standard disruptors (both F)
1 heavy disruptor bank (F)

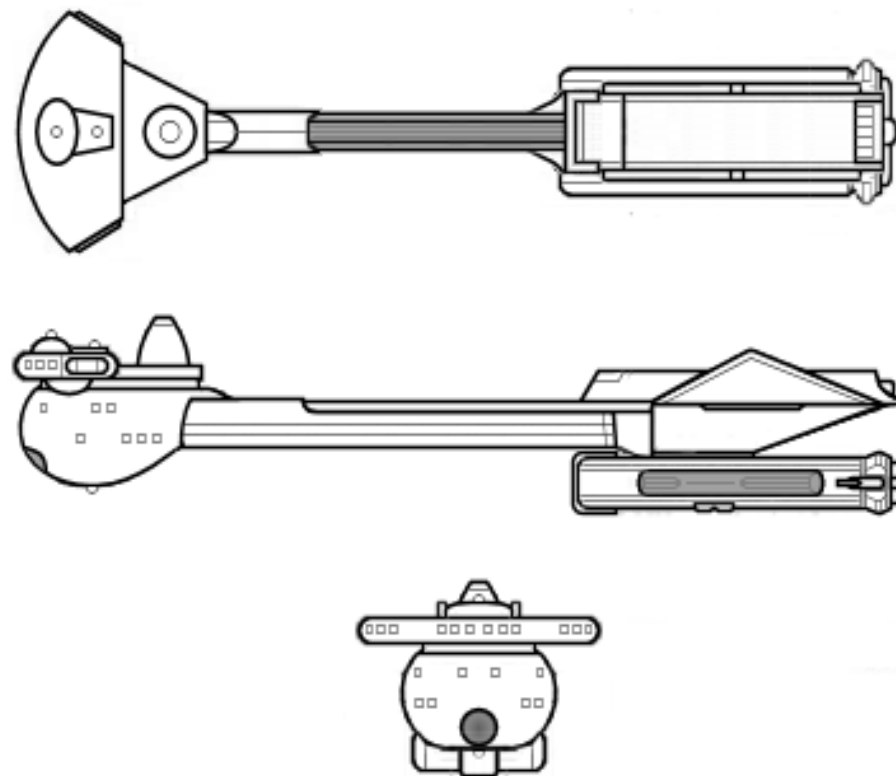

Known starships

Hull #	Name of starship	Builder	Status
KRS01-001	<i>Akh`ist (Runner)</i>	Taamar Shipyards	active

Akh'ist is the scout variant of *Kortak*, the most hated destroyer design still in service in the Imperial Fleet. *Kortak's* bad reputation has extended to *Akh'ist*, for it shares all of the same design deficiencies as its sibling. These factors are aggravated even more by the need to sacrifice precious internal hull for the ship's electronic surveillance suite.

Serving aboard an *Akh'ist* has often been described as worse than life aboard a gunboat, with its cramped spaces and permeating stench of warriors having to live together for days on end. For long-term body order to be noticed by a Klingon warrior *Akh'ist* living conditions must be poor indeed. This is aggravated by the fact that there is frequently not enough water generated by the ship's recycling system in which to bathe or properly dispose of wastes. The odor has known to become a problem even for Klingon warriors on the long term, long range scouting missions on which *Akh'ists* are frequently assigned. It is said that each *Akh'ist* has to be literally hosed out after its return, and even this does not always remove the odor. This has earned the class the unofficial nickname of *He'So'Hom* (tH "the stinking ships"). As with *Kortak* assignments, *Akh'ist* postings are usually reserved for Klingon malcontents. It is also said that the Klingon High Command likes to award *Akh'ist* postings for Klingon warriors who have earned the unwelcome reputation of being overly vain about their appearance.

Despite their perceived drawbacks, there are more *Akh'ist* class scouts in service in both the Imperial and House fleets than any other single scout design. The reasons are obvious: it is a simple design that is both cheap and quick to produce. Modernization has done little to alleviate its drawbacks save for the installation of an updated deflector grid and a slightly more powerful *pljonta'*. The Empire still finds the design useful for various reasons, so it is probably that it will remain in service for years to come.

<insert picture here>

**Morast class Klingon fleet transport/tug created by
Patrick Flannery (*Star Fleet Handbook* #10)**

Class name by Eric "Jackill" Kristiansen

Schematic by Richard Mandel

Sho'tar

***ghoqDuj* type 3 (*sirexa* type 4) [2272]**

Specifications as built

Dimensions

Length: 146.5 meters
Beam: 50.3 meters
Height: 27.5 meters

Mass

Subspace displacement: 65,000 DWT

Crew complement

Officers: 40
Enlisted: 155
Imperial Guards: none

Top velocity

Cruising speed: warp 4.0
Rated maximum speed: warp 6.0

Endurance

Standard endurance: estimated 2 years at L.Y.V.

Armament

Disruptors: 6 standard disruptor banks (2 F, 2 ea P/S)
1 heavy disruptor banks (both F)

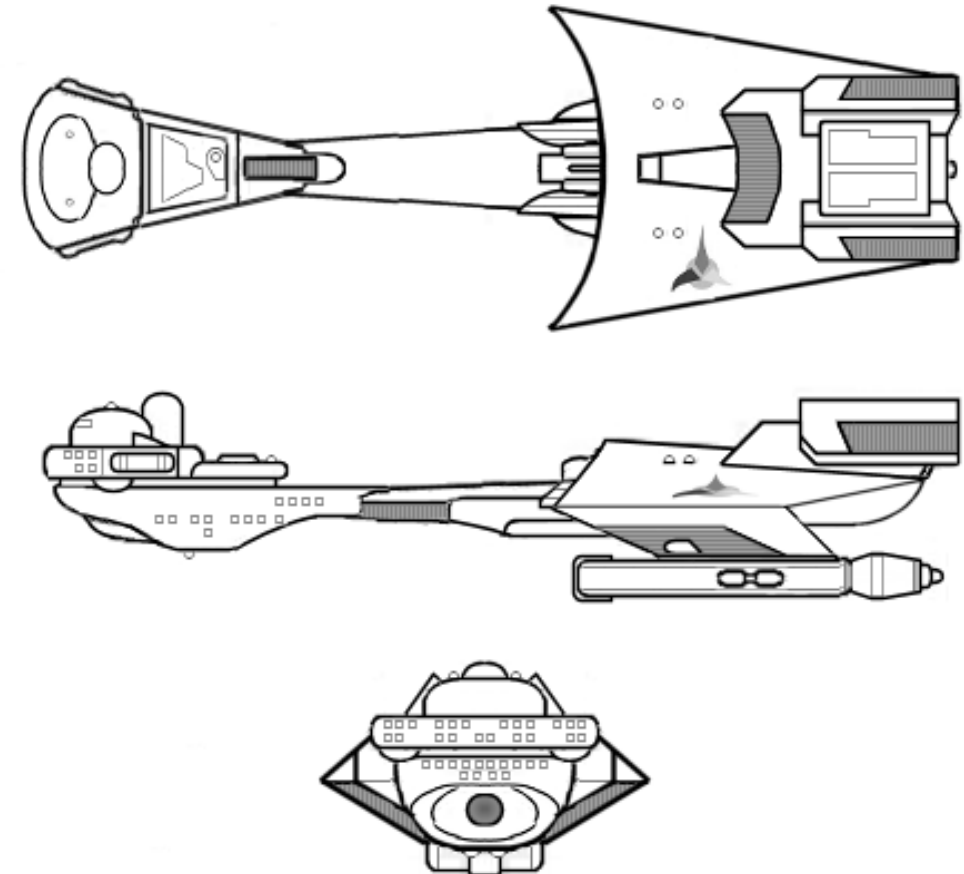

Known starships

Hull #	Name of starship	Builder	Status
KRS04-001	<i>Sho'tar (Ears Wide Open)</i>	Iosia Shipyards	active

Sho'tar is the scout version of *Lecthu*, first of the post-Kessa Klingon destroyer classes. As with all Klingon scouts, it trades armament for an extensive ECM/ECCM/ELINT suite. It also mounts a slightly smaller engine than *Kortak*, as its on-board power requirements are not as great. Its history is the same as that of its more storied destroyer sibling, having been delayed from entry into Imperial service for almost a full decade after it was designed for various reasons.

It is believed, as with the older *Kortak/Akh'ist*, that one in every six *Lecthu* hulls ordered was finished as a *Sho'tar* class scout. These have turned out to be among the best scouts in Imperial service, and postings are highly sought. The latter is most likely due to the fact that with its six standard disruptors and one heavy disruptor *Sho'tar* is the heaviest armed scout in the Klingon fleet. It can hold its own in a battle that would cripple or destroy almost any other Klingon fleet scout, which probably goes a long way in explaining its popularity among Klingon warriors. While a *Sho'tar* has never been known to provoke a combat action, there many reports of them finishing one at the expense of their attackers.

At one time there were reportedly plans to backfit *Sho'tar* with a boom-mounted phototorp system. This was eventually abandoned, as it would have meant a reduction in the ship's sensor and electronics suite. Likewise customizations are few and far between, usually trading any or all of the standard disruptors for less power-hungry weaponry.

<insert picture here>

***Sho'tar* class Klingon scout created by Eric "Jackill" Kristiansen**

Background by Richard Mandel

Schematics courtesy of Richard Mandel

**Derived by permission from the originals by Eric Kristiansen
and based on the work of Neale Davidson (Pixel Sagas)**

Tas`esta

***ghoqDuj* type 8 (*sirexa* type 14) [2260]**

Specifications as built

Dimensions

Length: 88 meters
Beam: 130 meters
Height: 16 meters

Mass

Standard gross: 116,250 GMT
Subspace displacement: 47,000 DWT

Crew complement

Officers: 2
Enlisted: 14
Imperial Guards: none

Top velocity

Cruising speed: warp 7
Rated maximum speed: warp 8

Endurance

Standard endurance: estimated 1 year at L.Y.V.

Armament

Disruptors: 2 standard disruptors (1 F/P, 1 F/S)
Guided weapons: 1 photon torpedo tube (F)
Other: cloaking device

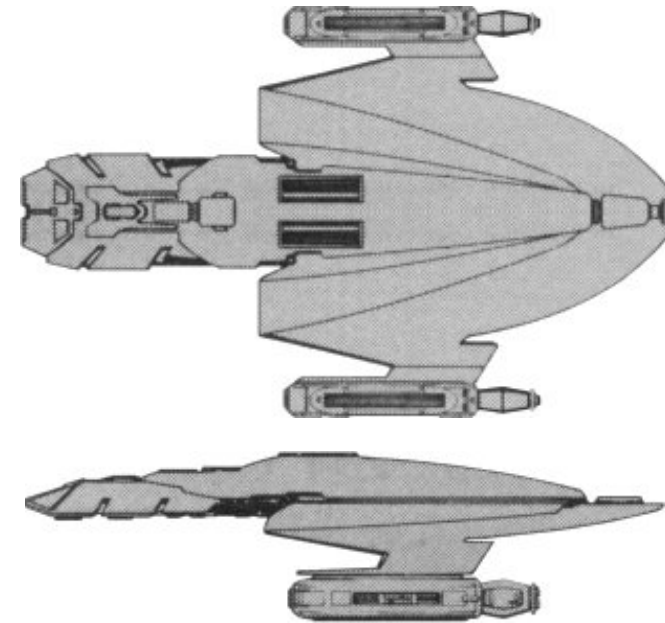

Known starships

Hull #	Name of starship	Builder	Status
KRS12-001	<i>Tas`esta (Pathmaker)</i>	Z'hai Shipyards	active
KRS12-192	<i>SoviH`Qlb (Lurker)</i>	Z'hai Shipyards	

Tas'esta is the Klingon analogue to Starfleet's *Oberth*. This makes it the "little brother" of the *Z'Gal* (tH. *loDnI'Daj Z'Gal*). Both are heavily armed Klingon explorer craft, with the only main difference being in size. The smaller *Tas'esta*, though, spends most of its time as a squadron or fleet ELINT vessel. Use of *Tas'esta* in this manner frees up the better-equipped *Z'Gal* for the few missions that the Klingon High Command cares to assign an explorer-type starship nowadays.

In 2279 the *Tas'esta* class scout *SoviH'Qib* (tH. "Lurker") was conducting a routine patrol along the edges of the Demon's Rift when its sensors registered a contact drifting just inside Klingon space. It turned out to be the jettisoned boom of the *taj So'vang* (tH. "Veiled Dagger"). It had been a *B'rel* that had disappeared without a trace in the region five years before on a similar mission. Normally this would have been the subject for a routine report without further investigation, with the assumed destruction of the craft chalked up to the Kinshaya. *B'rel* booms were not designed for extended life support beyond a few hours at the most, and this would have consumed whatever power was on board. Any survivors would have been long dead by now. That was why, when the initial sensor scan show a low power source still functioning on the boom, the crew of the *SoviH'Qib* promptly snagged the boom with a tractor beam, sent a coded priority scrambled signal burst to the nearest Klingon base, and then high-tailed it back as fast as they could. The Kinshaya made no effort to hinder the *SoviH'Qib*'s recovery of the boom, although long range sensors recorded at least two probable contacts deeper within the Rift. *SoviH'Qib* made it safely out of the area and was promptly met by a battlecruiser squadron, which then escorted it back to the nearest base along with its discovery. The bodies of five of its crewmembers, including Captain Kitach, were recovered along with a find of even greater importance.

As it turned out, *taj So'vang* had been one of a number of *B'rels* converted for use as deep penetration scouts. Among its many modifications was the scout-standard emergency backup power source for its main computer core. This could maintain the system in low-power mode in the event of the ship's destruction, assuming it remained intact, via the ambient background radiation of space. It had been this system that the *SoviH'Qib*'s sensors had detected still functioning aboard the *taj So'vang*'s otherwise lifeless boom. Its computer core had thus remained perfectly preserved, allowing Klingon Sector Intelligence to download its data and retrieve the ship's mission logs. Captain Kitach had been on a special mission to penetrate the Demon's Rift and follow the border line declared by the Klingons at the end of the Demon War. The overt reason was, of course, to show the flag as it were. The real reason was gather as much intelligence as possible using the ship's specially modified sensor

arrays. A modified *B'rel* had been used as opposed to a standard scout or patrol ship in the event that something went wrong. From the moment the *taj So'vang* had entered the Rift it had been shadowed by anywhere from two to five contacts that registered as Kinshaya in configuration. At the same time all contact with the nearest Klingon base had been lost. Kitach was under orders to act under his own discretion in such a situation, and he chose to proceed with the mission. One-third of the way into the Rift, as Kitach was completing his first dogleg on his planned course, his ship had been attacked by three small Kinshaya void-spheres of a previously unknown design. Kitach had attempted to engage but the more nimble Kinshaya craft easily evaded even the agile *B'rel*. Kitach then attempted to cloak and retreat out of the Rift, at which point at least two dozen more Kinshaya craft appeared and began laying down a coordinated pattern of fire design to prevent his escape. The Kinshaya were apparently all too aware of the cloaking device as well as efficient battle tactics to combat its use. Realizing that his efforts were doomed, Kitach ordered his crew to evacuate to the boom. His ship was hit and disabled within a split-second of his order, leaving Kitach with no choice but to activate his boom jettison system before the evacuation could be completed. Within seconds the *taj So'vang* was hit by a second Kinshaya volley and exploded, sending debris scattering in all directions. Kitach's action had saved the boom, though, which had been jettisoned along with him and his bridge crew. The Kinshaya took no other action other than a cursory scan of the wreckage and disappeared once again, content to leave Kitach and his surviving crewmembers to their fate. There was nothing left for them to do except activate the computer core's emergency power system and then prepare for their imminent journey to Sto-Vo-Kor.

The discovery of the *SoviH'Qib*, coupled with the actions of the late Captain Kitach and his crew, provided the Empire with the only detailed scans of Kinshaya void-spheres in the modern starship era. The crew of the *SoviH'Qib* received a special commendation for their find. All members of the *taj So'vang*'s late crew were awarded posthumous decorations for honor, and Captain Kitach was named a Hero of the Empire.

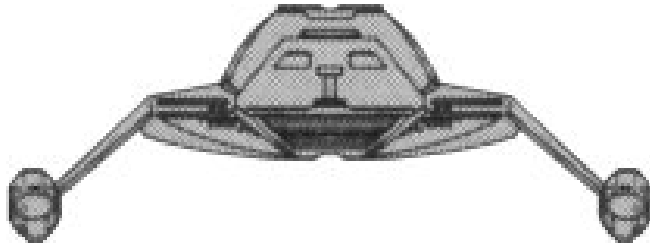

Tas'esta class Klingon scout created by Forrest G. Brown and Dana Kuntson for STAR TREK – The Role-Playing Game by FASA Corporation

Additional background material courtesy of Brad Torgenson and Michael Chumbler (“The Tale of the *taj So'vang*”)

Visuals courtesy of Dana Kuntson

Original Kinshaya concept by FASA Corporation (*The Klingons* RPG supplement) reversioned Kinshaya void-sphere design by Atolm

v

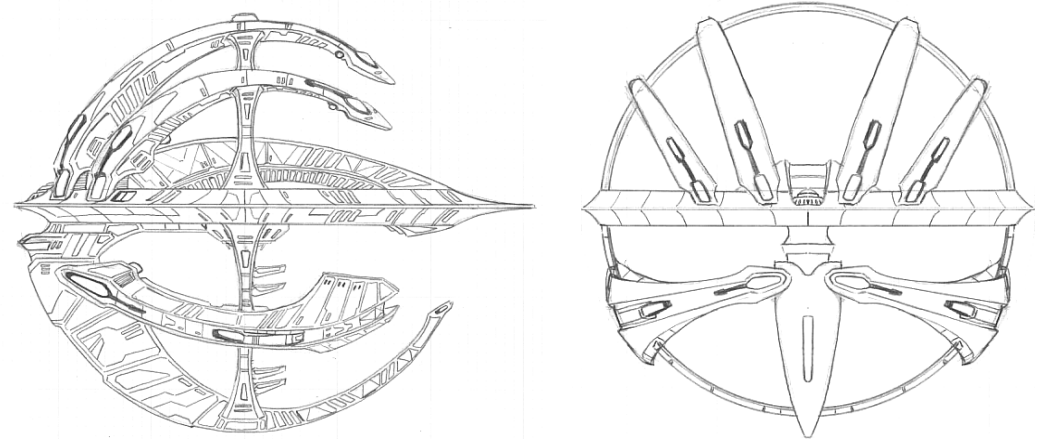

Starboard profile and aft elevation views of the new Kinshaya void-sphere observed by the *taj So'vang* prior to its destruction in 2274. These views, along with copies of the relevant data, came into Federation possession via the successful capture of the Bird-of-Prey *DuQwl'* in 2285.

L`rexa

***ghoqDuj* type 12 (*sirexa* type 15) [2260]**

Specifications as built

Dimensions

Length: 155 meters
Beam: 111 meters
Height: 50 meters

Mass

Standard gross: 114,625 GMT (average)
Subspace displacement: 42,000 DWT (average)

Crew complement

Officers: 24
Enlisted: 100
Imperial Guards: none

Top velocity

Cruising speed: warp 7
Rated maximum speed: warp 10

Endurance

Standard endurance: estimated 3 years at L.Y.V.

Armament

Disruptors: 2 standard disruptors (2 F, 1 P/A, 1 S/A)
Guided weapons: 1 photon torpedo tube (F)
Other: cloaking device



Known starships

Hull #	Name of starship	Builder	Status
KRS15-001	<i>L`rexa (Unseen Creeper)</i>	Gnuu Re' Shipyards	active

Next to *B'rel*, *L'rexa* is probably the most popular small capital ship design to be found in the Klingon Empire today. It serves primarily in the role of a long-range ELINT vessel. In fleet actions it is often used as a dedicated ECM/ECCM craft. Frequent updates have allowed it to maintain parity with even the best of the Federation Starfleet's own scout designs. It remains a favorite both with its crews and with the Imperial Houses. It is slowly being replaced in Imperial service by the ELINT variant of the *plH*.

The name from the class comes from Kl. *l'rexa*, a verb whose closest translation means "slowly and unseen." This is informally translated as "Unseen Creeper" by Starfleet, in part a reference to its cloaking capabilities.

Starfleet Intelligences gives *L'rexa* the same combat rating as *B'rel*. While it lacks *B'rel's* near-legendary maneuverability, it more than makes up for this with its ECM/ECCM capabilities. It is quite capable of practically blinding its opponent's sensors and then opening a surprise attack. In this manner it can take on any starship that outclasses it and almost always survives to affect a strategic retreat with little harm – save for chance hits by an opponent forced to manually aim its weapons. It has an excellent power-to-weapons ratio, even more so with the dual *pljonta'* version. It also features a surprisingly resilient space frame for ship of its class – the same that made the dual *pljonta'* upgrade possible. It can take an amazing amount of punishment for a ship its size, and in this feature it easily bests the quick but fragile *B'rel*.

L'rexa is capable of atmospheric flight under a variety of conditions, including the normally hostile environment of most gas giants. This adds greatly to *L'rexa's* scouting capabilities. Oftentimes *L'rexa* can be found hiding in the cloud formations of a planet that happens to be within convenient range of its intended target. This allows it to save precious energy that would normally be used to power its cloaking device. Unfortunately, *L'rexa* is incapable of a planetary landing unless it jettisons its *pljonta'*. This is true of both the original and refit versions. Certain of the Great Houses have reportedly refitted their *L'rexas* with custom landing gear to address this issue. The Imperial fleet has declined to undertake a similar conversion for its own, citing the minimal need for such a capability.

Beginning in 2269 an improved version of *L'rexa* entered service. The new version has twin *pljonta'* mounted in a *Drell*-type arrangement, as opposed to the single belly-mount *pljonta'* of the original design. Early *L'rexas* had proven to be underpowered, with only limited short-range ELINT capability when cloaked. The addition of the second *pljonta'* practically eliminated this problem. The improved *L'rexa* quickly displaced the original in both Imperial and House service, although a fair number of

original, single-*pljonta'* *L'rexas* can still be found in service with the Lesser Houses.

It is believed that "about 400" *L'rexas* were built from 2260 to 2288. Production began at Gnuu Re' and was subsequently expanded to Taamar three years later to meet demand. The improved *L'rexa* was introduced by Taamar in 2269 and had become the sole production type at both spaceyards by 2271. At least 60 have been destroyed or are listed as missing. The Romulans received 7 (5 original and 2 improved) as part of the terms of the Klingon-Romulan Alliance. Starfleet has managed to capture 1 of each type since the class was first introduced. Both currently serve with its Adversary Squadron for Command School training purposes.



Three-quarters aft view of a refitted *L'rexa*. The addition of the second *pljonta'* has done much for the design. It has not only allowed the fitting of a more powerful sensor suite but also powers improved shielding and heavier defensive weaponry.

***L'rexa* class Klingon escort created by Forrest G. Brown and Dana Knutson for FASA Corporation's STAR TREK – The Role-Playing Game**

Additional background material courtesy of Brad Torgerson

Images courtesy of Terradyhne

Z`mortama

***ghoqDuj* type 13 (*sirexa* type 17) (2265)**

Specifications as built

Dimensions

Length: 130 meters
Beam: 90 meters
Height: 20 meters

Mass

Standard gross: 43,000 GMT (*)
Subspace displacement: 17,200 DWT (*)

Crew complement

Officers: 4
Enlisted: 10

Top velocity

Cruising speed: warp 7
Rated maximum speed: warp 10

Endurance

Standard endurance: estimated 1 year at L.Y.V.

Armament

Disruptors: 3 standard disruptors (2 F, 1 A) (*)
Guided weapons: 2 photon torpedo tubes (both F) (*)
Other: cloaking device

(*) Figures are for the standard Imperial version. Figures for custom House models can vary wildly depending on the extent of their conversions and modifications.



Known starships

Hull #	Name of starship	Builder	Status
KRS17-001	<i>L'rexa (Death Stalker)</i>	Taamar Shipyards	active

Z'mortama is the Klingon scout vessel most commonly found operating in the Triangle and along the Empire's spinward borders. It was originally proposed as a competitor to *L'rexa* during the procurement process for a new fleet scout. *L'rexa* was deemed more suitable, so it was the one chosen. When *Z'mortama* was initially rejected for Imperial service, House Kinzan (its designer) built two of its own for use with its own House fleet in Triangle operations. By the time the first of these was completed the limitations of the original *L'rexa* design had become known. In a canny move House Kinzan licensed the *Z'mortama* design to Taamar for mass production, knowing that the Klingon High Command was rethinking its choice of *L'rexa* as the Imperial fleet's main scout class. It also demonstrated the "production model *Z'mortama*" for Taamar before High Command as an alternative to the planned *L'rexa* upgrade. As House Kinzan correctly predicted the Klingon High Council approved both programs – the planned *L'rexa* upgrade *and* the authorization of *Z'mortama* as "a supplemental scout class." This put Taamar in the unique position of being contracted (or sub-contracted) to build both of the Imperial fleet's scout classes at the same time, thus adding greatly to its prestige (and House treasury). In parallel, House Kinzan reaped a considerable profit from its *Z'mortama* license to Taamar, thus allowing it to finance other of its unique starship design programs (such as *Keth Ke Se*).



While the Federation Starfleet has had little experience against *Z'mortama*, it has gathered considerable intelligence from its contacts and allies within the Triangle. It is a sturdy, well-built scout whose dual photon torpedo tubes (obviously provided to operate probes) allow it to serve as a light destroyer or destroyer escort in a pinch. Its *Drell*-derived design gives it traditional *Drell*-type acceleration and maneuverability. When compared to *L'rexa* it is the more durable and combat-worthy of the two. Unlike *L'rexa*, though, *Z'mortama* cannot operate within a planetary atmosphere except with great difficulty. It is the only aspect between both designs in which *L'rexa* has the edge.

Most House versions are usually customized for the combat role at the cost of reduced ELINT capability. These retain their full ECM/ECCM suite.

Z'mortama was only in Imperial production for three years before it was discontinued in favor of the improved *L'rexa*. Taamar continued to build it, though, for almost a full decade more while custom orders for various House fleets were fulfilled. "At least three dozen" are believed to exist, although some Federation starship spotters give a far larger number. The last *Z'mortama* commissioned, a wing-swept-forward, customized version produced for the House of Kang, entered service in 2274.

L'rexa class Klingon escort created by Forrest G. Brown and Dana Knutson for FASA Corporation's *STAR TREK – The Role-Playing Game*

Additional background material courtesy of Brad Torgerson

Images courtesy of Terradyhne

ᑕᑦᑎᑦᑎᑦ

Escorts

ethakan (Kl. “Performer”),
kuwikh (Kl. “Favored Ship”) and
DorDuj (tH. “Guarding Vessel”) series

Escorts

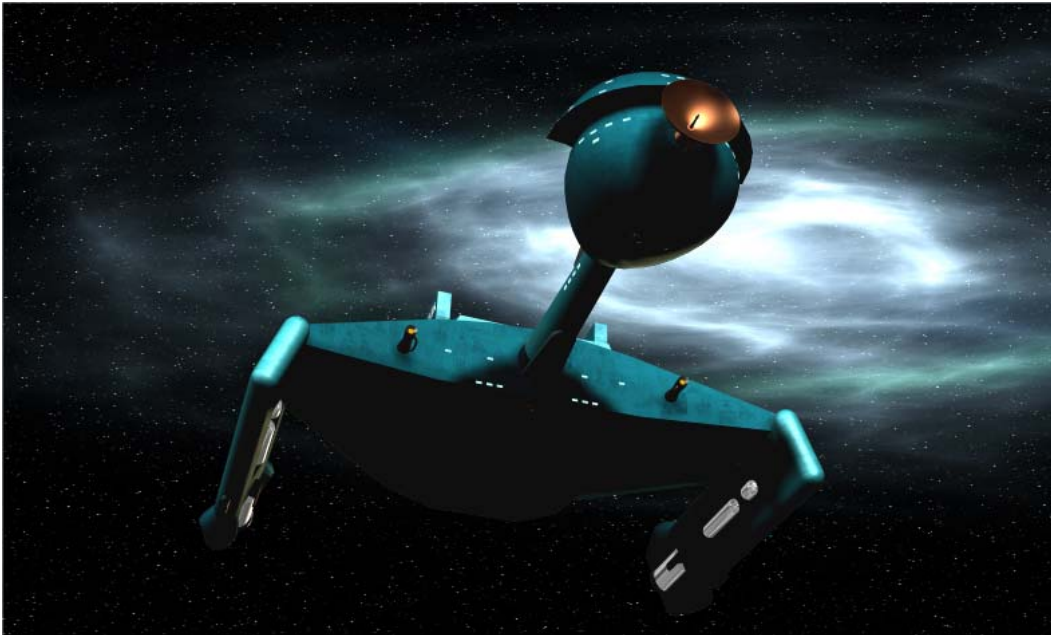

A *Sekleth* in its pre-modern configuration, c.2250

Within the Empire, escorts are the poor Klingon's frigates. They are the lowest class of fleet combatant produced and proved the second largest pool of starships in Imperial service. Consequently, their commanders do all of the "hump" work – the essential, necessary, and all too frequently inglorious missions and duties necessary in order to maintain the stability of the Empire. Police duties, routine border patrol in so-called "safe" zones, convoy escort, penal colony duty, formal state functions, and so on make up the bulk of a escort crew's tour of duty. Because of this Klingon escort captains generally fall into one of three types: those working up the ranks who are biding their time while awaiting the chance to prove they deserve a better ship, those who couldn't get a better ship for one reason or another, and those who don't deserve a better ship for obvious reasons. All three have one thing in common: they will jump at any chance to prove themselves in battle, no matter how small. Anti-piracy actions and the pursuit of minor criminals tend to make up the bulk of such chances and they tend to be executed in typical Klingon fashion. Even so, the occasional (and often provoked) scrap with an enemy combatant due to an "accidental" crossing of borders "due to bad navigation" is not unknown ... and such encounters by escorts are not frowned upon by the Klingon High Command, either, provided the escort scores some kind of measurable victory. Those who do are almost always guaranteed a promotion to a better vessel. Those who don't, or who have earned the wrath of the Empire due to past actions, are expected to die a glorious death in combat rather than live and return in disgrace. Such is the Klingon way.

Gavama

DorDuj type 2 (ethakan type 3) **[2125?]**

Specifications as built

Dimensions

Length: 80 meters
Beam: 135 meters
Height: 20 meters

Mass

Standard gross: 110,500 GMT
Subspace displacement: 45,300 DWT

Crew complement

Officers: 5
Enlisted: 18
Imperial Guards: none

Top velocity

Cruising speed: warp 5
Rated maximum speed: warp 7

Endurance

Standard endurance: estimated 1.5 years at L.Y.V.

Armament

Disruptors: 4 standard disruptors (2 F, 2 omni)
1 heavy disruptor (F only)
Guided weapons: none
Other: cloaking device



Known starships

Hull #	Name of starship	Builder	Status
KRE03-0001	<i>Gavama (Hunting Bird)</i>	Klinzhai Shipyards	---

Gavama is one of the ancestors of the modern *B'rel* class Bird-of-Prey. The main differences between the two are the lack of photon weaponry and the fact that *Gavama's* "wings" are fixed in place. This was the Empire's primary escort design during the 22nd century until it was phased out in favor of *Sekleth*. Almost all of the surviving *Gavam*s in service today are heavily refitted versions in Lesser House fleets.

The Internal Security Forces (Bloodwatch) variant is known as the G-2 (from the Kl. *gagdaka*, lit. "tool of justice"). It replaces the wingtip disruptors with drone racks and comes with a limited Justice Center facility within its secondary hull.

The heavily modified *Rotah* "Y" variant, which was first sighted in 2153, is capable of limited swing-wing capability. The primary purpose for this was to gain the capability for planetary operations. For this purpose *Rotah* could lift its wings to the fully horizontal position. This not only facilitated atmospheric flight but also permitted landings and take-offs. Understandably, *Rotah* became the most popular of the various *Gavama*-derived designs reportedly within two years of its entry into service. At the peak of its service life at the turn of the 22nd century, reportedly three-fifths of all *Gavam*s in the Imperial and House fleets were *Rotah* variants.

Two things have combined to make *Gavama* sightings a rare event these days. The first is the sudden upsurge in new escort classes that took place from the mid-23rd century onward. Before that it had been able to hold its own against *Sekleth*, its only competitor in the escort role. The debut of *B'rel* in 2270 virtually sealed its fate. Second, the design was not as easily customized as *Sekleth*. While some 21 known variants are recorded, this figure came nowhere close to the 53 variants of *Sekleth*. The latter was not that much more expensive than *Gavama*, so naturally those who had the funding gravitated towards the more versatile design. This effectively made *Gavama* a niche design for those Houses who preferred a more combat-oriented escort to a more general-purpose one. *B'rel* subsequently took this niche away from it as well, leaving it with no other purpose but to continue serving the fleet needs of the poorer of the Lesser Houses.

The last confirmed *Gavama* sighting was in 2272. The last confirmed sighting of *Rotah*, its most notable variant, was in 2267. *Gavama* is known to still be in the service of the Lesser Houses due to Klingon fleet records obtained from the captured Bird-of-Prey *DuQwl'* in 2285. Those records do not mention whether or not any *Rotah* variants remain in service. If so, then their numbers are probably included among those of its parent class.



Rotah E-3Y variant. This image is taken from a 2244 sighting above Donatu V. Note the heavy modifications to the aft section of the secondary hull, as well as the installation of more streamlined disruptors, as opposed to a standard *Gavama*. Barely visible in this image are four additional point-defense disruptor cannon – two on the forward part of the boom and two on the secondary hull. These came at the expense of already cramped interior spaces. An early form of photonic weaponry, precursor of the modern photon torpedo, replaces the heavy disruptor in the command boom. It is the *Rotah* variant of *Gavama* that is in fact the direct ancestor of the modern *B'rel*.

***Gavama* class Klingon escort created by Steven V. Cole
for Amarillo Design Bureau's *Star Fleet Battles* role-playing game**

***Rotah* class created by John Eaves and Greg Jein
as featured in the *STAR TREK: ENTERPRISE* episode "The Expanse"**

**Additional background material courtesy of Amarillo Design Bureau,
Activision Games, Klingon Fanatic, and James Dixon**

Visuals courtesy of Atrahasis and Animanic

Sekleth

***DorDuj* type 2 (*ethakan* type 4) [2177]**

Specifications as built

Dimensions

Length:	92 meters
Beam:	68 meters
Height:	38 meters

Mass

Standard gross:	69,750 GMT
Subspace displacement:	23,250 DWT

Crew complement

Officers:	19
Enlisted:	76
Imperial Guards:	none (*)

Top velocity

Cruising speed:	warp 4 (*)
Rated maximum speed:	warp 7 (*)

Endurance

Standard endurance:	estimated 2 years at L.Y.V. (*)
---------------------	---------------------------------

Armament

Disruptors:	4 standard disruptors (2 F, 2 omni) (*) 2 heavy disruptors (both F)
Guided weapons:	(*)
Other:	none (*)

(*) Dependent on level of customization. Listed values are for the stock production model (c. 2177-2270). All surviving *Sekleths* in the service of the Empire were backfitted in the 2270s with modern weapons systems, modern *pljonta'*, and cloaking device technology. Many Imperial *Sekleths* at that time also received a single forward-mounted photon torpedo system via a new command boom. Hull forms for refitted *Sekleths* are slightly different than pre-refit models.



Known starships

Hull #	Name of starship	Builder	Status
KRE04-0001	<i>Sekleth (Little Servant)</i>	Klinzhai Shipyards	---

Sekleth is basically a stripped-down *Kuve*. It utilizes the same spaceframe, *pljonta'* and most internal systems. The only real difference is in its armaments, which have been reduced by one omnidirectional standard disruptor mount for its intended role of escort. Its command boom is also slightly shorter and its *pljonta'* pylons mounted in an extreme forward position. The engine mount configuration was changed to support the larger *pljonta'* mounted on the Internal Security Forces variant.

The Internal Security Forces (Bloodwatch) variant is known as the G-3 (from the Kl. *gagdaka*, lit. “tool of justice”). It has larger *pljonta'* than those normally used on an E/F series hull. It also adds a pair of drone racks, which is a feature conspicuously absent on a regular *Sekleth*. It has “special” internal features like those found other major ISF vessels, such as a Justice Facility (complete with interrogation chamber and agonizer booth) and a Life Center (for both vivsection and dissection of subjects). It is said that the appearance of a lone G-3 over a Klingon subject world strikes even more fear in the hearts of its inhabitants than if a battlecruiser squadron had suddenly dewarped in low planetary orbit.

Sekleths are normally found on performing routine escort and patrol duties within the Empire itself. A few are still deployed on the Empire’s borders by the lesser houses; however, their numbers are steadily shrinking. *B’rei* has rapidly replaced *Sekleth* in the escort role that it once dominated for so many decades. That being said, the aged *Sekleths* are only being retired once it becomes obvious that their space frames are worn out. The design, which is essentially a *Kuve* on the cheap, quickly lent itself to many of the same kinds of conversions and customizations as its more respected sibling.

“Less than three dozen” *Sekleths* are known to still be in service with the Imperial fleet. All of these have been reconfigured to varying degrees for specific roles. It is thought that roughly twice that number still serve with the Imperial Houses, mostly in the fleets of the Lesser Houses. It is believed that a few “standard” *Sekleths* might still be in the service of one or more of the poorer Lesser Houses.

It is not known how many G-3 customizations are still in the service of the Bloodwatch. Unconfirmed sources have asserted that Bloodwatch G-3s are in the process of being replaced by a customized version of *Kom Kades*.



***Sekleth* class Klingon escort created by Steven V. Cole for Amarillo Design Bureau’s *Star Fleet Battles* role-playing game**

Additional background material courtesy of Amarillo Design Bureau, Activision Games, Klingon Fanatic, and James Dixon

Visuals courtesy of Battleclinic.com

B`rel

***DorDuj* type 12 (*kuwikh* type 22) [2270]**

Specifications as built

Dimensions

Length:	88 meters
Beam:	130 meters
Height:	16 meters

Mass

Standard gross:	108,000 GMT
Subspace displacement:	47,000 DWT

Crew complement

Officers:	2
Enlisted:	10
Imperial Guards:	none

Top velocity

Cruising speed:	warp 7.0
Rated maximum speed:	warp 9.0

Endurance

Standard endurance:	estimated 1 year at L.Y.V.
---------------------	----------------------------

Armament

Disruptors:	2 standard disruptors (both F)
Guided weapons:	1 photon torpedo (F)
Other:	cloaking device



Known starships

Hull #	Name of starship	Builder	Status
KRK22-001	<i>B`rel (Wild Woman)</i>	Klinzhai Shipyards	active
KRK22-116	<i>taj So`vang (Veiled Dagger)</i>	Gnalt Small Craft Spaceworks	lost
KRK22-120	<i>DuQwl` (Penetrator)</i>	H`renn Shipyards	capt-F

The Bird-of-Prey has been a staple of the Klingon fleet for as long as the fleet has been in existence. Legend ascribes the design to an early Klingon starship class used for commerce raiding, the *d'ex gavama* (Kl. "killer bird"). It was named after a predatory bird similar to the Terran falcon. From this word was derived the chopped form *d'gavama* (Kl. "bird of prey"), which is the name that the design was ascribed under the old Imperial fleet nomenclature system. This corresponds to *toQDuj* (tH. "bird of prey") in the current official language of the Empire, and it is by this name which Klingons know the design today.

B'rel, the first modern Bird-of-Prey design, is named for the original Bird-of-Prey per the legend described above. According to that legend, a Klingon warrior named Mokol was the first captain of the original Bird-of-Prey. When asked how it handled after its first flight, Mokol laughed and compared it to the greatest sex he ever had with the wildest Klingon female he had ever known. *B'rel* translates as "wild woman" in the Klingon Old Tongue.

In 2269 the Klingon High Command began actively seeking out a new design to replace its current crop of escorts and fleet scouts. Practically all of the designs that were in Imperial service at the time were either undergunned or underpowered (sometimes both) in comparison to next-generation Federation and Romulan designs, and there were not enough House customizations to cover this gap. Many ideas were suggested and designs submitted, but in the end it was a revival of the classic Bird-of-Prey that caught the High Council's eye. This design, submitted by Klinzhai Shipyards, was based on the Romulan S-11 gunboat. It was an excellent vessel for its size and Romulan origins, whose striking likeness to older Bird-of-Prey designs had immediately caught the eye of Klingon trade and military representatives. Several examples were obtained under a secret protocol of the Treaty of S'marba and closely studied by the design teams of the Klinzhai Shipyards. A prototype was then built and tested based on a modified Romulan S-11 design. Several more tweaks were then made before submitting a modified design to the High Council for review.

Klinzhai's *B'rel* proposal was one of two finalists chosen for the new fleet escort competition. The other was the *K'tak*, submitted by rival Chenwl' Duj Shipyards. In the final design competition that followed Klinzhai's *B'rel* prototype handily defeated Chenwl' Duj's *K'tak* in one mock battle after another. A initial construction contract for 79 hulls was awarded to Klinzhai in 2273.

It quickly became apparent to all that *B'rel* was the finest starship yet produced within its class in modern times and demand soared. Within the decade the demand for additional *B'rels* build groups became so great that Klinzhai was forced to farm out additional contracts to other Klingon

shipyards, including former competitor Chenwl' Duj. *B'rels* are now being produced at seven different inner system shipyards and five outer system ones, with a service entry rate of just under one per month.

B'rel is popular for a number of reasons. It is small and therefore cheaply and quickly produced, yet it packs considerable firepower for a vessel of its size. Its small size means a small crew, meaning that its captain serves as both commander and chief gunner and thus adds to his personal glory in battle. It also meant less chance of a mutiny, since *B'rel* crews are usually hand-picked by their captains. Its low production cost and high construction rate were the perfect means by which even the least of the Lesser Houses could build up a modern fleet in record time. This helps explain the fact that over two-thirds of all *B'rels* in existence today can be found in House fleets (as opposed to being in Imperial service). *B'rel* was also one of the first Klingon starship designs to incorporate the cloaking device, which had an immediate impact on escort battle tactics. Finally, the design is battle-proven against both Federation and Romulan forces. It was a *B'rel* that brought about the destruction of the legendary Federation starship *Enterprise* in 2285. It was a *B'rel* that destroyed the flagship of the Romulan Triangle fleet in 2286. These are but two of many, many examples of a *B'rel* defeating the superior starships of its enemies.

The main weakness of *B'rel* and most *B'rel*-derived designs is that all of its weaponry is fixed forward. There is no coverage of any kind for its sides or rear. This is not as big a disadvantage as it might seem, though, given the availability of its cloaking device. Battle tactics for *B'rel* commanders, developed by the late General Chang, use a hit-and-run approach derived from traditional Klingon head-on attack strategies. In a typical encounter a *B'rel* will get as close to its opponent as it can while under cloak with all weapons armed (something the plasma-equipped Romulan S-11 cannot do). Once in position it will quickly drop its cloak and open fire at point-blank range, then re-engage its cloak as soon as possible and swing back around for another hit-and-run attack pass. This technique has proven highly successful, so much that a *B'rel* with a skilled commander can take on a vessel many times the size of his own vessel and often come away the winner.

The recent addition of the ability for *B'rel* to fire its weapons while cloaked, developed by General Chang before his untimely death in 2293, transforms an already formidable opponent into a truly fearsome one. At Khitomer, in the battle that cost him his life, Chang's modified Bird-of-Prey took on both the Federation heavy cruiser *Enterprise-A* and the new Federation space control ship *Excelsior*. Both vessels were considerably larger and more heavily armed than his own, yet he managed to inflict heavy damage to both before a means was finally found to track his vessel

while cloaked. Chang subsequently died in the glory of battle defending the Empire to which he had dedicated his life. His technological achievement will live on, though, in Mustaka Shipyard's next build group of *B'rels* to enter Imperial service.

As of today there are some 243 confirmed *B'rels* in existence within the Empire in both Imperial and House service. Some Federation starship spotters put the total estimated figure at over twice that number. The size of the hull limits the number and type of variants that can be produced, although variations and customizations are not unknown.

In 2285 the *B'rel* class starship *DuQwi'* (tH. "Penetrator") was captured by Federation mutineers while undertaking a top-secret mission deep into Federation territory. It was never returned to the Empire despite repeated demands. It was eventually renamed the *Bounty*, reconfigured for human use, lost in San Francisco Bay during the Whalesong Crisis, then later raised and secured by Starfleet Intelligence for analysis. After they were finished with the ship, *DuQwi'* was eventually deployed with the Federation Starfleet's infamous Adversary Squadron for Command School training.

It was by *DuQwi'*'s capture that the Federation acquired a working example of a Klingon cloaking device. The tracking technology used to defeat General Chang at Khitomer in 2293 was based on information derived from studies of said device.

B'rel served as the design basis for the subsequent *QuD* class destroyer. *QuD*'s planned successor, *K'vort*, will revert to the original *B'rel* design configuration, despite its larger size, due to *B'rel*'s popularity within the Empire. With support such as this the ageless Bird-of-Prey may yet replace the venerated *Drell* as the starship design most firmly planted in the heart and mind of the Klingon Empire.

Schematics

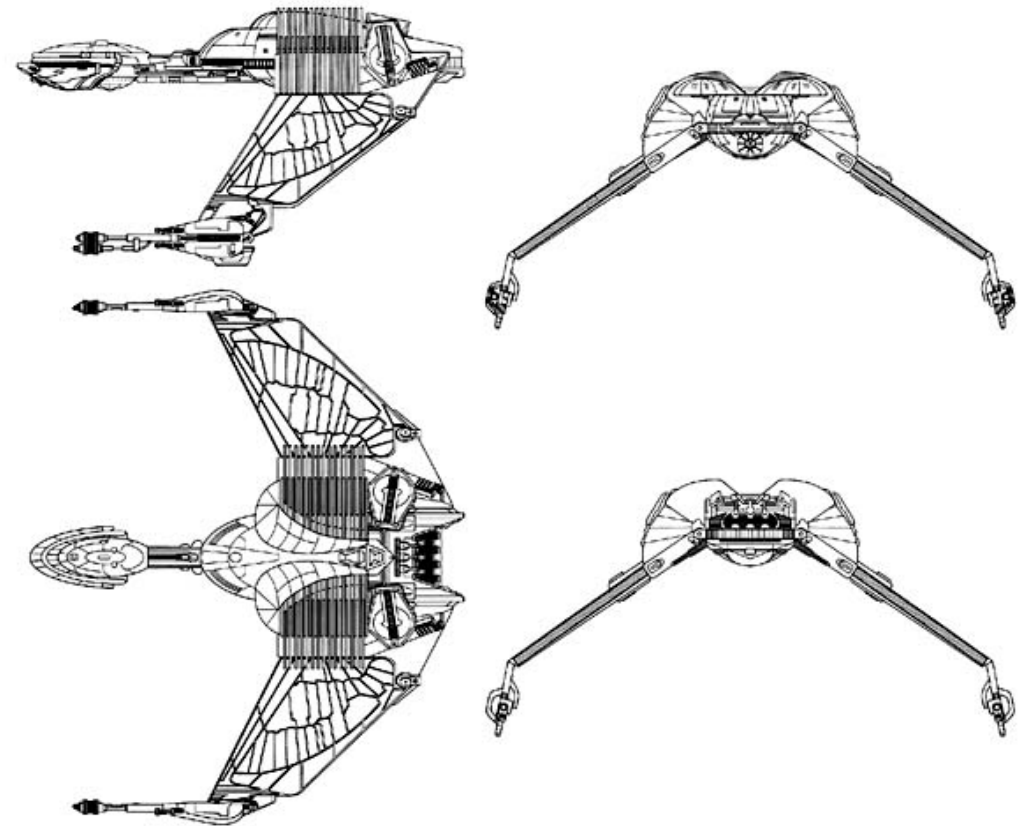

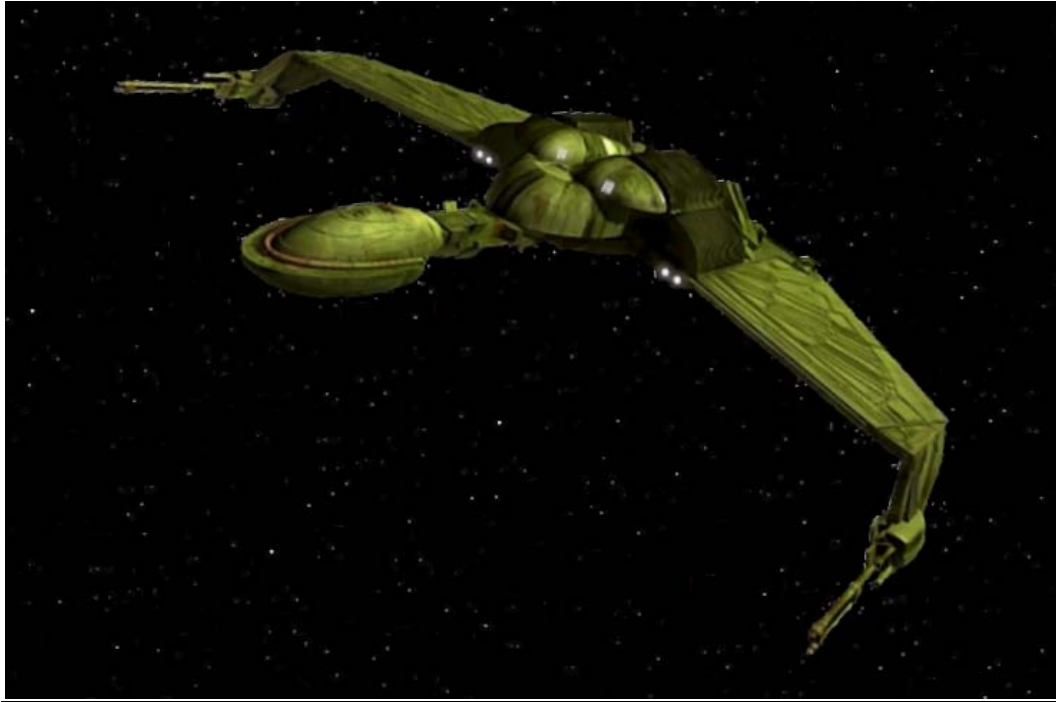

B'rel* class Klingon escort created by Nilos Rodios, Dave Carson, and Leonard Nimoy for the feature film *STAR TREK III – The Search for Spock

Additional background material courtesy of Activision Games, FASA Corporation, Mike Okuda, Doug Drexler, and Donald Burns

Visuals courtesy of SciFiMeshes.com

Schematics by Dana Knutson

Talat Kh'exesta

***DorDuj* type 13 (*kuwikh* type 23) (2275)**

Specifications as built

Dimensions

Length: 250 meters
Beam: 150 meters
Height: 50 meters

Mass

Standard: 290,750 GMT
Displacement: 73,800 DWT

Crew complement

Officers: 12
Enlisted: 50
Imperial Guards: up to 800 (in support of assault operations)

Top velocity

Cruising speed: warp 7.0
Rated maximum speed: warp 8.0
Rated emergency speed: warp 9.0

Endurance

Standard endurance: estimated 3 years at L.Y.V.
Maximum endurance: N/A

Armament

Disruptors: 8 standard disruptors
Other: cloaking device



Known starships

Hull #	Name of starship	Builder	Status
KRD08-001	<i>Talat Kh'exesta (Little Killer)</i>	H'renn Shipyards	active

Talat Kh'exesta (Kl. "Little Killer") was a marked departure from traditional *Drell*-derived designs, sporting angular sides and a slablike, unibody hull with a stylized command boom. It is not known why the Klingons adapted such a radical design for an escort. Most starship historians believe this was in anticipation of the so-called "Taldren generation" that has so shaped modern Klingon starship design.

It is reported that both Klingon officers and enlisted personnel alike were highly critical of *Talat Kh'exesta* until given the chance to try it in combat. Once that happened they found, much to their surprise, that here was a design worthy of note, with combat performance comparable to that of the venerated *Sekleth*.

The sudden and unannounced appearance of a number of *Talat Kh'exesta* in certain "quiet" areas of the Treaty Zone initially caused much confusion within the ranks of Star Fleet. The Klingons played this for all it was worth, seeding false intelligence that the craft were being built by "a new and powerful Klingon ally." It did not take long for Star Fleet Intelligence to discern the truth, however, and soon enough the Klingons withdrew the craft to other areas.

Encountering a *Talat Kh'exesta* nowadays is a something of a rarity. It is believed that the Empire has redeployed most of them along its coreward borders to deal with the more nimble starships of the Cardassians. Enough sightings still occur along both the Federation and Romulan borders (no more than 3-5 per year) to confirm that a small portion have been retained for whatever rimward duties the Klingons feel they are best suited to fulfill.

There are three minor variations and one major one of *Talat Kh'exesta* in Imperial service. The B variant added a reinforced superstructure (upping displacement by some 10,000 metric tons) and more powerful warp engines. The D variant substituted a new, stronger space frame made of a lighter alloy in place of the old one, upping displacement by an additional 3,000 metric tons, and relocated one of the disruptors to a omnidirectional belly mount. The E variant restored the original disruptor configuration but utilized heavier disruptors as well as retaining the new space frame and engines of the C variant. The F variant, the newest to enter service, is identical to the E variant save that six banks of standard disruptors replace the heavier ones used on the E variant.

The C variant never entered Imperial service. According to intelligence reports only one prototype was built. It was the only one fitted with a heavy photon weapons system, which proved to be too much for the space frame to handle. The C variant prototype reportedly blew itself up while attempting to arm and fire a heavy photon torpedo during a live fire test. Consequently, future refinements to *Talat Kh'exesta* focused on finding ways of improving its existing disruptor firepower rather than attempting to

add true heavy weaponry. Efforts at developing a *Talat Kh'exesta* type hull that could handle heavy weaponry would eventually lead to the development of the *Lara'atan* class destroyer. It is not known why the Klingon High Command has not just equipped *Talat Kh'exesta* with standard photon torpedoes. Several House modifications with these have been reported, usually at the expense of the forward disruptor banks.

Estimates for the number of *Talat Kh'exestas* serving the Empire range anywhere from 450 to 1000. The majority of these are the D model, although 120 or so of the B model are still known to exist. Starfleet has captured three B models and two of the D models, and all five now serve with its Adversary Squadron. Only 100 or so of the new F model are known to be in service.

Talat Kh'exesta remains in production within the Empire, with an average construction rate of 14 D models and 20 E models per year. The number of F models being produced is currently unknown.

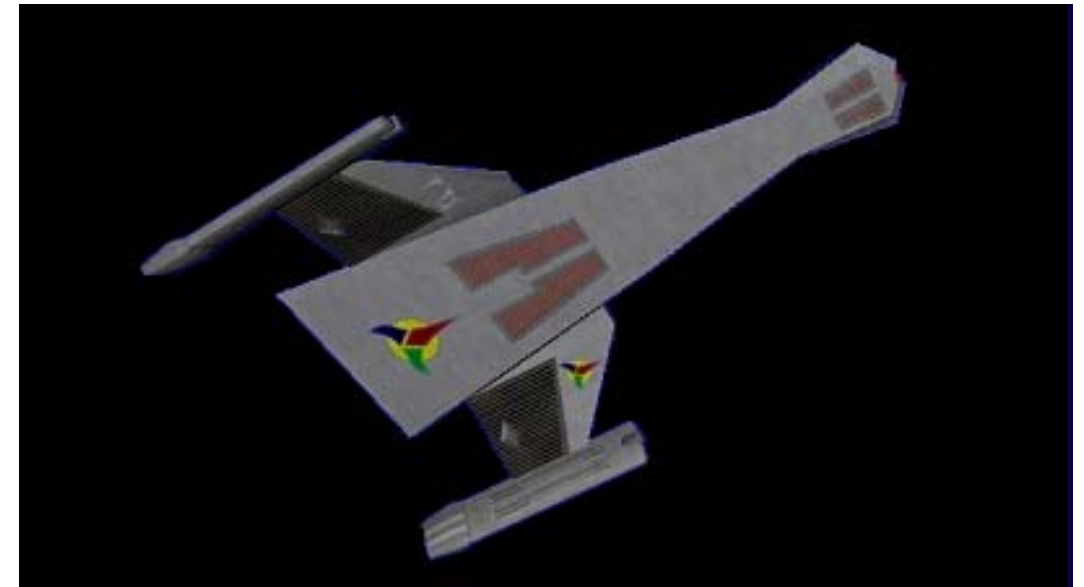

Talat Kh'exesta class Klingon escort created by Forrest G. Brown and Dana Knutson for FASA Corporation's *STAR TREK – The Role-Playing Game*

Additional background material courtesy of Brad Torgerson

Images courtesy of Terradyhne

Kom Kades

***DorDuj* type 14 (*kuwikh* type 24) (2269)**

Specifications as built

Dimensions

Length: 98 meters
Beam: 100 meters
Height: 24 meters

Mass

Standard: 222,750 GMT
Displacement: 81,000 DWT

Crew complement

Officers: 35
Enlisted: 125
Imperial Guards: up to 20 (in support of assault operations)

Top velocity

Cruising speed: warp 6.0
Rated maximum speed: warp 8.0

Endurance

Standard endurance: estimated 1 years at L.Y.V.

Armament

Disruptors: 4 standard disruptors
(1 F/P, 1 F/S, 1 A/P, 1 A/S)
2 heavy disruptors
(2285? refit – both F)
Other: cloaking device

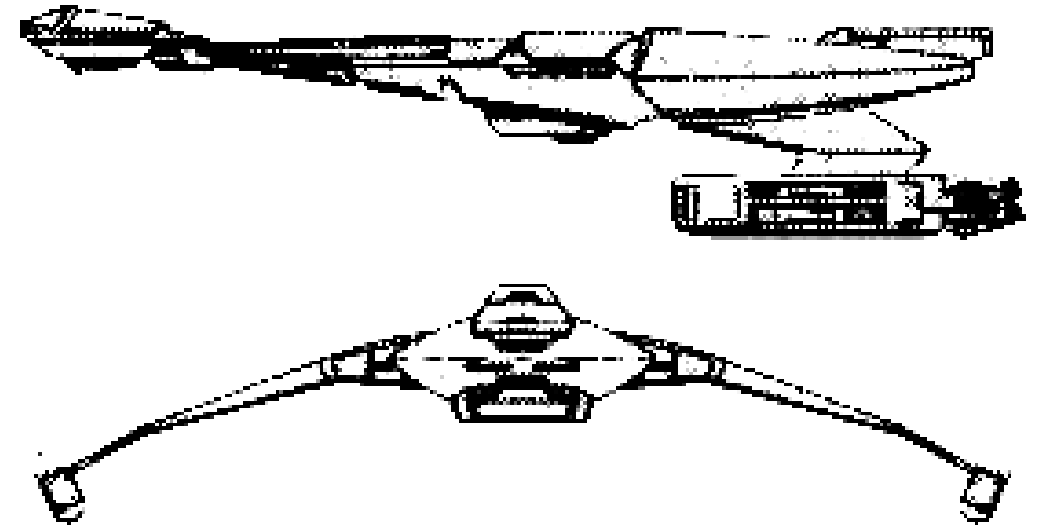

Known starships

Hull #	Name of starship	Builder	Status
KRD08-001	<i>Kom Kades (Winner)</i>	Mustaka Shipyards	active

This design has only been sighted five times since it first entered Imperial service. The first was during Operation Dixie in 2271. The second was during Project Phantom in 2287. In both instances these vessels were spotted operating deep within the Empire itself. Three additional sightings of *Kom Kades* were made along the Treaty Zone in recent years. The first of these was in 2293 by the starship *Eagle* while awaiting orders to commence Operation Retrieve. The other two were in 2296 and 2298.

Intelligence gathered during Operation Dixie revealed that *Kom Kades* (Kl. "winner") is very maneuverable and has a powerful shielding generator for its size. Its only real combat limitation at that time was the lack of heavy weaponry, although this was later rectified by the addition of fleet-standard heavy disruptors. This is the only variant of *Kom Kades* known to date, although indirect evidence suggests the existence of both drone- and photon-armed variants (probably along normal Imperial fleet lines).

This design is yet another of House Kinzan's legendary custom creations. This might explain why *Kom Kades* has not been deployed in great numbers, as the price for House Kinzan's craftsmanship remains rather steep.

It is believed that *Kom Kades* production originated at Mustaka and later shifted to Fonawl. It shifted again to a new facility at Gerly after Fonawl suffered heavy damage during the Praxis Event of 2293. "Over 100" are believed to be to have been built for both Imperial and House service, deployed largely within the Empire itself.

There are unconfirmed reports that the Bloodwatch has secured a *Kom Kades* contract in order to replace its own aging escort classes.

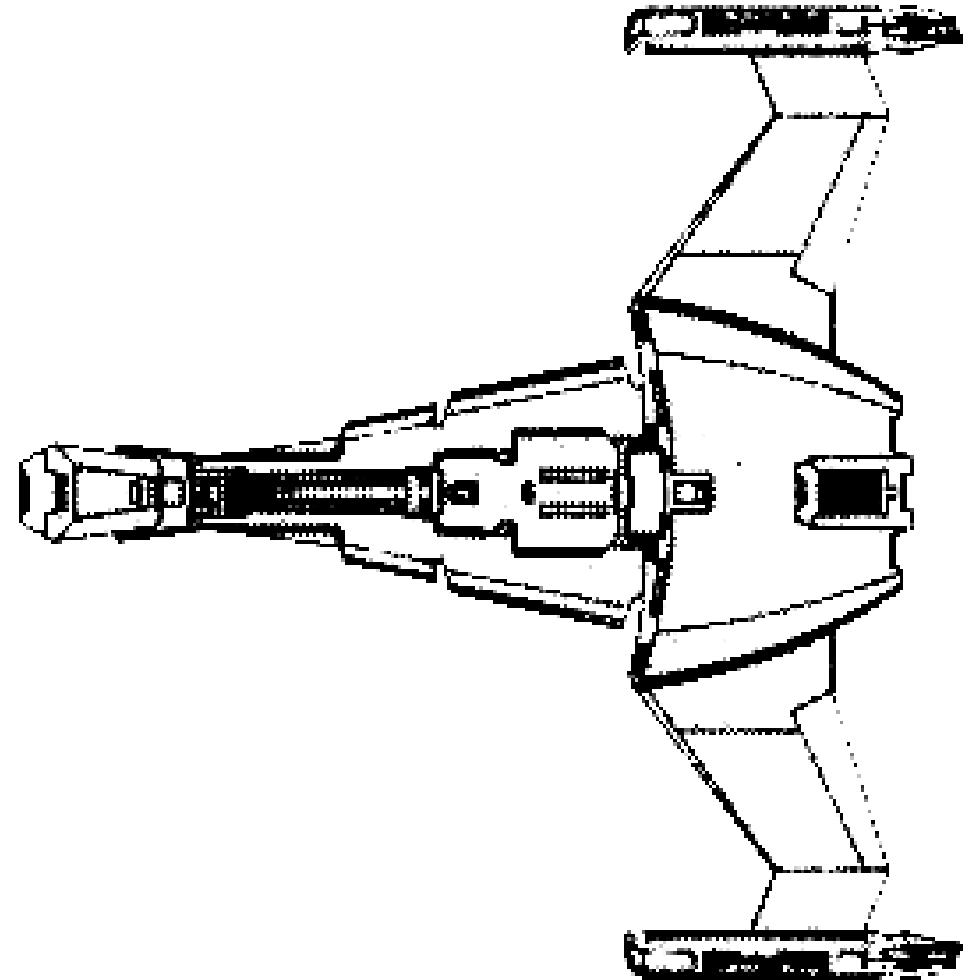

Kom Kades class Klingon escort created by Forrest G. Brown and Dana Knutson
for FASA Corporation's *STAR TREK – The Role-Playing Game*

Additional background material courtesy of Brad Torgerson

Schematics courtesy of Dana Knutson

Mortum Hesta

***DorDuj* type 15 (*kuwikh* type 27) [2270]**

Specifications as built

Dimensions

Length: 160 meters
Beam: 110 meters
Height: 55 meters

Mass

Standard: 192,500 GMT
Displacement: 60,650 DWT

Crew complement

Officers: 30
Enlisted: 127
Imperial Guards: none

Top velocity

Cruising speed: warp 6.0
Rated maximum speed: warp 7.0

Endurance

Standard endurance: estimated 3 years at L.Y.V.
Maximum endurance: N/A

Armament

Disruptors: 2 standard disruptors (1 P, 1 S)
2 heavy disruptors (both F)
Guided weapons: 1 photon torpedo tube (2278? fefit – F only)
4 drone racks (replaces heavy disruptors) (*)
Other: cloaking device

(*) Reported in the Project Grey Ghost Intelligence Summary of 2286 as having been sighted in operation in the Triangle. The report does not make clear when and under what conditions the sighting took place.



Known starships

Hull #	Name of starship	Builder	Status
KRK-27-001	<i>Mortum Hesta</i> (<i>Grim Reaper</i>)	Gerly Spaceworks?	active

Surprisingly little is known about *Mortum Hesta*, one of the most unique Klingon escort designs ever encountered. It was first spotted during Operation Dixie in 2271. An improved model, the first equipped with photon weaponry, was spotted during a Treaty Zone patrol in 2278. A drone-modified variant was reported in the Project Grey Ghost intelligence summary of 2286. That, in a nutshell, sums up all that is known about *Mortum Hesta* aside from limited technical data.

Mortum Hesta appears to be an amalgam of several different components from several different starship designs. The pre-Taldren “hex boom” is obviously borrowed (in a somewhat modified form) from *Talat Kh'exesta*. The secondary hull has similarities to that of the original *L'rexia*, although in this case the single *pljonta'* is mounted over the hull instead of under it. Starfleet Intelligence believes this was done in order to give *Mortum Hesta* the ability for planetary landings and take-offs. There is also evidence to suggest that *Mortum Hesta's* wings are capable of folding upwards in order to facilitate this, although such has never been directly observed either by Starfleet or its intelligence contacts. All models have cloaking capability.

It is believed that the photon torpedo modification of 2278 came about as the result of dissatisfaction with the combat capabilities of the original design. Similar reasoning can probably be applied to the drone-equipped “economy” model reported in the Project Grey Ghost summation of 2286, as it would be better suited for the unpredictable nature of Triangle operations.

Starfleet Intelligence believes that Gerly Spaceworks is the producer of *Mortum Hesta*, although this has yet to be confirmed.

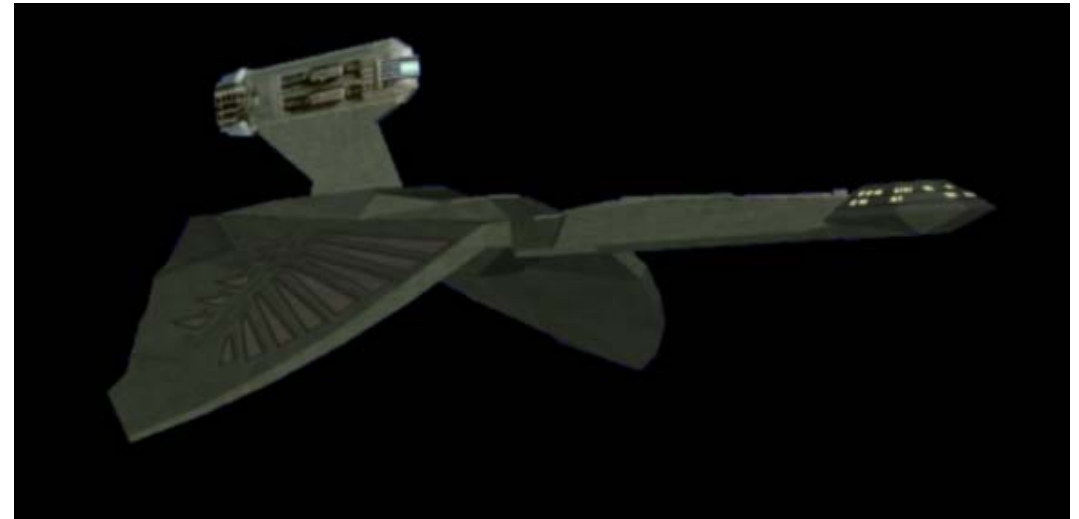

Mortum Hesta* class Klingon escort created by Forrest G. Brown and Dana Knutson for FASA Corporation's *STAR TREK – The Role-Playing Game

Additional background material courtesy of Brad Torgerson

Images courtesy of Paul Brown and Tyrel Lohr



Monitors

K'nel (Kl. “Cursed”) and
QitDuj (tH. “Slow Starship”) series

K'nel

***QitDuj* type 2 (*k'nel* type 30 mod 5) (2275)**

Specifications as built

Dimensions

Length: 106 meters
Beam: 46 meters
Height: 20 meters

Mass

Standard: 99,500 GMT
Displacement: 25,200 DWT

Crew complement

Officers: 6
Enlisted: 24
Imperial Guards: none

Top velocity

Cruising speed: warp 6.0
Rated maximum speed: warp 8.0

Endurance

Standard endurance: estimated 1 year at L.Y.V.

Armament

Disruptors: 6 standard disruptors (2 F, 2 F/P, 2 F/S)
1 heavy disruptor (F only)

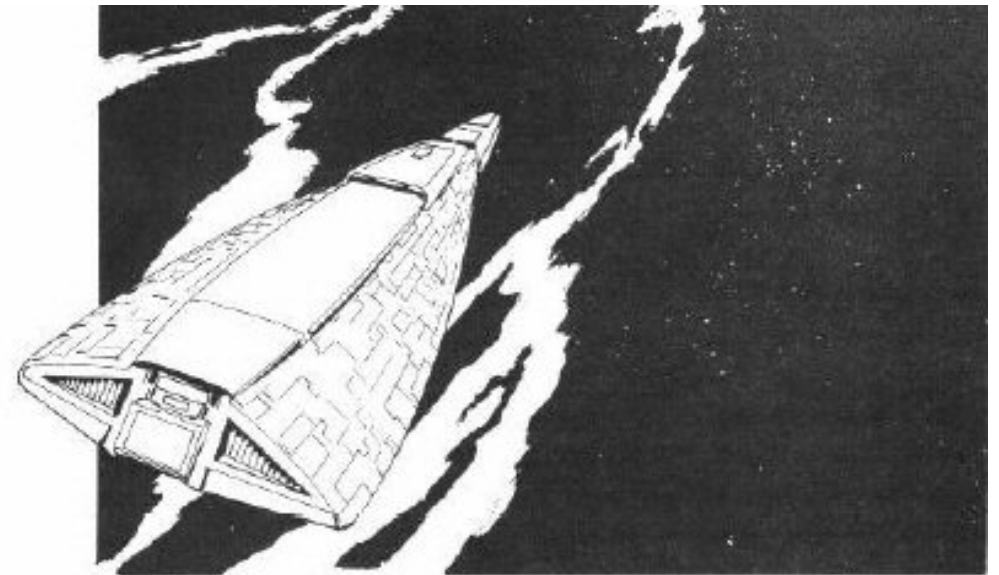

© 1994 Star Trek: The Next Generation

Known starships

Hull #	Name of starship	Builder	Status
KRK30-001	<i>K'nel (Luckless)</i>	Taamar Shipyards	scrapped
KRK30-210	<i>Kurin'pav (Universal Carrier)</i>	Taamar Shipyards	active
KRK30-212	<i>Ricon (Fat Champion)</i>	Taamar Shipyards	active
KRK30-215	<i>Khexlan (Flying Corpse)</i>	Taamar Shipyards	active

The year 2247 saw a new class of fleet monitor enter Imperial service. The K-30 *K'nel* replaced the older and obsolete K-12 *Kl't'bach* (Kl. "Braggart") class, which was incapable of independent operations due to lack of sufficient on-board resources – namely weaponry and propulsion. At that time the Empire was rapidly expanding on several of its borders and needed modern, cost-efficient monitors capable of operating alone.

The name of the class vessel, *K'nel* (Kl. "cursed, luckless, spell-stricken") comes from a series of events that happened not long after the first dozen hulls had been completed. A yard accident at Taamar due to "apparent miscommunication" caused one newly built monitor to cross the path of another during its launch, resulting in a collision. It was so badly damaged as a result that it had to be scrapped, while the other required a rebuild that took seven months. Within a month two more monitors were involved in a similar collision, while a third was attacked and destroyed by a fleet of pirate ships while enroute to its duty station. Yet another that was fitted with experimental shields and impulse engines was severely damaged during a "freak explosion," also resulting in the scrapping of the hull. Two more testbeds for future variants suffered total failures of their impulse engines during space trials and had to be towed back for repairs. This string of bad luck is what earned the class its name.

K'nel is one of the least favorite of all Klingon starships. It is widely derided by modern Klingon warriors as "the Flying Target" (tH. *puv'ta DoS*). Weaponry which was adequate for its designed task back in the mid-23rd century is now hopelessly inadequate. In addition, it lacks sufficient power to both maneuver and power all armaments. *K'nel* assignments, like those of the infamous *Kortak*, are usually doled out as sentences for malcontent or insubordinate behavior.

One unique feature of *K'nel* is that it is capable of landing and lifting off again from a planetary surface. In the past this feature has been exploited for use in everything from simple cargo transport to planetary assault operations support. In modern times Imperial *K'nels* are used primarily in the role of surface-to-space transports, shuttling supplies and cargos to and from a planetary surface during planetary assault operations. A fortunate few have been able to worm their way into combat as a result.

The late Colonel Galt'nah had this to say about the Klingon's fleet's oldest operational monitor. "*K'nel* was originally designed to fill a necessary role, not provide a path to glory. Nowadays, for the Klingon warrior looking to further his fame and reputation, assignment to *K'nel* is a career dead end. At least the poor fools sentenced to serve on *Kortak* have the chance to die gloriously in battle. Those condemned to *K'nel* have none, unless Fate is kind to them."

The current version of *K'nel* in Imperial service is the fifth iteration of the model, representing the last production batch on Taamar's original order. All in all some 244 *K'nels* (mods 1-5) were built, of which only 14 (mod 5) remain in Imperial service. 30 more remain in the service of various Houses, most notably the lesser ones.

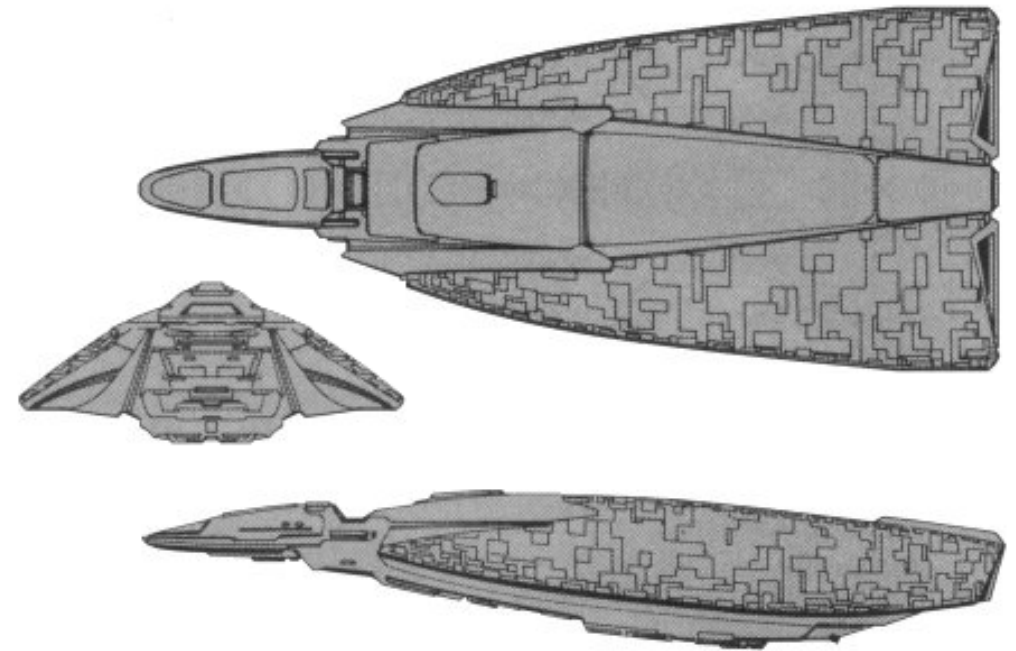

K'nel class Klingon monitor created by Forrest G. Brown and Dana Knutson
for FASA Corporation's *STAR TREK – The Role-Playing Game*

Additional background material courtesy of Brad Torgerson

Artwork and schematics courtesy of Dana Knutson

V'al'kon

***QitDuj* type 3 (*k'nel* type 32) (2255)**

Specifications as built

Dimensions

Length: 250 meters
Beam: 150 meters
Height: 50 meters

Mass

Standard: 290,750 GMT
Displacement: 73,800 DWT

Crew complement

Officers: 12
Enlisted: 50
Imperial Guards: up to 800 (in support of assault operations)

Top velocity

Cruising speed: warp 7.0
Rated maximum speed: warp 8.0
Rated emergency speed: warp 9.0

Endurance

Standard endurance: estimated 3 years at L.Y.V.
Maximum endurance: N/A

Armament

Disruptors: 8 standard disruptors

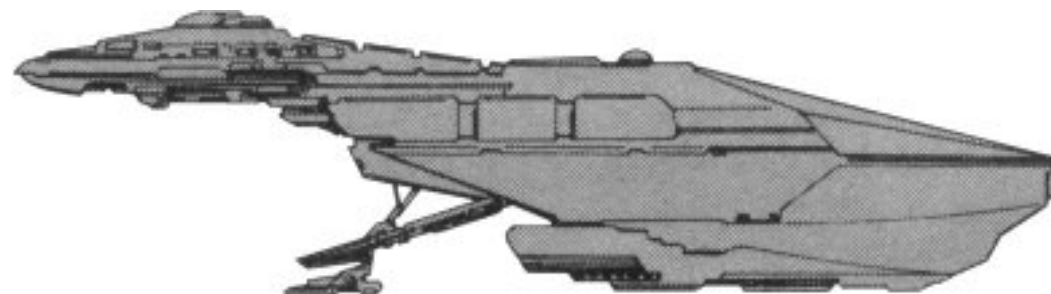

Known starships

Hull #	Name of starship	Builder	Status
KRD08-001	<i>V'al'kon (Strong Victor)</i>	Taamar Shipyards	active

V'al'kon is the modern Klingon fleet monitor, designed to replace the aging and deficient *K'nel* in the role. It was designed to address two problems that plagued earlier Klingon monitors: how to increase their survivability in combat, and how to make them more combat capable without compromising their basic intended function. The first problem was solved with a more powerful shield generator and warp engines than before. The second was the installation of additional heavy disruptors, as well as adding an on-board Imperial Guard contingent for boarding party actions. With these changes *V'al'kon* can at least hold its own for a time until more capable Klingon reinforcements arrive to give it aid.

The key to *V'al'kon's* success is its battery of four heavy disruptors. Such firepower could normally knock out or destroy any starship of destroyer class or smaller and cause considerable trouble for larger combatants. Four more standard disruptors cover *V'al'kon's* sides and rear – a configuration that was (and in some respects still is) most unusual for a Klingon design. These were designed to keep any craft from sneaking up from *V'al'kon* from its rear, such as assault craft rising up from a planetary surface (hence standard as opposed to point-defense disruptors). The arrangement is such that *V'al'kon* is capable of firing all four of its heavy disruptors and all four of its four standard disruptors in either the forward or aft firing arcs. This capability partially offsets its poor maneuverability and slow acceleration. The reason for this is that *V'al'kon* is designed to be a planetary defense monitor, not a true starship combatant. A starship does not need to be all that maneuverable in order to defend a given planet.

As with *K'nel*, its predecessor, *V'al'kon* is capable of planetary landings and take-offs. This capability has seen a number of customized *V'al'kons* built for the Imperial Guard for use as planetary assault landing craft. Troops, vehicles, and gear are normally disgorged from the bow loading ramp, with the ship's own weaponry providing covering fire during landing operations. *V'al'kon* can carry up to 2,100 metric tons of cargo in its hold, which can be filled with battle-ready Imperial Guards, ground assault vehicles, field pieces, combat supplies and equipment, or any mixture thereof. This capability has proven quite useful in situations where transporters will not work due to atmospheric conditions. Indeed, *V'al'kon* has proven so successful in this new role that there is talk of permanently redesignating it as an auxiliary assault ship instead of its intended role as a mere system defense monitor.

Starfleet Intelligence believes that “over 500” *V'al'kons* have been built to date. Taamar is the primary contractor and builds the standard Imperial model. H'rez has been subcontracted for the Imperial Guard custom model. 33 are known to have been destroyed in various encounters and planetary assault operations. “About 30 or so” are believed to be in the service of the various Houses, although the mix of standard-to-custom versions is unknown.

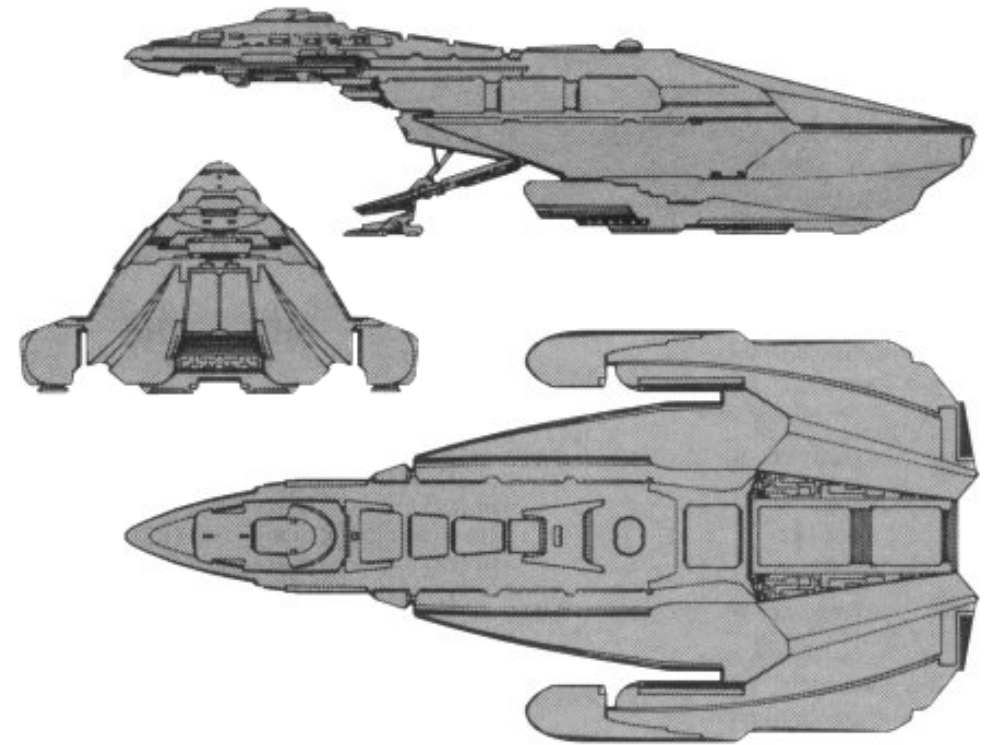

V'al'kon class Klingon monitor created by Forrest G. Brown and Dana Knutson for FASA Corporation's *STAR TREK – The Role-Playing Game*

Additional background material courtesy of Brad Torgerson

Schematics courtesy of Dana Knutson

ᐃᐱᐱᐱᐱᐱᐱ

Patrol Craft

galasta (Kl. “Glory Maker”),
kuwikh (Kl. “Favored Ship”), and
‘avwiDuj (tH. “Patrol Ship”), and
garghDuj (tH. “Serpent Ship”) series

Kalath

'avwIDuj type 2 (kuwikh type 3) (2246)

Specifications as built

Dimensions

Length: 53 meters
Beam: 23 meters
Height: 9 meters

Mass

Standard: 21,250 GMT
Displacement: 8,500 DWT

Crew complement

Officers: 4
Enlisted: 11
Imperial Guards: none

Top velocity

Cruising speed: warp 6.0
Rated maximum speed: warp 7.0

Endurance

Standard endurance: estimated 1 month at L.Y.V.

Armament

Disruptors: 2 standard disruptors (both F)

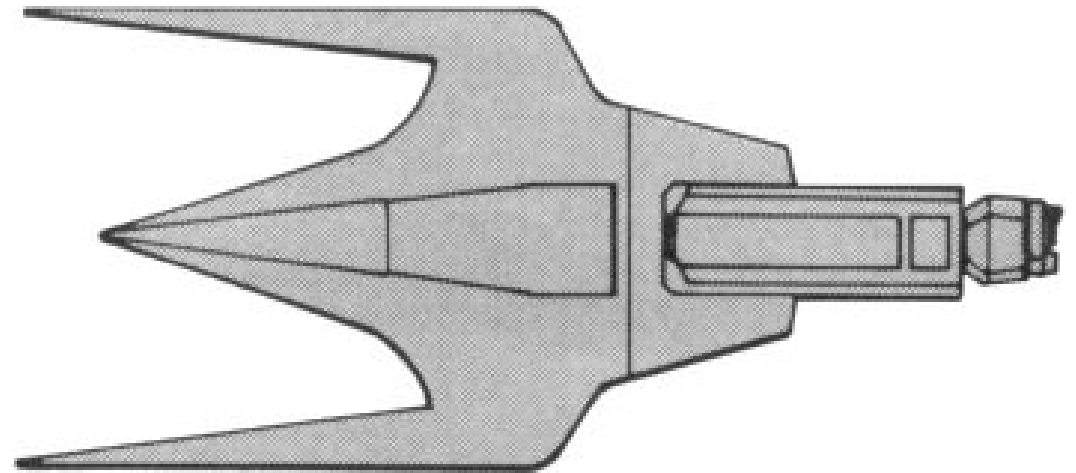

Known starships

Hull #	Name of starship	Builder	Status
KRK03-0001	<i>Kalath (Striker)</i>	Z'hai Spaceworks	sold-R

“Over 1800” *Kalaths* were produced during the century or so that it was the Empire’s premiere patrol ship class. It has seen duty in every sector of Klingon space in every conceivable role for a ship of its size in both Imperial and House service. As it neared obsolescence 123 were given to the Romulans as part of the technology trade protocols of the Treaty of S’maba, where (with plasma weaponry) it found a new lease on life.

Kalath is still a frequent sight along Klingon borders. It is also a common sight in the Triangle, where Romulan conversion sightings are frequent. Large numbers remain in service with the fleets of the Lesser Houses. Surplus decommissioned *Kalath* hulls have found their way into Orion hands, but most sold are purchased for private ownership. These hulls usually wind up being heavily customized by their new owners.

There are two different “stock” variants of *Kalath*: the original 2246 “Z’hai” production model and the 2250 “Taamar” version. The only real difference between the two is that the latter had more powerful *pljonta*’ and a correspondingly stronger space frame. The latter, which was produced exclusively by Taamar Shipyards, is the version sought by purchasers who intend to customize their *Kalaths*. It is often difficult to distinguish between the two without a structural integrity scan, since the older Z’hai model was produced at Gnuu Re’ with the larger *pljonta*’, thus further confusing the issue. To make matters worse, unscrupulous *Kalath* dealers will often install fake braces in Taamar fashion in order to fool potential customers into thinking they are purchasing a Taamar-produced *Kalath*. In all cases a structural integrity scan is all that is needed to distinguish a Taamar *Kalath* from the ones produced at Z’hai and Gnuu Re’.

Kalath is no longer being built, having been replaced by *Kl’xenova* on the Imperial production schedule. These are replacing *Kalaths* in Imperial service on a one-for-one basis as new *Kl’xenovas* are built. The surplus hulls, sans weapons and other sensitive military equipment, are then put up for sale to the highest bidder.

The class name comes from the design’s likeness to a small nocturnal predator native to the planet Veridor.

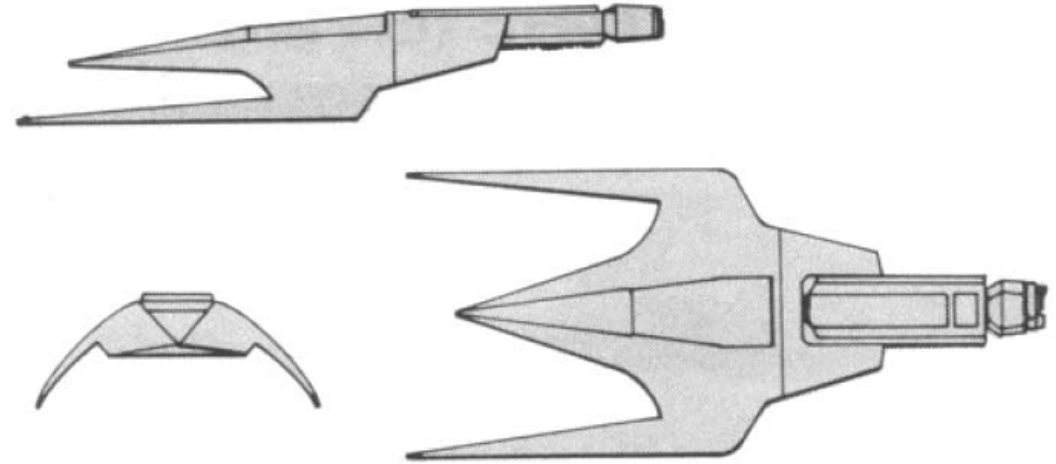

Kalath* class Klingon gunboat created by Forrest G. Brown and Dana Knutson for FASA Corporation’s *STAR TREK – The Role-Playing Game

Additional background material courtesy of Brad Torgerson

Artwork and schematics courtesy of Dana Knutson

nomDuj

'avwIDuj type 3 (kuwikh type 4) (2264)

Specifications as built

Dimensions

Length: 56 meters
Beam: 28 meters
Height: 14 meters

Mass

Standard: 27,500 GMT
Displacement: 11,000 DWT

Crew complement

Officers: 3
Enlisted: 9
Imperial Guards: 6

Top velocity

Cruising speed: warp 6.0
Rated maximum speed: warp 8.0

Endurance

Standard endurance: estimated 1 month at L.Y.V.

Armament

Disruptors: 6 standard disruptors (2 F, 2 F/P, 2 F/S)
1 heavy disruptor (F only)



Known starships

Hull #	Name of starship	Builder	Status
KRK04-0001	<i>Kl'xenova (Guard)</i>	Iosia Shipyards	active
KRK04-0282	<i>nomDuj (Fast Ship)</i>	Fonawl Shipyards	active

In 2260 Iosia Shipyards submitted the design for a new fleet gunboat to the Klingon High Command for prototype construction approval. *Kl'xenova* (pronounced kl'KSEE-no-vah) immediately caught the eye of Chancellor Kessa, with its intriguing combination of speed and firepower on a small form factor hull. Construction was delayed a full year while problems were worked out that were spotted after space trials of the two prototypes Kessa had approved. After that the development process went quickly, with a full production contract awarded to Iosia in late 2263 and auxiliary contracts to Gnuu Re' Fonawl, and H'rez. The first *Kl'xenova* entered Imperial service in mid-2264.

Most modern Klingons have difficulty in pronouncing *Kl'xenova*. It is a Klingonaase word, and the Kl. "xe" sound has always presented a problem for tHlingan hol speakers not versed in the old Imperial tongue. In this case it is immediately preceded by "kl," which makes matters even worse for them. Native tHlingan hol speakers usually wind up mispronouncing the word as *ch'ghInob'a'*, which makes absolutely no sense in their language. For this reason, Chancellor Lotar quietly had the class renamed *nomDuj* (tH. "fast ships") in 2270.

nomDuj was designed with two roles in mind. The first was as a patrol gunboat, assisting escorts and frigates in policing the Empire. The second was as a rapid mass attack vessel, operating in squadrons of six or twelve against larger enemy vessels. In this it anticipated the development of *Kari*, being in effect the Empire's first "fast patrol ship" (although it was not classified as such at the time).

The most famous use of *nomDuj* is also the one most studied by students of interstellar patrol craft operations. Admiral Kaneida's successful campaign against Romulan forces in the Triangle from 2275 to 2280 is considered a landmark example of the use of patrol craft on a fleet scale. Kaneida developed a three-pronged approach to tackling the more powerful Romulan craft, which could have easily beat his own had he followed standard Klingon combat doctrine. Instead, he used his destroyers for the initial engagement and then sent in massed waves of *nomDuj*, all the while pounding his targets with long-range heavy weapons fire from his cruisers. Any Romulan starships thus drawn into battle had to divide their fire against multiple targets, not giving them time either to charge up plasma weapons or re-engage their cloaking devices. Kaneida's campaign was so successful that he practically wiped the Triangle clean of Romulan forces for a time while only losing one cruiser, two destroyers, and seven *nomDuj* in the process. The Kaneida Doctrine has since become an integral part of Klingon patrol ship tactics.

In routine patrol duties *nomDuj* normally carries a contingent of six Imperial guards in addition to their regular crew. These are usually employed as "muscle" during inspections of stopped civilian craft. They can also be employed as a boarding party as need requires, thanks to *nomDuj's* single 6-man transporter.

At the time of its introduction in 2264 *nomDuj* was widely regarded as the most maneuverable major Klingon starship desing to enter service. In that regard it still commands considerable respect, although all of its maneuverability records have been surpassed either by the *B'rel* class Bird-of-Prey or by the *Kari* class fast patrol ship.

***K'nel* class Klingon monitor created by Forrest G. Brown and Dana Knutson
for FASA Corporation's STAR TREK – The Role-Playing Game**

Additional background material courtesy of Brad Torgerson

Artwork and schematics courtesy of Dana Knutson

Lar'hal

'avwIDuj type 5 (kuwikh type 6 mod 3) (2268)

Specifications as built

Dimensions

Length:	55 meters
Beam:	23 meters
Height:	10 meters

Mass (*)

Standard:	26,900 GMT
Displacement:	10,760 DWT (standard)
	11,560 DWT (full load) (*)

Crew complement (*)

Officers:	2
Enlisted:	8 (+ 4 passengers)
Imperial Guards:	none

Top velocity

Cruising speed:	warp 7.0
Rated maximum speed:	warp 9.0

Endurance (*)

Standard endurance:	estimated 6 months at L.Y.V.
---------------------	------------------------------

Armament (*)

Disruptors:	2 standard disruptors (both P/F/S)
	1 heavy disruptor (F only)

(*) Values listed are for the standard Imperial production model. These can vary wildly depending on the current owner, especially in the case of export models. Most *Lar'hals* can carry up to 800 DWT cargo. Crew and passenger complement varies depends on level of customization, as does endurance. Armament varies wildly on civilian export models, with additions made at the expense of cargo capacity. The Romulan P-12 variant replaces the heavy disruptor with a plasma cannon and Romulan-style standard disruptors.



Known starships

Hull #	Name of starship	Builder	Status
KRK06-0001	<i>Lar'hal (Administrator)</i>	Fonawl Shipyards	active

By far the most common Klingon gunboat in service today is *Lar'hal* (Kl. "Administrator"). It is a favorite of the Bloodwatch, i.e. the Internal Security Forces, who operate it in squadrons of five in all parts of the Empire. It can also be found in service as a sector defense ship with House fleets and Imperial border forces. The best place to spot it outside of the Empire, though, is within the Triangle. It can be found there, in one customized form or another, in the service of everybody from independent traders to such major players as the Klingons and Romulans. It is an excellent design for its size and class, although it is no match for large capital ships save in massed numbers.

Lar'hal's origins like in the across-the-board buildup of Imperial fleet strength originally ordered by the late Chancellor Kessa in the early 2260s. Many of these programs, including *Lar'hal*, were continued after Lotar's hopes of war with the Federation were dashed during the Organian Incursion of 2267. In this case *Lar'hal* had the strong backing of the Bloodwatch to ensure that the program continued on track. Both Fonawl and Taamar were contracted for production, with the first *Lar'hal* entering Imperial service from Fonawl in 2268. Production continued non-stop until the Praxis explosion of 2291, but has since resumed at H'rez.

The excellent performance of *Lar'hal* caused its designed mission profile to be expanded beyond exclusive Bloodwatch use during the late 2270s. It is believed that the first dedicated Imperial squadrons entered service around 2277, with House squadrons following shortly thereafter. The first Romulan conversions are believed to have entered service around 2280, and the design was licensed for general export sometime in late 2283 or early 2284. It immediately became one of the best selling of the various modern Klingon export designs: small yet decently armed, nimble and versatile. It worked equally well as both patrol ship and armed personal transport, and serves as such to the present day.

The model 3 version of *Lar'hal* was first introduced in 2269, one year after the original debut of the class and sporting a number of improvements. These included a reinforced superstructure capable of handling twice the stress and damage of the original, a shield generator 150% more powerful than the one used in the model 1, and better than double the firepower of the original. It also sported improved *pljonta*' that were first tested with the model 2, an interim design that never advanced beyond the prototype stage. All model 1 *Lar'hals* that had already been delivered to the Bloodwatch were promptly refitted to the model 3 configuration.

Some Federation civilian starship spotters have conjectured that *Lar'hal* was inspired by or copied from the Federation's own contemporary *Brahe* class long-range warp shuttle. They point out the similarities in form and

pljonta arrangement as proof of their claims, but no evidence has yet been found to confirm this.

"Over 1500" *Lar'hals* are believed to have been built to date per Starfleet Intelligence sources for the service of the Empire. This number includes Bloodwatch units (approximately two-fifths), Imperial and House units (another two-fifths), and those sold for export purposes (the remaining fifth) Approximately 60 per yer were produced by the combined output of Fonawl and Taamar until the Praxis explosion of 2293. The new facility at H'rez is believed to be producing *Lar'hals* at the rate of 10 per year.

At least 220 *Lar'hals* were traded to the Romulans (sans weapons and armaments) under the terms of the Treaty of S'marba in 2279. These were quickly converted for use with Romulan technology and plasma weaponry. This variant is unique to the Romulans and is classified as the P-12 by Starfleet Intelligence.

92 *Lar'hals* are known to have been destroyed or lost in the service of the Empire. 16 have been captured by various parties, including 2 by Starfleet. These two now serve with Starfleet's Adversary Squadron for Command School training purposes.

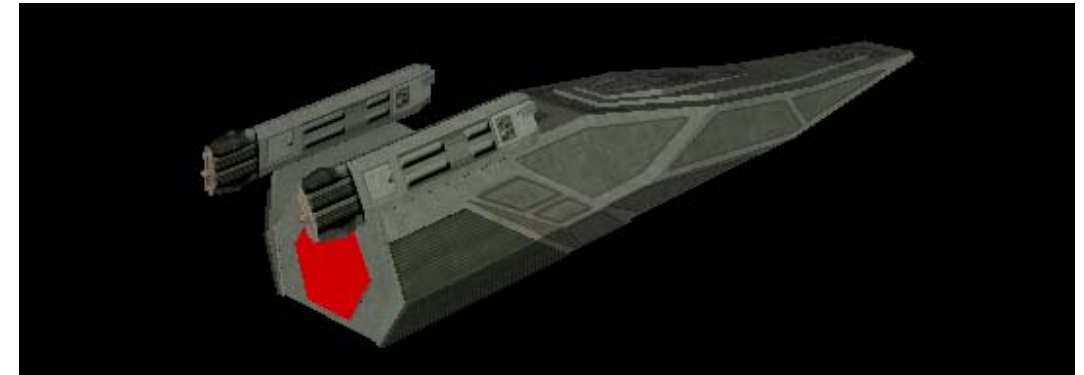

Lar'hal class Klingon gunboat created by Forrest G. Brown and Dana Knutson for FASA Corporation's *STAR TREK – The Role-Playing Game*

Federation *Brahe* class "long-range warp shuttle" inspired by the design of the shuttlecraft *Copernicus* as seen in the TAS episode "The Slaver Weapon" and created by Don Christansen (Filmation)

Additional background material courtesy of Brad Torgerson

Visuals courtesy of Korah

Kari

***gargDuj* type 1 [*kuwikh* type 10] [2289]**

Specifications as built

Dimensions

Length: 35 meters
Beam: 25 meters
Height: 7 meters

Mass

Standard: 20,250 GMT
Displacement: 8,150 DWT

Crew complement

Officers: 2
Enlisted: 4
Imperial Guards: none

Top velocity

Cruising speed: warp 7.0
Rated maximum speed: warp 8.0

Endurance

Standard endurance: estimated 7 days at L.Y.V.

Armament

Disruptors: 2 standard disruptors (both F/P/S)
1 point-defense disruptor (omnidirectional) (*)
1 heavy disruptor (F only)

Guided weapons: 2 drone racks

(*) Included primarily as an anti-drone defense system



Known starships

Hull #	Name of starship	Builder	Status
KRG02-0001	<i>Kari (Guard)</i>	Taamar Shipyards	???

In 2289 the Klingons quietly introduced a new type of patrol ship into their fleet structure. *garghDuj* (tH. “serpent ship”) was the first of the Klingon fast patrol ships (PF in Starfleet nomenclature) and was developed in response to a similar Lyran effort the year before. This type of patrol craft is so small that it can be operated from starships with large hangar bays (such as fleet shuttlecarriers) or from starships modified with special docking clamps (such as *Dath d’lan* and *Desta Kar*).

garghDuj was smaller by far than any Klingon patrol ship that had preceded it. In terms of size it might have classified as a heavy assault shuttle, save for its maneuverability, which approached that of a fighter. For this reason the *garghDuj* classification was created to denote patrol ships small enough to be carried aboard other starships.

Kari (Kl. “guard”) has the same general configuration and profile as the successful *Lara’atan* class frigate, albeit on a considerably smaller hull. This configuration gives it the maneuverability it would otherwise lack with a more conventional design. Interior space is extremely tight, with a single-deck bridge in the forward part of the boom and two decks of cramped engineering spaces aft. Both are connected by a single passageway through the trunk of the boom. A small “hot bunk” area with two sleeping pads is located inside a small well at the base of the boom. This area also doubles as the ship’s infirmary. The rest of *Kari*’s interior spaces are reserved exclusively for weaponry and ship’s systems, save for a small cubicle in the stern for waste disposal. On-board accommodations are extremely spartan, even by Klingon standards.

The specific nature and limited range of patrol ship operations is obvious with a starship like *Kari*. It lacks sufficient interior storage space for supplies and space is not wasted on a replicator. As a rule, *Karis* operate with only those provisions their crews have brought aboard and stashed away in whatever odd corners they can find. One favorite “hot spot” (literally) is the access space above the impulse engine heat exchanger. *Kari* officers are legend for stashing *targ* meat in this area, letting it slow-cook during their missions and thus always having a ready snack on hand.

Kari was the first Klingon patrol ship design to include special docking latches both forward and aft. The forward latch is similar to those used in earlier patrol ships and used for attachment to a mother ship, such as a *Dath d’lan* or other dedicated patrol ship carrier. The rear latch is used to link to another *Kari*’s forward latch for towing and personnel transfer purposes. This latter feature has proved its use time and again both during and after actions involving patrol ships. The crew of a *Kari* damaged beyond repair can be quickly evacuated from their vessel, for instance, or a damaged *Kari* that can be salvaged or repaired can be towed by another

Kari back to the nearest fleet unit or supply base. *Kari*’s engines do not have enough power to tow more than one *Kari* in this manner. It is possible for *Karis* to be transported in “daisy chains” of three by normal starships with the proper adjustments to the ship’s warp field. This is rarely done due to the warp field power requirements and the strain on the docking latches on the *Karis* at the middle and end of the chain. Instead, dedicated docking clamps are normally employed for each *Kari* being transported, as is the case with *Dath d’lan* and *Desta Kar*.

Kari has remained in constant production ever since its introduction in 2289. A *B’rel*-inspired successor, *toQloS* (tH. “little bird”), was first proposed in 2298 and approved the following year. It is expected to enter full-scale production by the end of 2301.

***Kari* class Klingon gunboat created by Steven V. Cole
for Amarill Design Bureau’s *Star Fleet Battles* strategic RPG**

Additional background material inspired by Forrest G. Brown

Image courtesy of Battleclinic.com



Fleet Transports

gavurta (Kl. “Fat Bird”),
nivipav (Kl. “Flying Container”),
and *HijDuj* (tH. “Transport Starship”) series

Fleet Transports

Most civilians are surprised when they learn that the Klingon Empire has a wide range of auxiliary starship classes at their disposal. This runs counter to the popular notion that the Imperial Fleet consists solely of warships of every size and description. Even the Klingons have acknowledged the reality that a space fleet is only as good as its supporting infrastructure. To that end they can match the Federation in almost every category of auxiliary and support craft.

It was in fact the Klingon Empire that took the idea of the fleet transport/tug and raised it to its current level of excellence. Their first effort in this regard, *Har'tu*, may have been less than impressive, but it soon followed by *Morast*. The later is without doubt the single most influential transport/tug design produced by any of the known major interstellar powers in modern times. Testimony to this lies in the fact that it continues to hold up well even today against *Tormin*, its more modern successor.



A modernized *Har'tu* on a typical transport run

Har`tu

***HijDuj* type 1 (*nivipav* type 5) (2239)**

Specifications as built

Dimensions

Length: 145 meters
Beam: 67 meters
Height: 48 meters

Mass

Standard: 92,500 GMT
Subspace displacement: 23,250 DWT (empty)
78,750 DWT (full load, no pods)

Crew complement

Officers: 10
Enlisted: 73
Imperial Guards: none

Top velocity

Cruising speed: warp 4.0
Rated maximum speed: warp 6.0

Endurance

Standard endurance: estimated 1 year at L.Y.V.

Armament

Disruptors: 2 standard disruptors (2 F)
4 point-defense disruptors (2 ea P/S)
2 heavy disruptors (both F)



Known starships

Hull #	Name of starship	Builder	Status
KRN07-001	<i>Har'tu (Gamble)</i>	Mustaka Shipyards	active

Har'tu (Kl. "Gamble") was the first-ever Klingon container transport starship ever observed by the Federation. It is believed to have been inspired by the successful Federation *Bering* class modular transport of the early 23rd century.

Har'tu is basically a retooled *Dupat* converted for auxiliary use. It can serve as both transport and container ship. Its secondary hull form factor was redesigned for its new role. Weaponry was reduced accordingly, with only two standard disruptors mounted in its boom "bulb" and point defense disruptors on the rest of the ship to ward off the occasional pirate attacks. On its own it can transport over 45,000 tons of cargo in its aft storage holds. This increases considerably once transport containers are attached.

With *Har'tu* came the first standardized Imperial transport container system to see service. The G-type series, or *g'al'pav* (Kl. "Super Box") as they are known to the Klingons, were even larger than their Federation Class I contemporaries. Their sheer size also limited the ability for *Har'tu* to transport them (only two at absolute maximum, in comparison to *Ptolemy's* three-container emergency limit). This limitation was in part responsible for the building of an even more sophisticated fleet transport (*Morast*) that could carry more.

All *Har'tu* class starships still in Klingon service in any capacity received the Imperial standard shielding refit of the 2260s. Many in House service also received a limited 2280s era modernization (see illustrations). The installation of more powerful *pljonta'* at this time upped their towing capacity to three G-type containers. A few have even been modified to carry the newer T-series containers, or *taj'pav* (Kl. "dagger box). These can only carry one of these at a time due to their unique design.

No *Har'tu* remains in Imperial service today. They remain plentiful, though, in the fleets of the Lesser Houses. They are also popular with those Triangle traders that have been lucky enough to find them for sale. The Romulans have been seen operating *Har'tus*, ostensibly purchased under the terms of the Treaty of S'marba, and the Orions are known to have "a few" in their possession. Star Fleet has at least 5, along with 11 G-type containers, available for use by its Adversary Squadron. These are all rebuilt from war prizes claimed from the Klingons in various battles and unofficial combat encounters over the years.

Schematics

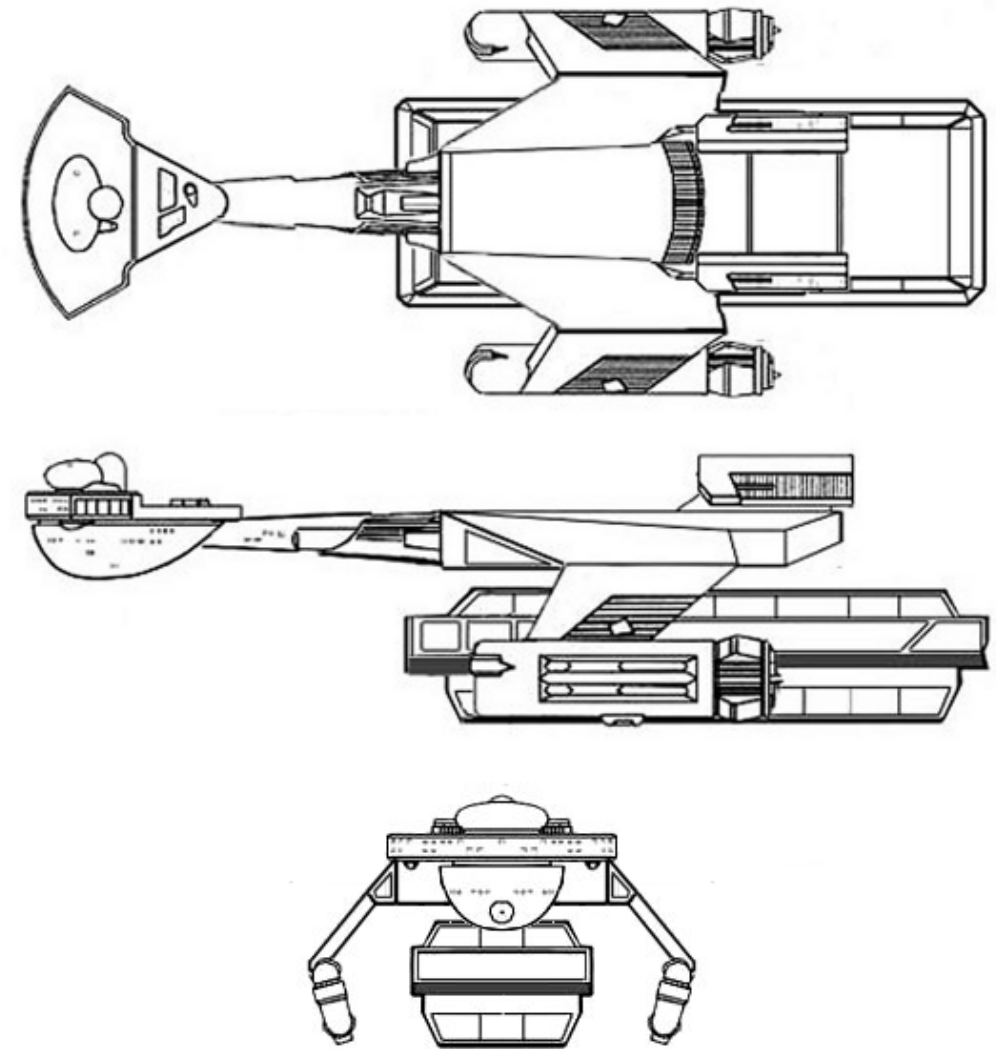



***Har'tu* class Klingon fleet transport/tug created by Eric "Jackill" Kristiansen based on a design by Patrick Flannery (*Star Fleet Handbook* #10)**

Schematics by Richard Mandel

Images courtesy of Terradhyne

Morast

HijDuj type 2 (nivipav type 6) **(2246)**

Specifications as built

Dimensions

Length: 178 meters
Beam: 127 meters
Height: 48 meters

Mass

Standard: 325,500 GMT
Displacement: 81,750 DWT (empty)
168,500 DWT (full load, no pods)

Crew complement

Officers: 15
Enlisted: 80
Imperial Guards: none

Top velocity

Cruising speed: warp 6
Rated maximum speed: warp 7

Endurance

Standard endurance: estimated 3 years at L.Y.V.

Armament

Disruptors: 3 standard disruptors (all F)
4 point-defense disruptors (2 ea P/S)
2 heavy disruptors (both F)



Known starships

Hull #	Name of starship	Builder	Status
KRN05-001	<i>Morast (Speedy Barge)</i>	Gnuu Re' Shipyards	active

Morast (Kl. “Speedy Barge”) is the standard by which all Klingon transport/tugs are measured. It struck an almost perfect balance between design sensibilities and transport capacity. In its day it was unmatched for its cargo transport capability. Even today, with newer designs in the field, it has still managed to hold its own against its younger competitors.

Once the design deficiencies of *Har'tu* became clear, a larger and more powerful Imperial fleet transport was inevitable. This time around the contract went to Gnuu Re' Shipyards, which had been building starships for the Empire for centuries. The specifications were clear: the new transport had to be larger, with more internal cargo capacity, and the ability to tow more G-type cargo pods than *Har'tu*. One important consideration was that the new ship had to be combat capable with no pods attached. Many *Har'tus* had been lost in battle or surprise attacks for lack of combat capability. The Klingon High Command at the time felt that any ship it wielded needed to be as good as any regular warship, hence the unusual requirement.

Gnuu Re' did the same thing as did Mustaka in designing *Morast* in that it used the popular *Dupat* as its design basis. The main difference was that it retained as much of *Dupat's* secondary hull form factor as it could while meeting design requirements. The additional cargo holds were installed in a large aft hull extension, thus allowing the rest of the hull to retain its normal *Drell* form factor. This gave *Morast* four immediate advantages over *Har'tu*. First, retaining the basic *Drell* form factor practically guaranteed *Morast's* nimbleness in a combat situation (provided it didn't have or jettisoned any towed container pods). The impact on *Morast's* warp field by its aft cargo hold extension was minimal in comparison to the effects caused by *Har'tu's* redesigned secondary hull. Second, retaining the *Dupat* hull form made for easier and less expensive construction. It has been estimated that *Morast* and *Dupat* shared over 65% common components. The cost savings alone was enormous, not to mention the easing of many procurement headaches as a result of this. Third, the fact that *Morast's* secondary hull form was wider than *Har'tu* allowed it to carry two G-type cargo containers side-by-side, which in turn led to the final advantage. Fourth, the fact that *Morast* shared *Dupat's* more powerful *pljonta'* meant that it could tow more transport containers than could *Har'tu*. In fact, it could tow up to four G-type containers with relative ease and six in an emergency, while *Har'tu* had problems with only two (at the time). It should come as no surprise that *Morast* quickly replaced *Har'tu* as the Imperial standard fleet transport. It continues proudly in Imperial service to this day.

Morast continues to serve in both Imperial and House fleets. Most have been modified to carry the newer *taj'pav*, or T-series containers, as well as

the older *g'al'pav*, or G-series. *Morast* can only carry two of the newer G-series due to their unique design.

It is common nowadays to focus on Klingon warship designs; however, the impact of *Morast* on interstellar transport/tug design cannot be discounted. Every other interstellar power at the time raced to get fleet transport/tugs into service that matched or exceeded the capabilities of *Morast*. The best known examples is the Federation Star Fleet's own *Dollond* and *Hensley* programs; however, they are not alone. The Romulan *Sparrowhawk-T* and Mirak “Fat Cat” are also part of this group of *Morast*-inspired designs. Its successor, *Tormin*, is little more than a *Morast* rebuilt with *Klolode* components as opposed to the older *Dupat*, but its design still follows the familiar *Morast* pattern. The Klingons may think of themselves as the greatest warriors in the galaxy, but with *Morast* they have inadvertently proven themselves as possibly its greatest freight-haulers.

Schematics

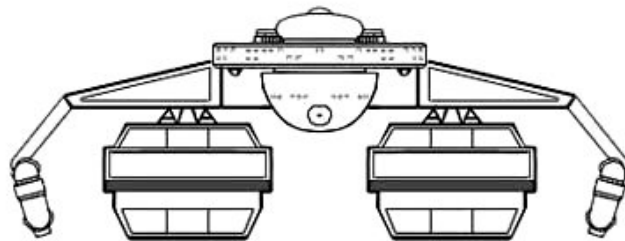
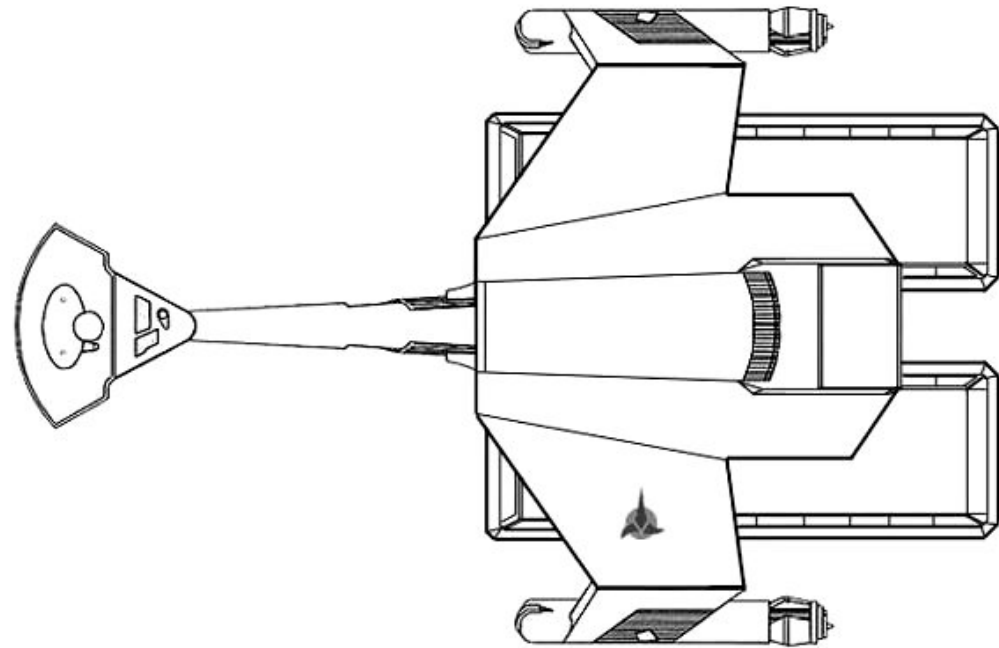
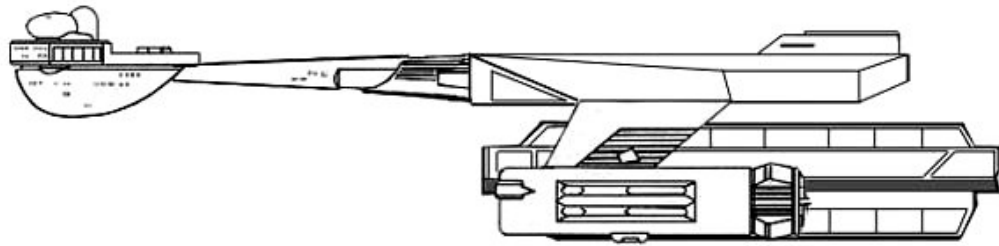

Morast class Klingon fleet transport/tug created by Patrick Flannery (*Star Fleet Handbook* #10)

Class name by Eric "Jackill" Kristiansen

Images courtesy of Atrahasis

Schematics by Patrick Flannery

Tormin

***HijDuj* type 3 (*nivipav* type 7) (2258)**

Specifications as built

Dimensions

Length: 205 meters
Beam: 160 meters
Height: 58 meters

Mass

Standard: 409,500 GMT
Displacement: 97,500 DWT (empty)
208,000 DWT (full load, no pods)

Crew complement

Officers: 83
Enlisted: 272
Imperial Guards: none

Top velocity

Cruising speed: warp 6
Rated maximum speed: warp 7

Endurance

Standard endurance: estimated 3 years at L.Y.V.

Armament

Disruptors: 6 standard disruptors (2 F, 2 A, 1 ea P/S)
4 point-defense disruptors (2 P/A, 2 P/S)
2 heavy disruptors (both F)

Guided weapons: 1 photon torpedo (F)

Other: cloaking device

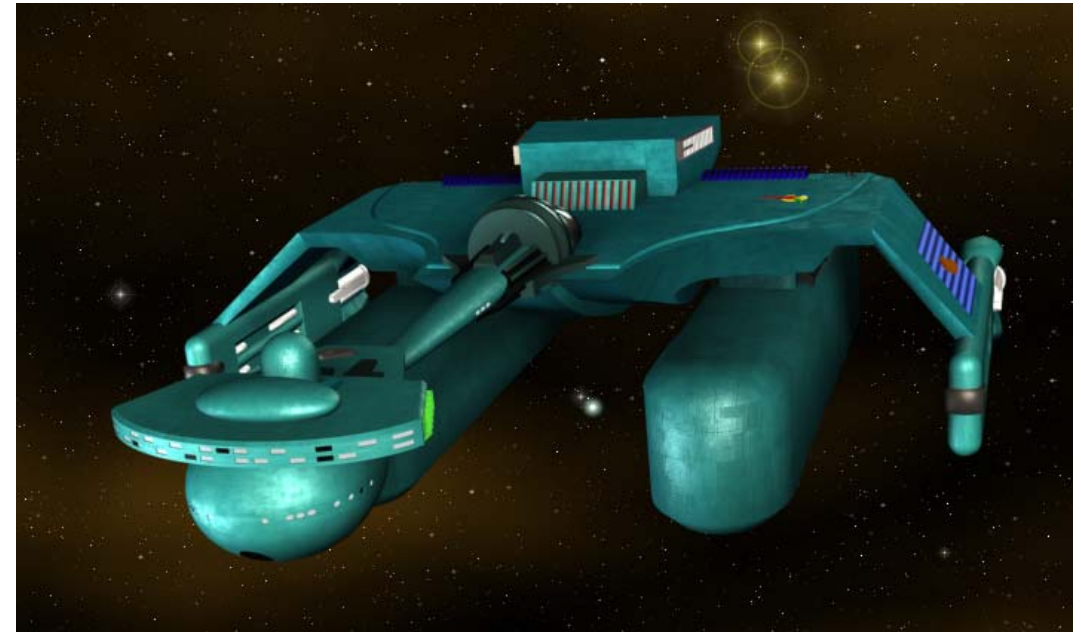

Known starships

Hull #	Name of starship	Builder	Status
KRN07-001	<i>Tormin (Kommisar)</i>	Gnuu Re' Shipyards	active

Tormin (Kl. "Kommissar") was the standard Klingon fleet transport/tug of the 2260s and 2270s. It was the successor to *Morast*, another excellent design that was the first modern multi-container fleet transport/tug to serve the Empire. *Morast* in turn was the successor of *Har'tu*, which was the first successful attempt to adapt a *Drell*-type hull for fleet transport/tug use. Whereas *Har'tu* had been limited to a maximum of two G-type containers, *Morast* could tow up to four. *Tormin* retained this capability from *Morast* and added to it an improved defensive weapons battery (including the first photon torpedo system ever mounted on a fleet transport/tug) and the ability to handle the new T-type containers. Today *Tormin* is the workhorse of the Imperial transport fleet.

Tormin was ordered during a time of heightened tensions with both the Federation and the Romulans. As such it has many features that are not normally found on a fleet transport/tug. It carries cruiser-class armament, including heavy weapons, for one. This was because studies had shown that earlier Klingon transport designs often fell victim to convoy raids due to lack of protection. Convoy raiders would draw off their escorts and then swoop in to attack the convoy itself, whose ships often had little or no protection. *Tormin's* design makes raiders think twice about attacking an Imperial transport colony. Once they jettison their pods, they perform about as well as a normal *Drell*-type battlecruiser. The addition of photon weaponry and cloaking devices during the 2270s also did much to enhance both survivability and combat performance.

It should be noted that *Tormin* does not have an aft firing photon torpedo tube as would a regular *Drell*-type design, nor have Imperial models ever been fitted with one. The space where the system would normally go is part of the *Tormin's* internal cargo hold. There are reports of House customizations with this feature, albeit at the expense of internal cargo space.

Tormin was and continues to be an expensive design to produce. The fact that it is one of the few combat-capable auxiliaries in the service of the Empire has assured its survival, not to mention a measure of respect with Klingon warriors in general; nevertheless, such features come at a high price. Even the fact that the command boom and *pljonta'* are *Klolode/K't'inga* standard has not made much of a dent in the cost of *Tormin's* specialized secondary hull. This kept production down to just two per year, with one each coming from the shipyards at Gnuu Re' (the primary contract holder) and Mustaka (an auxiliary contractor). There were plans at one time to begin construction of a third *Tormin* production line at B'treliq but this effort came to naught due to the Praxis explosion of 2293. That same event also so damaged the *Tormin* facilities at Mustaka that

production has been unable to restart ever since. It is believed that Mustaka's facilities will not be repaired until most of the Empire's warship production lines are resumed, as they hold higher priority than those of auxiliary classes.

Schematics

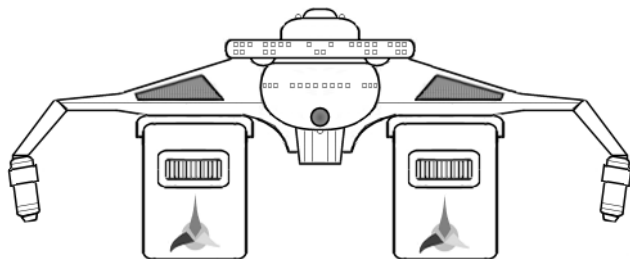
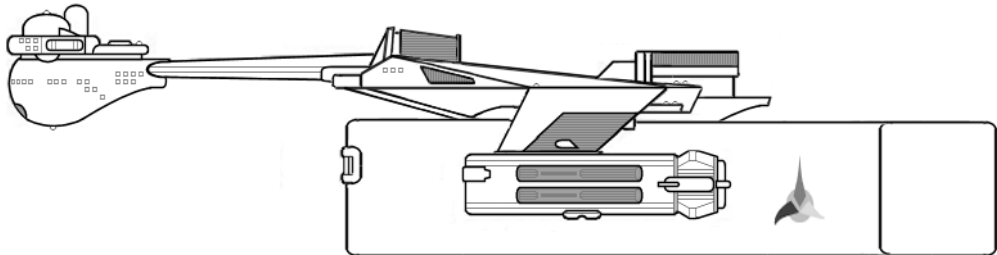
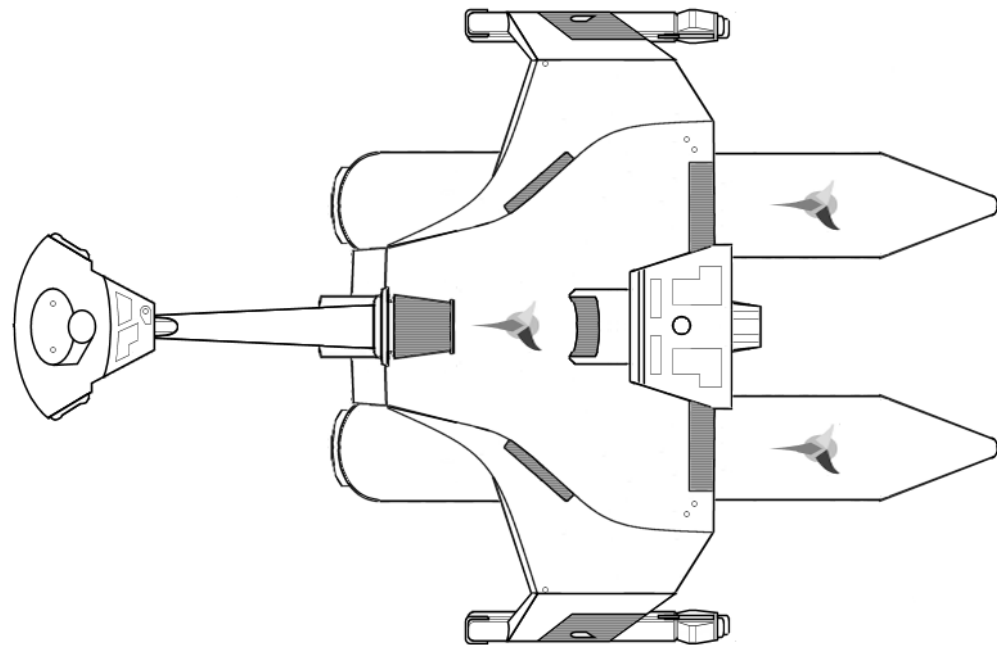

***Tormin* class Klingon fleet transport/tug created by Steven V. Cole for the *Star Fleet Battles* role-playing game by Amarillo Design Bureau**

Additional background material courtesy of Amarillo Design Bureau

Images courtesy of Ted W. Giebel (SFB Nexus)

**Schematics by Richard Mandel
Based on the work of Neale Davidson (Pixel Sagas)**

Baka Re

***HijDuj* type 3 (*gavurta* type 3) (2262)**

Specifications as built

Dimensions

Length: 240 meters
Beam: 140 meters
Height: 60 meters

Mass

Standard: 480,750 GMT
Displacement: 113,000 DWT (empty)
298,000 DWT (full load)

Crew complement

Officers: 12
Enlisted: 20 (+ accommodations for 10 more)

Top velocity

Cruising speed: warp 4 (full load)
warp 6 (unladen)
Rated maximum speed: warp 6 (full load)
warp 8 (unladen)

Endurance

Standard endurance: estimated 3 years at L.Y.V.

Armament (*)

Disruptors: 2 standard disruptors (both F)
5 point-defense disruptors
(1 F/P, 1 F/S, 1 A/P, 1 A/S, 1 omni)

(*) Reflects standard Imperial version. House customizations can include any (and some combinations) of the following: all disruptors upgraded to standard models and up to four additional standard disruptors (usually 2 ea P/S), dual heavy disruptors (both F), a boom-mounted "light" photon torpedo (F), drone racks, a stasis field generator, and even (on one memorable occasion) a cloaking device.



Known starships

Hull #	Name of starship	Builder	Status
KRG03-001	<i>Baka Re (Pregnant)</i>	Gnuu Re' Shipyards	active

In its heyday *Baka Re* was the dedicated transport design of choice both by the Imperial fleet and the Great Houses. Derived from the *D'aka* class assault ship, *Baka Re* amounted to little more than a *D'aka* with a significantly enlarged keel bulge. Two major protrusions extended behind and below the hull, providing extra room for dedicated cargo holds, oversized transfer hatches, and the like. It is said that when the design was first submitted to the Klingon High Council for approval, one of the councilors joked that it looked like a pregnant battlecruiser (Kl. *baka re lo Drell*, lit. "the *Drell* is with child"); hence the name for the lead ship of the class.

Soon after their introduction into Imperial service *Baka Re* became a favorite of sector commanders and individual warlords. They were far less expensive than *Tormin* to purchase and operate, thus they were perfectly suited for the types of off-the-record missions for which independent-minded Klingon regional leaders are legend. These frequently consisted of equal parts honest trade, smuggling, and outright looting of helpless subject worlds. *Baka Res* employed in such fashion would often be considerably upgunned after the manner of *Tormin* and other more powerful fleet transports, so as to discourage any attempts to relieve them of their cargo. This upgunning also had an important side benefit: it provided these regional leaders with a ready-made fleet of (somewhat) disposable warships for whatever local havoc he or she wanted to raise.

It may strike the reader as odd that Klingons would develop any kind of affection for a transport ship, even a heavily armed one. One must not forget, however, the old Klingon proverb, which in Standard translates as: "The same arm wields both sword and scythe." *Baka Re* is a proven starship design despite its ungainly looks. It is an excellent transport and also a fair combatant (for a transport) when suitably outfitted. It actually performs better than a laden *Tormin* with transport pods, although it cannot come close to comparing with an unladen *Tormin*. The wild card, of course, is the weapons mix. Starfleet personnel are advised to be on their guard in this respect, as the weapons loadout on any given *Baka Re* will depend on two things: whether or not it is an Imperial or House vessel and whether or not it shows an abnormal energy distribution pattern on an initial sensor scan. *Baka Res* have even been reported as operating as escort or auxiliary shuttlecarriers, conducting flight operations via the triple-deck cargo access hatch on the rear of the ship's ventral keel bulge. It is for this reason that *Baka Re* has earned the unofficial nickname of "the Klingon's chameleon ship." The explanation is that you never know quite what to expect should you happen to encounter one.

Baka Re and its successors, *yGr'oth* and *Plen Zha*, were originally classified as *gavurta* (Kl. "fat birds"), or general purpose transports, in order to distinguish them from *nivipav* (Kl. "box of many contents"), the term used for multipurpose fleet transport/tugs. Both are classified as *HljDuj* (tH. "transport starships") under the proposed new system of nomenclature.

Baka Re has long since been supplanted by newer and more capable designs. Between 2262 and 2285 "at least 200" *Baka Res* are believed to have been built. They remain a common sight in the Triangle and in the service of the Lesser House fleets. Four have been spotted in Romulan markings and at least three are under the ownership of various Orion merchant cartels.

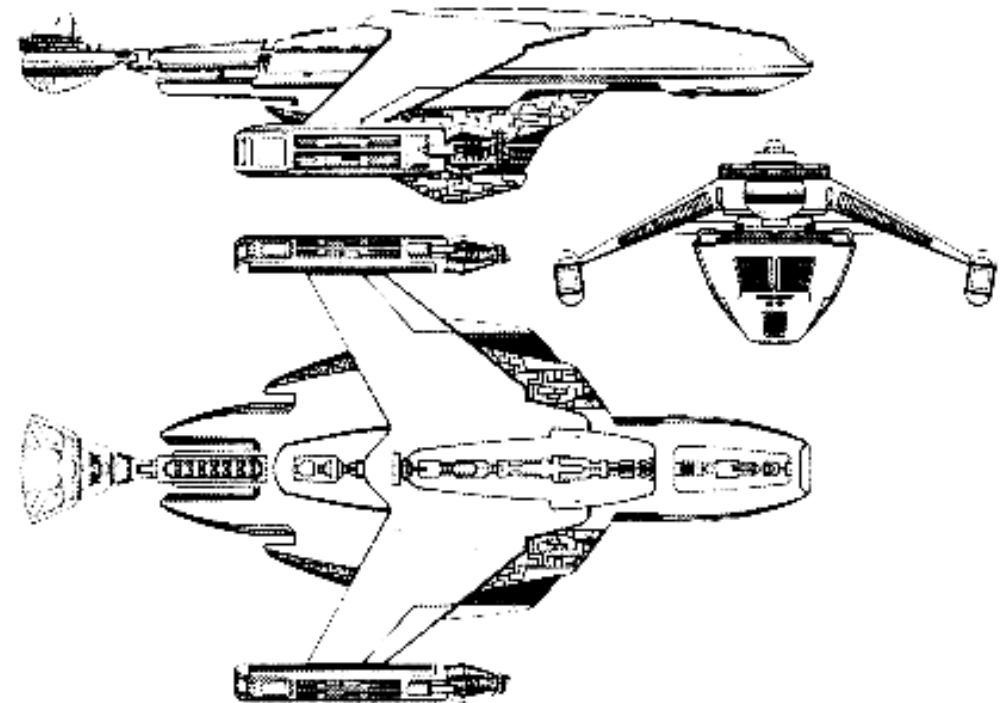

Baka Re class Klingon transport created by Forrest G. Brown and Dana Knutson for FASA Corporation's *STAR TREK – The Role-Playing Game*

Additional background material courtesy of Brad Torgerson and Julian Bolinger

Schematics courtesy of Dana Knutson
Image courtesy of Julian Bolinger

Plen Zha

***HijDuj* type 5 (*gavurta* type 8) (2268)**

Specifications as built

Dimensions

Length: 210 meters
Beam: 100 meters
Height: 60 meters

Mass

Standard: 525,250 GMT
Displacement: 135,200 DWT (empty)
250,200 DWT (full load)

Crew complement

Officers: 5
Enlisted: 19 (+ accommodations for 10 more)

Top velocity

Cruising speed: warp 4 (full load)
warp 6 (unladen)
Rated maximum speed: warp 5 (full load)
warp 8 (unladen)

Endurance

Standard endurance: estimated 3 years at L.Y.V.

Armament (*)

Disruptors: 4 standard disruptors (2 F, 2 A)
4 point-defense disruptors (2 ea. P/S)
2 heavy disruptors (both F)

(*) Reflects standard Imperial version. House customizations can include any (and some combinations) of the following: all disruptors upgraded to standard models and up to four additional standard disruptors (usually 2 ea P/S), a boom-mounted "light" photon torpedo (F), drone racks, a stasis field generator, and even a cloaking device.

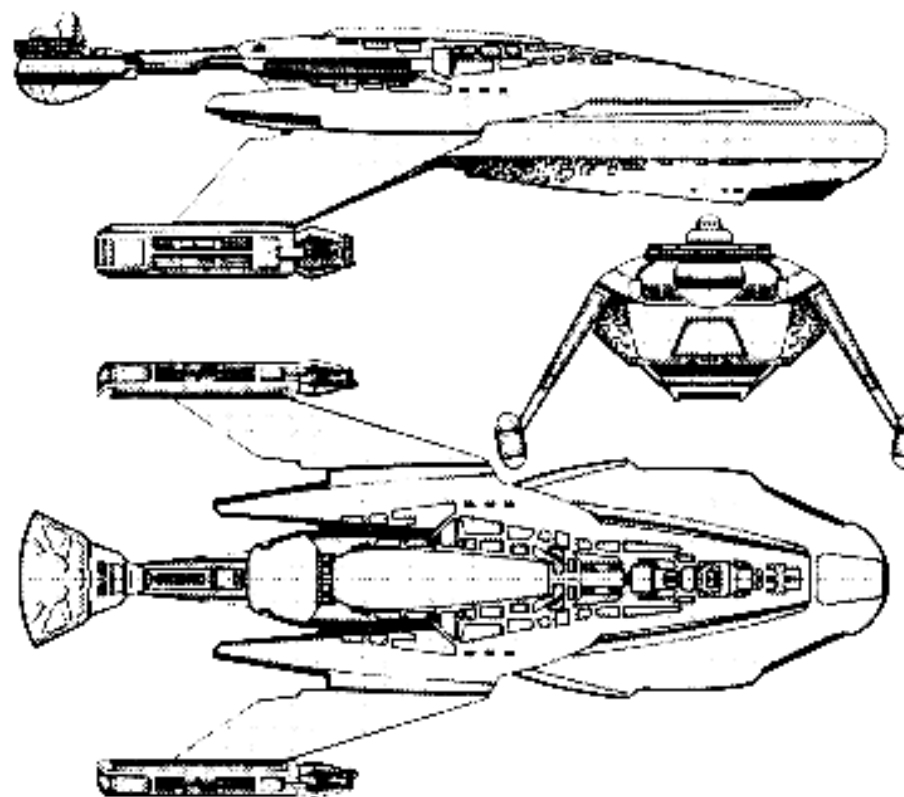

Known starships

Hull #	Name of starship	Builder	Status
KRG08-001	<i>Plen Zha (Trader's Game)</i>	Gnuu Re' Shipyards	active

Given the initial success of *Baka Re*, it seemed only natural that somebody would try its hand at updating the design. Taamar Shipyards, one of the largest in the Empire, decided to give it a go in 2265. Their version eliminated the ventral bulge in favor of an elongated aft “drop” bulge. It did the looks of the design no favor, with it immediately earning the unofficial label of *puchba’pom* (tH. lit. “the squatting shitter”). Others jokingly likened it to the *puvaw’gew*, a large Klingon insect with a prominent sternum similar to that of a Terran wasp. Despite this, or perhaps because the Klingon appreciate a good laugh as much as a good fight, Taamar’s new design quickly won approval. Both labels were quietly rejected for the official title of the class. Instead, the lead ship was named after the *Plen Zha* (Kl. “trader’s game”), a legendary Klingon trading ship from the Empire’s formative days in interstellar space. The design soon proved even more successful than its predecessor *Baka Re*. Within a decade it had passed *Baka Re*’s numbers to become the standard general purpose transport of choice within the Empire.

Plen Zha is best known to Federation citizens for the part three of its members played in Operation Dixie, the failed attempt by Starfleet Command in 2271 to gather critical intelligence from within the heart of the Klingon Empire itself. Three *Plen Zhas* were purchased covertly by intelligence operatives, crewed with Federation agents and Klingon contacts, and then sent on what was ostensibly a transport run through the Klingon inner systems. The operation did not go as planned, however, due to the fact that a deep cover mole within Starfleet Command itself alerted the Empire to the operation well in advance. They were allowed to see only what the Klingon High Command wanted them to see – an Empire building up its strength – before the ships were successfully tricked into diverting to the new Klingon naval base at Marram IX, about which the Federation had no knowledge at the time. All three ships were subsequently lost. The failure of Operation Dixie eventually grew into a scandal that caused a major shake-up within Starfleet command in the early 2280s. The ultimate fate of the transport crews and what additional intelligence they were able to gather was not learned until 2287, when one of the shuttlecraft from the Dixie *Plen Zhas* unexpectedly turned up at Freeman’s Port in the Triangle. It was later learned that Imperial forces had destroyed two and captured the third of the Dixie ships, with the survivors of the third ship’s crew sentenced to a work gang helping to expand the Imperial naval facilities at Marram IX. They were eventually rescued, along with what additional intelligence survived from Operation Dixie, in a covert action in 2287 under the code name Project Phantom.

In a nutshell, *Plen Zha* is slow but well armed even in its standard Imperial configuration. They are a favorite with disenfranchised Klingon

warriors, who hope to make enough profit with them to buy back their lost honor and a small fleet of warships to match. Once enough funds are raised both they and the *Plen Zha* are taken to the nearest spaceyard and traded for a used battlecruiser or, more than likely, a Bird-of-Prey or some other smaller yet newer warship. The *Plen Zha* is then restored and put in storage to await its next purchaser.

The biggest difference by far between *Plen Zha* and *Baka Re* is that the former’s cargo hold is capable of emergency separation from the rest of the ship. This effectively gives a separated *Plen Zha* about the same combat capability as a standard *Drell*-type battlecruiser. The design of its detachable cargo hold prevents a liberated *Plen Zha* from mounting standard G-type or N-type cargo pods due to its custom interlocks. This has not stopped at least one of the Great Houses from converting one of its *Plen Zhas* to use standard cargo containers instead of its design-standard cargo hold. The conversion reportedly has had mixed results and no more are believed to be on order.

Another advantage that *Plen Zha* has over *Baka Re* is a higher degree of automation. *Baka Re* requires its full crew of 22, while *Plen Zha* can be operated if need be with only a crew of 5. This factor was important in the choice of *Plen Zha* for the ill-fated Operation Dixie.

“Over 500” *Plen Zhas* are believed to be in service as of this date. They were being produced at the Taamar, Fonawl, and Z’hai shipyards at the combined rate of 18 per year prior to the Praxis explosion of 2293. Z’hai remained the only shipyard still capable of producing *Plen Zhas* after the event; however, priority was given to warship production in order to cover for the many other damaged and destroyed spaceworks within the Klingon inner systems. *Plen Zha* production was subsequently idled and has yet to be restarted.

***Plen Zha* class Klingon transport created by Forrest G. Brown and Dana Knutson for FASA Corporation’s STAR TREK – The Role-Playing Game**

Additional background material courtesy of J. Andrew Keith, Brad Torgerson, and Ron Swearingen

Schematics courtesy of Dana Knutson



Fleet Auxiliaries

sarnall (Kl. “Tender”),
grafqexa (Kl. “Warp Tug”),
and *yuvDuj* (tH. “Support Starship”) series

K'nall

***yuvDuj* type 1 (*sarnall* type 4) (2264)**

Specifications as built

Dimensions

Length: 90 meters
Beam: 101 meters
Height: 40 meters

Mass

Standard: 352,500 GMT
Displacement: 88,600 DWT

Crew complement

Officers: 20
Enlisted: 95
Imperial Guards: none

Top velocity

Cruising speed: warp 6.0
Rated maximum speed: warp 8.0

Endurance

Standard endurance: estimated 2 years at L.Y.V.

Armament

Disruptors: 4 point-defense disruptors ("corner" mounts)

(*) Upgraded to standard disruptors in 2273

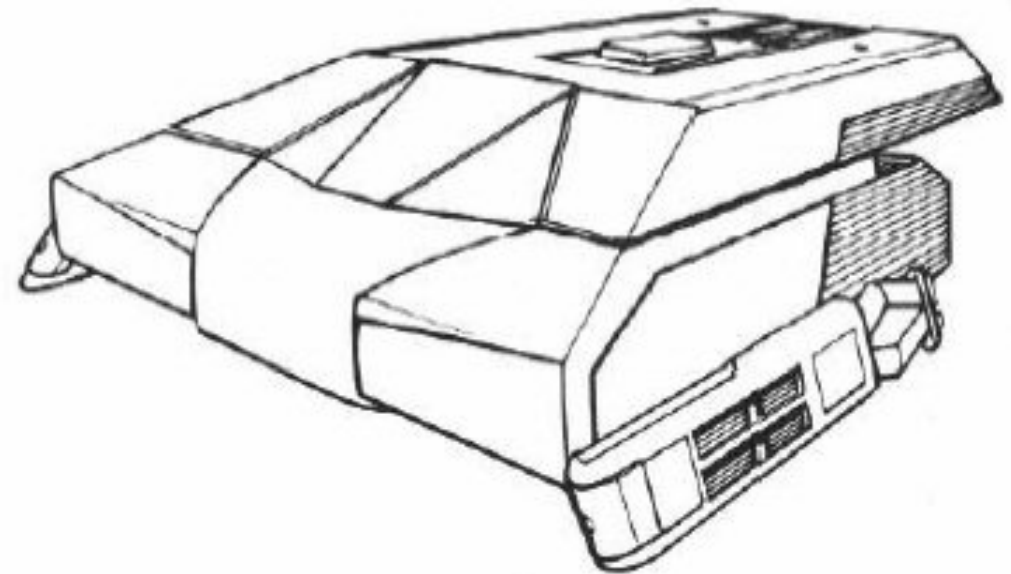

Known starships

Hull #	Name of starship	Builder	Status
KRS04-001	<i>K'nall (Healer)</i>	Taamar	active

K'nall is the common Klingon fleet tender. It is reported to have entered service in 2264 as part of Chancellor Kessa's fleet ramp-up program. Ever since it has been quietly serving in its role of servicing the Empire's many starships, as well as providing a mobile rapid-response capability for starships needing major repairs in the field. A *K'nall* (or its successor, *Eakin K'nall*) usually has all the equipment and spares on hand to handle most situations. In the few cases where the required repairs are beyond its capabilities, then the nearest *Hban Pav* is usually called in to assist.

K'nall got its equivalent of a "*K't'inga* upgrade" in 2273. It received *K't'inga* class *pljonta'*, standard disruptors in place of its point-defense models, and the fleet-standard armor/deflector upgrade. All on-board repair and maintenance facilities were brought up to current specifications at that time as well. The 2273 version is often known as the B-variant (S-4B) in Starfleet Intelligence circles. All *K'nalls* produced after 2274 have been S-4B models.

At the height of its production run *K'nall* hulls were being produced at the Taamar, Gnuu Re', and Mustaka Shipyards at the combined rate of 7 per year. Production came to a complete halt due to the widespread destruction caused by the Praxis explosion of 2293 and has never resumed. It is believed that the Klingon High Command has decided against continued *K'nall* production in favor of the smaller and cheaper *Eakin K'nall*.

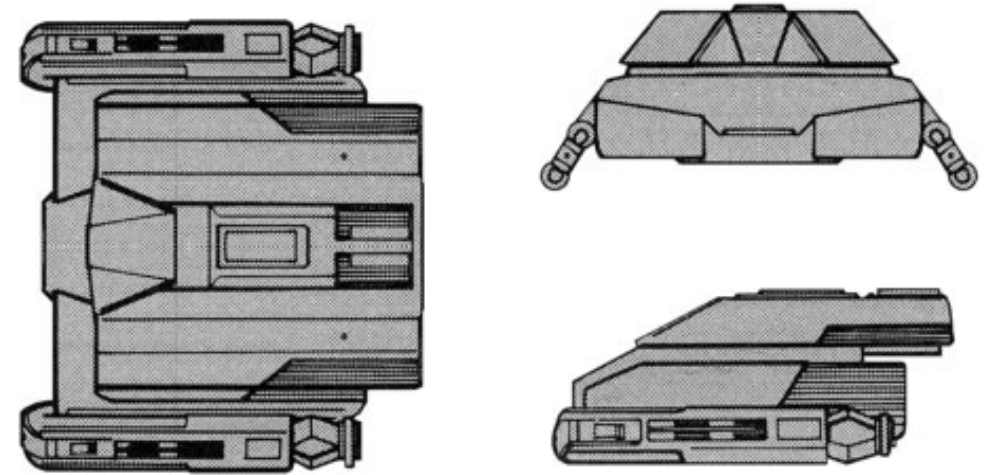

K'nall class Klingon tender created by Forrest G. Brown and Dana Knutson for FASA Corporation's *STAR TREK – The Role-Playing Game*

Additional background material courtesy of Brad Torgerson

Visual and schematics courtesy of Dana Knutson

Eakin K'nall

***yuvDuj* type 2 (*sarnall* type 5) (2272)**

Specifications as built

Dimensions

Length: 185 meters
Beam: 70 meters
Height: 70 meters

Mass

Standard: 120,500 GMT
Displacement: 35,360 DWT

Crew complement

Officers: 8
Enlisted: 28
Imperial Guards: none

Top velocity

Cruising speed: warp 7.0
Rated maximum speed: warp 8.0

Endurance

Standard endurance: estimated 3 years at L.Y.V.

Armament

Disruptors: 2 standard disruptors (both F/P/S)

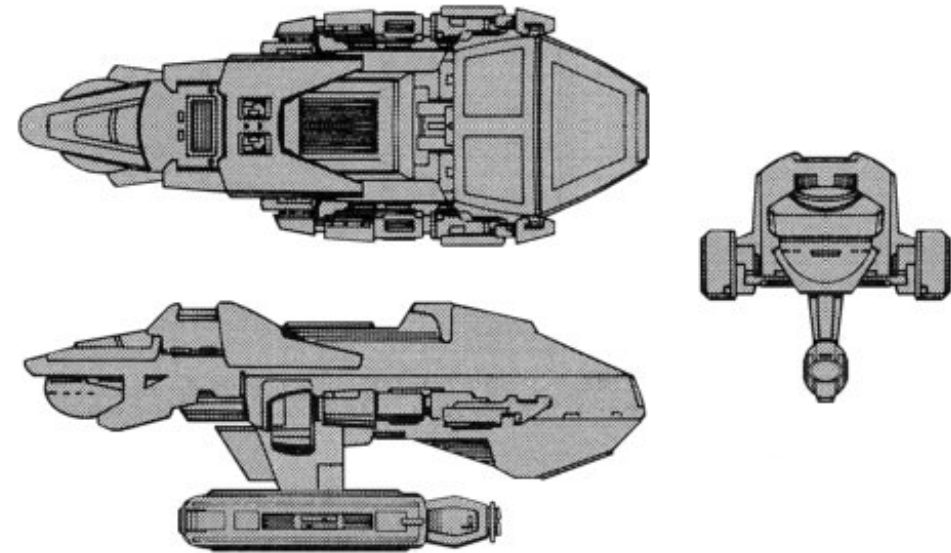

Known starships

Hull #	Name of starship	Builder	Status
KRS05-001	<i>Eakin K'nall (Ear Healer)</i>	Gnuu Re' Shipyards	active

Eakin K'nall entered service in 2272, just one year before the fleetwide refit of its predecessor *K'nall* to modern starship specifications. Its primary purpose is to serve as a high-speed mobile tender for extended fleet operations. As such it supplements, rather than replaces, *K'nall* in the fleet tender role. *K'nall's* duties are primarily in so-called safe areas, where the threat of combat is low, whereas *Eakin K'nall* is designed for combat arena operations.

It is not unheard of for an *Eakin K'nall* to accompany a Klingon fleet or squadron on extended detached duty. Such was the case with Commandor Kolor's famed Orion Strike Squadron. It was made up of one *K'tinga*, two modified *Klolodes*, and a *Eakin K'nall* that acted as both portable base and repair facility. Kolor's squadron enjoyed great success against Federation forces and local system defense fleets in the Treaty Zone from 2285 to 2290, when a Federation battle group finally caught up with it at the Alita system. The short-lived conflict that followed, known as the Battle of Alita to Federation forces, resulted in the destruction of two of Kolor's battlecruisers and the crippling of his tender. Kolor chose to go down with his ship; however, thanks to his final attack run the sole surviving battlecruiser of his fleet managed a successful escape back into Imperial space. Not only did Starfleet win the battle, it also captured the first example of an *Eakin K'nall* to come into Federation possession. Kolor's valor in battle was honored by re-naming a *VoDleh* class *chesis d'kleon* in his honor.

An unofficial upgrade carried out by local sector commanders in the late 2280s adds either a pair of drone racks or a pair of point-defense disruptors to help provide aft section coverage. Both of the *Eakin K'nalls* in Starfleet possession have these upgrades (one of each type). Both upgrades came at the cost of converting small cargo holds normally used to store spare parts. There is no indication in available intelligence that the Klingon High Command has ever ordered or approved such upgrades; likewise, there is no record of their refusing to allow them, either.

Eakin K'nall is produced exclusively by Gnuu Re' at the rate of 2 per year. The name comes from the design configuration's likeness to a small medical tool used by Klingon healers to treat ear infections.

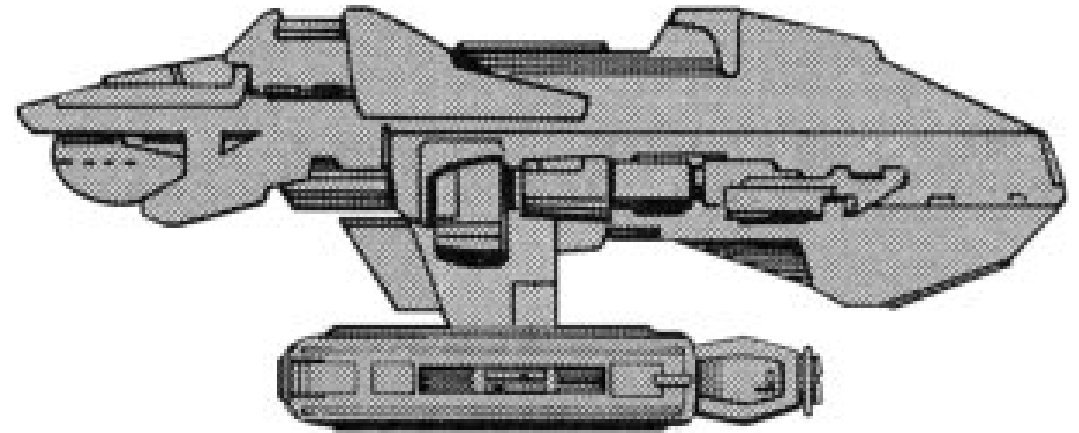

Besz Rate* class Klingon tug created by Forrest G. Brown and Dana Knutson for FASA Corporation's *STAR TREK – The Role-Playing Game

Additional background material courtesy of Brad Torgerson

Schematics courtesy of Dana Knutson

Hban Pav

***yuvDuj* type 3 (sarnall type 8) (2272)**

Specifications as built

Dimensions

Length: 259 meters
Beam: 191 meters
Height: 76 meters

Mass

Standard: 265,000 GMT
Displacement: 76,900 DWT

Crew complement

Officers: 32
Enlisted: 134
Workers (*): up to 100 (depending on mission requirements)

Top velocity

Cruising speed: warp 7.0
Rated maximum speed: warp 8.0

Endurance

Standard endurance: estimated 1 year at L.Y.V.

Armament

Disruptors: 2 standard disruptors (1 F/P/S, 1 A/P/S)
(2272 - 2278)
8 point-defense disruptors ("corner" mounts)
(2279 - present) (+)

(*) Can include "expendable" conscript labor and penal workers.

(+) Change in defensive armaments reflects decision to provide each *Hban Pav* with gunboats for increased protection. Anywhere from two to six gunboats are assigned to a given *Hban Pav* depending on mission requirements. Gunboat types are determined by local availability, and they are crewed by *Hban Pav* warriors on a regular rotation basis.

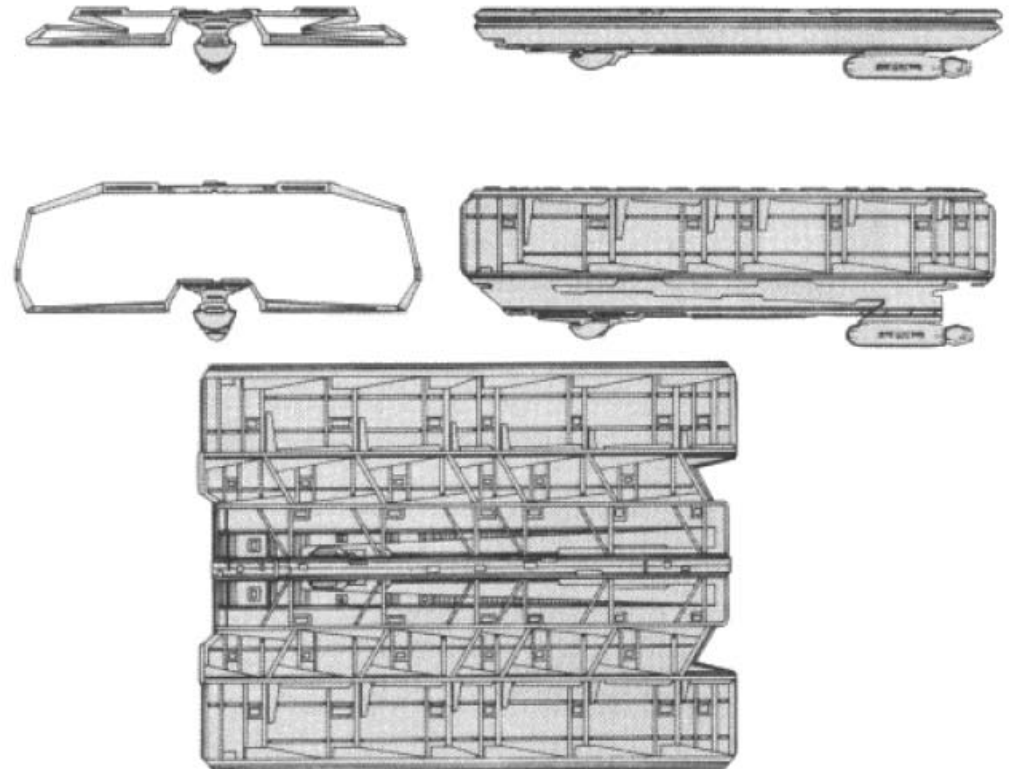

Known starships

Hull #	Name of starship	Builder	Status
KRS08-001	<i>Hban Pav (Folding Box)</i>	Gnuu Re' Shipyards	active

One of the good things to come out of Chancellor Kessa's efforts to wage open war with the Federation in the 2260s was *Hban Pav*. Having worked his way up the Klingon political structure the hard way, Kessa was fully aware that fleet auxiliary classes were just as important to a well-oiled space fleet as were war ships. To that end he authorized the largest buildup of Klingon auxiliaries in living memory. A number of new classes were introduced into fleet service as a result, and the most remarkable of these was *Hban Pav*.

The origins of *Hban Pav* can be traced back to Captain Krenn's initial tenure as Klingon ambassador to the Federation in the 2230s. At that time he was allowed to observe one of the Federation's massive CR-594 construction rigs. These 1600 meter monsters could be towed to any location within in the Federation to provide an instant starship and small craft construction, repair, maintenance, and upgrade facility. It is known that Captain Krenn was quite impressed with them, as he dedicated one of his confidential dispatches to describing them and their capabilities as compared to the Empire's own. Within the decade the Klingon Empire had built its own imitation of the CR-594. This and the mobile spacedocks that followed were all ancestors of *Hban Pav*. What made *Hban Pav* stand out from the others, though, and from other mobile spacedocks fielded by the other major interstellar powers, was that *Hban Pav* was the first warp-capable mobile repair facility (MRF, or "Murph") in known space. Chancellor Kessa had required that his new auxiliary space dock be capable of rapid deployment in order to provide the capability to conduct major starship repairs in the field. The only practical way to do this was to fit a mobile spacedock with warp drive; hence *Hban Pav*.

Hban Pav (Kl. "folding box") has two basic configurations: travel mode and fixed mode. In travel mode *Hban Pav* resembles a flying barge, with both its *pljonta'* and command "bulb" located on its keel. Once it arrives at its destination, though, it immediately transforms into fixed mode. A set of folded scaffolding rises up from the "barge" and locks into place, providing a ready-made space dock. This scaffolding can even be locked into various positions, similar to modern Federation space docks, in order to better accommodate the hull forms of certain Klingon starship classes. *Hban Pav* comes equipped with a full suite of repair facilities, cranes, booms, and a full flight of maintenance craft (such as *ghew*) to effect repairs as quickly as possible. It can also carry up to 10,000 metric tons of spare parts and other supplies. It can affect repairs on a single large capital ship (up to a *lat'd'kona* in size) or a mix of smaller ones.

Hban Pav is fully capable of operating alone; however, such instances are rare. One will almost always find a *K'nall* or *Eakin K'nall* nearby to provide assistance. In addition, as commanding a noncombatant vessel is

considered a dishonor, *Hban Pav* captains are also provided with several gunboats for self-defense, in addition to a limited defensive capability built into *Hban Pav* itself. This avoids the shame of having to command an unarmed vessel. The gunboats also give everyone aboard the *Hban Pav* a chance for combat should they be on crew rotation if (and often when) the spacedock is attacked.

Hban Pav will be supplemented in 2305 by *Ra'urta Pav*, an even larger MRF at nearly double the size. It will be capable of handling all but the largest Klingon warships, such as the massive *mayDuj'a'*.

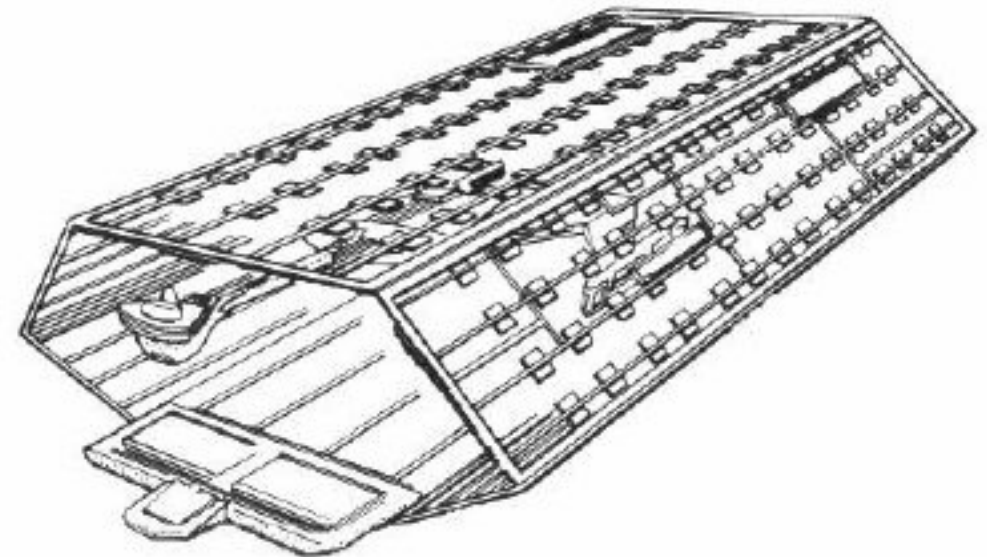

Artist's conception of *Ra'urta Pav*, the planned successor to *Hban Pav*. A *chetv'na* is shown inside to give some indication of scale.

***Hban Pav* class Klingon MRF created by Forrest G. Brown and Dana Knutson
for FASA Corporation's STAR TREK – The Role-Playing Game**

**Additional background material courtesy of Brad Torgerson, James Dixon,
Stan and Fred Goldstein, Rick Sternback, Eric "Jackill" Kristiansen, and John Ford**

Schematics and visual courtesy of Dana Knutson

Qexa

***yuvDuj* type 3 (*grafqexa* type 5) (2268)**

Specifications as built

Dimensions

Length: 110 meters
Beam: 80 meters
Height: 40 meters

Mass

Displacement: 102,900 DWT (unladen)
(max. 250,000 additional DWT of loading)

Crew complement

Officers: 3
Enlisted: 17 (+ 2 passengers)
Imperial Guards: none

Top velocity

Cruising speed: warp 4 (full load)
warp 6 (unladen)
Rated maximum speed: warp 5 (full load)
warp 8 (unladen)

Endurance

Standard endurance: estimated 1 year at L.Y.V.

Armament

Disruptors: none (*)

(*) Reflects standard Imperial version. There are two commonly encountered armed variants among both House and privately owned versions. The first has two standard disruptors, with one each covering the port and starboard firing arcs. The second substitutes four point-defense disruptors in paired arrangement and mounted in a similar fashion.

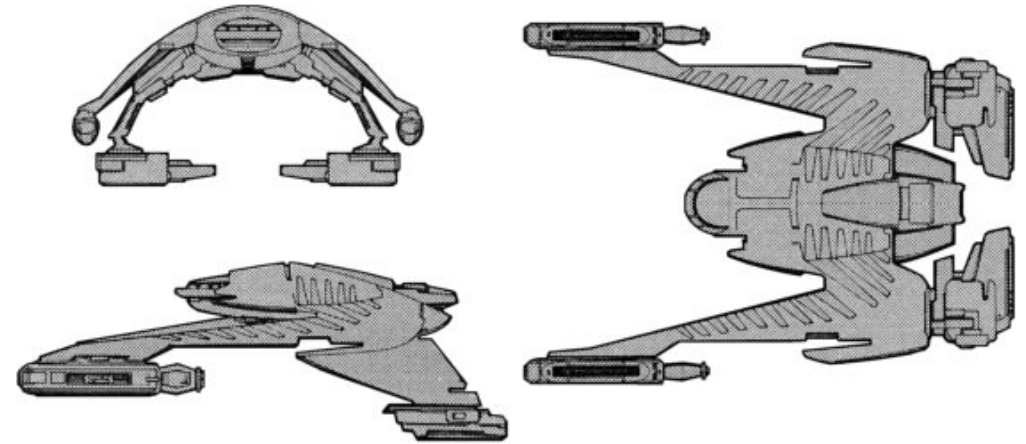

Known starships

Hull #	Name of starship	Builder	Status
KRG05-001	<i>Qexa (Tug)</i>	Taamar Shipyards	active

Qexa was originally ordered as part of the late Chancellor Kessa's efforts to modernize the Imperial Klingon fleet prior to his planned war with the Federation in the 2260s. Most of the focus of that program was on combat starship classes; however, the auxiliaries were not overlooked. Key auxiliary classes populated by aging vessels were also scheduled for replacement. *Qexa* was developed to replace the worn-out *Talat T'al'anda* (Kl. "Little Strongman"), which had been the standard Klingon fleet tug for well over a century. It is said that Chancellor Lotar, Kessa's successor, justified the expenses for the *Qexa* program by quoting a well-known Klingon proverb: "Even a porter has his place in battle."

Qexa's purpose is that of a dedicated fleet tug, or *yuvDuj* (tH. "starship pusher"). As such it has two primary functions. The first and more glorious function is to tow away from the battlefield those starships that cannot move under their own power. The second and less glorious is to supplement the regular fleet transport/tug force in the towing of Imperial cargo containers to various destinations. Assignment to *Qexa* is often viewed as a necessary one, although obviously lacking in chances for glory in battle.

The standard *Qexa* in Imperial service is unarmed. Those observed in House service, though, are another matter. Almost all are armed to some degree, usually with a pair of standard disruptors (one each port & starboard) or four point-defense disruptors in a similar paired arrangement. This is due largely to the infrequent inter-House fighting that takes place within the Empire. An armed *Qexa* sent to retrieve a damaged *Drell* from the site of a battle between rival Houses stands a better chance of defending itself during a potential ambush than an unarmed one. *Qexas* under private ownership and operating with renegade Klingon forces in the Triangle are also armed in a similar fashion. *Qexa's* design prevents the mounting of all heavy weapons save old-fashioned, engine-mounted heavy disruptors; however the justification for such is practically nonexistent. *Qexa* is a tug, not a battlecruiser, and such modifications would be wasted on a spaceframe "that wallows like a *targ* in heat" under combat conditions. No customized *Qexa* has ever been observed operating with any heavy weapons modification of any kind.

Qexa has remained in production since its introduction. The primary contractor is Taamar, while the secondary contractor is Gnuu Re'.

"About 400" *Qexas* are believed to be in Imperial service according to current Starfleet Intelligence estimates. The number in House service is unknown.

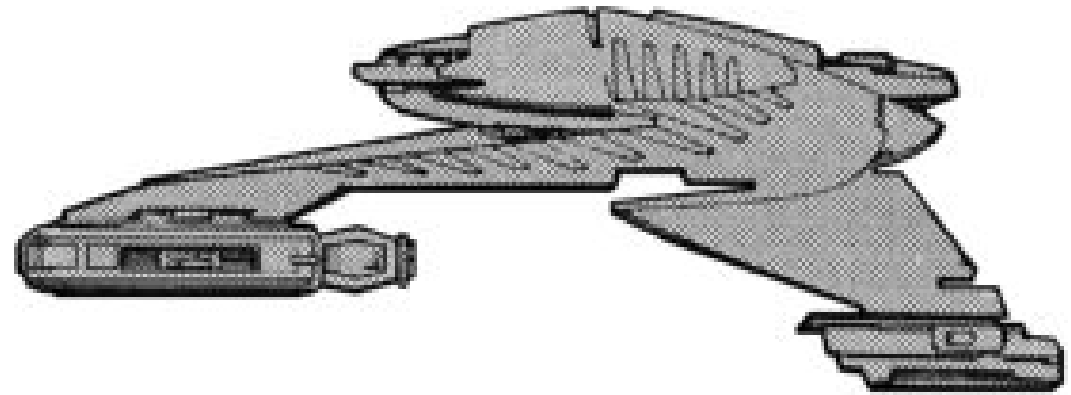

Qexa class Klingon tug created by Forrest G. Brown and Dana Knutson for FASA Corporation's *STAR TREK – The Role-Playing Game*

Additional background material courtesy of Brad Torgerson

Schematics courtesy of Dana Knutson

Besz Rate

yuvDuj type 4 (*grafqexa* type 6) (2280)

Specifications as built

Dimensions

Length: 120 meters
Beam: 90 meters
Height: 40 meters

Mass

Displacement: 115,800 DWT (unladen)
(max. 280,000 additional DWT of loading)

Crew complement

Officers: 4
Enlisted: 18 (+ 3 passengers)
Imperial Guards: none

Top velocity

Cruising speed: warp 5 (full load)
warp 8 (unladen)
Rated maximum speed: warp 6 (full load)
warp 10 (unladen)

Endurance

Standard endurance: estimated 1 year at L.Y.V.

Armament

Disruptors: none (*)

(*) Reflects standard Imperial version. There are two commonly encountered armed variants among both House and privately owned versions. The first has two standard disruptors, with one each covering the port and starboard firing arcs. The second substitutes four point-defense disruptors in paired arrangement and mounted in a similar fashion.

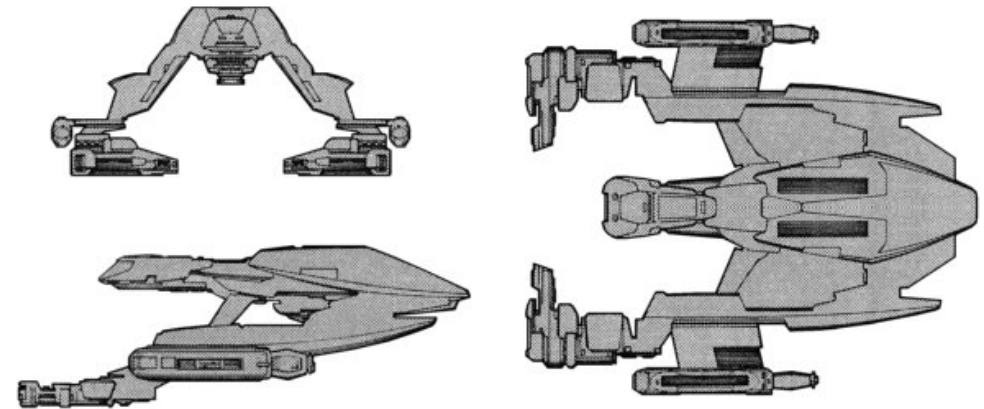

Known starships

Hull #	Name of starship	Builder	Status
KRG06-001	<i>Besz Rate (Catapult)</i>	Iosia Shipyards	active

There is little to say about *Besz Rate*, aside from the fact that it has replaced *Qexa* on the Imperial production schedule as the standard Klingon fleet tug. The design was first spotted in operation in 2281 assisting *Kar'hamer* at Mastocal during the *bur'd'kona's* initial space trials. It is little more than an improved *Qexa* with the ability to push more cargo than before. The design is still unarmed, like its predecessor, so *Besz Rate* assignments provide no path to glory for the average Klingon.

There are no customizations or modifications of *Besz Rate* known as of this date. All hulls produced remain in Imperial service, thus limiting such opportunities.

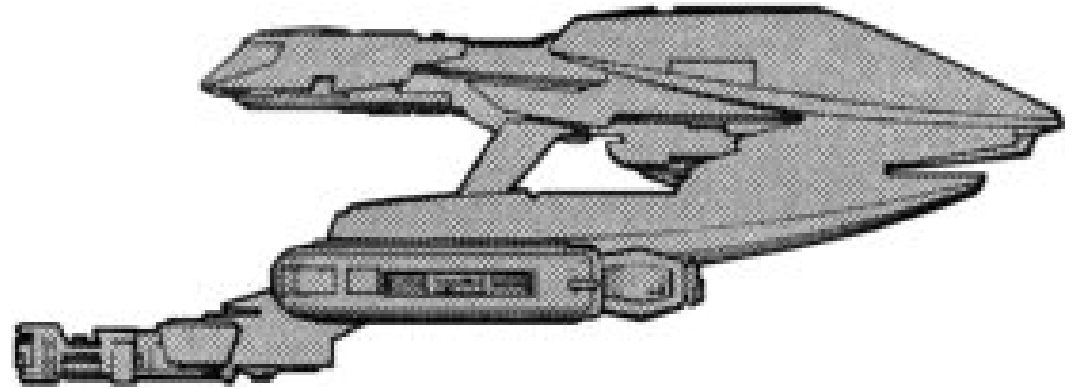

***Besz Rate* class Klingon tug created by Forrest G. Brown and Dana Knutson
for FASA Corporation's *STAR TREK – The Role-Playing Game***

Additional background material courtesy of Brad Torgerson

Schematics courtesy of Dana Knutson

ລຸປດຸຍໂຮມ ວິສະຄຣາ

Shuttlecraft and Small Craft

wisklah (Kl. “Small Craft”) and
lupDujHom (tH. “Shuttlecraft”) series

Zoran

type Z-1 fighter shuttle (2272)

Specifications as built

Dimensions

Length:	x meters
Beam:	x meters
Height:	x meters

Mass

Standard gross:	x GMT
-----------------	-------

Crew complement

Crew:	1
-------	---

Top velocity

Cruising speed:	warp x.0
Rated maximum speed:	warp x.0

Armament (*)

Point-defense disruptors:	2
Optional weapon hard points:	2

(*) Fighter and assault shuttle armaments are always fixed forward save in rare cases. These are noted when applicable.

**Zoran class Klingon fighter shuttle created by Steven V. Cole
for Amarillo Design Bureau's *Star Fleet Battles* role-playing game**

Visual courtesy of Battleclinic.com



Zoran was the first Klingon fighter shuttle ever encountered by Federation forces. It was reportedly based on an older and now unknown design that served the Empire for decades. The Z-1 model was introduced in 2272 in response to the introduction of new and more powerful fighters by the Mirak Star League.

Zoran continues to be a popular fighter with both Imperial and House forces. It is most commonly found on carrier conversions, where space is at a premium. In a number of deployments it can be found serving alongside the more modern *K'pak*. In these cases the smaller and less heavily armed *Zoran* can be found filling the CAP and interceptor roles.

K'pak

type Z-2 fighter shuttle (2278)

Specifications as built

Dimensions

Length:	x meters
Beam:	x meters
Height:	x meters

Mass

Standard gross:	x GMT
-----------------	-------

Crew complement

Crew:	2
-------	---

Top velocity

Cruising speed:	warp 2.0
Rated maximum speed:	warp 3.0

Armament (*)

Point defense disruptors:	4
Optional weapon hard points:	2

(*) Fighter and assault shuttle armaments are always fixed forward save in rare cases. These are noted when applicable.

***K'pak* class Klingon fighter shuttle created by Taldren
for the *Starfleet Command* series of licensed videogames**

**Inspired in part by the *Zoran* class fighter shuttles created by Steven V. Cole
for Amarillo Design Bureau's *Star Fleet Battles* role-playing game**

Visual courtesy of OutaLance Shipyards



K'pak quickly replaced *Zoran* as the standard Imperial Klingon fighter once the limitations of *Zoran* became clear. The handicap of its size and mass is largely offset by its more powerful engines and heavier weaponry.

Although it is limited to only two optional weapon hard points, the same as *Zoran*, these can carry a wider variety of weapons packages. One significant improvement over *Zoran's* hard points is the use of so-called "cluster rails," which allow it to carry multiple assault munitions (such as bombs, bombardment missile racks, etc.) on a single hard point. *Zoran* cannot wield these for the simple reason that its space frame cannot handle the load.⁴

D`k`tagh

type Z-3 fighter shuttle (2288)

Specifications as built

Dimensions

Length:	31 meters
Beam:	29 meters
Height:	10 meters

Mass

Standard gross:	100 GMT
-----------------	---------

Crew complement

Crew:	2
-------	---

Top velocity

Cruising speed:	warp 2.0
Rated maximum speed:	warp 3.0

Armament (*)

Disruptors:	2
Optional weapon hard points:	2

(*) Fighter and assault shuttle armaments are always fixed forward save in rare cases. These are noted when applicable.

***D`ktagh* class Klingon attack shuttle created by 18 Degrees East for the *Klingon Academy* and *Starfleet Command* series of licensed videogames**

Inspired in part by the *Zoran* class fighter shuttles created by Steven V. Cole for Amarillo Design Bureau's *Star Fleet Battles* role-playing game

Visual courtesy of Grey Griffon Shipyards



D`k`tagh entered service in 2290 as the Empire's newest fighter shuttle. It is fast and agile, like most other Klingon attack shuttle designs, but lacks the offensive punch of its stablemate *K`Pak*. This was partially offset by the introduction of a modified design in 2292, which added two *K`Tak* style hard points (one to each wing). It is already in the process of phasing out the older *Zoran* in the CAP and interceptor roles.

Most intelligence experts believe *D`ktagh* to be an economy design intended for rapid production in large numbers. Its relative cheapness, in comparison with other Klingon armed shuttle designs, has also seen it quickly become one of the Empire's most profitable export designs in modern times. *D`ktaghs* can be found wherever the Empire or its allies have established a foothold. In numbers they can pose a significant threat.

D`ktagh is named after the ritual dagger carried by Klingon warriors when wearing full battle dress. It has a primary dual-edged stabbing blade with two smaller, spring-loaded "hook" blades normally locked parallel to the primary blade. The smaller blades are designed to rip open the wound caused by the primary blade, resulting in major damage and severe loss of blood and body fluids.

A photon-equipped variant is rumored to be ready to enter service.

Kopav

type 1 personnel shuttle (2140?)

Specifications as built

Dimensions

Length:	x meters
Beam:	x meters
Height:	x meters

Mass

Standard gross:	x GMT
-----------------	-------

Crew complement

Crew:	2
Passengers:	up to 4

Top velocity

Cruising speed:	warp x.0
Rated maximum speed:	warp x.0

Armament (*)

Disruptors:	none
-------------	------

(*) Fighter and assault shuttle armaments are always fixed forward save in rare cases. These are noted when applicable.

Kopav* class Klingon personnel shuttle created by Forrest G. Brown and Dana Knutson for FASA Corporation's *STAR TREK – The Role-Playing Game

***Pavre* class Klingon personnel shuttle created by Greg Jein as first published in Geoffery Mandel's *Star Fleet Handbook #9* fanzine**

Visual courtesy of Dana Knutson

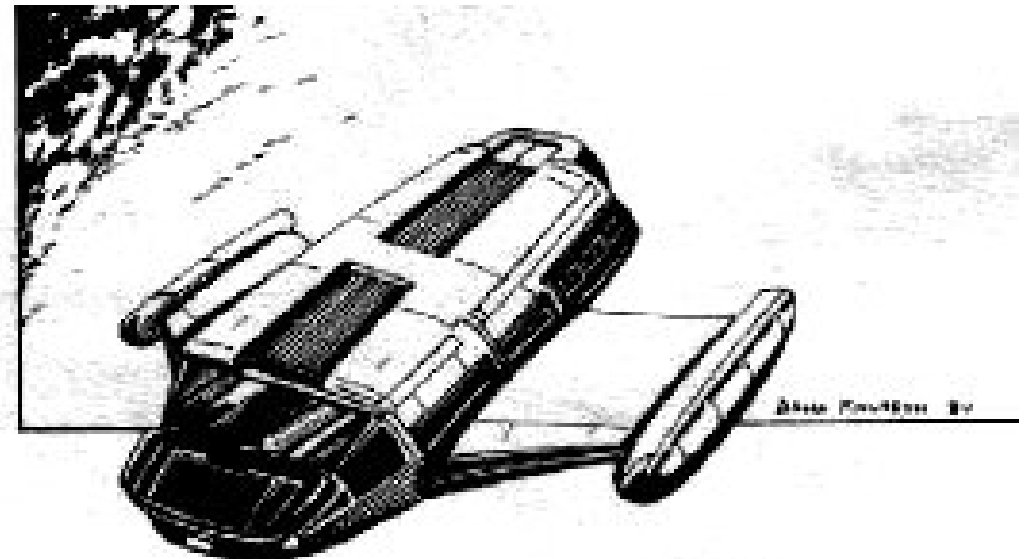

The unassuming *Kopav* has served the Empire as its standard personnel shuttle for well over a century. It was replaced in Imperial service in the 2240s by *Pavre*; however, *Kopav* still remains a common sight within the Empire. One still frequently encounters it in the service of House fleets, in particular those of the Lesser Houses. It can also be found in numbers within the Triangle, in particular with the various renegade Klingon factions located there. What *Kopav* lacks in looks and armament it makes up for in reliability and agility. The only thing that hinders its use today is its age and corresponding cost of spare parts. *Kopav* owners have been forced to be quite resourceful in keeping them operational by means of adapting currently technology. Consequently, there is some truth to the statement that no two *Kopavs* are exactly alike.

Klish

type 8 personnel shuttle (2280?)

Specifications as built

Dimensions

Length:	35 meters
Beam:	25 meters
Height:	7 meters

Mass

Standard gross:	35 GMT
-----------------	--------

Crew complement

Crew:	2
Passengers:	up to 6

Top velocity

Cruising speed:	warp 5.0
Rated maximum speed:	warp 7.0

Armament (*)

Disruptors:	2
Optional weapon hard points:	none

(*) Fighter and assault shuttle armaments are always fixed forward save in rare cases. These are noted when applicable.



Klish is the standard personnel shuttle of the Klingon High Command. It is fast and well armed, with room for both cargo and multiple passengers. It is also warp capable. It is normally used as a courier vessel or as the personal shuttle of Klingon flag officers whenever they are out in the field.

Klish class Klingon attack shuttle created by 18 Degrees East for the *Klingon Academy* and *Starfleet Command* series of licensed videogames

Visual courtesy of Activision Games

Koreba

type 2 warp shuttle (2247)

Specifications as built

Dimensions

Length:	84 meters
Beam:	24 meters
Height:	18 meters

Mass

Standard gross:	1,450 GMT
-----------------	-----------

Crew complement

Crew:	13
Passengers:	up to 10 (or up to 140 GMT of cargo)

Top velocity

Cruising speed:	warp 6.0
Rated maximum speed:	warp 7.0

Armament (*)

Disruptors:	2 (both F)
Optional weapon hard points:	1 (omni)

(*) Fighter and assault shuttle armaments are always fixed forward save in rare cases. These are noted when applicable.

Koreba* class Klingon warp shuttle created by Forrest G. Brown and Dana Knutson for FASA Corporation's *STAR TREK – The Role-Playing Game

Additional background material courtesy of Brad Torgerson

**Model by Floyd Christiancy
Visuals courtesy of Griffworks**



Koreba's age has not precluded its continued use by the Empire, even though it has been supplanted by *Kas Maal* in most normal duties. These days *Koreba's* duties are primarily administrative. It is often used as a courier vessel, shuttling Klingon VIPs to various locations within and without the Empire. Its rather roomy accommodations allow its owner to entertain his passengers with a measure of comfort, something that is not normally enjoyed above the average Klingon vessel. For example, a fleet of *Kas Maals* was reserved for the exclusive use of the Klingon High Council, and in times past was used to ferry them to various locales within the inner systems.

Until the signing of the Khitomer Accords in 2291, *Koreba* was the largest armed Klingon vessel permitted within Federation space. It was allowed to retain armaments both in self-defense and as part of its diplomatic functions. These involved the shuttling of Klingon ambassadors, representatives, and embassy personnel to and from various locales within Federation space, not all of which were friendly to Klingons.

Kas Maal

type 2 warp shuttle (2268)

Specifications as built

Dimensions

Length:	90 meters
Beam:	20 meters
Height:	20 meters

Mass

Standard gross:	2,430 GMT
-----------------	-----------

Crew complement

Crew:	10
Passengers:	up to 20 (or up to 1,500 GMT of cargo)

Top velocity

Cruising speed:	warp 7.0
Rated maximum speed:	warp 8.0

Armament (*)

Disruptors:	2 (1 F/P, 1 F/S) (+)
Optional weapon hard points:	3 (1 topside omni, 2 wing – F/P and F/S)

(*) Fighter and assault shuttle armaments are always fixed forward save in rare cases. These are noted when applicable.

(+) Standard disruptors are always found on military versions, while point-defense disruptors are common on civilian craft.



Kas Maal is the Empire's preferred long-range shuttlecraft. The term is something of a misnomer, as it could easily qualify as a cutter or runabout in Federation terms. It could also be a patrol ship in terms of size and speed save for its limited armament. That did not stop the designers at Taamar from building in three hard points for optional weapons systems. These normally go unused in Imperial and House models; however, they are frequently put to use in Taamar's civilian market model. The Klingon authorities have chosen to look the other way in this regard, due to Taamar's long standing reputation and the many contract favors it has cut the Empire in the past. To this end, civilian *Kas Maals* are usually armed to the teeth. Dual drone racks and a third topside omnidirectional disruptor are common for Triangle models. A version with five disruptor banks (2 standard, three point-defense) is operated by House Gnober, while a plasma cannon equipped Romulan model has also been reported.

Kas Maal* class Klingon warp shuttle created by Forrest G. Brown and Dana Knutson for FASA Corporation's *STAR TREK – The Role-Playing Game

Additional background material courtesy of Brad Torgerson

Visual courtesy of Dana Knutson

ghew

type 8 maintenance pod (2283)

Specifications as built

Dimensions

Length:	9 meters
Beam:	6 meters
Height:	3 meters

Mass

Standard gross:	25 GMT
-----------------	--------

Crew complement

Crew:	2
Passengers:	up to 4

Top velocity

Cruising speed:	warp 0.3
Rated maximum speed:	warp 0.5

Armament (*)

Disruptors:	none
-------------	------

(*) Fighter and assault shuttle armaments are always fixed forward save in rare cases. These are noted when applicable.



First observed in 2284, *ghew* (tH. “bug”) is the Klingon equivalent of Starfleet’s Work Bee. It is a small, one-man maintenance craft used for work and repairs in space of extended duration. The stock model comes equipped with a single forward waldo (as pictured). Option packages exist for alternate configurations along the lines of those used by the Terran “Work Bee.”

Kopav* class Klingon personnel shuttle created by Forrest G. Brown and Dana Knutson for FASA Corporation’s *STAR TREK – The Role-Playing Game

***Pavre* class Klingon personnel shuttle created by Greg Jein as first published in Geoffery Mandel’s *Star Fleet Handbook #9* fanzine**

Visual courtesy of Dana Knutson

Other Klingon Starship Designs

This work has striven to provide you with a well-rounded look at today's Imperial Fleet. In addition to the major starship and small craft classes previously presented, though, there are a wealth of minor designs. The reasons why they are not counted among the ranks of those just discussed are many. For example, they might have limited to just a single production run well below fleet standard, or even to just a few hulls. Or, as in the case of *Kortak*, it was a former mainstream design that has fallen out of favor for whatever reason and pressed into service for duties no longer worthy of a warrior's honor. Perhaps it might have been a lone prototype, such as *Kragg Dor*, that despite its status went on to make a name for itself in the service of the Empire. The use of the design in question might be limited to a few select Houses or even just one House. It might even be a specialty ship produced for a single purpose that survived its mission and went on to regular service. The possibilities are as endless as the descendants of the *Vag'chalthneS* (tH. "Honored Five Hundred"), the legendary bodyguard of Kahless from whom almost all of today's Klingon Houses swear descent.

The following pages provide brief summaries of other Klingon starship designs that are worthy of mention. The information that is included is by necessity not as detailed as that of the major Imperial and House classes previously presented. The intent here is to give the reader a broad overview as to the diversity of secondary designs used by the Klingons. Additional information is available on the UFP Infonet for each class listed in this section. Readers desiring a hardcopy reference on these vessels are recommended to take a look at *Jaynz' Klingon Force Review*, a quarterly periodical consisting of Klingon-related articles culled from past issues of *Jaynz Defense Weekly*.



Klingon TMP-era "mining ship" custom model by Paul K.

Kolor C-10 Dreadnought



Design by Atolm (inspired by the work of Stephen V. Cole)
Visuals by Atolm

This is reported to be the new configuration for the only *voDleH* class hull under construction to survive the Praxis Event. It follows the tri-engined *K'herr* hull form as opposed to that of the quad-engined *voDleH*; however, the ship itself has been completely redesigned (per *Hegh daS* technology?) for the 24th century Imperial Fleet. It will certainly be one of the most eye-catching dreadnoughts ever to enter Imperial service.

Kareli D-5C Light Command Cruiser

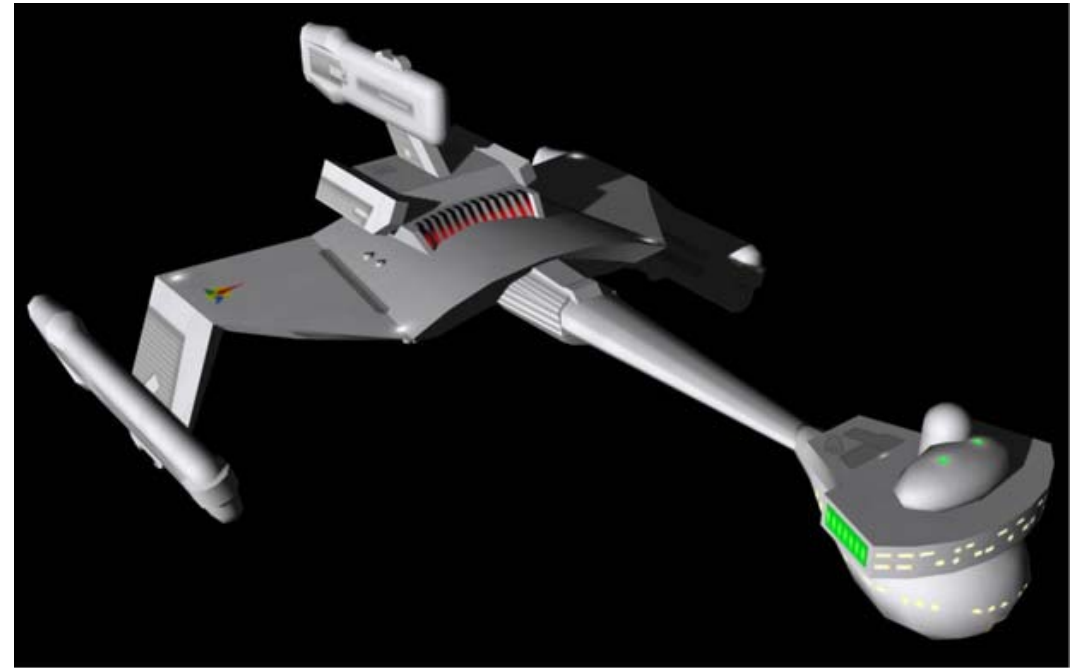

Design by Steven V. Cole (Amarillo Design Bureau)
Visual courtesy of Adam Turner

Kareli is one of the more popular *Hak'hyl* (D-5) variants. It is for all intents and purposes a "quick-and-dirty" *betleH* command cruiser on a D-5 hull. The over-hull mount for the third S-2 Graf unit was intended to correct the warp field distortions caused by *betleH*'s under-hull mount. This was only a partial success; however, it seems to have been enough to justify continued production. Until 2293 approximately one out of every fifteen *Hak'hyls* produced for the Great Houses or the Imperial fleet was a *Kareli*. The current production rate appears to be one out of twenty-five. It also seems to be a popular and cost-effective command cruiser design of choice for those Lesser Houses who can afford more than a *betleH* conversion of an existing hull.

***K't'kara* D-8S Fast Battlecruiser**



**Design by Dana Kuntson (FASA Corporation)
Visuals by Terradhyne**

This is essentially a *Drell* type hull that has been optimized (by House Kinzan) for speed. The standard *Drell* command boom is replaced with a somewhat shorter one one similar to that used on the older *bortaS*, and swept-back engine support pylons replace the swept-forward ones. What is lost in structural integrity is gained by a battlecruiser that can get to the scene of trouble almost as fast as many smaller vessels. *K't'karas* are not common, though, due to the high cost of producing them. Less than 100 are thought to be in service, although the exact number remains unknown. They have been observed acting primarily in two roles: first responder and high-speed courier. The latter is especially true in fleet actions, where they are often employed as flagships for border squadron commanders. A three-engine variant, utilizing an over-hull mount like that of the *Kareli* light battlecruiser, is also known to exist.

***Talat Dor (Aga'sta)* K-26 Escort**

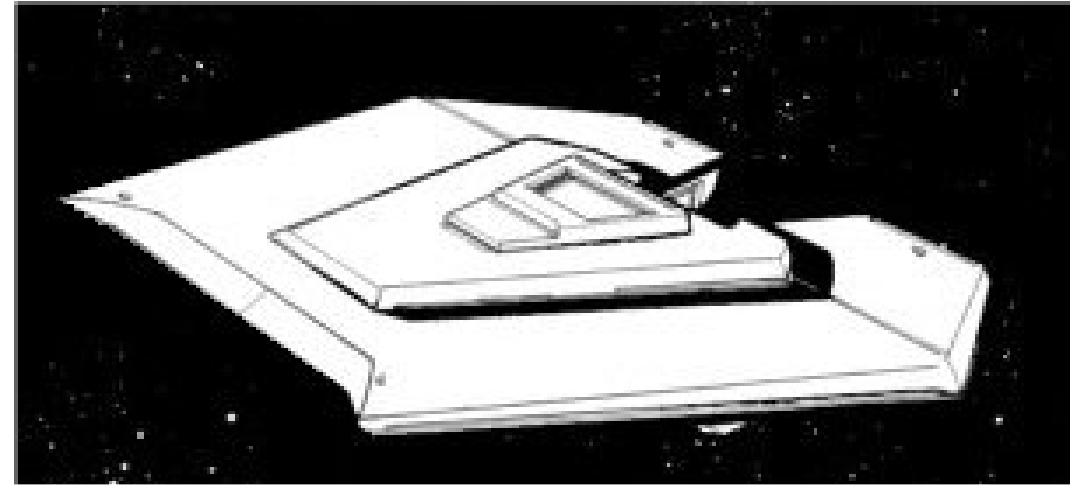

**Design by Dana Knutson (FASA Corporation)
Visuals by Dana Knutson**

Very little is known about this design, as it was only encountered sporadically during the 2270s and 2280s. The original class name (*Aga'sta*, Kl. "fast rider") was assigned by Starfleet Intelligence, but the actual Klingon name is *Talat Dor* (Kl "little messenger"). It was believed to be an experimental escort class of some type, and was most frequently seen in the priority courier role. Star Fleet Intelligence believes that the Klingon High Command was not happy with *Aga'sta's* performance and withdrew it from service sometime prior to 2290. Its status with the House fleets remains unknown.

***Hasparath* N-2 Transport**



Design by Aridas Sofia (*Kobayashi Maru* Blueprints)
Visuals by Terradhyne

Hasparath is the oldest known starship design still serving the Empire in any capacity. The design is at least 150 years old and may even be older than that. A *Hasparath* was observed in port by the crew of the Terran starship *Enterprise* during humanity's first visit to the Rigel Colonies in 2151, thus documenting its known age. While no *Hasparath* remains in Imperial service, many can still be found in use as transports in the fleets of the Lesser Houses. They are also a favorite with Triangle smugglers, due to their quick acceleration (for a transport) and large, jettisonable cargo holds. The surprise ambush of the smuggling ship *Kobayashi Maru*, a heavily customized *Hasparath*, serves as the basis for Starfleet Academy's infamous "no-win" training scenario for Command School candidates.

***Kragg Dor* C-5X Experimental Dreadnought**



Based on the work of Patrick Flannery and Steven V. Cole
Visuals and background (modified) by Scottish Andy

Kragg Dor was the prototype for the *K'herr* class dreadnought. Its most obvious modification reflects that intended for the original *K'herr* design: a warp-capable command boom. This had two immediate advantages. First, the chosen location of the third *pl'jonta'* eliminated most of the warp field distortions caused by fitting three *pl'jonta* on a *Drell*-type hull. Second, by making the boom warp capable, it became a destroyer-class starship when jettisoned. This second point soon became a sticking point with certain members of the Klingon High Command, who saw it as giving "cowardly commanders" an easy out in an uneven battle. They could, it was argued, simply jettison the boom and warp away, leaving the rest of the ship to its fate. As unlikely an argument as this sounds, one must remember that we are discussing Klingons, not humans. So it was that this line of reasoning eventually won out and the design of *K'herr* was changed. *Kragg Dor* remained in Imperial service for two more years, after which it was apparently sold. The details surrounding the sale are murky. The identity of the buyer has never been established but it is believed to be House Vor Thrumm, a house specializing in border "incidents" with the Romulans. The current whereabouts of *Kragg Dor* remain unknown.

***Des'x* D-5H(Atx) Battlecruiser (*QaHos* Variant)**



Derived from a design by Taldren (Activision Games)
Visuals by Kalion
Background by Richard Mandel

This is among the more notable of the House *QaHos* variants. Its owner is House *Atanerex*, one of the oldest and wealthiest of the Klingon Houses. Lord *G'dakh*, the House patriarch, bought the original hull as a present for his son *Kasdath*. With his father's permission and House funding *Kasdath* had it modified into its current form. Unique to its design are its dual *pljonta'*, which are light cruiser class and have been relocated to more traditional "wing" mounts on either side of the secondary hull. A larger than normal weapons package, mounted in the original location for the single *pljonta'*, sports four forward-firing standard photon torpedoes and two rear-firing ones. The additional power and weapons capacity has caused Star Fleet Intelligence to classify *Des'x* as a battlecruiser, as opposed to the standard cruiser designation normally assigned to *QaHos* and its variants.

***Krencha* (aka *Saber Bear*) Civilian Transport**

Design by Taldren (Activision Games)
for *Klingon Academy*
Class name from William Shatner's
STAR TREK novel *The Return*

This design is a common sight across the Empire and its affiliated systems. It is an old one and is believed to have been introduced c.2200 for commercial purposes. It was designed to be cheap and easy to produce, and many copies and variants of the basic design abound throughout the quadrant. Current versions sport modern warp engines and support systems. Its cargo carrying capacity is rather large for a vessel its size, and it can mass up to 50,000 DWT



fully loaded depending on its cargo. Most of cargo is carried externally on a paired system of latching rails. This also allows it to jettison its load in case of an emergency.

These are used by almost everyone – Klingon civilians, House transport commands, Bloodwatch and Imperial Intelligence agents, Triangle traders, Orion merchants, Federation border colonies, and so on. They are also a common sight at the Rigel Colonies, where the Klingons are believed have maintained an unofficial presence of one kind or another for the past three centuries. The design is probably best known to the general public for the prominent role played by the Klingon freighter *HongeDo* during the attempted Imperial coup of 2287.

The name comes from the *krencha* (tH. "saber bear") of Q'o'nos, a ferocious six-limbed, three-meter tall mountain predator. The spindly design of the vessel's cargo latching rail system is said to resemble the bared claws of the *krencha*.

***Khuled* R-7 Assault Cruiser (prototype)**

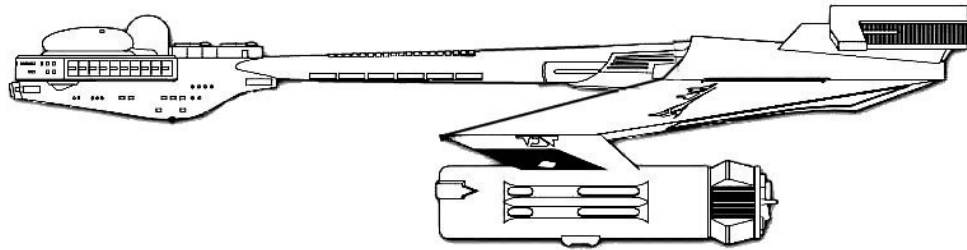

**Designed by Eric "Jackill" Kristiansen
Background draft by Richard Mandel
(subject to change in future revisions)**

Starfleet Intelligence has only recently received reports of *Khuled*. Most of these consist of surveillance drone intercepts of space trials and initial shakedown cruise of a lone prototype, which took place late last year. Currently available data seems to indicate that it is being evaluated for a highly specialized subcategory of assault cruisers used as command ships (*ra'wl'Duj yot*). These are somewhat smaller than standard assault cruisers, and trade their Imperial Guard facilities for the C3 capabilities necessary to coordinate fleet operations during planetary assault actions. It has also been speculated that the Imperial Guard may be evaluating *Khuled* as a dedicated escort cruiser, as reports indicate extensive combat trials in the "guard" role against multiple opponents.

The *Khuled* prototype appeared to be a mishmash of existing components spanning the last three decades of Klingon starship development. In essence, it is a *K'teremny* command boom fitted to a stripped-down *Z'gal* secondary hull, with older model S-2 *pljonta'* installed on its wing booms. This prototype may have been built merely to test the configuration and its suitability for assault ship operations. Its hodgepodge configuration is also a telling reflection of the state of the Klingon shipbuilding effort in the wake of the Praxis Event. The production design, once approved, will probably have modern *pljonta'* and incorporate other changes resulting from a thorough evaluation of its space trials. Starfleet Intelligence is said to be anticipating the finished form of *Khuled* the next time it returns to the spaceways.

The Future of the Klingon Fleet

<work in progress>

<possible topics>

(point towards TNG's Klingon Defense Force)

(shipyard and other production re-organizations)

(changing designs – *Kolor, Hegh daS, tel'Iw, B'rel/QuD/K'vort*)

(growing independence of the House fleets – coup in making?)

(increased tensions with Romulans - hint at coming Tomed Incident)

Appendicies

Klingon Shipyards and Ordinance Manufacturers

<incomplete, work in progress>

B'Treliq (?)

under construction?

battlecruisers (D-8) (?)

Chenwl Duj

heavy cruisers (C-7)

Fonawal (?)

assault cruisers (T-5, T-12)

battlecruisers (D-10)

destroyers (D-14)

escorts (K-24)

frigates (L-9)

gunboats (K-4, K-5, K-6)

transport (G-8)

administrative warp shuttles (W-2, W-4)

Gerly

escorts (K-24, K-27)

(new facility for K-24 production? existence unconfirmed)

Gnuu Re' (?)

battlecruisers (D-7, D-8, D-9, D-10, D-20)

frigates (L-9)

gunboats (K-4)

(K-3 gunboat built here when in production)

scouts (K-15)

transport (G-3)

tug (G-5, G-6)

tenders (S-4, S-5)

Graltha

(LUG)

H'rez (?)

battlecruisers (D-7, D-8, D-20)

gunboats (K-4, K-6)

monitors (K-32)

administrative warp shuttles (W-2)

H'renn (?)

Bird-of-Prey "small" gunship version

destroyers (D-2, D-14, D-18)

("One Wing" destroyer originally built here, no longer in production)

escorts (K-23)

Iosia (?)

assault cruisers (T-12)

battlecruisers (D-7, D-8)

destroyers (D-2, D-16, D-18)

escorts (K-23)

gunboats (K-4, K-5)

tug (G-6)

mobile repair facilities (S-8 MRF, aka "Murph")

Kodal (?)

frigates (L-6)

Kohl

heavy destroyers (Q-9)

Mustaka (?)

assault cruisers (T-5, T-12)

battlecruisers (D-10)

Bird-of-Prey, cruiser version

(production facilities being added for the gunship & scout versions

c.2290)

transport (G-3)

tenders (S-4)

Rohel Moonbase (Beta Thoridor, Mempa sector)

small craft construction (as favored by its owner, the House of Duras)

Taamar (?)

MOST IMPORTANT SHIPYARD COMPLEX IN THE KLINGON EMPIRE!!!

(most classes produced)

battleships (L-13, L-24)

battlecruisers (D-7, D-8, D-10)

destroyers (D-14)

("One Wing" destroyer originally built here, no longer in production)

escorts (K-23)

- frigates (L-9)
- gunboats (K-6)
(K-3 gunboat built here when in production)
- scouts (K-15)
Bird-of-Prey "small" scout version
- monitors (K-30, K-32)
- scouts (K-17)
- transport (G-8)
- tug (G-5)
- administrative warp shuttles (W-2, W-4)
- tenders (S-4)

Thoras (?)

Owned by the House of Kinzan, produces customizations and specialty classes

- pocket battleships (L-20)

Vekah Shipyards (Klinzhai/QoNos, Mempa sector)

NOTE: Dockyard Review #1 says it was the shipyard facility at Mastocal; however, FASA's

RPG module THE KLINGONS clearly states that no shipbuilding facilities were

- located at Mastocal due to its proximity to the Treaty Zone (p. 16).

- battleships (B-10)

Z'hai (?)

- battlecruisers (D-7, D-8, D-10)

- gunboats (K-5)

- (K-3 gunboat built here when in production)

- transport (G-8)

- administrative warp shuttles (W-2, W-4)

Glossary of Terms

BATTLESHIP: Any starship designed for use as a military combatant that is at least 400 meters in length and has a minimum mass of 1,000,000 GMT. Battleships are the largest fleet combatant classification with regards to ships of the line. A size exception exist for the Klinogn *lat'd'kona* series; see also **BUR'D'KONA, LAT'D'KONA, MAY'DUJ'A, MAY'DUJHOM, POCKET BATTLESHIP.**

BATLETH: See **BETLEH**

BETLEH (tH. “sword of honor”): A traditional Klingon blade weapon resembling a crescent-shaped, double-handled scimitar. Its popularity in Klingon culture lies in its origins, as its inventor was none other than the legendary Kahless the Unforgettable. Commonly misspelled as **BATLETH** in Federation Standard.

BOBCHO'DUB QENGWL (tH. “carrier upgrade module”): A system of clamp-on hangar bays used by the Klingons to add shuttlecarrier capability to an existing hull without conversion. The bulk of these are designed for *Drell* type hulls and derivatives. These are usually mounted in pairs, in arrangement similar to that employed by Klingon fleet tugs, in order to minimize their impact on the ship's warp field.

B'REL (OT “wild woman”): Class name of the most popular small starship used by the Klingon Empire at this time.

BUR'D'KONA (Kl. “hulking brute”): The Klingonaase term for a type of starship that corresponds to the Federation definition of a battleship.

CHESIS D'KLEON (Kl. “havoc wrecker”): The Klingonaase term for a type of starship that corresponds to the Federation definition of a dreadnought.

COMMAND BOOM: The forward part of most Klingon starships, corresponding to the primary hull of a Federation starship. Like its counterpart, Klingon command booms are capable of separation from the rest of the ship and have a (mostly) limited ability to operate as a sublight

escape vessel. Only a few command boom types, such as that of the experimental *Kragg Dor*, are warp capable.

CORSAIR: A type of privately owned starship, usually smaller than a corvette, specially designed for commerce raiding. These tend to be larger and more heavily armed than a gunboat, although there are a fair number of exceptions. Klingons do not have a specific class of starships comparable to corsairs, although many of their House-modified gunboat classes would qualify as such.

CORVETTE: Any starship designed for use as a military combatant that is 100 meters in length or less and has a mass of 100,000 GMT or less.

CRUISER: Any starship designed for use as a military combatant that is at least 200 meters in length and has a minimum mass of 500,000 GMT.

DESTROYER: Any starship designed for use as a military combatant that is at least 150 meters in length and has a minimum mass of 300,000 GMT.

DREADNOUGHT: Any starship designed for use as a military combatant that is at least 300 meters in length and has a minimum mass of 750,000 GMT. See also **QUGH'DUJ'A, POCKET BATTLESHIP.**

DRELL (Kl. “nimble lizard”): The most common type of Klingon starship hull, most commonly used for cruiser type starships but often serving as a design basis for other classes. At its simplest a *Drell* type hull consists of a long-necked command boom with a bulbous forward end and an inverted trapezoidal secondary hull that is usually fitted with dual warp engines on splayed, wing-like pylons. The overall visual effect of a *Drell* type is striking, and is commonly likened to a Terran manta ray in terms of both appearance and apparent menace. *Drell* types are named after the race that invented them, a species of intelligent lizard-like humanoids conquered by the Klingons centuries ago. Although greatly outnumbered, the superior design of their starships allowed the Drell to hold out against the Klingons for many years. After their final victory, the Klingons studied captured Drell

technology and copied their starship designs for their own uses, resulting in today's Klingon *Drell* hull types.

EPETAI-RI'NADA (Kl. "glorious fat man"): Derisive term commonly applied to the Klingon L-13 pocket battleship.

ESCORT: Any starship designed for use as a military combatant that is at least 100 meters in length and has a minimum mass of 100,000 GMT. Escorts are the smallest fleet combatant classification with regards to ships of the line.

GAGH: see **QAGH**

G'AL'PAV (tH. "super box"): Designation for the first series of standardized transport containers used by the Imperial Klingon fleet. Commonly referenced as the G-series in Federation works. See also **TAJ'PAV**.

GRAF UNIT: The Klingon equivalent of warp drive. Terranglo rendering of the term *graf stevi*, (Kl. "anti-curve rider," i.e. light-speed engine). See also **PIJONTA'**

GUNBOAT: A small starship, almost always smaller than a corvette, designed for use as a short-ranged picket or patrol ship. Gunboats sacrifice armaments and protection for speed, relying on acceleration as opposed to shielding to protect them from enemy fire during a battle. Gunboats can be found in both military and civilian service.

HIA'BAH (tH. "fanged animal"): A seven foot tall bipedal reptilian predator native to Q'o'nos. In both appearance and behavior it resembles the prehistoric Terran raptor. The term is a bastardized slang form of the more formal *Ho'law'Dibah*.

HOUSE: The Empire is dominated by some five hundred Houses (Kl. *thelds*, lit "families") that combined control 75-80% of the Klingon political, economic, and military power structure. According to Klingonaase lore, each was founded by one of the five hundred bodyguards of Kling during the unification of the planetary Klingon government. They are roughly divided into two groups: the Great Houses, who control the majority of the Empire's political and economic power; and the Lesser Houses, that usually end up doing most of the hump work in maintaining the Empire's integrity. The Bur Chak not only adopted the House system once they ascended to power but have even gone so far as to claim it to be their own invention, established in the wake of the passing of Kahless in order to maintain his

dream of a unified Q'o'nos. The truth of the matter is that the Bur Chak originally had a clan-based structure and it was effectively adapted (or forcibly merged, depending on your frame of reference) with the more formalized Klingonaase House system during the Bur Chak ascendancy.

HUR'Q' (tH "outsider"): Klingon name for the Karsid, also known as the Old Kings in Klingon lore. See **KARSID**.

KARSID: At one time the Karsid Empire held sway over a vast area of the Beta Quadrant from c.2000 to 358 IR (-1375 BCE to 973 CE). Among the most aggressive and ruthless of the so-called galactic pre-history civilizations, they were noted for their cruelty. They conquered Q'o'nos in 357 IR and stripped the planet of everything of worth. Among their many war prizes was the legendary Sword of Kahless, the original *betleH* and an object of sacred reverence within the Klingon's warrior culture. The Klingons of that era, with technology roughly equivalent to Terra's late 20th century, were simply no match for advanced Karsid beam weaponry and were slaughtered in vast numbers. The survivors fled to the hills or continued the fight in isolated (and largely unsuccessful) guerilla actions. A few, though, managed to swallow their pride and managed to work their way into the Karsid occupation force as servants, shock troops for the occupation of other worlds, or per one surviving legend, volunteers for target practice. It was due to the sacrifice of these few that the Klingons managed to begin to get a grasp on the highly sophisticated Karsid technology, which was centuries ahead of their own.

Very few images have survived of the Karsid. The few that do appear to suggest helmeted and spacesuited humanoids. It is a motif that is repeated on every world they conquered, including Q'o'nos. This may suggest that the Karsid came from a world with a non-oxygenated environment, forcing them to wear life support gear wherever they went. As all records of the Karsid appear to have perished with their fall, the truth may never be known.

Only a few months after their conquest of Q'o'nos, the Karsid Empire was in chaos. This appears to have caused by a near-simultaneous revolt of approximately one-third of its subject worlds. The Karsid were forced to withdraw their forces from Q'o'nos in order to deal with the revolt, but this appears to have been a desperation move. The Karsid Empire collapsed the following year and they appear to have been exterminated in the process. Very few genuine Karsid artifacts have survived as a result. Their former subjects appear to have been determined, as is the historical pattern for such things, to wipe clean all traces of their presence on their former subject worlds. Only the occasional prized artifact and the twisted legends of their former subjects remain as testimony of their existence.

The three centuries that followed the Karsid occupation of Q'o'nos were marked by two major events: the Klingon reclamation of their world and their rapid advance in spaceflight technology. Both were made possible by reverse-engineering the few examples of Karsid technology that remained on their world. The most popular legend on the subject says that a detachment of the *Vag'chalthneS* (tH. "Honored Five Hundred") came across the wreck of a Karsid spacecraft during one of their patrols. It had either crashed or had been abandoned due to battle damage. Enough of it remained intact for those few Klingons who had spent time with the Karsid to begin unlocking its secrets, and events naturally escalated from there. Another, less likely version of the legend is that a secret hangar was discovered at one of the old Karsid bases during a search. Once opened, it was found to contain four small spacecraft, all of which were intact and fully functional. Why the Karsid had left them behind was unknown, but the Klingons chose not to question their good fortune. Modern scholars generally accept the former and discount the latter versions of the tale, but the true account is probably lost in the mists of Klingon antiquity. What is certain is that subsequent Klingon advances in fusion power, that which made possible their first FTL starships, are widely credited to reverse-engineering of Karsid technology.

KHAMIN (Kl. "leader of men"): Captain; the commander of a Klingon vessel or base. The word refers to the position as opposed to the rank.

KHULED (Kl. "sharp tooth"): A short stabbing sword favored by assassins in the days of Klingon antiquity.

KLINGON (OT "children of Kling"): The native humanoids of the planet Q'o'nos.

KLINGON OLD TONGUE: A language of reverence of old, the Klingon Old Tongue is believed to be the original tongue of the Klingons. At present it is only used by the monks of Boreth as a language of ritual and custom, and their monastery is the major source for almost all surviving written examples. Elements of the Klingon Old Tongue survive in the various modern Klingon languages mostly as isolated loanwords, such as *klington* (OT "children of Kling") and *brël* (OT "wild woman"). Specific references to unique Klingon Old Tongue words in this text have the annotation (OT). See also **KLINGONAASE**, **THLNGAN HOL**.

KLINGONAASE (referenced as Kl.): Also known as Klingonese and Old Klingon, this was the language of the Klingon Empire prior to the ascendancy of the Bur Chak (Kl. *bur chak* – "the ridged brutes") within the

Empire's power structure. It has generally fallen out of favor, although its use persists with the *Quch'Ha* (tH. "mixed breeds", i.e. Klingon fusions) and the various Klingon religious castes. It is also considered a language of lore, since the bulk of written Klingon historical records and documents are in Klingonaase. The use of Klingonaase persists for many terms and terminology that were developed prior to the Bur Chak ascendancy to power. It continues today out of expediency, as the Bur Chak simply consider it a waste of time to rename everything in their own native tongue. Specific references to unique Klingonaase words in this text have the annotation (Kl.). See also **KLINGON OLD TONGUE**, **THLNGAN HOL**.

LA'QAWDUJ (tH. "lead destroyer"): The tHlIngan hol term for a type of starship that corresponds to the Federation definition of a destroyer leader.

LAT'D'KONA (Kl. "little brute"): The Klingonaase term for a type of starship that corresponds to the Federation definition of a pocket battleship.

LODNI'DAJ (tH. "little brother"): Term used to denote the lesser of two or more starship classes that enter Imperial service at the same time.

MAY'DUJ'A (tH. "monster ship"): The Klingonaase term for a type of starship that corresponds to the Federation definition of a battleship.

MU'A'VOMU (tH. "glory"): Name for the purported self-destruct system that is to be fitted to the planned *WoQ'a'* class battleships.

OLD KINGS: Per the monks of Boreth, this is a literal translation of the Old Tongue word *kehuk*. The Karsid are often named as the Old Kings in the oldest of Klingon records dealing with the Karsid conquest and occupation of Q'o'nos. The term supposedly has its origins as a reference to the original Klingon "gods" of lore (OT *kehuda*). The references to the Karsid appears to be one of fear, as if the old gods of lore had returned to reclaim their place as the lords of the Klingon people. See also **KARSID**.

PIJONTA' (tH. "warp engine"): The tHlIngan hol term for a starship engine capable of faster-than-light speeds. See also **GRAF UNIT**.

POCKET BATTLESHIP: A military starship that carries battleship armament and defensive systems on a cruiser hull. The Klingon *lat'd'kona* series are classified as pocket battleships in Federation terms.

PUJWI (tH. "weakling"): A term of contempt among Klingons, normally applied to those who for one reason or another are no longer able or fit to

serve as warriors. The term implies dishonor, as opposed to a warrior who was permanently disabled in battle or has simply grown too old or senile to fight.

PUQPU K'T'INGA (tH. “vigilant children”): Term used to denote the generation of Klingon warships (c. 2265-2270) that entered service around the same time as the *K't'inga* class battlecruiser. This was for the most part an interim stage in Klingon starship development that saw widespread enhancements to existing designs, consisting mainly of upgraded engines, weaponry, and installation of more extensive deflector grids. Limited, less expensive versions of these upgrades were frequently backfitted onto existing hulls in order to ensure their continued service. The *puqpu K't'inga* is also noteworthy for several original designs, such as the *K'teremny* and *K't'orr* class destroyers. This generation is traditionally held to have ended with the formal introduction of the *Suvwl Qeh* class command cruiser into fleet service in 2270

PUQPU THLDRN (tH. “children of my design”): Term used to denote the current generation of Klingon warships (c. 2270-present). Their most striking characteristic are their rounded, less angular contours and an obvious break with traditional hull forms such as the venerable *Drell*. The first of these is traditionally held to be the *Suvwl Qeh* command cruiser, although some argue that the *Sivista* class heavy frigate was the first Imperial fleet design to display *puqpu Thldrn* design influences.

PUQ'TAI (tH. “adoption ceremony”): A traditional form of adoption by a Klingon house. By tradition *puq'tai* is only used when a House cannot produce any heirs and wants to maintain its line. A warrior who undergoes *puq'tai* forswears his or her former House and adopts the name and family history of the new one. Klingon Houses have also been known to invoke *puq'tai*, usually in secret, in order to save the heirs or children of disgraced or destroyed Houses with whom they were once allied.

QAGH (tH. “serpent worms”): A Klingon delicacy since time immemorial. It was originally a food staple served during times when fresh meat was scarce. In its modern form *qagh* is little more than a dishful of harmless, tasteless, protein-rich worms, available in a variety of forms (both in the type of worms and in the preparation), but by tradition are served and eaten live. Connoisseurs of Klingon food claim that the so-called “taste” of *qagh* is best judged by the sensations one receives from the death spasms of these worms as they are chewed and digested. Most non-Klingon cultures find *qagh* revolting, although it is possible to develop a taste for it. Commonly misspelled as **GAGH** in Federation Standard.

QU'HEGH (tH. “death rite blade”): A special type of dagger used for the Klingon form of ritual suicide.

RAH'IR (tH. “woman warrior”): A popular society comprised entirely of female Klingon warriors. Their common bond is their warrior code, *ghop'be* (tH. “hand of woman”), which seeks to control the “wilder” influences of male Klingon society; that is, to direct their natural aggressiveness towards more constructive purposes instead of lashing out wildly without purpose or thought. The *RaH'ir* claim to trace their history back to the founding of the *Vag'chalthneS*, the personal bodyguard of Kahless. In their version of the tale Kahless specifically selected the best warrior females from rival houses to serve in the *Vag'chalthneS*. This version of the tale is hotly disputed by the modern *Vag'chalthneS*, who claim that it always was and always will be an all-male organization. Be that as it may, the teachings and influence of the *RaH'ir* are quite pervasive. It safe to assume that almost any female Klingon warrior one encounters in the field has either trained with or is a member of the *RaH'ir*. See also **VAG'CHALTHNES**.

RU'USTAI (tH “bonding ceremony”): A traditional form of arranged marriage among Klingon Houses. Its primary purpose is to gain social and political advantages for one or both of the Houses involved.

SECONDARY HULL: Also known in some publications as the engineering hull, this is everything on a Klingon starship aft of the command boom. Unlike Federation secondary hulls, however, Klingon secondary hulls usually contain the bulk of a starship's weaponry. Also, secondary hulls of most smaller Klingon starship classes, usually of destroyer/scout size or less, are not capable of independent operations as are their Federation counterparts.

SHIP OF THE LINE: In Terran naval parlance, the term *ship of the line* is a capital ship, a military vessel designed to both give and take abuse for extended periods in the thick of battle. These were often the largest and most powerful vessels in an aquatic navy. The term dates back to the days of sailing ships, which often engaged each other while attempting to sail in parallel lines. This allowed them to bring the maximum number of armaments to bear on their enemies. In modern Starfleet tradition a *ship of the line* is any military starship designed for combat that is of escort classification or larger.

SIVISTA (Kl. “fastsword”): A type of Klingon sword that is somewhat smaller than the *yan*. It is derived from a type of sword commonly used by the northern tribes of Q'o'nos in ancient times. In modern times is

traditionally worn as an article of dress at formal ceremonies when carrying one's *betleH* or *yan* is impractical. See also **YAN**.

STO-VO-KOR (OT “the place where the peoples are gathered”): The paradise in the afterlife for those Klingons who have been valiant enough to earn the honor. It shares certain parallels with the Norse Valhalla of Terran mythology, such as the opportunity to continue to fight great battles and then taking part in great feasts afterwards. Those Klingons who fail to gain entrance to Sto-Vo-Kor are instead sent to Gre'thor, the Klingon analogue to Hell.

TARG (OT “enduring little beast”): A herding animal native to Q'o'nos similar in both form and appearance to the Terran razorback boar. The main physical difference is the profusion of spikes that run along its spine. They are generally quite vicious in the wild, but have been domesticated by the Klingons as both pets and foodstock. They are considered the Klingon equivalent of the Terran dog and exist in about the same numbers and breeds.

Targ meat in any form is a common staple on Klingon warships. On smaller vessels and in the infrequently accessed portions of larger ones, one can often find strips of *targ* meat being cooked or dried by duty crews on the nearest heat source – usually the closest heat exchanger or conduction pipe. It is common for all Klingon warriors to carry two or three day's worth of dried *targ* meat somewhere on their person in the event of an emergency. This is often consumed as an all-day snack so the warrior in question does not have to leave his or her station for meals.

THELD (Kl. “house, family”): See **TUQ**.

TOKHESA KASSE'HA (Kl. “deliberate giveaway”): The official name for the Klingon Empire's starship technology exporting program. Under its auspices, older starships and starship technology for which the Empire has no more use are sold to its allies and vassals. The profits raised from this effort are then used to fund new Imperial shipbuilding efforts.

TAJ'PAV (tH. “dagger box”): The second series of standardized transport containers currently fielded by the Klingon Empire. Frequently referenced as the T-series in Federation literature. These were introduced at the same time as the *Tormin* class fleet transport/tug. They are slowly replacing the G-series as the older containers wear out. The name is thought to derive from their tapered aft sections, which gives them a knife-like appearance.

TLHLNGAN HOL: The official language of the modern Klingon Empire. It is also the native tongue of the Bur Chak, the Klingon humanoids that currently dominate it. It is a harsh language on the ear, with comparisons to Terran Slavic tongues and the spit-speech of the nomads of Thrysodia IV. It is also currently “burdened” with a heavy infusion of Klingonaase loanwords as the Bur Chak continue to establish their newfound cultural dominance over the Empire. Specific references to unique thlngan Hol words in this text have the annotation (tH.). See also **KLINGON OLD TONGUE, KLINGONAASE**.

TUQ (tH. “outer garment, clothes”): In the formal sense, a Klingon *TuQ* is one of the great families that dominate Klingon culture and politics. The term is often translated as “House” in Federation standard and both terms are always capitalized to denote this context. This is so it will not be confused with its common root word *TuQ* (tH. “clothing”). Most thlngan hol scholars believe it to be a clipped form of the word *TuQluch* (tH. “armor”) for reasons that will soon become clear.

The term has its origins in the frequent intermarriages, or *ru'ustai* (tH “bonding ceremony”) that occur between Houses in efforts to gain prestige and power. The warrior or warriors in question don the armor, gear, and weapons of their new House as part of the *ru'ustai*; thus they literally and physically assume their new identity when they become part of their new House. There are about 350 or so Great Houses (*law'TuQ*) and almost 2000 Lesser Houses (*puS'TuQ*). The number tends to vary over time due to House feuds and the occasional Klingon civil war. One is either born into a House, marries into it via *ru'ustai*, or can be adopted by the House via *puQ'tai* (tH. “adoption ceremony”). All Klingon Houses have their own private armies and space fleets, with their size and strength dependent on its resources and status. All of the Great Houses claim descent from the bodyguard of Kahless (*Vag'chalthneS*) as a matter of pride, although proof is questionable in many cases. It is also not unknown for a Klingon warrior from a disgraced or fallen House to found a new one of his own (*jlneH jiH*), tH. lit “I go alone”). It is by this means that many of the Lesser Houses came into being.

VAG'CHALTHNES (tH. “Honored Five Hundred”): The personal bodyguard of Kahless. In modern times it serves more of a ritualistic function as the ceremonial guard of the Klingon High Council. Its origins lie in the defense of the Great Hall of Qam-Chee by Kahless and his lover, Lukara, against five hundred opponents in 205 IR (830 CE). According to the legend is said that Kahless was so impressed by the valor of his foes during that fight that he created the *Vag'chalthneS* to honor their memory. In so doing he won the respect and loyalty of those who had sent the force against him. All of

the modern Klingon Houses, both Great and Small, claim descent from the original five hundred warriors hand-picked by Kahless as members of the first *Vag'chalthneS*. Thus it is that each individual member of the modern *Vag'chalthneS* represents one of the Houses. As there are more than five hundred houses in modern times, appointments to the *Vag'chalthneS* are fiercely contested. They almost always go to favored sons of the Great Houses, although it is not unknown for an ambitious Lesser House to win an open slot. Such is often a sign that it is about to move up and join the ranks of the Great Houses, often at the expense of current member in disgrace. Service in the *Vag'chalthneS* is also considered an important stepping-stone in Klingon politics, as its members have direct (albeit non-voting) access to the High Council at all times. See also **RA'HIR**.

VILOH' LAHBE' (tH. "utterly useless"): One of the lowest of the short-form Klingon insults. A concise definition is difficult in Federation Standard. The concept behind this insult involves a being or piece of equipment that has never served any purpose and has no redeeming value, nor will it ever be capable of such. The only things it is capable of doing are taking up space and consuming valuable resources.

VIMRADEN (Kl. "dedicated small craft transporter"): The Klingonaase word for a dedicated starship shuttlecarrier design. This is a fairly new concept for the Klingons, who in the past have always built their carriers via conversions from other classes or by fitting them with carrier pods.

YAN (Kl. "doom"): The oldest of the traditional Klingon blade weapons. It was first popularized by the southern tribes of Q'o'nos in ancient times. The *yan* is a large sword, with an oversized, wavy blade and a d-guard slanted away from the user from top to bottom. The actual shape and form of the blade varied from House to House in ancient times, with each having its own peculiar design. The names apparently comes from the ability of a warrior to literally "wield the power of doom" on the battlefield. Although displaced by the *bet'leH*, it still remains quite popular among Klingons and its mastery is part of the standard rite of passage for all warriors regardless of rank or gender. See also **SIVISTA**.

Afterword

Well, as you may or may not have learned by now, other projects and interests have conspired to pull me away from the wonderful world of *STAR TREK*. That means I'm not going to be able to do the multi-volume work I was planning with *Mandel's Fighting Starships*, of which this is technically the second volume. That's why I've decided to release what I have now – so both you'll have it and I won't wind up losing it later on down the road. You guys and gals have always been nice to me and I appreciate that. Think of this as one for the road, okay?

I hereby donate this document to the *TREK* community at large and to the TrekbBS in particular. For what it's worth, you have my permission to use it and do with it whatever you want so long as I get credit for the original concept. Here's hoping that one or more of you can finish what I started.

Live long and prosper

Richard E. Mandel

