

An adventure for use with  
**STAR TREK**<sup>®</sup>  
THE ROLE PLAYING GAME

# THE STRIDER INCIDENT

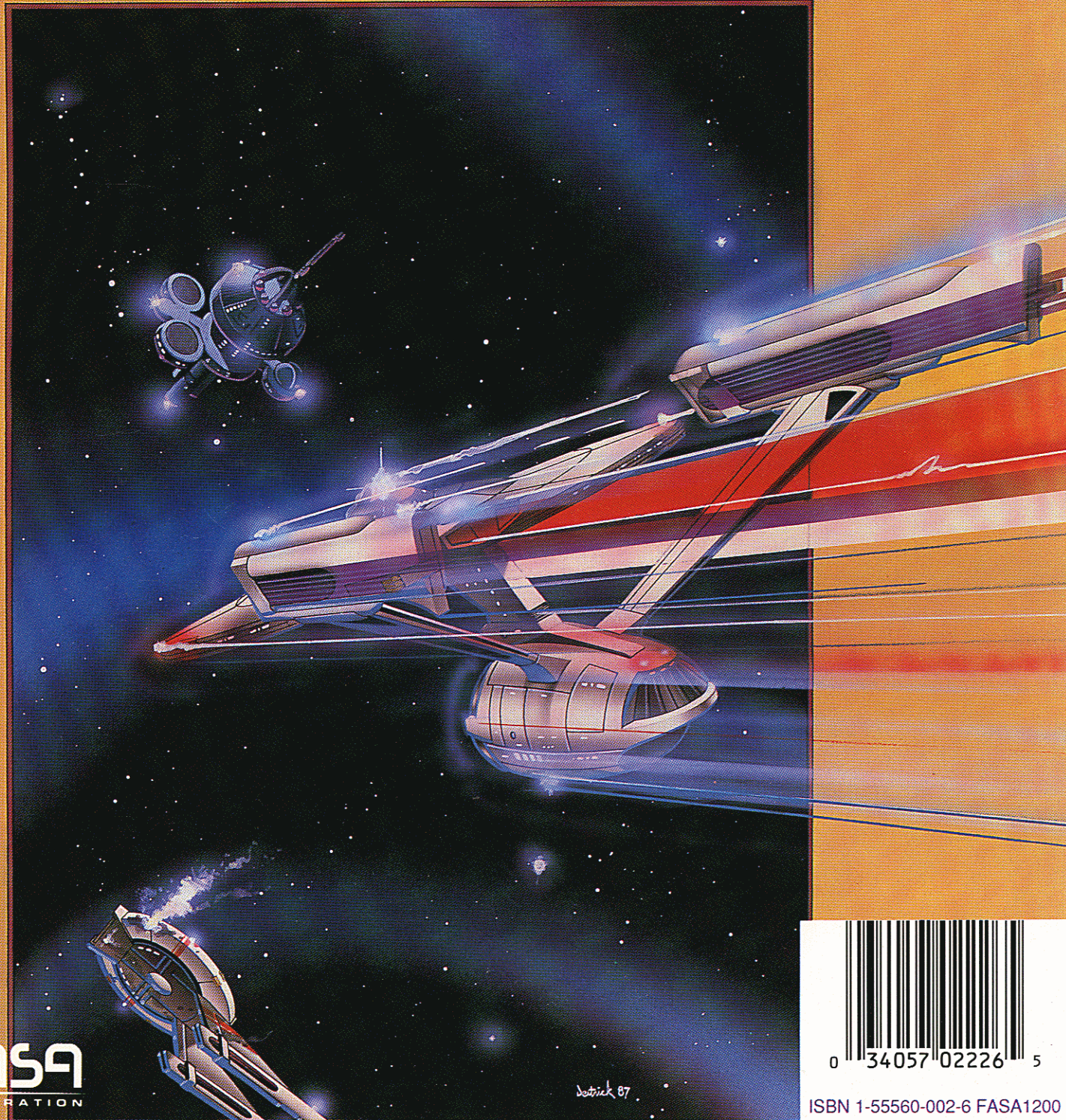

**FASA**  
CORPORATION



ISBN 1-55560-002-6 FASA1200

STAR TREK is a Registered Trademark of Paramount Pictures Corporation.  
STAR TREK: The Role Playing Game is published by FASA Corporation under license from Paramount Pictures Corporation, the trademark owner.  
Copyright © 1987, Paramount Pictures Corporation. All Rights Reserved.

### IS THE FEDERATION AT WAR WITH THE KLINGON EMPIRE?

... or did Captain Reardon violate Klingon space to avenge her brother's death?

While stuck aboard an R-1 Type defense outpost, the player characters are drawn into the investigation of the *USS Strider's* attack on the Klingon Empire. If the group fails to discover who sent the war orders to Captain Reardon, the Klingons will use the incident to gain control of a strategic system in the Neutral Zone. In addition, they will take Reardon prisoner...and Klingons do not treat Federation prisoners gently.

***THE STRIDER  
INCIDENT***

## THE STRIDER INCIDENT

### Design and Writing

Blaine Pardoe

### Editorial Staff

#### *Editor-In-Chief*

L. Ross Babcock III

#### *Senior Editor*

Donna Ippolito

#### *Editor*

Todd Huettel

### Production Staff

#### *Production Manager*

Jordan K. Weisman

#### *Art Director*

Dana Knutson

#### *Cover Art*

David R. Deitrick

#### *Illustration*

Bob Eggleton

Dana Knutson

Jeff Laubenstein

Todd F. Marsh

#### *Typesetting and Layout*

Tara Gallagher

#### *Pasteup*

Dana Knutson

Jeff Laubenstein

Todd F. Marsh

# TABLE OF CONTENTS

<b>INTRODUCTION</b> . . . . .	5
Plot Synopsis . . . . .	5
Contents of this Book . . . . .	5
<b>THE ADVENTURE</b> . . . . .	6
Setting the Stage . . . . .	6
Port of Call . . . . .	6
Of Captains and Commodores . . . . .	7
Dinner Talk . . . . .	7
<b>Breakfast with the Brass</b> . . . . .	8
A Private War . . . . .	8
A Planet Divided . . . . .	8
<b>The Investigation Begins</b> . . . . .	9
Communications Research . . . . .	9
Captain Reardon's Story . . . . .	9
Crew of the <i>Strider</i> . . . . .	10
<b>Duty Calls</b> . . . . .	11
Status of the <i>Lexington</i> . . . . .	11
Status of the <i>Strider</i> . . . . .	11
<b>Klingon Arrogance</b> . . . . .	11
<b>Revenge</b> . . . . .	12
<b>Suicide or Murder?</b> . . . . .	12
<b>A Bold Plan</b> . . . . .	13
Convincing the Captain . . . . .	13
Hashing Out the Details . . . . .	13
The Third Degree . . . . .	13
Jury-Rigging Repairs . . . . .	14
The Breakout . . . . .	14
The Getaway . . . . .	15
<b>Voyage of the <i>Strider</i></b> . . . . .	15
Hopplemeyer . . . . .	15
An Intercepted Message . . . . .	15
Arriving in Stogar . . . . .	16
<b>An Unexpected <i>Bird of Prey</i></b> . . . . .	16
Klingon Power Play . . . . .	16
Standoff . . . . .	16
The Diplomatic Table . . . . .	17
The Evidence . . . . .	17
<b>Homecoming</b> . . . . .	18
Accusations . . . . .	18
Unmasking the Spy . . . . .	18

<b>BACKGROUND INFORMATION</b> . . . . .	19
<b>Tasor</b> . . . . .	19
History . . . . .	19
Current Status . . . . .	19
<b>Captain Reardon's Log</b> . . . . .	20
<b>Personnel Records</b> . . . . .	20
<b>MAP</b> . . . . .	23
<b>VESSELS</b> . . . . .	24
<b>Enterprise Class XI Cruiser</b> . . . . .	24
<b>Ranger Class V-VI Scout</b> . . . . .	25
Deck Plans . . . . .	26
<b>K-22 (<i>Bird of Prey</i>) Class V Scout</b> . . . . .	32
<b>CAST OF CHARACTERS</b> . . . . .	33
<b>Player Characters</b> . . . . .	33
<b>NPCs</b> . . . . .	41
Crew of the <i>Strider</i> . . . . .	42
Outpost Personnel . . . . .	47
Klingons . . . . .	52
<b>GAMEMASTER'S NOTES</b> . . . . .	53
<b>Timeline</b> . . . . .	53
<b>Mechanics of Play</b> . . . . .	54
Player Character Selection . . . . .	54
Judging Action . . . . .	54
<b>Special Considerations</b> . . . . .	55
Pressure . . . . .	55
Gamemastering NPCs . . . . .	55
Rumors . . . . .	55
Actual Log Entries . . . . .	56
<b>Further Adventures</b> . . . . .	56

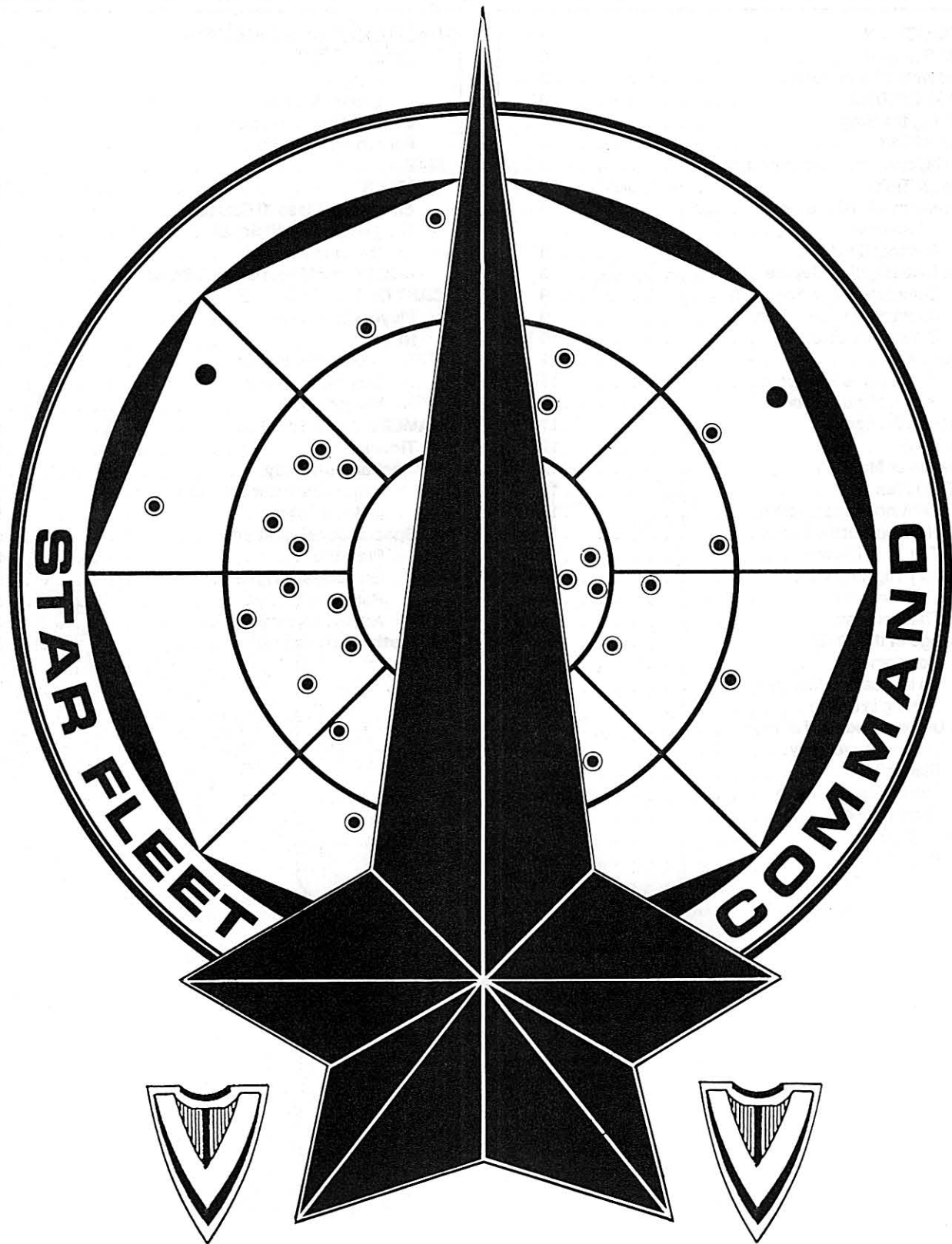

# INTRODUCTION

The **Strider Incident** is designed for use with **STAR TREK: The Role Playing Game** as well as the **STAR TREK Starship Tactical Combat Simulator**. The Klingons supplement and the **Klingon Intelligence Briefing**, also from FASA, may prove useful, too. Up to six players can play this scenario, each representing a department head on the *USS Lexington*, an *Enterprise Class* cruiser. As written, **The Strider Incident** assumes that the ship's Captain is an NPC, but the gamemaster may modify that if he wishes to allow a player to roleplay Captain Franklin.

## PLOT SYNOPSIS

After a run-in with a pirate vessel, the *USS Lexington* docks at Orbital Defense Outpost 1121 for repairs. There, the crew learn that a Federation task force entered Klingon space illegally and walked into an ambush. The leader of the task force, Captain Reardon, is awaiting a court-martial at the station. After some investigative work, the players discover that the Klingons are using this incident to strengthen their claim to a star system in the Organian Neutral Zone. In addition, some existing evidence seems to incriminate Captain Reardon, who maintains that someone ordered her into Klingon space. Though her crewmembers have no proof, they believe that she is being railroaded. Then, before he can deliver some new information to the player characters, a crewman on the base is killed.

Through NPC prompting or their own conclusions, the player characters decide to steal Captain Reardon's vessel, the *USS Strider*, and to take her back into Klingon space. There they will search for Reardon's log buoy, which contains the evidence that will either clear or convict her.

Springing Captain Reardon and stealing the *Strider* will not be easy. Hindering their efforts along the way is Captain Curtis, the Base Commander, who seems to be the culprit who sent the Task Force to their fate.

Once the players' group is within the Klingon Empire, a *Bird of Prey* scout intercepts the *Strider*. Although the Klingon Captain is eager to capture them, he allows them to depart Klingon space with the log buoy. The log does indeed show that Captain Reardon was ordered into the Empire. Some further sleuthing and a bit of computer wizardry help the player characters discover the true culprit.

Upon returning to the outpost, the players' group finds itself facing a Klingon diplomat, a deeply buried Klingon agent, the full firepower of the *USS Lexington*, and several court martials. Can the player characters defuse this situation and bring the real villain to justice?

## CONTENTS OF THIS BOOK

The **Adventure** section contains the events and encounters that the player characters experience on the outpost and during their journey to and from Klingon space. **Background Information** provides a world log and description of the planet Tasor, personnel records of the surviving crewmembers of the *USS Strider*, and Captain Reardon's copy of the *Strider's* log. A map of the region of space in which the adventure occurs is included in the **Map** chapter. **Vessels** contains statistics and complete deck plans for the *USS Strider*, in addition to statistics on the other ships encountered during this adventure. **Cast of Characters** provides full statistics on several pre-generated player characters, which the players may wish to use whole or in part. Statistics for important NPCs are also included. Finally, **Gamemaster's Notes** contains an adventure timeline, hints on play, a list of rumors that the player characters may hear regarding the *Strider* incident, and a scoring procedure for judging player character actions. The companion booklet contains the complete plans for Orbital Defense Outpost 1121, an *R-1* orbital facility.

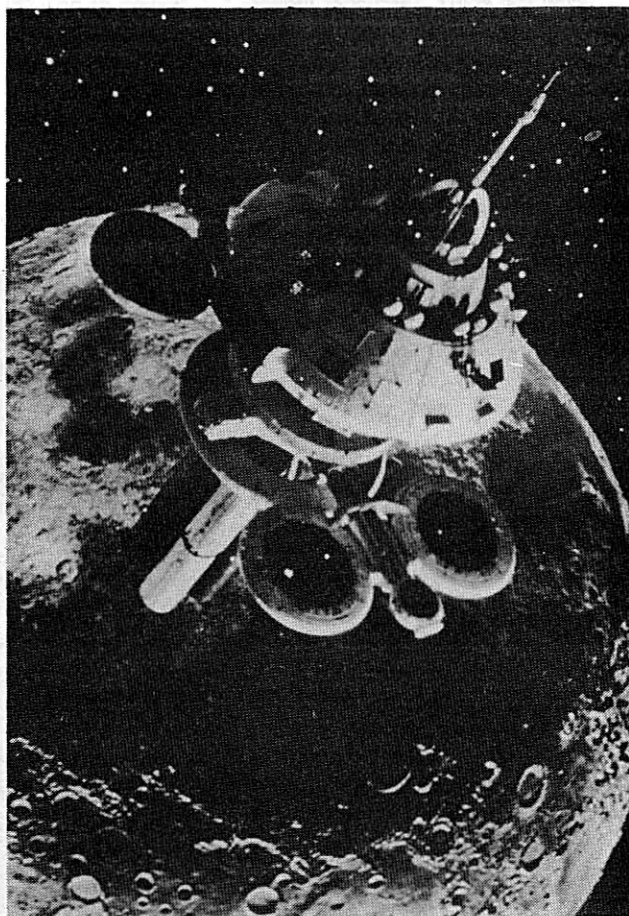

# THE ADVENTURE

## SETTING THE STAGE

Upon entering service in Stardate 1/1802, the *USS Lexington* was sent to patrol the Organian Neutral Zone border. During her shakedown cruise, the *Lexington's* warp engines performed very erratically, however. Though the Chief Engineer completed makeshift repairs to the engines, sterner measures were required. Captain Franklin, commanding officer of the *Lexington*, ordered his ship to return to Star Base 12 for the needed work.

Before the ship could reach base, however, Star Fleet changed the itinerary. A pirate vessel had destroyed two large freighters near the *Lexington's* position, and now the *Lady Lex* was ordered to warp out to investigate the attack. After discovering the wreckage of the freighters, Captain Franklin broadcasted a distress call on civilian frequencies, claiming to be a large freighter with engine problems seeking escort to a repair facility. This transmission drew the pirate vessel out of hiding, and the *Lexington* engaged the ship when it refused to surrender. Seeing that escape was impossible, the pirate ship self-destructed, which also damaged the jury-rigged warp engines of the *Lexington*.

With the ship's antimatter inducer functioning at only 20 percent capacity, Captain Franklin set course for the nearest repair post, Federation Defense Outpost 1121. Limping for several weeks at Warp Factor 2, the *USS Lexington* finally arrived at the small outpost, ignorant of the events that were unfolding there.

## PORT OF CALL

On Stardate 2/1809.01, the *USS Lexington* arrives in the Korial system and drops to sublight speed. As per regulations, the player characters should signal the base to receive docking clearance. While approaching the Outpost, the crew sees a badly damaged *Ranger* Class scout moored to the repair facilities. Any player character with a skill rating in *Mechanical Engineering* can tell that the ship's superstructure has sustained severe damage. The vessel's hull number is NCC 7141, identifying it as the *USS Strider*.

If the player characters request information concerning the *Strider*, the Outpost's Communications Officer will tell them that all information on that vessel is classified and cannot be disclosed at this time.

Once the *Lexington* is moored, the player characters receive notice from the post's Communications Officer that they are to report to Post Commander Curtis in the Outpost's command center. The Chief Engineer and the Supply Officer should accompany the players' group to requisition the tools and supplies they need for the *Lexington's* repairs. The Outpost's Communications Officer also tells Captain Franklin that, although the Outpost's recreational facilities are meager, the crew of the *Lexington* is more than welcome to use the planetside base for shore leave.

Beaming to the Outpost's transporter room, the landing party encounters several security men, who escort the Captain and his officers to their meeting with Captain Curtis in the command center. Consult the accompanying book's blueprints for deck and room descriptions.

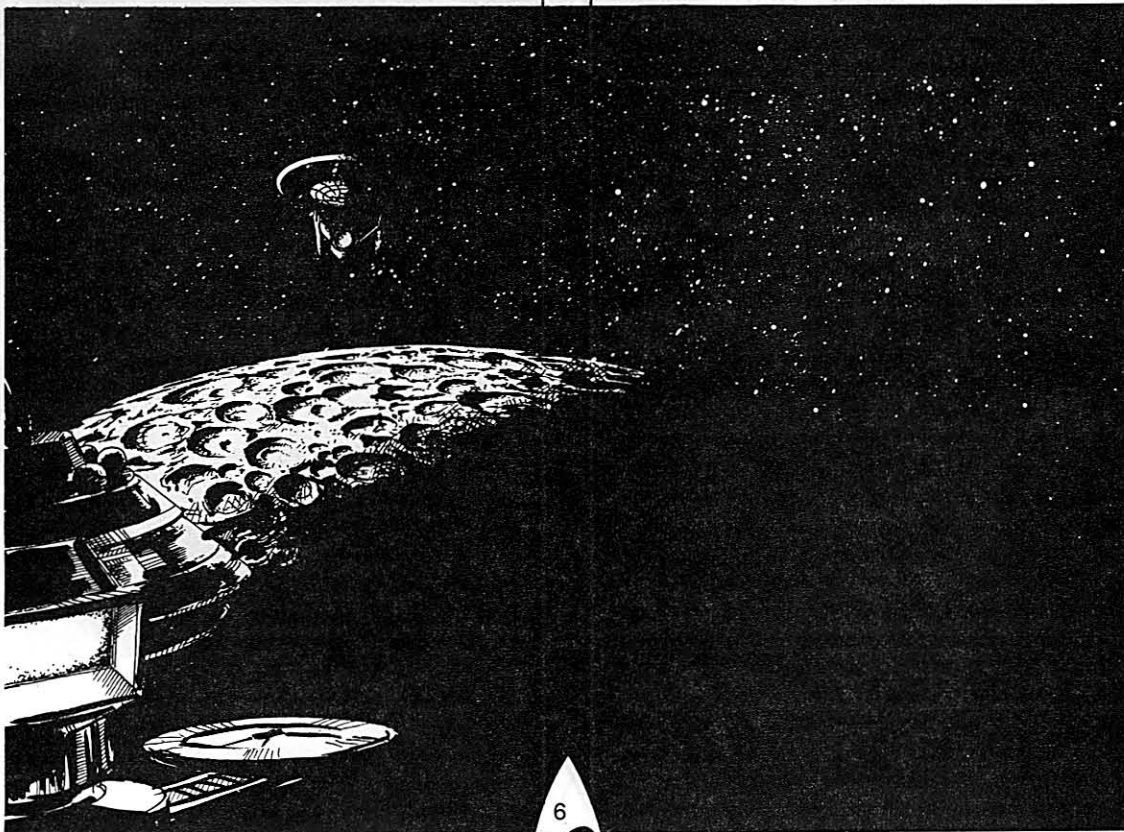

## OF CAPTAINS AND COMMODORES

In the command center, the player characters are introduced to Captain Carl Curtis, (Commander of Federation Defense Outpost 1121), Commodore Bram Harmonson, and Commander Gordon Davidson, the post's Chief Engineer. Davidson ushers the Chief Engineer and the Supply Officer to the Officers' Lounge to discuss repairs on the *Lexington*.

Commodore Harmonson is very quiet and withdrawn. If questioned about the *Strider*, he reveals that the vessel is all that remains of Task Force 13, but that the subject is not open for public discussion. Harmonson's main concern seems to be helping the *Lady Lex's* crew to get their ship operational again. While they are talking of this and other matters, Captain Curtis asks Captain Franklin about the *Lexington's* encounter with the pirate vessel. When Franklin proceeds to describe the brief battle, both Curtis and Harmonson are impressed. Curtis mentions that he hopes for a ship command of his own when his tour on the Outpost is over.

If pressed for further details concerning the *Strider*, the two men will invite the *Lexington* officers to dinner at the Officers' Lounge, where they promise to discuss the matter further. Until then, the player characters should tend to their vessel and their own relaxation.

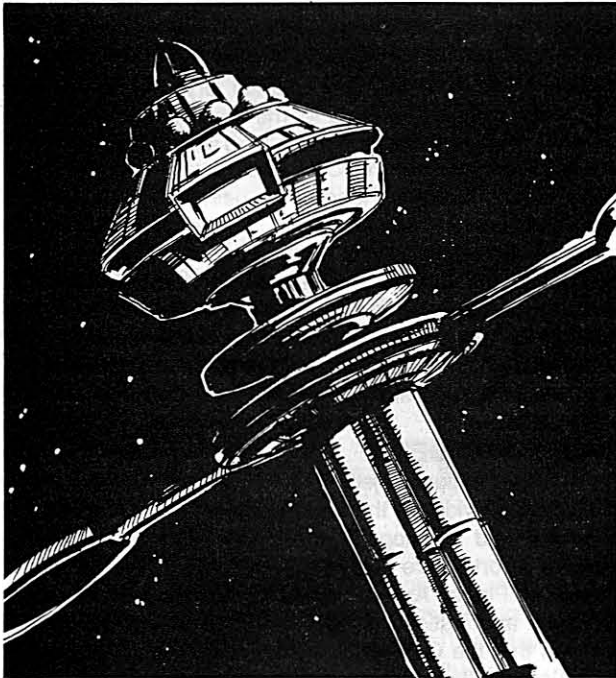

## DINNER TALK

When Captain Franklin and his executive officers go to the Outpost's Officers' Lounge for dinner, they find only Captain Curtis waiting for them there. He tells the group that Commodore Harmonson is preparing to meet a Klingon Diplomatic Corps envoy to discuss the *Strider* incident and so will not be able to join them. Curtis further says that he has little time to spare either, as he is in a hurry to assist the Commodore.

Getting quickly to the point, Curtis describes how Captain Kristine Reardon, Commander of the *Strider*, took a small task force into the Stogar system to attack the Klingon Empire. Although her reasons for this action are unclear, he implies that she did it for personal glory. A Klingon fleet decimated the Task Force, and the *Strider* was the only ship to return. Until her court martial, Kristine Reardon is being held in the Outpost's prison. Curtis hints that Commodore Harmonson will probably ask Captain Franklin to serve as a judge, because Franklin is a high-ranking line officer.

Captain Curtis then turns the discussion to the Klingon claims for the Tasor Major System. Prior to the Four Years War, the Klingons had established a small colony on Tasor, which they planned to develop as a major shipbuilding base. The Treaty of Axanar, which ended the war, ceded control of Tasor to the Federation. However, under the terms of the Organian Peace Treaty, Tasor fell within the Organian Neutral Zone. To gain control of the star system, the Federation has to demonstrate that it can develop the system more efficiently than can the Klingons.

If the Klingons get the system, they would gain control of a sparsely populated planet with great industrial potential right on the UFP's border. Such an outpost would force the Federation to redesign its defensive perimeter, which would require many years and billions of credits. The UFP project has had some success on Tasor, but the Klingons have poured a great deal more time, money, and manpower into their efforts. Although they knew negotiations for control of Tasor were not going to be easy, the Federation had had a fighting chance until the *Strider* Incident.

Captain Curtis feels that the attack by Task Force 13 might compel the Organians to award the system to the Klingon Empire. As the UFP's chief negotiator for Tasor, Commodore Harmonson knows that the Klingons will use the incident to solidify their own claims.

Before the player characters can ask him any questions, however, Captain Curtis excuses himself, saying he must join the Commodore to work on the Federation proposal. He suggests that if they wish to know more about the *Strider* or the Tasor situation, they should contact the Commodore first thing in the morning.



## BREAKFAST WITH THE BRASS

The next morning, Captain Franklin and his officers should meet with Commodore Harmonson in his VIP room to discuss matters in more detail. When the player characters arrive, Harmonson is just sitting down to breakfast and insists that the officers join him. As they are eating, he briefs the players' group on the situation.

### A PRIVATE WAR

The *Strider* was part of Task Force 13, a unit assigned to patrol the area near Defense Outpost 1121. The other two ships in the group, the *USS Clark* and the *USS Vidal*, were also *Ranger* Class scouts—small, fast vessels adept at reconnaissance.

After 20 days of patrol, Captain Reardon ordered the task force into the Neutral Zone. Under the Organian Treaty, that action was the equivalent of a declaration of war, and the Organians should have immediately destroyed the vessels. That they remained silent signifies that either their power does not extend far enough distant from Organia or that the Organians are withdrawing from UFP-Klingon affairs.

Captain Reardon took the group into the Stogar system in Klingon space. Her subordinate commanders no doubt followed her orders, presuming that war existed between the Federation and the Klingon Empire. The Task Force conducted itself according to regulations that apply during a state of war, which, of course, does not exist.

In the Stogar system, the Task Force encountered five Klingon *D-7M* battlecruisers. Though the three scouts had no chance against such odds, they were too far into Klingon

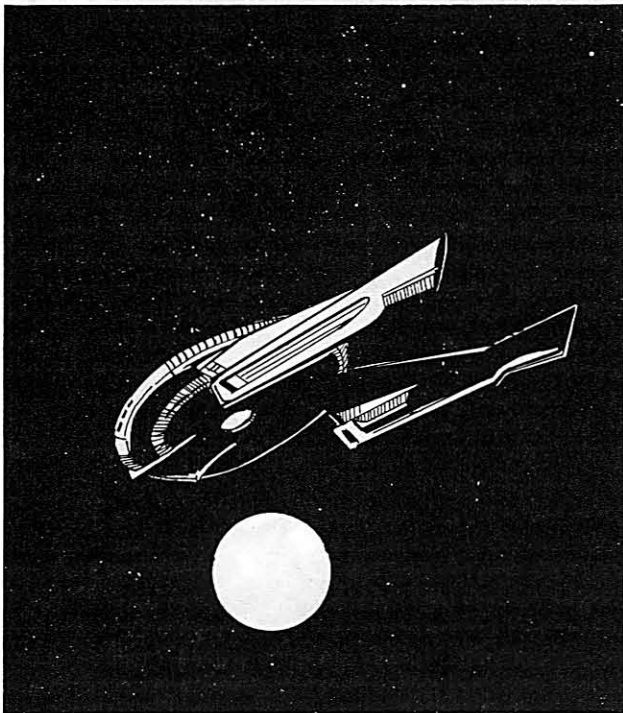

space to make a clean getaway. Three of the *D-7Ms* destroyed the *USS Vidal*, and the *Clark* was also destroyed in the first few seconds of battle. While fleeing the system, the *Strider* took a direct hit to its warp engines, fell out of sync, and imbalanced, thrusting the ship into a Wormhole. The Wormhole effect took the *Strider* far from the attacking Klingons.

On Stardate 2/1808.28, the *Strider* limped into Federation Defense Outpost 1121 for battle repairs. When Captain Reardon reported that her task force had attacked a Klingon formation, Captain Curtis beamed over a security team to arrest her.

Captain Reardon's defense is that she received a Code Red 1-A transmission, the code for all-out war, and that she was only following her orders. Because she jettisoned the *Strider's* log at the height of battle, there is no evidence to support her claim. The *Strider's* computer systems were so badly damaged that the log tapes were worthless.

Commodore Harmonson describes Captain Reardon as very independent and headstrong. According to Captain Curtis, Reardon is difficult to work with and frequently displays an almost obsessive hatred of the Klingons. Curtis also told the Commodore that he suspected Reardon of leading the Task Force into Klingon space on some sort of mad glory mission. Although the Commodore has refused to let Captain Curtis sit on the court-martial jury because Curtis seems to be prejudiced concerning Captain Reardon, he has decided to appoint Curtis as chief prosecutor for the case.

At this point, Commodore Harmonson asks Captain Franklin to sit in on the court-martial jury. Franklin has no choice but to agree, and so learns that Commodore Astak will arrive in several weeks to fill the third seat on the jury.

Although accused officers are usually placed under house arrest, Captain Reardon is being held in the Outpost's brig for her own protection. Many crewmen in Task Force 13 had families living on the groundside post, as their ships operated out of the Defense Outpost. There have been several threats against Captain Reardon, and Commodore Harmonson fears that someone may try to kill her.

The Commodore then changes the subject to Klingon claims in the Tasor system.

### A PLANET DIVIDED

The Federation project on Tasor demonstrated that the UFP could provide for the small population while allowing it to evolve and develop. The Klingons also made an impressive effort, more than making up for their failure on Sherman's Planet. As the Federation has a better reputation for peace and justice than do the Klingons, UFP diplomats believed that the Organians would award them the system. Unfortunately, the attack by Task Force 13 has endangered the Federation's peaceful reputation and has given the Klingons the tool they need to press for control of Tasor.

In the next few days, the Klingon ambassador will arrive on the Outpost to begin negotiations concerning the Tasor Major system. He will no doubt demand that the Federation turn over Captain Reardon as a galactic criminal of peace. If her court-martial finds her guilty, Kristine Reardon may very well be turned over to the Klingon Empire to mollify the Klingons.

As the Commodore closes the meeting, he reminds Captain Franklin that, as one of the court-martial justices, he cannot investigate the case personally. He also mentions that Captain Reardon has refused to accept counsel in her upcoming trial.

## THE INVESTIGATION BEGINS

After the meeting, Captain Franklin suggests that the player characters should look into the *Strider* incident. As the post offers little in the way of entertainment, the group should welcome this diversion. Indeed, most of the Outpost's personnel are asking to tour the *Lexington* because they are so bored with their own facilities.

### COMMUNICATIONS RESEARCH

According to Commodore Harmonson, Captain Reardon claims to have received a Code Red 1-A command for all-out war. Such a message would have had to come from Task Force 13's base of operations—Defense Outpost 1121. Thus, the player characters should investigate the Outpost's communications system.

The staff at the Communications and Electronics Center is more than willing to allow the player characters to investigate the system. Lieutenant Art Davials, the Deck Chief, tells the *Lexington* officers that someone would have had to access the communications computer's Priority Commands in order to issue a Code Red 1-A command. If the player characters check to see who was using the communications computer when Reardon received her message, they find that Captain Curtis was accessing the system at that time. Aside from him, only communications personnel were operating the computer.

If a player character asks Lieutenant Davials who can access the Priority Commands, he replies that only the Outpost Commander or someone with a high security clearance can use the codes. If a player character checks the computer's Priority Commands user sign-on record and makes a Skill Roll against his rating in *Computer Operation*, he discovers that the Priority Commands have not been used or tampered with.

If the *Lexington* officers neglect to ask about the Priority Commands backup disc, have them all make *Computer Operation* or INT rolls to discover their oversight. The backup copy shows some traces of recent use. However, someone has erased the disc's user sign-on record. Also, the time of the last transmission and its directional coordinates have been erased.

At best, this evidence is circumstantial. It simply proves that someone might have used the backup copy. Thus, Kris Reardon is not cleared yet.

### CAPTAIN REARDON'S STORY

When the player characters request a meeting with Captain Kristine Reardon, they are granted only a few minutes with her "for security reasons". The player characters should try to see the situation from her point of view. She has lost her command, her career is in tatters, and she is being blamed for numerous deaths. Showing signs of severe stress and pressure, she seems almost paranoid. Before she begins her story, she takes a deep breath.

"I'm glad I finally have a chance to tell unbiased people what really happened to me and the Task Force.

"We were several days into our patrol when my Communications Officer received a Code Red 1-A transmission. I took the message personally so that none of the bridge crew would hear it until it was confirmed. I acknowledged the communication and received the proper confirmation from the sender, who had to be at this base.

"My orders in time of all-out war are to take my Task Force to the Stogar system in the Klingon Empire. We were supposed to link up with a larger patrol group there and act as their recon support. I honestly thought that war had been declared, and so I led my group in at full alert. We arrived at the system on Reference Stardate 2/1808.19. I scanned the system for unfriendlies, then waited in the asteroid belt for the other group to arrive. Needless to say, it never did."

### Klingon Reception Committee

"The *Clark* picked up a Klingon battle group of five *D-7Ms* moving in on our position. We were in way over our heads, and so I ordered my Task Force to pull back and prepare to exit the system. Before we could execute, they were all over us. I swung the *Strider* wide to veer away from the attack force. The *Vidal* and the *Clark* swung in the other direction, taking them directly into the Klingons. I ordered them to pull back, but it was already too late.

"The *Clark* took several direct hits from photon torpedoes, blasting her foredeck into scrap metal. Captain Lewis turned the *Clark* into the lead Klingon vessel and hit it head-on. All that matter and antimatter went up at once—I think both ships were lost, but I couldn't tell for sure.

"The *Vidal* had a chance, but it was slim at best. It pivoted hard about and passed the Klingons at full impulse power, taking light damage. It cut behind the Klingons and almost linked up with us, but the aft torpedoes on the *D-7s* hit her something awful. We couldn't contact her through the static and jamming, but we saw her finish her turn, firing every weapon that she had. Three *D-7s* cut back and pumped photons into the *Vidal*, reducing it to a pile of debris.

"That left only me against the four remaining ships, outgunned 15 to one. I executed a Gartherian Pivot, but just before we jumped out of the system, we took several hits. The computer was damaged, and the coolant in the warp drive was leaking all over engineering. Several of my decks were torn wide open."

### The Wormhole Effect

"I thought we were done for, and so I ordered my ship's log to be fired in the log buoy. The engines were superheating, and so I tried to diminish the energy buildup by engaging the warp engines at full speed. Unfortunately, or maybe fortunately, the engines went into imbalance, and we fell smack dab into a Wormhole—just as the Klingons were moving in for the kill. It wasn't a battle tactic at all, but it worked. We lost a number of men in the Wormhole, but it drained the engines enough for Engineering to cool the systems down. I have to tell you, it was the most terrifying ride of my life. The next thing I knew, we popped up in real space almost a parsec from the Stogar system, with no Klingons and no more Task Force. Just the *Strider* and what was left of my crew.

"Our condition was bad. We could only limp along at Warp One for a short amount of time. Estimating our damage to be too great to fight effectively, I ordered a course laid for Federation Outpost 1121 for emergency repairs. Just like I was supposed to do in war time.

"When we came insystem, I expected security forces to be orbiting the installation for protection. Naturally, no one was following wartime procedures. Then, Captain Curtis hailed me and asked what I was doing off my standard patrol. I informed him of the battle, and the next thing I knew, he had beamed over an entire security force to hold me and my men."

## Imprisoned

"They placed me under arrest for treason. I called up a copy of my ship's log to show Captain Curtis and Commodore Harmonson that I was merely following orders, but with all of the damage to the *Strider's* computer, only fragments of the log were comprehensible. The officers who actually heard the command are all dead.

"I am guilty—guilty of following orders like a good officer should. Yes, I hate the Klingons—they killed my brother in cold blood. But I would never let that hate take me and my command into unprovoked battle.

"My only defense is a copy of my ship's log, and it's so badly chopped up that it's no help at all. Someone is railroading me, but I hate to think it's my fellow officers and superiors. Curtis and I have never agreed on anything, but I don't think he'd go to such lengths to set me up. Though Commodore Harmonson has promised me a fair trial, Curtis is running around like it's some sort of witch hunt.

"Many good people are dead, and I want an answer much more than those who put me here. The only thing that's going to help me is a legible copy of the Code Red 1-A transmission sent to the *Strider*. Then, we could trace the command cypher on it and find out who sent the thing.

"I appreciate your concern, and I hope we can meet again once this whole thing is cleared up. If you find out anything, we can set up another meeting to go over it."

## Words of the Doomed

In her speech, Kristine Reardon mentioned that she had a copy of the *Strider's* log. As the player characters are prohibited from seeing the vessel's computer records, they should ask Kris for the computer cart containing her copy of the log, and she will give it to them. As time runs out, the security guard asks the *Lexington* crew to leave the cell.

A player who makes a Skill Roll against his character's rating in *Computer Operation* after examining the computer cart will be satisfied that it has not been tampered with. Thus, the copy is accurate, even though it is damaged. When the player characters insert the cart into a computer terminal, they see that most of the log visuals are marred and blurred. The verbal message is choppy due to the *Strider's* damage, and so it is weak evidence. The game-master may give the players a copy of the ship's log from the **Background Information** section. The log reads as follows:

"Message incom...orit...ask Force 13 execut...ar...the Klingon Empire. Star Fleet...must not...know...engage and destroy...silenced."

There is a pause, and the image shows Captain Reardon opening up ship-to-ship communications with the Task Force.

"...ordered to...Stogar System to attack and l...Federation's preservation. Al...I accept full responsibility for this...action. You will follow my orders...violations of...punish...of death...and."

At first glance, the messages seem rather incriminating. They are so damaged that no player character can piece together the original text. This copy and the prosecution's copy of the *Strider's* log are identical. (See the **Game-master's Notes** for the undamaged log entries.)

## CREW OF THE STRIDER

Several hours after the meeting with Captain Reardon, four members of the *Strider* crew introduce themselves to the players' group. They have heard that the player characters are looking into the case, and they want to divulge what they know.

Commander Stoan, the *Strider's* Vulcan Science Officer, is the group's spokesman. He tells the player characters that he was on the ship's bridge when the alleged message arrived. He did hear Captain Reardon repeat and confirm the message and give the *Clark* and *Vidal* their orders. However, he did not see the actual message or the ciphers, and so he cannot confirm whether or not it was real. With typical Vulcan certainty, he maintains that the Captain verbally acknowledged some sort of message and ordered the Task Force to enter Klingon Space.

K'tril is a Caitian Communications Officer from the *Strider*. Unlike Stoan, she was not on the bridge when the message arrived, but she did replace the officer who supposedly received the command. As the two crewmen exchanged their posts, that officer told K'tril that a Code Red 1-A message had come in from Star Fleet, and it was not a drill. Unfortunately, the officer was killed in the attack, and so K'tril's evidence is circumstantial.

Lieutenant Commander Jack Thompson was at the helm of the *Strider* when Captain Reardon received the command. Like Stoan, he heard Reardon confirm the message and give the other ships their new orders. Although he does support Stoan's testimony, he cannot prove that the message was authentic.

The final member of the group is Lieutenant Lori Desmonal. Attached to the *Strider* for two years, Lori was in Engineering during the whole affair. Though she offers no evidence to support her Captain, she knows Captain Reardon quite well. Like the rest of the group, the engineer is convinced that the Captain would not have led the Task Force into Klingon space without orders.

The *Strider* crewmembers have been temporarily reassigned on the Outpost until the ship is repaired. They are anxious to help the player characters in their investigation. Jack Thompson then asks the players' group what information they have concerning their Captain and her plight.

Before the *Strider* crewmembers leave for their various duty stations, they tell the *Lexington* officers that they will discuss the case in more detail soon. Jack Thompson says that he knows how to clear the Captain, but he has to look into the matter further.

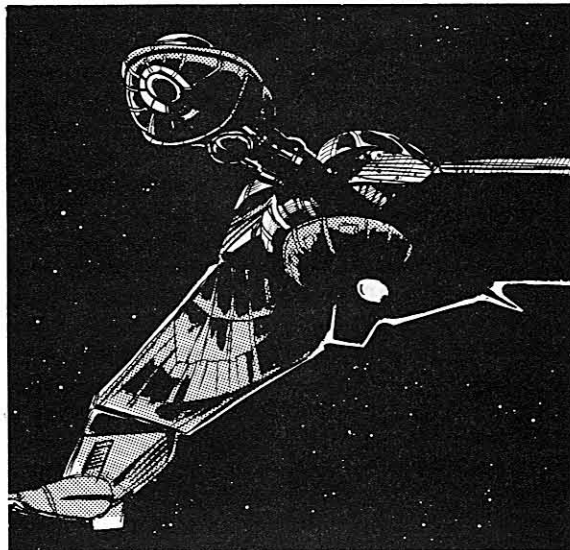

## DUTY CALLS

At this point, the player characters should contact Captain Franklin and inform him of their discoveries concerning the *Strider* incident. If they have a copy of the *Strider's* log or believe that someone has tampered with the backup Priority Commands, Franklin will insist that some of his officers maintain a watch on Captain Reardon to protect her. The players' group should also relate the discussion they had with the crew of the *Strider*.

If the player characters do not have a copy of the *Strider's* log or did not check the Outpost's communications systems, Captain Franklin steers them to these areas. Thus can the gamemaster get the players on the right track. The Captain also orders two of his officers to watch over Captain Reardon.

Captain Franklin then congratulates his crew on their progress. He suggests that they keep their eyes and ears open for any further information, as "something doesn't feel right".

### STATUS OF THE LEXINGTON

While the player characters are talking with their Captain, Commander Davidson, the engineer in charge of ship repair on the Outpost, arrives to inform Captain Franklin of the *Lexington's* condition. The ship's antimatter inducer will take at least two weeks to repair, as most of the Outpost's engineering staff are working on the *Strider*. Though the *Lexington* does have a higher priority (being one of Star Fleet's most powerful ships), the work on the *Strider* cannot be stopped in the middle. In a day or so, the engineers can begin work on the *Enterprise* Class ship.

### STATUS OF THE STRIDER

Commander Davidson then briefs the *Lexington* officers on his progress with the *Strider*. Engineers have sealed the ship's hull breaches, and it can now maintain atmosphere. The deflector shield system is still damaged, and the forward and starboard/forward shields will remain inoperative until the ship can be repaired at a fully functional star base.

Although the vessel's phaser system has been damaged, it can still function. Only the aft torpedo tube is operational. The computer system has been replaced, but the ship's sensors still need work.

As the engineers have repaired the warp engines' imbalance, they are functioning at 100 percent. Although the impulse engines took some damage, they are remarkably in perfect condition.

Commander Davidson says it is a miracle that the ship made it back from the fight at all. Also, he wonders what did the most damage: the Klingons or the Wormhole effect.

[GAMEMASTER'S NOTE: This encounter gives the players necessary information for subsequent events.]

## KLINGON ARROGANCE

A few hours after their meeting, Captain Franklin and his top officers are summoned to attend Commodore Harmonson at the Orbital's transporter room. As it is a command, the player characters must obey, dropping whatever they are doing.

When the player characters arrive at the transporter room, they see the Commodore, Captain Curtis, and three security men there. Commodore Harmonson informs them that a Klingon Diplomatic Corps shuttle has entered orbit around the Outpost and is preparing to beam over the Klingon ambassador and his party. The subject of the meeting is the Tasor star system.

The Transporter Chief beams aboard four Klingons: three security guards and the ambassador. Once confident that the room is safe, the ambassador, an Imperial Klingon, steps forward and introduces himself as Admiral Kai zantai-Mik, territorial governor and official ambassador for the Klingon Empire. Arrogant and pushy, he acts as if he knows something that the Federation party does not. The Commodore introduces himself, Curtis, Franklin, and the other officers present. Then, he will lead the group to the Officers' Lounge so that they can talk in private (Security has cleared the area).

Once there, Admiral Kai gets right to the point. The Klingon Empire is making an official appeal for control of the Tasor system. Before approaching the Organian Council, he offers Commodore Harmonson the opportunity to surrender the system without diplomatic debate and the "interference of the Organians".

The Commodore strongly protests and demands to know on what grounds the Klingons make their claim. Smiling, Kai tells the Federation officers that he was not the first ambassador sent to discuss the matter with the Federation. The Emperor told the Organians months ago that the ambassador was to be Kor zantai-Juriss, with Kai as backup in case of difficulties. While a Klingon squadron was escorting Kor's unarmed vessel to the Organian Neutral Zone, a Federation Task Force attacked. The only Klingon ship lost was the ship containing the ambassador.

Admiral Kai says that the Federation knew it was about to lose the Tasor system, and so it sent an attack group to kill the ambassador. Once the Organians learn of the Federation treachery, they will no doubt give the Klingons control of the system.

Shedding some of his dignity, Commodore Harmonson pounds the table in fury. He tells the Admiral that Task Force 13 had no designs against the Klingon ambassador, but the Admiral only smiles and says, "Do not waste your breath on me. Tell the Organians."

With that, the ambassador and his party request permission to beam back to their ship, as they do not wish to stay in the same port with the criminal that killed their honored *zantai*. Commodore Harmonson asks for a later meeting, and the Admiral agrees. Reluctantly, Harmonson grants the Klingons leave to return to their ship.

## REVENGE

That evening, Captain Reardon asks for a psychotri-corder test to determine the state of her memory concerning the *Strider* Incident. She hopes that this test will prove that she was merely following orders. Although she will not inform the player characters of her decision, if officers from the *Lexington* are keeping her under surveillance, they see two security men bring the Captain out of the brig. She has no restraints, and so she is free to move.

Have these player characters make a Skill Roll against their ratings in *Security Procedures*. If none of them have the skill, there is a 30 percent chance that they notice an officer walking toward the Captain and her two guards. The man has his hand thrust into his pocket and looks suspicious. If the player characters do not move against him in ten seconds, he draws a Phaser II and fires at Captain Reardon. One of her security men knocks the Captain aside and is promptly disintegrated. If the player characters watching the Captain do not defend her in some way, the attacker shoots Captain Reardon. There is a 90 percent chance that she is seriously wounded. If the player characters fire at him, he surrenders if he has seriously wounded the Captain. As long as she is still moving, he continues to fire at her until either he or she is hit.

The attacker is Lieutenant Darvin Harris, an officer assigned to the post. After the *Lexington* officers subdue him, he bitterly states that his twin brother Dale was aboard the *USS Clark* on its fateful trip. He overheard Captain Curtis in the Officers' Lounge saying that Captain Reardon led the attack with malice and forethought. That Reardon was responsible for the death of his brother was too much to bear, and so he hoped to make her pay for the crime.

Taking Captain Reardon to sickbay for treatment is more important than capturing Harris. She is shaking from the attack, and seems on the edge of a nervous breakdown. Once the player characters get Reardon to sickbay, the doctor on duty treats her wound and sedates her. When the Outpost Security Chief arrives, he asks the player characters what they were doing in the area. After hearing their story, he doubles security around Captain Reardon.

By this time, the Outpost grapevine will have alerted the other player characters to the incident. Captain Curtis, Commodore Harmonson, and Captain Franklin have also been notified, and they arrive in sickbay to see Captain Reardon. Curtis is furious at the security men for letting Darvin get so close to Reardon. Captain Franklin asks his officers what happened. Once everyone is assured that Captain Reardon will live, Captain Curtis asks the Commodore to advance the trial date to prevent any further bloodshed. Commodore Harmonson replies that all they can do is wait for Commodore Astak to arrive in a few weeks.

After four hours rest, Captain Reardon returns to her cell, escorted by four security men. Because of the attack, she will not undergo the psychotricorder tests.

## SUICIDE OR MURDER?

The player characters may either spend the night on the Outpost or on the *Lexington*. Whichever they decide, Lieutenant Art Davials contacts them once they do arrive. If player characters checked the communications systems earlier, they will remember Davials to be a bright and helpful officer. He has discovered that someone did send a Priority Command at the time Reardon claims, and agrees to a meeting that night in his room on the Outpost.

When the crew arrives at Davials's room, they find him dead on the floor. There is no sign of a struggle. Nearby is an empty bottle of pills, and on his bed is a scrawled suicide note, saying that he cannot deal with the pressure of his assignment. On the back of the note are a "B" and a "U" that do not match the handwriting on the front. A player who makes a Saving Roll against his LUC score spots Captain's bars in the corner of the room. If a player character makes a Skill Roll against his rating in *Security Procedures* while scanning the room with a tricorder, he discovers a bugging device hidden in the room. Examining the bug reveals that it is neither transmitting nor receiving.

[GAMEMASTER'S NOTE: Davials was killed, and it was made to look like a suicide. The letters "BU" on the back of the note stand for "backup". While studying the backup copy of the Priority Commands, Davials discovered that someone had accessed the disc. Running the command cipher, he found out who the sender was. For that knowledge, he was killed. Although the drug in Davials's system killed him before he could call for help, he did manage to scrawl a clue on the back of the note.]

Once Captain Curtis learns of Davials's death, he calls Captain Franklin and the investigating officers into his office and demands to know what they were doing in the room. He warns Captain Franklin that, as a court martial judge, Franklin cannot explore the *Strider* Incident. Refusing to take any flack from the post commander, Captain Franklin reminds Curtis that he has every right to have his officers look into the matter. As a parting shot, Curtis asks Franklin to keep his crew out of the way of base personnel.

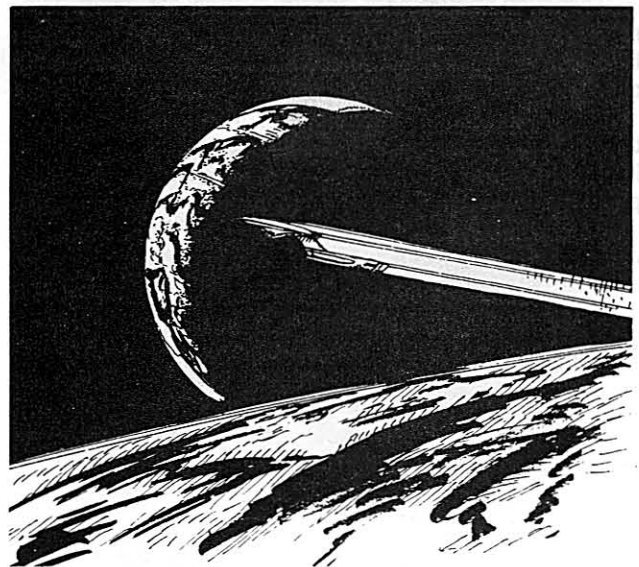

## A BOLD PLAN

The next morning, the crew of the *Strider* contacts the investigating officers to arrange a meeting with Captain Franklin. To ensure security, Captain Franklin insists that the meeting take place in his quarters on the *Lexington*.

Once the characters have assembled in the Captain's quarters, Jack Thompson asks that what they are about to discuss be off the record. Captain Franklin agrees to this and warns his officers to keep the matter secret.

Thompson says that Captain Reardon will be found guilty because there is no hard evidence to clear her. Captain Curtis is going out of his way to frame Captain Reardon, and her chance for a fair trial is growing weaker by the hour. Thus, they have devised a plan to get the evidence that will acquit Captain Reardon.

The copy of the *Strider's* log is impossible to read. However, as the original log was made before the computers were damaged, it will not have the same gaps as the copy. Thompson proposes taking the *Lexington* to the Stogar system to recover the *Strider's* log buoy. The other *Strider* crewmembers concur that it is the only real hope that Captain Reardon has. When Captain Franklin asks them what they intend to do if he will not aid them, they announce that they will go anyway. Their loyalty to their Captain more than makes up for the risks involved.

### CONVINCING THE CAPTAIN

Captain Franklin will remain unconvinced of the necessity to retrieve the log buoy unless presented with the following evidence.

1. Testimony from a player character with *Computer Operation* skill that the backup copy of the Priority Commands has been tampered with.

2. Something out of the ordinary with Davials's death. This can be either the bugging device, the reference to the "BU", or the Captain's bars discovered in the room.

3. The copy of the *Strider's* log tape that Captain Reardon gave to the player characters.

If presented with the three pieces of evidence above, Franklin will agree to their plan. If the player characters do not have all the evidence, the Captain will forbid his crew to participate in the plan until presented with the above.

When convinced, Captain Franklin will insist on accompanying the group to the Stogar system. If one of the player characters thinks that the idea is too far-fetched, Franklin asks if they have enough evidence to give the Captain a fair hearing. If the answer is anything short of a "yes", he will agree with the *Strider* crew's plan. The Captain is trusting not only his instincts, but also those of his officers. He is risking a very successful career with Star Fleet.

### HASHING OUT THE DETAILS

The only ship available for the journey is the *Strider*, as the *Lexington* is unable to travel for two weeks and the Klingon's ship is definitely out. Although the *Strider* is not in the best working condition, it can function, and many of the ship's problems have been fixed since her return.

Thompson's plan is for half of their group to sneak aboard the ship at 2000 hours tonight (after the engineers leave) to get her ready for the voyage. K'tril will go to her Communications post on the ground facility so that she can jam any signal from the Outpost to stop the *Strider* or intercept it. To prevent Curtis from ordering the ground facility to fire on the ship, she will stop any communications from reaching the planet. The rest of the group will rescue Captain Reardon from the security area and bring her to the *Strider*. (The *Strider* crewmembers insist that she come along so that they can protect her from further vengeance.) The vessel will leave the Outpost at precisely 0400 hours.

If the player characters suggest an alternative plan, the others will go along with it. However, they should make Reardon's rescue the last act before departure so that base security will not be able to foil their plan. If the rescue group desires, they may help repair the *Strider* and then free the Captain near launch time. This way, more people can work on the scout ship's repair.

If none of the player characters mention it, Captain Franklin remarks that, although the *Strider* needs only seconds to take her out of the range of the Outpost's tractor beam, the weapons are another matter. Lori Desmonal says she is a member of the Outpost's engineering crew, and so the computer room's palmprint analyzer will allow her into the computer room on Level 5. Once there, she can sabotage the fire directional control computer. [GAMEMASTER'S NOTE: If a player character wishes, he may accompany Lori. Roleplay the situation and refer to the Outpost deckplans to set the stage. As there are Klingons about, there is bound to be at least one security man guarding the computers.]

The ship will go to the Stogar system, find the buoy, and return. Although they will cross Klingon space, Star Fleet might overlook this if they retrieve a complete copy of the message. Not only will the message clear Captain Reardon, but it will also contain the command cipher identifying who actually sent Task Force 13 to their destruction. As the meeting ends, Captain Franklin says that he hopes the Organians will overlook this intrusion into the Neutral Zone.

### THE THIRD DEGREE

A half hour before the players' group is supposed to board the *Strider*, an intercom declares that some of the player characters must report to Captain Curtis in his office. Each *Lexington* officer player has a 30 percent chance of being called in; neither Captain Franklin nor any of the former *Strider* crew have been summoned. This summons will make the rescue and escape a little bit more difficult.

Captain Curtis is still building up his case against Reardon and wishes to learn what the player characters have uncovered. He questions their motives in the case, what they were doing in Lieutenant Davials's room at the time of his death, what they know about the attack on Captain Reardon, as well as their use of the communications computer. He will grill them for hours, asking them to write out full statements on what they might know about the case, and will generally waste their time. As the *Strider* crewmembers are repairing their ship while all this is going on, the player characters will be anxious to end the session with Curtis. However, Captain Curtis will hold a conference with them until 0350 hours or so, still hoping that they may confess something.

Captain Curtis feels that he is doing his job to the best of his ability. Commodore Harmonson told him to cover every avenue and said that he was proud of the hard work the Captain had put into the case. This inflated Curtis's ego and made him determined to put Captain Reardon behind bars once and for all. According to Commodore Harmonson, such a feat might earn him a promotion or a position on a starship. Such talk only whetted Curtis's appetite.

### JURY-RIGGING REPAIRS

The characters can sneak aboard the *Strider* through the mooring boom attached to Deck 15 of the Outpost. They find the ship deserted, open, and unsecured, as all personal effects have been removed.

The engineering section is mostly repaired, and the players' group need only fine-tune the systems to make them fully operational. Because this requires work on the console, the player characters will not discover the person sleeping in the Jefferies Tube. Although the engineering console requires only an hour of work, the bridge needs a minimum of three hours work per station. If the player characters check, they will find that the auxiliary control room is in even worse shape.

Except for the engineering station, all the bridge consoles have been disconnected for repairs. To repair a console, a character must work on it for three hours and make a successful skill roll. For each failed roll, he must spend an additional hour working. Below are the skills to be rolled against to repair each console. Where a skill rating average is called for, a character may average his skill rating in one skill with another character's skill rating in the other skill. Although both characters must work on the station, one of them can make the roll after only one-and-a-half hours of work.

#### Helm

Roll against the average of *Starship Helm Operation* and *Computer Technology*. The ship cannot move or fight without this console.

#### Navigation

Roll against the average of *Astrogation*, *Deflector Shield Technology*, and *Computer Technology*. Without the console, the group can neither plot a course nor safely use the warp drive, as the ship may collide with an object in space.

#### Science

Roll against the average of *Starship Sensors* and *Computer Technology*. Without this console, internal and external scanning is impossible.

#### Communications

Roll against *Communication Systems Technology*. If this system is left unrepaired, the group will not be able to transmit messages, but the system can receive messages.

The player characters may determine which system they will work on first. Naturally, they will be in deep trouble if they only work on the communications and science stations, as the ship would still not be able to leave the dock. The *Strider* crewmembers can suggest first repairing the more important systems: helm and navigation. Of course, they may repair systems once the *Strider* is underway.

### THE BREAKOUT

The player characters are free to devise their own plan to get Captain Reardon out of the brig. However, their attempt will probably involve some sort of fighting with the Security Officers on duty there. Since the attack on Captain Reardon, Curtis has ordered four men to guard her at all times. Armed with Phaser II-As set on heavy stun, these men are in the security control area next to the cell containing Captain Reardon. (Refer to the brig on Level 15 of the Outpost.)

If the players' group attacks the security control room, there is a 75 percent chance that a guard hits the alarm, summoning two other guards to the area within three minutes. If they do not sound the alarm, they will attempt to deal with the situation on their own.

Once the players' group subdues the guards, they have to bring Captain Reardon to the *Strider*. Unknown to them, however, she is heavily sedated with a drug called Axiltril II. To help recover from the attack, Curtis ordered the Base Chief Medical Officer to sedate her, but he never lifted the order, despite complaints from the doctor. The drug weakens a person's motivation and motor ability, rendering him unable to make decisions or to move without help. Because Kristine Reardon has been drugged for some time, she is very groggy. At least one person must support Reardon to get her moving toward the ship.

Reardon's condition requires the players' group to move slowly in the hallways of the station, and the game-master may throw in several encounters with personnel along the way. Nothing should threaten the mission, but these encounters can add to the thrill of the escape. Moving through the Outpost at 0330 hours with a prisoner that appears to be drunk can be tricky and will test the players' ability to think on their feet.



## THE GETAWAY

Once the *Strider's* helm and navigation consoles are hooked up, the ship is ready to clear the docks. K'tril is at the groundside base's communications office, though there is no way for the player characters to confirm this. Lori will have returned after sabotaging the Outpost's fire directional control computer. A Medical Officer should treat Kris Reardon with stimulants to keep her awake.

Taking the *Strider* out of the orbital post will be tricky. On the other side of the Outpost is the *Lexington*, unable to move at warp speed but fully capable of moving on her impulse engines. Her weapons systems make her a potential threat.

The gamemaster should make the getaway as tense and exciting as possible.

As the *Strider* clears its moorings, an alert sounds in the base. Captain Curtis is called to the Orbital's command center, and both he and Commodore Harmonson arrive there seconds after the page. On the groundside base, K'tril jams the Outpost's subspace communications, so that Curtis can neither order the groundside base to fire on the *Strider* nor call in other Star Fleet ships to stop the *Strider*. As the *Strider* is close to the Outpost, however, the player characters can receive Curtis's transmissions.

Captain Curtis contacts the *Strider* and orders her to stop or be fired upon. Also, he demands to know who is at the helm of the vessel. After learning the culprits' identities, Commodore Harmonson tries to convince them that they are making a grave mistake and threatens them all with court-martials. He then contacts the *Lexington* and orders it to capture the *Strider*.

## VOYAGE OF THE STRIDER

The *Strider's* journey to the Stogar system will take 86 hours at the scout's maximum cruising speed (Warp 8). It takes nearly ten hours before Captain Reardon can fully function again, assuming a Medical Officer is administering stimulants. If no medical personnel treats her, she takes an extra three hours to come around.

### HOPPLEMEYER

Lieutenant Ralph Hopplemeyer is one of the engineers who was repairing the *Strider*. Ever since Hopplemeyer accidentally spilled hot coffee on Captain Curtis, Curtis has made life rough for the engineer, holding him back from several promotions and refusing his requests for transfer. Though smart, he is also a bit absent-minded. After finishing his work on the *Strider*, he fell asleep in the starboard Jefferies Tube.

Thirty minutes after the *Strider's* warp drive is engaged, Hopplemeyer wakes up. From the hum of the engines, he can tell that the ship is moving. He climbs out of the Tube, looking for someone to answer his questions, such as who is running the ship and where it is going. If anyone from the players' group is in the engineering section, there is only a 15 percent chance that Hopplemeyer will see him, as he has very poor eyesight (even though he wears glasses). Anyone in engineering has a 25 percent chance of spotting Hopplemeyer as he makes his way to the turboelevator. The Lieutenant is on his way to the bridge to find out what is going on. His arrival should deliver quite a shock to the players.

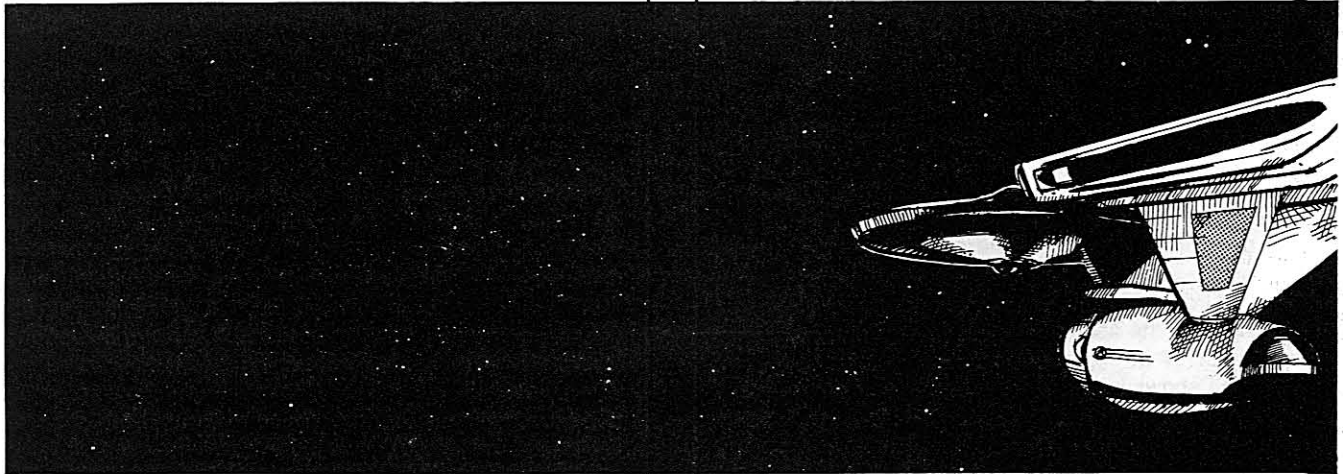

If the *Strider's* communications station has been repaired, Captain Franklin orders his vessel to remain at station. The *Lexington* acknowledges his message and stays put, out of loyalty to the Captain. If the communications station is not functional, the *Lexington* clears her moorings and follows the *Strider*, warning it to give up or be fired upon.

The *Strider* can move at warp speed, which the *Lexington* cannot do at this time. Should the *Lexington* follow the scout, the *Strider* need only leap into warp speed to leave the other ship behind. If the scout does not enter warp speed within ten minutes, the *Lexington* fires its phasers across the bow of the smaller ship. Subsequent shots will home in on the *Strider*. Once they go to warp speed, however, the player characters will leave Defense Outpost 1121 behind, setting their sights on the Stogar system.

If the player characters tell Hopplemeyer the truth about their mission, he will assist them only because it will bother Captain Curtis.

### AN INTERCEPTED MESSAGE

After the *Strider* has travelled for ten hours, the *Strider's* Communications Officer detects a faint narrow beam transmission. If the communications system has not been repaired, the ship's sensors can detect the transmission, but the player characters will not be able to intercept it. If neither system is functioning, the transmission passes the *Strider* undetected. The direction of the beam shows that it traveled along the flight path of the *Strider* and is heading for the Klingon Empire. A functioning communications computer allows the player characters to record the message so that they can decode it.



If the player characters run the message through the ship's computer, the computer will take six hours to deliver the millions of possible translations. However, as the computer does not know this code, all the translations will be gibberish. Someone has to make three Skill Rolls against his average rating in *Communications Systems Operation* and *Language, Klingonaase* to break the code, making one roll per hour. When the three rolls are successfully completed, the player characters receive the following pieces of the message. The rest is impossible to translate.

Federation...battlescout *Strider*...possibly Triangle area...  
must stop...kill those on board...Mik.

Thirty minutes after the scout detects the message, the player characters enter the Organian Neutral Zone. If the players' group has not repaired the ship's sensors, the gamemaster should ignore the following encounter.

Just inside the neutral zone, the ship's sensors discover a small satellite. The computer reports that the satellite is a communications booster, and that its power levels are increasing. However, as soon as the *Strider* scans it, it explodes. A character who makes a Skill Roll against his rating in *Communication Systems Technology* may determine that such satellites remain on minimal power until they receive a transmission. At that point, it generates more and more power to boost the message to its intended destination. Thus, because the satellite's power levels were increasing, the satellite must have been preparing to transmit its message when it self-destructed.

[GAMEMASTER'S NOTE: The message that the satellite was boosting is the one that the player characters intercepted. Any scan of the satellite triggers the self-destruct mechanism. As the remains of the satellite would interest Federation scientists, the player characters should bring the pieces aboard.

### ARRIVING IN STOGAR

Seventy-six hours later, the *Strider* reaches the Stogar system within the Klingon Empire. A dense asteroid ring surrounds the system, making scanning difficult. However, the ship detects two signals in the system. One is a faint power source within the asteroids and the other is a short, distinct signal from a Federation log buoy.

The signal in the asteroids is nearer. If the player characters approach that signal, they see an unusual asteroid. A closer scan shows it to be the charred and ripped dish of the *USS Vidal*, one of the ships in Task Force 13. Through the rips, the players' group can see the gutted insides of the ship, which is giving off too much radiation for anyone to venture inside. The power source is probably a small personal object that is still functioning.

The signal from the log buoy is deeper in the system. As the *Strider* scans the area, however, it detects only the signal, which appears to be coming from empty space. The ship will close to several thousand meters before the reason becomes apparent.

## AN UNEXPECTED BIRD OF PREY

The *IKV Bloodsteel*, A Klingon K-22 Class scout, beat the *Strider* to the log buoy. Equipped with a cloaking device, the K-22 is lying in wait for the Federation ship, using the buoy as bait.

### KLINGON POWER PLAY

The Captain of the *IKV Bloodsteel*, Captain Tasin sutai-Pallara of Imperial Security, is investigating one of the Imperial governors, an Admiral Kai zantai-Mik, to confirm that he is working in the best interests of the Klingon Empire. However, Captain Tasin has other motivations. A nephew of Admiral Kai, Captain Menjin sutai-Mik, is quickly rising to power in the Imperial Court. This young upstart is threatening the Pallaras' control of Imperial Security. Therefore, Captain Tasin leaped at the opportunity to investigate one of Menjin's famous relatives.

Captain Tasin has already learned one piece of valuable information: the Federation task force did not kill the Klingon ambassador to the Tasor. Rather, Admiral Kai destroyed the ambassador's ship so that he could assume the ambassador's duties. Though he has no proof, Captain Tasin thinks that Admiral Kai used a spy in the Federation to lure the task force into Klingon space.

Tasin has already fabricated a story concerning Admiral Kai. His report states that the Admiral is attempting to goad the Federation into a war with the Klingon Empire. As evidence, Tasin plans to use his findings about the death of the ambassador and has falsified certain documents. He also intends to implicate Menjin sutai-Mik in the conspiracy, thus removing both men from *komerex zha*. While he was waiting for the Admiral's return so that he could arrest him, Captain Tasin discovered and captured the Federation log buoy. When his sensors picked up the *Strider*, he engaged his cloaking device and reactivated the buoy's signal. Thus, will he lure the *Strider* close enough for the *Bloodsteel* to attack her, or even better, to capture her and her crew.

### STANDOFF

As the *Strider* comes within several thousand meters, the Klingon scout decloaks, arming its weapons and raising its shields. Before the Federation Captains can do anything, Captain Tasin transmits a message in Galacta for the ship to surrender or die. Both ships are within close range and facing each other. (The gamemaster should set up a Star-ship Mapsheet and place the two ships three hexes apart.)

In its present condition, the *Strider* is no match for the *Bird of Prey*. However, the Klingon does not know that. Therefore, at this time, the player characters should try a bluff. They may arm their weapons, raise their shields, and ask for the surrender of the Klingon ship, causing a total standoff.

On the *Strider*, the two Captains ask their officers for the best course of action. Captain Franklin would prefer to discuss their situation with the Klingons. Captain Reardon agrees, but suggests that the *Strider* should take any opportunity to cripple the enemy ship, even if it means losing the precious log buoy. Jack Thompson is all for a direct attack.

Discussing the issue with the Klingons is the best alternative. However, if the player characters decide to attack the *K-22*, use the **STAR TREK Starship Tactical Combat Simulator** rules to resolve combat. The *Bird of Prey* should be able to beat the *Strider*, as the Klingon ship can cloak and the players' group cannot fight and effect repairs. The gamemaster may keep the match even by having one of the *Strider's* shots severely damage the *Bloodsteel*. He should constantly nudge the players into negotiating with the Klingons.

### THE DIPLOMATIC TABLE

Captain Tasin demands to hold any discussions on the *Strider*. Once the player characters agree to this, they may consult the *Strider's* deckplans (in the **Vessels** chapter) to decide where they wish to station themselves for the Klingon's arrival.

The Klingon Captain first sends over a landing party of four heavily armed officers to make sure that the area is safe. Once they signal to the *Bloodsteel* that they have arrived, the Captain beams over, also carrying several weapons. After the *Strider* group introduces themselves, he remarks that they are the finest group of prisoners he has ever taken.

The Federation Captains invite the player characters to sit in on the conference to discuss the *Strider's* fate, while the rest of the group remains on the bridge. When seated in the Officers' Lounge, Captain Franklin tells the Klingons that the ship came only to get the log buoy. Captain Reardon breaks in with her story of how the *Strider* was tricked into coming into the Stogar system earlier. Reardon's escape from the Klingon ships impresses Captain Tasin, as does the cleverness of Admiral Kai's plan.

Captain Tasin then asks the assembled group if they know the whereabouts of Admiral Kai. As stated earlier, Tasin hopes to take his victim dead or alive. Captain Franklin tells him that the ambassador is at a Federation Outpost discussing the Tasor system.

Captain Tasin then tells the group that they are to consider themselves prisoners of the Klingon Empire and that any action against him or his ship will constitute an act of war. He informs the Federation Captains that he is returning to the *Bloodsteel* to confirm what they have told him. He will communicate with them shortly to report their fate.

Jack Thompson again suggests that they destroy the *Bloodsteel*, but both Captains will remind him and anyone who agrees with him that the *Strider* is on a mission of peace and that they are no longer in the safe, secure Federation.

While Tasin was aboard the *Strider*, one of his security men planted a listening device on Captain Reardon's shoe. The small device allows him to listen to the conversation aboard the Federation ship so that he can make sure they told him the truth. If, as Jack Thompson suggests, the player characters decide to attack the *Bloodsteel*, Captain Tasin will attack the *Strider* first. However, once he is assured that the *Strider* is not a threat, Tasin contacts the player characters, telling them to stand by in their transporter room.

### THE EVIDENCE

As the group waits in the transporter room, the log buoy materializes there. Tasin informs the Federation crew that he has confirmed their story and will escort them to the Neutral Zone. While they start their long voyage back to Federation space, the *Strider* crew can begin work on the log tape. Behind them, only a few thousand meters away, is the *IKV Bloodsteel*, making sure that the Federation ship does not alter its course out of the Klingon Empire. At the Neutral Zone, the *Bloodsteel* pivots, cloaks, and disappears into the Empire.

[GAMEMASTER'S NOTE: Captain Tasin let them go because he has higher aspirations: the capture of Admiral Kai, his spy, and the ruin of the Mik line. The *Bloodsteel* will follow the Federation ship to the Outpost fully cloaked. Even if the *Strider's* sensors are repaired, they have only a 5 percent chance of detecting the *Bird of Prey*, and then, only if they are concentrated aft.]

Running the log tapes shows that the *Strider* did receive a Code Red 1-A message and that Captain Kristine Reardon did follow her orders exactly. Both messages are intact, and everyone present can review them. Refer to **Gamemaster's Notes** for the log entry.

To determine who sent the message, a player should make a Skill Roll against his character's rating in *Communication Systems Operation*. If the roll fails, he comes up with the command cipher for Captain Curtis. If the roll succeeds, he discovers that the command cipher for Curtis was faked. Another successful *Communication Systems Operation* roll tells him that it was Commodore Harmonson who faked Curtis's cipher and sent the message. Alternatively, by feeding the message into the ship's computer, the player characters can verify that the cipher was faked. The computer can also determine that the real culprit is the Commodore.

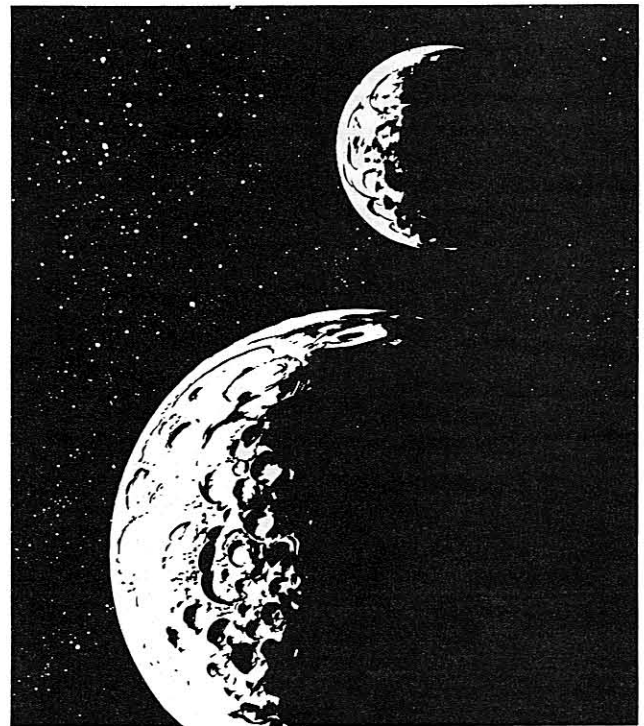

## HOMECOMING

As the *Strider* approaches Defense Outpost 1121, Captain Curtis hails the ship. He orders them to surrender, and arrests those on board. He sounds furious, and his anger intensifies when the group tells him that the *Strider* entered Klingon space.

The characters aboard the *Strider* have nothing to lose by surrendering. If they think that Curtis sent the Priority Command, they should ask to surrender to Harmonson, and the gamemaster should proceed to **Accusations**. However, he should immediately proceed to **Unmasking the Spy** if the player characters determined that the Com-modore is the villain.

### ACCUSATIONS

If the player characters inform the Outpost that they have retrieved the log buoy and that it proves Captain Curtis sent the Code Red 1-A transmission, Commodore Harmonson arrests him. The Commodore is more than happy to let Curtis take the rap for his murders and tamperings.

At this point, the *IKV Bloodsteel* uncloaks next to the *Strider* with its weapons and shields unpowered. Captain Tasin hails the outpost, proclaiming himself the new ambassador for the Tasor system and demanding custody of Admiral Kai and his spy. Shocked at this intrusion, Commodore Harmonson orders the *Lexington* to engage the *Bird of Prey*. The Commodore realizes that Captain Tasin has the goods on Admiral Kai, and that destroying the *Bloodsteel* will extinguish Tasin's evidence. Proclaiming that this interference in Empire matters will be avenged, Tasin cloaks his ship and departs the Korial system. After he leaves, Admiral Kai takes off to the Triangle, knowing that he has no future in the *komerex*.

Two weeks later, Commodore Astak arrives from Star Base 27, and the court-martial convenes. (If he wishes, the gamemaster can roleplay this trial, calling the *Strider* and *Lexington* crewmembers as witnesses.) Captain Reardon is cleared, but the evidence against Curtis is strong, and he is found guilty and delivered to the Klingon Empire. At this point, the adventure is over. Refer to the **Judging Action** section of **Gamemaster's Notes** to resolve the outcome.



### UNMASKING THE SPY

If the player characters discovered that Commodore Harmonson ordered the Task Force to its doom, they should tell Captain Curtis to arrest the Commodore as quickly as possible. Although the *Strider* group does not know it, the Commodore is standing next to Captain Curtis and is not about to end his career as a Klingon agent. Realizing that the *Strider* group must have found the ship's original log and discovered who sent the Priority Command, he executes his contingency plan.

The Commodore secretly loads a computer cart into the sensor console, and it registers that the *Strider* is arming its torpedoes. Suddenly, the base goes to red alert, and the Commodore orders Curtis to fire on the *Strider*. (By this time, the Outpost's fire directional control computer has been repaired.) Curtis does not arrest the Commodore, thinking that Reardon and Franklin are trying to trick him.

Curtis orders the *Lexington* into action against the *Strider*, telling the ship to block the scout's escape. Moving under impulse power, the mighty *Lady Lex* clears the Outpost and moves toward the *Strider*. Then, before any shots are fired, the *IKV Bloodsteel* turns off its cloaking device and moves in between the *Lexington* and the *Strider*.

Captain Tasin of the *Bloodsteel* calls for a truce. According to the Outpost's and the *Lexington's* scanners, the *Bird of Prey* has not armed its weapons. Commodore Harmonson uses this diversion to sneak out of the base command center and to make his way toward the transporter room, where he beams aboard Admiral Kai's warpshuttle.

When Harmonson arrives on Kai's ship, explaining that his cover is blown, the Admiral knows that he is in trouble. Captain Tasin orders the Admiral's warpshuttle to surrender. However, the Admiral's crew is loyal to Kai, and, as it does not have enough firepower to dent the *Bird of Prey*, the warpshuttle quickly departs.

Although Captain Tasin detects the shuttle leaving the area, he does not follow immediately. He does not trust the *Lexington*, and he wants to bring Kai's spy back to the Federation (not knowing Harmonson is on the Klingon ship). However, he does plot the shuttle's course-heading for future pursuit.

Instead, Tasin contacts Captain Curtis and informs him that he is the new Klingon ambassador for the Tasor Major system. He tells Curtis that Admiral Kai is a renegade from the Empire, briefs him on the Admiral's activities, and ends his speech by demanding custody of Kai's spy. Noting the Commodore's absence and learning that someone beamed aboard the Klingon warpshuttle, Curtis finally realizes that Harmonson is a spy, and informs the Klingon that the spy escaped aboard the shuttle. Tasin curses, and then warps out after the Admiral.

Although Commodore Harmonson escaped capture, Captain Reardon did manage to recover the evidence that will clear her. When Commodore Astak arrives in a couple weeks for the trial, even Captain Curtis admits that Reardon was just following her orders. The case is dropped, and the Captain's record and career are saved. Refer to the **Judging Action** section of **Gamemaster's Notes** to resolve the adventure outcome.

The last thing anyone will hear concerning Commodore Harmonson is that a Klingon warpshuttle was sighted heading for the Triangle...a perfect place for a man to hide.

# BACKGROUND INFORMATION

## TASOR

### World Log: TASOR

#### System Data

System Name:	Tasor Major
Map Coordinates:	8.52S 0.35E
Number Of Class M Present:	1

#### Planetary Data

Position In System:	1
Number Of Satellites:	2
Planetary Gravity:	.9G
Planetary Size	
Diameter:	16,599 km
Equatorial Circumference:	52,147 km
Total Surface Area:	865,592,950 sq km
Percent Land Mass:	10%
Total Land Area:	86,559,295 sq km

#### Planetary Conditions

Length Of Day:	25 hours
Atmospheric Density:	Terrestrial
General Climate:	Temperate

#### Mineral Content

Normal Metals:	35%
Radioactives:	23%
Gemstones:	1%
Industrial Crystals:	1.8%
Special Minerals:	18%

#### Cultural Data

Dominant Life Form:	Tasorian
Type:	Sentient Humanoid
Size:	Average

#### Technological/

Sociopolitical Index:	424332-53
Planetary Trade Profile:	BBAFBEG/C (E)



### HISTORY

Prior to the Four Years War, the Klingons began to build a major ship construction facility on Tasor. The Tasorians were unaware that Klingons were even on their world, however, because the staff of the Tasor post was so small. During the war, a small force of Federation marines landed on Tasor and defeated the Klingon forces there. Worried about the violence that these two governments could wreak, the Tasorians declined offers to join the United Federation of Planets, and Tasor remained an independent world within Federation space.

During the Organian Conflict, the *komerex* deployed vessels in the Tasor Major system to prevent a Federation advance. When a Federation battlefleet entered the system, the resulting combat left both forces rather depleted. The Federation force retreated, and the Klingon vessels departed to Mastocal for repairs. Shortly thereafter, the Organians stepped in and halted the war. In accordance with the Organian Peace Treaty, the Tasor Major system fell within the Neutral Zone between the two powers, though positioned closer to the Federation border. Tasor's governing body, the Planetary Council, realized that if a war were to erupt between the two starfaring powers, Tasor would again be drawn into the fight. In such a war, they might not be lucky enough to escape intact. Thus, they opened negotiations with both superpowers to determine which government offered them the most protection.

### CURRENT STATUS

Although Tasor has a small population, it does have a great deal of raw materials. The humanoid Tasorians tend to live much longer than Humans, averaging about 200 years. Their industrial technology resembles that of late 20th-century Terra.

Tasor is a prime location for a military base or a space dock facility. Under the terms of the Organian Treaty, both the UFP and the Klingon Empire get a chance to prove that it can best serve the planet's needs. Thus, both governments have begun large projects to convince the Tasorians to join them.

#### The Federation Project

At first, the Federation's project on Tasor went well. To stimulate population growth, Federation scientists presented the Tasorians with a chemical stimulant that allowed a larger percent of their offspring to reach maturity. In addition, UFP diplomats began a large agricultural project. Due to inadequate funds, the project did not yield a large harvest. Although the Federation Council had been little concerned with the fate of Tasor, it has recently realized that if the Klingons gain control of the system, the Federation line of defense would have to be reorganized, which would cost billions of credits.

#### The Klingon Project

After their failure on Sherman's Planet, the Klingons were determined to succeed with their Tasor Project. Control of this planet would allow them to station troops and ships one parsec from the Federation border. Ignoring the Tasorians' genetic problems, they concentrated on improving their agriculture. The Klingon Diplomatic Corps introduced over three dozen new crops, all of which have adapted well to Tasor's climate. As the Klingon crops are doing well, the people of Tasor are leaning toward joining the Klingon Empire.

## CAPTAIN REARDON'S LOG

Because of the *Strider's* battle damage, Captain Reardon's log is barely intelligible. The verbal part of the message is choppy, and the visuals are blurred. At several points during Reardon's message to the Task Force, there are semi-clear images of Captain Reardon in her command seat and of the bridge crew going about their tasks. The log reads as follows:

"Message incom...orit...ask Force 13 execut...ar...the Klingon Empire. Star Fleet...must not...know...engage and destroy...silenced."

There is a pause, and the image shows Captain Reardon sending a message to the other ships in the Task Force.

"...ordered to...Stogor System to attack and I...Federation's preservation. Al...I accept full responsibility for this...action. You will follow my orders...violations of...punish...of death ...and..."

## PERSONNEL RECORDS

The players can study these character sheets if any of them can make a Skill Roll against his character's rating in *Computer Operation* while accessing the main computer on either the *Lexington*, the *Strider*, or the Outpost. As the player characters do not have high enough security clearance to view these records, they should access the computer secretly. To view a personnel record, the player must tell the gamemaster the name of that individual. He must make a separate roll for each NPC record. The players may try to access a certain record as often as they wish.



## STAR FLEET COMMAND PERSONNEL RECORD

**Name:** HARMONSON, Bram Turlough

**Rank:** Commodore

**Current Assignment:** Federation Defense Outpost 1121,  
Special Assignment

**Position:** Acting Spokesperson, Star Fleet Command

**Race:** Human

**Age:** 52

**Sex:** Male

**Birthplace:** Zannaduu IV

**Service Record:**

Cadet Cruise, Military Operations Command,  
*USS Slashstar*, 1 year.

Military Operations Command, *USS Minotaur*,  
5 years.

Military Operations Command, *USS Stalker*, 6 years.

Star Fleet Intelligence Command, Classified,  
18 years.

**Awards/Commendations:**

Medal of Valor

Silver Star of Heroism

Hiveson Award of Intelligence Gathering

**Reprimands:** None

**Comments:** None

## STAR FLEET PERSONNEL RECORD

**Name:** CURTIS, Carl Arthur

**Rank:** Captain

**Current Assignment:** Defense Outpost 1121

**Position:** Commanding Officer

**Race:** Human

**Age:** 49

**Sex:** Male

**Birthplace:** Ireland, Terra

**Service Record:**

Cadet Cruise, Merchant Marine Command, 1 year.

Star Base 10, 6 years.

Galaxy Exploration Command, *USS Maxrix*, 2 years.

Star Base 11, 5 years.

Star Base 12, 7 years.

Galaxy Exploration Command, *USS Windfall*, 1 year.

Defense Outpost 1121, 5 years.

**Awards/Commendations:** None

**Reprimands:**

Disorderly conduct and conduct unbecoming an officer, Stardate 1/9303.12. Temporary grade reduction and loss of rank.

**Comments:** None

**STAR FLEET PERSONNEL RECORD**

**Name:** REARDON, Kristine Dorothy  
**Rank:** Captain  
**Current Assignment:** Military Operations Command,  
*USS Strider*, NCC 7141  
**Position:** Commanding Officer

**Race:** Human  
**Age:** 47  
**Sex:** Female

**Birthplace:** New York, United States of America, Terra.

**Service Record:**  
Cadet Cruise, Galaxy Exploration Command,  
*USS Potemkin*, 1 year.  
Military Operations Command, *USS Walter*, 4 years.  
Star Base 12, 2 years.  
Military Operations Command, *USS Kingston*,  
5 years.  
Merchant Marine Command, 8 years.  
Military Operations Command, *USS Strider*, 5 years.

**Awards/Commendations:**  
Grankite Order of Tactics  
Commendation of Bravery Under Extreme  
Circumstances

**Reprimands:**  
Conduct unbecoming an officer, insubordination.  
Filing Officer Captain Carl Curtis, Stardate 2/1501.11. All  
charges dismissed due to lack of evidence.

**Comments:**  
Offered an opportunity to command *USS Lexington* or  
*USS Yamato*, but turned down offer to remain working  
along Klingon border.

**STAR FLEET PERSONNEL RECORD**

**Name:** STOAN  
**Rank:** Commander  
**Current Assignment:** Military Operations Command,  
*USS Strider*, NCC 7141  
**Position:** Science Officer

**Race:** Vulcan  
**Age:** 46  
**Sex:** Male

**Birthplace:** Shil, Vulcan

**Service Record:**  
Cadet Cruise, Colonial Operations Command, 1 year.  
Colonial Operations Command, *USS Randolph*,  
3 years.  
Star Base 12, 5 years.  
Merchant Marines Command, 2 years.  
Military Operations Command, *USS Strider*, 2 years.

**Awards/Commendations:**  
Silver Star of Heroism, First Class

**Reprimands:** None

**Comments:**  
Awarded Silver Star for saving the lives of eight fellow  
officers during a fire on the *USS Randolph*. Sustained  
severe damage to lungs in blaze; condition believed to be  
permanent.

**STAR FLEET PERSONNEL RECORD**

**Name:** 'CHU, Hung  
**Rank:** Lieutenant Commander  
**Current Assignment:** Defense Outpost 1121  
**Position:** Security Chief

**Race:** Human  
**Age:** 30  
**Sex:** Male

**Birthplace:** Biro, Dinil.

**Service Record:**  
1st Cadet Cruise, Military Operations Command,  
1 year.  
2nd Cadet Cruise, Merchant Marine Command,  
1 year.  
Military Operations Command, *USS Thranstor*,  
4 years.  
Defense Outpost 1121, 3 years.

**Awards/Commendations:** None

**Reprimands:** None

**Comments:**  
Failure of first cadet cruise due to erratic  
performance.

**STAR FLEET PERSONNEL RECORD**

**Name:** THOMPSON, Jack Thales  
**Rank:** Lieutenant Commander  
**Current Assignment:** Military Operations Command,  
*USS Strider*, NCC 7141  
**Position:** Helmsman

**Race:** Human  
**Age:** 40  
**Sex:** Male

**Birthplace:** Dorthican Continent, Alpha Centauri

**Service Record:**  
Cadet Cruise, Military Operations Command, 1 year.  
Galaxy Exploration Command, *USS Gandalf*, 2 years.  
Military Operations Command, *USS Longsight*,  
2 years.  
Military Operations Command, *USS Strider*, 4 years.

**Awards/Commendations:** None

**Reprimands:**  
Drunk and disorderly conduct, Stardate 1/9909.09,  
Grade Reduction.  
Conduct unbecoming an officer, Stardate 2/1001.01,  
Paroled.

**Comments:**  
This man rarely follows orders. Will disregard those  
orders that he feels are wrong, despite regulations.

**STAR FLEET PERSONNEL RECORD**

**Name:** DESMONAL, Lori Karen  
**Rank:** Lieutenant  
**Current Assignment:** Military Operations Command,  
*USS Strider*, NCC 7141  
**Position:** Engineer's Mate

**Race:** Alpha Centauran  
**Age:** 29  
**Sex:** Female

**Birthplace:** Tamen, Alpha Centauri  
**Service Record:**

- 1st Cadet Cruise, Colonial Operations Command, 1 year.
- 2nd Cadet Cruise, Galaxy Exploration Command, *USS Hood*, 1 year.
- Military Operations Command, *USS Vidal*, 2 years.
- Military Operations Command, *USS Strider*, 1 year.

**Awards/Commendations:** None

**Reprimands:**

One reprimand for leaving mainflow circuit access unattended during general quarters, Stardate 2/1611.01. No punishment.

**Comments:** None

**STAR FLEET PERSONNEL RECORD**

**Name:** K'TRIL  
**Rank:** Lieutenant  
**Current Assignment:** Military Operations Command,  
*USS Strider*, NCC 7141  
**Position:** Communications Officer

**Race:** Caitian  
**Age:** 31  
**Sex:** Female

**Birthplace:** Shaduma, Samar  
**Service Record:**

- Cadet Cruise, Galaxy Exploration Command, 1 year.
- Galaxy Exploration Command, *USS Enterprise*, 3 years.
- Star Base 9, 4 years.
- Military Operations Command, *USS Strider*, 2 years.

**Awards/Commendations:** None

**Reprimands:** None

**Comments:**

Has contracted syphotenitus and has been cured. Likely to have relapses every 2 years.

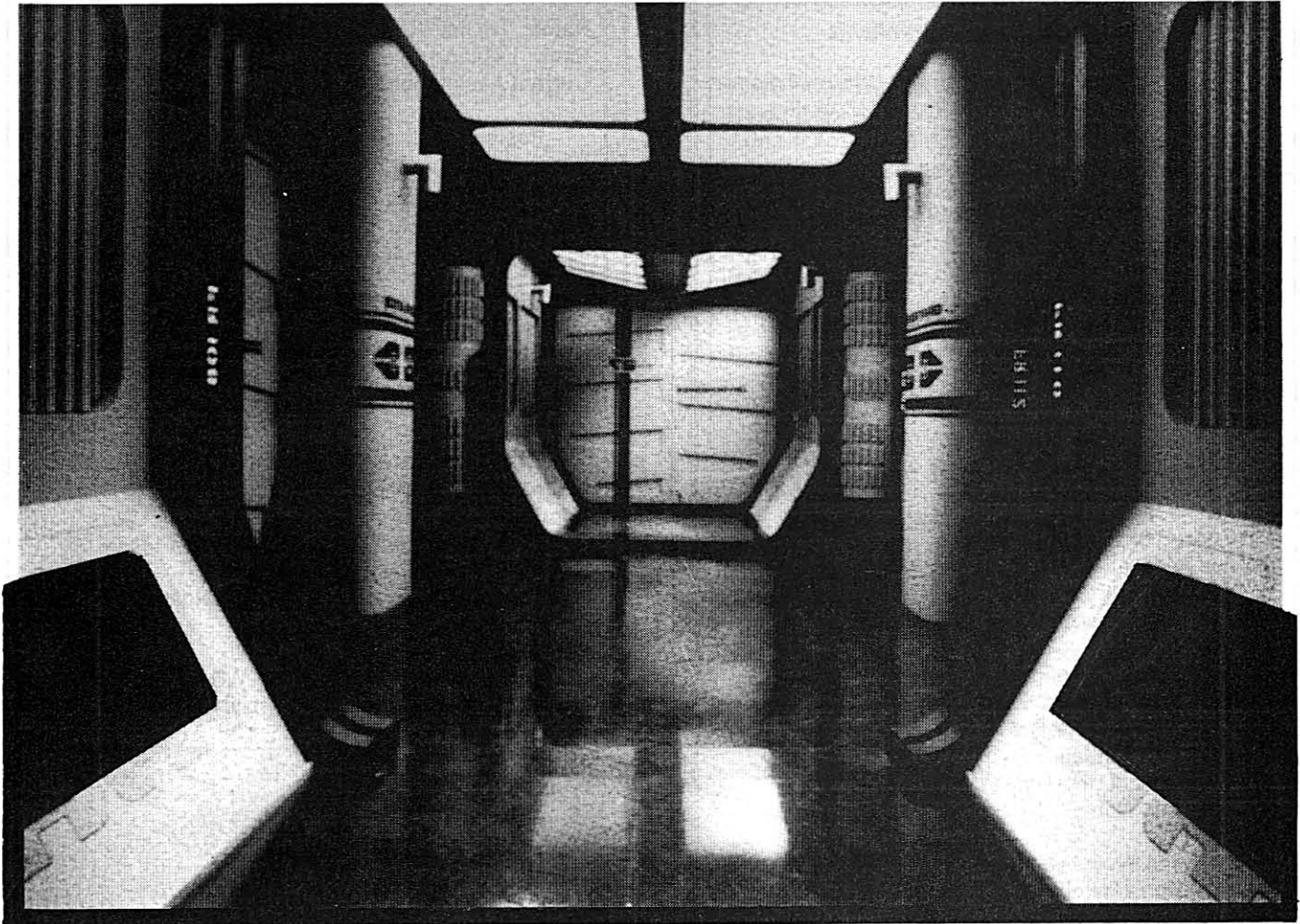

# MAP

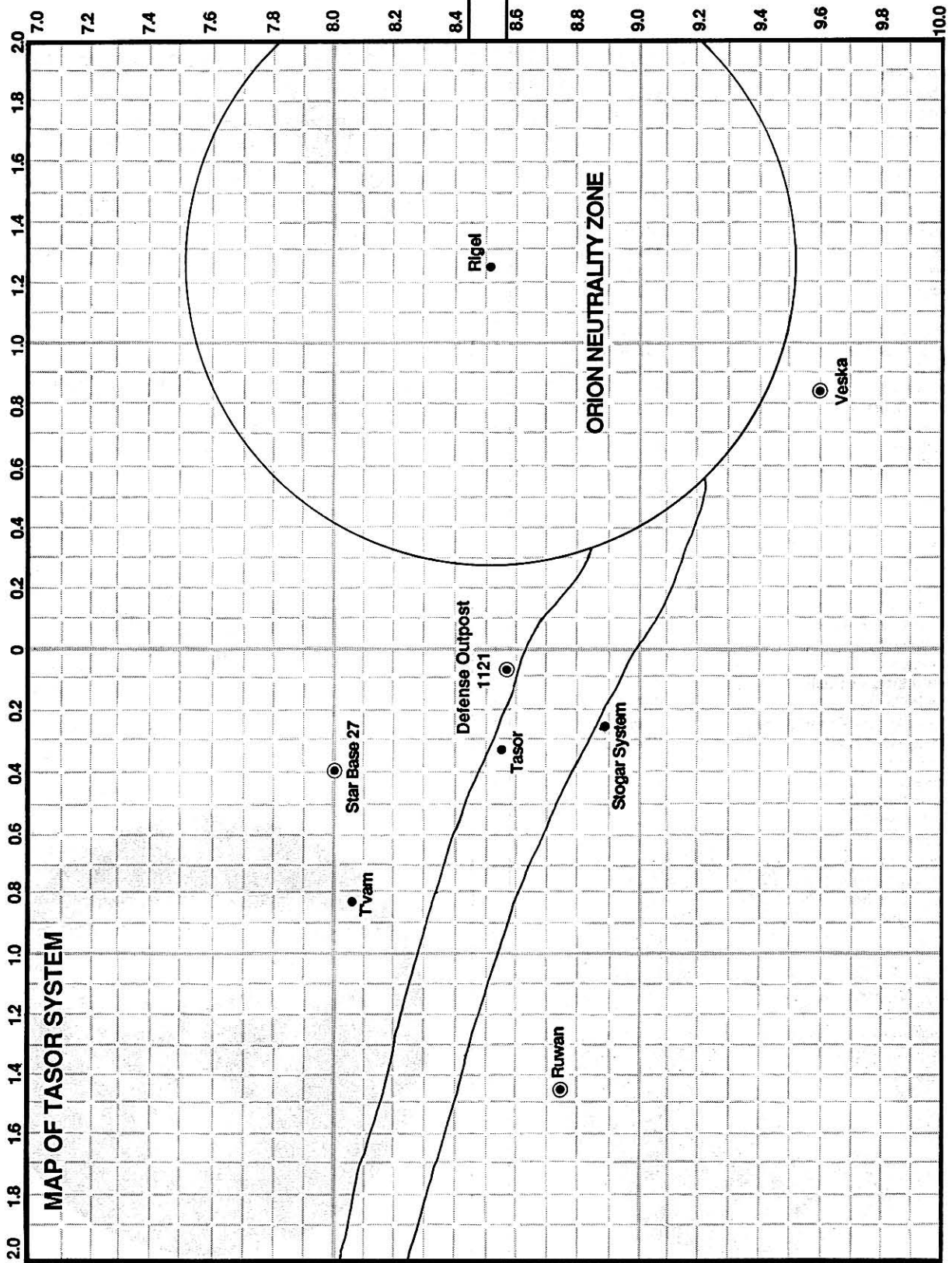

1 Square = 1 Parsec





# VESSELS

## ENTERPRISE CLASS XI CRUISER

<b>Construction Data:</b>	
Model Number—	MK I
Date Entering Service—	2/1704
Number Constructed—	26
<b>Hull Data:</b>	
Superstructure Points—	26
Damage Chart—	C
<b>Size</b>	
Length—	302 m
Width—	131 m
Height—	74 m
Weight—	160,275 mt
<b>Cargo</b>	
Cargo Units—	450 SCU
Cargo Capacity—	22,500 mt
Landing Capability—	None
<b>Equipment Data:</b>	
Control Computer Type—	M-6
<b>Transporters—</b>	
standard 6-person	4
emergency 22-person	4
cargo	2
<b>Other Data:</b>	
Crew—	412
Passengers—	60
Shuttlecraft—	12
<b>Engines And Power Data:</b>	
Total Power Units Available—	60
Movement Point Ratio—	4/1
Warp Engine Type—	FWG-1
Number—	2
Power Units Available—	26
Stress Charts—	D/F
Maximum Safe Cruising Speed—	Warp 8
Emergency Speed—	Warp 10
Impulse Engine Type—	FIE-2
Power Units Available—	8
<b>Weapons And Firing Data:</b>	
Beam Weapon Type—	FH-11
Number—	6 in 3 banks
Firing Arcs—	2f/p,2f,2f/s
Firing Chart—	Y
Maximum Power—	10
Damage Modifiers—	
+3	(1-10)
+2	(11-17)
+1	(18-24)
Missile Weapon Type—	FP-4
Number—	2
Firing Arcs—	f
Firing Chart—	S
Power to Arm—	1
Damage—	20
<b>Shields Data:</b>	
Deflector Shield Type—	FSP
Shield Point Ratio—	1/4
Maximum Shield Power—	16
<b>Combat Efficiency:</b>	
D—	145.2
WDF—	89.2

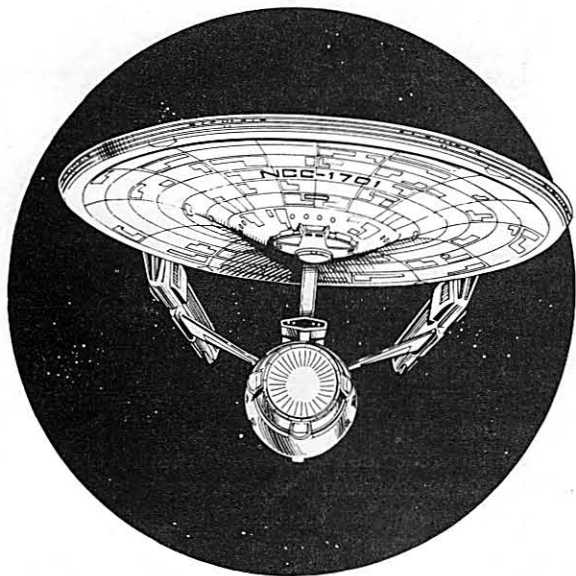
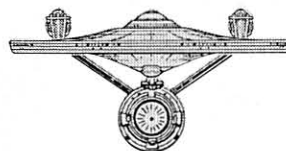
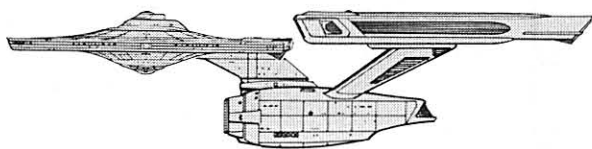
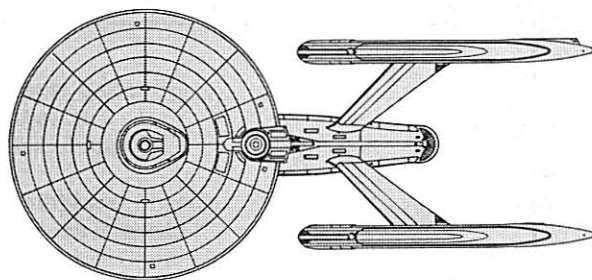

## RANGER CLASS V-VI SCOUT

### Construction Data:

Model Number— MK II  
 Date Entering Service— 2/1710  
 Number Constructed— 108

### Hull Data:

Superstructure Points— 12  
 Damage Chart— C  
 Size  
 Length— 87 m  
 Width— 57 m  
 Height— 21 m  
 Weight— 59,145 mt

### Cargo

Cargo Units— 20 SCU  
 Cargo Capacity— 1,000 mt  
 Landing Capability— None

### Equipment Data:

Control Computer Type— M-2  
 Transporters—  
     standard 6-person 2  
     emergency 22-person 1

### Other Data:

Crew— 77  
 Troops— 6  
 Shuttlecraft— 2

### Engines And Power Data:

Total Power Units Available— 34  
 Movement Point Ratio— 2/1  
 Warp Engine Type— FWB-2  
 Number— 2  
 Power Units Available— 14  
 Stress Charts— M/O  
 Maximum Safe Cruising Speed— Warp 8  
 Emergency Speed— Warp 9  
 Impulse Engine Type— FIB-3  
 Power Units Available— 6

### Weapons And Firing Data:

Beam Weapon Type— FH-6  
 Number— 4 in 2 banks  
 Firing Arcs— 2p/f, 2t/s  
 Firing Chart— N  
 Maximum Power— 3  
 Damage Modifiers—  
     +2 (1-7)  
     +1 (8-13)  
 Missile Weapon Type— FP-7  
 Number— 2  
 Firing Arcs— 1f, 1a  
 Firing Chart— H  
 Power To Arm— 1  
 Damage— 6

### Shields Data:

Deflector Shield Type— FSH  
 Shield Point Ratio— 1/2  
 Maximum Shield Power— 14

### Combat Efficiency:

D— 80.2  
 WDF— 14.0

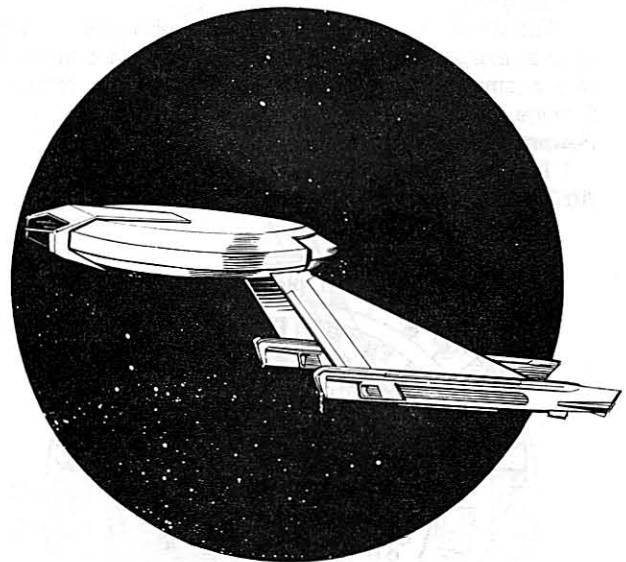
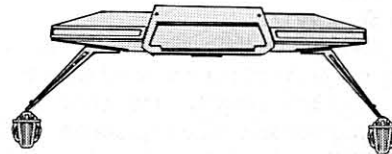
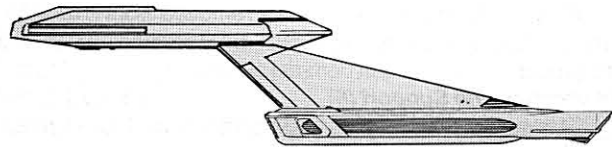
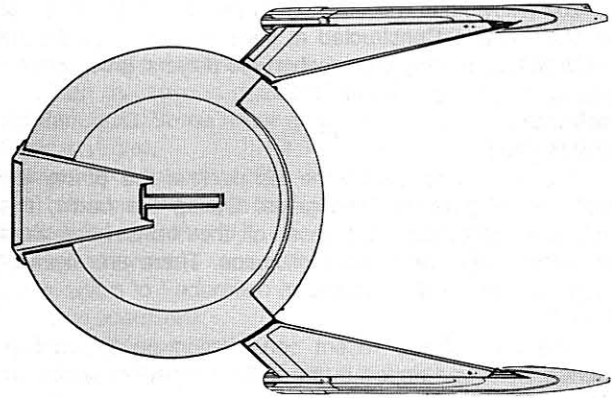

## DECK PLANS

The following is a description of the rooms and levels of the *USS Strider*. Constructed at the Morena shipyards, the *Strider* will be in sorry shape when the players' group comes aboard.

### Deck One

#### Staterooms (1)

The 40 staterooms on the top deck of the *Strider* are empty of *all* personal belongings. During the battle, this deck was breached, and most of the items here were sucked out into the vacuum of space. There are signs of recent fire in some of the corridors.

#### Gym (2)

This area shows recent construction on the ceiling, where a hole was ripped in the hull. The padded walls are totally burnt, as is the floor.

#### Mess Hall (3)

All of the furnishings in this area have been smashed against the walls. Blood is everywhere. Among the debris, there is a broken helmet from an environmental suit.

#### Recreation (4)

Most of the games have been removed from this area, which is being used by the repair crew to store parts and equipment.

#### Emergency Life Support (5)

This atmospherically sealed room shows little damage from the battle.

#### Emergency Batteries (6)

During the battle, both of these sections remained intact, though a few cells in the starboard area show signs of recent overheating.

#### Sickbay and Surgery (7)

Blood is speckled on the walls and ceilings of this area. During the battle, many of the wounded were brought here. When the deck lost integrity, the crew here suffered drastically from explosive decompression. Although the medical aid team from the outpost has cleaned most of this area, it is poorly stocked with medical supplies.

#### Officers' Quarters (8)

The Captain's and the First Officer's rooms are charred beyond recognition. As the rooms reek of chemical stench, no one will be able to spend any time in them.

#### Life Support (9)

The life support area shows signs of a major fire and several explosions. Though life support is not functional, only a small amount of work is necessary to repair the damage.

#### Forward Torpedo Tubes (10)

This area took no damage.

#### Aft Torpedo Tubes (11)

This area took no damage.

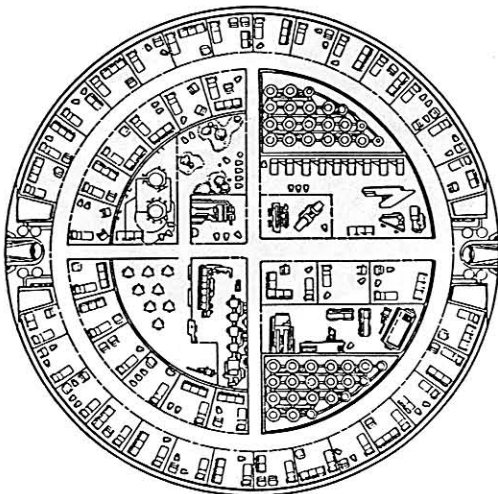

### Deck Two

#### Bridge (1)

This area shows signs of several minor electrical fires. Many of the consoles are open for repair, and there are signs of patchwork repairs common in battle situations. There is also a small quantity of blood near the doorway.

#### Transporter Rooms (2)

Although the port transporter room is functional, the starboard system shows signs of damage, and its console has been dismantled.

#### Weapons Control Room (3)

This room can be used to control the main phasers as well as the photon torpedo tubes. There is a great deal of dried blood in this room.

#### Hydroponics (4)

This area has suffered remarkably little damage. Several hydroponic tanks have been shattered and some have been removed.

#### Biology Lab (5)

The broken glass and spilled chemicals have been cleaned up and placed in large drums. Many of the plants have been removed to the outpost.

#### Water Storage and Purification (6)

This area was emptied when the outer hull was ruptured. Although spare tanks have been moved into the hallways on certain decks, this main source is dry.

#### Computers (7)

Though this area shows signs of recent fire, the computers are operational.

#### Communications (8)

Base engineers have replaced much of the damaged equipment, but most systems are still not functional. Many tools and equipment parts are here.

#### Physics Lab (9)

During the battle, this area served as a makeshift sickbay. The lab equipment has been trashed, and there are several cots and empty medical kits strewn throughout the room.

#### Lounge (10)

Overturned tables and chairs mark this area.

#### Conference Room (11)

Still intact and usable, this area shows little sign of battle damage.

#### Storage Areas (12)

These rooms are empty except for the coffins of eight crewmembers. They were supposed to have been taken to Star Base 12 when the *Strider* arrived there for full repairs.

#### Pressure Controls (13)

These controls for the shuttlebay area are still intact and usable.

#### Repair Equipment (14)

The repair equipment locker is empty except for some small tools brought by the Outpost engineers.

#### Air Lock (15)

There are no environmental suits left here, though the lock still works.

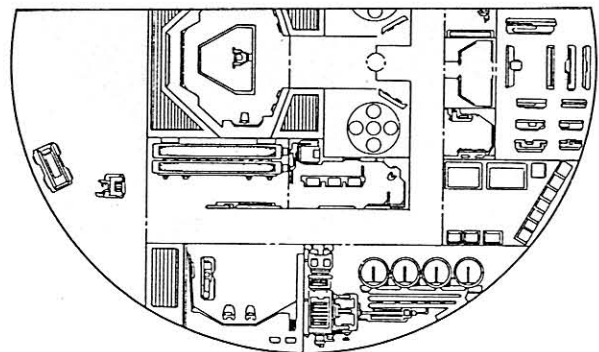

### Deck Three

#### Engineering (1)

The repair crews have set up operations here. Crates of repair parts are on the floor, and massive cables have been strung up on the ceilings and floors. The sickly green stain on the walls and floor is from a coolant leak from the impulse engines. Monitoring equipment is rigged in several areas.

#### Shield Generators (2)

Though functional, both generators show signs of stress and may not hold up for long. Any engineering check will show that they have to be replaced.

#### Jefferies Tubes (3)

Excess cables feed into these areas. Hopplemeyer is sleeping in one.

#### Auxiliary Control (4)

The *Strider* crew scavenged most of this room's consoles to keep the bridge functioning for their trip to the Outpost. The base engineers are storing several crates here.

#### Chief Engineer's Office (5)

As the filing cabinets were destroyed, paperwork litters this office. Most of the paper smells of smoke and coolant.

#### Brig (6)

This room is intact but empty. It shows signs of coolant seepage from the impulse engines.

#### Armory (7)

This intact room holds 20 Phaser IIs as well as several dozen rechargers.

#### Internal Security (8)

This control room is gutted, and the engineers have removed all the equipment.

#### Fabrication Equipment (9)

When the second deck lost its integrity, this area was also damaged. Some minor repairs have got this equipment to function again.

#### Emergency Equipment (10)

This room now stores tools and parts for the repairmen.

#### Backup Generators (11)

These systems are still functional and helped the *Strider* return to Federation space. It is still handling most of the vessel operations.

#### Transporter Room (12)

The cargo transporter is not functional, and the control panel is charred. It seems that the console might have short-circuited.

#### Storage Hold (13)

Most of this area's damage is structural, and the room supports are bent and crooked. A number of crates for the repair crew are sitting in the middle of the room.

#### Airlocks (14)

The starboard lock is rigged to the mooring boom of the Outpost, and the port lock is jammed and unusable.

#### Shuttlebay (15)

This area has two shuttles that are battered from sliding free during combat. Although both are functional, the base engineers sealed the bay doors for the duration of repairs.

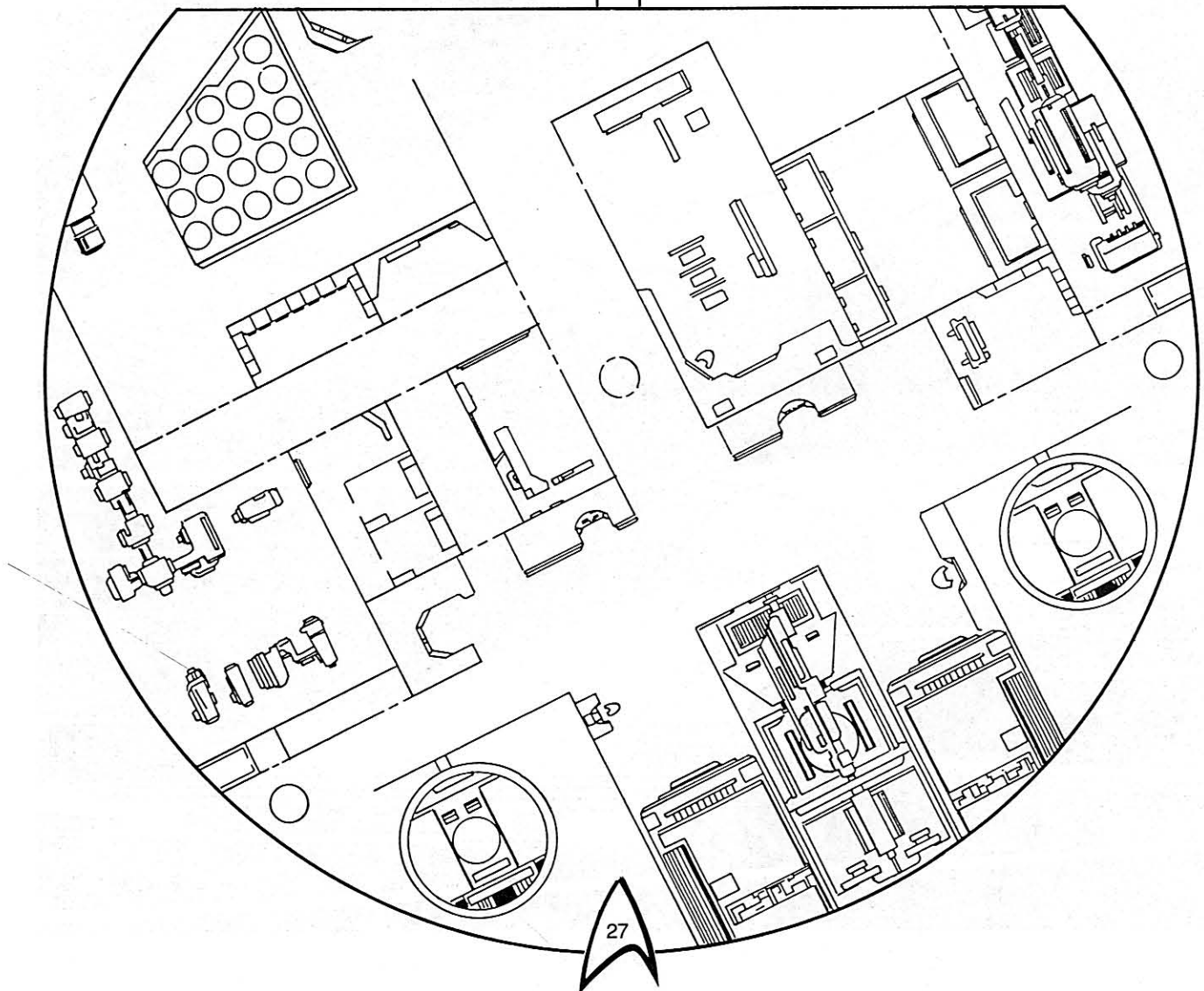



# Deck One

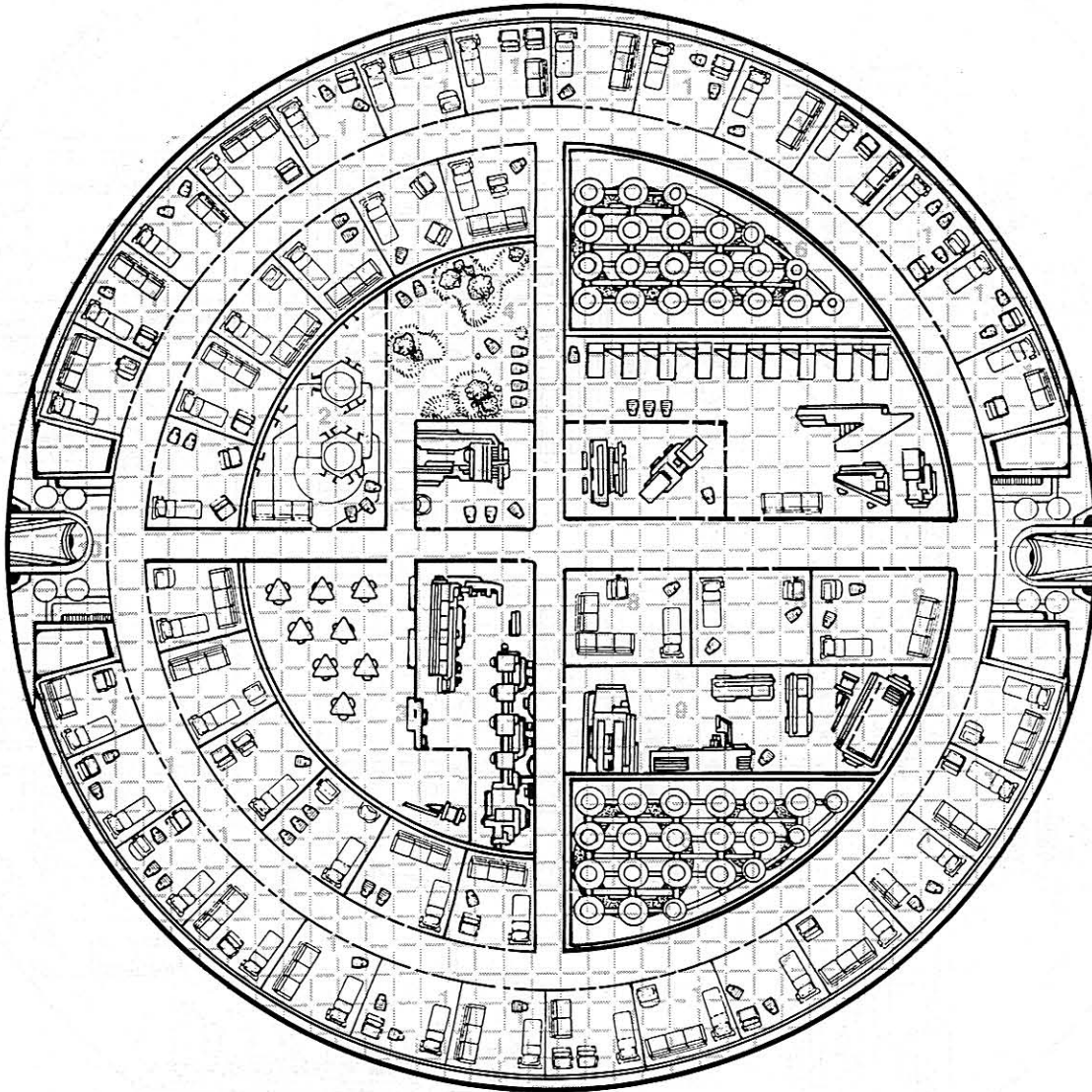

1 Square = 1.5 Meters

# Deck Two

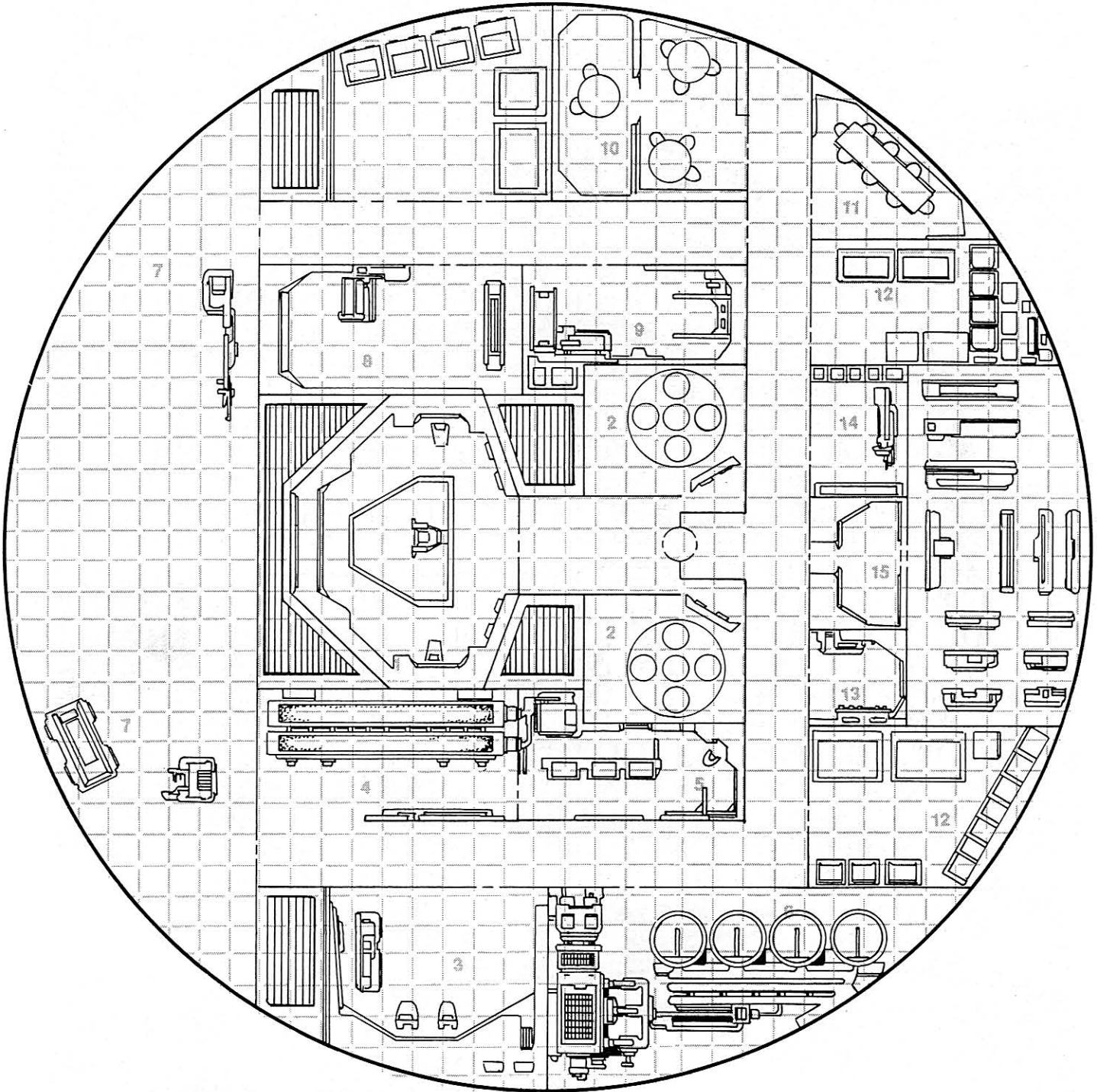

1 Square = 1.5 Meters



# Deck Three

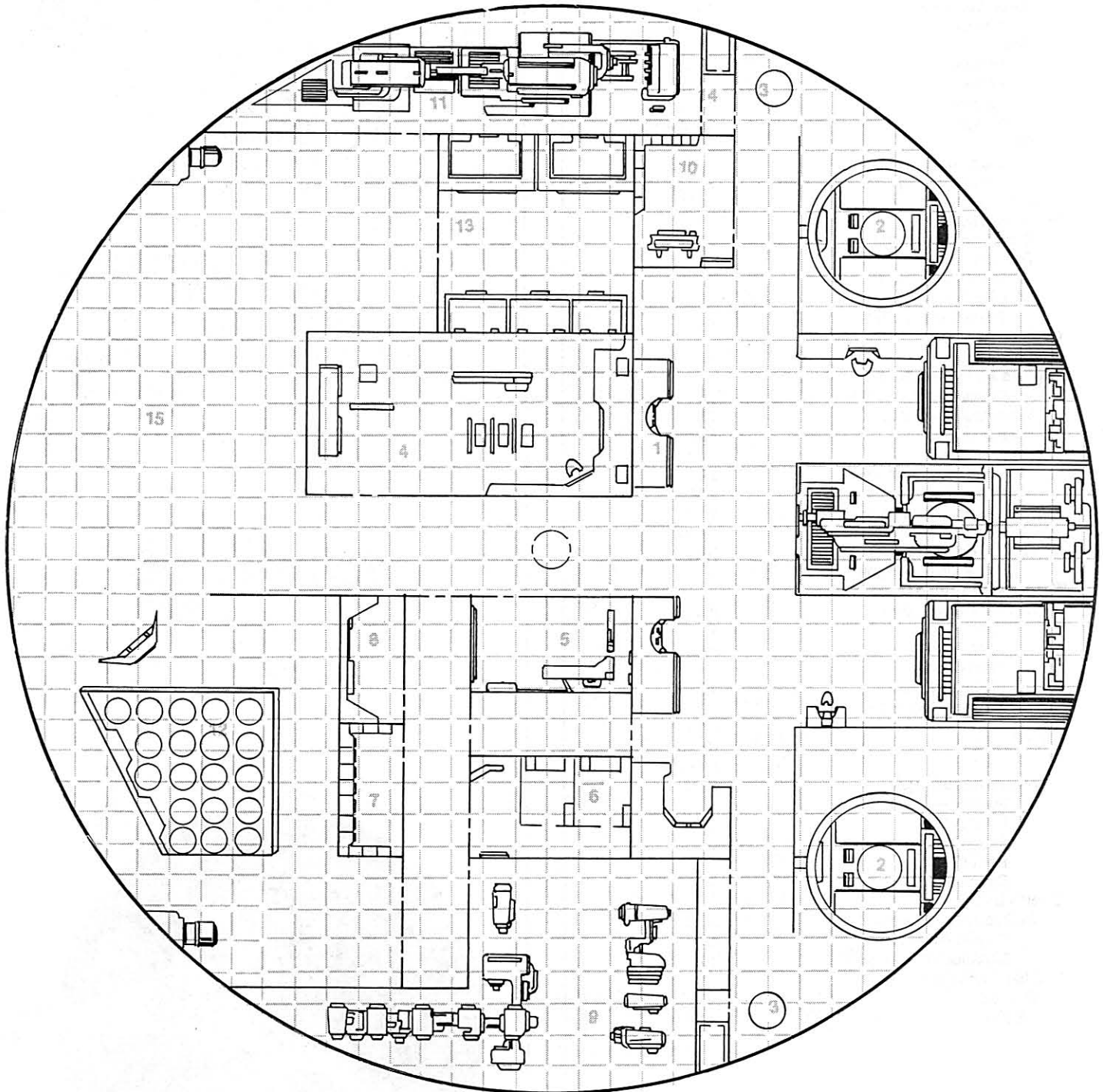

1 Square = 1.5 Meters



## K-22 (BIRD OF PREY) CLASS V SCOUT

### Construction Data:

Model Number— A  
 Date Entering Service— 2/1805  
 Number Constructed— 8

### Hull Data:

Superstructure Points— 10  
 Damage Chart— C  
 Size  
 Length— 88 m  
 Width— 130 m  
 Height— 16 m  
 Weight— 46,300 mt

### Cargo

Cargo Units— 5 SCU  
 Cargo Capacity— 250 mt  
 Landing Capability— Yes

### Equipment Data:

Control Computer Type— ZD-4  
 Transporters—  
 standard 6-person 1  
 Cloaking Device Type— KCB  
 Power Requirement— 22

### Other Data:

Crew— 12

### Engines And Power Data:

Total Power Units Available— 25  
 Movement Point Ratio— 2/1  
 Warp Engine Type— KWC-3  
 Number— 1  
 Power Units Available— 22  
 Stress Charts— L/M  
 Maximum Safe Cruising Speed— Warp 7  
 Emergency Speed— Warp 8  
 Impulse Engine Type— KIB-1  
 Power Units Available— 3

### Weapons And Firing Data:

Beam Weapon Type— KD-8  
 Number— 2  
 Firing Arcs— 1f/p,1f/s  
 Firing Chart— U  
 Maximum Power— 7  
 Damage Modifiers—  
 +3 (1-7)  
 +2 (8-15)  
 +1 (16-20)  
 Missile Weapon Type— KP-5  
 Number— 1  
 Firing Arcs— 1f  
 Firing Chart— Q  
 Power To Arm— 1  
 Damage— 10

### Shields Data:

Deflector Shield Type— KSC  
 Shield Point Ratio— 1/1  
 Maximum Shield Power— 10

### Combat Efficiency:

D— 45.8  
 WDF— 17.7

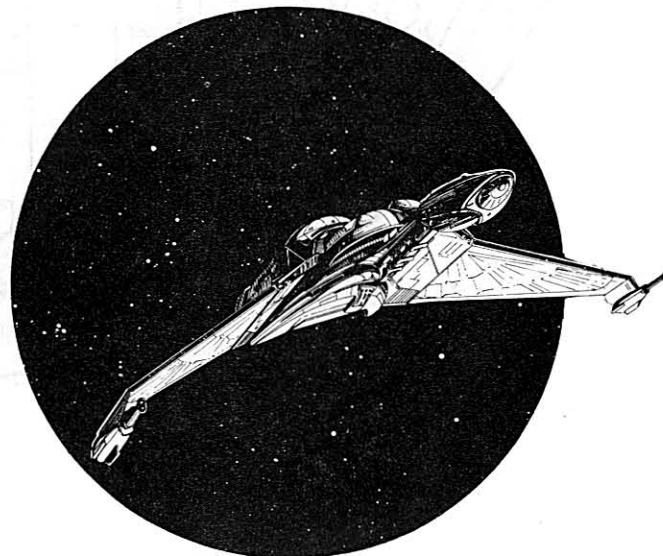
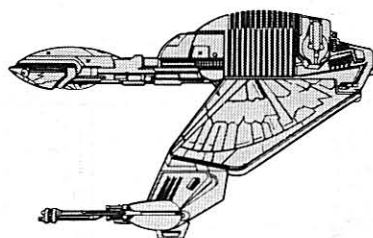
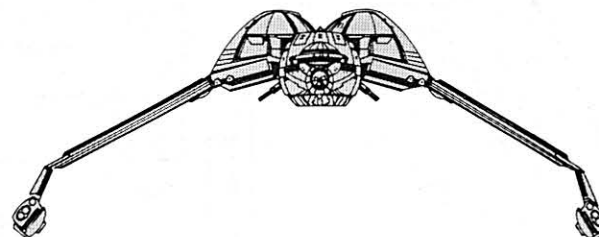
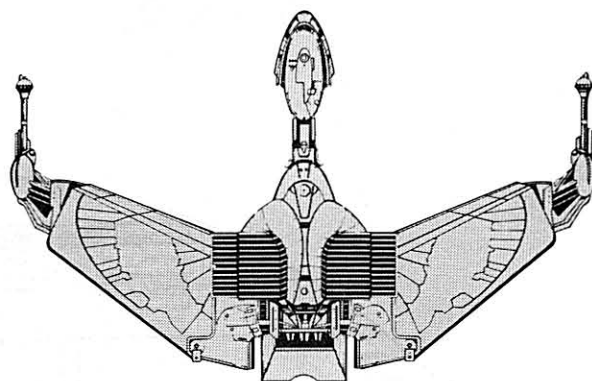

# CAST OF CHARACTERS

There is a 10 percent chance that a player character has previously met Captain Reardon at some official Star Fleet function. If they have met, there is a 75 percent chance that the player character likes Captain Reardon and believes she could not have attacked the Klingon Empire without orders to do so.

The player character sheets below are intended for those players with little time for or little experience in generating characters. At the gamemaster's discretion, players may create their own characters. However, remember that this adventure takes place in Stardate 2/18 and *STAR TREK* present is 2/2310.

## PLAYER CHARACTERS

**Name:** WORRENTILL, Wanda

**Rank/Title:** Commander

**Current Assignment:** Galaxy Exploration Command,  
*USS Lexington*, NCC 1709

**Position:** First Officer

**Race:** Human

**Age:** 36

**Sex:** Female

**Attributes:**

STR - 59	CHA - 80
END - 80	LUC - 77
INT - 70	PSI - 22
DEX - 82	

**Combat Statistics:**

To-Hit Numbers—	Bare-Hand Damage: 1D10 + 8
Modern: 58	AP: 12
HTH: 70	



Significant Skills	Rating
Carousing	20
Computer Operation	44
Damage Control Procedures	41
Deflector Shield Operation	47
Deflector Shield Technology	22
Environmental Suit Operation	13
Instruction	47
Languages	
Klingonaase	28
Orion	20
Leadership	63
Life Science, Biology	10
Marksmanship, Modern	34
Medical Science	
General Medicine, Human	18
Negotiation/Diplomacy	57
Personal Combat, Unarmed	57
Personal Weapons Technology	06
Physical Science, Computer Science	48
Planetary Science, Geology	15
Shuttlecraft Pilot	44
Small Equipment Systems Operation	25
Social Sciences	
Federation Law	47
Federation Culture/History	40
Space Sciences	
Astrogation	45
Astronautics	15
Astronomy	28
Astrophysics	23
Starship Combat Strategy/Tactics	62
Starship Sensors	39
Transporter Operation Procedures	23
Trivia, 2-D Movies	36
Warp Drive Technology	19
Zero-G Operations	18

**Distinguishing Physical Characteristics:**

Wanda is a very excitable person who is rarely still. Though she has blond hair and a slender build, it is her green eyes that attract her fellow officers' attention.

**Brief Personal History:**

*Birthplace:* Alpha III.  
Cadet Cruise, Military Operations Command, High Honors.  
Colonial Operations Command, 3 years.  
Merchant Marine Command, 2 years.  
Colonial Operations Command, *USS Hethelik*, 5 years.  
Military Operations Command, *USS Burnham*, 3 years.  
Galaxy Exploration Command, *USS Lexington*, 7 months.

Wanda came from a rich family and could have had anything she wanted. Instead, she turned her back on all that and enlisted with Star Fleet. She has performed extremely well on all her cruises, and has been promoted accordingly. During the Organian Conflict, she experienced some action, and her navigation helped the *Hethelik* out of more than one jam.

**Personality:**

*Motivations/Desires/Goals:*

Wanda desperately wants to prove herself to her family and fellow officers. Because she always tries to do her best, she disapproves of those who perform at less than their potential.

*Manner:*

A newly promoted commander, Wanda feels that her duties on the *Lexington* are geared to test her abilities. Captain Franklin has often complimented her on her performance, and this has only pressured her to try harder.

**Name:** MANYARD, Wendall

**Rank/Title:** Commander

**Current Assignment:** Galaxy Exploration Command,  
*USS Lexington, NCC 1709*

**Position:** Chief Engineer

**Race:** Alpha Centauran

**Age:** 56

**Sex:** Male

**Attributes:**

STR - 56	CHA - 70
END - 71	LUC - 41
INT - 88	PSI - 10
DEX - 69	

**Combat Statistics:**

To-Hit Numbers—	Bare-Hand Damage: 1D10 +6
Modern: 45	AP: 10
HTH: 54	

**Significant Skills**

	Rating
Administration	49
Communication Systems Technology	25
Communication Systems Operation	30
Computer Operation	29
Computer Technology	61
Damage Control Procedures	14
Deflector Shield Technology	79
Electronics Technology	79
Environmental Suit Operation	32
Instruction	34
Leadership	54
Life Sciences, Biology	17
Life Support Systems Technology	50
Marksmanship, Modern	21
Mechanical Engineering	79
Medical Science	
General Medicine, Human	26
Personal Combat, Unarmed	38
Personal Weapons Technology	30
Small Equipment Systems Operation	76
Physical Sciences	
Mathematics	80
Physics	43
Shuttlecraft Systems Technology	19
Social Sciences	
Federation Law	27
Federation Culture/History	26
Space Sciences	
Astronautics	52
Astronomy	18
Starship Sensors	19
Starship Weaponry Technology	43
Transporter Operation Procedures	52
Transporter Systems Technology	60
Warp Drive Technology	85
Zero-G Operations	41

**Distinguishing Physical Characteristics:**

Short and stocky, Wendall has a powerful frame. His pockets are usually crammed with small testing devices or tools. He wears his dark brown hair in a crew cut.

**Brief Personal History:**

**Birthplace:** Quiberon Prime, Alpha Centauri  
Cadet Cruise, Colonial Operations Command, 1 year.  
Galaxy Exploration Command, *USS Defiant*, 2 years.  
Military Operations Command, *USS Stein*, 3 years.  
Star Fleet Training Command, 12 years.  
Military Operations Command, Star Base 12, 3 years.  
Galaxy Exploration Command, *USS Ford*, 6 years.  
Galaxy Exploration Command, *USS Lexington*, 2 years.

Even as a young boy, Wendell showed a rather unique talent for taking things apart and putting them back together. He graduated with honors from the Cochrane Institute of Technology, then took his fine talents to Star Fleet. As he has no living family, his only ties are with Star Fleet and his commanding officers.

**Personality:**

**Motivations/Desires/Goals:**

Wendell was the engineer in charge of the *Lexington's* construction, and so he knows the ship well. At times, he can get on the Captain's nerves when he demands special replacement parts for the ship. Wendell firmly believes in having only the best for his engine room, no matter what the Captain or the rest of Star Fleet thinks. However, he is very happy in Star Fleet, where he gets paid for doing what he loves best.

**Manner:**

Although Wendell can be temperamental at times, he is always ready to assist those who are humble enough to ask for help. He considers the *Lexington* to be the most important ship in the fleet. Because he expects his engine room to be always perfect, his crewmen have grown to dread his inspections.



**Name:** DRIVEON, Dr. Winston  
**Rank/Title:** Commander  
**Current Assignment:** Galaxy Exploration Command,  
*USS Lexington, NCC 1709*  
**Position:** Chief Medical Officer

**Race:** Human  
**Age:** 50  
**Sex:** Male

**Attributes:**

STR - 50	CHA - 70
END - 60	LUC - 46
INT - 86	PSI - 29
DEX - 54	

**Combat Statistics:**

To-Hit Numbers—	Bare-Hand Damage: 1D10 +4
<i>Modern:</i> 38	AP: 9
<i>HTH:</i> 47	

**Significant Skills**

	<b>Rating</b>
Administration	52
Carousing	26
Computer Operation	72
Damage Control Procedures	32
Environmental Suit Operation	10
Instruction	35
Languages	
Andorian	33
Klingon	22
Life Sciences	
Biology	52
Bionics	40
Botany	33
Life Support Systems Technology	27
Marksmanship, Modern	21
Medical Science	
General Medicine, Andorian	75
General Medicine, Human	89
General Medicine, Vulcan	41
Psychology, Andorian	53
Psychology, Human	83
Personal Combat, Unarmed	40
Personal Weapons Technology	09
Physical Science, Mathematics	32
Planetary Science, Geology	11
Small Equipment Systems Operation	25
Social Sciences	
Andorian Culture/History	33
Federation Culture/History	35
Federation Law	15
Space Science, Astronomy	14
Starship Sensors	12
Transporter Operation Procedures	38
Zero-G Operations	17

**Distinguishing Physical Characteristics:**

The doctor has a round face, stark white hair, and a deep voice. He walks with long strides and has a rather sinister grin.

**Brief Personal History:**

**Birthplace:** Brooklyn, U.S.A., Terra.  
 Cadet Cruise, Merchant Marines Command, *USS Farragut*,  
 1 year.  
 Star Fleet Training Command, *USS Nightingale*, 7 years.  
 Galaxy Exploration Command, *USS Saratoga*, 6 years.  
 Military Operations Command, *USS Churchill*, 6 years.  
 Galaxy Exploration Command, *USS Lexington*, 1 year.

Winston was born to a poverty-stricken family in the slums of Brooklyn. Earning a scholarship to Oxford University, he eventually got his doctorate in medicine. However, instead of doing work in the public sector, he joined Star Fleet Command. During the Four Years War, he earned the Legion of Merit for saving the lives of over 30 crewmen in the Battle of Kyros.

**Personality:**

**Motivations/Desires/Goals:**

The doctor is a practical joker. Teamed up with V'Shall, he has played practical jokes on almost every member of the crew. His favorite joke involved planting a *z'thil*, an Andorian whoopee cushion, in the Captain's seat. During the execution of his jokes, he always keeps a straight face.

**Manner:**

Doctor Driveon has an easy-come, easy-go attitude toward life. Because his Legion of Merit medal is important to him, he wears it all the time.



**Name:** TRELLAN, Megan  
**Rank/Title:** Lieutenant Commander  
**Current Assignment:** Galaxy Exploration Command,  
*USS Lexington*, NCC 1709  
**Position:** Chief Science Officer

**Race:** Human  
**Age:** 46  
**Sex:** Female

**Attributes:**

STR - 49	CHA - 70
END - 76	LUC - 55
INT - 81	PSI - 31
DEX - 86	

**Combat Statistics:**

To-Hit Numbers—	Bare-Hand Damage: 1D10 + 2
<i>Modern:</i> 54	AP: 12
<i>HTH:</i> 53	

**Significant Skills** **Rating**

Administration	51
Computer Operation	54
Computer Technology	39
Damage Control Procedures	43
Electronics Technology	23
Environmental Suit Operation	36
Instruction	32
Language, Romulan	08
Leadership	27
Life Sciences	
Genetics	24
Zoology	42
Marksmanship, Modern	22
Medical Science	
General Medicine, Human	20
Personal Combat, Unarmed	20
Personal Weapons Technology	19
Physical Sciences	
Chemistry	31
Computer Science	24
Planetary Sciences	
Geology	31
Hydrology	40
Meteorology	40
Small Equipment Systems Operation	48
Social Sciences	
Federation Law	29
Federation Culture/History	28
Political Science	31
Space Sciences	
Astronautics	49
Astronomy	12
Astrophysics	38
Starship Sensors	47
Transporter Operation Procedures	22
Zero-G Operations	19

**Distinguishing Physical Characteristics:**

Megan is tall, lanky, and rather clumsy. Her hands are very large. When off-duty, she dresses in the latest fashions, but they look terrible on her. She changes her hair style daily.

**Brief Personal History:**

**Birthplace:** Benecia Colony  
 Cadet Cruise, Military Operations Command, *USS Tibur*,  
 1 year.  
 Colonial Operations Command, *USS Thomas*, 2 years.  
 Diplomatic Liaisons Office, Vulcan Science Academy, 4 years.  
 Star Fleet Intelligence, *USS Rickover*, 5 years.  
 Military Operations Command, *USS Skywalker*, 3 years.  
 Galaxy Exploration Command, *USS Lexington*, 1 year.  
 Megan joined Star Fleet to escape from her family's poverty. Instead of sending some of her salary home, she invests it in her appearance. Early in her career, Megan studied at the Vulcan Science Academy as a Liaison Officer. Proud of that assignment, she mentions it every chance that she gets.

**Personality:**

**Motivations/Desires/Goals:**

Megan sees her assignment to the *Lexington* as merely a steppingstone in her career. Although she has requested a transfer to the *USS Excelsior* four times, Captain Franklin has refused, thinking that she needs some humbling before taking on the best assignment in Star Fleet.

**Manner:**

Megan's ego and arrogance have made her the target of many of Driveon and V'Shall's practical jokes. She believes that she is the victim of these "childish pranks" because the crew is jealous of her. Actually, few crewmembers like her.



**Name:** V'SHALL

**Rank/Title:** Lieutenant Commander

**Current Assignment:** Galaxy Exploration Command,  
*USS Lexington*, NCC 1709

**Position:** Chief Navigator

**Race:** Andorian

**Age:** 46

**Sex:** Male

**Attributes:**

STR	— 76	CHA	— 23
END	— 70	LUC	— 33
INT	— 70	PSI	— 21
DEX	— 81		

**Combat Statistics:**

To-Hit Numbers—	Bare-Hand Damage: 2D10 + 6
Modern: 80	AP: 12
HTH: 75	

**Significant Skills**

	Rating
Administration	65
Carousing	31
Computer Operation	41
Computer Technology	37
Damage Control Procedures	12
Deflector Shield Operation	45
Deflector Shield Technology	22
Electronics Technology	22
Environmental Suit Operation	12
Instruction	22
Language, Vulcan	31
Leadership	41
Life Science, Botany	14
Marksmanship, Modern	79
Medical Science	
General Medicine, Andorian	54
General Medicine, Human	10
Personal Combat, Unarmed	68
Personal Weapons Technology	70
Physical Science, Physics	19
Planetary Science, Geology	12
Small Equipment Systems Operation	63
Social Sciences	
Andorian Law	45
Andorian Culture/History	80
Federation Law	17
Federation Culture/History	26
Space Sciences	
Astrogation	72
Astronautics	56
Astronomy	65
Starship Sensors	34
Transporter Operation Procedures	22
Trivia, Andorian War Songs	35
Zero-G Operations	23

**Distinguishing Physical Characteristics:**

V'Shall is a relatively short Andorian. Unlike many Andorians in Star Fleet, he wears robes from Cyclopus instead of traditional Andorian garb while off-duty. V'Shall has a terrible burn mark on his right arm from the uprising on Dankon IV.

**Brief Personal History:**

**Birthplace:** Andor

Cadet Cruise, Galaxy Exploration Command, *USS Republic*, 1 year.

Galaxy Exploration Command, *USS Republic*, 5 years.

Galaxy Exploration Command, *USS Warspite*, 4 years.

Military Operations Command, *USS Mowe*, 5 years.

Military Operations Command, *USS Bismark*, 4 years.

Galaxy Exploration Command, *USS Lexington*, 1 year.

Although V'Shall is heir to the V'stillarn Shipyards on Andor, he has no desire to take control of the family business. Star Fleet has provided him with all the adventure that his homeworld lacks.

During his cadet cruise aboard the *USS Republic*, V'Shall was severely wounded while trying to control the uprising on Dankon IV. In the bloody rioting, he was the only member of the 24-person landing party to survive. For his actions, he received the Medal of Valor, 2nd Class.

**Personality:**

**Motivations/Desires/Goals:**

As the only Andorian in a Human crew, V'Shall is somewhat of a celebrity, and he enjoys it. His ego is huge. However, V'Shall's only real friend is Dr. Driveon. Together, they have been performing a large number of practical jokes on the crew of the *Lexington*. Even Captain Franklin has fallen prey to one of their jokes. So far, no one imagines that the Andorian and the doctor are responsible.

**Manner:**

V'Shall's love of old Andorian war songs has made his visits to local starport pubs somewhat legendary. More than once, the Captain has heard V'Shall and Driveon return to the ship singing at the top of their lungs.



**Name:** RALSTON, David Lee  
**Rank/Title:** Lieutenant Commander  
**Current Assignment:** Galaxy Exploration Command,  
*USS Lexington, NCC 170*  
**Position:** Security Chief

**Race:** Human  
**Age:** 38  
**Sex:** Male

**Attributes:**

STR	- 78	CHA	- 78
END	- 80	LUC	- 12
INT	- 45	PSI	- 23
DEX	- 88		

**Combat Statistics:**

To-Hit Numbers—	Bare-Hand Damage: 2D10 + 5
<i>Modern:</i> 89	AP: 12
<i>HTH:</i> 73	

Significant Skills	Rating
Administration	61
Computer Operation	21
Damage Control Procedures	31
Environmental Suit Operation	22
Instruction	40
Leadership	43
Life Science, Genetics	16
Marksmanship, Modern	90
Medical Science	
General Medicine, Human	28
Psychology, Human	19
Personal Combat, Unarmed	58
Personal Weapons Technology	32
Physical Science, Physics	12
Planetary Science, Hydrology	38
Security Procedures	49
Shuttlecraft Pilot	65
Small Equipment Systems Operation	25
Small Unit Tactics	44
Social Sciences	
Federation Law	49
Federation Culture/History	28
Space Science, Astronomy	13
Starship Sensors	38
Transporter Operation Procedures	32
Zero-G Operations	18

**Distinguishing Physical Characteristics:**

David Lee is tall with blonde hair, broad shoulders, and a muscular body. In contrast to his masculine appearance, he has a very high-pitched voice. He speaks with a slight Southern drawl.

**Brief Personal History:**

*Birthplace:* Virginia, U.S.A., Terra.  
 Cadet Cruise, Colonial Operations Command, 1 year.  
 Military Operations Command, *USS Tripitz*, 4 years.  
 Military Operations Command, *USS Robert E. Lee*, 3 years.  
 Star Fleet Intelligence Command, *USS Camelot*, 2 years.  
 Military Operations Command, Star Base 12, 3 years.  
 Galaxy Exploration Command, *USS Lexington*, 1 year.

The son of wealthy Virginian landowners, David Lee joined Star Fleet after flunking out of college. The highlight of his career occurred when he was working with Star Fleet Intelligence to investigate Orion merchants suspected of smuggling. While raiding the Orions' warehouse, he found an old laser pistol. He sometimes carries the weapon as his sidearm, despite warnings from the Captain.

**Personality:**  
**Motivations/Desires/Goals:**

David joined the Security branch to see some action, and that he has. Though he will not admit it, he wants to command his own ship. Very few Security personnel have ever captained a ship, but David did not know that when he enlisted. Thus, he considers his career an uphill battle to get a ship.

**Manner:**

David gets bored very easily. An impatient man, he always opts for action, even if waiting is the logical choice.

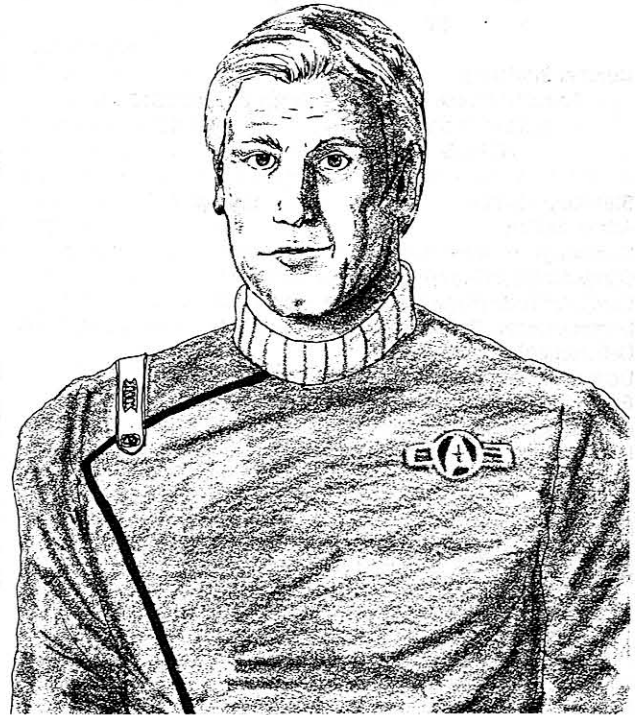

**Name:** TURNMAN, James

**Rank/Title:** Lieutenant

**Current Assignment:** Galaxy Exploration Command,  
*USS Lexington, NCC 1709*

**Position:** Chief Helmsman

**Race:** Human

**Age:** 37

**Sex:** Male

**Attributes:**

STR - 57	CHA - 70
END - 71	LUC - 30
INT - 60	PSI - 12
DEX - 77	

**Combat Statistics:**

To-Hit Numbers—	Bare-Hand Damage: 1D10 + 5
<i>Modern:</i> 54	AP: 11
<i>HTH:</i> 49	

**Significant Skills**

	<b>Rating</b>
Administration	50
Computer Operation	27
Damage Control Procedures	14
Environmental Suit Operation	12
Instruction	10
Language, Andorian	16
Leadership	15
Life Science, Botany	32
Marksmanship, Modern	31
Medical Science	
General Medicine, Human	27
Personal Combat, Unarmed	20
Personal Weapons Technology	10
Physical Science, Mathematics	44
Planetary Science, Meteorology	14
Small Equipment Systems Operation	30
Social Sciences	
Andorian Culture/History	23
Federation Law	36
Federation Culture/History	15
Space Science, Astronomy	14
Starship Combat Strategy/Tactics	38
Starship Helm Operations	55
Starship Sensors	34
Starship Weaponry Operation	58
Starship Weaponry Technology	22
Transporter Operation Procedures	17
Warp Drive Technology	35
Zero-G Operations	11

**Distinguishing Physical Characteristics:**

James Turnman is tall and skinny with long fingers and large feet. He sports a goatee, which matches his sand-colored hair.

**Brief Personal History:**

*Birthplace:* Darv

Cadet Cruise, Galaxy Exploration Command, *USS Starwind*,  
1 year.

Colonial Operations Command, *USS Kirwan*, 6 years.

Military Operations Command, Star Base 12, 3 years.

Military Operations Command, *USS Tigershark*, 4 years.

Galaxy Exploration Command, *USS Lexington*, 1 year.

James joined Star Fleet like his five brothers before him did. However, he is the only one who has become an officer. Recently, his parents were killed when a meteor destroyed their homestead. Since then, Turnman has found his duties to be a hard burden.

**Personality:**

*Motivations/Desires/Goals:*

Complacent about his current position with Star Fleet, James would be more than happy to finish his career as a lieutenant. He has no desire for promotion or his own command, though Captain Franklin seems to think that he has potential for both.

James hopes that the *Lexington* will soon patrol near Darv so that he can pay his last respects to his parents. Although Captain Franklin offered him temporary leave, James turned it down.

*Manner:*

Because of the recent deaths of his parents, James has been slow and dragging in his work. Since turning down leave to visit Darv, he has been fighting his guilt.





**Name:** WANGLESTIEN, Marvin

**Rank/Title:** Lieutenant

**Current Assignment:** Galaxy Exploration Command,  
*USS Lexington*, NCC 1709

**Position:** Chief Communications Officer

**Race:** Human

**Age:** 39

**Sex:** Male

**Attributes:**

STR	— 45	CHA	— 60
END	— 67	LUC	— 70
INT	— 78	PSI	— 10
DEX	— 78		

**Combat Statistics:**

To-Hit Numbers— Bare-Hand Damage: 1D10 + 2

Modern: 49

AP: 11

HTH: 54

**Significant Skills**

**Rating**

Administration	51
Communication Systems Operation	43
Communication Systems Technology	48
Computer Operation	57
Computer Technology	10
Damage Control Procedures	67
Environmental Suit Operation	12
Instruction	39
Languages	
Andorian	68
Gorn	13
Klingonaase	45
Orion	47
Romulan	31
Tellarite	42
Vulcan	39
Leadership	40
Life Science, Biology	12
Marksmanship, Modern	20
Medical Science	
General Medicine, Human	31
Personal Combat, Unarmed	29
Personal Weapons Technology	13
Physical Science, Physics	21
Planetary Science, Geology	17
Small Equipment Systems Operation	15
Social Sciences	
Federation Law	45
Federation Culture/History	23
Klingon Culture/History	23
Orion Culture/History	49
Space Science, Astronomy	18
Starship Sensors	23
Transporter Operation Procedure	30
Zero-G Operations	17

**Distinguishing Physical Characteristics:**

Marvin is the shortest member of the *Lexington* crew—his uniform always seems to be several sizes too large. Often, his dark black hair is uncombed and unkempt. He usually has a small paperback tucked in the pocket of his pants.

**Brief Personal History:**

*Birthplace:* Ariannus

Cadet Cruise, Merchant Marines Command, 1 year.

Military Operations Command, *USS Ranger*, 2 years.

Star Fleet Education and Training Command, Star Base 4,  
7 years.

Military Operations Command, *USS Wellington*, 6 years.

Galaxy Exploration Command, *USS Lexington*, 1 year.

Early in his career, Marvin displayed an uncanny ability to learn languages. He has written several texts and papers on communications that are required reading at Star Fleet Academy.

The high point of his career was the seven years he spent at Star Base 4 working on the Webstar Project. This project analyzed the Orion Colonies, and Marvin worked on the language differences between the two governments. He spent most of this time trying to break Orion codes and loving every minute of it.

**Personality:**

*Motivations/Desires/Goals:*

Besides languages, Marvin has developed a strong love for the Orion culture and its people. He has read several hundred books on the Orions, and he is currently writing a paper on the development of Orion culture and where it will go in the next decade.

*Manner:*

Marvin is one of the most liked members of the *Lexington's* bridge crew. Other people tend to make him nervous, and that is often mistaken for severe shyness. He is the only person on the bridge crew who has been spared from V'Shall and Driveon's practical jokes. The crew consider him a genius.

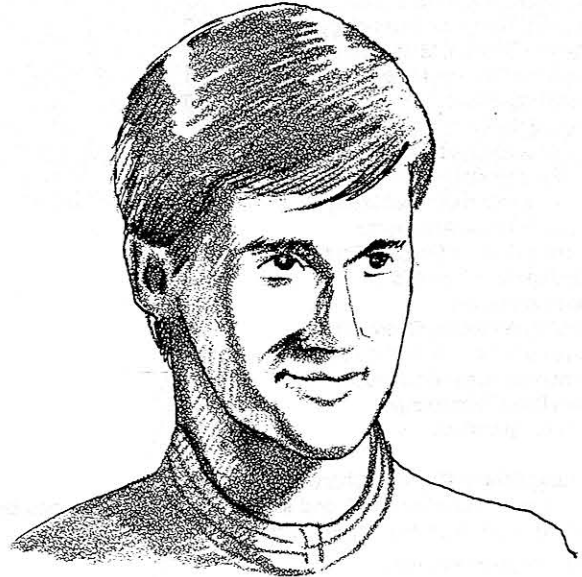

## NPCs

**Name:** FRANKLIN, Grant  
**Rank/Title:** Captain  
**Current Assignment:** Galaxy Exploration Command,  
*USS Lexington, NCC 1709*  
**Position:** Captain

**Race:** Human  
**Age:** 47  
**Sex:** Male

**Attributes:**

STR - 70	CHA - 60
END - 75	LUC - 14
INT - 80	PSI - 13
DEX - 77	

**Combat Statistics:**

To-Hit Numbers—	Bare-Hand Damage: 1D10 + 5
Modern: 68	AP: 11
HTH: 50	

**Significant Skills**

Significant Skills	Rating
Administration	50
Computer Operation	60
Computer Technology	12
Damage Control Procedures	56
Deflector Shield Operation	54
Deflector Shield Technology	50
Electronics Technology	14
Gaming, BattleTech	20
Instruction	44
Languages	
Gorn	58
Romulan	09
Leadership	67
Life Science, Bionics	24
Marksmanship, Modern	59
Medical Science	
General Medicine, Gorn	07
General Medicine, Human	20
Personal Combat, Unarmed	23
Personal Weapons Technology	16
Physical Science, Physics	15
Planetary Sciences	
Geology	29
Meteorology	30
Small Equipment System Operations	30
Social Sciences	
Federation Law	58
Federation Culture/History	45
Gorn Culture/History	12
Space Sciences	
Astrogation	43
Astronautics	13
Astronomy	23
Astrophysics	14
Shuttlecraft Pilot	10
Starship Combat Strategy/Tactics	71
Starship Sensors	38
Transporter Operation Procedures	34
Warp Drive Technology	60
Zero-G Operations	11

**Distinguishing Physical Characteristics:**

A tall man, Captain Franklin has a muscular body and a well-rounded face. His long stride has made him the brunt of jokes at many a star base. He has a long scar on his left arm that a Gorn officer gave him early in his career.

**Brief Personal History:**

*Birthplace:* England, Terra  
 Cadet Cruise, Military Operations Command, 1 year.  
 Colonial Operations Command, 2 years.  
 Military Operations Command, *USS Farragut*, 4 years.  
 Galaxy Exploration Command, *USS Excalibur*, 8 years.  
 Colonial Operations Command, 2 years.  
 Galaxy Exploration Command, *USS Lexington*, 1 year.  
 Captain Franklin joined Star Fleet to rebel against his parents, who were both involved in politics. Ironically, he uses politics every day in his current position, though he does not realize it.  
 Early in his career, Franklin and a Gorn officer were marooned on a planet for several days during an ion storm. When they were finally rescued, he was severely wounded. He refuses to discuss the Gorn, his scar, or anything else about the incident.

**Personality:**

*Motivations/Desires/Goals:*

Grant Franklin considers Star Fleet the savior of billions in the galaxy. Believing in the Federation with all of his heart, he will defend it to the end.

Though he often values a single life over many, so far this thinking has not cost any lives. His caring is a great strength to his crew and a weakness in the eyes of his enemies.

*Manner:*

Franklin is a quiet, sure man. However, whenever he gets an idea, he pursues it relentlessly.



## CREW OF THE *STRIDER*

**Name:** REARDON, Kristine Dorothy

**Rank/Title:** Captain

**Current Assignment:** Military Operations Command,  
*USS Strider* NCC 7141

**Position:** Captain

**Race:** Human

**Age:** 47

**Sex:** Female

### Attributes:

STR	- 68	CHA	- 78
END	- 71	LUC	- 59
INT	- 80	PSI	- 17
DEX	- 56		

### Combat Statistics:

To-Hit Numbers—	Bare-Hand Damage: 1D10 + 6
Modern: 48	AP: 9
HTH: 43	

Significant Skills	Rating
Administration	45
Computer Operation	30
Computer Technology	42
Environmental Suit Operation	10
Instruction	17
Languages	
Klingonaase	50
Orion	21
Leadership	69
Life Science, Zoology	40
Marksmanship, Modern	40
Medical Science	
General Medicine, Human	28
Personal Combat	
Unarmed	30
Sword	25
Personal Weapons Technology	12
Physical Sciences	
Chemistry	10
Computer Science	10
Physics	15
Planetary Sciences	
Geology	12
Hydrology	10
Small Equipment Systems Operation	20
Social Sciences	
Federation Law	30
Federation Culture/History	20
Klingon Culture/History	30
Space Sciences	
Astrogation	09
Astronomy	34
Starship Combat Strategy/Tactics	50
Starship Helm Operation	48
Starship Sensors	25
Starship Weaponry Operation	35
Starship Weaponry Technology	23
Streetwise	21
Transporter Operation Procedures	20
Zero-G Operations	11

### Distinguishing Physical Characteristics:

Captain Reardon has dark red hair, grey eyes, and very small hands.

### Brief Personal History:

**Birthplace:** New York, U.S.A., Terra

Cadet Cruise, Galaxy Exploration Command, *USS Potemkin*,  
1 year.

Military Operations Command, *USS Waltor*, 4 years.

Star Base 12, 2 years.

Military Operations Command, *USS Kingston*, 5 years.

Merchant Marines Command, 8 years.

Military Operations Command, *USS Strider*, 5 years.

Early during her Star Fleet career, Kristine's brother Peter was killed in a Klingon border raid. Peter was her only living relative. Since then, Star Fleet has become her life.

### Personality:

#### Motivations/Desires/Goals:

Captain Reardon was offered the opportunity to command a ship-of-the-line, but she turned the offer down. She does not want to leave the border of the Organian Neutral Zone because that was where her brother died.

#### Manner:

Kristine does not feel that she is ready to command an *Enterprise* Class cruiser, but she may change her mind in the future. Although she knows that she is innocent of the charges placed against her, she still feels somewhat guilty over the loss of lives in the incident.

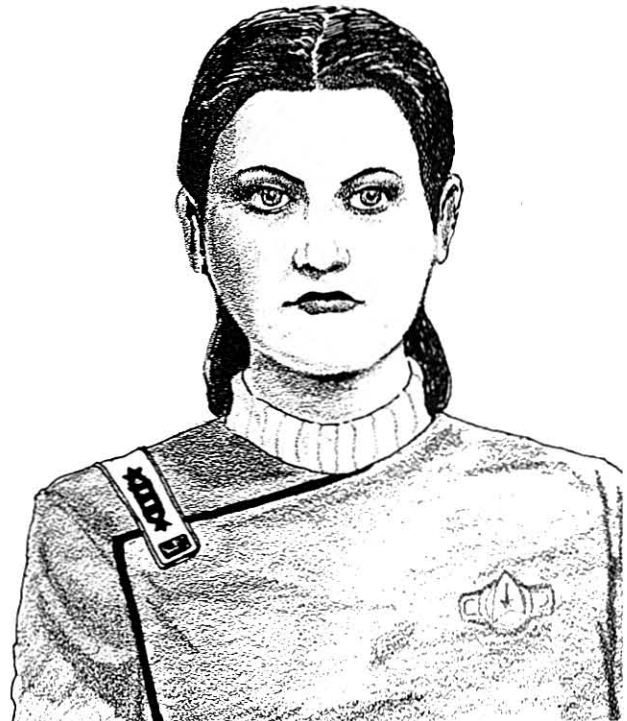

**Name:** STOAN

**Rank/Title:** Commander

**Current Assignment:** Military Operations Command  
*USS Strider, NCC 7191*

**Position:** Science Officer

**Race:** Vulcan

**Age:** 46

**Sex:** Male

**Attributes:**

STR	- 65	CHA	- 58
END	- 89	LUC	- 13
INT	- 91	PSI	- 71
DEX	- 96		

**Combat Statistics:**

To-Hit Numbers—	Bare-Hand Damage: 1D10 + 5
Modern: 53	AP: 13
HTH: 58	

**Significant Skills**

	Rating
Administration	12
Computer Operation	55
Computer Technology	38
Damage Control Procedures	19
Electronics Technology	20
Environmental Suit Operation	35
Instruction	14
Languages	
Klingonaase	34
Orion	12
Leadership	15
Life Sciences	
Botany	06
Zoology	13
Marksmanship, Modern	10
Medical Science	
General Medicine, Human	24
General Medicine, Orion	09
General Medicine, Vulcan	30
Personal Combat	
Unarmed	20
Lirpa	10
Personal Weapons Technology	06
Physical Sciences	
Chemistry	83
Computer Science	20
Mathematics	30
Physics	15
Planetary Science, Geology	22
Small Equipment Systems Operation	25
Social Sciences	
Federation Law	28
Federation Culture/History	30
Space Sciences	
Astrogation	10
Astronautics	12
Astronomy	13
Starship Sensors	49
Transporter Operation Procedures	14
Zero-G Operations	10

**Distinguishing Physical Characteristics:**

Stoan is short for a Vulcan, making him stand out in a crowd. His narrow frame makes his uniform seem almost empty at times. Oddly, his feet are many times too large for his size.

**Brief Personal History:**

*Birthplace:* Shil, Vulcan.

Cadet Cruise, Colonial Operations Command, 1 year.

Colonial Operations Command, *USS Randolph*, 3 years.

Star Base 12, 5 years.

Merchant Marines Command, 2 years.

Military Operations Command, *USS Strider*, 2 years.

At an early age, Stoan discovered that Star Fleet received much more funding than the Vulcan Science Academy did, and so it was logical to join Star Fleet to conduct scientific studies. While on the *USS Randolph*, he saved the lives of eight fellow officers in a shipboard fire. As a result, his superiors consider him a bright, quick-thinking officer with a good future. To learn more about combat tactics and administration, he was assigned to Reardon's ship.

**Personality:**

*Motivations/Desires/Goals:*

Stoan believes he should try to act like his Human counterparts, and so he is trying to develop a logical form of humor. Although his jokes lack any identifiable Human humor, the crew does appreciate his efforts.

*Manner:*

In most respects, Stoan is a typically logical Vulcan.



**Name:** THOMPSON, Jack  
**Rank/Title:** Lieutenant Commander  
**Current Assignment:** Military Operations Command,  
*USS Strider*, NCC 7141  
**Position:** Helmsman

**Race:** Alpha Centauran  
**Age:** 40  
**Sex:** Male

**Attributes:**

STR - 76	CHA - 76
END - 85	LUC - 95
INT - 69	PSI - 21
DEX - 92	

**Combat Statistics:**

To-Hit Numbers—	Bare-Hand Damage: 2D10 + 4
<i>Modern:</i> 71	AP: 13
<i>HTH:</i> 66	

**Significant Skills**

	<b>Rating</b>
Carousing	40
Computer Operation	21
Damage Control Procedures	39
Environmental Suit Operation	10
Instruction	11
Language, Orion	07
Leadership	24
Life Sciences	
Biology	06
Bionics	10
Marksmanship, Modern	50
Medical Science	
General Medicine, Human	21
Personal Combat	
Unarmed	40
Knife	23
Personal Weapons Technology	09
Physical Science, Physics	10
Planetary Science, Meteorology	11
Small Equipment Systems Operation	13
Social Sciences	
Federation Law	25
Federation Racial Culture/History	16
Space Sciences	
Astrogation	05
Astronomy	16
Starship Combat Strategy/Tactics	20
Starship Helm Operation	44
Starship Sensors	27
Starship Weaponry Operation	70
Starship Weaponry Technology	13
Transporter Operation Procedures	12
Trivia, Alcoholic Beverages	13
Zero-G Operations	10

**Distinguishing Physical Characteristics:**

Jack has a medium build, black hair, light green eyes, and a mustache. Though he is physically fit, he is beginning to get a beer belly.

**Brief Personal History:**

*Birthplace:* Dorthican Continent, Alpha Centauri.  
 Cadet Cruise, Military Operations Command, 1 year.  
 Galaxy Exploration Command, *USS Gandalf*, 2 years.  
 Military Operations Command, *USS Windride*, 5 years.  
 Military Operations Command, *USS Longsight*, 2 years.  
 Military Operations Command, *USS Strider*, 4 years.

Born to a family tied to the banking industry, Jack Thompson always wanted more out of life. After joining Star Fleet, Jack lost contact with his family. During the economic upset of Stardate 2/01, his parents' lending institution went bankrupt, and he has tried in vain to find them. Despite some marks on his record, he is considered an outstanding officer.

**Personality:**

*Motivations/Desires/Goals:*

Plagued with guilt over leaving his parents, Jack has started several projects to locate them. This guilt has helped his performance, as he wishes to show his family that he is a Star Fleet officer in good standing.

*Manner:*

Jack believes that certain things are right and certain things are wrong. Determined to do things his way or not at all, he sometimes resorts to force to get his way. He is rather impatient with others.



**Name:** DESMONAL, Lori

**Rank/Title:** Lieutenant

**Current Assignment:** Military Operations Command,  
*USS Strider*, NCC 7141

**Position:** Engineer's Mate

**Race:** Alpha Centauran

**Age:** 29

**Sex:** Female

**Attributes:**

STR	- 56	CHA	- 40
END	- 42	LUC	- 85
INT	- 39	PSI	- 42
DEX	- 59		

**Combat Statistics:**

To-Hit Numbers— Bare-Hand Damage: 1D10 +5  
*Modern: 37* AP: 9  
*HTH: 40*

**Significant Skills**

	Rating
Communication Systems Technology	13
Computer Operation	21
Computer Technology	40
Damage Control Procedures	48
Deflector Shield Technology	48
Electronics Technology	58
Instruction	10
Language, Klingonaase	03
Life Science, Biology	12
Life Support Systems Technology	10
Marksmanship, Modern	15
Mechanical Engineering	19
Medical Science	
General Medicine, Human	10
Personal Combat, Unarmed	20
Personal Weapons Technology	15
Physical Science, Mathematics	35
Planetary Science, Hydrology	10
Shuttlecraft Systems Technology	11
Small Equipment Systems Operation	25
Social Sciences	
Federation Law	20
Federation Racial Culture/History	20
Space Sciences	
Astronautics	10
Astronomy	12
Starship Sensors	10
Starship Weaponry Technology	15
Transporter Operation Procedures	10
Transporter Systems Technology	11
Warp Drive Technology	22
Zero-G Operations	31

**Distinguishing Physical Characteristics:**

A petite young lady, Lori has high cheekbones and a green streak in her light blonde hair.

**Brief Personal History:**

*Birthplace:* Tamen, Alpha Centauri.

Cadet Cruise, Colonial Operations Command, 1 year.

Galaxy Exploration Command, *USS Hood*, 3 years.

Military Operations Command, *USS Vidal*, 2 years.

Military Operations Command, *USS Strider*, 1 year.

Born to a wealthy family, Lori has always sought a purpose in life. Although she could have had anything she desired, she joined Star Fleet, hoping that it would provide her with direction and meaning. She chose to study engineering because it sounded amusing to her. However, she has found her stint with Star Fleet to be much more demanding than she expected.

**Personality:**

*Motivations/Desires/Goals:*

Recently, Jack Thompson has started to see Lori in their spare time, and she has become dedicated to him. Having a very dominant personality, Jack has done little to discourage this and uses Lori to boost his ego.

*Manner:*

Though aware that she is a weak individual, Lori makes little effort to change. She is content to be a good follower, and never makes a stand for her feelings.



**Name:** K'tril

**Rank/Title:** Lieutenant

**Current Assignment:** Military Operations Command,  
*USS Strider*, NCC 7141

**Position:** Communications Officer

**Race:** Caitian

**Age:** 31

**Sex:** Female

**Attributes:**

STR	- 66	CHA	- 20
END	- 70	LUC	- 20
INT	- 72	PSI	- 13
DEX	- 94		

**Combat Statistics:**

To-Hit Numbers—	Bare-Hand Damage: 1D10 + 7
<i>Modern:</i> 95	AP: 13
<i>HTH:</i> 67	

**Significant Skills**

	<b>Rating</b>
Administration	41
Communication Systems Operation	45
Communication Systems Technology	30
Computer Operation	20
Computer Technology	10
Damage Control Procedures	10
Environmental Suit Operations	10
Instruction	33
Language, Klingonaase	20
Leadership	50
Life Science, Bionics	07
Marksmanship, Modern	95
Medical Science	
General Medicine, Caitian	25
General Medicine, Human	20
Personal Combat	
Unarmed	40
Dagger	12
Personal Weapons Technology	10
Physical Science, Physics	10
Planetary Science, Geology	09
Small Equipment Systems Operation	20
Social Sciences	
Federation Law	20
Federation Culture/History	20
Klingon Culture/History	12
Space Science, Astronomy	10
Starship Sensors	10
Transporter Operation Procedures	10
Zero-G Operations	08

**Distinguishing Physical Characteristics:**

K'tril is a large Caitian female with white highlights in her golden fur. She keeps her nails at regulation length and paints them gold.

**Brief Personal History:**

*Birthplace:* Shaduma, Samar.

Cadet Cruise, Galaxy Exploration Command, 1 year.

Galaxy Exploration Command, *USS Enterprise*, 3 years.

Star Base 9, 4 years.

Military Operations Command, *USS Strider*, 2 years.

Life on the Caitian colony world of Samar did not suit K'tril. Wanting to help others, she joined Star Fleet. Her family disowned her because of her career choice, which disturbs her a great deal.

**Personality:**

*Motivations/Desires/Goals:*

K'tril feels that her whole life has been spent in search of something else. Although Star Fleet has fulfilled some of her needs, she still feels that there must be something else in life. She yearns to prove to her family that she is doing what she must do, and that Star Fleet is not an evil but a good and necessary organization.

*Manner:*

K'tril spends most of her spare time reading and meditating. She is very quiet and pacifistic for a Caitian.



## OUTPOST PERSONNEL

**Name:** HARMONSON, Bram

**Rank/Title:** Commodore

**Current Assignment:** Federation Defense Outpost 1121,  
Special Assignment

**Position:** Acting Spokesperson, Star Fleet Command

**Race:** Human/Klingon Fusion

**Age:** 52

**Sex:** Male

### Attributes:

STR	- 79	CHA	- 71
END	- 72	LUC	- 20
INT	- 86	PSI	- 22
DEX	- 69		

### Combat Statistics:

To-Hit Numbers—	Bare-Hand Damage: 2D10 + 6
Modern: 62	AP: 10
HTH: 68	

### Significant Skills

	Rating
Administration	50
Computer Operation	54
Damage Control Procedures	23
Environmental Suit Operation	30
Instruction	20
Languages	
Klingonaase	78
Romulan	40
Vulcan	13
Leadership	43
Life Science, Botany	10
Marksmanship, Modern	55
Medical Science	
General Medicine, Human	10
Psychology, Romulan	10
Personal Combat, Unarmed	67
Personal Weapons Technology	12
Physical Science, Physics	13
Planetary Science, Meteorology	20
Security Procedures	57
Shuttlecraft Pilot	21
Small Equipment Systems Operation	31
Small Unit Tactics	20
Social Sciences	
Federation Law	34
Federation Culture/History	15
Romulan Culture/History	10
Space Sciences	
Astronomy	15
Astrophysics	12
Starship Sensors	10
Transporter Operation Procedures	40
Zero-G Operations	28

### Distinguishing Physical Characteristics:

Bram is tall with a dark complexion, jet black hair, and a very powerful build. On his left shoulder is a deep scar from a disruptor. Bram claims that he received the wound as a child when Klingons attacked his outpost home.

### Brief Personal History:

*Birthplace:* Zannadu IV

Cadet Cruise, Military Operations Command, *USS Slashstar*, 1 year.

Military Operations Command, *USS Minotaur*, 5 years.

Military Operations Command, *USS Stalker*, 6 years.

Star Fleet Intelligence Command, Classified, 18 years.

Bram is the result of a Klingon genetic experiment. Totally devoted to the *komerex*, he joined Star Fleet and climbed through the ranks using some of his Klingon contacts, the most important being Admiral Kai.

Star Fleet has decorated Bram Harmonson many times. As he has taken assignments with no possibility of fighting Klingons, he has spent a great deal of time on the Romulan front. He is one of the few Security Officers that has ever risen to such a high position.

### Personality:

*Motivations/Desires/Goals:*

Despite all appearances, Bram is dedicated to the Klingon Empire. He has used Star Fleet officers to do his and the Empire's bidding, but he has never exposed himself. Although he has smuggled valuable documents to the Klingons, he holds back the most important documents for 'insurance'. His devious plans have never backfired.

*Manner:*

Bram seems to be the perfect Commodore. Confident and always in command, he is very easy-going, but always speaks professionally.





**Name:** CURTIS, Carl  
**Rank/Title:** Captain  
**Current Assignment:** Military Operations Command  
 Defense Outpost 1121  
**Position:** Commanding Officer

**Race:** Human  
**Age:** 49  
**Sex:** Male

**Attributes:**

STR — 68      CHA — 61  
 END — 80      LUC — 12  
 INT — 62      PSI — 12  
 DEX — 56

**Combat Statistics:**

To-Hit Numbers— Bare-Hand Damage: 1D10 + 5  
*Modern:* 36                      AP: 9  
*HTH:* 38

Significant Skills	Rating
Administration	45
Communication Systems Operation	40
Communication Systems Technology	12
Computer Operation	36
Computer Technology	12
Damage Control Procedures	48
Environmental Suit Operation	10
Instruction	25
Language, Tellarite	15
Leadership	12
Life Science, Ecology	10
Marksmanship, Modern	15
Medical Science	
General Medicine, Human	22
Personal Combat, Unarmed	20
Personal Weapons Technology	09
Physical Science, Computer Science	11
Planetary Science, Geology	12
Small Equipment Systems Operation	13
Social Sciences	
Federation Law	36
Federation Culture/History	23
Klingon Culture/History	22
Tellarite Culture/History	30
Space Science, Astronomy	21
Starship Sensors	45
Transporter Operation Procedures	30
Zero-G Operations	16

**Distinguishing Physical Characteristics:**

Carl Curtis is a short man whose weight is almost against regulation. What little remains of his hair is prematurely grey. He has high cheekbones and a squeaky voice.

**Brief Personal History:**

*Birthplace:* Ireland, Terra.  
 Cadet Cruise, Merchant Marines Command, 1 year.  
 Star Base 10, 6 years.  
 Galaxy Exploration Command, *USS Maxrix*, 2 years.  
 Star Base 11, 5 years.  
 Star Base 12, 7 years.  
 Galaxy Exploration Command, *USS Windfall*, 1 year.  
 Military Operations Command, Federation Defensive Outpost 1121, 5 years.

With dreams of becoming an Admiral, Carl Curtis joined Star Fleet. Although he has spent only a small portion of his career on a ship, he wants to captain a ship-of-the-line. During a performance review, he struck a superior officer who told him that he was not promotable.

**Personality:**

*Motivations/Desires/Goals:*

Curtis dislikes Captain Reardon because she was recommended for a major command and he was not even considered. He lies to other officers, telling them that he turned down a ship command to remain in command of the Defense Outpost. Few believe him.

*Manner:*

A paranoid man, Carl Curtis thinks that everyone in Star Fleet is trying to keep him from getting a ship command. Unable to control his temper, he has even struck fellow officers, though no one has yet filed charges.



**Name:** DAVIDSON, Gordon

**Rank/Title:** Commander

**Current Assignment:** Military Operations Command,  
Defense Outpost 1121

**Position:** Chief Engineer

**Race:** Human

**Age:** 55

**Sex:** Male

**Attributes:**

STR	- 54	CHA	- 21
END	- 67	LUC	- 40
INT	- 80	PSI	- 21
DEX	- 90		

**Combat Statistics:**

To-Hit Numbers—	Bare-Hand Damage: 1D10 + 7
Modern:72	AP:13
HTH:72	

**Significant Skills**

	Rating
Administration	49
Communication Systems Technology	25
Communication Systems Operation	80
Computer Operation	56
Computer Technology	34
Damage Control Procedures	43
Deflector Shield Technology	89
Electronics Technology	40
Environmental Suit Operation	09
Instruction	32
Leadership	44
Life Science, Botany	07
Language, Tellarite	16
Life Support Systems Technology	39
Marksmanship, Modern	44
Mechanical Engineering	67
Medical Science	
General Medicine, Human	22
Personal Combat, Unarmed	44
Personal Weapons Technology	12
Small Equipment Systems Operation	56
Physical Sciences	
Chemistry	20
Physics	23
Shuttlecraft Systems Technology	70
Social Sciences	
Federation Law	15
Federation Culture/History	20
Space Sciences	
Astronautics	25
Astronomy	10
Starship Sensors	40
Starship Weaponry Technology	41
Transporter Operation Procedures	78
Transporter Systems Technology	66
Warp Drive Technology	38
Zero-G Operations	50

**Distinguishing Physical Characteristics:**

Gordon is fat, almost overweight by Star Fleet standards. His uniforms are dirty, ill-kept, and sometimes stained with a recent meal.

**Brief Personal History:**

*Birthplace:* Daraniss, Daran V.

Cadet Cruise, Merchant Marines Command, 1 year.

Galaxy Exploration Command, *USS Stanford*, 4 years.

Star Base 3, 2 years.

Military Operations Command, *USS Tir*, 4 years.

Star Base 5, 7 years.

Colonial Operations Command, 2 years.

Military Operations Command, Star Base 11, 3 years.

Galaxy Exploration Command, *USS Windsor*, 3 years.

Military Operations Command, Defense Outpost 1121,

8 years.

Gordon joined Star Fleet because no one else would take him.

Although he is a talented engineer, his disregard for authority has shuffled him from one post to another. Eventually, he was dropped in the far-off Defense Outpost 1121. There, he has done nothing but bump heads with Captain Curtis, who has tried in vain to have him transferred.

**Personality:**

*Motivations/Desires/Goals:*

Gordon lives from day to day, indifferent to Star Fleet orders and expectations. Though he does enjoy being an engineer and shows some talent for it, he cannot work well within the Star Fleet system.

*Manner:*

Gordon does not care about anyone but himself. Although he has been considering leaving the Fleet, he is too lazy to do so. One of his commanding officers commented that he had the table manners of a spoiled Tellarite.



**Name:** 'CHU, Hung  
**Rank/Title:** Lieutenant Commander  
**Current Assignment:** Military Operations Command,  
 Defense Outpost 1121  
**Position:** Security Chief

**Race:** Human  
**Age:** 30  
**Sex:** Male

**Attributes:**

STR - 70	CHA - 69
END - 88	LUC - 10
INT - 65	PSI - 30
DEX - 90	

**Combat Statistics:**

To-Hit Numbers— Bare-Hand Damage: 1D10 + 8  
*Modern:* 79 AP: 13  
*HTH:* 70

Significant Skills	Rating
Administration	45
Computer Operation	21
Damage Control Procedures	13
Environmental Suit Operation	25
Instruction	32
Language, Tellarite	17
Leadership	33
Life Science, Bionics	30
Marksmanship, Modern	68
Medical Science	
General Medicine, Human	38
Psychology, Human	16
Personal Combat, Unarmed	50
Personal Weapons Technology	33
Physical Science, Mathematics	12
Planetary Science, Geology	10
Security Procedures	48
Shuttlecraft Pilot	60
Small Equipment Systems Operation	23
Small Unit Tactics	30
Social Sciences	
Federation Law	46
Federation Culture/History	21
Political Science	24
Space Science, Astronomy	09
Starship Sensors	12
Transporter Operation Procedures	43
Trivia, 21st Century Terran Poets	13
Zero-G Operations	22

**Distinguishing Physical Characteristics:**

Hung is stout with dark, penetrating eyes and long black hair. He has a number of scars from fights that he has either broken up or started himself. As he is very proud of these scars, he is likely to show them off to anyone who asks about them.

**Brief Personal History:**

**Birthplace:** Biro, Dinil.  
 1st Cadet Cruise, Military Operations Command, 1 year.  
 2nd Cadet Cruise, Merchant Marines Command, 1 year.  
 Military Operations Command, *USS Thranstor*, 4 years.  
 Military Operations Command, Defense Outpost 1121,  
 3 years.

Hung 'Chu comes from a large family on Dinil. He has ten brothers and sisters in the Fleet, and all look up to him as the most successful member of the family. He begs to differ—most of his assignments have been in minor and remote locales. Hung feels that his talents are wasted guarding the base supply of drill bits, and is striving for a post on a ship-of-the-line.

**Personality:**

**Motivations/Desires/Goals:**

Hung wants to be a great leader, but his posts have denied him the opportunity. Even though he has a higher rank than any of his brothers or sisters, they have had far more exciting assignments.

**Manner:**

Though rather self-centered, Hung is very good at his job. He can usually beat the goals that his commanders set for him. He does not care for Captain Curtis, but he does what he is told.



**Name:** HOPPLEMEYER, Ralph

**Rank/Title:** Lieutenant

**Current Assignment:** Military Operations Command,  
Defense Outpost 1121

**Position:** Ship Repair Specialist

**Race:** Human

**Age:** 33

**Sex:** Male

**Attributes:**

STR	- 39	CHA	- 55
END	- 48	LUC	- 87
INT	- 97	PSI	- 40
DEX	- 87		

**Combat Statistics:**

To-Hit Numbers—	Bare-Hand Damage: 1D10 + 2
Modern: 59	AP: 11
HTH: 54	

**Significant Skills**

	Rating
Administration	09
Communication Systems Technology	12
Computer Operation	20
Computer Technology	15
Damage Control Procedures	14
Deflector Shield Technology	38
Electronics Technology	47
Instruction	10
Language, Deltan	09
Marksmanship, Modern	30
Life Science, Bionics	45
Life Support Systems Technology	13
Mechanical Engineerings	88
Medical Science	
General Medicine, Human	20
Personal Combat, Unarmed	20
Personal Weapons Technology	10
Physical Science, Physics	40
Planetary Science, Geology	07
Shuttlecraft Systems Technology	15
Small Equipment Systems Operation	29
Social Sciences	
Federation Law	15
Federation Culture/History	15
Space Sciences	
Astronautics	12
Astronomy	10
Starship Sensors	10
Starship Weaponry Technology	13
Transporter Operation Procedures	11
Transporter Systems Technology	15
Trivia, Plastic Models	66
Warp Drive Technology	59
Zero-G Operations	10

**Distinguishing Physical Characteristics:**

Ralph is tall and so skinny, that his clothing seems to hang on his narrow frame. As Retinax S treatment could not correct his poor eyesight, he wears glasses.

**Brief Personal History:**

*Birthplace:* Ardana

At the age of four, Ralph was working hard on his toy electrical set. Since then, he has worked hard to realize his dream of becoming an engineer. After college, instead of taking one of many outstanding corporate offers, he joined Star Fleet so that he could work on *real* engines—warp engines.

Considered a genius, Ralph was temporarily assigned to Defense Outpost 1121 for some repair work. When he accidentally spilled hot coffee on Captain Curtis, however, he suddenly found himself transferred to the base permanently. Because of the incident, Curtis has not let up on the man and has passed him up several times for promotion and transfer.

**Personality:**

*Motivations/Desires/Goals:*

As long as Ralph is allowed to work in engineering, he is happy. He has developed a hate for Captain Curtis and will do anything to bother the man. Once he rigged Curtis's entertainment system to overload, just for grins.

*Manner:*

Though a genius, Ralph is absent-minded and forgetful. He is a loyal, devoted friend.



## KLINGONS

**Name:** KAI, zantai-Mik  
**Rank/Title:** Admiral  
**Current Assignment:** 10th Frontier Sector  
**Position:** Governor

**Race:** Imperial Klingon  
**Age:** 49  
**Sex:** Male

### Attributes:

STR	- 79	CHA	- 34
END	- 78	LUC	- 06
INT	- 86	PSI	- 09
DEX	- 66		

### Combat Statistics:

To-Hit Numbers—	Bare-Hand Damage: 2D10 + 7
Modern: 67	AP: 10
HTH: 68	

Significant Skills	Rating
Administration	46
Computer Operation	61
Computer Technology	12
Communication Systems Technology	49
Interrogation	55
Languages	
Galacta	70
Romulan	12
Leadership	60
Negotiation/Diplomacy	78
Personal Combat	
Unarmed	70
Dagger	56
Marksmanship, Modern	68
Social Sciences	
Federation Law	55
Federation Culture/History	67
Klingon Law	88
Klingon Culture/History	67
Starship Combat Strategy/Tactics	50

### Distinguishing Physical Characteristics:

This Imperial Klingon has a mustache but no beard. In his right boot, he always carries a dagger. His eyes are deep and penetrating.

### Brief Personal History:

*Birthplace:* Gnuu Re

Kai has lived up to his family's hopes and aspirations. Before being reassigned as a regional governor, he participated in several of the more successful raids into Romulan space.

The Admiral has made good use of his Federation spies and agents, including Bram Harmonson. He believes that the Empire comes first, and he comes a close second. As the only individual who knows that Harmonson is an agent, he is one of the few Klingons who ever see the information that Bram sends to the Empire.

### Personality:

*Motivations/Desires/Goals:*

Admiral Kai has hopes beyond his border governorship. He seeks a regional office and later an Imperial one, but first, he must prove himself at the lower levels. At times, he hates his life as a governor, wishing to return to active fighting duty.

*Manner:*

The Admiral is sly and devious. Believing the Tasor system to be his key to getting off the border, he ordered the death of the ambassador and took his place.

**Name:** TASIN sutai-Pallara  
**Rank/Title:** Captain  
**Current Assignment:** Imperial Security,  
Imperial Court  
**Position:** Advisor

**Race:** Imperial Klingon  
**Age:** 54  
**Sex:** Male

### Attributes:

STR	- 88	CHA	- 76
END	- 91	LUC	- 28
INT	- 91	PSI	- 20
DEX	- 80		

### Combat Statistics:

To-Hit Numbers—	Bare-Hand Damage: 2D10
Modern: 75	AP: 12
HTH: 74	

Significant Skills	Rating
Administration	67
Computer Operation	45
Communication Systems Technology	54
Interrogation	60
Language, Galacta	69
Leadership	70
Marksmanship, Modern	69
Negotiation/Diplomacy	58
Personal Combat, Unarmed	68
Social Sciences	
Federation Law	15
Federation Culture/History	50
Klingon Culture/History	56
Romulan Culture/History	12
Starship Combat Strategy/Tactics	58

### Distinguishing Physical Characteristics:

Short for an Imperial Klingon, Tasin also has a stout frame. He has thick, powerful arms and legs, and no facial hair.

### Brief Personal History:

*Birthplace:* Talida

Born to the powerful Pallara line, Tasin rose through the ranks quickly. As a captain, he has led several official and unofficial raids into the Romulan Empire. He was even called to the Imperial Throne to be decorated for his actions. Because of his favored status, he was allowed to keep his birth name (fleet officers almost always adopt first names beginning with "K"). While at the palace, Tasin personally saved the life of the Emperor during an attempted overthrow. For his actions, he was given a position on the Imperial Court.

In the past few years, his position has been weakening, and Menjin sutai-Mik is making moves to take his position. Thus, he has begun efforts to discredit the Mik line.

### Personality:

*Motivations/Desires/Goals:*

Tasin's chief goal is to discredit the entire Mik line. When he happens across the *Strider*, he discovers Admiral Kai's plan and learns that Kai's spy must be on the Outpost. To get the goods on Kai, he decides that capturing the spy is more important than capturing the Federation officers, whom he releases to cover his approach to the Outpost.

*Manner:*

For a Klingon officer, Tasin shows a great deal of patience. He is extremely anxious to protect his position.

# GAMEMASTER'S NOTES

## TIMELINE

The following timeline will provide the gamemaster with some insight into the events of **The Strider Incident**:

### **Stardate 1/6601**

As part of a Human-Fusion experiment, Kailla Mishka is born. His genetic structure is so similar to a Human's that it is impossible to tell the two apart.

### **Stardate 1/6811**

Kailla Mishka is brought to the Imperial Throne, where he is given a mission that will take a lifetime to fulfill. He will be taken to the Federation to assume the identity of a Human, to infiltrate Star Fleet, and to learn all that he can concerning the Federation.

### **Stardate 1/7112**

Klingons attack the Human colony on the planet Zannadu IV within the area of space called the Triangle. All of the colonists are killed, and Kailla is transported there to take on the identity of one of the slain children. He becomes Bram Harmonson.

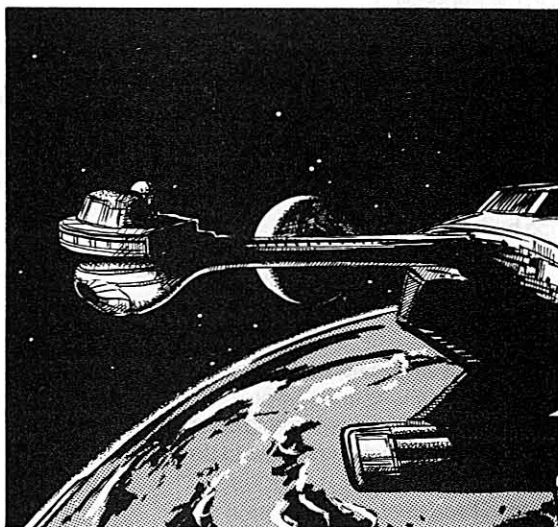

### **Stardate 1/7202**

Forces from the Federation rescue Bram/Kailla. According to the colony's charter, the sole survivor (Bram) is entitled to all assets of the dead colonists. At a young age, Bram becomes very wealthy.

### **Stardate 1/8309**

Bram is accepted as a cadet at Star Fleet Academy.

### **Stardate 1/8805**

Upon graduation with honors from the Academy, Bram is assigned to the *USS Washington*. He is awarded the Star Fleet Citation of Merit for actions during his first tour of duty.

### **Stardate 1/9409**

The Four Years War begins. Bram is assigned to security on the *USS Constitution* and avoids most of the military actions. At this time, he begins sending some of his information to his contact, Captain Kai sutai-Mik of the Imperial Klingon Navy.

### **Stardate 2/0208.09**

For her daring and bravery in the Four Years War, Kristine Reardon is assigned to patrol duty along the Klingon border. Within five months, her ship's captain is killed in an attack by a raiding party, and Kristine assumes the Captain's chair. Her subsequent actions win her the Grankite Order of Heroism.

### **Stardate 2/0503**

Captain Kai sutai-Mik provides Captain Harmonson with information on Romulan activities near the Federation border. During the same year, Bram is given command of his first vessel, the *USS Ironclad*, and is assigned to patrol the Romulan border.

### **Stardate 2/1512.08**

With information from Captain Kai, the *Ironclad* manages to catch several Romulan raiding vessels in Federation space. For his daring and bravery, Bram is promoted to Commodore and awarded the Medal of Valor.

### **Stardate 2/1601.11**

Officer selections begin for the *Yamato* and the *Lexington*, which are under construction. Captain Kris Reardon is offered the command of the *Yamato*, but turns it down to remain working along the Organian Neutral Zone. She is given command of the *Strider*. Carl Curtis is not considered for the command of the *Enterprise* Class ships.

### **Stardate 2/1705.02**

Commodore Harmonson receives a list of Romulan agents in the Triangle area from Klingon Imperial Intelligence.

### **Stardate 2/1705.11**

Commodore Harmonson is responsible for breaking the Romulan spy ring in the Triangle. As a reward, he is given the post of Star Fleet Diplomatic Attache. He secretly contacts Kai zantai-Mik, and they discuss how the Klingons can gain control of the Tazor system. Harmonson decides to lure Federation ships into Klingon space to convince the Organians of the Federation's aggressiveness. Imperial Intelligence gives him full discretion.

### **Stardate 2/1802**

The *USS Lexington* begins its shakedown cruise.

### **Stardate 2/1808.10**

Bram Harmonson sends a Code Red 1-A Command to the *Strider*, which executes her wartime orders.

### **Stardate 2/1808.13**

The *Strider* enters the Klingon Empire.

### **Stardate 2/1808.21**

The *Lexington* battles pirate vessels operating near the Organian Neutral Zone. At the same time, the *Strider* and Task Force 13 encounter a Klingon battle group under the command of Admiral Kai zantai-Mik. Task Force 13 is decimated, and only the *Strider* escapes destruction.

### **Stardate 2/1808.28**

The *Strider* returns to Federation Defense Outpost 1121. Captain Reardon is arrested for treason.

### **Stardate 2/1809.01**

The *Lexington* arrives at Outpost 1121 for repairs to her warp engines.

## MECHANICS OF PLAY

This section provides hints for running and judging the player characters and their actions.

### PLAYER CHARACTER SELECTION

The *Strider Incident* is designed for eight players. However, if there are fewer than eight players, refer to the suggestions below for the recommended groups of characters. If the players desire, they may choose other characters than the ones suggested. Naturally, they may also play their own characters at the gamemaster's discretion. The gamemaster should roleplay any *Lexington* officers that will not be played by the players. They will need all the help they can get.

Three Players: First Officer, Chief Engineer, Chief Helmsman.

Four Players: First Officer, Chief Engineer, Chief Helmsman, Chief Medical Officer.

Five Players: First Officer, Chief Engineer, Chief Helmsman, Chief Medical Officer, Chief Science Officer.

Six Players: First Officer, Chief Engineer, Chief Helmsman, Chief Medical Officer, Chief Science Officer, Chief Communications Officer.

Seven Players: First Officer, Chief Engineer, Chief Helmsman, Chief Medical Officer, Chief Science Officer, Chief Communications Officer, Chief Navigator.

Eight Players: First Officer, Chief Engineer, Chief Helmsman, Chief Medical Officer, Chief Science Officer, Chief Communications Officer, Chief Navigator, Chief Security Officer.

### JUDGING ACTION

This section presents victory conditions for the players. Judge the group's overall performance based on the total number of points obtained.

### VICTORY POINT ALLOCATION TABLE

Modifier	Condition
+5	Looking into the personnel records of the crew involved with the incident.
	Finding the coded transmission being broadcast to the Klingon booster satellite.
+10	Finding the Captain's bars in Lieutenant Davial's quarters.
	Returning the Klingon booster satellite parts to the Federation.
+15	Checking to see who has access to the Priority Commands.
	Stealing the <i>Strider</i> successfully.
	Listening to the <i>Strider's</i> former crew and their plans.
+20	Guarding Captain Reardon without orders to do so.
	Meeting with Captain Reardon.
+30	Saving the life of Captain Reardon during the attack.
	Looking over Captain Reardon's copy of the <i>Strider's</i> log.
+40	Meeting with Captain Tasin and getting the log buoy.
+50	Checking to see if someone tampered with the Priority Commands Backup Tape.
	Discovering that Commodore Harmonson sent the Task Force to its death.
-10	Following each false rumor for more than 2 hours.
	Neglecting to gather pieces of the booster satellite.
-20	Failing to intercept the coded message being broadcast to the booster satellite.
	Per person harmed during the <i>Strider's</i> escape attempt.
-30	Checking the backup copy of the Priority Commands only when ordered to do so.
-35	Watching the cell where Captain Reardon is being held only when ordered to do so.
	Making any attacks on Klingon personnel.
-40	Recommending that the <i>Strider</i> should fire on the <i>Bloodsteel</i> .
-50	Firing on the <i>Lexington</i> or the base during the <i>Strider's</i> escape.
-60	Accusing Captain Curtis of being the person who lured the Task Force to its death.
-150	Proving with the log buoy that Captain Curtis sent the Task Force to its death.

### RESULTS

280+	Decisive Victory Citations awarded to the characters involved.
200 to 279	Strategic Victory Characters receive neither citations nor reprimands.
150 to 199	Marginal Victory Characters are reprimanded for their actions.
-1 to 149	Marginal Loss Characters court-martialed, but found innocent. Tasor Major system remains up for grabs.
-180 to -151	Strategic Loss Characters court-martialed and found guilty. Tasor Major system lost to the Klingons.
Less than -181	Decisive Loss Characters found guilty, stripped of all rank, and sentenced to prison. Tasor Major system lost to Klingons, and the Federation border is redefended at a cost of billions.

## SPECIAL CONSIDERATIONS

The gamemaster should present this adventure as a whodunnit. According to the player's personalities, however, he may emphasize the adventure's action or investigation. Below are hints for adding color to the game to make it even more challenging for the players.

### PRESSURE

Pressure is the key to running this scenario successfully. The gamemaster should keep the tension high and have the players thinking that everyone is guilty. Commodore Harmonson plans to mislead the player characters into thinking that Captain Curtis is responsible for ordering the Task Force into Klingon space. The gamemaster can implicate Curtis even further by playing him as arrogantly as possible. However, if Curtis seems too obvious a culprit, the players will automatically assume he is innocent. Balance Curtis's arrogance by casting suspicion on Gordon Davidson, the Outpost's Chief Engineer, and Hung 'Chu, the Outpost's Chief Security Officer.

The adventure's high pressure point occurs when the players' group is rescuing Captain Reardon and fleeing the Outpost. Curtis's grilling of the player characters is intended to make them squirm. As the clock ticks closer to the rendezvous time, they will become increasingly frustrated, and the gamemaster should draw the interrogation out as long as possible. When the player characters finally rescue Captain Reardon, her drugged condition will slow them down even further. As they drag her to the *Strider*, any Outpost personnel that they encounter will likely give them heart seizures.

### GAMEMASTERING NPCs

Some other areas that can increase the players' enjoyment of the game include the effective use of NPCs. Adding Ralph Hopplemeyer to the *Strider* crew will reinforce the players' opinion of Curtis's poor leadership. Play Ralph as a happy-go-lucky stowaway who is not at all perturbed at this unexpected jaunt into Klingon space.

The Klingons are working their own power games beyond the scope of the adventure. They are not bloodthirsty animals, but very serious manipulators. Although the player characters may be surprised that Captain Tasin lets them go, characters who know something about the *komerex zha* should realize that Tasin is up to something. Play the Klingons as manipulative and untrustworthy, always having ulterior motives.

The gamemaster can use Jack Thompson deviously. Jack's record shows that he is a troublemaker with a total lack of respect for authority. Use him to lure the player characters down wrong paths. For example, Jack will insist on attacking the Klingons in the Stogar system. As Captain Tasin's waiting game grates on his nerves, he will offer silly suggestions, such as trying to beam aboard the *Bloodsteel* to take it over, or kidnapping the Captain when he comes to the *Strider*. Jack should offer plenty of suggestions to the player characters. Most of the time, these should be way off the mark.

### RUMORS

There is a 75 percent chance for each player character on the Outpost to hear a rumor concerning the *Strider* incident. Roll once for each player character after they have dinner with Captain Curtis. To discover which rumor they discover, roll percentile dice and consult the table below. After each result is an indicator determining whether or not the rumor is true.

### FLOATING RUMORS

Die Roll	Result
1-25	Captain Curtis has a grudge against Kris Reardon. (True)
26-29	When Kris Reardon was a child, her brother was killed in a Klingon attack. (True)
30-35	The Klingon Empire is planning a counterattack for the attack from Task Force 13. (False)
36-45	Star Fleet is planning to release Kris Reardon for lack of evidence. (False)
46-55	Some Outpost personnel who had relatives in Task Force 13 are planning to make sure that Kris Reardon does not live to face a court martial. (True)
55-60	A Federation task force is moving into this area to deter a possible Klingon attack. (False)
60-65	The <i>USS Lexington</i> needs repairs because a Klingon task force attacked it. (False)
66-70	Captain Reardon has lost her grip on reality and is being held for psychology reasons. (False)
70-79	Several members of the <i>Strider</i> crew are planning to spring Kris Reardon and to steal a ship to escape. (Partially True)
80-85	There are Klingon agents operating out of the Outpost. (True)
86-93	Kristine Reardon is a Klingon agent trying to start a war between the Empire and the Federation. (False)
94-100	Someone in Star Fleet is making Kristine Reardon a scapegoat for the invasion of Klingon space. (True)

Smart players can easily dispel the bulk of these rumors. Checking fleet movements shows that no Federation task force is moving into the area, and recent intelligence reports show no increase of Klingon forces near the Neutral Zone. The true and the partially true rumors are designed to steer the player characters toward the right track without telling them exactly what they are up against.



## ACTUAL LOG ENTRIES

The real entries from the *Strider's* log are presented below for the gamemaster's reference. When Captain Tasin delivers the log buoy to the players' group, the gamemaster may read or hand the following messages to them.

"Message incoming, Code Red 1-A to Commander of Task Force 13. Execute your Emergency War Orders. The United Federation of Planets has declared war on the Klingon Empire. Star Fleet Command orders your force to depart for the Stogar system. Enemy forces must not know your movements. You are to engage and destroy any and all enemy forces until Task Force 19 links up with your force. All communications are silenced."

Captain Reardon's message to the other members of Task Force 13 is as follows:

"I have received a Code Red 1-A Command from Star Fleet Command. We are ordered to proceed to the Stogar system to attack and link up with another Federation battle group. All ships are to maintain communications silence and increase internal security. I accept full responsibility for this Task Force and our current situation. You will follow my orders, as per your Emergency War Commands. Any violations of these orders will be punishable, as per Star Fleet Regulations XIXA-F. With luck, the deaths of millions of Federation citizens can be prevented by following our proper commands at this time of great need. Captain Reardon out."

## FURTHER ADVENTURES

The characters that escaped from the Outpost at the end of the adventure, Admiral Mik and Commodore Harmonson, are still free. Rumors could lead the player characters on a mission to find them, perhaps with the help of Captain Reardon and some of her crew. After all, Reardon despises Klingons already, and she is sure to want revenge on the Klingons who set her up.

The Commodore is likely to have many friends and allies who will still support him. Some could be planetary governors, and others might be high-ranking officials in Star Fleet. Perhaps Harmonson will seek their aid and hide with them. Alternatively, he and the Admiral may join the Imperial Klingon states or hide elsewhere in the Triangle. If the player characters wish to follow this tack, the gamemaster should consult **The Triangle** supplement. Characters from the **Trader Captains and Merchant Princes** supplement can help the player characters bring the two Klingons to justice, leading them to many worlds and adventures. In addition, Star Fleet may cover up the fact that the Commodore was a spy, and the player's group might have to defy the authorities in order to prove the truth.

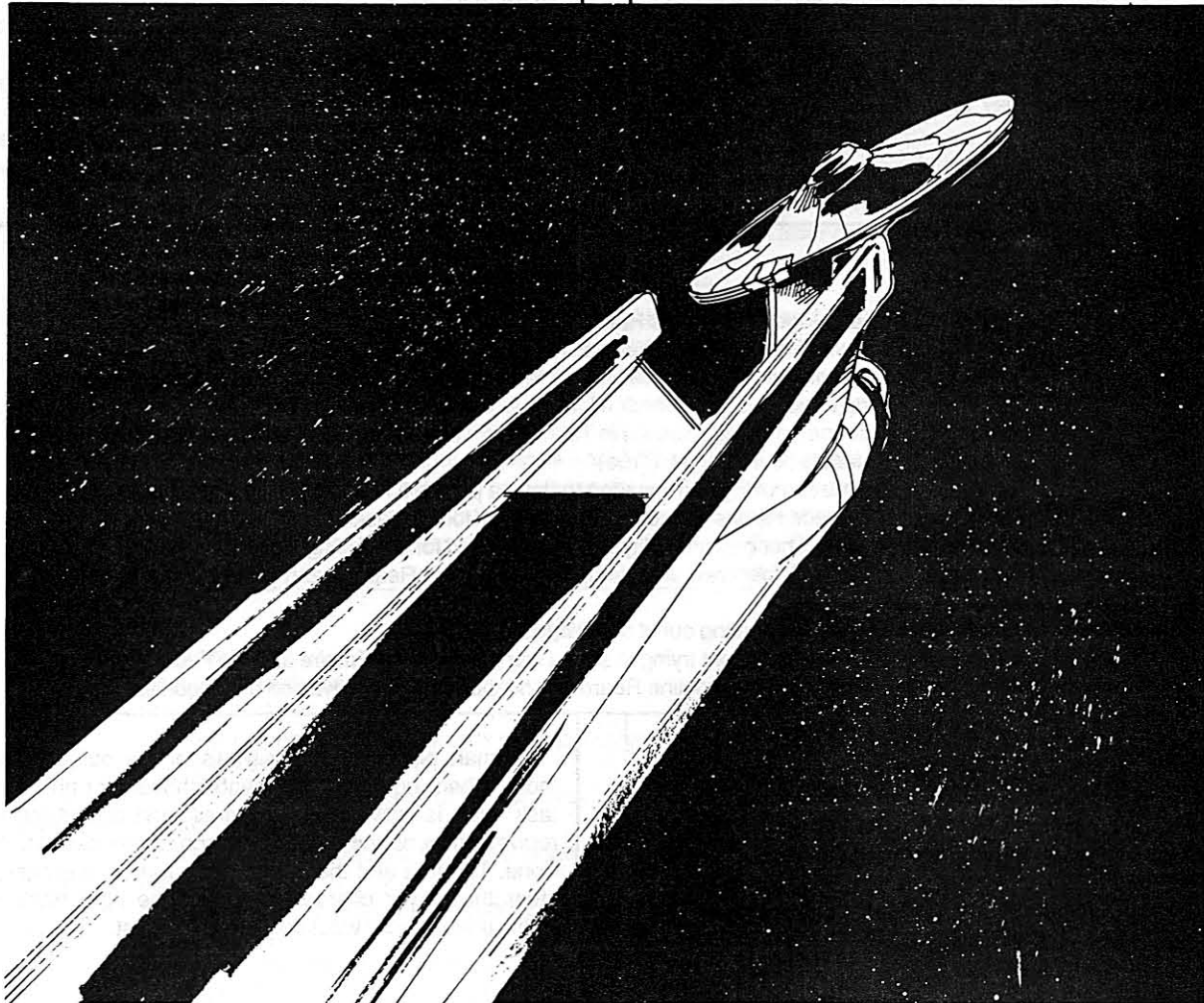

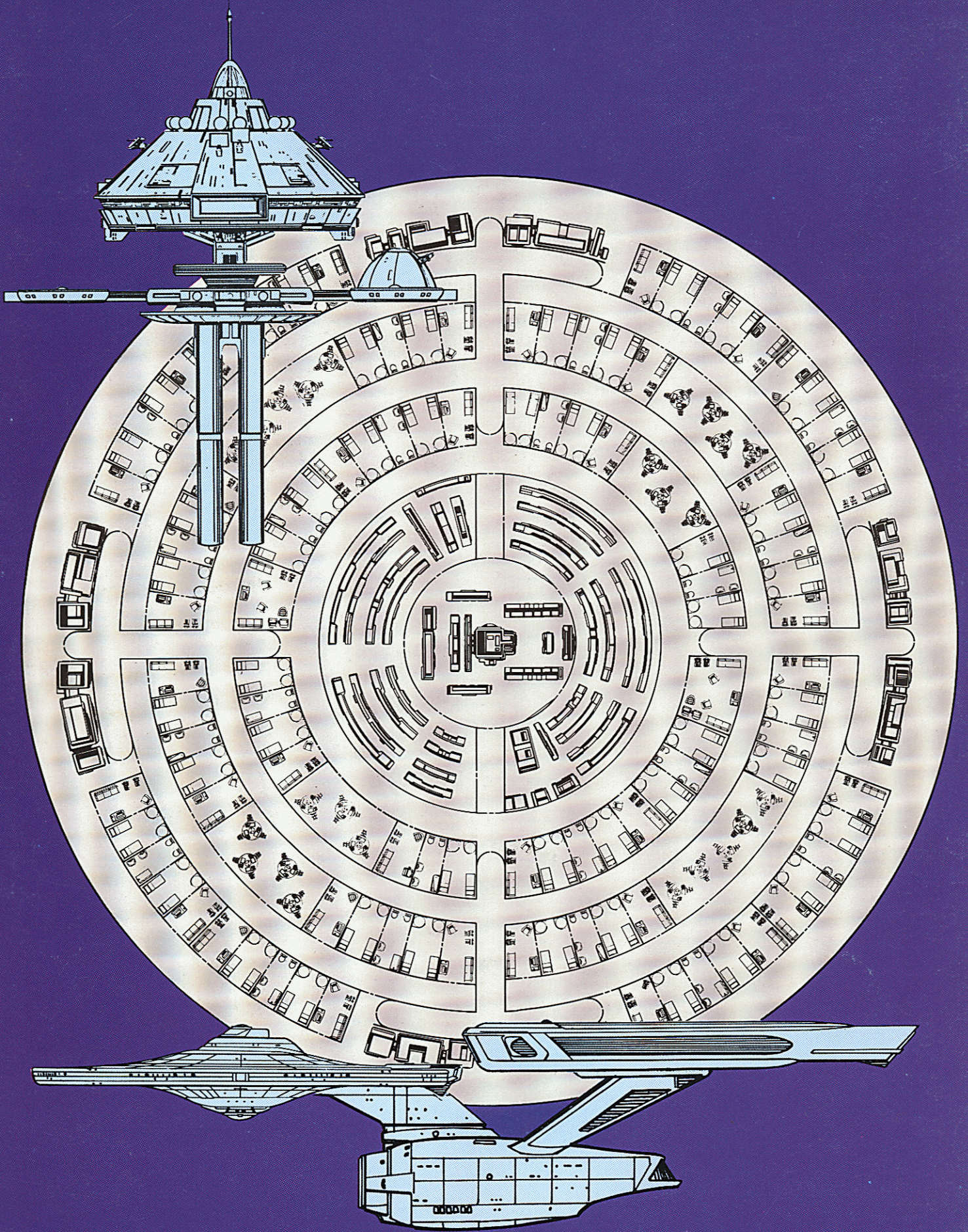

# REGULA-1

## ORBITAL STATION DECKPLANS

A supplement for use with  
**STAR TREK**  
 THE ROLE PLAYING GAME



### CREATE YOUR OWN ADVENTURES ABOARD THE REGULA-1

The *Regula-1 Orbital Station Deckplans* contain extensive blueprints and room descriptions of the *R-1* Type station, as seen in **STAR TREK II: The Wrath of Khan**. Also included are the *R-1* station's history, descriptions of its eight variants and support craft, and a list of all stations in operation. While running **The Strider Incident**, the gamemaster should use this book to keep track of action aboard Defense Outpost 1121.

**FASA**  
 CORPORATION

# **REGULA-1**

## **ORBITAL STATION DECKPLANS**

### **FOR AUTHORIZED USE ONLY**

The following classified information has been drawn from various Star Fleet Command and civilian sources, including corporate documents, Star Fleet Intelligence Command summaries, and engineering reports. Any unauthorized duplication or distribution of this material will subject the violator to immediate security confinement pending a board of inquiry and/or court-martial action.

—Commodore C.W. Harn, Office Of Star Fleet Operations  
Star Fleet Education And Training Command  
Elysium, Sol IV, 09.217

## **REGULA I DECK PLANS**

### **Writing**

Rick David Stuart  
Bernard Edward Menke

### **Regula Designs and Deck Plans**

Dana M. Knutson

### **Editorial Staff**

#### *Editor-In-Chief*

L. Ross Babcock III

#### *Senior Editor*

Donna Ippolito

#### *Editor*

Todd Huettel

### **Production Staff**

#### *Production Manager*

Jordan K. Weismann

#### *Art Director*

Dana M. Knutson

#### *Cover Art*

Dana M. Knutson

#### *Typesetting*

Tara Gallagher

#### *Layout and Pasteup*

Todd F. Marsh

Jeff Laubenstein

# TABLE OF CONTENTS

<b>INTRODUCTION</b>	4
Description Of Contents	4
<b>OVERVIEW</b>	5
Origins	5
Logistics	5
Current Deployment	6
Fatalities	9
<b>LAYOUT</b>	10
<i>R-1 Invictus</i> Type Orbital Defense Outpost	10
Level Descriptions	11
Communications And Electronics Center (Level C)	11
Command Center (Level B)	11
Water Storage And Filtration (Level A)	11
Park (Level 1)	11
Hydroponics And Executive Rooms (Level 2)	11
Hydroponics And Executive Rooms (Level 3)	12
Crew Quarters And Medical Facilities (Level 4)	13
Crew Quarters And Computer Center (Level 5)	14
Shuttlecraft Maintenance And Repair Deck (Level 6)	14
Shuttlecraft Storage Bay (Level 7)	15
Shuttlebay (Level 8)	16
Cargo Deck (Level 9)	16
Storage Batteries (Level 10–12)	16
Labs And Sciences (Level 13)	33
Security (Level 14)	33
Ship Repair And Reception (Level 15)	34
Air Filtration And Fabrication (Level 16)	35
Recreation Deck (Level 17)	35
Engineering (Level 18+)	35
<b>VARIANTS</b>	36
<i>R-1 Investigator</i> Type Orbital Research Station	36
<i>R-1 Artisan</i> Type Orbital Manufacturing Center	37
<i>R-1 Administrator</i> Type Orbital Administrative Center	38
<i>R-1 Informant</i> Type Deep-Space Surveillance Center	39
<i>R-1 Harmony</i> Type Recreational Facility	40
<i>R-1 Mercy</i> Type Orbital Medical Center	41
<i>R-1 Terminus</i> Type Orbital Penal Installation	42
<b>SUPPORT VESSELS</b>	43
<i>Samson</i> Class X Warp Tender	43
<i>Scorpio</i> Class II Corvette	44
S-11 Type Repair And Maintenance Pod	45
S-12 Type Medical Pod	45
<i>Infiltrator</i> Type Surveillance Drone	46

# INTRODUCTION

In accordance with the Office of Star Fleet Operations Directive 2878-23Y, this booklet presents specific information concerning the design and use of the *R-1* Type orbital/ deep-space station produced by Chiokis Starship Construction and Rantura Shipping Lines. As the *R-1* is easily adaptable to a wide variety of functions, it plays a key role in Federation security. Fleet officers should familiarize themselves with the various duties and capabilities of this station, its major variants, and its support spacecraft.

## DESCRIPTION OF CONTENTS

This book is divided into four sections. **Overview** presents information regarding the history of the *R-1* Type station, its design, and the development of its eight major types. In addition, this section gives the locations of all *R-1* Type stations. The **Layout** section contains level and room descriptions of the *R-1 Invictus* Type orbital defense outpost. **Variants** describes the seven other *R-1* Type stations, as well as each one's primary function and variations from the *Invictus*. Lastly, **Support Vessels** discusses the various spacecraft typically encountered by crewmembers of *R-1* Type stations.

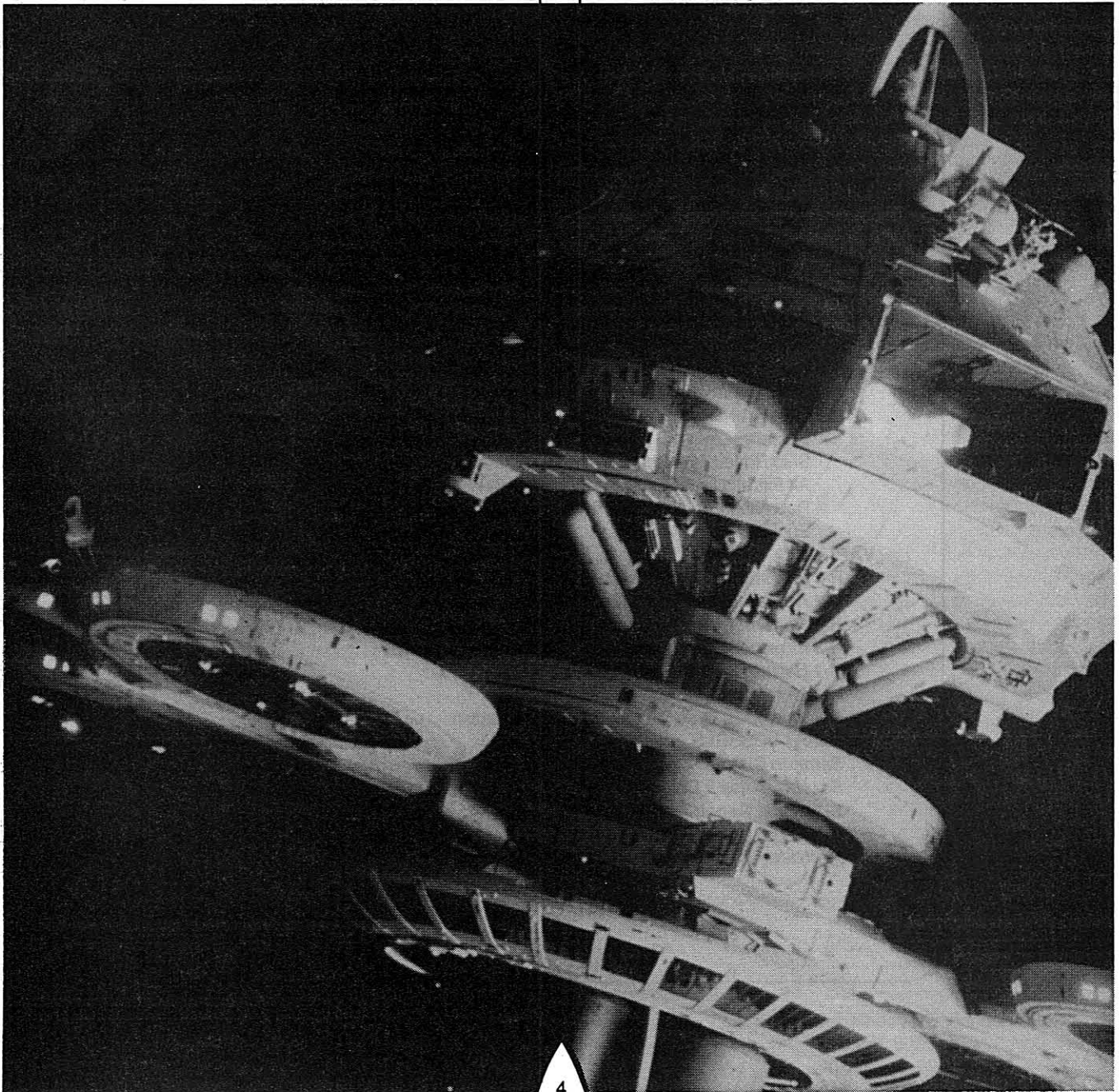

# OVERVIEW

## ORIGINS

The *R-1* Type orbital station was designed to meet the growing need for such a facility among the scientific, civilian, and military sectors. In Stardate 2/01, Star Fleet Command petitioned the Federation Council to request bids to replace the older *K* Type support stations, which were used primarily as trade centers and waystations between distant points of call. At the same time, the Federation's scientific community was lobbying for observation platforms to study astronomical and astrophysical phenomena such as the Murisaki Quasar and the Tritonian Comet Cloud.

These divergent appeals spurred Rantura Shipping and Chiokis Starship engineers to draft blueprints for a modular station system capable of fulfilling both roles. The first type, designated the *R-1 Investigator*, was constructed to study the impending effects of the Lyra Niobe nova. Soon thereafter, Star Fleet command commissioned many orbital defense outposts (*R-1 Invictus* Type stations) to reinforce fleet units stationed near sensitive border regions. Although most of these stations are currently positioned along the Organian and Romulan Neutral Zones, the infamous *V'ger* Incident spurred the Federation Council to supplement Terran defense systems with three new *R-1 Invictus* Type orbital outposts.

Five years after the introduction of the *Invictus*, Chiokis Starship and Rantura shipping began producing a second variant, which allowed manufacturing and industrial refinement operations to function in a zero-g environment. This design, called the *R-1 Artisan*, quickly became one of the most profitable concerns for Chiokis and Rantura.

The *R-1 Administrator* Type has proven itself the most versatile of all the *R-1* variants. Conceived originally as an administrative center, this design has served as apartment complexes, diplomatic conference centers, corporate headquarters, and governmental records repositories.

As tensions increased between the United Federation of Planets and the Klingon Empire, Star Fleet Command began clamoring for intelligence posts to observe enemy military maneuvers and to coordinate intelligence operations within foreign space (such as Operation Dixie). Thus was the *R-1 Informant* Type station created. In addition to conducting discreet intelligence-gathering operations, these stations employ surveillance drones and long-range sensor systems to obtain information. Thirty such listening posts have been constructed.

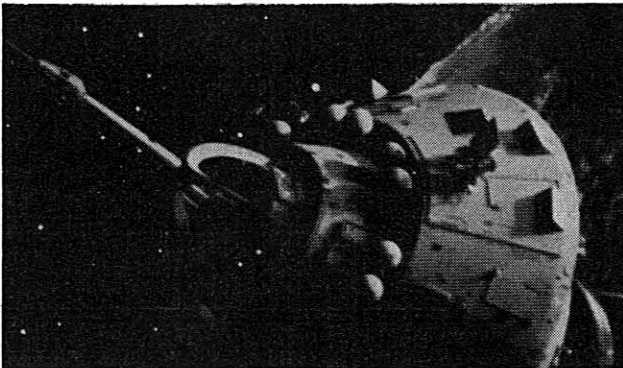

A radical departure from previous variants, the *R-1 Harmony* Type station was produced to improve relations between the Federation and the Orion Colonies and to net a high financial return. With the approval of the Federation Bureau of Interstellar Trade, a group of Orion corporations purchased the first *R-1 Harmony* Type (called the *Treasure Trove 1*). Situated on the border between the UFP and the Orion Colonies, this exclusive recreation and gambling complex provides wealthy clientele with a variety of entertainment and recreational opportunities found nowhere else in the galaxy. Impressed by the vast profit collected during the station's first two years of operation, the Leeper-Fell corporate conglomerate purchased the second *R-1 Harmony* Type station, the *Centauri Pleasureplex 1*, and situated it in the Al Rijil system.

The *R-1 Mercy* Type station serves a more practical purpose. This orbital platform can provide extensive medical care to far-flung regions of space, where a medical disaster would otherwise take thousands of lives. Already this design has proven its effectiveness by stemming an outbreak of Rigellian blood fever in the Cheron star system.

Though specific design data is classified, the *R-1 Terminus* Type station is probably an orbital confinement center used to detain and interrogate intelligence agents and other undesirables caught within Federation space. Information on the *Terminus* Type design is considered top secret and distributed on a need-to-know basis only.

## LOGISTICS

The major reason for the *R-1*'s success is its versatility. Although stations are constructed for a specific purpose, they are not limited to this objective. In an emergency, any of the station's 120 separate modular components can be quickly refitted or reconfigured at a star base or repair facility, giving the station a completely different function.

Whether originating from private, governmental, or civilian concerns, proposals for the construction of an *R-1* Type station must be approved by the Secretary of Star Fleet, as Star Fleet must pay the majority of the costs involved (estimated at somewhere in excess of 17 billion credits). Star Fleet Command owns and is wholly responsible for the operation of *Invictus* and *Informant* Type stations. All other station designs are owned either by individual corporations (who finance most, but not all, the costs incurred) or leased out by Star Fleet to private institutions under long-term agreements. In all cases, however, Star Fleet Command transports the facility to its operational position. The Department of Star Fleet receives an annual fee for providing vessels (warp tenders, supply ships, and so on), which is calculated according to the specific vessel class. In addition, corporations or private industries using *Artisan* or *Administrator* Type stations must pay Star Fleet an annual 2 percent of gross profits from station production. Likewise, an additional 1 percent of all goods manufactured on any *R-1* Type stations are allocated to the Star Fleet Office of Colonization to support and encourage new colonies.



## CURRENT DEPLOYMENT

The following table lists each *R-1* Type station by name, ownership, and present mission objective. Note that the operational status of *Terminus* Type stations is classified and thus not listed on the table.



### R-1 STATION STATUS TABLE

Station	Type	Owner	Mission
Lyra Niobe 1	Investigator	Vulcan Science Academy	Investigation of Lyra Niobe Nova
Vega Prime 1	Investigator	Terran Science Foundation	Interstellar Gas and Plasma Studies
Vulcan Annex 1	Investigator	Vulcan Science Academy	University Astrophysical Research
Pallas 1	Investigator	UFP Geophysical Society	Geophysical Research Data Center
Cassiopeia 1	Investigator	Kaferia University	Astrophysical Research
Beta Darius 1	Investigator	Deneva	Solar Wind Research
Gamma Hydra 1	Investigator	Star Fleet Command	Cometary Research
Regula 1	Investigator	UFP Science Foundation	Classified
Landisa 1	Investigator	Arkenite Astral Institute	Black Hole Research
Alpha Bootis 1	Investigator	Arcturus	Metallurgy Research and Development
Aldebaran 1	Investigator	University of Athers	Microbiology and Biochemical Studies
Ipicran 1	Investigator	Bureau of Star Fleet Science	Cometary Research
Fillandia 1	Investigator	Vulcan Science Academy	Geological Disturbance Studies
Hyronalin Base 1	Investigator	Corporation	Radioactives Research
Arcturus 1	Investigator	Arcturus	Volcano Research/Control
Ariadne 1	Investigator	UFP	High-Energy Physics Research
Miranda 1	Investigator	Tarsus	Biological Studies
Unitas 1	Investigator	Engineering Command	Enemy Vessel Research
Gilgamesh 1	Investigator	Bureau of Scientific Investigation	Research of Yonada Civilization
Othello 1	Investigator	UFP	Destroyed
Boundary 1	Investigator	UFP	Rimward Star Group Studies
Defense Outpost 6	Invictus	Military Operations Command	Organian Neutral Zone
Defense Outpost 18	Invictus	Military Operations Command	Rimward Frontier
Defense Outpost 29	Invictus	Military Operations Command	Gorn Border
Defense Outpost 36	Invictus	Military Operations Command	Organian Neutral Zone
Defense Outpost 43	Invictus	Military Operations Command	Organian Neutral Zone
Defense Outpost 44	Invictus	Military Operations Command	Organian Neutral Zone
Defense Outpost 60	Invictus	Military Operations Command	Organian Neutral Zone
Defense Outpost 85	Invictus	Military Operations Command	Romulan Neutral Zone Border
Defense Outpost 89	Invictus	Military Operations Command	Organian Neutral Zone
Defense Outpost 91	Invictus	Military Operations Command	Organian Neutral Zone
Defense Outpost 102	Invictus	Military Operations Command	Triangle Border
Defense Outpost 112	Invictus	Military Operations Command	Romulan Neutral Zone Border
Defense Outpost 148	Invictus	Military Operations Command	Organian Neutral Zone
Defense Outpost 157	Invictus	Military Operations Command	Tholian Border
Defense Outpost 194	Invictus	Military Operations Command	Gorn Border
Defense Outpost 216	Invictus	Military Operations Command	Orion Border
Defense Outpost 229	Invictus	Military Operations Command	Organian Neutral Zone
Defense Outpost 238	Invictus	Military Operations Command	Gorn Border
Defense Outpost 248	Invictus	Military Operations Command	Organian Neutral Zone
Defense Outpost 287	Invictus	Military Operations Command	Organian Neutral Zone
Defense Outpost 323	Invictus	Military Operations Command	Organian Neutral Zone
Defense Outpost 337	Invictus	Military Operations Command	Romulan Neutral Zone Border
Defense Outpost 361	Invictus	Military Operations Command	Romulan Neutral Zone Border
Defense Outpost 366	Invictus	Military Operations Command	Romulan Neutral Zone Border
Defense Outpost 372	Invictus	Military Operations Command	Romulan Neutral Zone Border
Defense Outpost 375	Invictus	Military Operations Command	Rimward Frontier
Defense Outpost 396	Invictus	Military Operations Command	Gorn Border
Defense Outpost 417	Invictus	Military Operations Command	Orion Border
Defense Outpost 438	Invictus	Military Operations Command	Orion Border
Defense Outpost 457	Invictus	Military Operations Command	Romulan Neutral Zone Border

**R-1 STATION STATUS TABLE (Continued)**

<b>Station</b>	<b>Type</b>	<b>Owner</b>	<b>Mission</b>
Defense Outpost 498	Invictus	Military Operations Command	Rimward Frontier
Defense Outpost 507	Invictus	Military Operations Command	Gorn Border
Defense Outpost 524	Invictus	Military Operations Command	Triangle Border (Destroyed)
Defense Outpost 545	Invictus	Military Operations Command	Organian Neutral Zone
Defense Outpost 573	Invictus	Military Operations Command	Rimward Frontier (Destroyed)
Defense Outpost 579	Invictus	Military Operations Command	Gorn Border
Defense Outpost 581	Invictus	Military Operations Command	Organian Neutral Zone
Defense Outpost 602	Invictus	Military Operations Command	Organian Neutral Zone
Defense Outpost 607	Invictus	Military Operations Command	Rimward Frontier
Defense Outpost 608	Invictus	Military Operations Command	Rimward Frontier
Defense Outpost 629	Invictus	Military Operations Command	Romulan Neutral Zone Border
Defense Outpost 665	Invictus	Military Operations Command	Triangle Border (Destroyed)
Defense Outpost 724	Invictus	Military Operations Command	Orion Border
Defense Outpost 735	Invictus	Military Operations Command	Orion Border
Defense Outpost 768	Invictus	Military Operations Command	Tholian Border
Defense Outpost 780	Invictus	Military Operations Command	Triangle Border
Defense Outpost 797	Invictus	Military Operations Command	Triangle Border
Defense Outpost 856	Invictus	Military Operations Command	Tholian Border
Defense Outpost 859	Invictus	Military Operations Command	Organian Neutral Zone
Defense Outpost 893	Invictus	Military Operations Command	Gorn Border
Defense Outpost 930	Invictus	Military Operations Command	Organian Neutral Zone
Defense Outpost 1038	Invictus	Military Operations Command	Gorn Border
Defense Outpost 1051	Invictus	Military Operations Command	Romulan Neutral Zone Border
Defense Outpost 1121	Invictus	Military Operations Command	Organian Neutral Zone
Defense Outpost 1204	Invictus	Military Operations Command	Romulan Neutral Zone Border
Defense Outpost 1237	Invictus	Military Operations Command	Romulan Neutral Zone Border
Defense Outpost 1286	Invictus	Military Operations Command	Orion Border
Defense Outpost 1317	Invictus	Military Operations Command	Organian Neutral Zone
Defense Outpost 1378	Invictus	Military Operations Command	Tholian Border
Defense Outpost 1426	Invictus	Military Operations Command	Terran Defense Post
Defense Outpost 1427	Invictus	Military Operations Command	Terran Defense Post
Defense Outpost 1428	Invictus	Military Operations Command	Terran Defense Post
Defense Outpost 1520	Invictus	Military Operations Command	Organian Neutral Zone
Endeavor 1	Artisan	Tellar	Experimental Ore Processing
Andor Eye 1	Artisan	Andor	Meteorological Studies
Regal Find 1	Artisan	Tellar	Metal Refining
Zeta Alpha 1	Artisan	Corporate	Microcircuitry Manufacturing
Sarsis Plant 1	Artisan	Corporate	Pharmaceutical Manufacturing
Vega Harrier 1	Artisan	Corporate	Vegan Tobacco Processing
Salazaar A-1	Artisan	Corporate	Starship Components Manufacturing
Salazaar B-1	Artisan	Corporate	Starship Components Manufacturing
Xanadu Prime 1	Artisan	Corporate	Terraforming Equipment Manufacturing
Sarus Pax 1	Artisan	Corporate	Asteroid Mining Complex
Excavator 1	Artisan	Corporate	Asteroid Mining Complex
XM-1	Artisan	Corporate	Agricultural Complex
Jarid Center 1	Artisan	Corporate	Ship Component Manufacturing
Multiplanet Base 1	Artisan	Corporate	Cybernetic Construction
Soron Center 1	Artisan	Corporate	Cybernetic Construction
Hadrans Complex 1	Artisan	Corporate	Clothing Manufacturing
Deepwell 1	Artisan	Corporate	Asteroid Mining Complex
Richload 1	Artisan	Corporate	Metal Processing
Manning Dox 1	Artisan	Corporate	Textile Manufacturing
Muraski Major 1	Artisan	Corporate	Silk/Textile Manufacturing
Muraski Minor 1	Artisan	Corporate	Silk/Textile Manufacturing
Luxor Able 1	Artisan	Corporate	Ore Extraction
Luxor Twin 1	Artisan	Corporate	Ore Extraction
Astral Point 1	Artisan	Corporate	Optical Lens Manufacturing
Hendersen 1	Artisan	Corporate	Chemical Manufacturing
Maxwell Orb 1	Artisan	Corporate	Cybernetic Construction

**R-1 STATION STATUS TABLE (Continued)**

<b>Station</b>	<b>Type</b>	<b>Owner</b>	<b>Mission</b>
Cygnets XIV Prime 1	Artisan	Corporate	Cybernetic Construction
Byondis 1	Artisan	Corporate	Subspace Communication Research
Samos 1	Artisan	Corporate	Ferrocrite Manufacturing
Babel Orbital Center 1	Administrator	UFP	Government Archives Storage
Terra 1	Administrator	Star Fleet Command	Orbital Administrative Facility
Parley Point 1	Administrator	UFP	Diplomatic Conference Center
Centus Alpha 1	Administrator	Corporate	Corporate Headquarters
Clanhaven 1	Administrator	UFP	Gorn Diplomatic Facility
Lorris Main 1	Administrator	Corporate	Orbital Housing Project
Resurrection 1	Administrator	Tiburon	Cemetery
Trilum Base 1	Administrator	Sol University	Astronomical Observation Facility
Maxilon Control 1	Administrator	Corporate	Marketing Center
Unity Point 1	Administrator	Star Fleet Command	Strategic Planning Post
Maximus 1	Administrator	Bureau of Star Fleet Science	Weapons Testing Center
Ursis Load A-1	Administrator	UFP	Federation Treasury Depository
Ursis Load B-1	Administrator	UFP	Federation Treasury Depository
BiblioTech 1	Administrator	UFP	Federation Technical Records Center
Welcome Mat 1	Administrator	Argelius	System Access/Exit Navigation
Dinara Set 1	Administrator	Corporate	Business Trade Center
Port Issara 1	Administrator	Corporate	Business Trade Center
Thelossis 1	Administrator	Corporate	Luxury Hotel Accommodations
LaGrange AAA-1	Administrator	Corporate	Corporate Headquarters
Palasada 1	Administrator	Corporate	Luxury Business Hotel
Gritch 1	Informant	Intelligence Command	Romulan Sector
Mothra 1	Informant	Intelligence Command	Romulan Sector
Snark 1	Informant	Intelligence Command	Romulan Sector
Pennywise 1	Informant	Intelligence Command	Romulan Sector
Fafnir 1	Informant	Intelligence Command	Romulan Sector
Sasquatch 1	Informant	Intelligence Command	Romulan Sector
Ghidrah 1	Informant	Intelligence Command	Romulan Sector
Vermithrax 1	Informant	Intelligence Command	Klingon Sector
Nosferatu 1	Informant	Intelligence Command	Klingon Sector
Wief 1	Informant	Intelligence Command	Klingon Sector
Scylla 1	Informant	Intelligence Command	Klingon Sector
Charybdis 1	Informant	Intelligence Command	Klingon Sector
Poltergeist 1	Informant	Intelligence Command	Klingon Sector
Hyde 1	Informant	Intelligence Command	Klingon Sector
Grendel 1	Informant	Intelligence Command	Klingon Sector
Dragon Lady 1	Informant	Intelligence Command	Klingon Sector
Tingler 1	Informant	Intelligence Command	Klingon Sector
Polladori 1	Informant	Intelligence Command	Gorn Sector
Bugblatter 1	Informant	Intelligence Command	Gorn Sector
Gammorah 1	Informant	Intelligence Command	Gorn Sector
T'prelki 1	Informant	Intelligence Command	Tholian Sector
Raven 1	Informant	Intelligence Command	Tholian Sector
Rodan 1	Informant	Intelligence Command	Tholian Sector
Vlad 1	Informant	Intelligence Command	Tholian Sector
Chimera 1	Informant	Intelligence Command	Rimwood Border, Sector 1
Namu 1	Informant	Intelligence Command	Rimward Border, Sector 1
Bargrik 1	Informant	Intelligence Command	Rimward Border, Sector 1
Typhon 1	Informant	Intelligence Command	Classified
Shadow 1	Informant	Intelligence Command	Classified
Nightmare 1	Informant	Intelligence Command	Classified
Treasure Trove 1	Harmony	Corporate	Commercial Pleasure Resort
Centauri Pleasureplex 1	Harmony	Corporate	Commercial Pleasure Resort
Mercy 1	Mercy	Medical Command	Rigellian Fever Victim Care
Compassion 1	Mercy	Medical Command	Hospital Facilities

## FATALITIES

Since the introduction of the first *R-1* Type station, four have been lost. Three of these were *Invictus* Type orbital border outposts and the fourth, the *Othello 1*, was an *Investigator* Type research installation. The *Othello 1* was destroyed on Stardate 2/2012, while station personnel were engaged in a classified research project for Star Fleet Command. Though unconfirmed, rumors suggest that the *Othello 1* was conducting experiments with protomatter, and a machine malfunction might have caused a prototype Genesis Device to explode. Although long-range sensor scans did detect an unusual amount of radiation in the *Othello 1*'s last-known position, the rescue team found no survivors nor any trace of the station itself.

Negligence caused the destruction of Defense Outpost 665. On Stardate 2/1704.05, a class from Star Fleet Academy was participating in a weapons status check when a cadet accidentally triggered an overload in one of the station's phaser banks. Before the bank could be deactivated, a chain-reaction explosion destroyed over half the station. Since then, Star Fleet training groups have been forbidden from participating in any exercise aboard defense outposts.

The circumstances behind the loss of Defense Outposts 524 and 573 remain classified. What is known is that they operated along the Federation border near the Triangle Zone, receiving orders from Star Base 10, and were lost at about the same time.

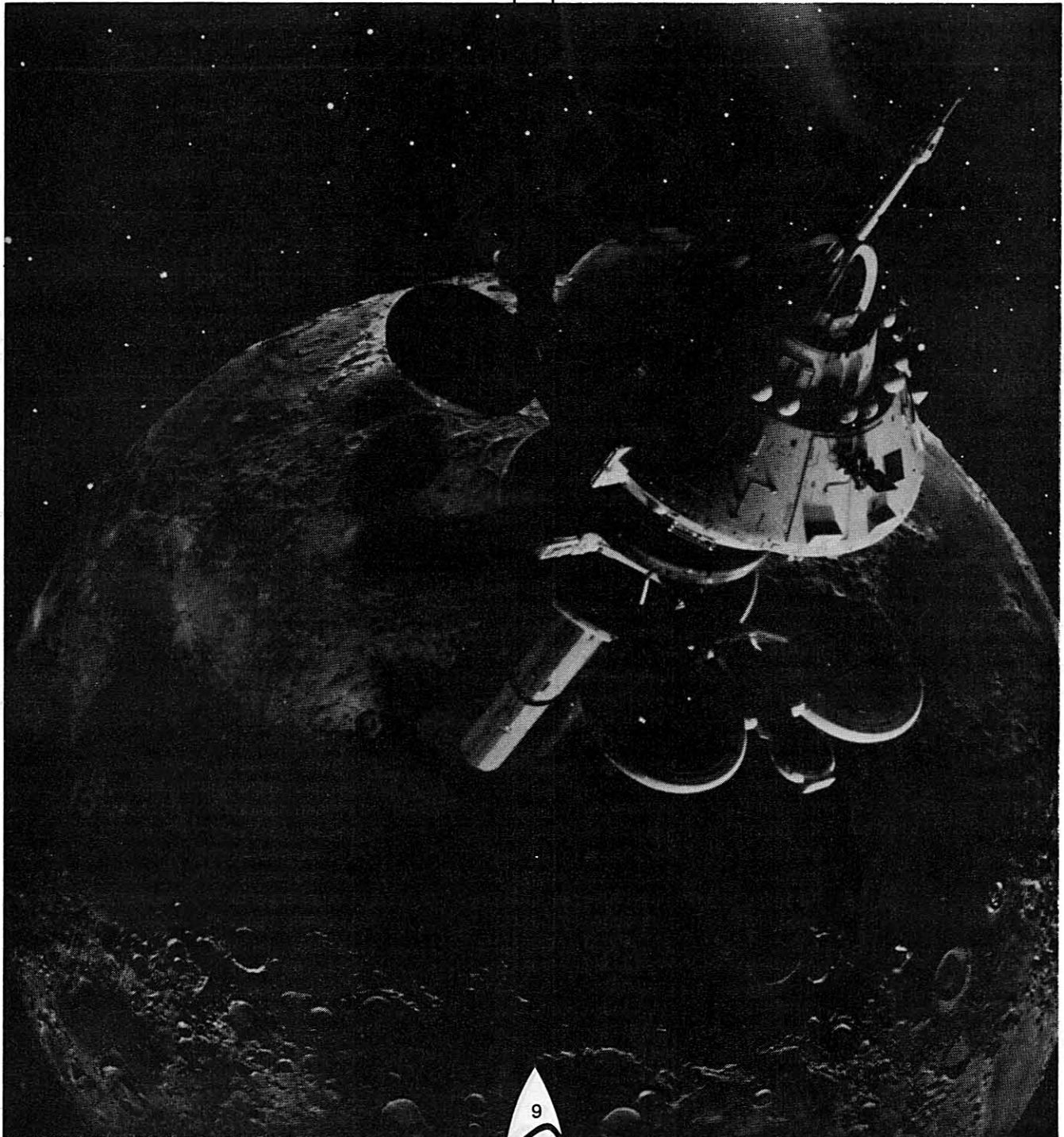

# LAYOUT

The following section describes each level of the *R-1 Invictus* Type orbital border outpost. In addition to turbolifts connecting all station levels, a network of catwalks and stairwells provides access to each level. To protect base personnel in case of unexpected depressurization, each room contains independent life support and gravity control systems. Station designers made great efforts to accommodate both Humanoid and non-Humanoid personnel who would be working aboard for long periods of time. Refer to the pull-out section of deck plans for the *R-1 Invictus* Type station.

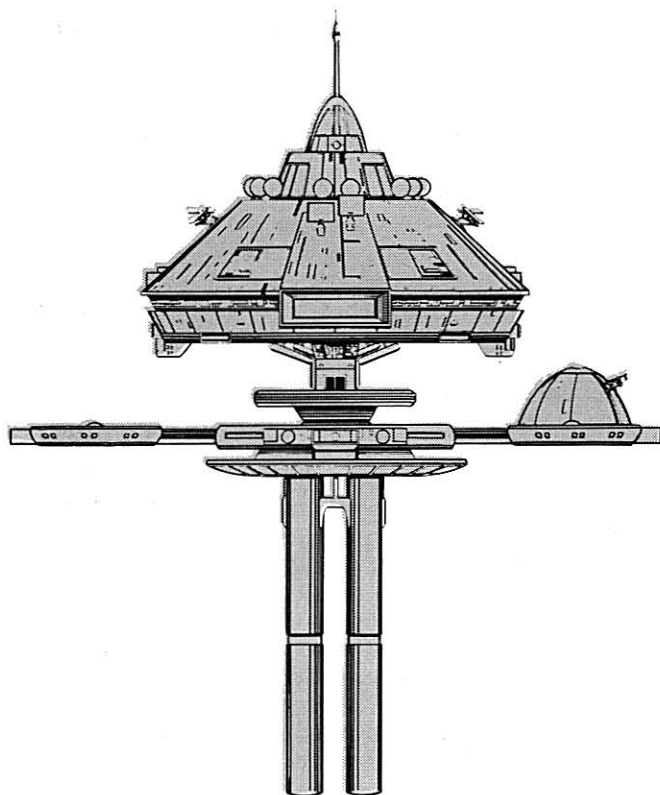

## R-1 INVICTUS TYPE ORBITAL DEFENSE OUTPOST

<b>Construction Data:</b>	
Model Number—	MK 1
Date Entering Service—	2/0911
Number Constructed—	63
<b>Hull Data:</b>	
Superstructure Points—	40
Damage Chart—	Outpost
Size	
Diameter—	200M
Length—	215M
Weight—	1,103,000 mt
<b>Cargo</b>	
Cargo Units—	200 SCU
Cargo Capacity—	10,000 mt
Landing Capability—	None
<b>Equipment Data:</b>	
Control Computer Type—	M-1
Transporters—	
Standard 6-person—	2
Emergency 22-person—	1
Cargo—	2
<b>Other Data:</b>	
Crew—	185
Visitors—	20
Shuttlecraft—	0-4
<b>Engines And Power Data:</b>	
Total Power Units Available—	114
Movement Point Ratio—	10/1
Matter-Antimatter Power GeneratorType—	FMAPG-1
Number—	1
Power Units Available—	98
Impulse Power GeneratorType—	FIPG-1
Power Units Available—	16
<b>Weapons And Firing Data:</b>	
Beam WeaponType—	FH-8
Number—	9
Firing Arcs—	3/arc
Firing Chart—	T
Maximum Power—	5
Damage Modifiers—	
+2	(1-10)
+1	(11-18)
Missile Weapon Type—	FP-6
Number—	6
Firing Arcs—	2/arc
Firing Chart—	0
Power To Arm—	1
Damage—	12
<b>Shields Data:</b>	
Deflector Shield Type—	OFSA
Shield Point Ratio—	1/2
Maximum Shield Power—	16
<b>Combat Efficiency:</b>	
D—	112.8
WDF—	78.9

### STATION NOTES

The mission of the *Invictus* Type orbital defense outpost is to provide defensive support for installations and planetary systems and to serve as an early-warning post able to withstand a low- to moderate-level incursion by enemy forces. It is one of the few *R-1* Type stations that mounts weaponry.

## LEVEL DESCRIPTIONS

### COMMUNICATIONS AND ELECTRONICS CENTER (LEVEL C)

The topmost level of the *R-1 Invictus* Type defense outpost is a single room that houses the installation's sub-space communications system. Located here are controls for the navigation beacon mounted on top of the station and short-range scanning and detection sensors with backup systems and emergency power supply units. Electrical systems monitor the distribution of power generated by the station's matter/antimatter reactors and also control life support systems throughout the entire station.

### COMMAND CENTER (LEVEL B)

Duty officers monitor the installation's operations from this single-room level. Roughly analogous to a starship's bridge, the command center is where the station commander coordinates vessel operations.

### WATER STORAGE AND FILTRATION (LEVEL A)

This large, single-room level contains the automated machinery that stores and recycles the station's water. It controls both filtration and purification of onboard supplies, which will last for 18 months at normal consumption rates.

### PARK (LEVEL 1)

This level supports numerous floral specimens, which are regulated by automated systems running below the deck's surface. Besides the various plants and trees, this park contains a spring, benches, and dirt paths so that personnel can enjoy the great outdoors without leaving the station. Three FH-8 phasers are mounted outside this deck.

### HYDROPONICS AND EXECUTIVE ROOMS (LEVEL 2)

Various foodstuffs are grown on this level, whose automated systems continuously regulate growth. In addition, the station's command personnel and visiting dignitaries have their living accommodations here. Attractive shrubs lend a homey air to this level.

#### Hydroponics Growth Control Area (1)

These self-contained areas house a variety of food-producing plants under different environmental conditions.

#### Park Area (2)

These park areas contain both familiar and exotic floral specimens.

#### Station Chief Quarters (3)

This room contains sleeping accommodations for the station chief, including a bed with antigrav plates for zero- or low-g conditions.

#### Station Chief Living Room (4)

This area contains chairs, a couch, dining facilities, and a food fabricator.

#### Station Chief Study (5)

Used for private meetings, this study houses a computer console with access to both the communication and library computers.

#### Station Chief Head (6)

This is the station chief's sanitary facilities.

#### Officer's Quarters (7)

This room contains sleeping accommodations for an officer, including a bed with antigrav plates for zero- or low-g conditions.

#### Officer's Living Room (8)

This area contains chairs, a couch, dining facilities, and a food fabricator.

#### Officer's Study (9)

Used for private meetings, this room houses a computer console with access to both the communications and library computers.

#### Officer's Head (10)

This is an officer's sanitary facilities.

#### VIP Quarters (11)

These accommodations for visiting dignitaries include a bed with antigrav plates for zero- or low-g conditions.

#### VIP Living Room (12)

This area contains chairs, a couch, dining facilities, and a food fabricator.

#### VIP Study (13)

Used for private meetings, this room houses a computer console with access to both the communications and library computers.

#### VIP Head (14)

This is a VIP's sanitary facilities.

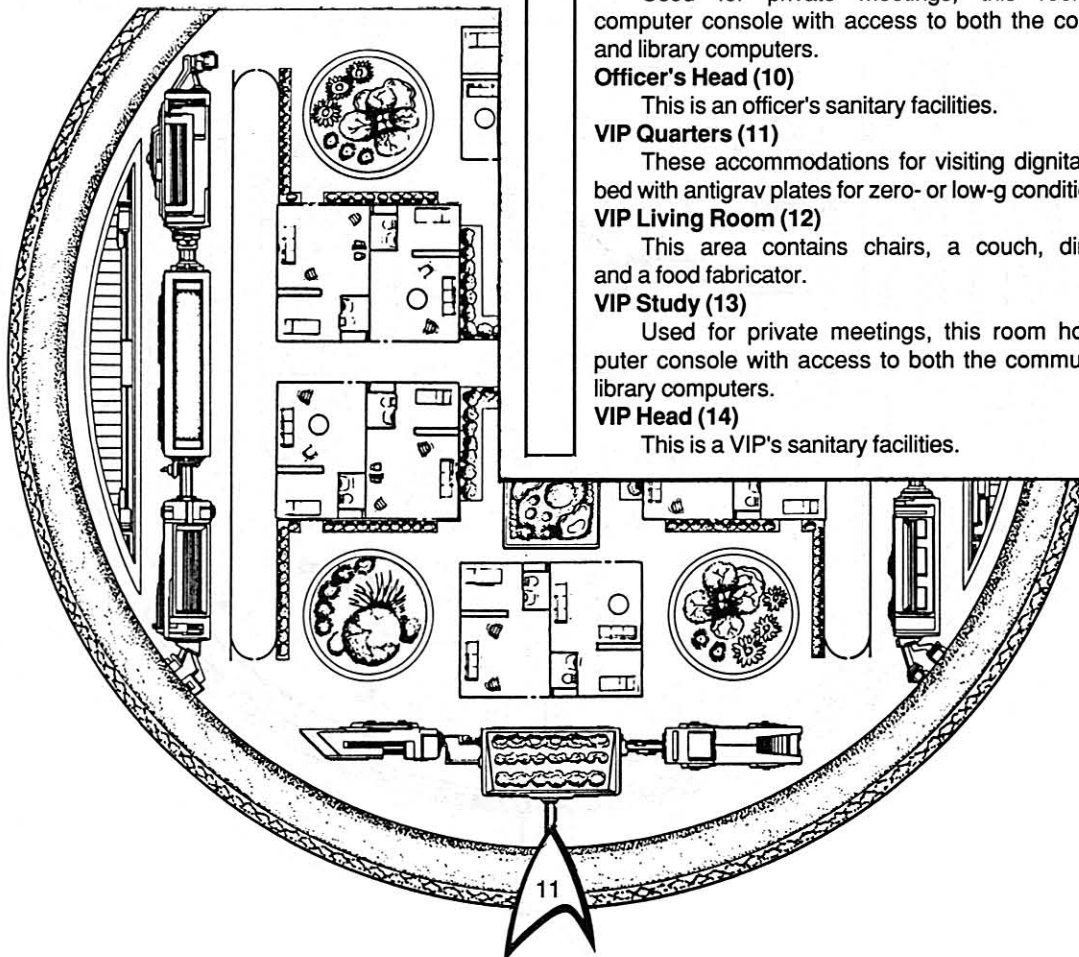

## HYDROPONICS AND EXECUTIVE ROOMS (LEVEL 3)

On this level are several hydroponics tanks, which contain plants intended for consumption. In addition, state-rooms for station officers and visiting dignitaries are located here. This level also contains shrubberies and hydroponics machinery.

### Hydroponics Growth Control Area (1)

These self-contained areas house a variety of food-producing plants under different environmental conditions.

### Park Area (2)

These park areas contain both exotic and familiar floral specimens.

### Vegetable Garden (3)

Station personnel grow several varieties of vegetables here.

### Assistant Station Chief Quarters (4)

These accommodations for the assistant station chief include a bed with antigrav plates for zero- or low-g conditions.

### Assistant Station Chief Living Room (5)

This area contains chairs, a couch, dining facilities, and a food fabricator.

### Assistant Station Chief Study (6)

This room is used for private meetings and houses a computer console with access to both the communications and library computers.

### Assistant Station Chief Head (7)

This is the assistant station chief's sanitary facilities.

### Officer's Quarters (8)

This room contains sleeping accommodations for an officer, including a bed with antigrav plates for zero- or low-g conditions.

### Officer's Living Room (9)

This area contains chairs, a couch, dining facilities, and a food fabricator.

### Officer's Study (10)

Used for private meetings, this room houses a computer console with access to both the communications and library computers.

### Officer's Head (11)

This is an officer's sanitary facilities.

### VIP Quarters (12)

These accommodations for a visiting dignitary include a bed with antigrav plates for zero- or low-g conditions.

### VIP Living Room (13)

This area contains chairs, a couch, dining facilities, and a food fabricator.

### VIP Study (14)

This room is used for private meetings and houses a computer console with access to both the communications and library computers.

### VIP Head (15)

This a VIP's sanitary facilities.

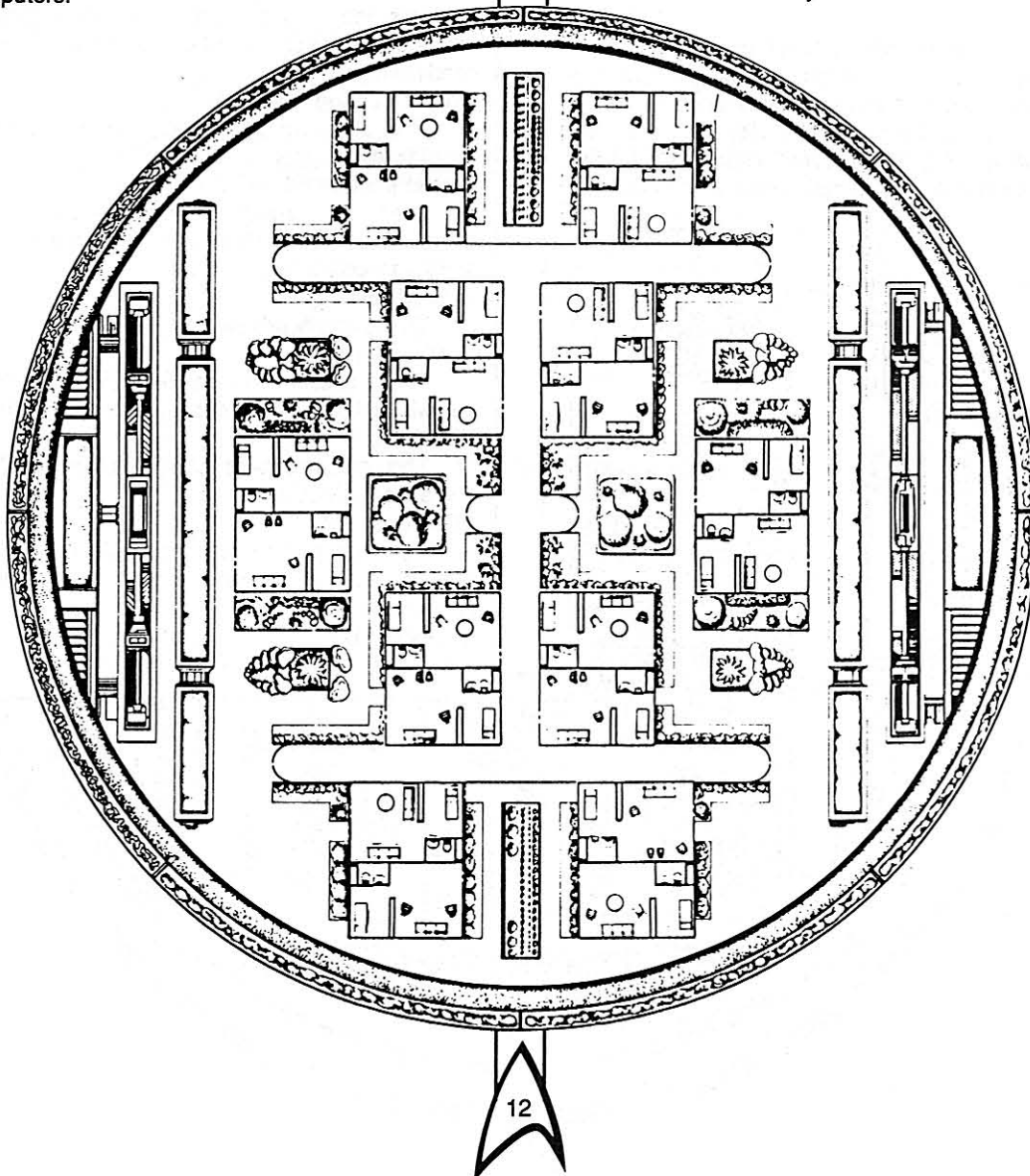

## CREW QUARTERS AND MEDICAL FACILITIES (LEVEL 4)

On this level are staterooms for station personnel as well as dining areas. Two crewmembers share each suite, which contains a sleeping area, living area, and a head. This level also houses the station's medical facilities, including a sickbay, pharmacology, xenobiology and medical labs, an operating room, and an intensive care ward that can accommodate up to a dozen personnel.

### Examination Room (1)

This area is used to examine injured or ill crewmembers.

### Medical Science Lab (2)

The medical science lab is used for conducting research and contains separate facilities for toxicology, immunology, and neurological studies.

### Medical Computer (3)

This room contains a computer system capable of running the medical facilities if the station's main computer breaks down. It controls all medical lab operations on this level.

### Operating/Examining Room (4)

The Chief Surgeon performs operations and examines patients here.

### Private Ward Area (5)

This private room has a diagnostic table and panel to monitor a patient.

### Two-Person Ward Area (6)

This semi-private room is equipped with two diagnostic tables and panels.

### Pharmacology Lab (7)

The pharmacology lab contains computerized laboratory equipment used to conduct pharmacology and related research.

### Xenobiology Lab (8)

The lab's computerized equipment is used to conduct biological studies on Humanoid and nonHumanoid patients.

### Patient Monitoring Station (9)

This room contains monitors that allow medical personnel to watch every patient in sickbay and to monitor their vital functions.

### Medical Computer Power Generators (10)

Backup power generators in this room are capable of powering the medical computer if the station's main power generators fail.

### Chief Surgeon's Office (11)

The Chief Medical Officer handles paperwork and meets with patients here.

### Personnel Records Room (12)

This room's computers contain past and present medical records of all individuals serving aboard the station.

### Waiting Area (13)

Patients wait for appointments with the Chief Surgeon here.

### Biochemistry Lab (14)

These computerized facilities are used to conduct biochemical experiments.

### Medical Lab (15)

The Chief Surgeon evaluates his patients' tests here.

### Dining Area (16)

These dining areas are equipped with food processing units and dining tables.

### Park (17)

In this enclosed park area are several species of Terran and Caitian trees. Electronic controls in Room 18 can make this area display a variety of scenes, such as beach, forest, desert, and mountains.

### Park Display Room (18)

This room contains the controls that change the scenery in Room 17.

### Transporter Room (19)

Contained in this room is the station's only 22 person emergency transporter.

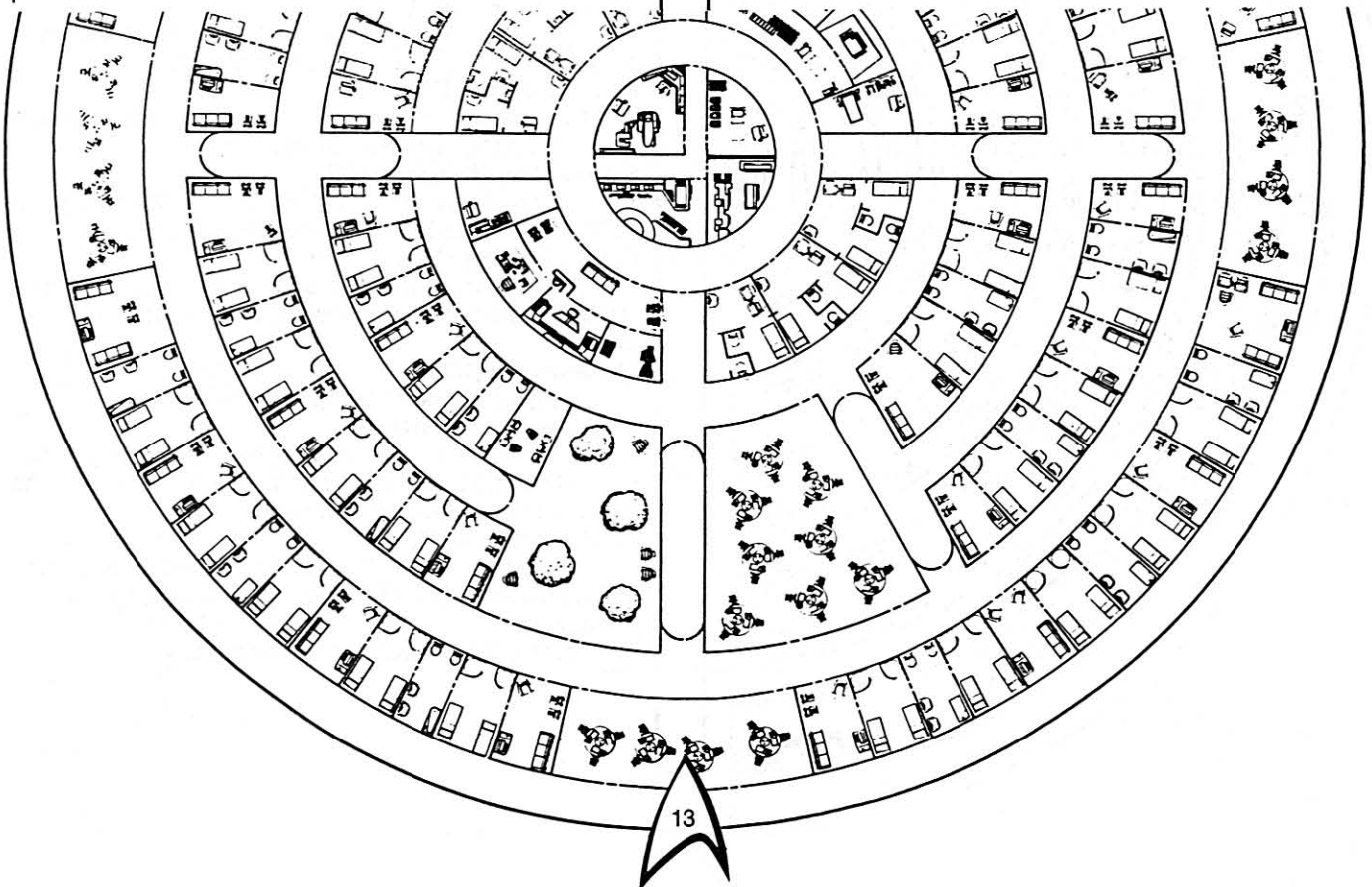



## CREW QUARTERS AND COMPUTER CENTER (LEVEL 5)

Like the deck above, this level contains room accommodations and dining facilities for enlisted crewmembers. In addition, it houses the installation's central computer system, which controls every aspect of the station's functions.

### Computer Room (1)

This room contains the controls for the station's main and backup computer systems.

### Computers (2)

In these rooms are the main and auxiliary computer systems, which regulate all computers and power sources throughout the installation.

### Emergency Power Systems (3)

If the main power generators malfunction, the backup power generators in this room can provide emergency power to station computer systems.

### Dining Area (4)

These dining areas are equipped with food processing units and dining tables.

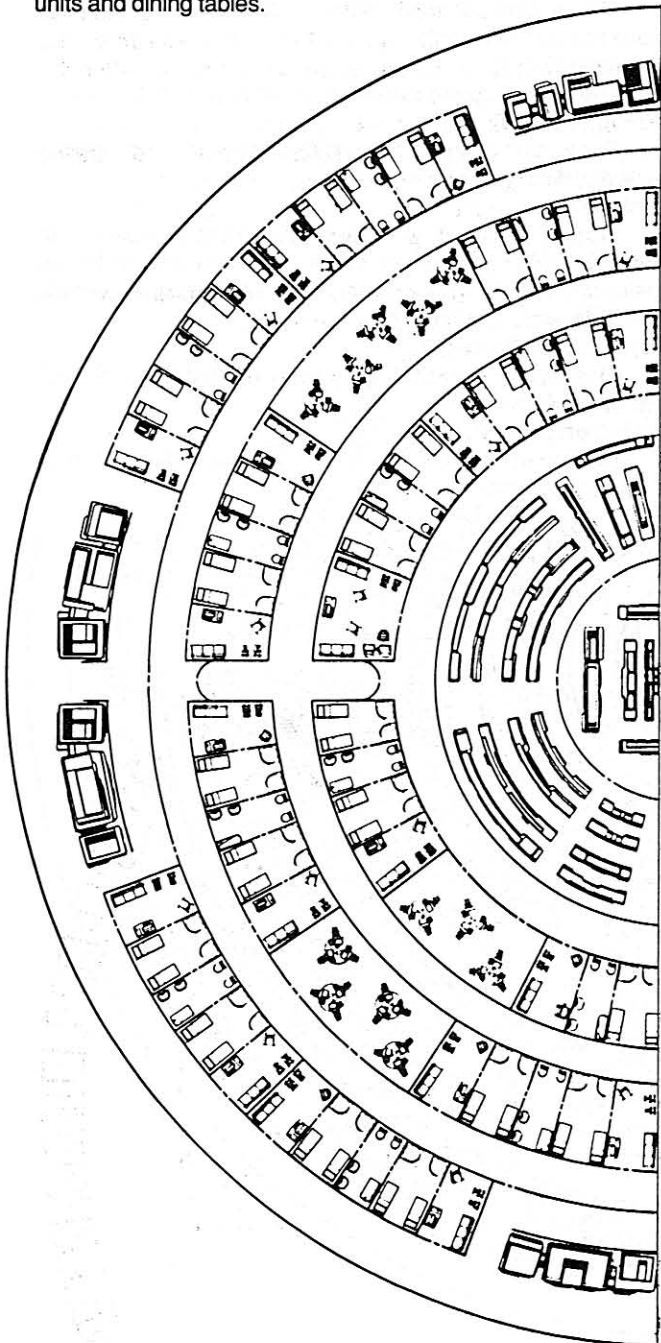

## SHUTTLECRAFT MAINTENANCE AND REPAIR DECK (LEVEL 6)

This level houses the machinery and electronic systems used to maintain and repair shuttlecraft and repair pods. Additional equipment permits shuttlecraft to be modified with specialized sensors or a warpsled. Ringing this level are storage cabinets containing tools and spare parts.

### Work Area (1)

Support personnel use this area to repair, maintain, and modify the station's repair pods and shuttlecraft. Several pneumatic lifts can raise shuttlecraft high enough that support personnel can work underneath them.

### Elevator (2)

Running from Level 6 to Level 9, this pneumatic elevator and is large enough to accommodate one shuttlecraft.

### Small Craft Computer (3)

The small craft computer contains detailed information, schematic diagrams, and electrical circuit blueprints of Federation shuttlecraft, repair and travel pods, and other small craft.

### Circuit Analysis Room (4)

The circuit analysis room's computers run multiple tests on shuttlecraft electronic and computer systems to determine their efficiency.

### Fusion Room (5)

Repair personnel use this room for precision fusion of metallic and synthetic parts.

### Break Room (6)

Support personnel and technicians take coffee and meal breaks in this room.

### Diagnometry Machine Areas (7)

These areas consist of portable diagnostic machines, which can determine the general source of equipment malfunctions.

### Deck Chief's Office (8)

The deck chief works in this room, compiling reports and filling out any necessary paperwork.

### Shuttledolly Room (9)

Stored in this room is a shuttledolly, which can lift a shuttlecraft and move it to and from the elevator.

### Power Generator Room (10)

The massive generator in this room can recharge emergency batteries stored aboard shuttlecraft.

### Sensor Status Computer (11)

The sensor status computer can run tests on shuttlecraft sensors to determine their operating efficiency.

### Sensor And Shield Repair Room (12)

Machines for repairing shuttle sensor arrays and navigational deflector shields apparatus are located in this room.

### Lift Generator (13)

This generator powers the pneumatic elevator.

### Engine Repair Room (14)

These facilities are used to make repairs on repair pod and shuttlecraft impulse engine systems. Also, the thrusters can be fueled up in this room.

### Fabricator Room (15)

The fabricators in this room manufacture only large metallic materials and are usually used to make hullmetal.

### Head (16)

These sanitary facilities are for technicians.

### SHUTTLECRAFT STORAGE BAY (LEVEL 7)

This level is used for storing the station's repair pods and shuttlecraft. At least one shuttlecraft is powered for launching at all times.

#### Vessel Storage Area (1)

All shuttlecraft and repair pods that are not being used or repaired are stored here.

#### Elevator (2)

Running from Level 6 to Level 9, this pneumatic elevator is large enough to accommodate one shuttlecraft.

#### Turbolift Control Room (3)

Machinery in the turbolift control room coordinates the movement of all turbolifts so that none will crash into each other. Also located here are the generators that power the turbolifts. A computer display shows the whereabouts of each one.

#### Navigation Beacon Center (4)

This automated machinery powers and monitors the beacon perched atop the orbital station.

#### Head (5)

These are sanitary facilities.

#### Custodial Room (6)

Supplies used to clean the interior and exterior of repair pods and shuttlecraft are kept here.

#### Power Relay Station (7)

These power outlets are connected to the standby power generator in Room 10. Cables running from these outlets keep the shuttlecraft in a constant state of readiness.

#### Phaser Circuit Breaker Room (8)

This room contains circuit breakers for the station's phasers. When a phaser is about to overload, it trips a circuit breaker, cutting off power to that phaser.

#### Shuttledolly Room (9)

Stored in this room is a shuttledolly, which can pick up and move shuttlecraft to and from the elevator.

### Standby Power Generator (10)

The standby power generator feeds power to the power relay stations (Room 7), where shuttlecraft are plugged in to receive a constant stream of energy.

### Power Gauge Station (11)

Shuttlecraft and repair pods are plugged into these monitors to determine their systems' operating efficiency. If the monitors discover any malfunction, the shuttlecraft is sent to the shuttlecraft maintenance and repair deck (Level 6) for repairs.

### Auxiliary Command Center (12)

If the station's command center is rendered unusable, command personnel can monitor and direct station functions from the auxiliary command center. There is always one security guard posted outside this room.

### Fire Control Center (13)

The fire control center contains repeater consoles for the station's beam and missile weapons. The consoles connect the targeting computer (on Level 5) to the weapons console on the command center. If the command center is incapable of firing the weapons, these consoles can do the job. All firing is done through these consoles, even when the command center is functional.

### Personal Effects Lockers (14)

Personal effects lockers are issued to station personnel for storing their belongings.

### Observation Portals (15)

These windows allow a clear view of space.

### Torpedo Tubes (16)

The station's six torpedo tubes are installed on this level. Each tube can fire photon torpedoes in a 120° arc.

### Storage Lockers (17)

These lockers contain tools and spare parts.

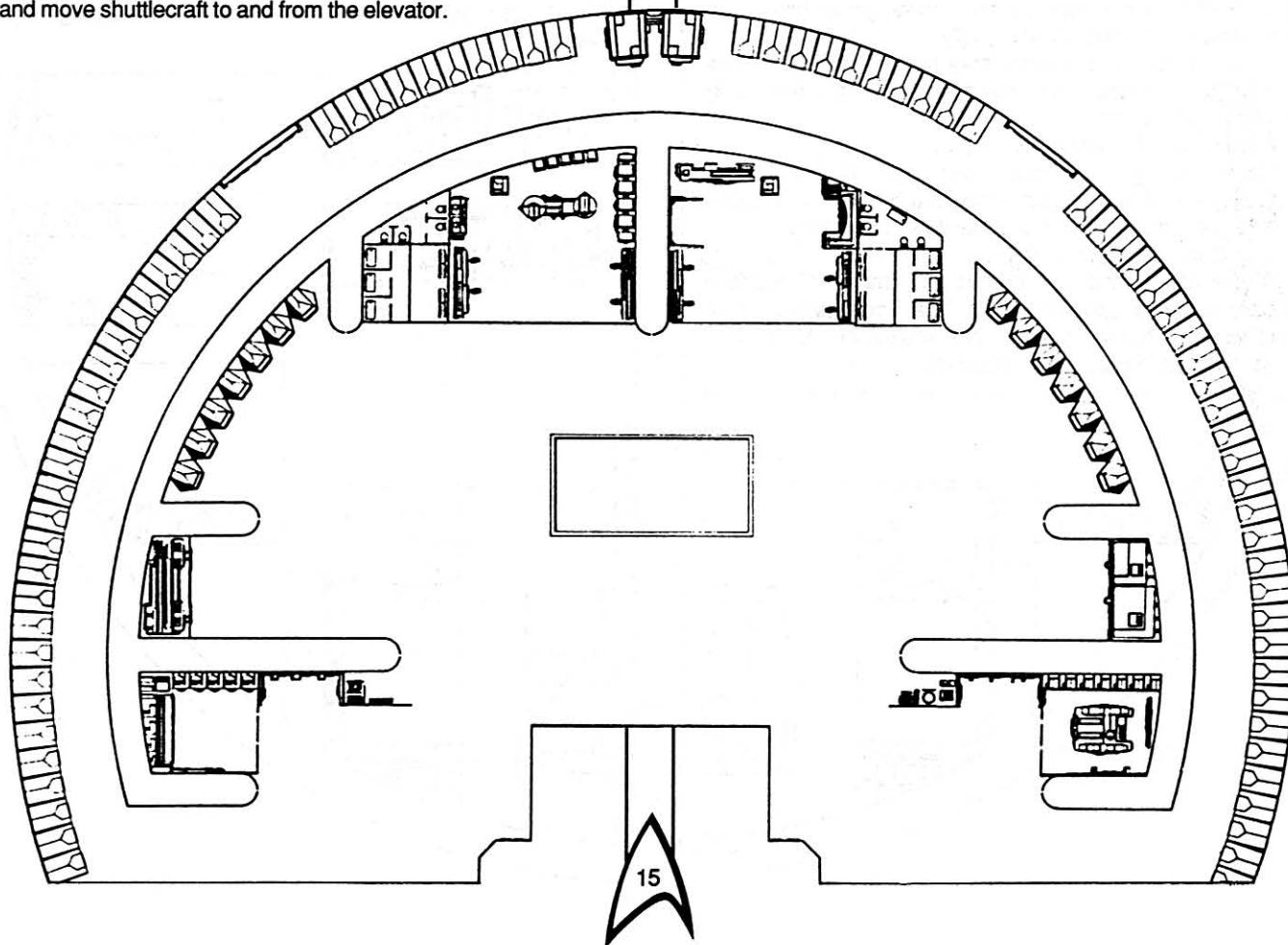

## SHUTTLEBAY (LEVEL 8)

Shuttlecraft and repair pods land and take off from this level. Also located here are the launch control facilities. Every door on this level is airtight to prevent its room's atmosphere from escaping into the launch bay while the shuttle doors are open.

### Launch Bay (1)

This hangar bay is used to launch and recover repair pods and shuttlecraft. An enclosed catwalk above the runway surrounds the area and is used for observing launch and recovery activities.

### Elevator (2)

Running from Level 6 to Level 9, this pneumatic elevator is large enough to accommodate one shuttlecraft.

### Launch Control Room (3)

The launch control room is used to control the launching and landing of repair pods and shuttlecraft. In addition, it contains consoles that control the tractor beam, pressurization, and shuttlebay door.

### Decontamination Room (4)

Personnel and equipment are decontaminated here.

### Emergency Unit Storage (5)

These rooms contain paramedical equipment and fire extinguishers in case the craft or crew have been injured.

### Head (6)

Duty personnel use these sanitary and bathing facilities.

### Ready Room (7)

Environmental suits, tricorders, and other equipment needed aboard repair pods and shuttlecraft are stored here. Also, officers may hold conferences in these rooms.

### Tractor Beam Generator Room (8)

This room contains machinery that can produce a tractor beam or a pressor beam, which can repel objects. The launch control room (Room 3) controls these generators.

### Shuttlebay Door Activator Room (9)

Located here is the machinery that opens and closes the shuttlebay doors. The launch control room (Room 3) controls the activators.

### Pressurization Machinery Room (10)

Controlled by the launch control room (Room 3), this machinery restores the hangar bay to a breathable environment 13 seconds after the shuttlebay doors are closed.

### Backup Operations Room (11)

If any of the machines on this level malfunction, these auxiliary systems can take over. They can generate the tractor/pressor beam, operate the shuttlebay doors, and control life support systems on this level.

## CARGO DECK (LEVEL 9)

Bulk cargoes, including equipment, consumables, and raw materials for fabrication, are stored on this level. In addition, this deck houses the station's gravity control systems. Three FH-8 phasers are mounted outside this deck.

### Cargo Transporter (1)

The transporter console beams cargo to and from this area.

### Elevator (2)

Running from this level to Level 6, this pneumatic elevator allows personnel to unload cargo from a shuttlecraft.

### Storage Area (3)

Non-perishable items are stored in these rooms.

### Storage Area (4)

Perishable, climate-controlled items are stored here.

### Zero-G Storage Area (5)

These rooms provide a null-gravity environment for certain cargo.

### Bulk Storage Area (6)

Large pieces of cargo are stored in these rooms.

### Grain Bin (7)

Seeds and grain for hydroponic tanks or planetside farming are stored in these grain bins.

### Gravity Generators (8)

These phased energy-linked artificial gravity generators keep the entire station at 1 g, and can supply individual staterooms with higher or lower gravities.

## EMERGENCY BATTERIES (LEVELS 10-12)

These three levels contain the station's backup power system—Model L-346 storage batteries and Kloratis Drives, Inc. solar power capacitors, which are similar to those found onboard Federation interstellar craft. Each level contains control units that regulate the distribution of emergency power.

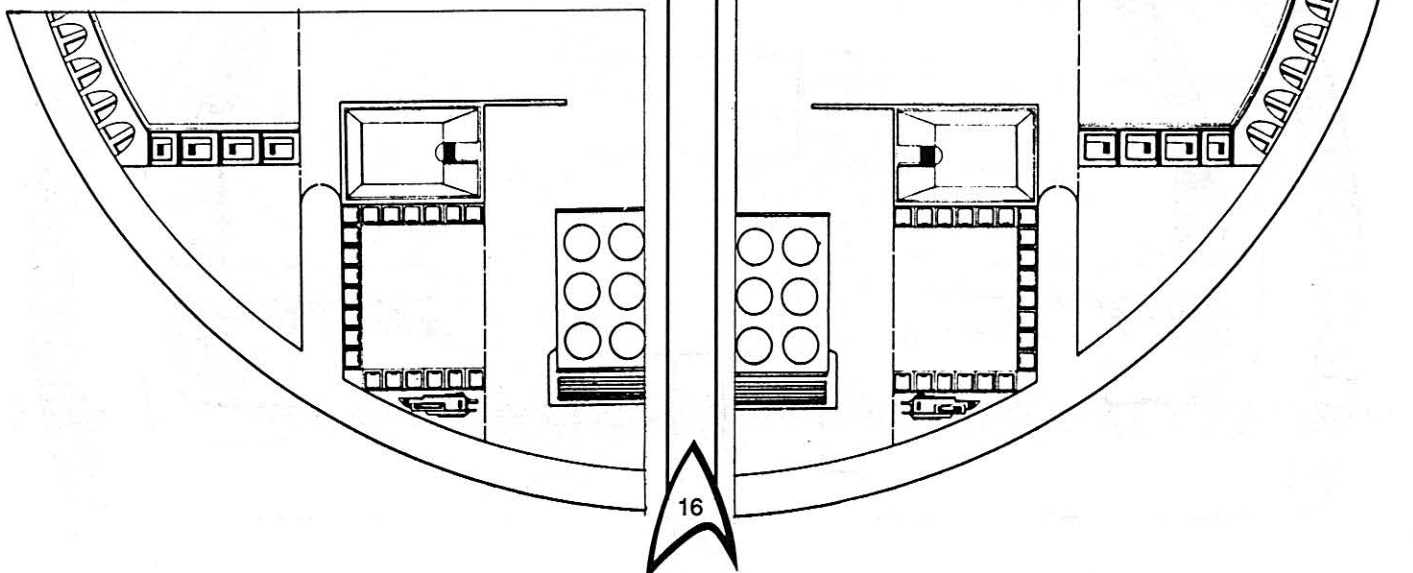

**LEVEL C: COMMUNICATIONS AND ELECTRONICS CENTER**

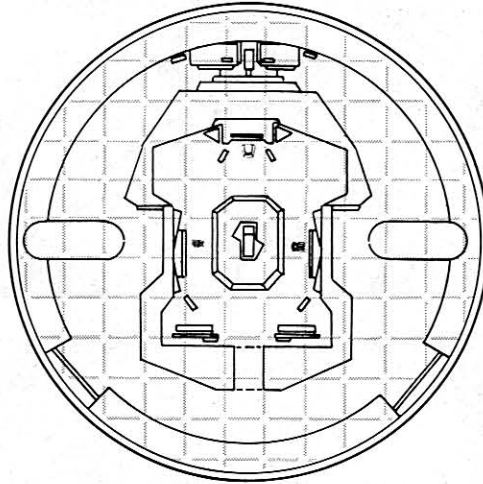
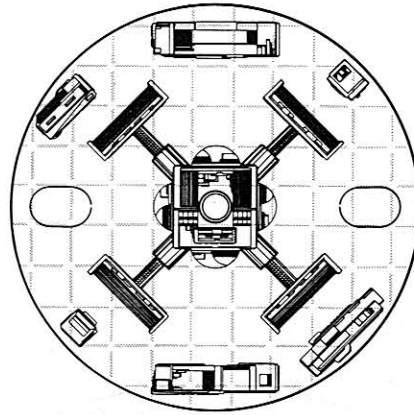

**LEVEL B: COMMAND CENTER**

**LEVEL A : WATER STORAGE AND FILTRATION**

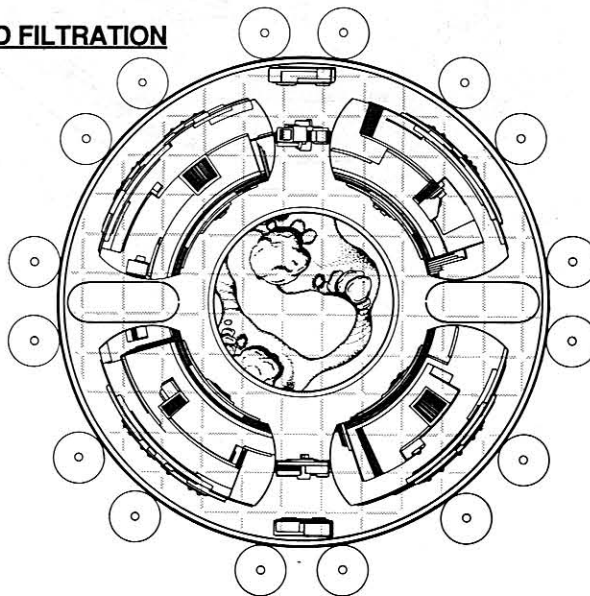

**Scale: 1 square = 3 meters**

**LEVEL 1 : PARK**



**Scale: 1 square = 3 meters**

**LEVEL 2: HYDROPONICS AND EXECUTIVE ROOMS**

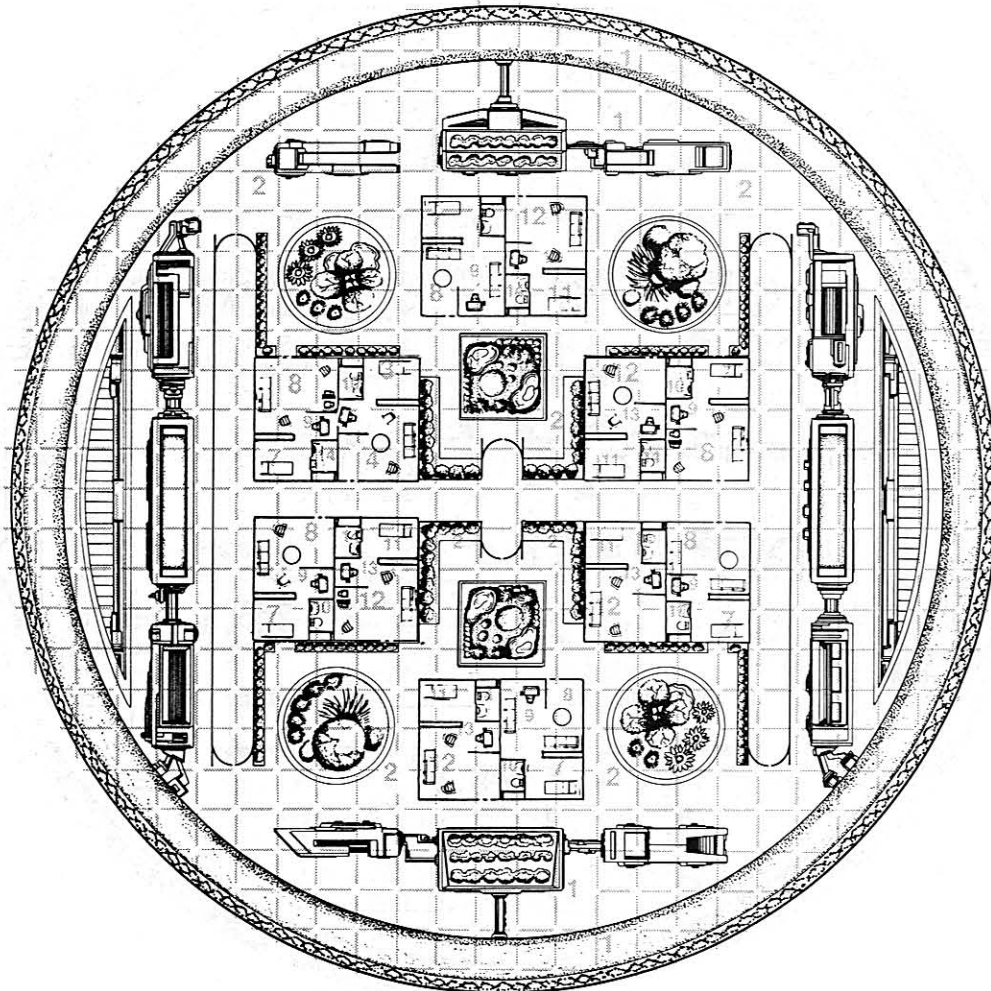

**Scale: 1 square = 3 meters**

**LEVEL 3: HYDROPONICS AND EXECUTIVE ROOMS**

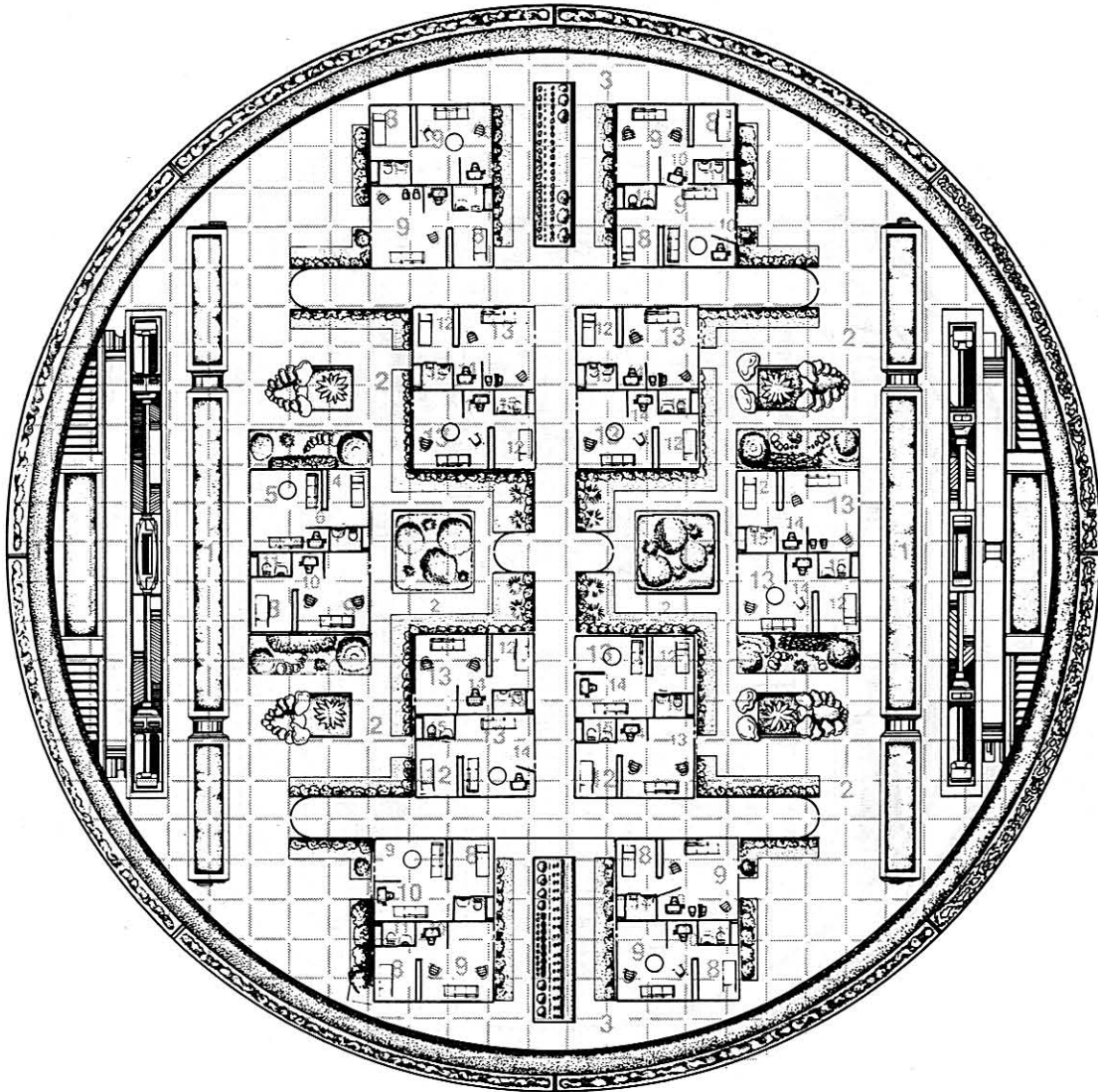

**Scale: 1 square = 3 meters**

**LEVEL 4: CREW QUARTERS AND MEDICAL FACILITIES**

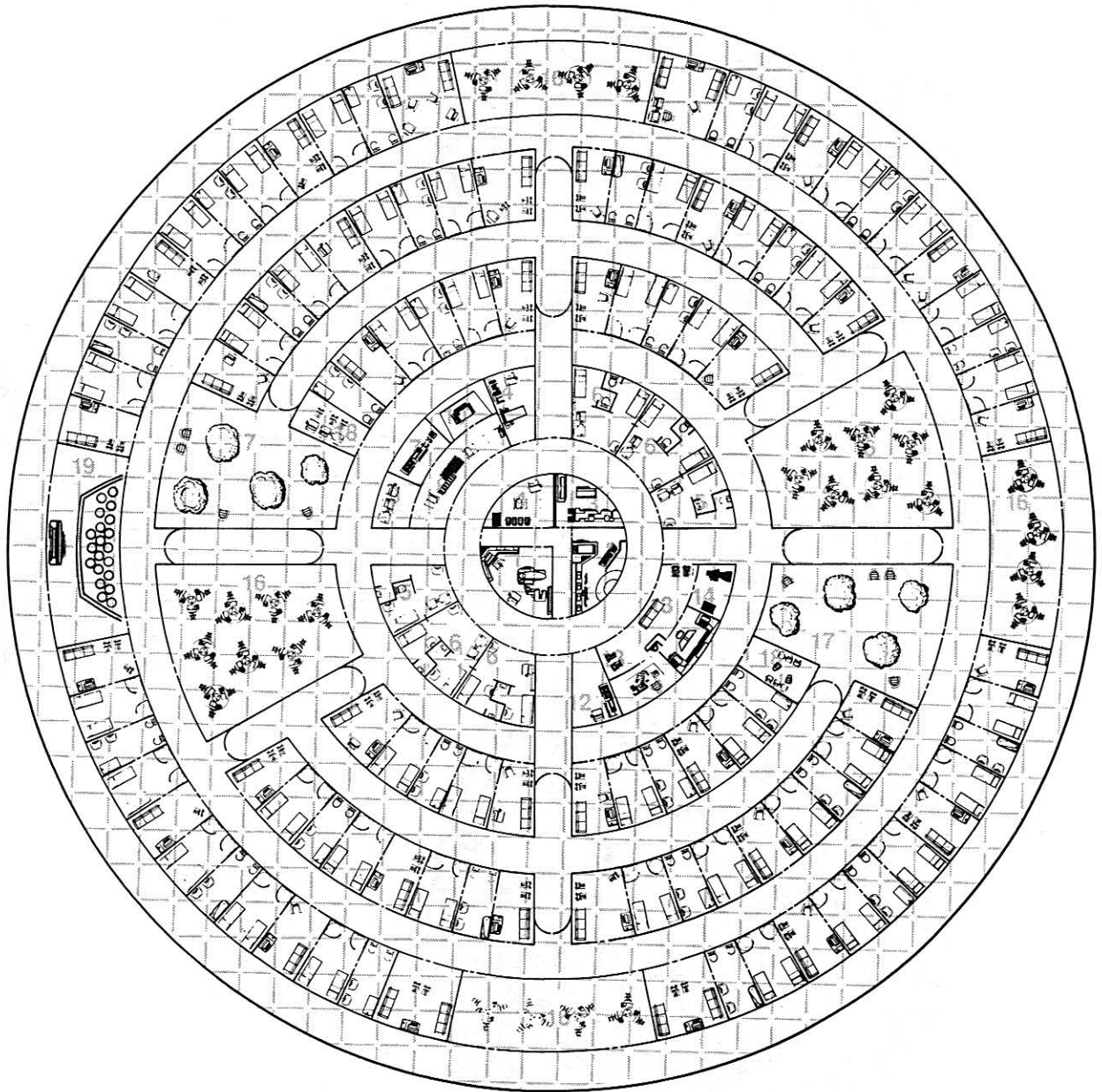

**Scale: 1 square = 3 meters**



LEVEL 15: SHIP REPAIRS AND RECEPTION

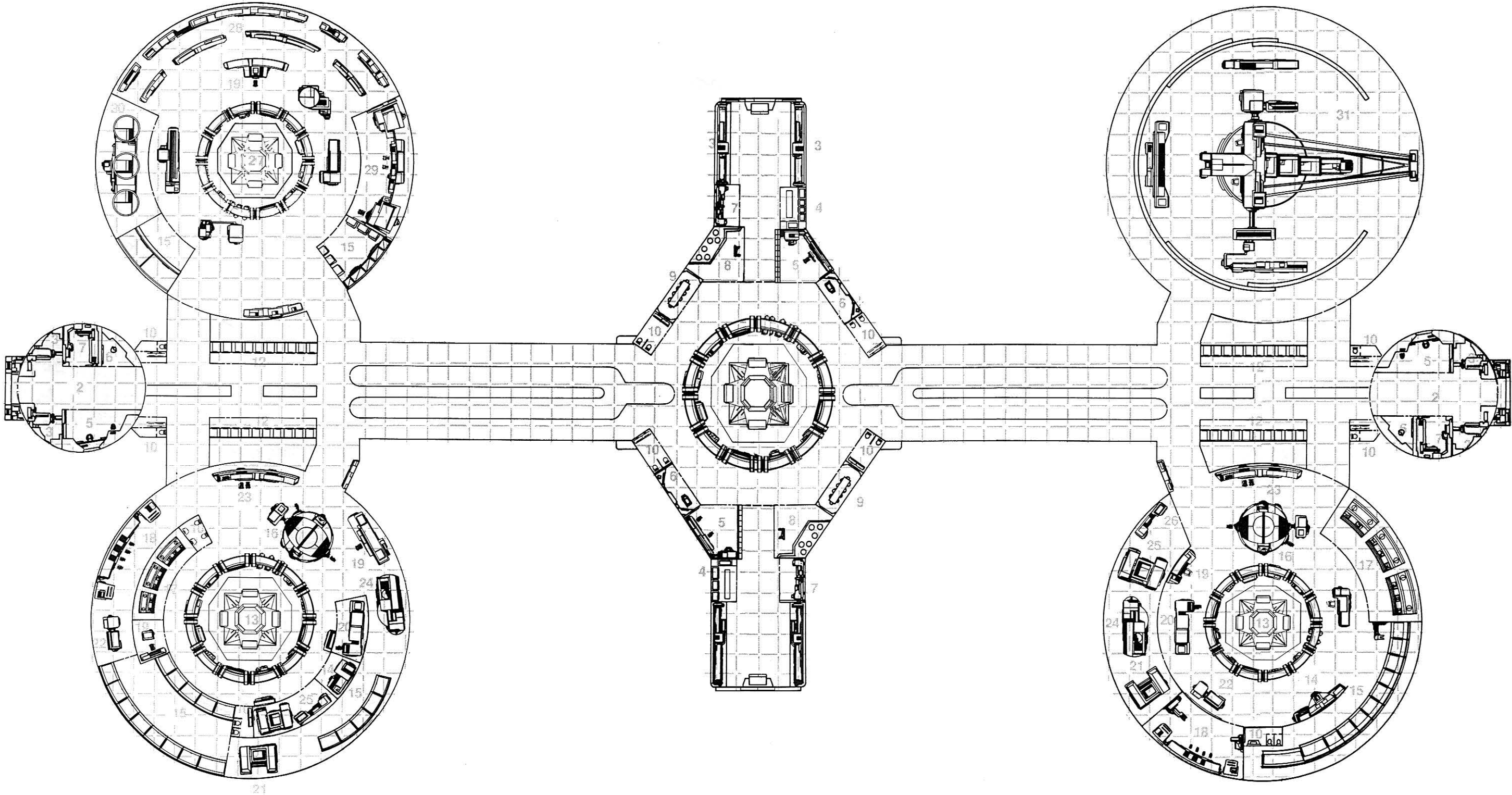

Scale: 1 square = 3 meters

**LEVEL 5: CREW QUARTERS AND COMPUTER CENTER**

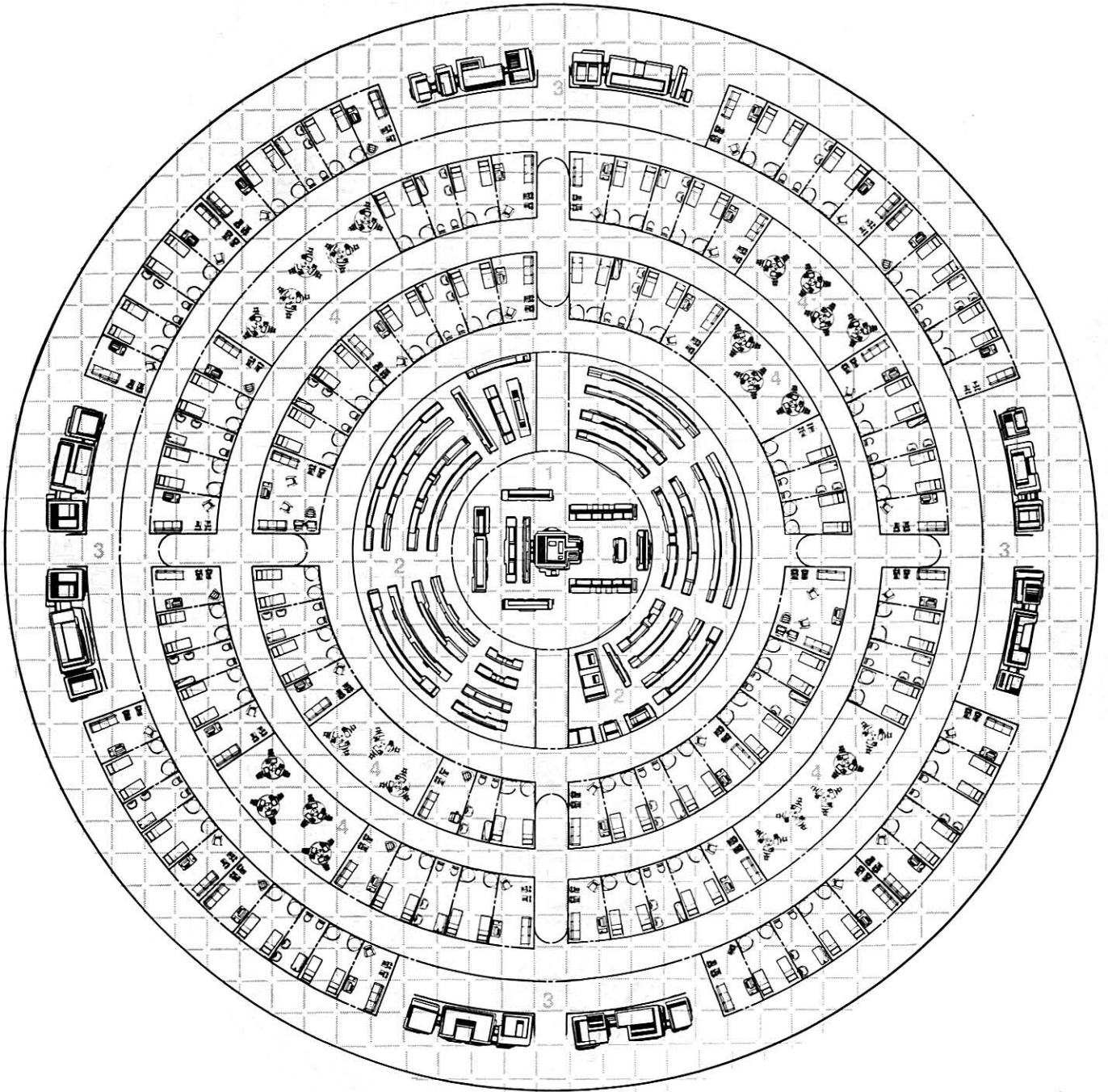

**Scale: 1 square = 3 meters**

**LEVEL 6: SHUTTLECRAFT MAINTENANCE AND REPAIR DECK**

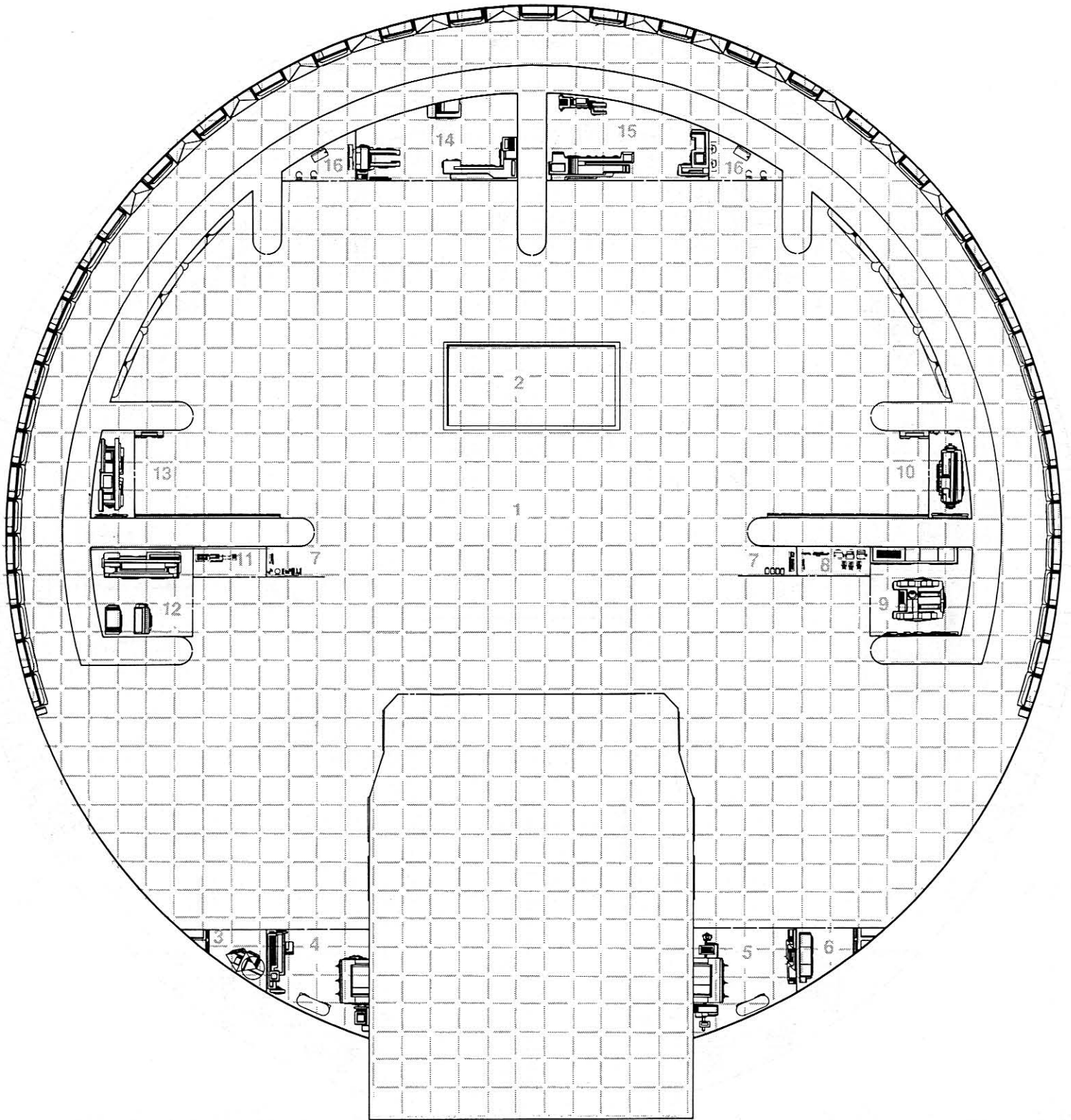

**Scale: 1 square = 3 meters**

**LEVEL 7: SHUTTLECRAFT STORAGE BAY**

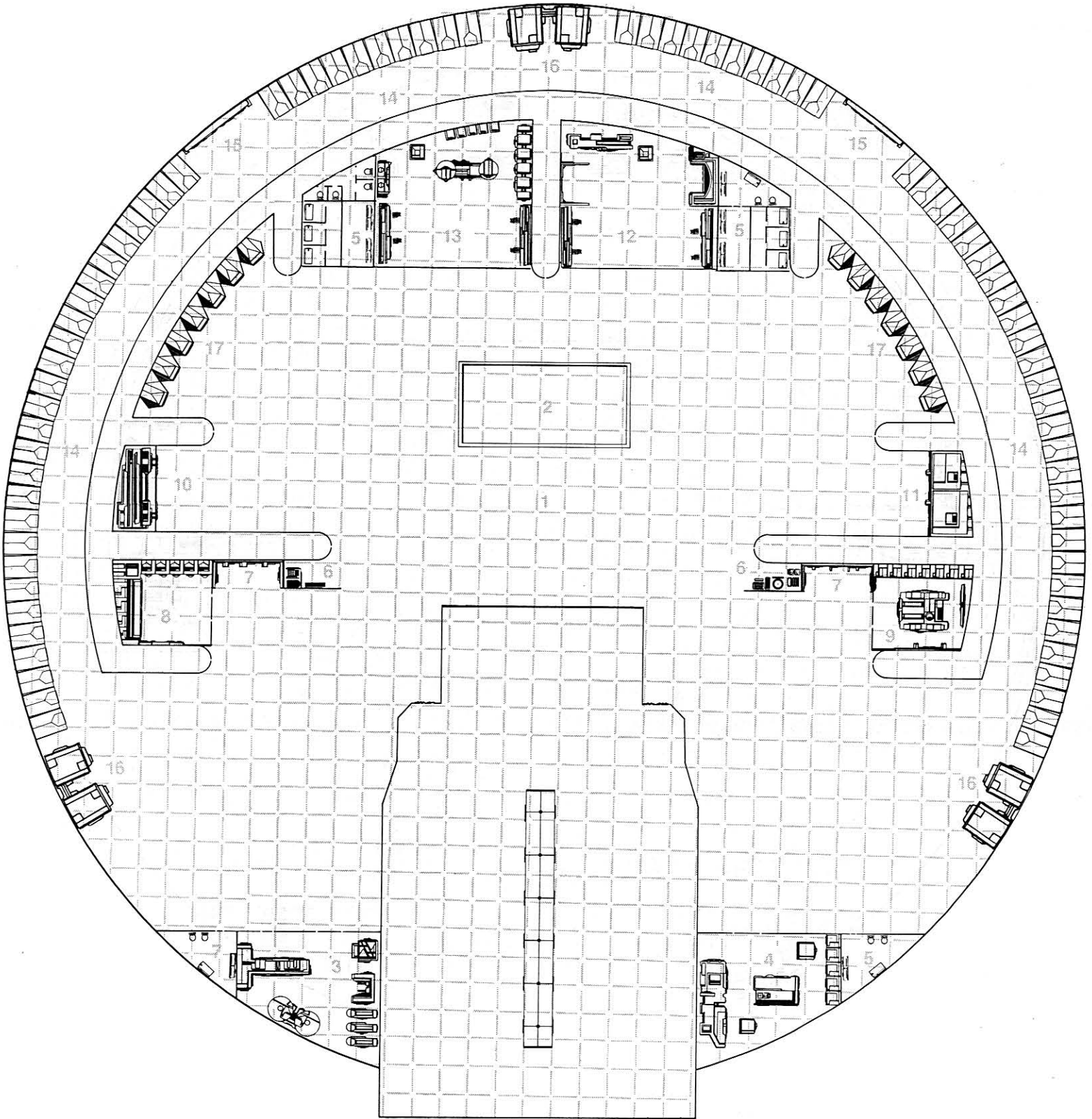

**Scale: 1 square = 3 meters**

**LEVEL 8: SHUTTLEBAY**

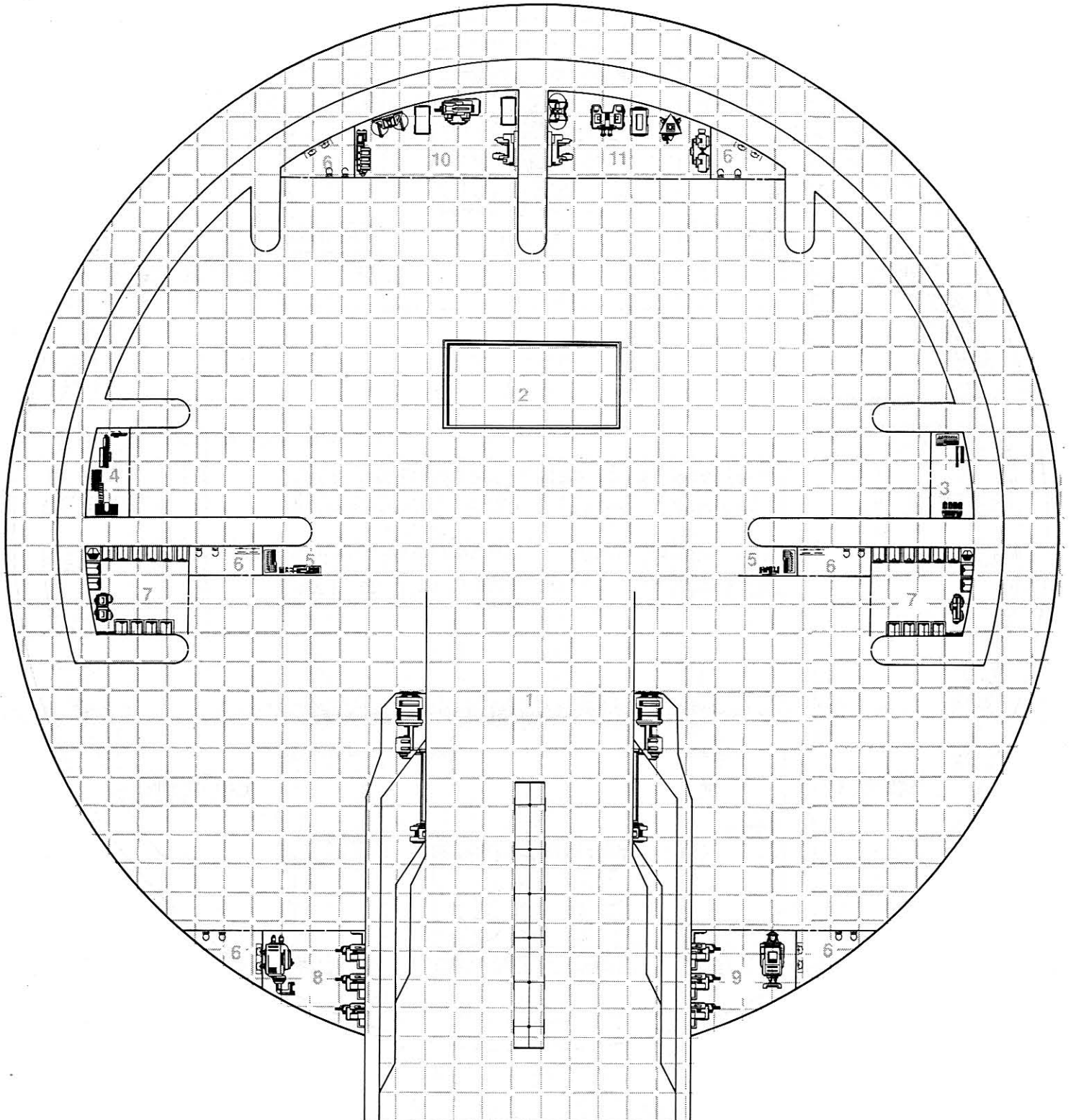

**Scale: 1 square = 3 meters**

**LEVEL 9: CARGO DECK**

REVISED 7/12/97

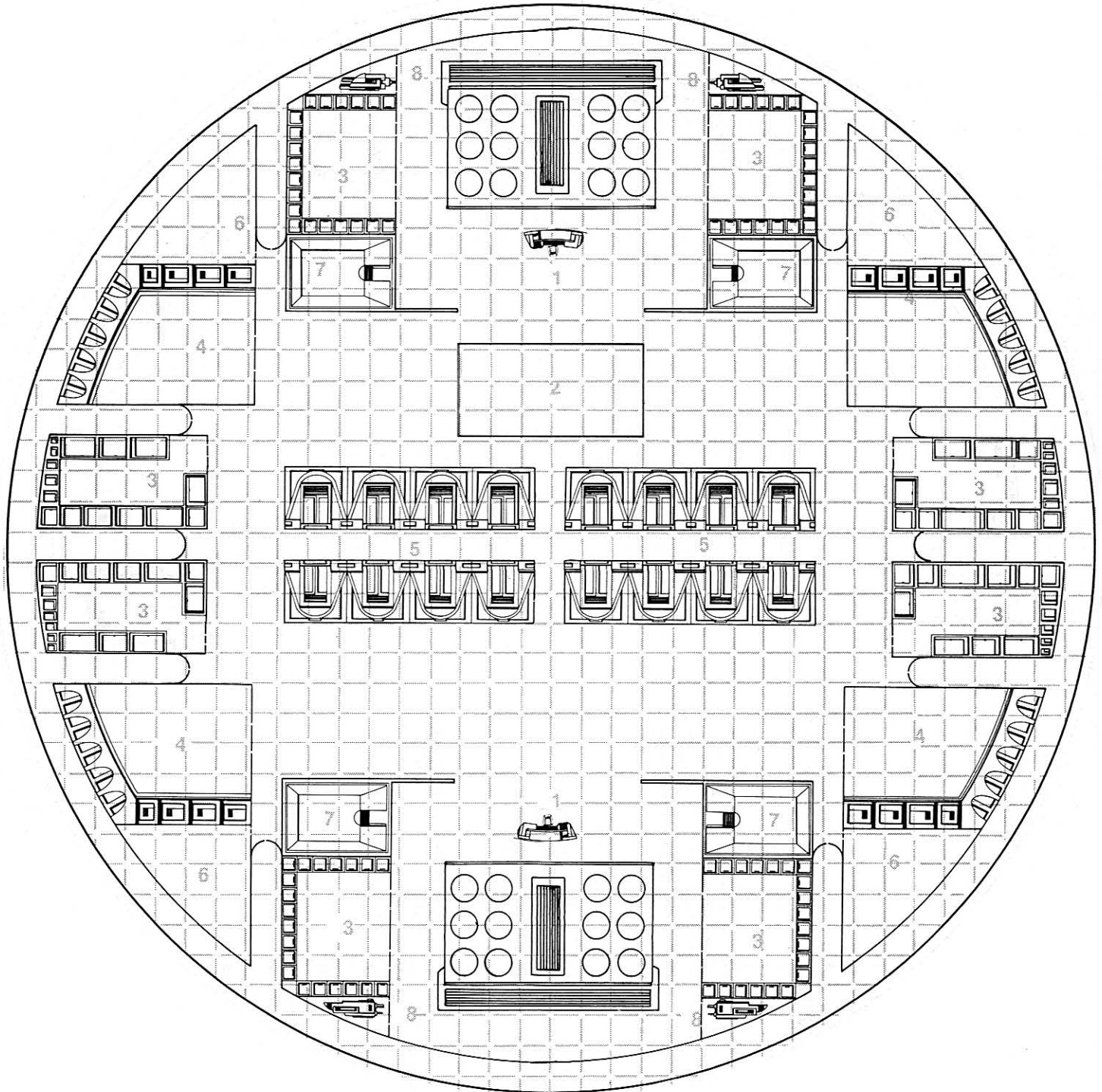

**Scale: 1 square = 3 meters**

REVISED 7/12/97

**LEVEL 10: EMERGENCY BATTERIES**

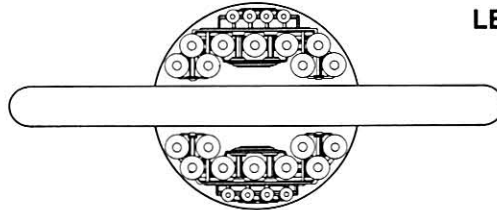

**LEVEL 11: EMERGENCY BATTERIES**

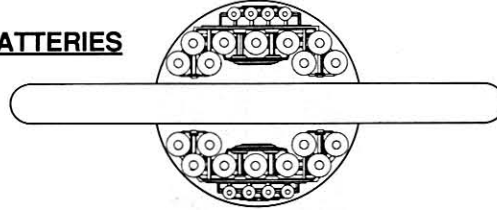

**LEVEL 12: EMERGENCY BATTERIES**

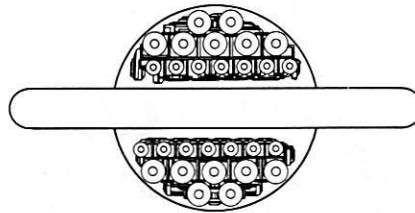

**LEVEL 13: LABS AND SCIENCES**

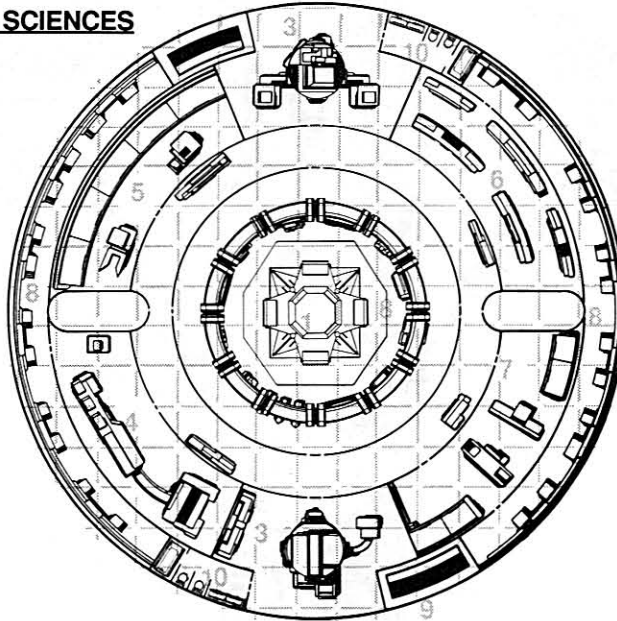

**LEVEL 14: SECURITY**

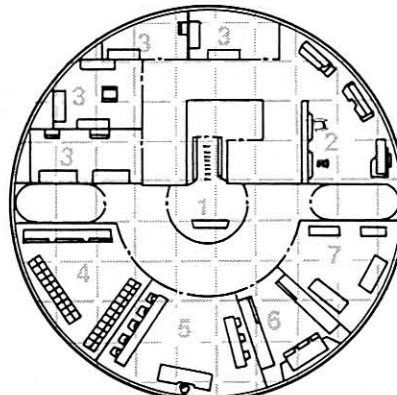

**Scale: 1 square = 3 meters**

**LEVEL 16: AIR FILTRATION AND FABRICATION**

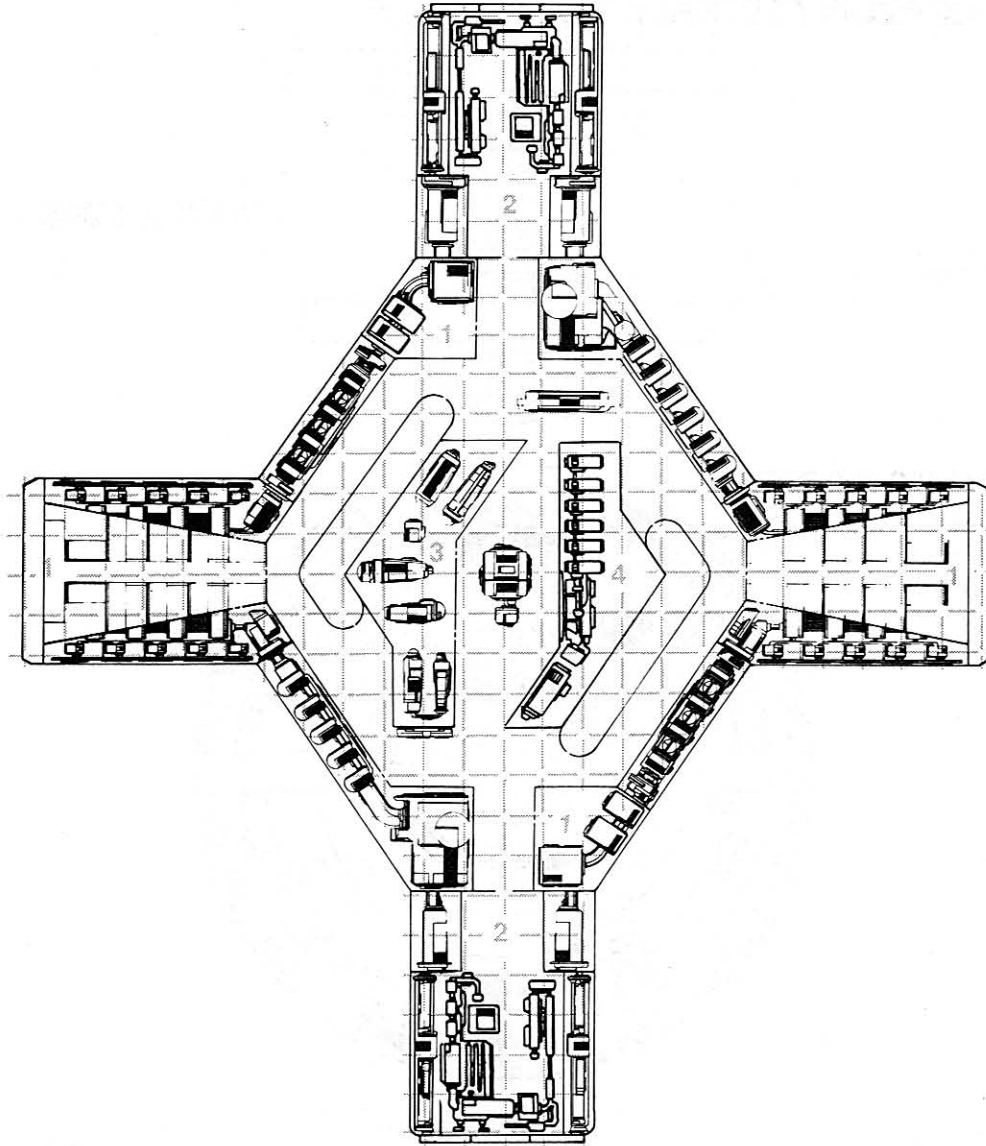

**Scale: 1 square = 3 meters**



**LEVEL 17: RECREATION**

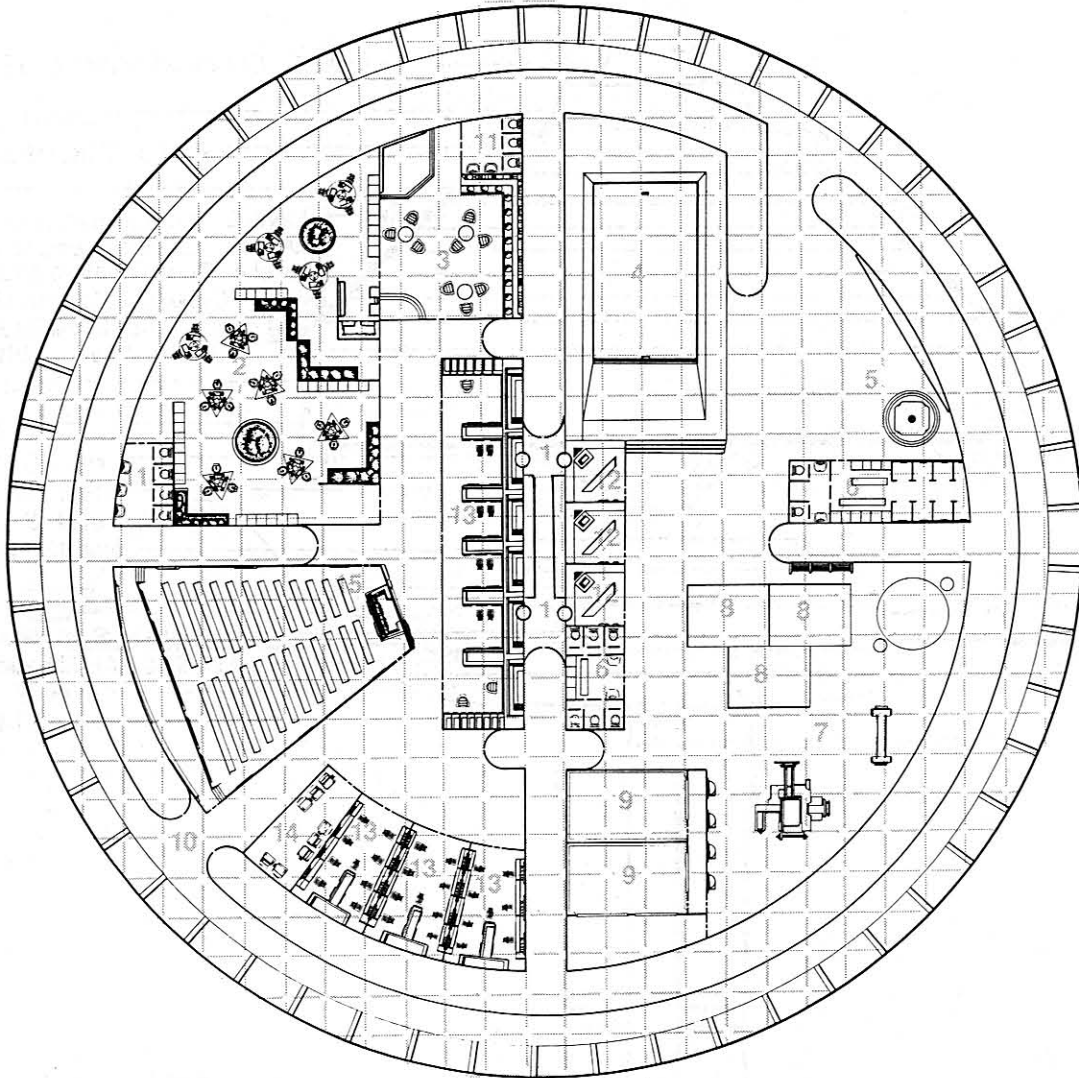

**LEVELS 18 +: ENGINEERING**

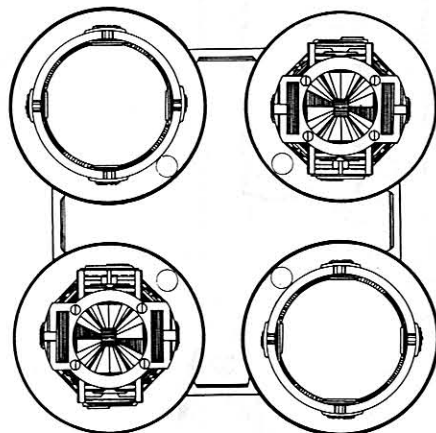

**Scale: 1 square = 3 meters**

# ELEVATION VIEW OF R-1 INVICTUS

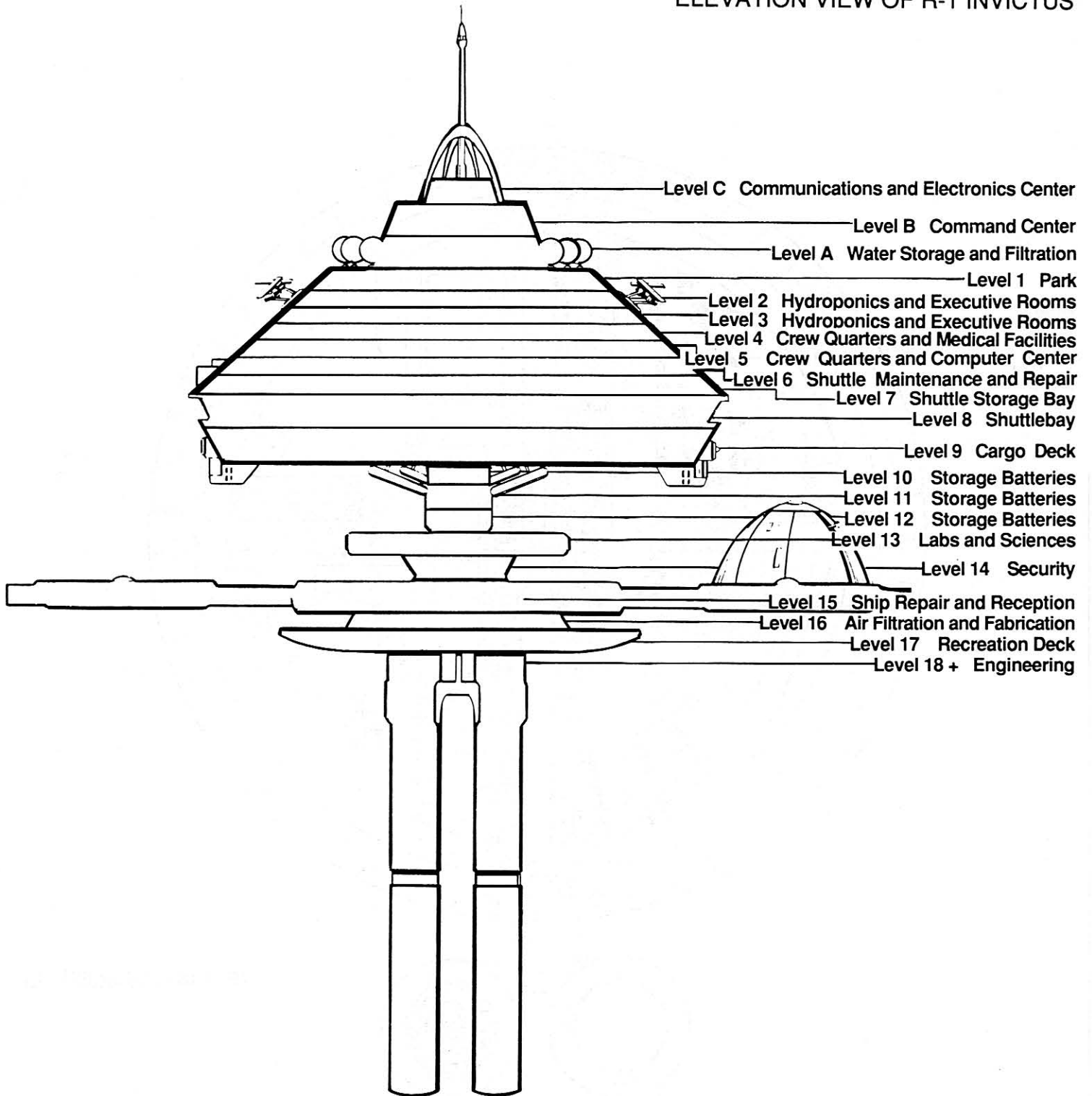

## LABS AND SCIENCES (LEVEL 13)

This level contains laboratory facilities for science research, including electronics, astronomy, and astrophysics. Three FH-8 phasers are mounted outside this deck.

### Central Science Station (1)

Sensors located on the hull of the station relay astronomical data to this science computer, which filters out star chatter and channels the data to specialized computers. Because the science computer generates extreme heat, a large ventilation tube surrounds the area, circulating and cooling the air.

### Astrogation Computer (2)

The astrogation computer contains star charts and space lanes for the known galaxy, including parts of the Gorn Alliance and the Klingon and Romulan Empires. It is constantly updated to reflect changes in astronomical bodies and the charting of new areas of space.

### Retroanalysis Computer (3)

The retroanalysis computer can determine an object's past; that is, it can discover how old an object is, what sort of energy it has experienced, and so on.

### Astronomy Lab (4)

Computers for analyzing planets, stars, nebulae, and other large astronomical bodies are located here.

### Astrophysics Lab (5)

The astrophysics lab is used for examining data on radio waves, microwaves, delta rays, subatomic particles, and so on.

### Electronics Lab (6)

This lab contains several computers and worktables for constructing and repairing electronic circuits.

### Radiation Lab (7)

Research into unusual forms of radiation, including Perthold and Celebium radiation, is conducted here.

### Storage Compartments (8)

These cabinets contain tools and replacement parts for lab equipment—everything from light bulbs to tri-phased actiforce circuits.

### Power Generators (9)

The backup power generators located in this room can supply emergency power to laboratory systems, so that experiments are not disrupted in case of a main power systems shutdown.

### Head (10)

Science personnel working on this level use these sanitary facilities.

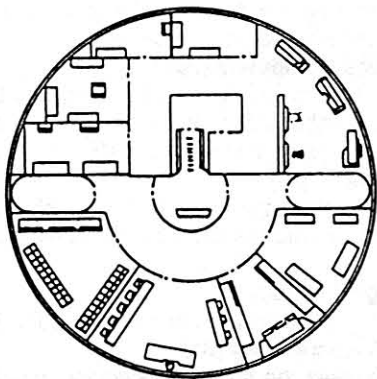

## SECURITY (LEVEL 14)

This deck houses a well-protected brig as well as storage areas for valuable, combat-oriented, and classified materials. Also located here is the courtroom, where court-martials are conducted.

### Security Admittance Room (1)

Visitors to prisoners must leave all weapons and electronic equipment in this room. Then, they pass through a sensortube, which can detect the presence of any energized device, such as a phaser or a communicator. If something sets off the sensors, warning lights flash in the tube and in the security control center. Until he passes the scan, a person cannot gain admittance to security control. After all visitors have passed the sensortube test, a security guard presses the entry button, unlocking the door and allowing the visitors to enter the security control center. Four cameras ring the security admittance room and relay images to security control.

### Security Control Center (2)

At least two security guards are always on duty here. Besides monitoring prisoners and visitors, they scan such sensitive areas as engineering, the computer room, the weapons room, and the transporter rooms.

### Cells (3)

Each cell contains a cot, sanitary facilities, and a restraining field that blocks the entryway. An invisible energy barrier, this field prevents prisoners from escaping confinement. Although contact with a restraining field is not fatal, the shock it delivers will increase as more force is applied against it. Projectiles will bounce off the field, but energy weapons can penetrate the barrier (this will not deactivate the field).

### Safe Deposit Vault (4)

The safe deposit vault is used to store valuable items, confidential documents, and evidence for court-martials.

### Courtroom (5)

The station commander convenes disciplinary hearings and court-martials in this room.

### Combat Suit Storage Room (6)

Lockers in this room contain combat uniforms and environmental suits.

### Armory (7)

The armory has several cabinets containing phasers and phaser rifles.

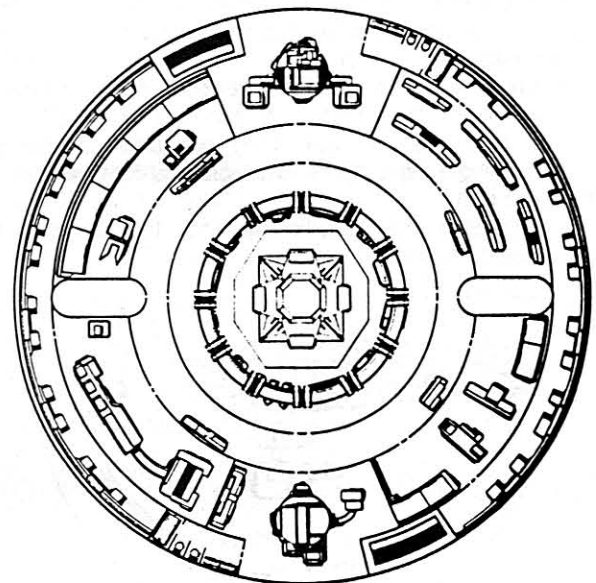

## SHIP REPAIR AND RECEPTION (LEVEL 15)

In addition to reception areas for visiting VIPs, this level contains repair facilities for Star Fleet and civilian vessels.

### Reception Bay (1)

Command personnel use the reception bay to receive visitors and VIPs whose ships dock at the station. Pressurized turbolocks at the end of these rooms fasten a vessel to the station securely and allow personnel to walk to and from the vessel without wearing environmental suits.

### Repair Bay (2)

These areas are identical to reception bays, except that ships needing repair dock here.

### Tractor/Pressor Beam Generators (3)

These tractor beams guide a ship toward the station's docking bay. When the ship is ready to leave, the pressor beams push it a safe distance away to where it may safely maneuver on its own.

### Ship's Power Monitors (4)

The computers in this room monitor the docked ships' power levels and functions so that no one need remain aboard the ships.

### Docking Control Center (5)

Duty personnel control all aspects of docking ships, including the tractor beams and turbolocks, from here.

### Backup Docking Control Center (6)

The backup docking control center is used when the docking control centers are damaged.

### Decontamination Room (7)

These rooms are used to decontaminate personnel and equipment.

### Transporter Room (8)

One six-man transporter is in this room.

### VIP Reception Lounge (9)

Station command personnel use these rooms to formally receive VIPs and visitors.

### Head (10)

These rooms contain sanitary facilities.

### Central Power Generator (11)

A massive metal framework surrounds this powerful generator, which supplies power to the level's tractor beams, decontamination rooms, repair facilities, and so on. Also, a large ventilation tube supplies oxygen to the turbolock areas and to the repair areas.

### Environmental Suit Lockers (12)

These lockers contain environmental suits for emergencies and for working in depressurized starships.

### Diagnometry Display (13)

Surrounded by a metal framework, these computer banks tie into a ship's computers and analyze all damage that the ship has received. They are also capable of reprogramming a ship's main and navigational computers.

### Fabricator (14)

Constructing only metallic materials, this fabricator is used mostly for making hullmetal.

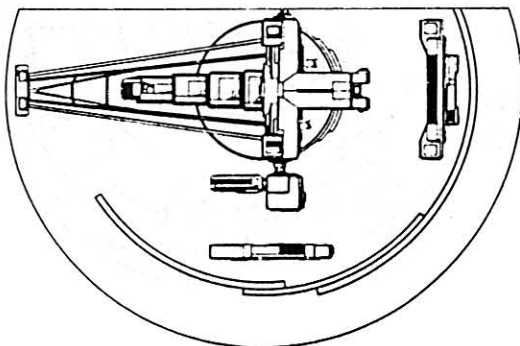

### Storage Lockers (15)

Various repair parts and tools are stored in these lockers.

### Power Generator (16)

This power generator is used to recharge a ship's emergency batteries.

### Life Support Monitor Room (17)

The computers in the life support monitor room check the efficiency of a ship's life support systems, including gravity and atmosphere control.

### Communications Switchboard (18)

Technicians coordinate repair operations in space from the communications switchboard, allowing support personnel both inside and outside the ship to work together.

### Fusion Station (19)

Support personnel can create and repair microcircuitry at the fusion station.

### Sensor Status Computer (20)

The sensor status computer feeds information to a ship's sensors and displays the sensors' reading. It then compares the inputted information to the sensor reading, thus determining sensor efficiency.

### Transporter Repair Console (21)

This console ties into a ship's transporter console to monitor the system's condition.

### Dilithium Analyzer (22)

The dilithium analyzer checks dilithium crystals for defects.

### MAM Containment Exploratory System (23)

The MAM containment exploratory system is used to discover the location of any faults in the matter/antimatter containers and the electromagnetic conduit that directs the matter and antimatter to the dilithium crystals.

### Weapons Defect Tracer (24)

Any malfunction in a ship's phaser or photon torpedo system can be located generally when the weapons defect tracer computer is tied into the ship's fire control center.

### Bridge Control Center (25)

The bridge control center computer can tie into a ship's main computer, allowing technicians to control bridge functions from this station.

### Craft Schematics Monitor (26)

This monitor can access the station's craft schematics computers (Room 28) so that personnel can see a ship's blueprints conveniently.

### Station-Ship Link Center (27)

Surrounded by a metallic framework, this massive power generator links station computers to ship computers, allowing the bridge control center (Room 25) to tie into a ship's main computer, the ship visual monitor (Room 29) to tie into a ship's security monitors, and so on.

### Craft Schematics Computers (28)

The craft schematics computers contain blueprints, electrical system schematics, and many other diagrams of most commercial, civilian, and Star Fleet ships.

### Ship Visual Monitor (29)

The ship visual computer ties into a ship's security monitors so that technicians can observe damaged portions of the ship.

### Coolant Storage Vats (30)

These large containers store coolant for warp engines.

### Observation Telescope Bay (31)

This area houses the station's telescope, which is used by off-duty personnel for stargazing.

## AIR FILTRATION AND FABRICATION (LEVEL 16)

This level houses the station's air filtration and purification systems, as well as most types of material fabricators.

### Air Purification System (1)

This internal atmosphere purification system recycles the station's air.

### Waste Treatment System (2)

These rooms contain automated solid and liquid waste disposal and reclamation facilities.

### Fabrication Center (3)

The fabrication center holds organic, metallic, and nonmetallic fabricators, which take raw materials from storage and convert them into desired items.

### Laundry (4)

The laundry room contains cleaning facilities for any washable item that a crewmember does not wish to have broken down and reconstructed.

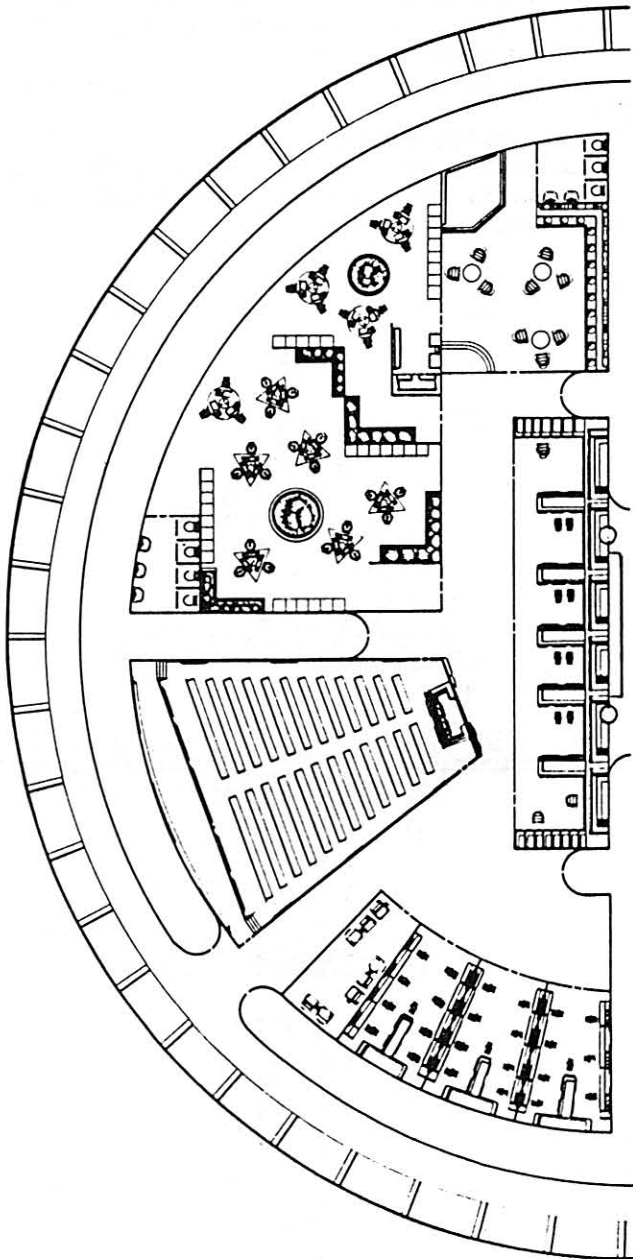

## RECREATION DECK (LEVEL 17)

This level accommodates the various recreational needs of the station's crew. Located here are the station's library, theater, gymnasium, and private rooms with audio and visual recordings. Large observation windows surround this deck.

### Engineering Turbolift (1)

These turbolifts lead down into the engineering sections.

### Garden Dining Area (2)

Numerous exotic plants and shrubs surround these dining facilities. Crewmembers may use the adjoining galley to prepare and cook any type food that they desire.

### Lounge (3)

This is the only lounge on the entire station that serves alcoholic beverages. Musical groups can also perform on the room's small stages.

### Swimming Pool (4)

Personnel swim and play an occasional game of water polo here.

### Hot Tub (5)

The hot tub pumps hot water continuously and accommodates 15–20 people.

### Locker Room (6)

The locker room contains benches, lockers, showers, and a head.

### Gymnasium (7)

This gymnasium contains free weights, weight machines, and a circular boxing ring.

### Competition Courts (8)

Personnel may play handball, racquetball, or squash in these transparent courts.

### Zero-G Courts (9)

Though these courts are similar to competition courts (Room 8), their gravity can be reduced for null-gravity competition.

### Running Track (10)

This track surrounds the level and allows personnel to run, jog, or race-walk.

### Head (11)

These are sanitary facilities.

### Viewing Rooms (12)

Viewing rooms contain terminals that show two-dimensional movies and shows.

### Station Library (13)

Station crewmembers can access library datacards in these rooms.

### Game Room (14)

Various 2-D and 3-D computer games fill this room.

### Station Theater (15)

Crewmembers and visiting actors and actresses can present theatrical performances here. Tri-dimensional holographic films are also shown here.

## ENGINEERING (LEVELS 18+)

The four cylindrical pods below the orbital station contain the station's main power generators and distribution systems. A small turboelevators runs from the top of each pod to the bottom. Located here are the well-shielded warp and impulse engines, as well as most pieces of heavy machinery and electronics.

# VARIANTS

The following section provides specific information, including mission parameters, layout modifications, and items of special interest, concerning the other kinds of *R-1* Type orbital stations. Also provided is any variation of level design with the *R-1 Invictus*.

## R-1 INVESTIGATOR TYPE ORBITAL RESEARCH STATION

<b>Construction Data:</b>	
<i>Date Entering Service—</i>	2/0902
<i>Number Constructed—</i>	22
<b>Hull Data:</b>	
<i>Superstructure Points—</i>	40
<i>Damage Chart—</i>	Outpost
<b>Size</b>	
<i>Diameter—</i>	200 m
<i>Length—</i>	215 m
<i>Weight—</i>	854,000 mt
<b>Cargo</b>	
<i>Cargo Units—</i>	200 SCU
<i>Cargo Capacity—</i>	10,000 mt
<i>Landing Capability—</i>	None
<b>Equipment Data:</b>	
<i>Control Computer Type—</i>	L-14
<i>Transporters—</i>	
<i>standard 6-person cargo</i>	1
	2
<b>Other Data:</b>	
<i>Crew—</i>	150
<i>Visitors—</i>	20
<i>Shuttlecraft—</i>	0-8
<b>Engines and Power Data:</b>	
<i>Total Power Units Available—</i>	114
<i>Movement Point Ratio—</i>	10/1
<i>Matter-Antimatter Power Generator Type—</i>	
<i>Number—</i>	FMAPG-1
<i>Power Units Available—</i>	1
<i>Impulse Power Generator Type—</i>	98
<i>Power Units Available—</i>	FIPG-1
<i>Power Units Available—</i>	16
<b>Weapons and Firing Data:</b>	
	None
<b>Shields Data:</b>	
<i>Deflector Shield Type—</i>	Navigational Only

## STATION NOTES

The *R-1 Investigator* Type orbital research station enables scientists to pursue research in secrecy and far from support installations. Designed to provide maximum comfort and utility for both research staff and support personnel, the *R-1 Investigator* can operate for up to 18 months without resupply. Traditionally, the stations are named after the planet they orbit; *e.g.*, Lyrae Nicbe 1, Regula 1, and Vulcan 1. Though based on the standard *R-1* design, the *Investigator* has the following modifications.

### Botany Studies (Level 1)

Besides offering a park area, this level contains numerous floral specimens for study under different climatic conditions. Environmental control facilities allow scientists to examine specimen reaction to almost any climate. Automated systems running below this level regulate floral growth.

### Specialized Labs (Level 15)

Extensive research labs replace most of the repair facilities on this level. This is where scientists work on their primary research experiments.

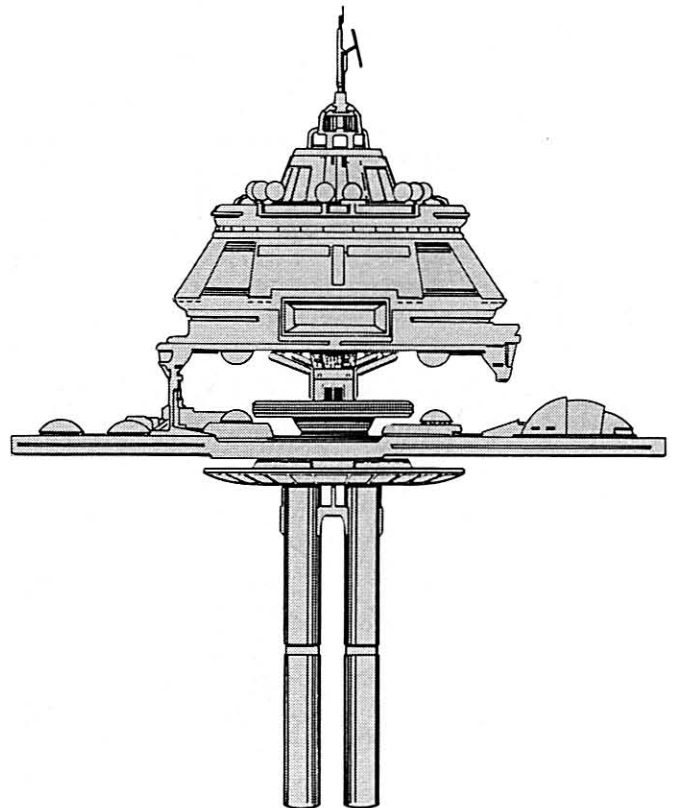



## R-1 ADMINISTRATOR TYPE ORBITAL ADMINISTRATIVE CENTER

### Construction Data:

*Date Entering Service—* 2/1409  
*Number Constructed—* 20

### Hull Data:

*Superstructure Points—* 40  
*Damage Chart—* Outpost  
*Size*  
Diameter— 200 m  
Length— 215 m  
Weight— 780,000 mt

### Cargo

*Cargo Units—* 200 SCU  
*Cargo Capacity—* 10,000 mt  
*Landing Capability—* None

### Equipment Data:

*Control Computer Type—* L-14

*Transporters—*  
standard 6-person cargo 4  
cargo 1

### Other Data:

*Crew—* 50  
*Visitors—* 75 (100 in housing)

### development center)

*Shuttlecraft—* 0-4  
*Travel Pods—* 0-4

### Engines and Power Data:

*Total Power Units Available—* 114  
*Movement Point Ratio—* 10/1  
*Matter-Antimatter Power Generator Type—* FMAPG-1  
*Number—* 1

*Power Units Available—* 98  
*Impulse Power Generator Type—* FIPG-1  
*Power Units Available—* 16

### Weapons and Firing Data:

*Shields Data:* None

### Shields Data:

*Deflector Shield Type—* Navigational Only

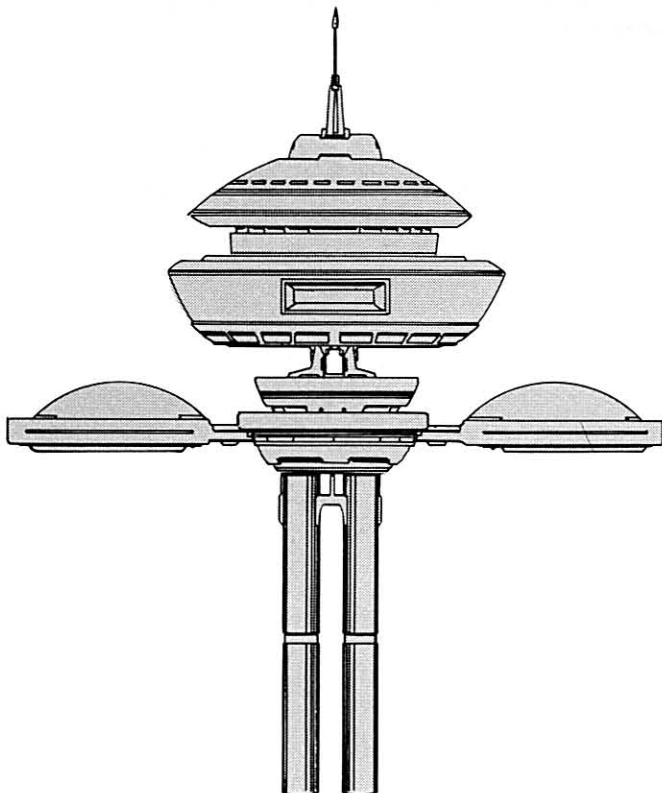

## STATION NOTES

Clearly the most versatile *R-1* design, the *R-1 Administrator* Type orbital administrative center functions as accommodations and centralized administrative headquarters for both private and government organizations. Since its inception, this variant has been adapted to provide luxury housing and to secure historical and governmental documents.

Star Fleet Command owns all administrative complexes and leases them to developers, who offer the office, living, and dining accommodations to business clientele. The housing development center furnishes luxury accommodations for visiting businessmen who find the local planetary conditions too harsh or the housing facilities inadequate. Both the housing center and the administrative complex are based on the basic *R-1* design, with the following modifications.

### Restaurant Deck (Level A)

This entire area has been remodeled as large dining facilities with a 360° view of space.

### Greenhouse Level (Level 1)

The hydroponics located here have been expanded to include more varieties of floral specimens. The housing development center variant also contains luxury family accommodations here.

### Conference Area (Level 2)

This level has private conference and presentation rooms with communication equipment that permits anyone on the station or planetside to participate in the meeting. The housing development center variant also has luxury family dwellings here.

### Dining Facilities (Level 3)

Located here are banquet halls and private dining rooms accommodating up to 300 people. In the housing development center variant, this level also contains luxury family dwellings.

### Dancing Hall (Level 9)

Like Level A, this level allows a 360-degree view of space. Acoustical systems and a band stage surround the dance floor, and environmental systems can program regular, low, or zero-gravity conditions for the entire level or selected areas.

### Display Area (Level 13)

This level is reserved for corporate product displays and other marketing projects.

### Recreational Level (Level 15)

In place of repair facilities, four separate sports and recreational areas are maintained in domed enclosures on this level. The housing development center also contains daycare centers and educational facilities.

### Transporter Bay (Level 16)

All station transporter systems are located here.



## R-1 INFORMANT TYPE DEEP-SPACE SURVEILLANCE SYSTEM

<b>Construction Data:</b>	
<i>Date Entering Service—</i>	2/1801
<i>Number Constructed—</i>	30
<b>Hull Data:</b>	
<i>Superstructure Points—</i>	40
<i>Damage Chart—</i>	Outpost
<i>Size</i>	
Diameter—	200 m
Length—	215 m
Weight—	803,000 mt
<i>Cargo</i>	
Cargo Units—	200 SCU
Cargo Capacity—	10,000 mt
Landing Capability—	None
<b>Equipment Data:</b>	
<i>Control Computer Type—</i>	M-1
<i>Transporters—</i>	
standard 6-person	2
emergency 22-person	1
cargo	1
<b>Other Data:</b>	
<i>Crew—</i>	120
<i>Visitors—</i>	10
<i>Shuttlecraft—</i>	0-2
<b>Engines and Power Data:</b>	
<i>Total Power Units Available—</i>	114
<i>Movement Point Ratio—</i>	10/1
<i>Matter-Antimatter Power Generator Type—</i>	
Number—	1
Power Units Available—	98
<i>Impulse Power Generator Type—</i>	
Power Units Available—	FIPG-1 16
<b>Weapons and Firing Data:</b>	
<i>Beam Weapon Type—</i>	
Number—	FH-4 6
Firing Arcs—	2/arc
Firing Chart—	Q
Maximum Power—	3
<i>Damage Modifiers—</i>	
+2	(1-8)
+1	(9-14)
<i>Missile Weapon Type—</i>	
Number—	FP-2 3
Firing Arcs—	1/arc
Firing Chart—	H
Power to Arm—	1
Damage—	6
<b>Shields Data:</b>	
<i>Deflector Shield Type—</i>	OFSA
<i>Shield Point Ratio—</i>	1/2
<i>Maximum Shield Power—</i>	16
<b>Combat Efficiency:</b>	
<i>D—</i>	113.1
<i>WDF—</i>	21.6

### STATION NOTES

The *R-1 Informant* Type deep-space surveillance center is assigned to gather, analyze, and evaluate intelligence for Star Fleet Intelligence Command. Positioned along border regions, these stations contain sophisticated computer systems capable of monitoring enemy ship movements, data transmissions, and natural phenomena, as well as broadcasting counterintelligence and conducting electronic warfare operations. The station is based on the standard *R-1* design, with the following modifications.

#### Secondary Sensors and Communications (Levels C and A)

These levels contain specialized sensor computers, scrambling and unscrambling computers, and communications computers that can receive, decode, or jam enemy subspace radio transmissions.

#### Remote Drone Launch Bay (Level 8)

The station's long-range surveillance drones are launched from here.

#### Photographic Analysis Center (Level 13)

Intelligence agents analyze sensor photographs here.

#### Security Deck (Level 14)

The brig has been enlarged to include several interrogation rooms.

#### Primary Sensor Arrays (Level 15)

Long-range sensor arrays in domed enclosures provide the station with general information.

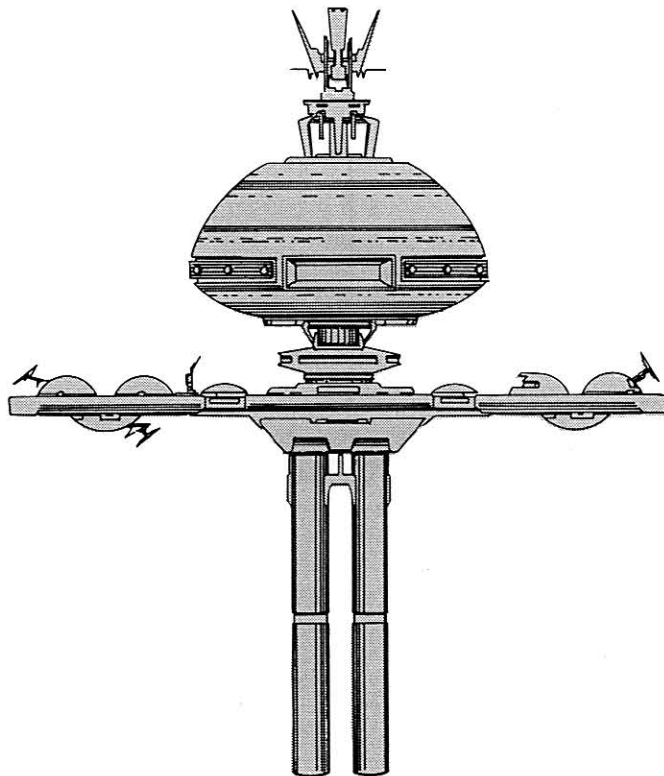

## R-1 HARMONYTYPE RECREATIONAL FACILITY

### Construction Data:

*Date Entering Service*— 2/2002  
*Number Constructed*— 2

### Hull Data:

*Superstructure Points*— 40  
*Damage Chart*— Outpost  
*Size*  
 Diameter— 200 m  
 Length— 250 m  
 Weight— 895,000 mt

### Cargo

*Cargo Units*— 200 SCU  
*Cargo Capacity*— 10,000 mt  
*Landing Capability*— None

### Equipment Data:

*Control Computer Type*— L-14  
*Transporters*—  
 standard 6-person cargo 6  
 cargo 2

### Other Data:

*Crew*— 75  
*Visitors*— 120  
*Shuttlecraft*— 0-2  
*Travel Pods*— 12

### Engines and Power Data:

*Total Power Units Available*— 114  
*Movement Point Ratio*— 10/1  
*Matter-Antimatter Power Generator Type*— FMAPG-1  
 Number— 1  
 Power Units Available— 98  
*Impulse Power Generator Type*— FIGP-1  
 Power Units Available— 16

### Weapons and Firing Data:

None

### Shields Data:

*Deflector Shield Type*— Navigational Only

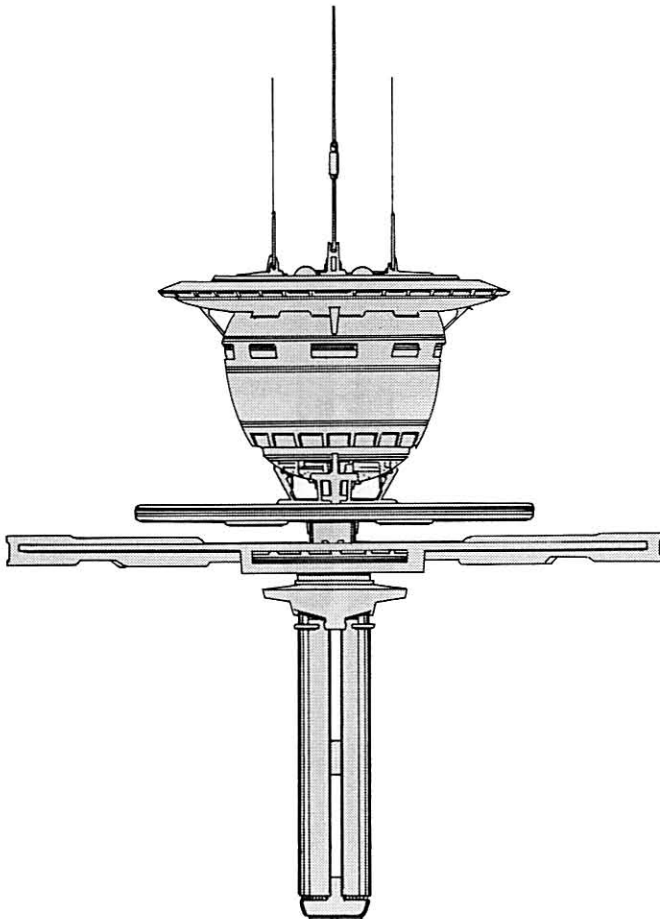

## STATION NOTES

The *R-1 Harmony* Type recreational facility provides a wide spectrum of entertainment opportunities for tourists from all over the Federation. The station's living accommodations make the *Harmony* a popular vacation spot and cultural exchange point. Though based on the standard *R-1* design, the station has the following modifications.

### Observation Deck (Level A)

This entire area has been remodeled as dining facilities with a 360-degree view of space.

### Casino Level (Level 1)

The casino level offers every game of chance found in the Federation and the Orion Colonies. All gambling is subject to house rules.

### Thematic Fantasy Level (Level 2)

These computer-controlled facilities can recreate the precise look and feel of different historical, modern, and fantasy periods from over three dozen Federation worlds.

### Cabaret (Level 3)

Each of the cabaret's dozen large and small night clubs duplicate famous entertainment spots from somewhere in the galaxy.

### Bazaar (Level 4)

This entire level is devoted to the sale of rare and expensive luxury items from Federation and Orion Colony worlds. The station management imposes a small duties fee on all sales conducted here.

### Food Preparation Center (Level 7)

Besides storing shuttlecraft and travel pods, this level supports a large kitchen staffed by noted culinary experts, who cook all the food on the station. There are also a few cafes and dining areas on this level.

### Dining Level (Level 9)

This is the main dining area for station guests, containing both private and banquet facilities.

### Wine Cellar (Level 10)

The wine cellar contains a wide variety of vintage wines, brandies, and liqueurs from Federation and non-Federation markets.

### Zoological Park Level (Level 13)

Numerous land and aquatic life forms reside here in computer-replicated natural habitats.

### Security and Finance Area (Level 14)

A branch of the Bank of Andor operates here, facilitating guests' financial transactions through subspace transfer of funds.

### Docking and Reception Area (Level 15)

In addition to the standard docking and reception facilities found on all *R-1* Type stations, this area contains zero-gravity recreation centers and bathing facilities simulating famous beach and water sport centers.

## R-1 MERCY TYPE ORBITAL MEDICAL CENTER

<b>Construction Data:</b>	
<i>Date Entering Service—</i>	2/2202
<i>Number Constructed—</i>	2
<b>Hull Data:</b>	
<i>Superstructure Points—</i>	40
<i>Damage Chart—</i>	Outpost
<i>Size</i>	
Diameter—	200 m
Length—	250 m
Weight—	895,000 mt
<i>Cargo</i>	
Cargo Units—	200 SCU
Cargo Capacity—	10,000 mt
Landing Capability—	None
<b>Equipment Data:</b>	
<i>Control Computer Type—</i>	L-14
<i>Transporters—</i>	
standard 6-person	6
emergency 22-person	1
cargo	1
<b>Other Data:</b>	
<i>Crew—</i>	100
<i>Patients—</i>	200
<i>Shuttlecraft—</i>	0-4
<i>Travel Pods—</i>	12
<b>Engines and Power Data:</b>	
<i>Total Power Units Available—</i>	114
<i>Movement Point Ratio—</i>	10/1
<i>Matter-Antimatter Power Generator Type—</i>	
Number—	1
Power Units Available—	98
<i>Impulse Power Generator Type—</i>	
Power Units Available—	FIPG-1
Power Units Available—	16
<b>Weapons and Firing Data:</b>	
None	
<b>Shields Data:</b>	
<i>Deflector Shield Type—</i>	Navigational Only

### STATION NOTES

The *R-1 Mercy* Type orbital medical center functions both as a research center for medicine and xenobiology and as a hospital for treating medical emergencies in the far-flung regions of Federation space. In time of war, these stations can operate just behind the frontlines, allowing medical personnel to treat the maximum number of wounded in the shortest possible time. The *R-1 Mercy* is based on the standard *R-1* design, with the following modifications.

#### Patient Wards (Levels 2-4)

Capable of handling up to 200 patients, these levels contain support stations and diagnostic computers for monitoring patients.

#### Administrative Level (Level 7)

Besides storing shuttlecraft, this deck contains administrative offices and conference rooms.

#### Medical Research Labs (Level 15)

Several medical laboratories replace the repair bays of the standard *R-1* Type station. The radiology lab allows medical personnel to conduct tests on and treat victims of radiation poisoning. The prosthetics lab contains artificial limbs, organs, and implants for disfigured persons of almost every Federation race.

#### Surgical Ward (Level 16)

The surgical ward includes 20 operating rooms, as well as postoperative and recovery rooms.

#### Dining Level (Level 17)

These dining facilities serve both staff and visitors.

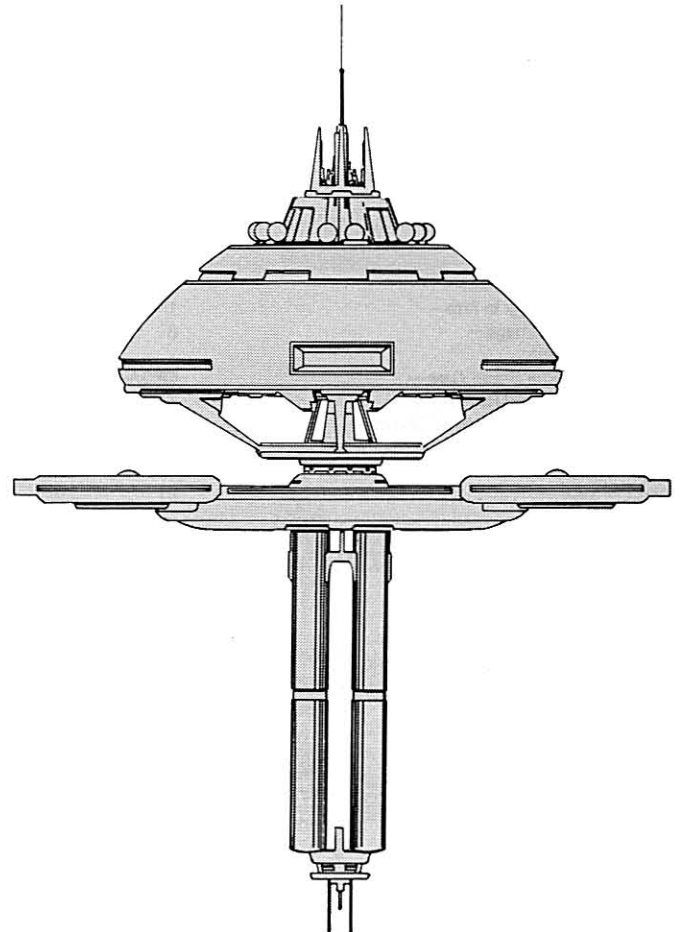

## R-1 TERMINUS TYPE ORBITAL PENAL INSTALLATION

### Construction Data:

*Date Entering Service*— 2/2303  
*Number Constructed*— 2

### Hull Data:

*Superstructure Points*— 40  
*Damage Chart*— Outpost  
*Size*  
Diameter— 250 m  
Length— 260 m  
Weight— 975,000 mt

### Cargo

*Cargo Units*— 200 SCU  
*Cargo Capacity*— 10,000 mt  
*Landing Capability*— None

### Equipment Data:

*Control Computer Type*— M-1  
*Transporters*—  
standard 6-person 2  
emergency 22-person 1  
cargo 1

### Other Data:

*Crew*— 80  
*Inmates*— 150  
*Shuttlecraft*— 0-4

### Engines and Power Data:

*Total Power Units Available*— 114  
*Movement Point Ratio*— 10/1  
*Matter-Antimatter Power Generator Type*— FMAPG-1  
Number— 1  
Power Units Available— 98  
*Impulse Power Generator Type*— FIGP-1  
Power Units Available— 16

### Weapons and Firing Data:

*Beam Weapon Type*— FH-3  
Number— 3  
Firing Arcs— 1/arc  
Firing Chart— W  
Maximum Power— 5  
*Damage Modifiers*—  
+3 (1-10)  
+2 (11-17)  
+1 (18-20)  
*Missile Weapon Type*— FP-3  
Number— 3  
Firing Arcs— 1/arc  
Firing Chart— D  
Power to Arm— 1  
Damage— 6

### Shields Data:

*Deflector Shield Type*— OFSA  
Shield Point Ratio— 1/2  
Maximum Shield Power— 16

### Combat Efficiency:

*D*— 113.1  
*WDF*— 21

## STATION NOTES

The *R-1 Terminus* Type orbital penal installation was built to confine foreign agents and hard-core criminals captured within Federation space. Though Federation authorities deny it, enemy operatives are probably taken to these maximum security institutions for interrogation and processing.

A security zone, possibly as wide as one thousand kilometers, surrounds the installations. *Scorpio* Class corvettes and armed shuttlecraft patrol this zone and will attack any intruders. The station's crew is a combination of Star Fleet Marine and Intelligence personnel, with some scientific and medical staff. Admission to these confinement installations requires priority clearance in advance from the Department of Star Fleet.

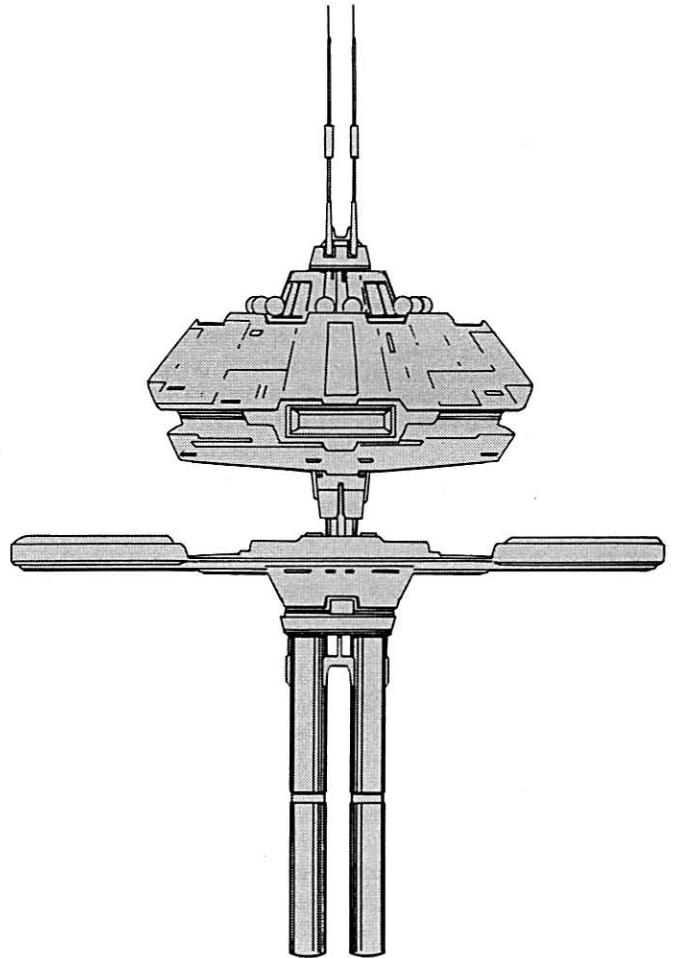

# SUPPORT VESSELS

The following section describes the auxiliary craft that operate out of certain *R-1* Type stations. In addition to vessel design data, information on vessel deployment is also provided.

## SAMSON CLASS X WARP TENDER

### Construction Data:

Hull Numbers—	92300–92310
Model Number—	MK 1
Date Entering Service—	2/0902
Number Constructed—	26

### Hull Data:

Superstructure Points—	20
Damage Chart—	B (Treat "Beam Weapon Hits" as "Tractor Beam Hits")

### Size

Length—	200 m
Width—	140 m
Height—	60 m
Weight—	152,000 mt

### Cargo

Cargo Units—	100 SCU
Cargo Capacity—	5,000 mt
Landing Capability—	None

### Equipment Data:

Control Computer Type—	M-4
Transporters—	
standard 6-person—	1

### Other Data:

Crew—	52
Shuttlecraft—	2

### Engines and Power Data:

Total Power Units Available—	44
Movement Point Ratio—	4/1 unloaded 8/1 loaded

### Warp Engine Type—

Number—	2
Power Units Available—	20
Stress Charts—	G/L
Maximum Safe Cruising Speed—	Warp 6 unloaded Warp 3 loaded Warp 8 unloaded Warp 5 loaded
Emergency Speed—	FID

### Impulse Engine Type—

Power Units Available—	4
------------------------	---

### Weapons and Firing Data:

Weapons and Firing Data:	None
--------------------------	------

### Shields Data:

Deflector Shield Type—	FSB
Shield Point Ratio—	1/2
Maximum Shield Power—	6

### Combat Efficiency:

D—	65.6
WDF—	0.0

Developed by a joint commercial venture between Rantura Shipping Lines and Chiokis Starship Construction, the *Samson* Class X warp tender is designed primarily to provide warp mobility to all *R-1* Type stations. As it uses enormous amounts of power to tow even the lightest of the *R-1s*, the warp tender has no power to spare for weaponry and has only limited defensive capabilities. All these warp tenders operate out of star bases and are dispatched to an *R-1* station only when the station must be moved. With the growing military tension between the Federation and the Klingon Empire, Star Fleet is currently planning to upgrade the existing MK 1 design to a more powerful version.

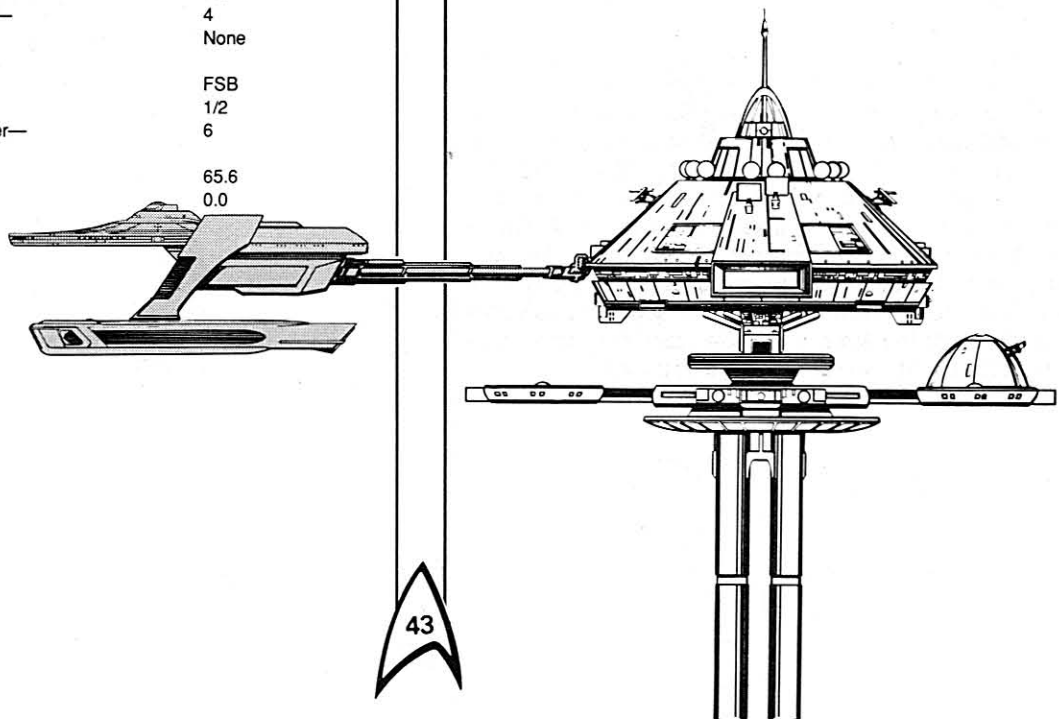
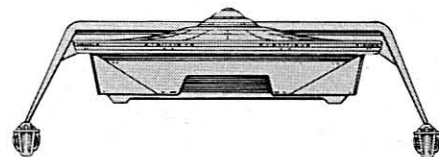
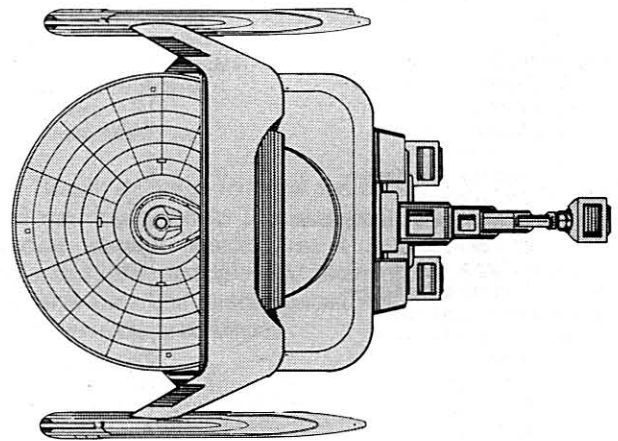

## SCORPIO CLASS II CORVETTE

### Construction Data:

Model Number—	MK 1
Date Entering Service—	2/2206
Number Constructed—	192

### Hull Data:

Superstructure Points—	3
Damage Chart—	C
Size	
Length—	22 m
Width—	7 m
Height—	7 m
Weight—	7,840 mt

### Cargo

Cargo Units—	1 SCU
Cargo Capacity—	50 mt
Landing Capability—	Yes

### Equipment Data:

Control Computer Type—	L-13
Transporters—	
standard 6-person	1

### Other Data:

Crew—	4
-------	---

### Engines and Power Data:

Total Power Units Available—	2
Movement Point Ratio—	1/3
Warp Engine Type—	FWA-1
Number—	1
Power Units Available—	6
Stress Charts—	F/G
Maximum Safe Cruising Speed—	Warp 7
Emergency Speed—	Warp 9
Impulse Engine Type—	FIA-1
Power Units Available—	1

### Weapons and Firing Data:

Beam Weapon Type—	FH-1
Number—	2 in 1 bank
Firing Arcs—	t/p/s
Firing Chart—	F
Maximum Power—	2
Missile Weapon Type—	FP-3
Number—	1
Firing Arcs	f
Firing Chart	D
Power to Arm	1
Damage	6

### Shields Data:

Deflector Shield Type—	FSB
Shield Point Ratio—	1/2
Maximum Shield Power—	11

### Combat Efficiency:

D—	81.2
WDF—	2.2

Organized into groups of twelve ships operating in three flights of four ships each, *Scorpio* Class corvettes are used primarily as long-range support craft for Federation bases and orbital platforms. Though lightly armed and armored, this craft is very quick and maneuverable, making it ideal for commerce protection, long-range scouting, and interception duties. Its Andorian design makes it a favorite of Andorian pilots. Most *Scorpios* operate out of star bases, but one group, the 14th Pursuit Group, is quartered at an *R-1 Invictus* Type orbital defense outpost. As additional corvettes are produced at the Morena and Salazaar shipyards, more will be added to *R-1 Invictus* Type stations as well.

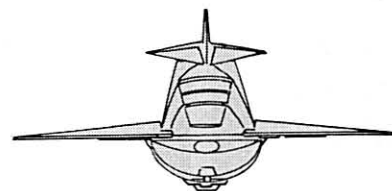
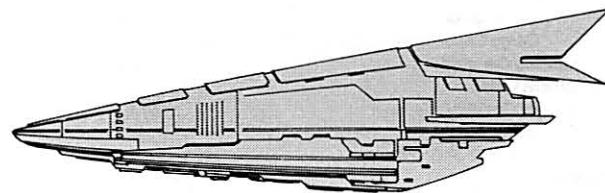
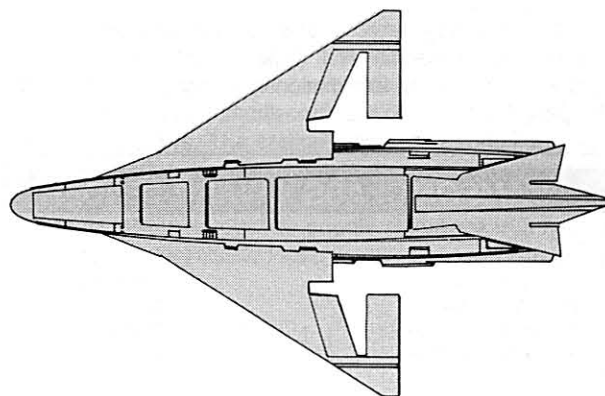

## S-11 TYPE REPAIR AND MAINTENANCE POD

<b>Construction Data:</b>	
Model Number—	Series 8
Date Entering Service—	2/1201
Number Constructed—	2,547
<b>Hull Data:</b>	
Superstructure Points—	0
Damage Chart—	C
Size	
Length—	3 m
Width—	5 m
Height—	4 m
Weight—	6 mt
Cargo	
Cargo Units—	1 SCU
	(manned version only)
Cargo Capacity—	50 mt
	(manned version only)
Landing Capability—	Yes
<b>Equipment Data:</b>	
Control Computer Type—	L-12
<b>Other Data:</b>	
Crew—	1 or
	remote-controlled
<b>Engines and Power Data:</b>	
Total Power Units Available—	1
Movement Point Ratio—	1/1
Warp Engine Type—	None
Impulse Engine Type—	FMIA
Power Units Available—	1
<b>Weapons and Firing Data:</b>	
Weapons—	None
<b>Shields Data:</b>	
Deflector Shield Type—	Navigational Only

Built from the original specifications of the *S-10* travel pod, the *S-11* repair pod is capable of effecting standard equipment repairs to exterior station systems and spacecraft. The *S-11* comes in two types: manned or remote-controlled (MK I and II, respectively). Mark I versions carry one standard cargo unit. The remote-controlled version lacks cargo capacity, because its additional computer systems take up the space.

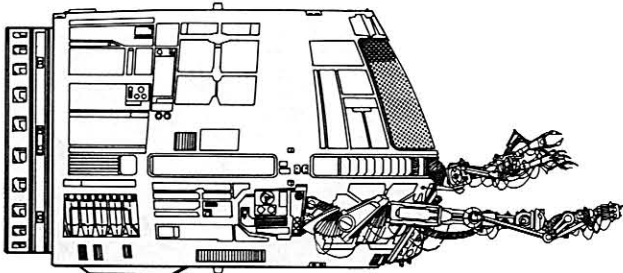

## S-12 TYPE MEDICAL POD

<b>Construction Data:</b>	
Model Number—	Series 9
Date Entering Service—	2/2007
Number Constructed—	158
<b>Hull Data:</b>	
Superstructure Points—	0
Damage Chart—	C
Size	
Length—	8 m
Width—	4 m
Height—	5 m
Weight—	8 mt
Landing Capability—	Yes
<b>Equipment Data:</b>	
Control Computer Type—	L-12
<b>Other Data:</b>	
Crew—	1
Patients—	2
<b>Engines and Power Data:</b>	
Total Power Units Available—	1
Movement Point Ratio—	1/2
Impulse Engine Type—	FMIA
Power Units Available—	1
<b>Weapons and Firing Data:</b>	
Weapons—	None
<b>Shields Data:</b>	
Deflector Shield Type—	Navigational Only

Based on the *S-10* travel pod design, the *S-12* medical pod was developed for use aboard *R-1 Mercy* Type orbital medical centers. Medics use it if beaming up injured patients to the station would jeopardize their health. The intensive care unit directly behind the pilot can be set for low or zero-gravity conditions.

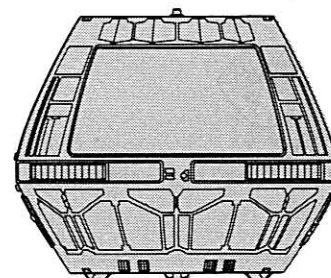
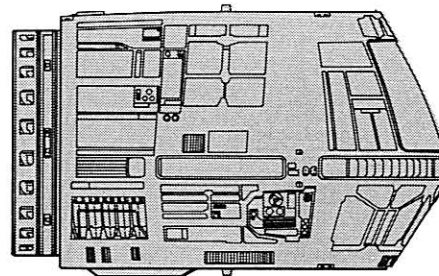
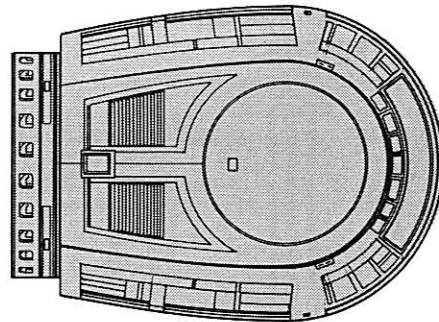

## INFILTRATOR TYPE SURVEILLANCE DRONE

### Construction Data:

*Date Entering Service*— 2/1405  
*Number Constructed*— Unknown

### Hull Data:

*Superstructure Points*— 1  
*Damage Chart*— C  
*Size*

Length— 10 m  
 Width— 2 m  
 Height— 1 m  
 Weight— 12 mt

### Equipment Data:

*Control Computer Type*— L-12

### Engines and Power Data:

*Total Power Units Available*— 2  
*Movement Point Ratio*— 2/1  
*Warp Engine Type*— FMWA  
 Number— 1  
*Power Units Available*— 2  
*Stress Charts*— A/A  
*Maximum Safe Cruising Speed*— Warp 2

### Weapons and Firing Data:

None

### Shields Data:

*Deflector Shield Type*— Navigational Only

Because many details of the *Infiltrator* Type surveillance drone are classified, the above information represents the best estimate of its abilities. Essentially, it is a microwarp engine attached to long-range sensors. Although the exact number is unknown, some drones are currently operating out of key Federation outposts, including *R-1 Informant* Type surveillance centers. Unconfirmed rumors report that an *Informant* drone was the first to detect the *V'ger* starcraft, which gave Star Fleet Command enough time to react to the menace.

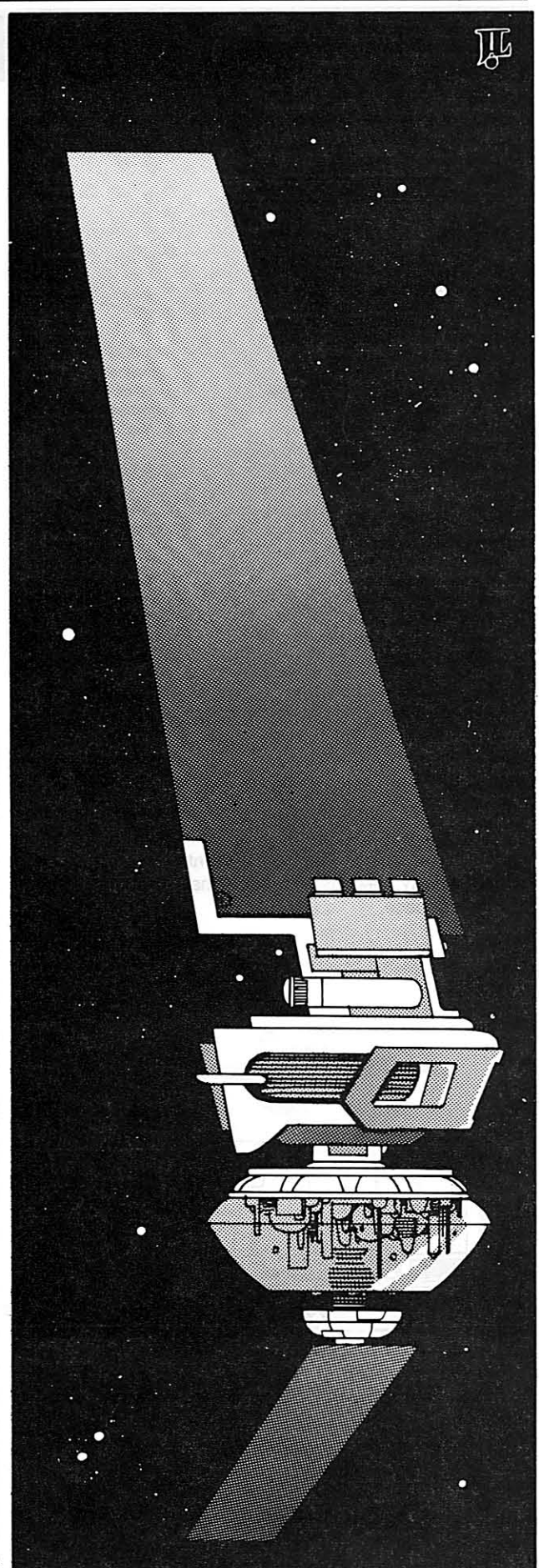
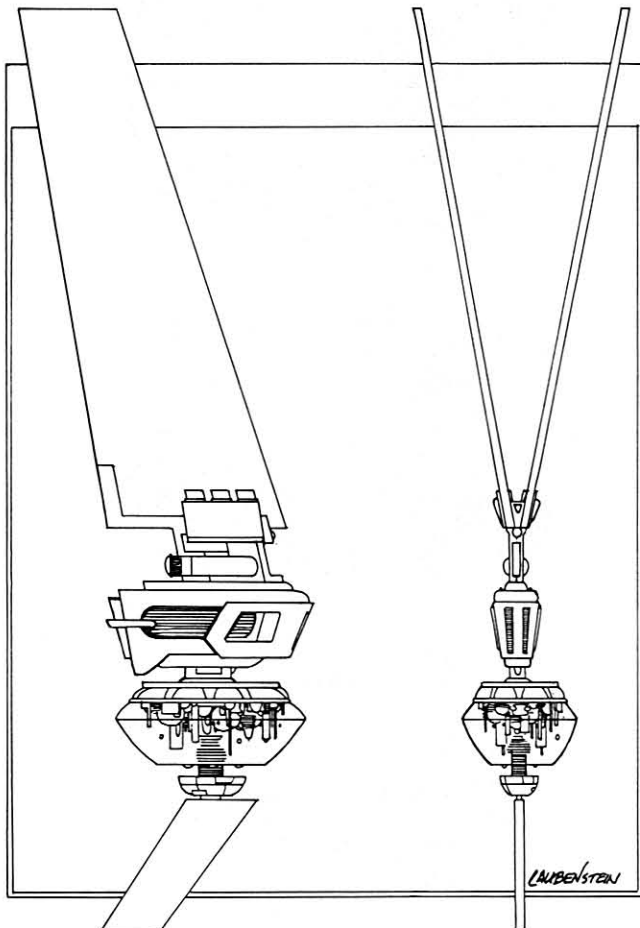



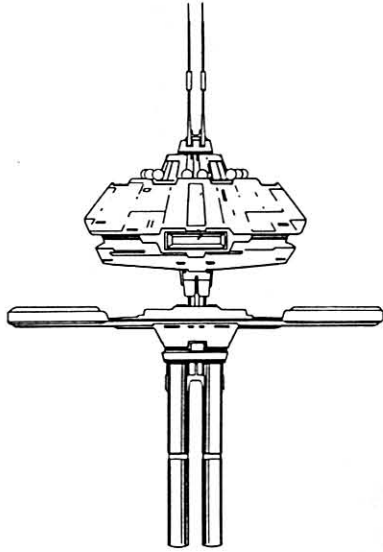

**Terminus Type Orbital Penal Installation**

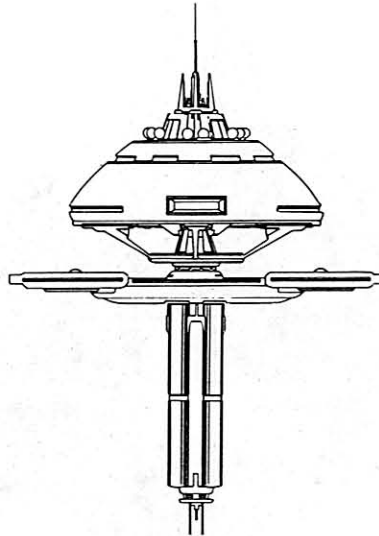

**Mercy Type Orbital Medical Center**

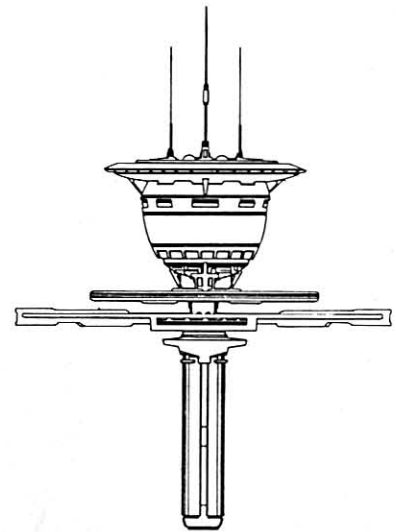

**Harmony Type Recreational Facility**

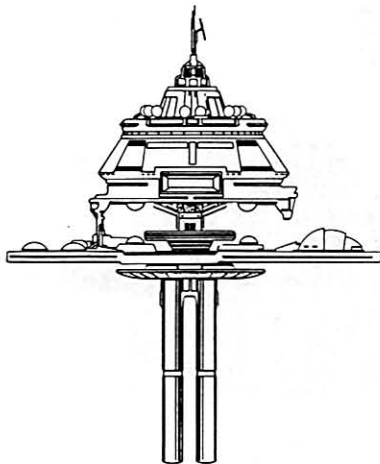

**Investigator Type Orbital Research Station**

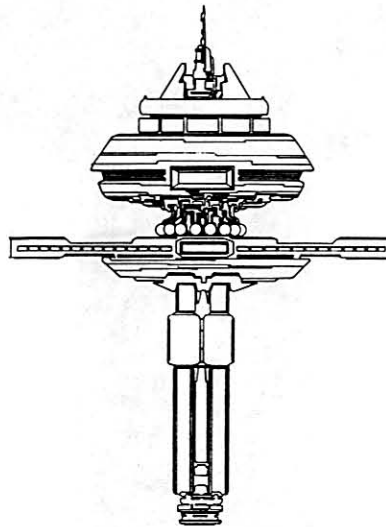

**Artisan Type Orbital Manufacturing Center**

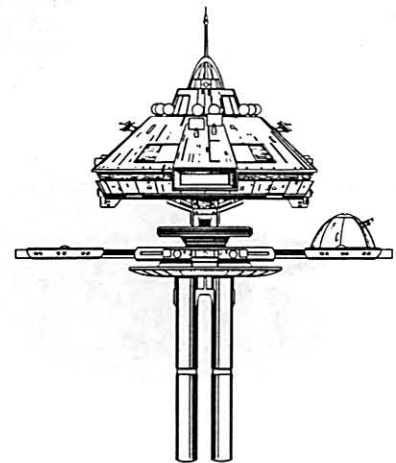

**Invictus Type Orbital Defense Outpost**

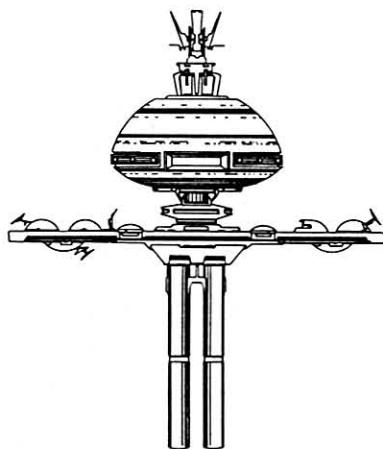

**Informant Type Deep-Space Surveillance Center**

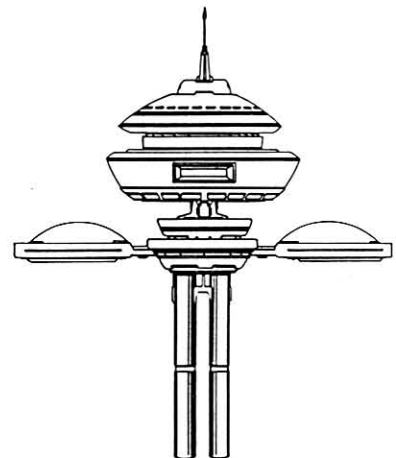

**Administrator Type Orbital Administrative Center**



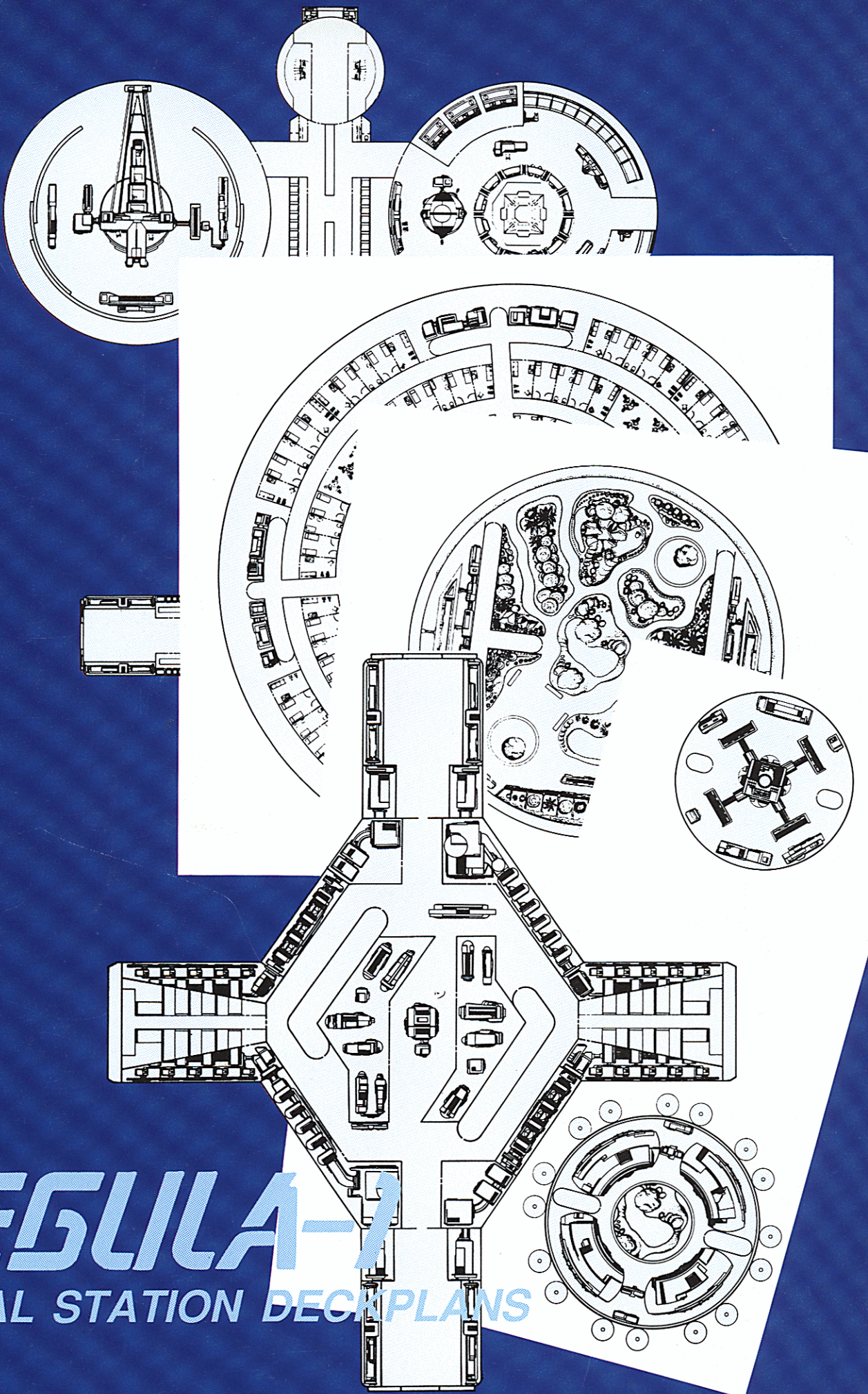

# REGULA-1

ORBITAL STATION DECK PLANS