

# THE DIXIE GAMBIT

An adventure for use with  
**STAR TREK**<sup>®</sup>  
THE ROLE PLAYING GAME

3 512  
SENSORS: VISUAL  
344 88 060

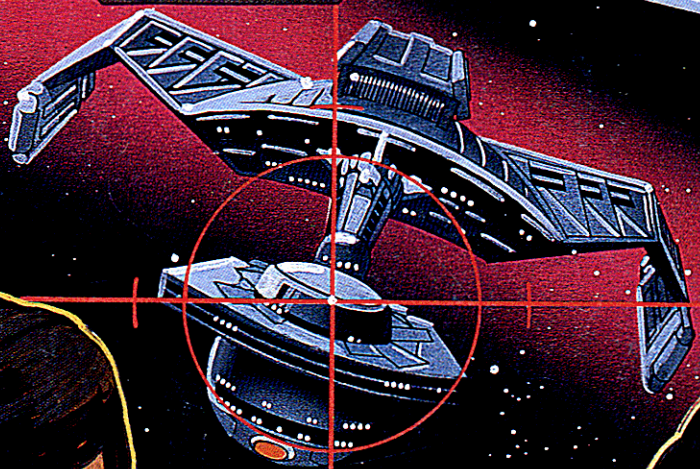
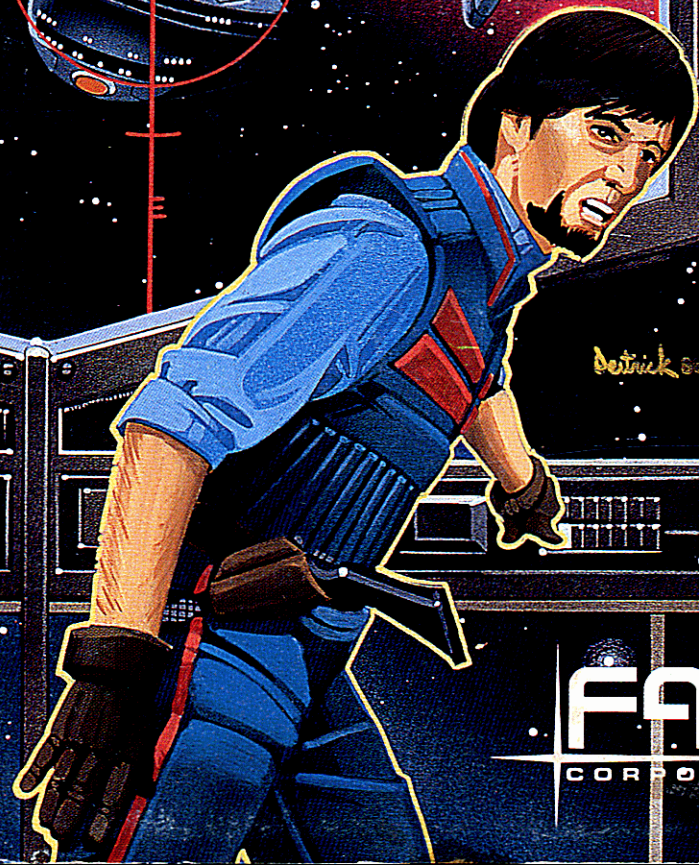

*Detrick 88*

**FASA**  
CORPORATION

# THE DIXIE GAMBIT

## TABLE OF CONTENTS

<b>INTRODUCTION</b> . . . . .	2	<b>CAST OF CHARACTERS</b> . . . . .	-27
Plot Synopsis . . . . .	2	Pre-generated Player Characters . . . . .	-27
Contents of This Book . . . . .	3	NPCs . . . . .	-36
Game Aids . . . . .	3	Star Fleet Characters . . . . .	-36
<b>THE ADVENTURE</b> . . . . .	4	Richmond Enterprises Characters . . . . .	-39
Introductory Story . . . . .	4	Klingon Characters . . . . .	-42
Ghost From the Past . . . . .	5	Prisoners and Pawns . . . . .	-47
In The Triangle . . . . .	5	<b>GAMEMASTER'S NOTES</b> . . . . .	-50
Priority Code Blue . . . . .	5	Hints on Play . . . . .	-50
Tremaine's Story . . . . .	5	Adventure Timeline . . . . .	-50
Briefing . . . . .	6	Judging Klingon Characters . . . . .	-50
In Search Of Dixie . . . . .	7	Relaying Players Information . . . . .	-52
Thisisit . . . . .	7	Personal Outcomes . . . . .	-52
Richmond Enterprises . . . . .	7	Further Adventures . . . . .	-52
The Klingon Connection . . . . .	8	Adventure Background . . . . .	-53
File Alpha 011 . . . . .	8	Planets . . . . .	-53
Return of the Dixie Lady . . . . .	9	Operation Dixie . . . . .	-54
A New Challenge . . . . .	10	The Klingon Plan . . . . .	-55
Return to Freeman's Port . . . . .	10	Richmond Enterprises . . . . .	-55
En Route . . . . .	10	Project Minuteman . . . . .	-56
Marram IX . . . . .	10	A Ray of Hope . . . . .	-56
The Perpetual Game . . . . .	11	<b>PLAYERS BACKGROUND INFORMATION</b>	
Plan Red File . . . . .	12	Eternity . . . . .	-1
Next Steps . . . . .	12	Freeman's Port . . . . .	-1
Project Minuteman . . . . .	13	Federation Intelligence Operations,	
Rescue Mission . . . . .	13	Triangle Sector . . . . .	-1
Turning Point . . . . .	14	Lantos . . . . .	-1
Dixie Triumphant . . . . .	14	Mantiev Colonial Association . . . . .	-2
The Missing Piece . . . . .	14	Marram IX . . . . .	-2
Plan White File . . . . .	14	Maraarda . . . . .	-2
Return Engagement . . . . .	15	New Paradise . . . . .	-2
Pursuit at Warp Speed . . . . .	15	Operation Dixie . . . . .	-2
Coming Home . . . . .	15	Project Grey Ghost . . . . .	-3
<b>VESSELS</b> . . . . .	16	Richmond Enterprises . . . . .	-3
W-4 Warpshuttle . . . . .	16	Star Fleet Intelligence Command . . . . .	-3
G-8 Cargo Frighter . . . . .	17	Thisisit . . . . .	-3
K-3 Gunboat . . . . .	18	Triangle, The . . . . .	-3
D-14 Destroyer . . . . .	19	Galaxy Map . . . . .	-4
L-42 Frigate . . . . .	20	<b>OPERATION DIXIE HANDOUT</b>	
D-18 Destroyer . . . . .	21	Mission Planning . . . . .	-1
D-10 Cruiser . . . . .	22	Inter-Sector Rivalry . . . . .	-1
<b>MAPS</b> . . . . .	23	Final Plans . . . . .	-1
Klingon Base Headquarters . . . . .	23	Execution . . . . .	-2
Klingon Work Camp . . . . .	24	Aftermath . . . . .	-3
		Operation Ferret . . . . .	-3
		Service Roster . . . . .	-4

### DIXIE GAMBIT

#### Writing and Design

J. Andrew Keith

#### Editorial Staff

##### Editor-In-Chief

L. Ross Babcock III

##### Senior Editor

Donna Ippolito

##### Editor

Todd Huettel

#### Production Staff

##### Production Managers

Jordan K. Weisman

Karen Vander Mey

##### Art Director

Dana Knutson

##### Cover Art

David R. Deitrick

#### Illustration

Todd F. Marsh

Jeff Laubenstein

John C. Tylk

Dana Knutson

#### Typesetting and Layout

Tara Gallagher

#### Pasteup

Todd F. Marsh

John C. Tylk

# INTRODUCTION

The **Dixie Gambit** is an adventure module for **STAR TREK: The Role Playing Game**. In it, the players take the roles of agents of Star Fleet Intelligence Command assigned to discover the fate of Operation Dixie, an ill-starred covert mission sent into the Klingon Empire. The player characters must also try to recover the valuable intelligence data gathered by that lost mission and to determine the identity of the Klingon spy who sabotaged it. In the course of their investigation, the players will be forced to penetrate Klingon-held space, stage a rescue operation at an Imperial prison camp, and escape from a Battle Group commanded by one of the Klingon Empire's most ruthless captains.

The adventure is designed for a group of four to six players, who play the roles of Star Fleet Intelligence agents aboard a small starship in the notorious Triangle region lying between the borders of the UFP, the Klingon Empire, and the Romulan Empire. It is possible to vary the size of the group, if desired. A lone player could participate, for example, or a group of ten or more could play, but certain essential facts must remain constant. First, at least half the player characters should be Klingon-Human Fusions who are now, for one reason or another, in the service of Star Fleet. Although characters of other races do have a place in this adventure, Klingon-born characters are absolutely essential for many stages. The other requirement is that the characters be serving in an Intelligence capacity, as this is not an adventure for the typical starship crew. However, the scenario can be incorporated into an ongoing campaign by having regular Star Fleet officers temporarily attached to Fleet Intelligence (a not unusual occurrence) so that they may become involved here.

The adventure assumes a Federation point of view throughout. The gamemaster might, however, wish to consider the possibility of using the same backdrop for an adventure involving Klingon counter-espionage forces. Though this alternative is not covered in detail in this module, the gamemaster could easily create such a scenario by making the Federation characters into NPCs. It would even be possible to create an intricate campaign in which two players' groups (one Klingon, one UFP) compete, the one to obtain key intelligence and the other to protect it. Such an adventure would require considerable gamemaster preparation, as it is outside the scope of this booklet.

## PLOT SYNOPSIS

A team of Star Fleet Intelligence agents operating in the Triangle are contacted by an Intelligence Officer on the independent world of Freeman's Port. He reports sighting a starship that he has identified as one of three lost spy ships belonging to Operation Dixie, a covert investigation of Klingon capabilities and commitments. The player characters are ordered to assist in an investigation and recovery mission to discover the fate of Operation Dixie and of the intelligence lost when its three ships disappeared.

The first phase of the mission takes the player agents to Thisisit, an independent trading world where the lost spy ship's new owners have their headquarters. Here the adventurers obtain important leads to Dixie's fate. They also get a chance to search the lost spy ship itself for any information still recorded in its computer banks. The material they obtain is only partial, however, and the only way to unlock it is to trace further back and recover one of the ship's crew, now presumably in Klingon hands.

The trail takes the characters to Marram IX, a Klingon-controlled world in the Triangle. Here the adventurers learn of the circumstances behind the arrival of the Dixie spy ship in the Triangle, and have a chance to discover that the ship's crew is being held in a prison camp on the same world. To free the prisoners, the adventurers must attempt to enlist the aid of Marram's Human colonists now under Imperial domination. In the course of the rescue, they may also be able to gain clues to the identity of the traitor who sold out Dixie's three ships. However, a trap by Klingon counter-intelligence awaits.

Finally, the agents uncover a Klingon scheme to plant the Dixie traitor and false Dixie data back in the Federation. By stopping him, the adventurers can get the *real* data from the Klingons, then escape, despite pursuit by a Battle Group of Klingon starships.

Although the adventure may take a variety of twists and turns that lead it into a completely different track, this sequence of events is the one competent players are most likely to produce. The players, through their actions, and the gamemaster, by his overall control of events, will shape the final course of the adventure.

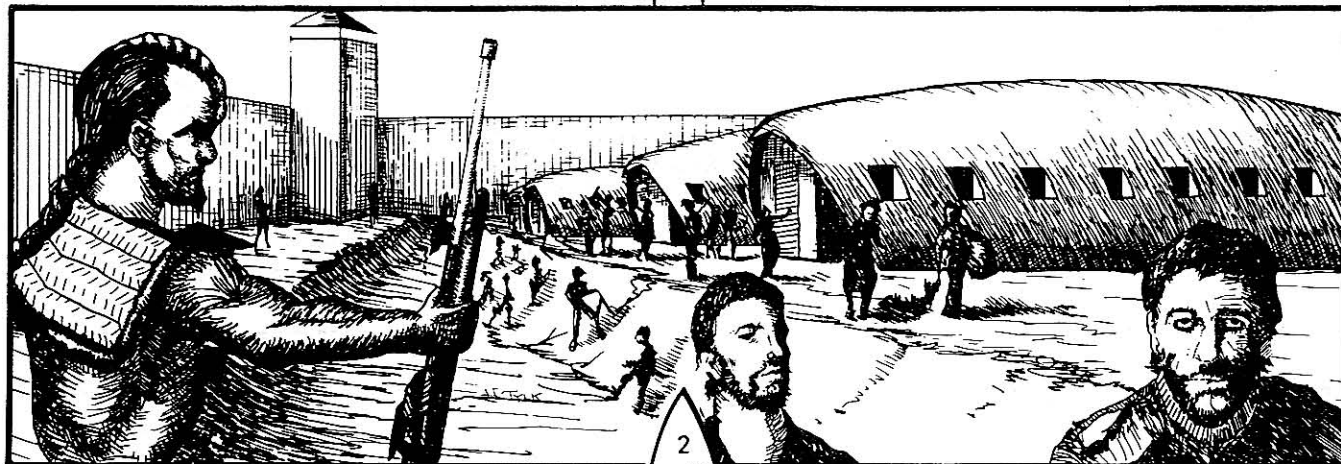

## CONTENTS OF THIS BOOK

All the specific events, encounters, and situations that combine to create the story of **The Dixie Gambit** are explained in the **Adventure** chapter, which deals step by step with each phase of the scenario. Following this is a section of **Background Information** on the planets, organizations, and events that have their part in the adventure. This material is for gamemaster's use only, and is intended to help him shape his narrative and to cope with the unexpected.

The **Cast of Characters** chapter includes a small collection of pre-generated characters as well as descriptions of all the NPCs. The **Gamemaster's Notes** chapter is designed to guide him in creating, developing, regulating, and resolving **The Dixie Gambit**.

There are also two 4-page pullouts in the center of this booklet. One is the **Player's Handout**, containing computer files on the places, people, and events of importance to the story. The other is a briefing on **The Dixie Operation**, a summary of the purpose, intent, known history, and outcome of this covert mission, as player characters would perceive it. These handouts are the only portions of this booklet that should be made directly available to the players. As the information in them is often incomplete or inaccurate, the gamemaster himself should rely solely on the information given in the **Gamemaster's Information** chapter, and, of course, on his own interpretations or modifications of it.

## GAME AIDS

Although not absolutely necessary to this adventure, several other FASA **Star Trek** products would make very useful companions to **The Dixie Gambit**. The **Klingons** supplement, which contains background material, character generation information, and other important data on this Federation opponent, is extremely beneficial to players and gamemasters alike. Another supplement, **The Triangle**, provides in-depth background on the region where **The Dixie Gambit** takes place. It also includes other adventures that might run concurrently with or apart from this scenario. The **Klingon Ship Recognition Manual** provides data on Klingon starships that might be encountered randomly during this scenario.

Finally, it is recommended that extensive use be made of material relating to the **Tricorder/Starship Sensors Interactive Display**, a FASA product that allows for considerable detail in the analysis of the unknown. Although the same information can be passed on without the use of this product, the gamemaster will find it a useful adjunct to the text. Miniatures and other similar game aids may be used at the gamemaster's option.



# THE ADVENTURE

This chapter outlines the various events and situations that form the adventure as a whole. Of course, the way player characters choose to handle specific problems or encounters may vary enormously from one group to another, leading to a scenario radically DIFFERENT from the one laid out here. Certain basic facts will always remain constant, however, no matter what the players do or do not do.

The **Introductory Story** sets the scene for the game-master. At the appropriate time in the adventure, he should share it with the players.

**Ghost From The Past** describes the initial situations and early events that get the adventure rolling. Clues uncovered during this phase will lead to the order to go **In Search Of Dixie**, taking the adventurers to Thisisit and a chance to uncover more information on Operation Dixie's ultimate fate. Events in that section, in turn, produce the clues needed to enter the next phase of the adventure.

**A New Challenge** outlines events on Marram IX, where the Klingons spring a carefully-laid plot that could be a serious danger to the Federation. Infiltration of a Klingon headquarters, a rescue mission into an Imperial prison camp, and a surprise twist await the players here.

Finally, the whole adventure comes together in **Dixie Triumphant**, the climax and resolution of the unfolding story. Here, the characters have the chance to foil the Klingons, retrieve the vital Dixie information, elude a Klingon Battle Group, and to return home in triumph.



## INTRODUCTORY STORY

Operation Dixie, report #19-C-3, Officer Arvan tai-Vinsar recording. Transmission to be broadcast at 30 to 1, Scramble Code 19, Priority Blue, clearance 'Dixie.' Report follows.

Computer analysis allows for no appreciable doubt: This mission has been penetrated, compromised, and betrayed by a double agent. The loss of the *Dixie Queen* and the *Dixie Princess*, our own difficulties (see report #18-C-3), and the breakdown of the Dixie project can only be attributable to betrayal. This opinion has been endorsed by Security Officer Vestai-Krinitth and by the Captain. On my own authority, and contrary to operational protocol, it is my intention to transmit the data gathered by the *Dixie Queen* and the *Dixie Princess*, for I doubt very much that we shall reach Star Base 12 to deliver the data tapes per procedure.

Request is hereby made for a relief mission, per Captain's instructions, but we all know no relief mission can reach us in time. Data transmissions to follow. Stand by for *USS Dixie Queen* sealed report, Scramble Code 23, Priority Red, Clearance 'Dixie Prime-Top Secret'.

Captain Nicholas Tremaine switched off the tape and sank back into the plush suspensor chair, his eyes wandering from the viewscreen to the office window overlooking the starport. The shuttlecraft that stood alone on the tarmac looked like any other Klingon-designed civilian shuttle. Tremaine had tried to convince himself that it was not what he thought, but his eyes would not betray him. As coordinating officer in charge of Operation Dixie, he had personally inspected each of its ships, each auxiliary craft, and he well remembered that lopsided, seven-pointed star on the stubby shuttle's bow. New metal against old, there was now a poorly-welded patch in a peculiar shape over that same spot.

That shuttlecraft, like the tape made by a Klingon renegade named Arvan tai-Vinsar, belonged to Operation Dixie, lost over a year ago. "Missing in Action," the reports said. The failure of that mission had ended Tremaine's hopes of promotion, and condemned him to a nowhere post on a world that was not even part of the Federation.

How did that shuttle now come to be here? he wondered. And if it WAS from the lost *Dixie Lady*, one of Operation Dixie's three ships, could other flotsam of the mission be out there, too? Perhaps even survivors from among the 90 people whose memory haunted him every night—the *Dixie* crews? And what about the information, the top secret data jammed before it could reach the Federation? Could it still turn up after all this time?

Captain Tremaine reached for the intercom switch, his mind made up. He had to know the truth, and devil take the proper channels. "Send out a coded message to the nearest offplanet field team. Priority Code Blue, this Stardate. Message begins: 'Effective immediately, cancel previous orders.'"

Tremaine owed it to the men who had died for Dixie.

## GHOST FROM THE PAST

The following sections set the general scene for **The Dixie Gambit**, giving the gamemaster a chance to acquaint players with the basic situation and background information necessary to understand the adventure.

### IN THE TRIANGLE

As the adventure opens, the player characters have been assigned as a field team by Star Fleet Intelligence Command. They are intelligence agents (or officers temporarily seconded to the SFIC to broaden their experience and fill in during critical manpower shortages in Intelligence) operating along the fringes of the Mantiev Colonial Association, near the lower part of the region popularly known as the Triangle.

A deadly civil war between Association factions is in progress here. Each side is backed by a powerful foreign power, the Romulans on one side and the Klingons on the other. Meanwhile, the Federation continues to make poorly-received offers of mediation and peaceful assistance. In this confrontation that could be a dress rehearsal for a full-fledged war between the other two super powers, the UFP position is precarious. The Federation has been funneling intelligence agents into the region in droves to protect its interests and to monitor Klingon and Romulan operations while they have the chance.

The players' group has been assigned to investigate the Klingon supply chain into the Association, the route by which equipment, "advisors", and "volunteer units" have been reaching the rebels. Disguised as free traders of mixed backgrounds, the group includes a number of renegade Klingon/Human Fusion agents, who can infiltrate Klingon operations as the need arises. Their ship, too, is Klingon, a captured *W-4 Class III* warpshuttle that can serve equally well as a small trader or excursion ship, or as a military courier or picket boat in Imperial service.

As the adventure begins, the group's mission has been fairly successful, but, like most intelligence work, painstaking and dull. They have traced several private concerns connected with the rebel cause back to the Klingons, proving that much more support is flowing to the rebel cause covertly than is visible on the surface. Their work has really only just begun when new orders come in. The orders are not only unusual, but they are from a surprising source.

### PRIORITY CODE BLUE

The players receive the following message:

PRIORITY CODE BLUE  
Ref. Stardate 2/2303.18

FROM: Captain Nicholas Tremaine  
SFIC Agent-in-Charge, Freeman's Port  
TO: Warpshuttle *Galahad*  
NCU-5884

Effective immediately, cancel previous orders. Proceed top warp speed to Freeman's Port, coordinates 10.75 6.9E. Report to Suite 973B, Port Annex South, cover file Alpha, challenge/response 79Y. Consider this Priority Code Blue. Override authority SFIC Operation Dixie. Subspace radio silence mandatory.

The message contains several mysteries. First of all, the group has not previously been answerable to Captain Tremaine, who, as Agent-in-Charge of what is essentially a backwater world, has no real involvement in the MCA investigation. Although Tremaine has the rank to issue orders, his authority over the characters is questionable. Further, such a change in orders should properly be sent through channels. Under normal circumstances, the characters would be correct in sending a query to their own superiors, continuing on with their current mission until ordered otherwise by a legitimate authority.

These are not ordinary circumstances, however, thanks to Tremaine's invocation of Priority Code Blue. Blue Priority orders are generally issued only by Project Coordinators, and relate to matters of critical importance to Federation security. Using the Priority Code Blue, Nicholas Tremaine can indeed override previous instructions, and bind the group to silence in the process, provided he is willing to justify his use (or misuse) of the code later.

Most confusing of all, however, is the "authority SFIC Operation Dixie" phrase in the message. Every SFIC agent knows that the intelligence mission known as Operation Dixie was a complete fiasco, ending in the loss of three ships in Klingon space more than two years ago. To invoke Dixie as authority for a Code Blue message is a highly questionable move indeed. Presumably, the operation was closed down when the mission failed.

The adventurers could refuse to respond at all, which would mean that this adventure could not take place at all. If Tremaine's orders are queried upward, SFIC will order the characters to respond to Tremaine, but also to report back on his activities, in case he is misusing his authority. Thus, the turn of events will depend largely on the players.

The player characters could also choose to blindly obey Tremaine or might also decide to do some quick research. Files on Operation Dixie are limited (the **Player's Handout** on Dixie is not available at this time). After announcing an intention to investigate Dixie or Captain Tremaine, player characters who make a successful Skill Roll against *Computer Operation* will find that the Captain was Project Coordinator for the operation. Moreover, as the ships of Dixie are listed officially as "Missing in Action," the files on the project are not closed. Technically, Tremaine has a right to invoke Priority Code Blue in connection with Dixie, although in practice, there is no precedent for suddenly issuing such orders two years after the collapse of a mission and the transfer of the mission leader to another intelligence sector. Tremaine is on shaky legal ground. However, the characters have every right to respond to his summons if their curiosity is sufficiently piqued, which it should be by this curious conflict of legalities.

### TREMAINE'S STORY

The voyage to and arrival at Freeman's Port is uneventful. Reaching the planet, the adventurers can follow Tremaine's instructions to adopt the guise of traders dealing in small lots of high-quality gems. Tremaine's office suite, the front for his intelligence activities, appears to be a busy brokerage house. Using the proper code phrase (Challenge: "The market for flame gems is soft this year." Reply: "Until the Altair shipment comes due.") will get the party ushered past several secretaries and into Tremaine's private sanctum.

Captain Tremaine looks older than his dossier claims, with an air of hopelessness about him. He is a man whose career is winding down for good, and it shows. Though cordial, he is slow to get to the point of his summons. Drinks, inquiries about the party's health and the party's good travel time, and other such small talk only delay the inevitable, however. If not interrupted by one of the characters, Tremaine will go on like this for more than a quarter of an hour, seemingly unsure how to proceed. Eventually but clumsily, he gets down to business.

"I've ordered you here," he says, "to put you onto an important matter. It's a vital mission, but there's a, well, a problem. What I'm ordering isn't sanctioned by Triangle Sector. I'm going out on a limb, and so will you if you accept my orders, but what I've got is too hot for normal channels."

Tremaine goes on to rehash ancient history. As Project Coordinator for Operation Dixie, he was in overall charge of the preparations for the most ambitious SFIC probe of Klingon capabilities ever attempted. However, the three ships that carried the brunt of the Dixie mission never came back, and were presumed destroyed.

Tremaine tells the group that he recently spotted a ship he believes is one of Dixie's. The craft in question was a shuttle sent down from orbit, but he recognized it because of the peculiar pattern of a patch welded onto the shuttle's bow. He checked, and the shuttlecraft proved to be a landing craft from a *G-8* Klingon freighter orbiting Freeman's Port. All three of the principle Dixie ships were also *G-8*s.

The freighter warped out of orbit before Tremaine could take any further steps, but data searches of port records revealed that the vessel was privately owned, apparently purchased from the Klingons by Richmond Enterprises of Thisisit, a planet on the far side of the Mantiev Colonial Association. No other information on the ship is available here, and Tremaine has reached a dead end.

If the Captain were following proper SFIC procedure, he would file a report on his suspicions and forget about it. The information would work its way through the tortuous twists and turns of the Star Fleet bureaucracy, where it might (or might not) attract the attention of someone interested enough to carry out further investigations. It is far more likely such a report would get buried in some computer file and be lost.

Tremaine does not want to take that chance. He was responsible for Dixie, and its failure was his failure. Now there seems a chance that the mission was not totally destroyed after all. If one of the ships really did survive, what about some of the men? Or even the vital information they were about to broadcast before the *USS Dixie Lady's* last transmission was swallowed up by jamming?

Tremaine cannot leave Freeman's Port to pursue the investigation himself. After all, resident agents cannot simply hare off on quixotic chases. The player characters, however, have roving field commissions that give them considerable latitude. Their work involves looking into the sources of the MCA rebels' Klingon supplies. As Thisisit is one of the planets where such supplies are transshipped, surely the group could follow up Tremaine's Dixie lead while officially continuing their own operation?

The Captain is in no position, really, to give them orders. His appeal is to their sense of camaraderie and their pride in the service. Operation Dixie's failure was a blow from which SFIC might never fully recover, but here is a chance to offset that failure. Or, at least to learn for sure what happened and why. Tremaine needs their help, and so might

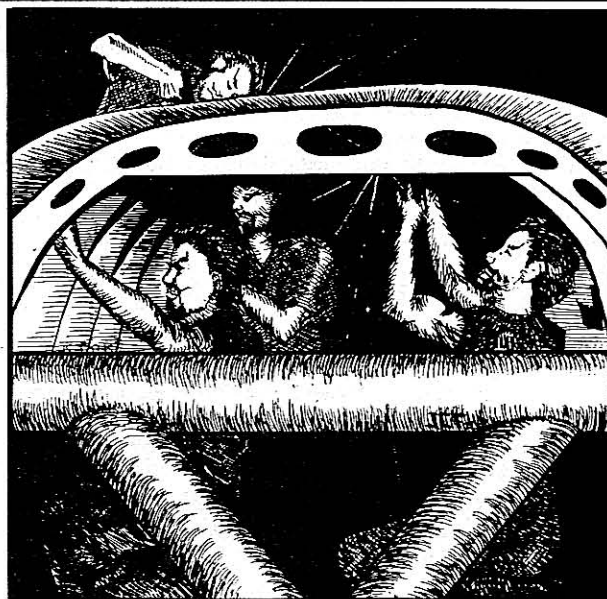

any Dixie survivors languishing in a Klingon work camp. Also, if the Dixie information is still accessible, it could be the most significant intelligence coup in Federation history. If the adventurers decide to look into this matter without official SFIC sanction, they risk censure from Star Fleet Command, but successful resolution of the Dixie mission after all these years could be a triumph for everyone.

The player characters are, of course, free to refuse, but the gamemaster may wish to give them added incentives, such as relatives involved in Dixie or some old debt to Captain Tremaine. If they do refuse, of course, there is no real way to involve them in the mission, unless Tremaine works through channels and somehow gets them officially assigned to the investigation. Acceptance of Tremaine's proposal or receipt of official orders to look into Tremaine's sighting will be followed with a thorough briefing on Operation Dixie.

## BRIEFING

Once the adventurers agree to look into Tremaine's story, they should be given access to the handout on Operation Dixie, which summarizes the origins, events, and aftermath of the mission. This handout actually represents the gist of a much more thorough background briefing, but contains everything the players will need to know.

Tremaine will also play a copy of the last Dixie transmission (see the **Introductory Story**), which he has kept in his possession since Dixie fell apart a year ago. He will answer questions and clear up obscure points as needed, and can add background information on Thisisit and Richmond Enterprises.

The intelligence officer's small Freeman's Port station can help turn out phony credentials and other cover material for the players' group. If they get stuck for a plan of action, Tremaine will suggest that they pose as investors interested in putting large amounts of money into Richmond. Such wealthy businessmen will be in a good position to ask questions about where Richmond gets its ships, and might be allowed access to the company computers or to the ship itself (which should, according to the flight plan filed at Freeman's Port control, be on its way back to Thisisit now). If possible, however, the players should come up with their own cover story and scheme for getting close to Richmond Enterprises.

Tremaine makes a special point to tell the characters to try to check the freighter's computer files. If the Klingon shuttle is, as he suspects, the *Dixie Lady*, the vessel is carrying the accumulated findings of all three Dixie ships at the time of its capture. Standing orders to all Dixie intelligence teams required that data be filed in a special computer file known as Alpha 011. Disguised as part of the ship's avionics/sensor control program, this file was actually a data repository whose existence was known only to the Captain, the Intelligence Officer, the Security Chief, and the Communications Officer. It is possible that the Klingons, in capturing *Dixie Lady*, never dreamed that such data might be present. If so, the information could still be there, locked away in a computer file just waiting to be tapped.

The characters must check this file, which will answer a simple coded query about whether data is present in the file or not. They will NOT be able to access the file, however. The system was designed to require retinal scans from one of the four officers who knew about it, and, in a crisis, could even be keyed to shut out all but one of them. If the data is present in the file, the players will have to secure the freighter by purchase, theft, or some other method so that they can use Star Fleet personnel file records to gain access to the Dixie information stored there.

If the information is not present, of course, there is no need to secure the ship. In *either* case, though, Tremaine also wants to know as much about the ship's history as possible. How did Richmond Enterprises acquire it, and from whom? From what planet did it come? This information could lead back to the ship's crew and to other copies of the data tapes that individuals may have made and concealed prior to the capture of the ship.

After the briefing, it will take about a week for final preparations to be made, and then the characters can begin their voyage to Thisisit in search of Dixie's fate.

## IN SEARCH OF DIXIE

In this portion of the adventure, the characters have the opportunity to use techniques of espionage and undercover investigation to discover the truth behind Tremaine's sighting of the *Dixie Lady* shuttlecraft.

### THISISIT

Thisisit lies just under five and one-half parsecs from Freeman's Port, a trip of nearly 19 days at maximum safe cruising speed (Warp Factor 7). The voyage is uneventful, and so the player characters can pass the time in any way they choose.

The planet, always a busy center of trade, is bustling with activity when the group's warpshuttle assumes orbit. If the party wishes to take their ship down to the surface, there is a four-hour delay before they receive clearance to land. Remember, however, they are also free to remain in orbit and to use transporters to come and go. Other ships present include two small, fast Orion privateers, a squadron of Romulan *Fire Swarm* Class destroyers, and several freighters, among them a Klingon *G-8* broadcasting the private recognition code of Richmond Enterprises. This ship, the *Simone DeLeone*, is the vessel Tremaine believes was once a part of Operation Dixie.

There are no Federation agents permanently resident on Thisisit, as there are at Freeman's Port, because the local government is sensitive to Federation influence in internal affairs. The last two SFIC operatives planted on the world were politely asked to leave after the highly efficient Klingon espionage network discovered them and anonymously tipped off the government to their presence. Undercover teams sharing the same original assignment as the characters may be present, but they will not break cover without a very good reason.

Having arrived onplanet, the adventurers have no problems with officialdom. Customs inspections, like tariffs, are more a formality than a serious piece of bureaucracy, unless the characters try to bring in a major arsenal or other suspicious-looking articles that might make planetary security people edgy.

What happens from here depends largely on how the group chooses to proceed. The following sections describe what can be learned from various sources or by various actions, but it is up to the gamemaster to determine just how well various approaches will work, and how the information is actually conveyed (if it is to be available to the party at all).

### RICHMOND ENTERPRISES

The corporate headquarters for Richmond Enterprises is located in a small office complex near the port. It is a fairly large company, with over 100 employees in the corporate offices alone, as well as branches on several other planets. Though Tremaine's research has shown that business is down and stock values declining, the Richmond family, the firm's majority stockholders, seems to be doing just fine. This suggests that the family is not above shady deals that never quite show up on the company books, and it may also give the players some ideas about how to discover the information they need.

The Chief Executive Officer of the company is Donald Richmond, son of the founder (and current Chairman of the Board) of Richmond Enterprises. Donald's son Thomas, is, in turn, a senior vice president, although not yet 30 years old. A rake, gambler, and womanizer, young Thomas Richmond is the family's one weak link, which might make him a good bet in the player group's search for the truth.

Donald Richmond, though not a playboy like his son, has his own weakness, which is greed. Ever since regular trade was disrupted by the civil war in the Association, he has been skimming money through kickbacks and bribes, acquiring a fortune while the books show continued hard times for the company. (Even his father does not know about this.) Richmond has been dealing heavily with the Klingons, shipping cargo and personnel to the Association rebels, smuggling spies into Federation and Romulan territory, and generally seizing every possible opportunity to make money at anyone else's expense.

These two Richmonds are not the only ones in the company whom the adventurers might approach for information. Many other people, from secretaries or office boys up to other vice presidents or starship crewmen, might be willing to provide access either to the company's records on the ship or to the vessel itself. Other people, however, are not as well known to SFIC, whereas the Richmonds each have a fairly extensive dossier summarized by the above information. This need not stop creative players from coming up with other approaches to probing the company and its secrets, however. It is up to the gamemaster to



determine the nature and outcome of any encounters with such potential sources.

### THE KLINGON CONNECTION

Records kept by Donald Richmond (available through him, his son, or his confidential secretary), document the recent history of the ship now christened *Simone DeLeone*. The information dates back over the past six months, from the time of the ship's purchase by Richmond. The sale was a private transaction between Donald Richmond and Klinmar sutai-Asteera, the military governor of the planet Marram IX. Files note the sale (at an extremely low price), but nothing of the ship's background before this time. Richmond later sold the ship to his own company at a price still below market value, but netting about 300 percent personal profit. Crew lists show that there have been no major personnel changes since Richmond first dispatched Captain S. A. Mahoney to conclude the transaction and bring the ship back. A listing of other crew members employed on board is available.

Characters who, for one reason or another, approach crew members of the *Simone DeLeone* for background on the ship will find Captain Mahoney and his crew a hard-drinking, boastful, mercenary bunch. The players' group should not find it hard to eventually pump information from these sources.

Important clues that might be handed out (at the gamemaster's discretion) are summed up as follows. First, the Klingons were anxious to unload the ship, which is why the selling price was so low. Their story was that the ship was ready for decommissioning anyway, and it would cost Klinmar more than it was worth in time, bureaucracy, and effort to send the vessel back to some more usual Imperial facility. The crew thinks, however, that Klinmar was up to some typical Klingon double-dealing. The ship was probably no longer carried on the books, and needed to be disposed of quickly (at a profit to Klinmar, of course) through irregular channels. Recent reports of a Klingon Admiral on a prolonged visit to Marram IX tend to confirm this.

Another of the crewmen will remember something odd about the deal. At one of the meetings, there was a foul-up over scheduling, and some of the officers met a stranger on his way out of Klinmar's office. The source is sure that this person was not an Imperial Klingon. He might have been a Klingon/Human Fusion, although stance, skin tone, and other details seemed a bit odd. Whoever it was seemed reluctant to be seen. Of further interest was a set of deck plans for the *G-8* freighter already open on Klinmar's desk when they entered. Speculation among the crew was rife. Some think the stranger was a Klingon investigator who made a deal with Klinmar to keep things quiet, while others swear he was an Orion who was selling or turning over the freighter to Klinmar.

The crew members are generally unwilling to talk about other aspects of Marram IX, saying only that the Klingons seemed to have organized things with typical efficiency, and that it was too bad about the Federation scientists who were stuck there and forced to help the Empire. All agree that Klinmar shows a firm hand at the helm, and that he will not tolerate black market dealings by his troops. This comment should follow hard on the heels of all the speculation about Klinmar's dirty dealings with the freighter. If the players interrogate a crewman further on this seeming inconsistency, he will shrug it off with a comment that Klinmar does not have to obey his own rules.

Another rumor about Marram IX that the crew can pass on is a sort of boast that they were stopped by a bright-blue-painted destroyer that could only be one of sutai-Kargon's squadron. This famous Battle Group commander is notorious in the Triangle as one of the most ruthless, most tactically brilliant officers in the Imperial Navy.

A final rumor to hand out is a mention that the *Simone DeLeone* is scheduled for a six-week overhaul in a repair dock in a matter of days.

### FILE ALPHA 011

Gaining access to the shipboard computer on the *Simone DeLeone* will require a clever plan on the part of the player characters. They might be able to get on board by offering to purchase the ship from Richmond Enterprises. (If something like this did come up, Richmond would quickly 'buy back' the ship from the company for substantially less than he 'sold' it previously, and then sell to the adventurers at a profit.) This approach would entitle the player characters to an inspection tour, including a check of the ship's computer, which is commonly part of a pre-purchase examination. Not only would the group get a look at whether or not file Alpha 011 is full, but this would also open the way to a legitimate purchase of the ship if the file is really present.

Friends made among the crew on the ground can lead to visits aboard, and computer access might follow if the characters do a good job of espionage. If the players see fit, they can try other ploys, including a perfectly straightforward break-in using the warpshuttle's silent transporter. (Though the *G-8* would not use shields in orbit, transporter activity is detectable, and so there is some risk.) If the gamemaster wishes, he can create deck plans of areas relevant to the group's break-in.

To accomplish a query of computer file Alpha 011 requires a successful skill roll against *Computer Operations*. If the query is made, the computer will respond with a visual display of a set of numeric codes (indistinguishable from other elements of the avionics programs). These must be translated, either directly, using *Clandestine Operations* skill, or indirectly, by noting the display and later running it with *Computer Operations* skill a second time. Further skill rolls must be made for either of these methods to get a clear translation of the code groups.

The final result reveals that the file does indeed contain a great deal of material, and also that it has been sealed off by a security lock so that only the retinal patterns of Communications Officer Mouhkta of Operation Dixie can access the data.

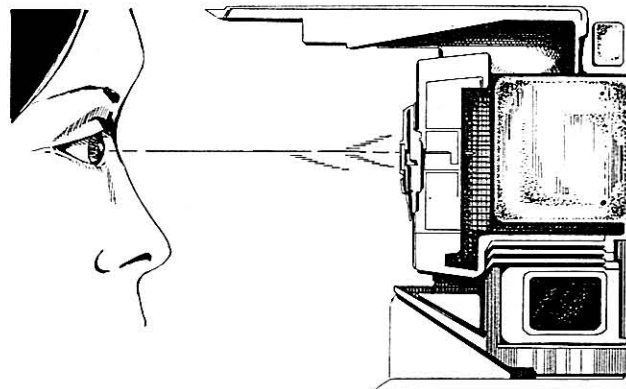

## RETURN OF THE DIXIE LADY

This discovery means, of course, that the ship must be returned to Star Fleet hands. Once again, how this is done will depend on the players. If they are using the cover identity of wealthy investors, they will have access to a Star Fleet discretionary fund through Captain Tremaine on Freeman's Port, and so could simply try to purchase the ship. Remember, however, that the characters are not on a sanctioned mission, and trying to draw SFIC money to pay for a freighter would probably set off all manner of queries and delays. Even if their actions resulted in the retrieval of the Dixie intelligence, the player characters could find themselves facing grave charges involving misuse of Star Fleet money, if SFIC decided to question their motives and methods somewhere down the line.

The alternative to a simple, legal sale is a simple, illegal hijacking. Though a variety of approaches are possible, there is a time limit because the ship is scheduled for an extended maintenance overhaul. Also, the hijacking would

Seconds do count, because Thisisit is not without muscle to keep the peace. A squadron of five Klingon-surplus gunboats will quickly put in an appearance within a few combat rounds of any alarm. If the adventurers do not get the freighter's shields up before Klingon reinforcements arrive, they can expect a visit from a well-armed boarding party. Should shields go up, a space battle will ensue instead. When the *G-8* is empty, it can outrun the gunboats. When it is first captured, however, it carries enough of a load to reduce performance significantly. It will require 2D10 x 5 uses of a cargo transporter to clear enough cargo to give the ship the higher level of operation. (This use of the transporters does not require that shields be dropped, as cargo can simply be scattered within the field radius.) Each cargo transporter requires the presence of one character with *Transporter Operation* skill. One round of space combat allows all manned transporters to operate once. Until the cargo is reduced, the *G-8* cannot streak away from Thisisit's gunboats, and so a fight will be inevitable.

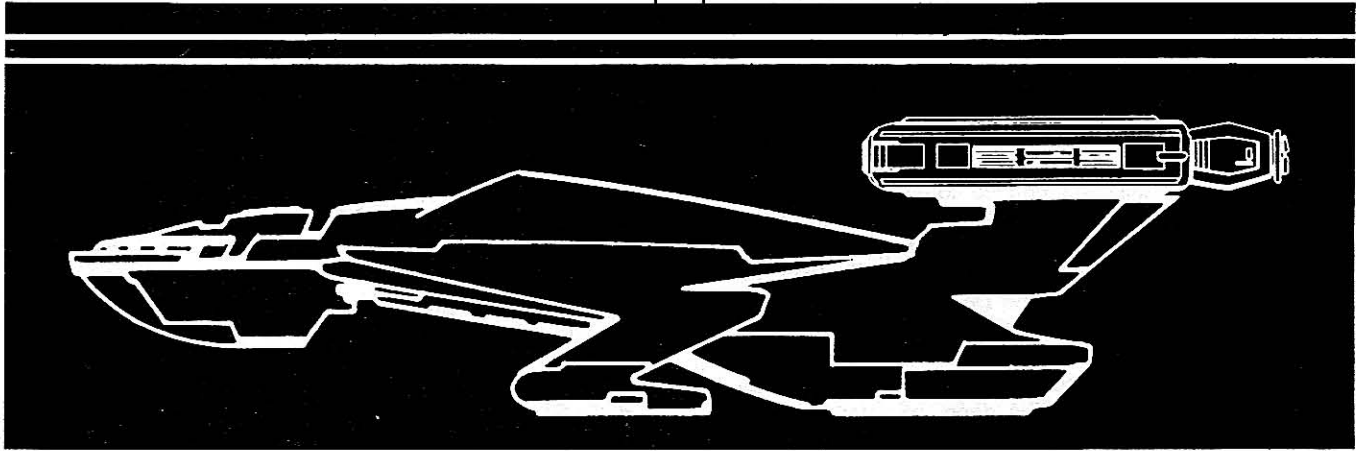

have to be executed at Thisisit, not in some other star system. These constraints are important, and the imminence of the overhaul leaves no time for a request for further instructions from Tremaine. A subspace radio message will take almost two days to reach Freeman's Port, and a similar amount of time to get back. By then, the *G-8* will be in a repair dock, immobile and unreachable. Waiting six weeks raises other unfortunate possibilities, such as an overhaul of the computer system that could purge the Dixie file, or other unforeseen changes in the overall situation. At this point, speed in making a decision and in carrying it out are essential.

If the players want to attempt a hijack, it will be up to them to come up with a plan for getting aboard ship, what to do with the crew, and so forth. In moderating the resolution of this plan, the gamemaster should keep in mind that not only is a hijacking unexpected, but the crew is not particularly efficient even when they ARE expecting trouble. Most of them will not even be around when the balloon goes up. On the other hand, the operation need not be a total shoe-in for the players, either. One alert crewman on watch could complicate things by calling for help, by taking refuge in engineering and cutting the ship's power, or by defending the bridge to the bitter end at a time when seconds count. The gamemaster can use these or similar details to create a tense atmosphere.

Another problem the player characters face is that Thisisit is by no means a hostile power, and blowing up police craft in the performance of duty is not usual Federation behavior. Here is where the gamemaster must evaluate player roleplaying, rewarding those who manage to avoid unnecessary loss of life, and handicapping those who are a little too eager to use firepower as a solution to their situation.

Resolution of the conflict should probably use the space combat rules of the *Starship Combat Game*. (Boarding party conflicts would probably require that the gamemaster create deck plans and miniatures or counters to resolve the action.) Keep in mind the player group's own warpshuttle as well as the *G-8*. On one hand, their ship should not be abandoned. On the other hand, it cannot as easily escape from pursuit, and so the group will have to take these factors into account.

If the players have done a credible job of staging their hijack, they should be able to escape from Thisisit, elude Klingon pursuit, and head back to Freeman's Port with the old *Dixie Lady* and her vital computer files, which could prove to be the most important data ever recovered for SFIC.

## A NEW CHALLENGE

Following the recovery of the *USS Dixie Lady*, events move into higher gear as the SFIC takes official cognizance of the case. Before long, the characters are again called upon to follow the trail of Operation Dixie, backtracking to Marram IX in search of a clue to the location of the Dixie prisoners. The rescue of one of these officers is of major importance, and will lead the characters into an exciting confrontation with Klingon ground forces at a remote Imperial labor camp.

### RETURN TO FREEMAN'S PORT

After the characters arrive at Freeman's Port with the *Simone DeLeone* (ex-*Dixie Lady*), Captain Tremaine will contact them again. In the period since their last meeting, he has been in touch with Star Fleet, hoping to get official approval of the Dixie investigation. The return of the ship with its computer files intact is a major personal triumph for Tremaine, though he hastens to assure the players that his reports have not ignored their role. Tremaine asks the adventurers to remain at Freeman's Port, offering them access to extensive computer files on subjects relating to their original case, so that they cannot be accused of neglecting their duties while he awaits a response from Star Fleet. Tremaine wants the chance to make an officially-sanctioned investigation of the fate of the *Dixie Lady's* crew, using the player characters as his field agents.

A response to Tremaine's preliminary report, which was sent in before the liberation of the *Dixie Lady*, comes in from Star Base 10 only two days after the players' group returns to Freeman's Port. Star Fleet gives Tremaine what he wanted—authorization to look into the matter and assignment of the adventurers to his direct command. Without further ado, the Captain gets the second investigation rolling. First, he files a report of the recovery of the *Dixie Lady*, requesting copies of the retina prints of Communications Officer Mouhkta so that the computer file can be retrieved. He also issues orders for his agents to trace the *Dixie Lady* back to Marram IX to investigate the fate of the prisoners taken from the ship's crew. This is a matter of supreme importance to Tremaine.

### ENROUTE

Back on board their warpshuttle, the adventurers face a long voyage of a over 56 days to Marram IX. As the planet lies in Klingon space and is rarely open to trade, they must adopt a cover identity suitable for gaining access to the world. If they consult Tremaine, he will suggest that they disguise their ship as a Klingon military warpshuttle carrying Imperial inspectors. This will mean that only the Fusion race characters will be able to move about freely on Marram IX. The others will have to keep under cover as backups, but there is no difficulty forging identification for such a disguise. If the characters have ideas of their own, the gamemaster can let them pursue any that seem reasonable. (Posing as the Klingon Emperor is NOT a reasonable approach. Posing as a trading vessel sent by Richmond Enterprises, which has had dealings here before, IS reasonable.)

Shortly before their arrival at Marram IX, the players' group receives a coded subspace radio message from Tremaine. After unscrambling and rendering it into Galacta, the adventurers read:

### PRIORITY CODE BLUE

FROM: Captain Nicholas Tremaine, SFIC  
Agent-in-charge, Freeman's Port  
TO: Warpshuttle *Galahad*  
NCU-5884

Starbase 10 reports Dixie personnel files destroyed in computer failure Ref. Stardate 2/2209.16. Retina patterns Mouhkta now unavailable. Imperative for success of Operation Dixie that you locate crew, ascertain survival Mouhkta, and recover same. Priority given this rescue, but retrieval other prisoners allowed your discretion. Maintain subspace silence. Mission yours through successful completion.

You're on your own, guys. Good luck.

### MARRAM IX

Assuming the characters have adopted a cover that will allow them 'legitimate' access to Marram IX, their arrival there will prove relatively uneventful. Intelligence reports had indicated the presence of three Battle Groups in the Marram system. (Usually, this would mean nine ships, but the actual number of vessels present is ten.)

On approach, ship's sensor readings identify six ships of 59,800 metric tons, which prove to be *D-14* destroyers. Two more, at 125,500 metric tons, prove to be *D-18* destroyers. These two ships and a Romulan-designed *L-42* frigate massing 146,400 metric tons, are painted with bright blue markings. A Saving Roll against INT by any of the characters will allow that individual to recall that similar markings are supposed to be the mark of Captain Kresz sutai-Kargon, a Klingon officer famous for his tactical skill.

The final ship is the largest vessel present, a 151,510 metric-ton Klingon cruiser identifiable as a Model G *D-10*. This ship does not seem to belong to any of the regular Battle Groups.

If the players' warpshuttle is using a military disguise, the party will receive permission to land at the high-security port complex near the Klingon base headquarters. A civilian ship, on the other hand, would be directed to the old colony starport.

In either case, the players' ship will arrive under heavy guard. Other aspects of their reception will depend on where they land and who they say they are, however.

The Klingons regard anyone landing at the colony starport as potentially dangerous interlopers who could be engaged in anything from black market smuggling to attempting to aid the subjugated colonists. New arrivals are closely watched, and their comings and goings severely restricted. Almost before the landing thrusters cool down, a comparatively minor garrison officer will call the player characters to demand a complete inspection of the ship and cargo, as well as a thorough explanation of why they have come to Marram IX. Like any good intelligence vessel, the warpshuttle does have some concealed compartments where the non-Klingon crew members can hide during the inspection.

To discover each of the 206 monitoring devices the Klingon inspectors have left behind after their tour, the players who are not hidden must make successful Skill Rolls equal to or less than their *Surveillance* ratings. A failed roll means that no devices are found or detected, although suitably paranoid characters should be allowed additional attempts until they have either discovered all the bugs or are satisfied that no more are present. Obviously, the players must think to check for such devices before being

allowed to make the rolls. If non-Klingon characters emerge while monitoring devices are still on board, there is a ten percent chance per undiscovered device per day that Klingon Security personnel will spot these characters, and an equal chance that indiscreet planning sessions will be overheard. The Klingons will not, however, act upon this information as long as Mouhkta's secret plans are moving ahead smoothly. Discovered bugs can be left in position and used to feed false intelligence to the Klingons.

From the starport, the player characters will have little access to the main Klingon headquarters, which is the only place where the prior history of the *Dixie Lady* is likely to be located. Security around the headquarters complex is tight, and so burglary or similar commando-style missions have little chance of success unless the Klingons know about the operation and *want* it to succeed. The gamemaster should keep this in mind when developing details for the resolution of such an attempt.

It is considerably easier for the adventurers to gain access to the headquarters complex if they have posed as visitors from the Empire, but they will still be under close scrutiny (because that is the way the Klingons operate). Although the Klingons would find it believable that a trader coming from the Triangle might have a few non-Klingon crew members on board, ALL non-Klingons must stay under cover when the ship must take part in something official. The exception to this would be player characters posing as *kuve* servitors, but too many on a warshuttle would also be highly suspect.

If posing as Klingons, the characters who can stay out in the open will be welcomed by Klinmar, the base's military governor, accompanied by a suitable retinue of aides and staff officers. Klinmar and other senior Klingon personnel will assume that the newcomers are spies sent by Imperial Intelligence to investigate Marram IX, and will do everything possible to keep tabs on them while seeming to be the very picture of cordial cooperation. Surveillance devices will probably wind up on board the adventurers' vessel, but they will be fewer in number and less easily deployed, giving the characters less trouble in keeping the shuttle clean.

Klinmar will be ready to give full cooperation to "inspectors" who have a plausible reason to tour his facilities. The adventurers will quickly discover some ideal opportunities to cause disruption in the Klingon ranks as they become aware of a three-way struggle for power in the upper ranks of the Klingon hierarchy (see **The Perpetual Game**), while also finding ways to learn more about Dixie (**Project Red File**). How they use these opportunities is up to them.

## THE PERPETUAL GAME

Klingon society revolves around a complex interrelationship between individuals, each engaged in the *Komerex zha*, the game of seeking power and prestige at any cost. In their constant attempts to bring down their rivals while keeping themselves safe from the machinations of others, Klingons trust no one and do not expect to be trusted.

A major confrontation in this "perpetual game" is brewing on Marram IX, where three prominent Klingons have squared off against each other as a result of their rival ambitions. In some ways, the conflict actually heightens the effectiveness of the rivals, as each is seeking to score points against the others. Properly devious player characters will find ways to exploit this situation to their advantage.

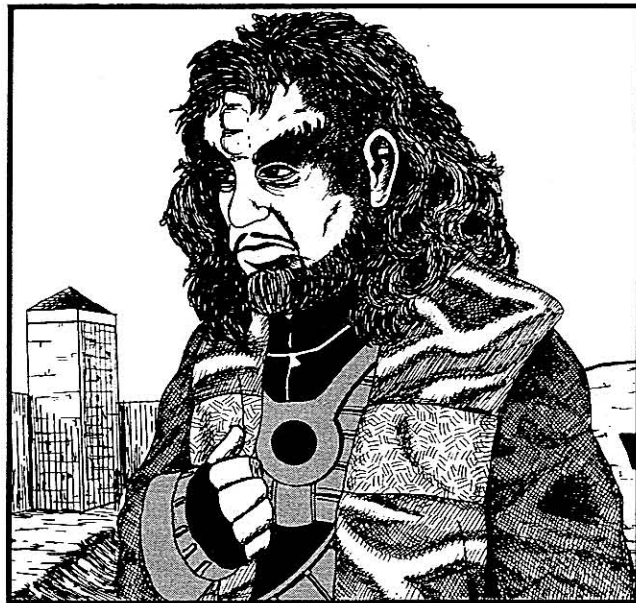

The first figure involved in this intrigue is Klinmar, the base commander. He is the least famous and lowest-ranking of the three, and resents it. Klinmar's twin goals are the completion of his base on time and the successful implementation of Mouhkta's intelligence scheme, which he sees as a chance to win friends in Imperial Intelligence while enhancing his image as a clever and efficient officer. Klinmar is trying to stay neutral in the head-on clash between the other two, but will gladly throw in with one or the other if he can win even more power or support that way.

Captain sutai-Kargon is a rising star in the Imperial Navy, the officer who once tricked a Federation squadron and knocked out a cruiser and two frigates with a handful of destroyers. He was senior naval officer on this station, building a power base that gave him command of three Battle Groups and the full support of the base commander, until he was superseded in command by an older, more famous admiral. Now Captain sutai-Kargon is fighting hard to discredit his rival.

Finally, there is Koloth, once the captain of a *D-7A* cruiser on the Organian frontier, but now risen to high rank and great personal influence in the Navy (despite the fact that he is a Klingon/Human Fusion, rather than a pure-blooded Imperial). His long-standing battle of wits with James T. Kirk continued even after both achieved Admiral's rank, although on a more rarified level. Both were with strategic planning staffs for a time, and both were eager to return to a more active role. Despite advancing age, Koloth got his wish, and intends to use his new position as Senior Commander of Marram IX to further enhance his reputation. Kargon stands in the way, however.

Both Kargon and Koloth have made reports to Imperial Intelligence that tried to cast doubt on the other's loyalty and ability, and they are likely to try to recruit newcomers as allies. The player characters can expect to be approached by both Kargon and Koloth at some point. Each will make insinuations about his rival, and try to sound out whether he can get the adventurers' support in "eliminating a dangerous weak link in the chain of command".

How the players respond to these overtures is up to them. If they have a proper understanding of Klingon psychology (which they should, if they are trying to

impersonate renegade Klingons), they will realize that the rivalry between Koloth and Kargon might be exploited to reduce the effectiveness of both officers. In particular, if each tries to find a way to cast blame on the other in the event of trouble at the base, that could tie up both of them if (and only if) the player characters can persuade each of the two officers that Imperial Intelligence designed the 'trouble' as a way to plot the other Captain's downfall.

Thus, player characters who wish to cause maximum disruption among the Klingons at the base can begin by dropping an assortment of hints about arrangements being made to put a rival in an untenable position. When a crisis does arrive, this could make both Kargon and Koloth hold back for a crucial few minutes. The gamemaster should determine the success of such subversive schemes by having player characters make a Saving Roll against the average of his *CHA* and *Clandestine Operations* skill, adding 1/10 of the target character's *INT* to the roll. If the Saving Roll is successful, the attempt to convince the NPC target to hold back at a crisis (as discussed in later sections) succeeds. Failure of the roll means that the target does not accept the idea, probably perceiving the player characters' overtures as some kind of trap prepared by his rival.

As for Klinmar, his attempts to avoid contact with this power struggle have no direct bearing on the players. The base commander is doing his best to keep his plot with Mouhkta a secret from both Kargon and Koloth, so that neither will try to take credit for the scheme or use it as another tool in their own personal power plays. For this reason, much of what is happening on Marram IX's surface is not known to the two naval leaders, though both have a natural curiosity about some of Klinmar's activities.

## PLAN RED FILE

Plan Red File ("ta Doq nab" in the Imperial Klingon dialect currently in vogue at the Imperial core) is the name given to the 'public' records of Klinmar's followup to Operation Dixie. This project code relates to the disposition of the Dixie prisoners, the sale of the freighter, and other matters. Direct questioning of Klinmar about the freighter will lead to access to Plan Red File. Cagey characters may try to run a bluff that suggests that they know the base commander is involved in something deeper than just the sale of the ship. If any of what they suggest sounds at all close to the truth of the Klingon plot, it will rattle Klinmar and lead directly to the revelations of **Plan White File**. However, it would take a shrewd or lucky player to make a guess like that so early. Random computer searches will always lead to Red File; the other project is kept in Klinmar's personal computer records, outside the regular base filing system.

As far as Klinmar knows, no one but he and Mouhkta are aware of the full scope of the Klingon plot, though there are others who know about some of its aspects. Klinmar does not want Imperial Intelligence to learn his plans yet, and so all inquiries are funnelled to Plan Red File unless the commandant thinks his secret has already been given away.

Player characters who gain access to Plan Red File records will learn that the *G-8* freighter they have recovered was sent to Marram IX two years ago by order of a high-ranking operative of Imperial Intelligence (who is nowhere named in the file). It is recorded that the freighter was a captured Federation spy vessel manned by a temporary Klingon crew and carrying the UFP survivors as prisoners. Records show that these prisoners have been assigned to a

work camp on the island known as Schleiman's Rock ("SI'manpH" in the Imperial dialect) as part of the expansion program to build outlying defense installations on Marram IX. Running logs of the work camp show several casualties among the 30-man work force, including Chief Engineer Koth, who was killed in what is laconically described as a "disturbance among the prisoners." Another prisoner, Arvan, is noted as having been in solitary confinement for the past year, without further details. Astur vestai-Krinith is noted as having escaped. Other information is not particularly important or interesting to the characters.

The crucial fact is this: The adventurers have discovered that the Dixie prisoners are right here on Marram IX, and that they are in a position to do something about freeing Mouhkta (and perhaps others), making a success of their mission.

## NEXT STEPS

Freeing some or all of the 22 Dixie prisoners noted in Plan Red File will take more preparation than simply jumping aboard the warpshuttle and launching a lightning raid on Schleiman's Rock. It is up to the players, of course, to plan the next move, but the gamemaster may be in a position to at least give some advice or suggestions that can steer them in the right direction.

Local assistance will be needed to carry off an effective raid, because Plan Red File carries no details of the layout of Schleiman's Rock. If approached directly about the work camp, Klinmar will become rather nervous and uncooperative. He will give vague replies, not wishing to reveal too much about the camp's special prisoners if he thinks this might disturb his carefully-prepared plan. If the players seek to have the prisoners turned over to Imperial Intelligence, Klinmar will use every possible excuse to resist giving up control of the prisoners. His prevarication and resistance should, in fact, take a dangerous form, such as querying a higher authority, which the adventurers cannot afford to risk.

Therefore, the players' group will need some kind of local assistance. Those player characters who must avoid the Klingons are ideally suited to the task of slipping out quietly and infiltrating the colony proper to search for help.

Unfortunately, the colonists have no stomach for rebellion. Following the example of their leader, Doctor Jones, these "sheilas" are out-and-out collaborators. There is a 50 percent chance (+ a modifier of 1/10 of the approaching character's *CHA*) that a character who asks for help from a colonist will be turned over to the Klingons immediately. If the player character is a Klingon/Human Fusion, the base chance for being turned in is 75 percent, as the colonist will be certain it is some kind of trap set by the Klingons to catch subversives.

A character who is turned in will be sent to Schleiman's Island, but Klinmar will leak news of the capture to a suspected double agent, who can pass the word on to the colonial resistance movement. The captured character will then be rescued, and so meet up with the Resistance.

Characters who are NOT betrayed receive no direct help from the colonial(s) they contact. They will, however, be advised to seek out the guerrilla forces supposed to be operating in the hills. Fusion-race characters who go into the wild in search of guerrillas will be ambushed (and probably killed), but Humans will be contacted by the Resistance.

## PROJECT MINUTEMAN

One way or another, characters who venture out into Marram IX's wilderness will end up encountering a representative of Project Minuteman, a group of SFIC operatives who are attempting to liberate the Human colonists on the planet. The encounter begins when the adventurers are surrounded abruptly by twelve figures in ragged clothing, all armed with phaser rifles. If the player characters were captive of a Klingon escort, the guerrillas will quickly eliminate Klingons and their vehicles and equipment from ambush.

The rescue force is led by a grimy but attractive woman, looking almost too small to use the phaser rifle she carries. Once the characters have been established as friendly, Team Leader Sinclair from the Klingon Sector of Star Fleet Intelligence will introduce herself. She and another agent, Lieutenant Commander O'Mara, are in charge of the colonial guerrillas in this district. Depending on the circumstances of the encounter, Sinclair may or may not know at first that the characters are Federation agents, but she certainly knows that they are not colonists. She and her people are well aware of all the Human settlers on Marram IX. As soon as possible, then, Sinclair will want to know just who they are and what they are doing in 'her' territory.

If the characters choose to outline their situation and needs, Sinclair will be inclined to be cooperative but scornful. (Agents of SFIC's Klingon sector tend to feel superior to the newer Triangle Sector operatives.) Her comments on the subject, however, are cut off after her partner, O'Mara, begins commenting on the problems that have plagued their own operation, Project Minuteman. Begun as an attempt to liberate the Marram IX colonists, it has since degenerated into a rather pointless exercise in ongoing guerrilla warfare, thanks to the apathy of the "sheilas" in the colony.

After these comments by O'Mara, Sinclair's tone becomes less mocking. She would be willing to lend her assistance in rescuing the Dixie prisoners, provided her own guerrilla band could leave the planet as well. She feels that Project Minuteman cannot amount to anything worthwhile, especially since the backup ship that was supposed to evacuate the team was lost in a previous recovery attempt. To sweeten the deal, Sinclair mentions that Project Phantom, a set of surprises concocted by O'Mara, is available to cover an escape from Marram IX. The players' group would probably accept her terms.

It is possible, though, that the characters will back off from seeking Sinclair's help. If they are doing a good job of roleplaying, the rivalry between their Triangle Sector and the Klingon Sector of SFIC may make them want to keep Sinclair out of the plan. The guerrillas are firmly behind Sinclair, however, which means the adventurers will need her help to find and raid the work camp. Moreover, once Sinclair's curiosity is aroused, she will keep an eye on the characters, and she will most likely come to their rescue (this time *really* trumpeting the merits of the Klingon Sector) whether the group is in desperate straits or not.

## RESCUE MISSION

With the aid of Project Minuteman and their guerrilla followers, the adventurers can lay serious plans for a rescue mission. Once the players have access to guerrilla help, the gamemaster can show the map of the prison camp to them (see **Gamemaster's Information**).

Plans for this raid have to come from the players, and so there is no way to predict all the possible ways a group of players might choose to make an assault. A direct attack is not likely to succeed, however. Only the gates can be successfully penetrated from the outside, and these are well-defended. Therefore, any assault from the outside must be either diversionary or coordinated with a "bore-from-within" tactic that will take out the force field generators securing the camp.

The party could be beamed into the camp, but Klingon sensors would quickly detect transporters used for this purpose. It will be only a matter of 1D10 minutes before the source of the transporter beam comes under attack by orbiting Klingon ships. Sinclair will know this, and so will point out the inadvisability of an attack that requires such close timing to complete the whole mission and run.

The best method is to find a way to penetrate the camp without drawing attention to the raiding party. Just how this is done depends on the group. One obvious way, if they are already posing as inspectors, is to get Klinmar to agree to their inspection of the facility. This will get the players and their warpshuttle right inside the camp. To leave again, however, they must turn off the work camp's force field.

Execution of the rescue mission should follow the usual rules and procedures of the game. The gamemaster should also note that the Klingons, once they realize a prison break is in progress, will be ordered **NOT TO WIN**. Mouhkta and Klinmar *want* Mouhkta to be 'rescued', and so will instruct the prison guards to fight hard and doggedly, but, ultimately, to allow the prisoner to escape. The gamemaster must not be *too* obvious in throwing the fight, but if the players get the feeling that "that was too easy," it could be an important clue for them. Remember, too, that the rescue of Mouhkta will not trigger a vigorous pursuit by the Klingons, except to keep up appearances. Sinclair's warnings of Klingon retaliation could easily prove false under these circumstances. Nevertheless, the players should *think* they are waging a difficult and dangerous battle with their enemies.

In the course of resolving the rescue mission, the player characters may receive unlooked-for help from Astur vestai-Krinit, formerly one of the Dixie prisoners. Since his escape from the work camp, he has existed as a solitary renegade in the hills. Astur can be useful in helping the party uncover the truth about Mouhkta and his plan, but whether or not to introduce him is up to the gamemaster. (He can base his decision on how well the players have been doing up to this point.)

Ultimately, of course, Mouhkta should be rescued. The players' group may also recover some or even most of the other Dixie prisoners, depending on their skill in carrying out the raid. It is advisable, however, that no Dixie prisoner with skill in *Warp Drive Technology* be rescued uninjured. (An injured character is allowable, providing he cannot participate actively during the critical hour or so following the rescue.) The reason for this will be made clear in **Turning Point**.

## TURNING POINT

Either during or immediately following the raid, the game-master should find a way for the warpshuttle to come under fire. If the shuttle was actually involved in the attack, a stray shot from a disrupter cannon can hit the craft. Otherwise, over-eager Klingon pursuit ships may get in a lucky shot before word filters down that the target is *supposed* to escape.

In any event, the shuttle should take a hit to the engineering section, severely damaging some of the warp drive controls. Any character making a successful Skill Roll against *Warp Drive Technology* can work on the damaged system. During any turn when two characters can simultaneously make such a skill roll, the ship will be capable of warp speeds. Until then, the vessel is crippled and almost helpless.

Only one sufficiently skilled character should be available on board. Then Mouhkta will volunteer to help, saying that he has had some training and might be able to assist. The gamemaster should keep this offer low-key, almost casual. It is, however, a clue of extreme importance, as Mouhkta's personnel files showed no engineering experience. Indeed, the analysis of Dixie's betrayal (see the **Operation Dixie Handout**) noted that Mouhkta was a low-priority suspect because he lacked the skill to sabotage the two ships on which he served.

This is a crucial turning point in the adventure. If the players fail to realize the significance of this clue, and if the gamemaster does not introduce anyone who can remind them of the inconsistency, then the group will simply escape. There will be no close-pressed pursuit beyond a token Klingon show of effort to make the escape seem convincing. Mouhkta is delivered to Captain Tremaine, who in turn gets the Klingon spy back into Star Fleet Intelligence, where he spreads false information and awaits a chance to attempt new, even more devastating betrayals.

If, however, the truth dawns on the group before they make good their escape, they are in a position to do something about it. In that case, the adventure moves into its final, most challenging phase.



## DIXIE TRIUMPHANT

In this segment of the adventure, the characters have a chance to retrieve the *real* Dixie information, and return home in triumph.

### THE MISSING PIECE

Having discovered that Mouhkta is the mole, the adventurers can use *Interrogation* skill to make him talk (See the **Gamemaster's Notes** on Judging Klingon Characters.) A successful interrogation will reveal that Klinmar is keeping Arvan tai-Vinsar, another of the Dixie prisoners, at the base headquarters facility. It is believed that Arvan somehow concealed the real information gathered by Operation Dixie, but no one knows where. Despite nearly a year of intermittent interrogation, tai-Vinsar has managed to keep from breaking and revealing the secret.

This missing piece of the puzzle and the discovery of Mouhkta's sweeping plot (**Plan White File**) will lead the adventurers to their final task, the difficult and dangerous job of freeing tai-Vinsar from the base headquarters and then escaping alive.

### PLAN WHITE FILE

The ultimate Klingon plan is described in the **Gamemaster's Information** chapter. Under interrogation, the Klingon spy will provide only bits and pieces of the overall scheme. A full summary of the project is also contained in Klinmar's office, in a small computer system not directly tied in to the base records.

Plan White File ("ta chISnab" in the Imperial dialect) was Mouhkta's brainchild, hatched shortly after his betrayal of the *Dixie Lady*. The following crucial bits of information relate to the operation.

—The data contained in the *Dixie Lady/Simone DeLeone* computer banks is entirely false.

—The ship was deliberately sold to Richmond Enterprises in the hope that Star Fleet would discover and trace it.

—The Klingons *wanted* the Dixie prisoners, and particularly Mouhkta, to be freed by Star Fleet so that the mole could return to the Federation.

—Arvan tai-Vinsar is the only Dixie officer who knows the fate of a computer module containing a duplicate of the real Dixie information, and he has not revealed this knowledge to anyone.

[NOTE: The gamemaster can reveal additional details if the characters find means to legitimately learn more. However, the above information is as much as can be learned by interrogating Mouhkta, and should be uncovered one bit at a time in accordance with the normal interrogation process.]

## RETURN ENGAGEMENT

Freeing Arvan and his information is another phase of the adventure that cannot be defined too precisely in advance, as so much depends on how the player characters proceed. The gamemaster should resolve the details of the mission as he sees fit.

There are certain restrictions on player options, however. The base headquarters is shielded, and so the players cannot simply transport in a team of commandos. Landing outside and charging in with guns blazing is possible, but only for those who consider suicide a desirable game outcome. As with the work camp raid, finesse, not brute force, is most likely to work. If the player characters have established themselves as officials from the Empire, access to the building will be easy enough.

Arvan is confined in one of the detention cells on the second level of the HQ building. He is currently recovering from a particularly nasty bout of torture. The only two ways for freeing him are by written authorization from Klinmar or by an outright assault.

There are also two ways out: either through the front door or via Klinmar's personal transporter. Only Klinmar's transporteer, and Klinmar himself, know the access codes that must be punched in to free up the controls to operate the transporter. Controls in the transporter room will also drop the base shields so that the transporter can operate.

The building description in the *Gamemaster's Information* chapter describes the layout and contents of the building, including the numbers and locations of guards. In addition, 1D10 + 5 combat rounds after any Klingon has had a chance to sound an alarm, guards will begin to arrive from a nearby building to reinforce the HQ security people. On each round, 1D10-5 squads of Klingon soldiers (seven troopers to a squad) will arrive. Die roll results of 0 or less mean no new troops arrive in that turn. For all practical purposes, there is no limit to the number of reinforcements that might arrive.

The Service Area on the first floor controls all power for the HQ building. If it is knocked out, all lights, computers, and other electrical or electronic systems (including shields and the transporter) are out of action until reserve generators elsewhere on the base are cut in. There is a ten percent chance that this will happen immediately. On the next combat round, the chance is 20 percent. On the second round, 30 percent, and so on. While power is out, a party could be transported out of the base. If the shields cut in while a party is actually transporting, the difficulty of the transporter operation causes a -25 penalty to the operator's skill, in addition to any other modifications called for under the usual rules.

Klingons do not flinch from the prospect of losing senior officers, and so the idea of taking Klinmar as a hostage is not likely to work.

## PURSUIT AT WARP SPEED

If the characters raid the HQ and escape back to their ship, they face a dangerous situation—pursuit by Klingon ships, some of which are perfectly capable of keeping up with the warpshuttle. It is at this point that Lieutenant Commander O'Mara's Project Phantom becomes useful. At this time, the players may also exploit the rivalry between the local Klingon leaders (if the seeds were properly planted earlier) to cut down on the danger of the pursuit.

Under normal circumstances, the Klingon ships will launch an all-out pursuit as soon as the warpshuttle breaks

orbit. All the Klingon ships can at least keep pace with the warpshuttle, but both the Battle Group under Kargon and Koloth's flagship can outdistance the shuttle at will.

If either or both officers have been convinced that his rival is being led into a trap, their pursuit will be much more cautious. This caution will become even more pronounced if O'Mara can execute Project Phantom.

Project Phantom was created as a means of covering the escape of Minuteman personnel from Marram IX. Hidden among the asteroids in orbit just beyond the Klingon planet are a number of transmitters that O'Mara has programmed to simulate a flight of Romulan ships. Each ship combat round, a character manning the communications station of the warpshuttle can manipulate these transmitters in such a way as to produce a very realistic set of de Broglie waves and random radio traffic mimicking a Romulan force moving under cloaking devices to strike at Marram IX or at the Klingon pursuit ships. To maintain the deception, the operator must make a successful Skill Roll against the average of his *Communication Systems Operation* and *Computer Operation* skills. O'Mara receives a -20 modifier to all rolls.

Successful deception *automatically* throws off any Klingon officer except Kargon and Koloth; they will break off the pursuit and withdraw on sensing the 'Romulan presence'. Kargon and Koloth each get Saving Rolls against their INT scores, but if they are expecting some kind of trap set for their rival, the INT should be halved. One saving roll is made each turn that the deception is successfully maintained, until there have been either three successful saving rolls (in which case the two Klingons realize it is a trick and close in to take or destroy the warpshuttle), or three unsuccessful deception attempts (same result), or three failed Klingon saving rolls (at which point that officer breaks off). Each of the Klingons resolves this process separately.

There is very little hope for the characters if the Klingons do NOT break off. Gluttons for punishment may resolve a detailed starship combat action if they so desire, but a warpshuttle pitted against a Klingon fleet has minimal chances of survival.

## COMING HOME

If the characters escape from Marram IX and return with Arvan to Freeman's Port, they will have done the Federation a very good turn indeed. Arvan carries the missing Dixie records in a tiny chip hidden subcutaneously in his artificially reinforced leg. The chip is self-erasing and can only be played once it is in SFIC computer banks. Thus, adventurers cannot examine the data for themselves. Although some of the Dixie officers know some of the contents of the file, no one knows all of it, and none of them are talking. They do reveal, however, that the Dixie tapes contain a great deal of very important and sensitive data on the Kinshaya, a race that occupies the space on the far edge of the Klingon Empire. Knowledge of the Kinshaya will, they say, be very important to the formulation of future UFP policies toward the Klingons.

The adventurers will return with Tremaine to the Federation, and it is quite likely that their success will lead to promotions or reassignment to duty stations of their choice.

Although it is a year and many lives late, SFIC's Operation Dixie has, thanks to the player characters, finally returned.



# VESSELS

Several specific ship types appear in or are peripheral to this adventure. For the convenience of the gamemaster, information on these ships is provided below.

## W-4 (SPEEDSTAR) CLASS III WARPSHUTTLE

### Construction Data:

<i>Model Number-</i>	A	B
<i>Date Entering Service</i>	2/1110	2/1504
<i>Number Constructed-</i>	594	394

### Hull Data:

<i>Superstructure Points-</i>	4	5
<i>Damage Chart-</i>	C	C
<i>Size</i>		
Length-	90m	90m
Width-	20m	20m
Height-	20m	20m
Weight-	21,100 mt	24,300 mt

### Cargo

<i>Cargo Units-</i>	30 SCU	30 SCU
<i>Cargo Capacity-</i>	1500 mt	1500 mt
<i>Landing Capability-</i>	Yes	Yes

### Equipment Data:

<i>Control Computer Type-</i>	ZD-3	ZD-4
<i>Transporters-</i>		
standard 6-person	1	1
cargo	1	1

### Other Data:

<i>Crew-</i>	10	10
<i>Passengers-</i>	20	20
<i>Shuttlecraft-</i>	None	None

### Engines And Power Data:

<i>Total Power Units Available-</i>	21	21
<i>Movement Point Ratio-</i>	1/1	1/1
<i>Warp Engine Type-</i>	KWB-1	KWB-1
Number-	2	2
Power Units Available-	9	9
Stress Charts-	O/Q	O/Q
Maximum Safe Cruising Speed-	Warp 7	Warp 7
Emergency Speed-	Warp 8	Warp 8
<i>Impulse Engine Type-</i>	KIB-1	KIB-1
Power Units Available-	3	3

### Weapons and Firing Data:

<i>Beam Weapons Type-</i>	KD-10	KD-2
Number-	2	2
Firing Arcs-	1 f/p, 1 f/s	1 f/p, 1 f/s
Firing Charts-	C	G
Maximum Power-	3	4
Damage Modifiers-		
+1	(1-6)	(1-10)

### Shields Data:

<i>Deflector Shield Type-</i>	KSI	KSD
Shield Point Ratio-	1/1	1/1
Maximum Shield Power-	14	12

### Combat Efficiency:

<i>D/WDF-</i>	55.2/1.4	83.1/2.8
---------------	----------	----------

### Game Notes:

The characters in this adventure have a Model A version of this warpshuttle, one of seven captured by Star Fleet and redeployed as intelligence vessels.

As it is of Klingon manufacture, the ship uses the empire's famous "noiseless transporter". An additional 5-point penalty is applied to all Skill Rolls against *Transporter Operation Procedure*, as discussed in *The Klingons Supplement*.

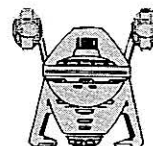
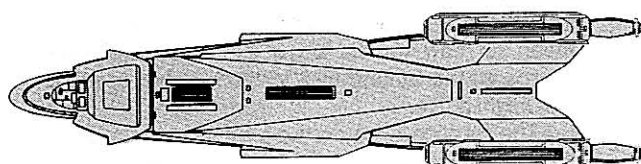
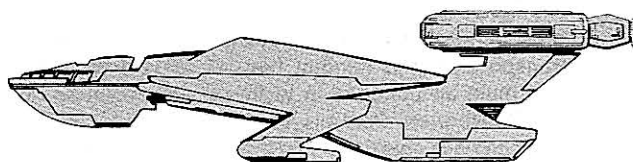

## G-8 (TRADER'S GAME) CLASS IV CARGO FREIGHTER

<b>Construction Data:</b>	
Model Number-	A
Date Entering Service-	IV
Number Constructed-	1/9501
<b>Hull Data:</b>	
Superstructure Points-	7
Damage Chart-	A
Size	
Length-	210m
Width-	100m
Height-	60m
Weight-	35,200 mt
Cargo	
Cargo Units-	2300 SCU
Cargo Capacity-	115,000 mt
Landing Capability-	None
<b>Equipment Data:</b>	
Control Computer Type-	ZD-4
Transporters-	
standard 6-person	1
cargo	8
<b>Other Data:</b>	
Crew-	24
Passengers-	6
Shuttlecraft-	4
<b>Engines And Power Data:</b>	
Total Power Units Available-	29
Movement Point Ratio-	2/1
Loaded-	6/1
Warp Engine Type-	
Number-	KWB-3
Power Units Available-	2
Stress Charts-	13
Maximum Safe Cruising Speed-	Q/Q
Loaded-	Warp 8
Emergency Speed-	Warp 4
Loaded-	Warp 9
Emergency Speed-	Warp 5
Loaded-	Warp 5
Impulse Engine Type-	
Power Units Available-	KIB-1
	3
<b>Weapons and Power Data:</b>	
Beam Weapon Type-	
Number-	KD-1
Firing Arcs-	2
Firing Chart-	1 p/l/s, 1 p/a/s
Maximum Power-	B
	4
<b>Shields Data:</b>	
Deflector Shield Type-	KSE
Shield Point Ratio-	1/1
Maximum Shield Power-	11
<b>Combat Efficiency:</b>	
D/WDF-	46/1.4

### Game Notes:

All three of Dixie's primary vessels were G-8 freighters. The *Dixie Lady*, aka *Simone DeLeone*, is this type of ship.

Although a crew of 24 is normally needed for such a ship, it can be flown with fewer personnel. A Helmsman, a Navigator, a Communications Officer, and two Engineers can handle essentials. The full complement, however, calls for Captain, Helmsman, Navigator, Communications Officer, four Bridge Watchstanders, Chief and Second Engineers and four Engineering Watchstanders, two Gunners, a Cargo Officer, a Purser/Chief Steward, and four cargo handler/steward crew personnel. The purser also handles medical responsibilities. As can be seen, many positions are unnecessary or redundant for basic ship-handling needs.

Like the warpshuttle, the G-8 uses Klingon transporters.

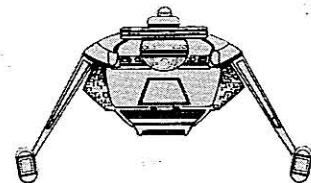
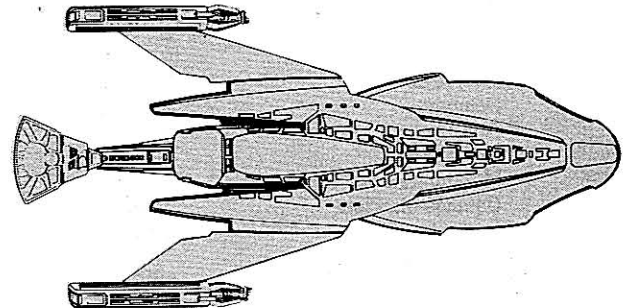
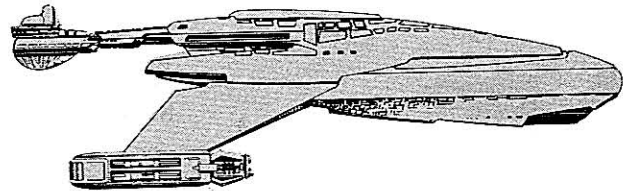

## K-3 (KALATH) CLASS II GUNBOAT

### Construction Data:

<i>Model Numbers-</i>	A	B
<i>Ship Class-</i>	II	II
<i>Date Entering Service-</i>	1/8909- 2/1106	1/9212
<i>Number Constructed-</i>	466	1336

### Hull Data:

<i>Superstructure Points-</i>	3	3
<i>Damage Chart-</i>	C	C
<i>Size</i>		
Length-	53m	53m
Width-	23m	23m
Height-	9 m	9 m
Weight-	8300 mt	8300 mt

### Cargo

Cargo Units-	2 SCU	2 SCU
Cargo Capacity-	100 mt	100 mt
Landing Capability-	Yes	Yes

### Equipment Data:

<i>Control Computer Type-</i>	ZD-2	ZD-2
<i>Transporters-</i>		
standard 6-person	1	1

### Other Data:

<i>Crew-</i>	10	10
<i>Passengers-</i>	None	None
<i>Shuttlecraft-</i>	None	None

### Engines And Power Data:

<i>Total Power Units Available-</i>	12	15
<i>Movement Point Ratio-</i>	1/1	1/1
<i>Warp Engine Type-</i>	KWA-2	KWB-2
Number-	1	1
Power Units Available-	10	12
Stress Charts-	P/Q	O/P
Maximum Safe Cruising Speed-	Warp 6	Warp 6
Emergency Speed-	Warp 7	Warp 7
<i>Impulse Engine Type-</i>	KIA-2	KIB-1
Power Units Available-	2	3

### Weapons and Firing Data:

<i>Beam Weapon Type:</i>	KD-2	KD-2
Number-	2	2
Firing Arcs-	F	F
Firing Chart-	G	G
Maximum Power-	4	4
Damage Modifiers-		
+1	(1-10)	(1-10)

### Shields Data:

<i>Deflector Shield Type-</i>	KSB	KSC
Shield Point Ratio-	1/1	1/1
Maximum Shield Power-	10	11

### Combat Efficiency:

<i>D/WDF-</i>	35.8/2.8	40.8/2.8
---------------	----------	----------

### Game Notes:

A squadron of five of these gunboats has been sold to the government of Thisisit, and these ships will be dispatched to pursue the characters if they steal the *Simone DeLeone* from Richmond Enterprises. This leads to the skirmish that forms the climax to *In Search of Dixie*.

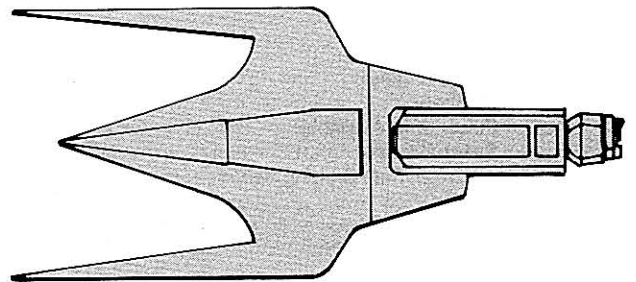
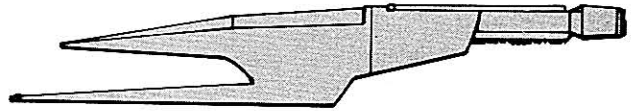

## D-14 (STINGER) CLASS VI DESTROYER

### Construction Data:

<i>Model Numbers-</i>	A	B
<i>Ship Class-</i>	VI	VI
<i>Date Entering Service-</i>	2/1607	2/2008
<i>Number Constructed-</i>	142	66

### Hull Data:

<i>Superstructure Points-</i>	15	15
<i>Damage Chart-</i>	C	C
<i>Size</i>		
Length-	220 m	220 m
Width-	170 m	170 m
Height-	42 m	42 m
Weight-	59,800 mt	60,100 mt

### Cargo

<i>Cargo Units-</i>	80 SCU	80 SCU
<i>Cargo Capacity-</i>	4,000 mt	60,100 mt

### Landing Capability-

	None	None
--	------	------

### Equipment Data:

<i>Control Computer Type-</i>	2D-5	2D-5
<i>Transporters-</i>		
standard 6-person	2	3
emergency 18-person	2	2
Cargo	1	1
<i>Cloaking Device Type-</i>	None	KCB
<i>Power Requirement-</i>	-	22

### Other Data:

<i>Crew-</i>	285	292
<i>Passengers-</i>	30	30
<i>Shuttlecraft-</i>	2	2

### Engines And Power Data:

<i>Total Power Units Available-</i>	40	40
<i>Movement Point Ratio-</i>	3/1	3/1
<i>Warp Engine Type-</i>	KWC-3	KWC-3
Number-	1	1
Power Units Available-	22	22
Stress Charts-	L/M	L/M
Maximum Safe Cruising Speed-	Warp 6	Warp 6
Emergency Speed-	Warp 7	Warp 7
<i>Impulse Engine Type-</i>	KIE-3	KIE-3
Power Units Available-	18	18

### Weapons and Firing Data:

<i>Beam Weapon Type-</i>	KD-6	KD-6
Number-	1	1
Firing Arcs-	1 p/a, 2 t/p/s, 1 s/a	1 p/a, 2 t/p/s, 1 s/a
Firing Chart-	T	T
Maximum Power-	6	6
Damage Modifiers-		
+2	(1-18)	(1-18)
<i>Missile Weapon Type-</i>	KP-1	KP-2
Number-	2	2
Firing Arcs-	1f, 1a	1f, 1a
Firing Chart-	F	H
Power to Arm-	1	1
Damage-	6	100

### Shields Data:

<i>Deflector Shield Type-</i>	KSG	KSG
Shield Point Ratio-	1/2	1/2
Maximum Shield Power-	11	11

### Combat Efficiency:

<i>D/WDF-</i>	74.5/23.4	74.5/27.0
---------------	-----------	-----------

### Game Notes:

There are two 3-ship Battle Groups of Model A D-14s stationed at Marram IX, and these ships will be certain to pursue the adventurers in their flight from the planet at the height of the adventure.

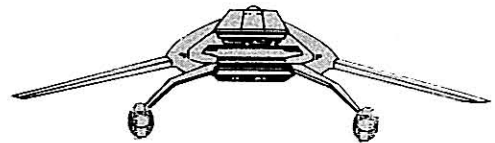
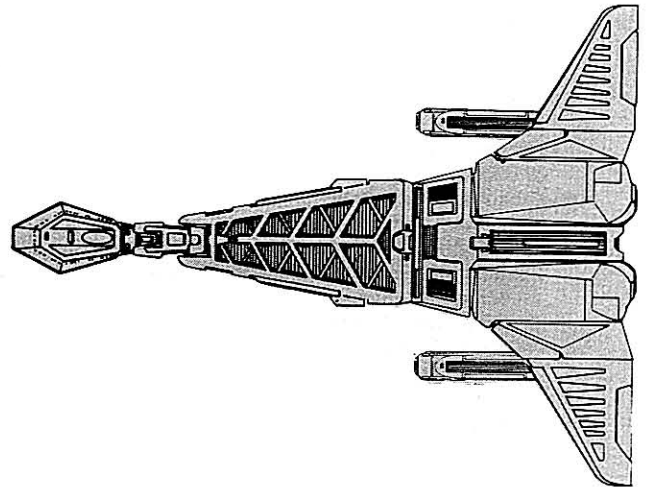
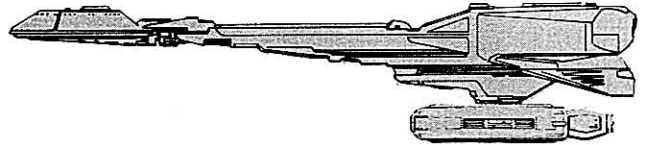

## L-42 (GREAT BIRD) CLASS IX-X FRIGATE

<b>Construction Data:</b>		
<i>Model Numbers-</i>	A	B
<i>Ship Class-</i>	IX	X
<i>Date Entering Service-</i>	2/2101	2/2106
<i>Number Constructed-</i>	12	8
<b>Hull Data:</b>		
<i>Superstructure Points-</i>	22	26
<i>Damage Chart-</i>	C	C
<i>Size</i>		
Length-	164 m	164 m
Width-	242 m	242 m
Height-	31 m	31 m
Weight-	120,000 mt	146,400 mt
<b>Cargo</b>		
Cargo Units-	60 SCU	60 SCU
Cargo Capacity-	3000 mt	3000 mt
Landing Capability-	None	None
<b>Equipment Data:</b>		
<i>Control Computer Type-</i>	ZD-6	ZD-6
<i>Transporters-</i>		
standard 6-person	3	3
emergency 18-person	2	2
Cargo	1	1
<i>Cloaking Device Type-</i>	KCC	KCD
<i>Power Requirement-</i>	32	48
<b>Other Data:</b>		
<i>Crew-</i>	220	240
<i>Passengers-</i>	10	10
<i>Shuttlecraft-</i>	2	2
<b>Engines And Power Data:</b>		
<i>Total Power Units Available-</i>	55	63
<i>Movement Point Ratio-</i>	3/1	4/1
<i>Warp Engine Type-</i>		
Number-	2	2
Power Units Available-	16	20
Stress Charts-	H/J	H/J
Maximum Safe Cruising Speed-	Warp 8	Warp 7
Emergency Speed-	Warp 9	Warp 8
<i>Impulse Engine Type-</i>		
Power Units Available-	23	23
<b>Weapons and Firing Data:</b>		
<i>Beam Weapon Type-</i>		
Number-	KD-13	KD-13
	6 in 2	6 in 2
	banks of 3	banks of 3
Firing Arcs-	3 t/p, 3 f/s	3 t/p, 3 f/s
Firing Chart-	X	X
Maximum Power-	5	5
<i>Damage Modifiers-</i>		
+3	(1-7)	(1-7)
+2	(8-15)	(8-15)
+1	(16-22)	(16-22)
<i>Missile Weapon Type-</i>		
Number-	KP-6	KP-5
Firing Arcs-	1	4
Firing Chart-	F	2/f, 2/a
Power to Arm-	R	Q
Damage-	2	1
	20	10
<b>Shields Data:</b>		
<i>Deflector Shield Type-</i>		
Shield Point Ratio-	KSP	KSP
Maximum Shield Power-	1/3	1/3
	15	15
<b>Combat Efficiency:</b>		
<i>D/WDF-</i>	130.5/40.1	133.2/57.8

### Game Notes:

A Model B is the leader of the strongest Klingon Battle Group, commanded by Captain Kresz sutai-Kargon. It will only join in a pursuit under certain circumstances, as described in the adventure narrative. The ship is notable because of its bright blue markings, and is accompanied by two blue-painted D-18D Class IX destroyers.

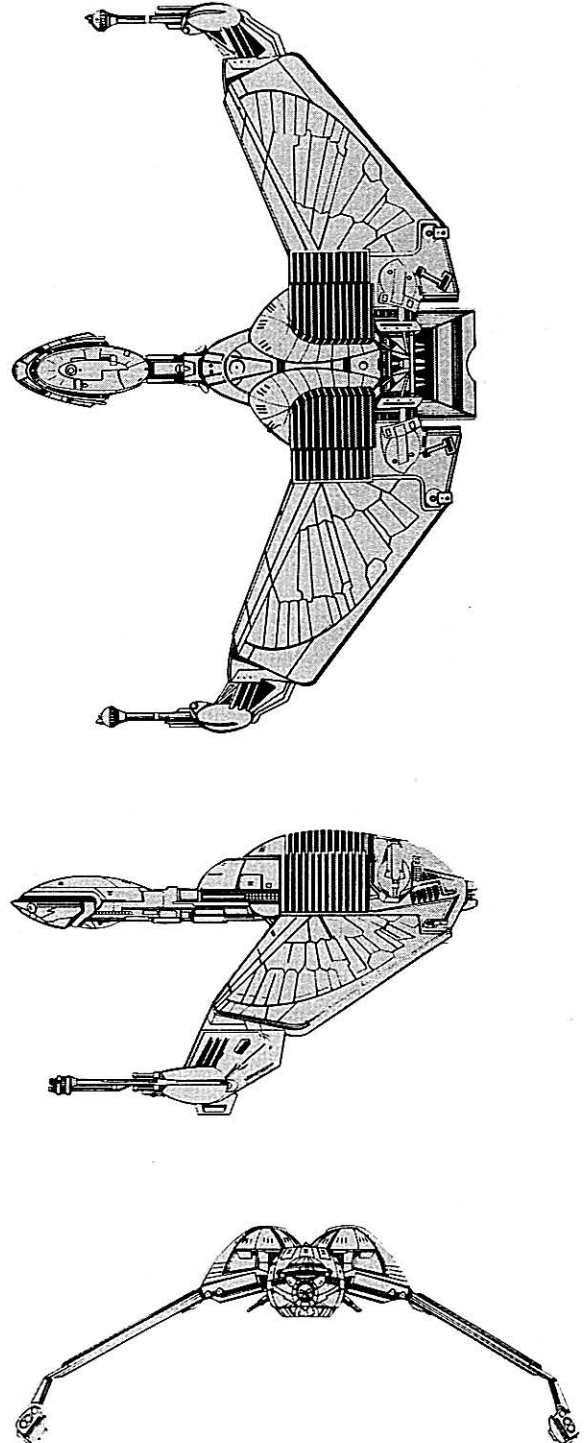

## D-18 (GULL) CLASS VII-IX DESTROYER

### Construction Data:

Model Numbers-	A	B	C
Ship Class-	VII	IX	IX
Date Entering Service-	2/0108- 2/1512	2/1110	2/1803
Number Constructed-	231	358	82

### Hull Data:

Superstructure Points-	14	14	14
Damage Chart-	C	C	C
Size			
Length-	215 m	212 m	212 m
Width-	159 m	159 m	159 m
Height-	38 m	38 m	38 m
Weight-	90,500 mt	3,500 mt	125,800 mt

### Cargo

Cargo Units-	65 SCU	70 SCU	70 SCU
Cargo Capacity-	3250 mt	125,500 mt	3500 mt
Landing Capability-	None	None	None

### Equipment Data:

Control Computer Type-	ZD-5	ZD-6	ZD-6
Transporters-			
standard 6-person	2	2	2
emergency 18-person	2	2	2
cargo	1	1	1
Cloaking Decive Type-	None	None	KCC
Power Requirement-	-	-	32

### Other Data:

Crew-	265	265	280
Passengers-	20	20	20
Shuttlecraft-	12	12	12

### Engines And Power Data:

Total Power Units Available-	38	42	42
Movement Point Ratio-	4/1	3/1	3/1
Warp Engine Type-	KWD-1	KWE-3	KWE-3
Number-	2	2	2
Power Units Available-	18	20	20
Stress Charts-	L/N	J/M	J/M
Maximum Safe Cruising Speed-	Warp 6	Warp 8	Warp 8
Emergency Speed-	Warp 8	Warp 9	Warp 9
Impulse Engine Type-	KIB-2	KIB-2	KIB-2
Power Units Available-	2	2	2

### Weapons and Firing Data:

Beam Weapon Type-	KD-5	KD-5	KD-5
Number-	2	6	6
Firing Arcs-	1 f/p, 1 f/s	2 f/p, 2f, 2 f/s	2f/p, 2f, 2 f/s
Firing Chart-	P	P	P
Maximum Power-	4	4	4
Damage Modifiers-			
+2	(1-10)	(1-10)	(1-10)
+1	(11-18)	(11-18)	(11-18)
Beam Weapon Type-	KD-14	KD-14	KD-14
Number-	1	1	1
Firing Arcs-	A	A	A
Firing Chart-	D	D	D
Maximum Power-	8	8	8
Damage Modifiers-			
+2	(1-6)	(1-6)	(1-6)
Missile Weapon Type-	-	-	KP-5
Number-	-	-	1
Firing Arcs-	-	-	A
Firing Chart-	-	-	Q
Power to Arm-	-	-	1
Damage-	-	-	10

### Shields Data:

Deflector Shield Type-	KSE	KSE	KSE
Shield Point Ratio-	1/1	1/1	1/2
Maximum Shield Power-	10	8	8

### Combat Efficiency:

D/WDF-	47.5/8.3	54.0/20.7	71.0/26.2
--------	----------	-----------	-----------

### Game Notes:

Two blue-marked Model B D-18 destroyers accompany Captain sutai-Kargon's frigate in action. If the L-42 does not appear, neither do these ships.

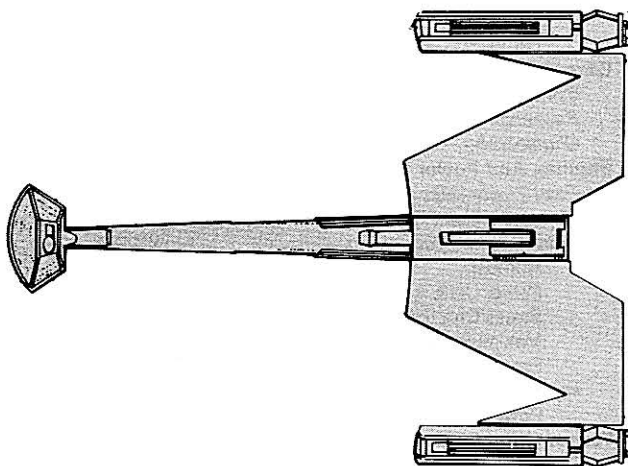

## D-10 (RISKADH) CLASS VII-X CRUISER

### Construction Data:

Model Number-	G
Ship Class-	X
Date Entering Service-	2/1601
Number Constructed-	84

### Hull Data:

Superstructure Points-	28
Damage Chart-	C
Size	
Length-	264 m
Width-	157 m
Height-	30 m
Weight-	151,510 mt

### Cargo

Cargo Units-	320 SCU
Cargo Capacity-	16,000 mt
Landing Capability-	None

### Equipment Data:

Control Computer Type-	ZD-7
Transporters-	
standard 6-person	4
emergency 18-person	4
cargo	2

### Other Data:

Crew-	525
Passengers-	20
Shuttlecraft-	12

### Engines And Power Data:

Total Power Units Available-	46
Movement Point Ratio-	4/1
Warp Engine Type-	KWE-3
Number-	2
Power Units Available-	20
Stress Charts-	J/M
Maximum Safe Cruising Speed-	Warp 7
Emergency Speed-	Warp 8
Impulse Engine Type-	KIE-1
Power Units Available-	6

### Weapons and Firing Data:

Beam Weapon Type-	KD-13
Number-	8
Firing Arcs-	2 f/p, 2 f, 2 f/s, 2a
Firing Chart-	X
Maximum Power-	5

Damage Modifiers-	
+3	(1-7)
+2	(8-15)
+1	(16-22)

Beam Weapon Type-	KD-5
Number-	2
Firing Arcs-	A
Firing Charts-	P
Maximum Power-	4
Damage Modifiers-	
+2	(1-10)
+1	(11-18)

Missile Weapon Type-	KP-4
Number-	2
Firing Arcs-	1 f, 1 a
Firing Chart-	Q
Power to Arm-	2
Damage-	18

### Shields Data:

Deflector Shield Type-	KSL
Shield Point Ratio-	1/3
Maximum Shield Power-	14

### Combat Efficiency:

DAWDE-	107.5/61.6
--------	------------

### Game Notes:

Flagship of the famous Admiral Koloth zantai-Rahanz, this ship is the command vessel for the squadron at Marram IX. It will only enter a pursuit under the conditions outlined in the adventure narrative. Data on the numerous other models of this type is not provided here, due to lack of space.

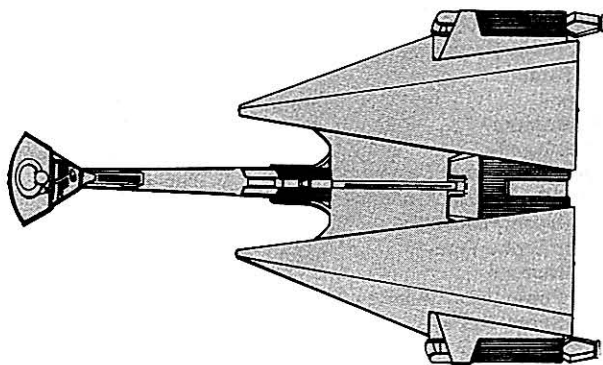

# MAPS

Two maps crucial to the adventure are included in this booklet. The short descriptions that follow provide keys to locations shown on these maps.

## KLINGON BASE HEADQUARTERS

This building is a prefabricated structure common to many Klingon outposts. It contains a complete array of administrative facilities, offices, storage areas, and security sections. It is most frequently encountered as one building among many at a frontier outpost such as Marram IX. Individual rooms are briefly described below.

### Entry Hall (1)

A reception room where visitors are scrutinized prior to being admitted to the headquarters.

### Security Station (2)

A continually-manned checkpoint staffed by guards who monitor the entry hall and lower-floor offices.

### Waiting Room (3)

Visitors wait here for clearance to visit other parts of the building.

### Ready Room (4)

A squad of seven Klingons stand guard here to handle internal security problems.

### Conference Room (5)

A meeting hall for routine, low-priority conferences.

### Administrative Offices (6)

An open area with a number of desks, each manned by base administrative personnel.

### Semi-Private Offices (7)

This large room is subdivided into a number of smaller cubicles where low-level management staffers work.

### Computer Room (8)

This room contains several terminals and a large holographic image display tank.

### Base Supply Office (9)

The chief supply officer works here, along with two assistants.

### Building Stores (10)

A storage area for key building spares and parts. Though not complete, there is sufficient equipment stored here to keep essential power, computer, and communications systems in operation in the absence of other sources of spares.

### Base Maintenance Office (11)

The chief maintenance officer works here, along with three assistants.

### Maintenance Storeroom (12)

A small storage area for equipment essential to the repair of essential services. There is considerable duplication between this stock and that in Room 10.

### Service Area (13)

This room contains monitor panels and access hatches leading to the underground power, sewage, and life support systems for the HQ building, which are generally independent of other base facilities.

### Security Station (14)

A security checkpoint manned constantly to monitor access to the upper levels and to the Service Area.

### Armory (15)

A small storage area for security weaponry.

### Stairs (16)

### Security Station (17)

A security checkpoint manned continuously to monitor access to and from the stairs.

### Armory (18)

A small storage area for security weaponry.

### Ready Room (19)

A squad of seven Klingons guards this area.

### Holding Cells (20)

These are cells used to hold prisoners of special interest to Base Security.

### Reception Area (21)

The Base Security Officer's administrative assistant works here.

### Security Office (22)

The Base Security Officer works here.

### Interrogation Room (23)

This small room includes a variety of devices for questioning or outright torture.

### Computer Room (24)

This room contains the Security Officer's computer and communications equipment.

### Security Station (25)

This is a security checkpoint, constantly manned, from which access to and from the stairs is monitored.



### **Administrative Office (26)**

An office sometimes assigned to supernumeraries at a base, it is often used instead for storage.

### **Ready Room (27)**

A squad of seven of the Base Commander's personal bodyguards are housed here.

### **Transporter Room (28)**

Only persons authorized by the Base Commander can use this facility. The commander's personal transporteeer is the only individual with entry codes to operate the unit.

### **Conference Room (29)**

This room is used for meetings between base senior officers.

### **Computer Room (30)**

The master computer room for the HQ complex is housed here.

### **Communications Room (31)**

Subspace and NST radio equipment is maintained here. A technician is always on duty to record incoming messages.

### **Reception Room (32)**

The Base Commander's administrative assistant works here.

### **Base Commander's Office (33)**

## **KLINGON WORK CAMP**

This map shows the overall layout of the camp where the Dixie survivors are confined. Individual buildings are described below.

### **Main Gate (1)**

There are four sentries posted at each of the two gate areas, two inside and two outside the gates. Shifts change every six hours.

### **Towers (2)**

Each guard tower is 30 feet tall, manned by six Klingons with personal disruptor rifles. They mount an impressive array of searchlights (normal light, UV, IR), plus a heavy disruptor cannon. Shifts change every six hours, but tower and gate shifts changes do NOT coincide.

### **Perimeter Fence (3)**

This fence is only ten feet tall, and consists of two parallel fences of simple chain links, separated by five feet of open ground. Between them is a force field that operates on an intermittent (once per three seconds) basis. Anything present in the area of the field when it pulses on is disintegrated. The field does form a dome around and over the camp, but the pulse effect makes it possible to use transporters (and weapons) through the field. The gates are not covered by the pulse effect, but rather by a more conventional detention force field. The fence serves to keep people from accidentally entering the danger area.

### **Parade Grounds (4)**

Musters and exercises for both guards and prisoners are held here.

### **Prison Barracks (5)**

At the Marram IX work camp, only those marked with an (O) are occupied. Others are being used as storage areas. Each barracks building houses up to 15 people.

### **Guard Barracks (6)**

Each guard barracks building houses one platoon of Klingon combat troops.

### **Prisoner Recreation Hall (7)**

Prisoners have communal mess and recreation facilities here.

### **Guard Recreation Hall (8)**

Soldiers have communal mess and recreation facilities here.

### **Camp Services Building (9)**

This building contains a generator, plus all other essential camp service facilities. It is heavily guarded (two squads on six-hour shifts) at all times, as it houses the force field mechanisms.

### **Vehicular Services Building (10)**

Ground vehicles and shuttlecrafts are stored and serviced in this building, which is guarded by two full squads on six-hour shifts.

### **Open Tarmac (11)**

This is a shuttle landing pad and vehicle parking lot.

### **Administration Building (12)**

This building is a variant on the main HQ building.

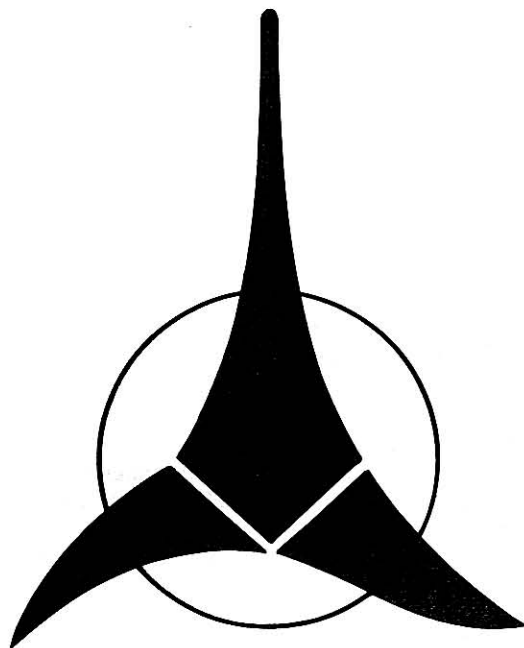

# KLINGON BASE HEADQUARTERS BUILDING

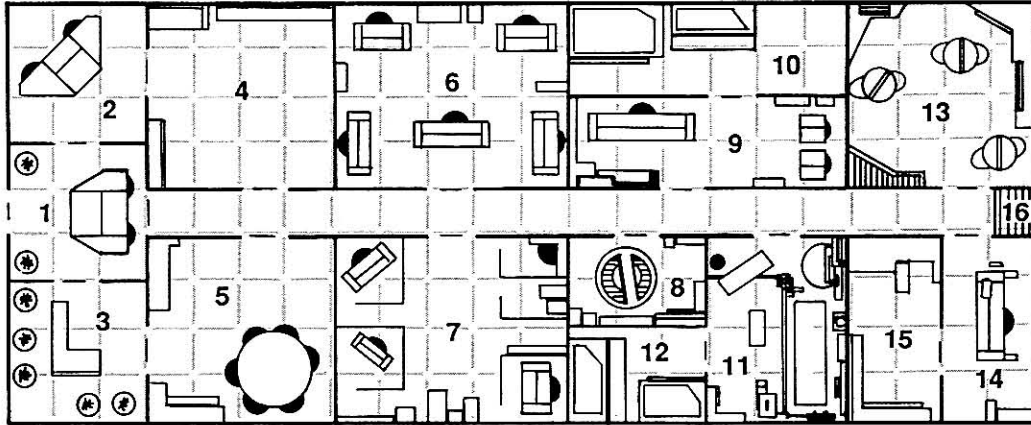

HEADQUARTERS BUILDING, LOWER FLOOR

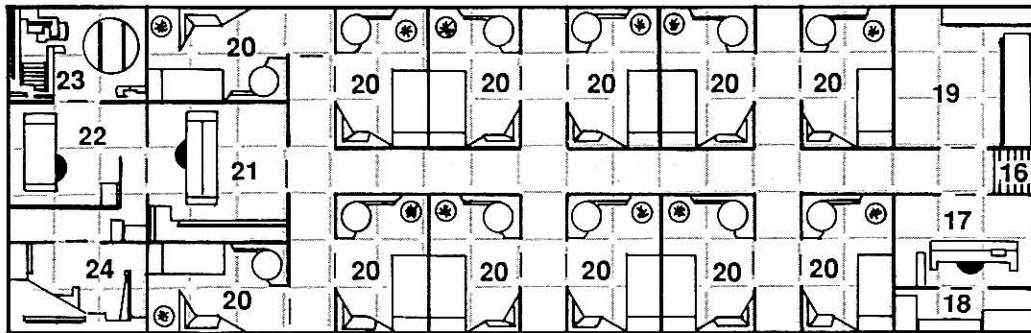

HEADQUARTERS BUILDING, MIDDLE FLOOR

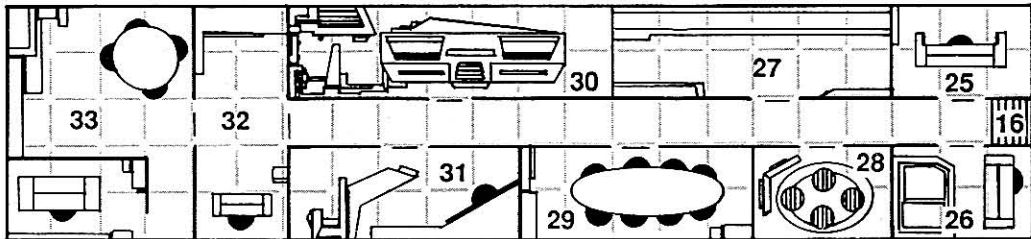

HEADQUARTERS BUILDING, UPPER FLOOR

1 SQUARE = 1.5 METERS



# KLINGON WORK CAMP

1 SQUARE = 6 METERS

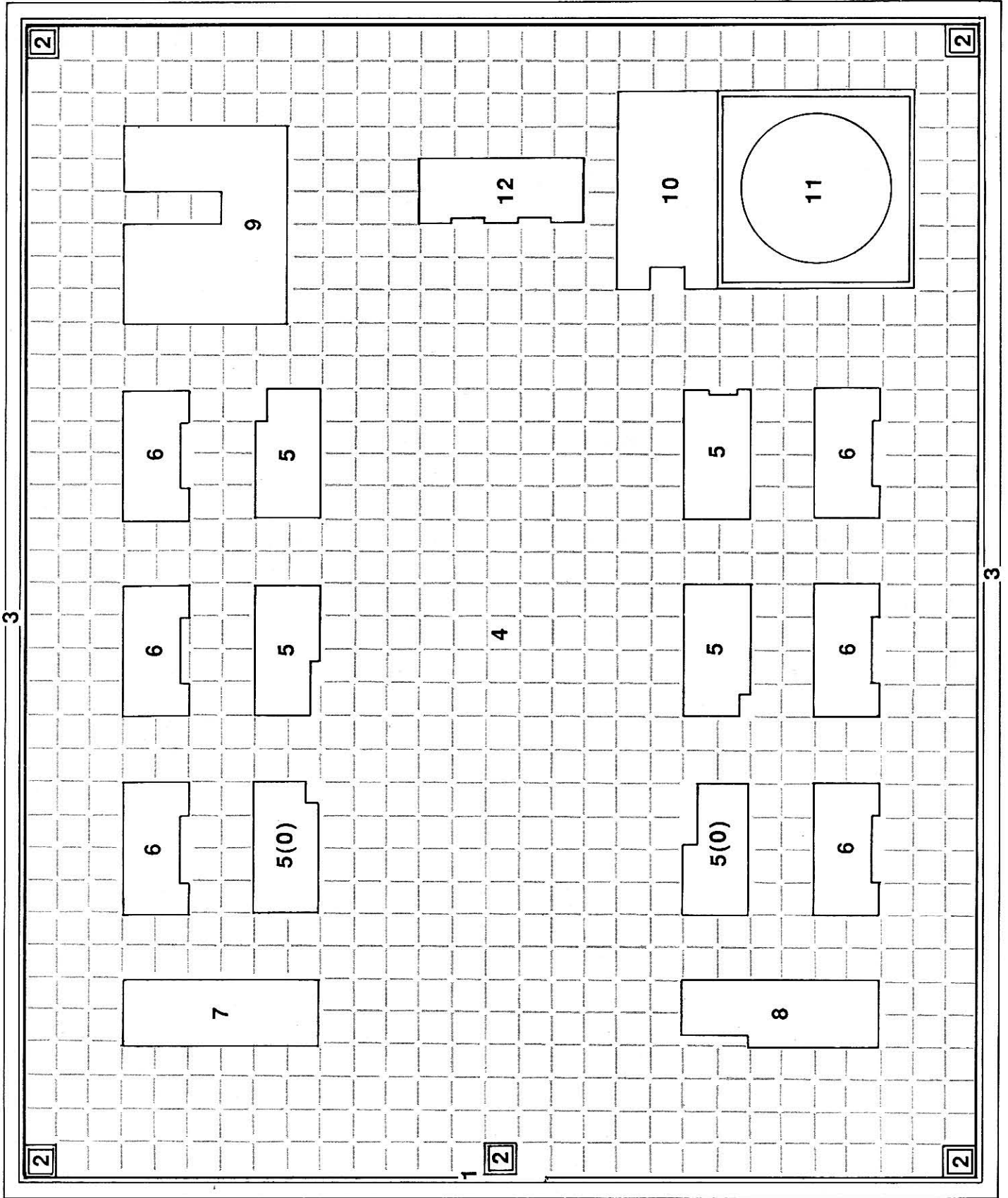

# CAST OF CHARACTERS

All the important characters who figure into *The Dixie Gambit*, including both pre-generated player characters and NPCs, are described in this chapter.

## PRE-GENERATED PLAYER CHARACTERS

Players may wish to introduce characters of their own, either Klingon refugees, temporarily-transferred shipboard officers attached to the Star Fleet Intelligence Command, or characters created out of FASA's upcoming supplements dealing with Star Fleet Intelligence.

In this adventure, however, the *best* characters are those drawn from a very special background: intelligence agents, with a healthy percentage of Klingon refugees in Star Fleet service among their ranks. The pre-generated characters that follow are intended for possible use by players who are role-playing an intelligence-oriented adventure for the first time or when the gamemaster wishes to get play started very quickly. The group presented here includes a balance of character types, ranging from the warpshuttle crew to regular operatives and combat specialists, who together can build an effective all-around team.

Small role-playing groups should have more than one character assigned to each player (two characters is ideal, given the split between shipboard and operations types). Alternatively, or to handle uneven numbers, the gamemaster may run some of these as NPC team members whose talents are necessary for the group's success but whose other input is minimal. Lieutenant Commander Jorgenssen and Lieutenant Commander vestai Jomrak should *never* be NPCs, as they are senior officers and will be frequently called upon to make decisions.



**Name:** JORGENSEN, Gustav A.  
**Rank/Title:** Lieutenant Commander  
**Current Assignment:** Star Fleet Intelligence Command  
*USS Galahad, NCU 5884*

*Position:* Captain

**Race:** Human  
**Age:** 33  
**Sex:** Male

**Attributes:**

STR - 63	CHA - 76
END - 65	LUC - 62
INT - 81	PSI - 19
DEX - 65	

**Combat Statistics:**

To-Hit Numbers:	Bare-Hand Damage: 1D10+6
<i>Modern:</i> 53	AP: 10
<i>HTH:</i> 52	

Significant Skills	Rating
Computer Operation	35
Language	
Galacta	60
Klingonaase	15
Leadership	64
Markmanship, Modern Weapons	41
Personal Combat, Unarmed	39
Shuttlecraft Pilot	38
Space Sciences, Astrogation	31
Starship Combat Strategy/Tactics	68
Starship Helm Operation	58
Starship Sensors	32
Starship Weaponry Operation	43
Warp Drive Technology	15

### Distinguishing Physical Characteristics:

Tall and blond, young Jorgenssen stands 6.4 meters and weighs 85 kilos. While under cover, he wears a mesh-like tunic of Orion manufacture over grey trousers and an open-necked, blue-grey shirt. He is fastidious about his personal appearance.

### Brief Personal History:

*Birthplace:* Stockholm, Scandanavian Union, Earth  
 Jorgenssen was only recently assigned to the SFIC, having previously served as Helmsman of a *Gagarin* Class survey ship. This is his first command, and not much of a captaincy at that. As he puts it, he is "more of a bus driver than a starship officer."

### Personality:

#### *Motivations/Desires/Goals:*

Jorgenssen is unhappy in his present assignment. He has little liking for "the spy business," preferring the scientific and exploratory aspects of Star Fleet. More a planner than a man of action, he tends to be cautious, conscientious, and methodical. This makes him an uninspiring but fairly effective leader.

#### *Manner:*

Gustav Jorgenssen is a man of few words. He rarely reveals what he is thinking, although he often initiates conferences to determine a good course of action. By and large, he remains silent during these sessions and soaks up the opinions of his comrades. Preferring not to commit himself until he absolutely has to, the Captain does not make friends easily.

### Special Knowledge/Powers:

None.

**Name:** SORVAK

**Rank/Title:** Lieutenant

**Current Assignment:** Star Fleet Intelligence Command  
*USS Galahad* NCU-5884

*Position:* First Officer/Navigator

**Race:** Vulcan

**Age:** 40

**Sex:** Male

**Attributes:**

STR - 90	CHA - 68
END - 75	LUC - 35
INT - 95	PSI - 98
DEX - 72	

**Combat Statistics:**

To-Hit Numbers:	Bare-Hand Damage: 2D10+4
Modern: 50	AP: 11
HTH: 59	

**Significant Skills**

	Rating
Deflector Shield Operation	64
Deflector Shield Technology	28
Electronics Technology	31
Environmental Suit Operation	25
Language	
Galacta	60
Klingonaase	38
Vulcan	60
Leadership	31
Marksmanship, Modern Weapons	28
Negotiation/Diplomacy	58
Personal Combat, Unarmed	46
Space Sciences	
Astrogation	85
Astronomy	38
Astrophysics	42
Starship Helm Operation	39
Starship Sensors	46

**Distinguishing Physical Characteristics:**

Sorvak is tall and strong. Although he dresses in civilian clothes, his stiff bearing so typical of a Vulcan Star Fleet officer makes him appear to be dressed in full uniform.

**Brief Personal History:**

*Birthplace:* Shi'nav Province, Vulcan

Sorvak's father was a Vulcan trading magnate whose ships plied the Triangle region. Young Sorvak shipped out as an apprentice navigator on one of these for five years before he finally realized a trader's life was not for him. His deep-space experience won him a late appointment to the Academy, however, and he became a Star Fleet officer. After Sorvak had explained the logic behind his decision, his father fully approved this move.

Sorvak served for several years aboard combat starships patrolling the periphery of the Triangle, and has only recently been reassigned to the Star Fleet Intelligence Command. Though he still has trouble relaxing his rigid service formality, his intimate knowledge of the Triangle and past mercantile experience have made him an invaluable asset to the *Galahad's* crew.

**Personality:**

*Motivations/Desires/Goals:*

Withdrawn, introspective, and solitary, Sorvak has shared his inner drives with no one. He is, in fact, secretly ashamed of his father's business ever since he discovered that it included non-Vulcan employees exploiting races and evading Federation trading regulations. He entered Star Fleet as a gesture against these practices (while his father did some thorough housecleaning), and has found similar mercantile criminals distasteful to deal with ever since. Sorvak welcomed the assignment to the SFIC because it gave him a chance to be at the forefront of investigations into groups like Richmond Enterprises.

*Manner:*

Typically Vulcan in his rigid emotional control, Sorvak and his shipmates get along well enough despite his aloofness. Sorvak respects the abilities of the others, and has demonstrated his loyalty and attachment to them by actions (rather than emotional displays).

**Special Knowledge/Powers:**

Lieutenant Sorvak is an exceptionally gifted student of Vulcan psionic methods. Prior to joining Star Fleet, he studied for a time the *Kolinahr* discipline.

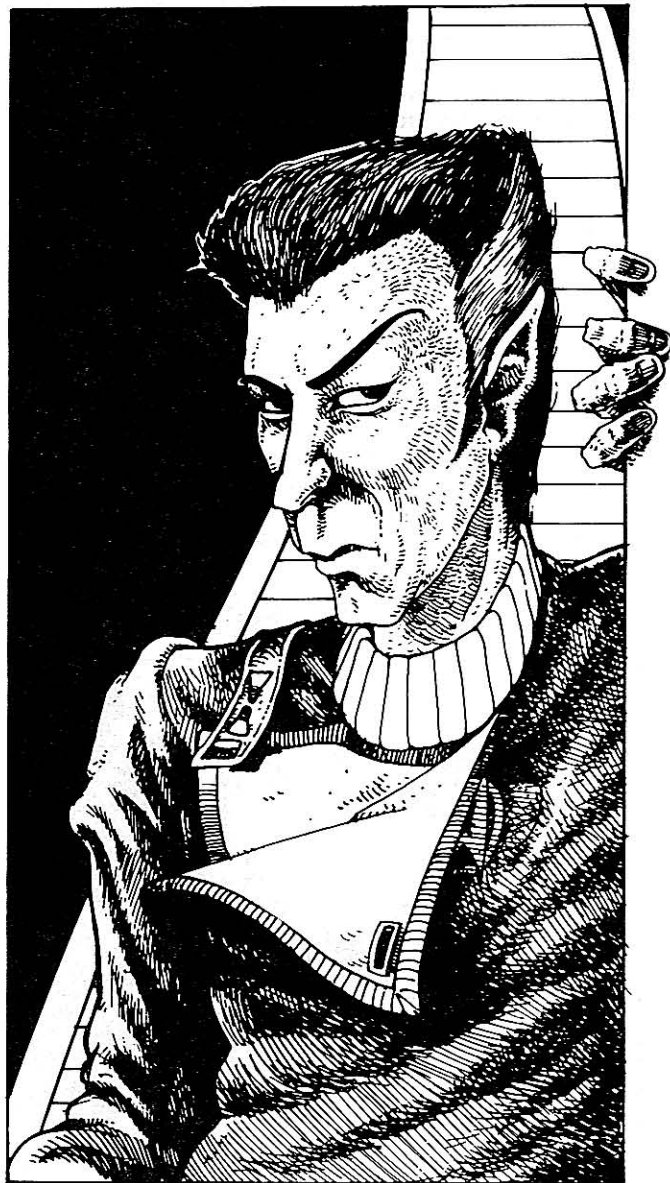

**Name:** ALBEYSHA, Rujnar

**Rank/Title:** Lieutenant

**Current Assignment:** Star Fleet Intelligence Command  
USS Galahad NCU-5882

**Position:** Pilot

**Race:** Human/Orion

**Age:** 30

**Sex:** Male

**Attributes:**

STR -76	CHA -64
END -62	LUC -59
INT -78	PSI -56
DEX -83	

**Combat Statistics:**

To-Hit Numbers: Bare-Hand Damage: 2D10+5

Modern: 69

AP: 12

Knife: 67

HTH: 68

**Significant Skills**

	Rating
Computer Operation	38
Language	
Galacta	60
Klingonaase	59
Orion	60
Leadership	43
Marksmanship, Modern Weapons	54
Negotiation/Diplomacy	62
Personal Combat, Knife	50
Personal Combat, Unarmed	53
Space Sciences, Astrogation	35
Starship Combat Strategy/Tactics	45
Starship Helm Operation	75
Starship Sensors	26
Starship Weaponry Operation	64
Starship Weaponry Technology	30
Streetwise	84
Warp Drive Technology	21

**Distinguishing Physical Characteristics:**

Taking after the Orion side of his family, Albeyssha is tall, stocky, and black-haired. He is a muscular man, almost catlike in his movements, a surprising and useful combination. Albeyssha wears shabby Orion clothes with a sloppy flair, and has a knack for dominating a room of people or a conversation.

**Brief Personal History:**

**Birthplace:** Freeloader (Olen X), OFMA, The Triangle

Born of an Orion father and a Human mother (Albeyssha maintains that his father was a pirate and his mother a wealthy victim who fell in love with her captor, but this is not true), Rujnar began life as an Orion and counts himself of that race. For several years, he served in a small ship that alternated between trading and privateering in the Triangle. When the ship's captain made a deal with a local Klingon governor, however, Albeyssha disapproved and sold out to the Federation, an act of betrayal that averted a major revolution in the cluster of Orion-settled worlds just inside the UFP frontier.

Albeyssha then had the affrontery to bargain with Star Fleet for more permanent employment. The sheer gall of his approach, combined with his knowledge of the Triangle, led to a special commission from SFIC. Albeyssha has been serving as an Intelligence operative ever since, under a variety of cover identities.

**Personality:**

**Motivations/Desires/Goals:**

Albeyssha will never admit to it, but deep down, he is something of a Federation patriot. Although as independent as any other Orion rogue, he has seen enough of the Klingons and the Romulans to know that the real future of his people lies toward the Federation, despite their restrictive laws and regulations.

Albeyssha never shows this aspect of his personality, however. He prefers to flaunt only his unprincipled, mercenary side. Thought perpetually seeking the most rewarding angle or the best deal he can for himself, he would never sell out his shipmates.

**Manner:**

Rujnar Albeyssha is a flamboyant and colorful rogue who should never have become a Star Fleet officer. Brash and self-confident, he is always full of ideas or plans, is loud and garrulous, and is never at a loss for words in even the stickiest or trickiest of circumstances.

**Special Knowledge/Powers:**

None.

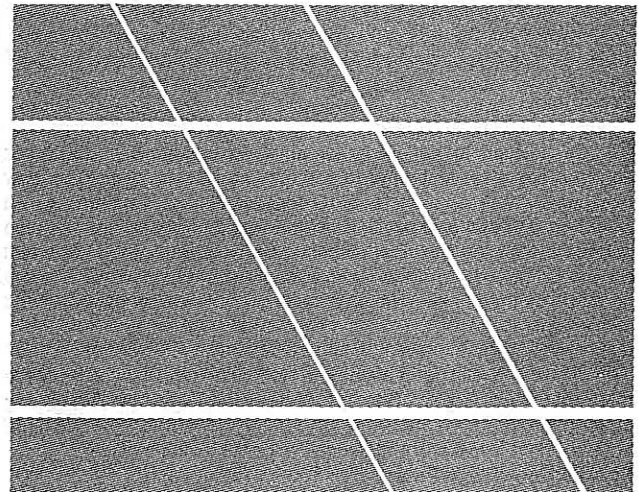

**Name:** JOHNSON, Helen  
**Rank/Title:** Lieutenant  
**Current Assignment:** Star Fleet Intelligence Command  
USS Galahad NCU-5882  
**Position:** Chief Engineer

**Race:** Human  
**Age:** 31  
**Sex:** Female

**Attributes:**

STR - 55      CHA - 81  
END - 57      LUC - 92  
INT - 79      PSI - 05  
DEX - 80

**Combat Statistics:**

To-Hit Numbers:      Bare-Hand Damage: 1D10+6  
*Modern:* 58                      AP: 12  
*HTH:* 55

Significant Skills	Rating
Communications Systems Technology	28
Computer Operation	32
Computer Technology	25
Electronics Technology	43
Environmental Suit Operation	33
Life Support Systems Technology	58
Marksmanship, Modern Weapons	36
Mechanical Engineering	50
Personal Combat, Unarmed	31
Space Sciences, Astronautics	71
Warp Drive Technology	60
Zero-G Operations	23

**Distinguishing Physical Characteristics:**

Lieutenant Helen Johnson is a tall, attractive redhead. She is usually seen wearing grease-stained coveralls, her long hair concealed under a battered technician's cap. When she chooses to dress up, the transformation is astonishing.

**Brief Personal History:**

*Birthplace:* San Francisco, USA, Earth

Helen Johnson always loved machinery, and was an accomplished amateur mechanic and technician before she entered the Academy. Since that time, she has pursued her vocation zealously, serving at a wide variety of duty stations in a comparatively short period of time. She volunteered for transfer to SFIC (among other things), and has been aboard the *Galahad* for six months.

**Personality:**

*Motivations/Desires/Goals:*

In addition to her liking for anything mechanical, Lieutenant Johnson has a restless urge to see new horizons and conquer new challenges. She applied to SFIC largely because she thought it would be different and exciting. At the time of application, she also made a bid for the Star Fleet Rescue Service (part of the Merchant Marine Command) and the Galaxy Exploration Command's Pioneer Unit, all of them high-risk units with a promise of glamour and excitement.

*Manner:*

Though she is good at her job, Helen Johnson likes to be at the forefront of the action. She grows impatient and irritable during prolonged periods of inactivity. Cheerfully indifferent to all forms of trouble, she is brave and enthusiastic once the action begins.

**Special Knowledge/Powers:**

None.

**Name:** DROMAL, Larns  
**Rank/Title:** Ensign  
**Current Assignment:** Star Fleet Intelligence Command  
USS Galahad NCU-5882  
**Position:** Engineer

**Race:** Klingon/Human Fusion  
**Age:** 26  
**Sex:** Male

**Attributes:**

STR - 74      CHA - 45  
END - 73      LUC - 28  
INT - 78      PSI - 01  
DEX - 65

**Combat Statistics:**

To-Hit Numbers:      Bare-Hand Damage: 1D10+6  
*Modern:* 55                      AP: 10  
*HTH:* 52

Significant Skills	Rating
Damage Control Procedures	23
Deflector Shield Technology	42
Electronics Technology	32
Language	
Galacta	38
Klingonaase	60
Marksmanship, Modern Weapons	45
Mechanical Technology	38
Personal Combat, Unarmed	39
Shuttlecraft Systems Technology	27
Starship Weaponry Technology	45
Transporter Operation Procedures	74
Transporter Systems Technology	53

**Distinguishing Physical Characteristics:**

Ensign Dromal is short and heavy-set. Though he runs more to fat than to muscle, he is not as weak as his soft appearance might suggest. Dromal's complexion is swarthy, and his facial features are strongly Klingon.

**Brief Personal History:**

*Birthplace:* Star Base 10

Dromal's parents fled the Empire during the aftermath of an unsuccessful coup by a leader to whom they were closely connected. His father supplied information on Klingon shipbuilding techniques to the SFIC. Before being commissioned and attached to Intelligence, Larns was one of the handful of Klingons ever to attend the Star Fleet Academy.

**Personality:**

*Motivations/Desires/Goals:*

Larns Dromal is divided against himself. Intensely proud of the fact that he is one of the few "outsiders" permitted to attend the Academy, he also has a strong interest in his Klingon heritage. This manifests as his refusal to adopt a name in keeping with his profession, and by his deliberate adoption of Klingon mannerisms, turns of phrase, and modes of speech.

Dromal wants very much to be accepted by the Federation without giving up his own identity as a Klingon, and this leads to a considerable degree of conflict in his decisions and actions.

*Manner:*

Although a Klingon by birth, Dromal was born in the Federation and raised with some (but not all) of the usual Klingon attitudes considerably altered or repressed. His pride of heritage is an artificial one, equivalent to a Human who identifies with an ethnic group without really knowing much about it except through books or garbled family traditions. At the core, Dromal is a citizen of the Federation and a Star Fleet officer. Though he may have trouble admitting it to himself, he will generally make his decisions as a Human would, rather than as a Klingon should.

**Special Knowledge/Powers:**

Dromal's parents were friends of the *Dixie Lady's* Chief Engineer Koth, and the Ensign cannot and will not accept the notion that Koth could have been the Dixie traitor.

**Name:** KERAX, vestai Jomrak  
**Rank/Title:** Lieutenant Commander  
**Current Assignment:** Star Fleet Intelligence Command  
USS Galahad NCU-5882  
*Position:* Intelligence Officer

**Race:** Klingon/Human Fusion  
**Age:** 31  
**Sex:** Male

**Attributes:**

STR - 71	CHA - 48
END - 65	LUC - 54
INT - 84	PSI - 23
DEX - 70	

**Combat Statistics:**

To-Hit Numbers: Bare-Hand Damage: 1D10+10  
*Modern:* 62 AP: 11  
*HTH:* 71

Significant Skills	Rating
Administration	31
Clandestine Operations	65
Communications System Operation	43
Computer Operation	45
Damage Control Procedures	28
Interrogation	47
Language	
Galacta	25
Klingonaase	60
Romulan	31
Leadership	62
Marksanship, Modern Weapons	54
Personal Combat, Unarmed	71
Security Procedures	68
Social Sciences	
Klingon Culture/History	35
Klingon Law	32
Streetwise	29
Surveillance	48

**Distinguishing Physical Characteristics:**

Lieutenant Commander vestai-Jomrak is tall and of imposing build. When in civilian dress, he can pass for Human (barring the fairly distinctive styling of beard and mustache, which gives him a Klingon look).

**Brief Personal History:**

*Birthplace:* Klinzhai, Klingon Empire

Kerax was a rising star in the Klingon Empire's Intelligence Service until the Imperial Klingons attempted to purge the Service of all fusions. During this conflict, vestai-Jomrak killed a relative of the Emperor (in self-defense, or so he maintains) and was forced to flee. With nowhere else to turn, he came to the Federation, where he sought employment with Star Fleet because he really was not suited to any civilian job. Kerax was given a field commission for his help in breaking up a Klingon spy ring, and now serves as the Chief Intelligence Officer (and communications specialist) aboard the *Galahad*.

**Personality:**

*Motivations/Desires/Goals:*

Although he is no longer part of the Empire, vestai-Jomrak is still Klingon. His drives are for power and prestige. So far, he has sublimated these by trying to be the best possible Star Fleet officer in hopes of winning advancement, but his methods (when he can get away with them) are uncomfortably Klingon in nature. Also, changes in the wind in the Empire have suggested to him that a return might not be out of the question. Kerax has been considering (but so far rejecting) the idea of betraying the Federation and returning home.

*Manner:*

Kerax is a fairly typical Klingon, devious, aggressive, and cagey. Always eager to take direct action, he is impatient with Jorgenssen's plodding ways. Kerax is very good at saying a lot without giving away anything.

**Special Knowledge/Powers:**

None.





**Name:** ALMUR, tai-Sahran

**Rank/Title:** Lieutenant

**Current Assignment:** Star Fleet Intelligence Command  
*USS Galahad NCU-5882*

**Position:** Assistant Intelligence Officer

**Race:** Klingon/Human Fusion

**Age:** 29

**Sex:** Female

**Attributes:**

STR - 68	CHA - 22
END - 61	LUC - 39
INT - 86	PSI - 08
DEX - 76	

**Combat Statistics:**

To-Hit Numbers:	Bare-Hand Damage: 1D10+8
Modern: 60	AP: 10
HTH: 64	

Significant Skills	Rating
Administration	25
Bribery	52
Carousing	35
Clandestine Operations	58
Computer Operation	64
Computer Technology	39
Instruction	41
Interrogation	39
Language	
Galacta	40
Klingonaase	60
Leadership	29
Marksmanship, Modern Weapons	44
Personal Combat, Unarmed	51
Planetary Survival, Warm Temperate	36
Security Procedures	56
Small Equipment Systems Operation	32
Starship Sensors	72
Streetwise	61
Surveillance	53

**Distinguishing Physical Characteristics:**

Almur tai-Sahran is a sturdy, somewhat stocky Klingon/Human Fusion female who is not particularly attractive even to her own kind. She is medium height with a heavy build and facial features that give her an almost Neanderthal appearance around the eyes and forehead. Despite her looks, Almur is an intelligent and highly capable officer.

**Brief Personal History:**

**Birthplace:** Gnuu Re, Quadrant Delta

Lieutenant tai-Sahran killed her superior officer in a planetside brawl, then fled the Empire to avoid the vengeance of the officer's family. For a time, she attempted to serve as a free-lance spy in the Orion colonies. After Klingon assassins in the pay of her enemies hunted her down and nearly killed her, she fled to the Federation to sell her knowledge and services to Star Fleet in exchange for protection. Since that time, the SFIC has employed her in a variety of roles in the Triangle and along the Klingon frontier.

**Personality:**

**Motivations/Desires/Goals:**

Almur still fears the vengeance of her Klingon enemies. As it happens, Kresz sutai-Kargon is a member of that family, and Almur will spend much of her time on Marram IX worried about the prospect of being captured and discovered by Kargon.

The Lieutenant has a dislike for men (Human and Klingon alike) that stems from her own lack of beauty and allure. She is fiercely determined to prove herself better than any mere male, a trait that frequently leads her to take action without reference to her companions.

**Manner:**

Lieutenant tai-Sahran has an abrupt, no-nonsense approach to her duties, and little life outside of her work. She is precise, businesslike, and almost Vulcan in her apparent lack of feeling. Lurking beneath this professional demeanor, however, is a temper that would scare a battle-hardened Gorn. If properly provoked, she is quite capable of flying into a deadly rage.

**Special Knowledge/Powers:**

None.



**Name:** AJARD, vestai-Rondal  
**Rank/Title:** Lieutenant  
**Current Assignment:** Star Fleet Intelligence Command  
*USS Galahad* NCU-5882  
**Position:** Medical Officer

**Race:** Klingon/Human Fusion  
**Age:** 36  
**Sex:** Male

**Attributes:**

STR - 74	CHA - 39
END - 63	LUC - 41
INT - 80	PSI - 21
DEX - 84	

**Combat Statistics:**

To-Hit Numbers:	Bare-Hand Damage: 1D10+7
<i>Modern:</i> 63	AP: 12
<i>HTH:</i> 65	

Significant Skills	Rating
Administration	41
Bribery	33
Carousing	30
Clandestine Operations	45
Computer Operation	41
Instruction	38
Language	
Galacta	51
Klingonaase	60
Marksmanship, Modern Weapons	42
Medical Sciences	
General Medicine, Human	41
General Medicine, Klingon	48
Psychology, Human	32
Psychology, Klingon	45
Surgery	43
Negotiation/Diplomacy	39
Personal Combat, Unarmed	45

**Distinguishing Physical Characteristics:**

Ajard's face is severely scarred, the result of a shipboard explosion in his days with the Imperial Navy (which believes in reconstructive surgery for purposes of efficiency, not appearance).

**Brief Personal History:**

*Birthplace:* H'Rez, Quadrant Delta

Lieutenant vestai-Rondal had a short but distinguished career in the Navy before becoming the scapegoat in a superior's unsuccessful bid for power. A loser in the *komerex zha*, the Lieutenant was forced to flee or perish. He chose to join the SFIC as a route toward winning a very personal form of vengeance.

**Personality:**

*Motivations/Desires/Goals:*

Ajard is consumed by a desire to kill the Klingon who forced him into exile: Klinmar sutai-Langtorz, now commandant of the base on Marram IX. Up until now, this has been an impossible dream. Now it could be achieved, but such a goal would almost certainly threaten the success of the group's real mission. How this influences the course of the adventure must be left to the player running Ajard, and to the gamemaster.

*Manner:*

Ajard, like all Klingon medical people, has nothing of the "bedside manner" of his Human counterparts, which makes his ministrations more than a little bit unnerving to the non-Klingon members of *Galahad's* crew. He is blunt-spoken, efficient, and competent in his craft, but at all times follows Klingon, rather than UFP, medical practices. Even in non-duty matters, he maintains the same straightforward style of thought and action. In properly devious Klingon fashion, however, he says very little, though he is usually honest and reliable when he does speak up.

**Special Knowledge/Powers:**

None.



**Name:** IRKHO, Zharad  
**Rank/Title:** Ensign  
**Current Assignment:** Star Fleet Intelligence Command  
*USS Galahad* NCU-5882  
**Position:** Intelligence Operative

**Race:** Klingon/Human Fusion  
**Age:** 19  
**Sex:** Male

**Attributes:**

STR - 80	CHA - 51
END - 65	LUC - 46
INT - 79	PSI - 22
DEX - 62	

**Combat Statistics:**

To-Hit Numbers:	Bare-Hand Damage: 2D10+3
<i>Modern:</i> 53	AP: 10
<i>HTH:</i> 48	

**Significant Skills**

	<b>Rating</b>
Bribery	32
Carousing	38
Clandestine Operations	41
Interrogation	23
Language	
Galacta	60
Klingonaase	48
Orion	21
Leadership	29
Marksmanship, Modern Weapons	44
Personal Combat, Unarmed	33
Security Procedures	46
Shuttlecraft Pilot	24
Small Unit Tactics	31
Streetwise	66
Surveillance	24
Transporter Operational Procedures	32

**Distinguishing Physical Characteristics:**

Zharad is a youthful Klingon/Human Fusion, beardless and looking more Human than many of his kind. He is short and heavy.

**Brief Personal History:**

*Birthplace:* Rigel IX

Son of a Klingon refugee, Zharad grew up in Orion space, and was trained as a security guard aboard an Orion privateer. When the ship was caught by Federation patrol craft, young Irkho turned Federation's evidence against his erstwhile comrades and so got off scot-free. When his Klingon ancestry and background were uncovered, he was given the opportunity to volunteer for intelligence training in Star Fleet (always on the lookout for usable Klingon agents). Zharad has served aboard the *Galahad* for six months, during which time he has made himself thoroughly detestable to all his shipmates.

**Personality:**

*Motivations/Desires/Goals:*

Zharad Irkho combines most of the worst attitudes of his Klingon forefathers and his Orion upbringing. He is so slippery, devious, and self-seeking that the motto "looking out for Number One" could have been written with him in mind. Irkho will do anything to make sure that he personally comes out of a tough situation smelling like a rose, and does not particularly care how anyone else makes out in the interim.

*Manner:*

Zharad Irkho is not well-liked by his shipmates. He is shiftless and lazy, good at spreading the blame for his own oversights or faults, and generally sneaky. Now that they have his measure, the others keep a close watch on him so that he cannot shift responsibility when it counts. They would not tolerate Irkho at all if it were not for his positive genius at ferreting out information of vital importance from the most unlikely places. Because of this talent, his usefulness has so far outweighed his irresponsibility.

**Special Knowledge/Powers:**

On any world regularly visited by Orion traders, Irkho will probably have some worthwhile contacts who can feed him useful information. Both Freeman's Port and Thisisit fall into this category, though Marram IX does not.

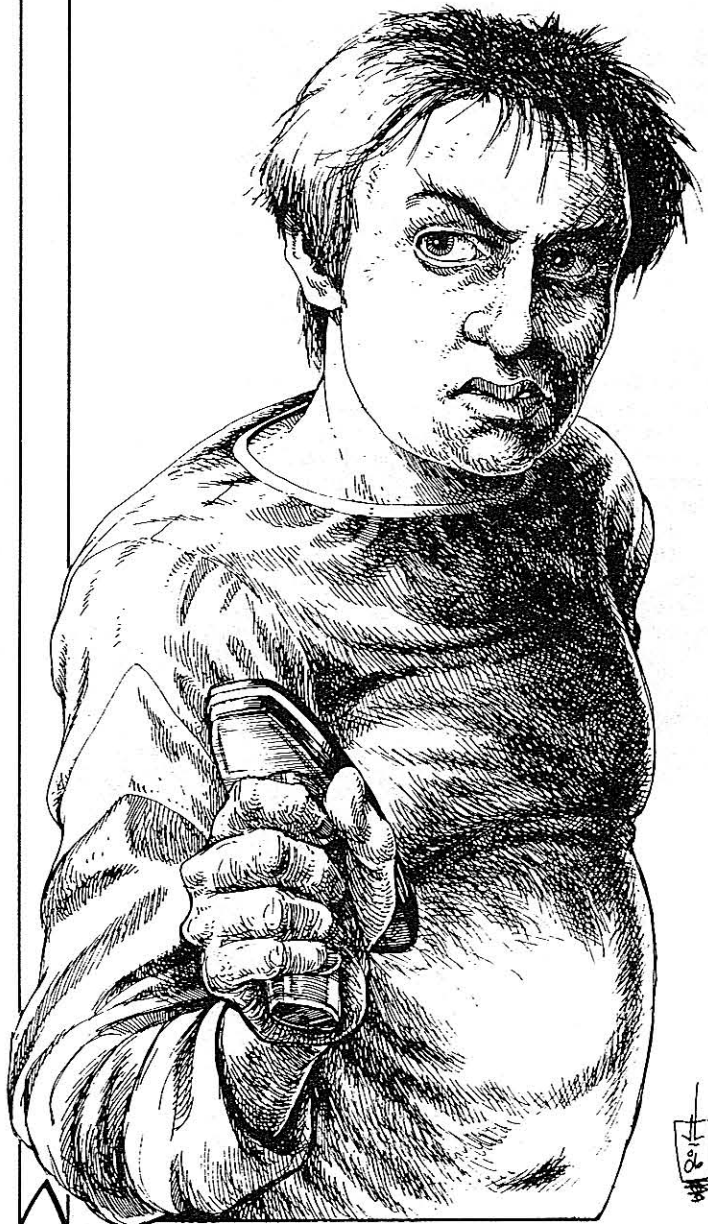

**Name:** MRANN, tai-Larig  
**Rank/Title:** Ensign  
**Current Assignment:** Star Fleet Intelligence Command  
USS Galahad NCU-5882  
**Position:** Intelligence Operative

**Race:** Klingon/Human Fusion  
**Age:** 26  
**Sex:** Male

**Attributes:**

STR - 76	CHA - 41
END - 62	LUC - 28
INT - 75	PSI - 04
DEX - 83	

**Combat Statistics:**

To-Hit Numbers: Bare-Hand Damage: 2D10+5  
Modern: 76 AP: 12  
HTH: 70

Significant Skills	Rating
Carousing	28
Clandestine Operations	41
Environmental Suit Operations	36
Interrogation	25
Language	
Galacta	38
Klingonaase	60
Leadership	51
Marksmanship, Modern Weapons	69
Personal Combat, Unarmed	57
Personal Weapons Technology	24
Planetary Survival, Arctic	39
Small Unit Tactics	64
Streetwise	33
Vehicle Operation, Ground	31
Zero-G Operations	49

**Distinguishing Physical Characteristics:**

A slender, graceful Klingon, Mrann's slim build conceals powerful muscles, which give him quite an edge in combat.

**Brief Personal History:**

*Birthplace:* Veska, Quadrant Delta.

Mrann served in the Imperial Marines until forced to flee the Empire during the aftermath of a particularly violent power struggle. He joined Star Fleet Intelligence largely because his warrior's background left him few other options. He has served in the Triangle for over a year now, though he only recently transferred to the *Galahad*.

**Personality:**

*Motivations/Desires/Goals:*

Mrann is a soldier, pure and simple. He was trained to fight, and so finds it difficult to turn down a chance at combat. His original hope in joining Star Fleet was to become a Marine, but SFIC claimed him first. He strongly dislikes "spy games" and has outraged his Klingon comrades by denying the Perpetual Game itself. Instead, Mrann welcomes a nice, straightforward commando raid or barroom brawl every so often to relieve the boredom.

*Manner:*

The Ensign refuses to participate in anything like the Perpetual Game. For a Klingon, he is amiable, cheerful, and open, both a loyal comrade and a deadly foe.

**Special Knowledge/Powers:**

None.



## NPCS

### STAR FLEET CHARACTERS

Only three of the NPCs encountered in *The Dixie Gambit* are from Star Fleet. These characters are presented below.

**Name:** TREMAINE, Nicholas  
**Rank/Title:** Captain  
**Current Assignment:** Star Fleet Intelligence Command  
 Freeman's Port Station  
**Position:** Agent-in-charge

**Race:** Human  
**Age:** 42  
**Sex:** Male

**Attributes:**

STR - 62	CHA - 76
END - 58	LUC - 44
INT - 74	PSI - 03
DEX - 68	

**Combat Statistics:**

To-Hit Numbers:	Bare-Hand Damage: 1D10+8
Modern: 59	AP: 10
HTH: 49	

**Significant Skills**

	Rating
Administration	72
Bribery	23
Carousing	31
Clandestine Operations	53
Computer Operation	38
Forgery	26
Instruction	15
Language	
Galacta	60
Klingonaase	32
Orion	32
Leadership	41
Marksmanship, Modern Weapons	50
Negotiation/Diplomacy	36
Personal Combat, Unarmed	30
Social Sciences	
Federation Culture/History	30
Federation Law	41
Klingon Culture/History	15
Klingon Law	18
Streetwise	33
Trivia, Background of Operation Dixie	62

**Distinguishing Physical Characteristics:**

Nicholas Tremaine is stocky, of medium height, and with reddish hair. He looks considerably older than his 42 years.

**Brief Personal History:**

*Birthplace:* Republic of Mars

Tremaine has served in a variety of Star Fleet Intelligence posts, primarily those connected with Klingon and Orion Sector Intelligence departments, culminating in his appointment to coordinate Operation Dixie. Since then, his career has been on a downslide.

**Personality:**

*Motivations/Desires/Goals:*

Tremaine blames himself for the failure of Dixie, and particularly for the losses incurred by the Dixie crews. As this adventure opens, Tremaine has realized that his men may be alive after all, and has become obsessed with the idea of finding and rescuing them. To a lesser extent, he also wants to turn Dixie around to vindicate the whole SFIC and salvage his failing career, but Tremaine's main object will always be humanitarian.

*Manner:*

Tremaine is full of contradictions. Once a dynamic, charming leader of men, he has become morose and withdrawn. Now, bursts of great energy alternate with fits of lassitude and deep soul-searching.

**Special Knowledge/Powers:**

Tremaine's skill in "Trivia" is not a true skill as such, but represents his ability to recall and explain specific points regarding Operation Dixie. The gamemaster should remember that Tremaine is only a coordinator and assigner of tasks, and will not leave Freeman's Port. Thus, though he is in a position to give orders, he is too remote to be a direct influence on the player characters while they are in the field.



**Name:** SINCLAIR, Caroline  
**Rank/Title:** Lieutenant Commander  
**Current Assignment:** Project Minuteman  
*Position:* Team Leader (Acting)

**Race:** Human  
**Age:** 33  
**Sex:** Female

**Attributes:**

STR - 62	CHA - 82
END - 72	LUC - 78
INT - 76	PSI - 08
DEX - 70	

**Combat Statistics:**

To-Hit Numbers:	Bare-Hand Damage: 1D10+10
Modern: 76	AP: 11
HTH: 73	

**Significant Skills**

	Rating
Clandestine Operations	72
Communications Systems Operation	24
Environmental Suit Operation	30
Language	
Galacta	60
Klingonaase	42
Romulan	31
Leadership	76
Marksmanship, Modern Weapons	82
Medical Sciences	
General Medicine, Human	26
Psychology, Human	18
Negotiation/Diplomacy	31
Personal Combat, Knife	40
Personal Combat, Unarmed	76
Personal Weapons Technology	16
Planetary Survival, Warm Temperature	32
Security Procedures	60
Small Equipment Systems Operation	20
Small Unit Tactics	68
Streetwise	43
Zero-G Operations	28

**Distinguishing Physical Characteristics:**

The petite Lieutenant Commander Sinclair seems delicate and fragile, and so her actual stamina and strength may surprise those who do not know her. She is slim and attractive, with short blonde hair and blue eyes. Her attractiveness may be disguised now by the months of guerrilla life on Marram IX.

**Brief Personal History:**

*Birthplace:* Naim, Scotland, Earth

Originally a Star Fleet Security Officer, Caroline Sinclair was later transferred to the Klingon sector of Star Fleet Intelligence Command. Since then, she has served in several important missions, and was one of the Project Minuteman commandos dispatched to Marram IX.

**Personality:**

*Motivations/Desires/Goals:*

Caroline Sinclair is a tough, no-nonsense agent, brave to a fault and very competent in everything she does. As Klingon Sector Intelligence has been around longer than Triangle Sector, she tends to feel that there is some work that amateurs should stay out of, and commando missions is one of them. Thus, though she will ultimately cooperate with the player characters, she will not hesitate to voice her disapproval if they fail to do the kind of job she expects from trained raiders.

**Special Knowledge/Powers:**

Caroline Sinclair is intimately familiar with the fringes of the Klingon-controlled territories of Marram IX, and is in complete control of a guerrilla band of 15 resistance fighters (not counting her partner, Lt. Commander O'Mara).



**Name:** O'MARA, Ryan  
**Rank/Title:** Lieutenant Commander  
**Current Assignment:** Star Fleet Intelligence Command,  
 Klingon Sector  
 Project Minuteman  
*Position:* Supernumerary

**Race:** Human  
**Age:** 30  
**Sex:** Male

**Attributes:**

STR - 56	CHA - 81
END - 66	LUC - 59
INT - 82	PSI - 10
DEX - 68	

**Combat Statistics:**

To-Hit Numbers: Bare-Hand Damage: 1D10+5  
*Modern:* 49 AP: 10  
*HTH:* 47

**Significant Skills**

	Rating
Communications Systems Operation	46
Communications Systems Technology	38
Computer Operation	38
Electronics Technology	35
Language	
Galacta	60
Klingonaase	54
Tellarite	28
Vulcan	30
Leadership	24
Marksmanship, Modern Weapons	30
Negotiation/Diplomacy	54
Personal Combat, Unarmed	26
Planetary Survival, Warm Temperate	22
Shuttlecraft Pilot	34
Small Equipment Systems Operation	30
Small Equipment Systems Technology	18
Space Sciences, Astrogation	24
Starship Helm Operation	30

**Distinguishing Physical Characteristics:**

O'Mara is a heavy-set, moon-faced young man with weak eyes, sandy brown hair, and freckles. He is not very tall and quite heavy.

**Brief Personal History:**

*Birthplace:* Dublin, Ireland, Earth.

O'Mara trained in Communications with Star Fleet, with some cross-over into the Helm branch. Actually, he was a second choice for the Project Minuteman operation. The original communications specialist came down with Vegan chloriomeningitis shortly before the start of the project.

**Personality:**

*Motivations/Desires/Goals:*

Ryan O'Mara's main object in life is to look out for Mother O'Mara's only son. He never really wanted to come on this mission. It was supposed to be "volunteers only"; he did not like the alternative to volunteering (assignment to a two-year tour of duty manning a communications station on Hanson's Planet, a ball of rock and ice at the edge of the Klingon Neutral Zone where the average daytime temperature soars to -75° C at midday, and where the total Star Fleet contingent numbers six when a five-man supply ship calls for its biannual visit).

O'Mara, then, is no hero. He is along as a specialist who will not be needed until the very end of the operation, though his role then is crucial. Meanwhile, he keeps his head down as much as possible and volunteers for nothing.

*Manner:*

Ryan O'Mara is almost a comical figure, a nervous man who is not quite a coward, but certainly not a hero. He has very little respect for authority, but learned long since that arguing with Caroline Sinclair is like trying to hold back a tornado. His Irish temperament shows in his disrespectful, barbed comments and his general independence. He has a way of keeping up a running stream of complaints, whines, regrets, and mournful comments that irritate Sinclair by deflating her sometimes pompous intensity.

**Special Knowledge/Powers:**

O'Mara is in charge of implementing Project Phantom, the diversionary action originally designed to help the refugees from Marram IX elude the Klingon fleet. He can perform this same task for the adventurers instead.

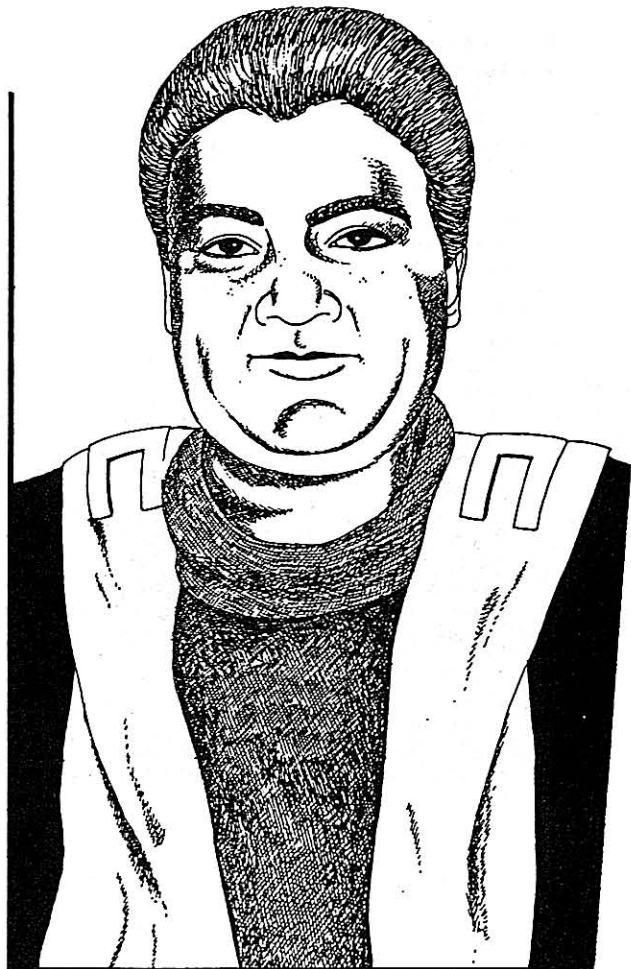

## RICHMOND ENTERPRISES CHARACTERS

Among the five NPCs described below, there are two "typical" characters who may be encountered in the course of dealings with Richmond Enterprises and the *Simone DeLeone* on Thisisit. Typical characters can be modified to fit the needs of specific encounters.

**Name:** RICHMOND, Donald  
**Rank/Title:** President  
**Current Assignment:** Richmond Enterprises  
*Position:* Chief Executive Officer

**Race:** Human  
**Age:** 53  
**Sex:** Male

### Attributes:

STR	- 54	CHA	- 82
END	- 50	LUC	- 94
INT	- 76	PSI	- 02
DEX	- 60		

### Combat Statistics:

To-Hit Numbers: Bare-Hand Damage: 1D10+5  
*Modern:* 73 AP: 10  
*HTH:* 40

Significant Skills	Rating
Administration	82
Bribery	44
Carousing	21
Computer Operation	30
Language	
Galacta	60
Klingonaase	21
Orion	40
Leadership	30
Marksmanship, Modern Weapons	26
Medical Sciences	
Psychology, Human	18
Negotiation/Diplomacy	32
Personal Combat, Unarmed	20
Security Procedures	24
Social Sciences	
Economics	40
Federation Culture/History	26
Federation Law	45
Streetwise	38
Trade and Commerce	46
Value Estimation	63

### Distinguishing Physical Characteristics:

Donald Richmond has greying hair and dark brown eyes. Though slightly overweight and not in the best of health, he is handsome and distinguished-looking. Despite his company's financial problems, Richmond is ostentatious about his wealth, and dresses in the finest clothing.

### Brief Personal History:

*Birthplace:* Thisisit

Born to follow his father, James Richmond, as head of Richmond Enterprises, Donald Richmond took over as Chief Executive Officer of the firm seven years ago, after the semi-retirement of his father. His years at the helm of Richmond Enterprises saw the outbreak of the civil war in the Mantiev Colonial Association, where most of his major markets were located. As a result, the company suffered tremendous setbacks, but Richmond himself has been able to maneuver for position to secure a considerable personal fortune out of the whole affair.

### Personality:

#### *Motivations/Desires/Goals:*

Donald Richmond is greedy, not only for money but for power and influence. Because he feels that rebuilding the company would be a long, slow process, Richmond is seeking a method far more direct than a slow, legal retrenchment. Instead of trying to rebuild the company, he is allowing it to collapse while he milks every credit he can from the situation. His ultimate goal is to start a new firm more completely under his control.

#### *Manner:*

Donald Richmond is a smooth and devious operator. He cannot be trusted, except to work for his own interests. However, he is charming, suave, full of bonhomie and always willing to listen to—or propose—"a deal you just wouldn't believe." Casual and completely heartless in his treachery, Richmond would cheerfully sell his own grandmother to the Klingons if he thought he could get a good enough price.

#### **Special Knowledge/Powers:**

None.

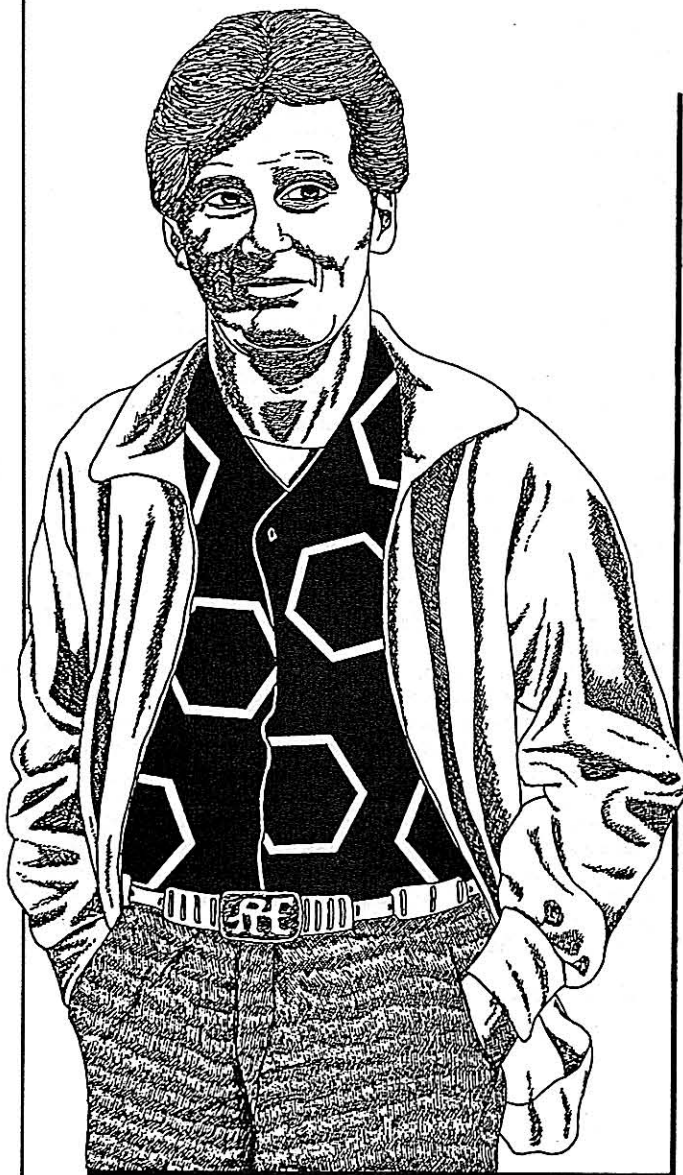





**Manner:**

Mahoney is tough as nails, the epitome of a veteran merchant skipper who has gone everywhere and seen everything. She is a hard drinker, smokes cigars, and swears like a Marine. As a shiphandler, she is very competent. As for her health problem, it barely slows her down, even at the worst of times.

**Special Knowledge/Powers:**

None.



**Name: TYPICAL RICHMOND EMPLOYEE**

**Race:** Human (usually)

**Age:** Gamemaster's Choice

**Sex:** Gamemaster's Choice

**Attributes:**

STR	- 50+2D10	CHA	- 50+2D10
END	- 50+2D10	LUC	- 1D100
INT	- 50+2D10	PSI	- 1D100-30
DEX	- 50+2D10		

**Significant Skills**

Significant Skills	Rating
Administration	40+3D10
Carousing	20+2D10
Marksmanship, Modern Weapons	10+2D10
Personal Combat, Unarmed	10+1D10
Streetwise	30+2D10
Trade and Commerce	25+2D10
Value Estimation	25+2D10

**Notes:**

Typical Richmond Enterprises employees would include secretaries, junior executives, clerks, dockyard workers, security guards, and so forth. Actual skills can be tailored to suit a character with specific jobs. The gamemaster should also try to create a coherent background and personality for each such character if the individual has a potential of becoming important to the story.

**Name: TYPICAL MERCHANT SHIP CREWMAN**

**Race:** Human

**Age:** Gamemaster's Choice

**Sex:** Gamemaster's Choice

**Attributes:**

STR	- 50+2D10	CHA	- 50+2D10
END	- 50+2D10	LUC	- 1D100
INT	- 50+2D10	PSI	- 1D100-30
DEX	- 50+2D10		

**Significant Skills**

Significant Skills	Rating
Carousing	25+2D10
Leadership	10+1D10
Marksmanship, Modern Weapons	20+2D10
Personal Combat, Unarmed	20+2D10
Small Unit Tactics	1D10
Any Four Specialty Skills	40+3D10

**Notes:**

Merchant ship crewmen are used to man the *Simone DeLeone*, either when characters from the ship are being pumped for information or to resolve a confrontation if combat arises. Specialty skills represent those skill areas needed for the performance of a specific position's duties. For example, a Helm officer might have *Starship Helm Operations*, *Shuttlecraft Pilot*, *Astrogation*, and *Starship Combat Strategy/Tactics*. The gamemaster should choose suitable skills as needed.

## KLINGON CHARACTERS

Various Klingon characters who may make an appearance in this adventure are described below. Some are full-fledged characters, while others are generic Klingons who might be encountered.

**Name:** KLINMAR, sutal-Langtorz

**Rank/Title:** Commander

**Current Assignment:** Installation Branch  
Marram IX Outpost

**Position:** Base Commander

**Race:** Imperial Klindon

**Age:** 31

**Sex:** Male

### Attributes:

STR	- 72	CHA	- 31
END	- 65	LUC	- 22
INT	- 75	PSI	- 01
DEX	- 68		

### Combat Statistics:

To-Hit Numbers: Bare-Hand Damage: 1D10+6

Modern: 53 AP: 10

HTH: 52

### Significant Skills

	Rating
Administration	68
Bribery	32
Computer Operation	34
Interrogation	46
Language	
Galacta	16
Klingonaase	60
Romulan	28
Leadership	42
Marksmanship, Modern Weapons	38
Negotiation/Diplomacy	26
Personal Combat, Unarmed	37
Security Procedures	55
Shuttlecraft Pilot	28
Small Unit Tactics	32
Social Sciences	
Klingon Culture/History	21
Klingon Law	43
Surveillance	65

### Distinguishing Physical Characteristics:

Klinmar is short, squat, and stocky. As his weight is almost all muscle, his movements are quite fluid for his bulk. Klinmar wears a full, bushy beard, and has more hair on his head than many males of his race.

### Brief Personal History:

**Birthplace:** Jit, Quadrant Delta

Klinmar has had a long but rather undistinguished career with the Empire, serving mostly on minor frontier posts.

### Personality:

#### Motivations/Desires/Goals:

Commander Klinmar is ambitious (like most Klingons), but frustrated. His undistinguished line and lackluster career have slowed his advancement to a snail's pace, and so he has adopted a "keep your nose clean" attitude and a deep-seated fondness for schemes that might suddenly catapult him to success. He runs a very tight base, concentrating on efficiency and avoiding scrutiny by Imperial Intelligence. His current plot, to support Mouhkta's bid to re-enter the Federation with the falsified Dixie material, is calculated to win him the favorable attention of the high command.

#### Manner:

If a Klingon could fawn, Klinmar would do it. As it is, he is a likspittle and toady to the greatest extent possible, though no one can accuse him of being *kuve*. Nervous about Imperial Intelligence, he is careful to make no public utterances (and precious few private ones) that will too deeply commit him to anyone or anything.

#### Special Knowledge/Powers:

Klinmar is one of only three Klingons aware of Mouhkta's plans.



**Name: KRESZ, sutai-Kargon****Rank/Title:** Captain**Current Assignment:** IKV *Deathless Glory*, Imperial Navy*Position:* Captain/Battle Group Commander**Race:** Imperial Klingon**Age:** 28**Sex:** Male**Attributes:**

STR	- 84	CHA	- 08
END	- 65	LUC	- 44
INT	- 81	PSI	- 30
DEX	- 72		

**Combat Statistics:**

To-Hit Numbers:

*Modern:* 58*HTH:* 52

Bare-Hand Damage: 2D10+3

AP: 11

**Significant Skills**

	Rating
Administration	42
Bribery	41
Computer Operation	38
Gaming, Klin Zha	69
Interrogation	51
Language	
Galacta	30
Klingonaase	60
Romulan	18
Leadership	72
Marksmanship, Modern Weapons	43
Negotiation/Diplomacy	26
Personal Combat, Unarmed	31
Security Procedures	17
Starship Combat Strategy/Tactics	83
Starship Helm Operation	51
Surveillance	29

**Distinguishing Physical Characteristics:**

Kresz sutai-Kargon is a tall, massively built Imperial Klingon. Unlike most males of his race, he does not wear a beard, but does have a long, elegantly thin, silky mustache that frames his mouth and chin. The right side of his face bears several scars, and his overall appearance is menacing and evil to Federation eyes.

**Brief Personal History:***Birthplace:* Kargarth, Quadrant Beta

One of the rising stars of the Imperial Navy, Kargon is a name well-known to the UFP since the infamous "Kargon Incident". In that incident, the Klingon Captain destroyed a Federation outpost in the Orion sector and then lured Captain J. C. Fredriksen and three Star Fleet capital ships into a trap that resulted in the destruction of the entire UFP squadron. After that action, Kargon received command of the *Deathless Glory*, one of the new L-42 frigates built on Romulan lines and equipped with a cloaking device. Until Admiral Koloth's arrival, Kresz was senior officer at Marram IX.

**Personality:***Motivations/Desires/Goals:*

Like most Klingons, Kargon wants to win glory, prestige, and power. As squadron commander at Marram IX, he had hoped to be able to fight some Romulans, but the arrival of Koloth bumped him from the squadron leader's position and placed him at the Admiral's mercy. Koloth, a more methodical officer than Kresz sutai-Kargon, is much less likely to go searching for trouble with the Star Empire.

Thus, Kargon's main concern right now is the removal of Koloth (or, alternatively, his own transfer to an independent command). He would do almost anything to discredit or eliminate Koloth, but the canny Human-fusion Admiral is a difficult foe.

*Manner:*

Kresz sutai-Kargon is blunt and aggressive. A brilliant tactician, he even has some of the strategic skill lacking in most Klingons, a trait that marks him as dangerous to his peers. However, ambition and a restless urge for glory make Kargon excitable and easily blinded to the consequences of his actions. He is often too forthright and direct in his play of "the perpetual game" to be as effective *politically* as he is in battle. Outspoken and prone to sudden rages, Kargon has been known to kill officers for disturbing his sleep by snoring too loudly in a planetside camp.

**Special Knowledge/Powers:**

None.

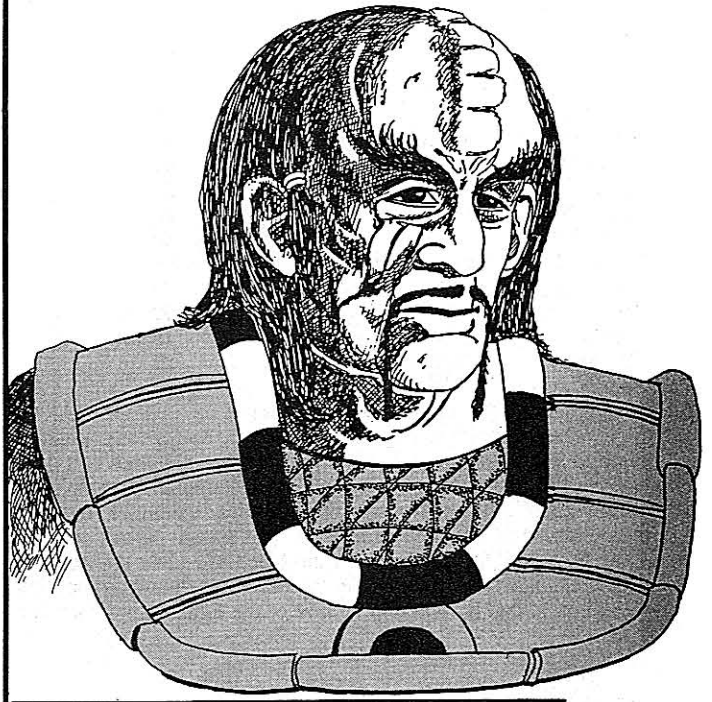

**Name: KOLOTH, zantai-Rahanz****Rank/Title:** Admiral**Current Assignment:** Nawlogh WejHeH cha' Dich  
IKV *Dominator*, Imperial Navy**Position:** Squadron Commander**Race:** Klingon/Human Fusion**Age:** 48**Sex:** Male**Attributes:**

STR	- 79	CHA	- 59
END	- 81	LUC	- 36
INT	- 76	PSI	- 21
DEX	- 71		

**Combat Statistics:**

To-Hit Numbers:	Bare-Hand Damage:	2D10+5
Modern: 64	AP:	11
HTH: 56		

**Significant Skills**

	Rating
Administration	41
Bribery	37
Computer Operation	38
Gaming	
Chess	26
Klin zha	39
Interrogation	69
Language	
Galacta	41
Klingonaase	60
Leadership	79
Marksmanship, Modern Weapons	57
Negotiation/Diplomacy	42
Personal Combat, Unarmed	41
Security Procedures	25
Space Sciences, Astrogration	43
Starship Combat Strategy/Tactics	85
Starship Helm Operation	73
Starship Sensors	39
Starship Weaponry Operation	45
Streetwise	28
Surveillance	47

**Distinguishing Physical Characteristics:**

Although he is growing old for a Klingon, Koloth does not show his age. His hair and "van Dyke" style beard are still black and silky, and his face unlined. Koloth has a high forehead and narrow face. Unlike many Klingon/Human Fusions, his eyebrows are not bifurcated, and his appearance is (to Human eyes) vaguely Oriental. Koloth frequently wears the black-and-silver uniform with sleeveless mesh tunic popular in the days of his youth, a personal idiosyncrasy that is allowable for one of the Empire's most famous Captains.

**Brief Personal History:****Birthplace:** Klinzhai

Koloth is one of the most well-known figures of the Imperial Navy. For a brief time, a fictionalized video series based on his exploits ("*Devisor Victorious*") was nearly as popular as the much older "*Battlecruiser Vengeance*".

Through most of his career, Koloth's chief non-Klingon opponent was the Federation's James T. Kirk. The two commanded cruisers along the Organian frontier at the same time, and clashed on several occasions (including two separate incidents involving tribbles). Both were promoted to Admiral and assigned staff positions. While Kirk was facing V'jer and hankering for an active command once more (which Star Fleet denied him), the venerable Admiral Koloth was manipulating things to *get* such a command. He recently took up active command of *Nawlogh WejHeH cha' Dich* (the official Imperial designation, translated roughly as "Second Triangle Squadron"), based at Marram IX.

**Personality:****Motivations/Desires/Goals:**

Koloth has a keen sense of his own mortality, but does not want to be carried off by old age or the plottings of some rival in the *Komerex zha*. His ideal end would be death in glorious combat under the naked stars, and his quest for a new command was intended to make this possible. Battle and glory for the sake of it are not all that Koloth wants, however. He is a thinker and a planner, and could someday become a Thought Admiral. This native caution has brought him into conflict with sutai-Kargon, which has plunged Koloth back into the Perpetual Game to keep the aggressive young Captain from destroying him.

**Manner:**

Koloth is, for a Klingon, charming and diplomatic, the kind of oily character star Fleet officers like and hate at the same time. His play of the *komerex zha* is devious and subtle. To this day, he remains an effective and popular figure. (Although the actor who portrayed him on video was of the Imperial race, few outside the Navy know that Koloth is a Human Fusion).

Under no circumstances should anyone mention tribbles in the presence of Admiral Koloth zantai-Rahanz.

**Special Knowledge/Powers:**

None.

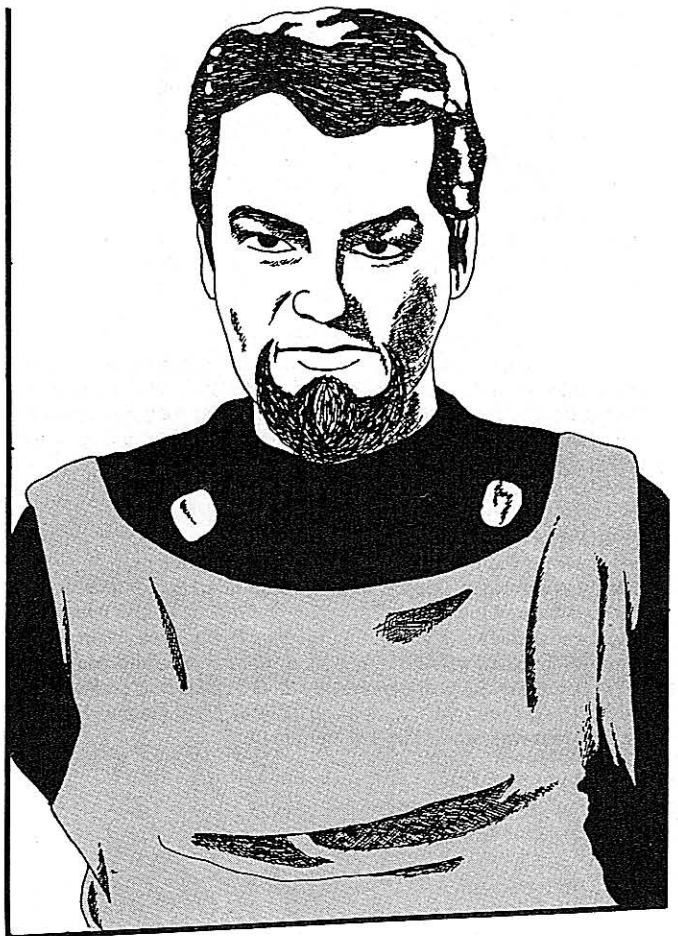

**Name:** MOUHKTA, Rashed

**Rank/Title:** Captain

**Current Assignment:** Imperial Intelligence  
gharg DlvImey Daq Inmol

**Position:** Field Agent

**Race:** Klingon/Orion Fusion

**Age:** 35

**Sex:** Male

**Attributes:**

STR - 79	CHA - 52
END - 82	LUC - 38
INT - 84	PSI - 08
DEX - 68	

**Combat Statistics:**

**To-Hit Numbers:** Bare-Hand Damage: 2D10+7

**Modern:** 61

**AP:** 10

**HTH:** 72

**Significant Skills**

	<b>Rating</b>
Bribery	35
Clandestine Operations	79
Communications Systems Operation	56
Communications Systems Technology	41
Computer Operation	48
Damage Control Procedures	25
Interrogation	49
Language	
Galacta	48
Klingonaase	60
Orion	60
Leadership	52
Marksanship, Modern Weapons	54
Mechanical Engineering	19
Negotiation/Diplomacy	29
Personal Combat, Unarmed	75
Security Procedures	56
Space Sciences, Astronautics	31
Streetwise	28
Surveillance	56
Warp Drive Technology	32

**Distinguishing Physical Characteristics:**

Mouhkta has had extensive plastic surgery to disguise his origins as a Klingon/Orion Fusion. He is as convincing in his image as Arne Darwin was as a Human in the Sherman's Planet Incident. The pseudo-Orion is of average height, but is somewhat overweight and has a swarthy complexion. Tricorder readings will identify him as a Klingon.

**Brief Personal History:**

**Birthplace:** Irashkar, Beta Quadrant

Mouhkta was born Vrede Trusagh, a Klingon/Orion Fusion on one of the Empire's Orion subject worlds. His family suffered heavily in the Orion Fusion pogroms that followed a bid for power by a local Klingon admiral who used Orions and Orion Fusions extensively to build his power base. These pogroms virtually eliminated Orion Fusions from the Empire, and Mouhkta was saved only because an enterprising Intelligence Officer thought of using him as a mole.

Surgery and a thoroughly developed background history enabled the spy to enter Orion space, and then the Federation itself. He was disguised as a refugee from the Klingons, possessing valuable knowledge and having no Imperial loyalties that might hinder his security clearances. Mouhkta ended up in Star Fleet Intelligence, and joined with nearly a hundred others in training for Operation Dixie. It was his betrayal that destroyed the whole mission.

Since then, the agent has been working toward getting himself and his carefully-faked Dixie information accepted back into Star Fleet, and has enlisted the aid of Commander Klinmar.

**Personality:**

**Motivations/Desires/Goals:**

Mouhkta is fiercely loyal to the Empire despite the pogroms of his early years, and wants to serve the Klingon cause to the best of his ability. He wants to do it away from the prejudices and intricacies of the Perpetual Game, which he knows he cannot win because of his birth. Currently, all his attention is concentrated on his plans. He is especially concerned that Klinmar will accidentally or deliberately ruin his chances of success.

**Manner:**

To the other Federation prisoners and to potential rescuers, Mouhkta is the very image of the stalwart defender of the UFP. If discovered, he will use every trick in the book to silence anyone who penetrates his cover so that his overall plan can continue. Failing that, Mouhkta will die like a true Klingon, taking with him as many enemies as possible.

**Special Knowledge/Powers:**

Mouhkta, of course, knows all the details of the Dixie plot. However, his personnel file admitted nothing of his engineering skills (and for this reason he was one of the least likely suspects as a traitor). All his shipmates, too, believe that he knows not a thing about warp drives and such.



**Name: TYPICAL KLINGON JUNIOR OFFICER****Race:** Klingon (any type, but probably Imperial Race)**Age:** Gamemaster's Choice**Sex:** Gamemaster's Choice**Attributes:**

STR	- 60+2D10	CHA	- 25+2D10
END	- 55+2D10	LUC	- 10+2D10
INT	- 40+3D10	PSI	- 1D100-60
DEX	- 60+2D10		

Significant Skills	Rating
Administration	20+2D10
Interrogation	4D10
Language	
Galacta	20+3D10
Klingonaase	60
Leadership	20+2D10
Marksmanship, Modern Weapons	30+2D10
Negotiation/Diplomacy	10+2D10
Personal Combat, Unarmed	30+2D10
Security Procedures	4D10
Small Unit Tactics	4D10
Surveillance	20+2D10

**Notes:**

Junior officers may appear as aides, officials, commanders of troop detachments, or as other individuals encountered on an incidental basis. Considerable latitude is allowed the gamemaster in working up characters tailored to specific jobs or situations.

**Name: TYPICAL KLINGON GUARD****Race:** Klingon (any type, but mostly Imperial Race)**Age:** Gamemaster's Choice**Sex:** Gamemaster's Choice**Attributes:**

STR	- 65+2D10	CHA	- 20+2D10
END	- 60+2D10	LUC	- 5+2D10
INT	- 30+2D10	PSI	- 1D100-60
DEX	- 60+2D10		

Significant Skills	Rating
Marksmanship, Modern Weapon	40+2D10
Personal Combat, Knife	40+2D10
Personal Combat, Unarmed	45+2D10
Security Procedures	20+2D10
Small Unit Tactics	20+2D10

**Notes:**

These characters fill the roll of prison guards, escort troopers, and other soldiers or security troops met in the course of the adventure. The gamemaster can flesh these characters out as desired.



## PRISONERS AND PAWNS

The characters that follow are key members of Operation Dixie who are held prisoner on Marram IX (plus a "typical" character category for use in adding extras). Also included are typical guerrilla characters to round out an assault or diversionary force, and typical colonists who might be encountered on Marram IX in the course of a hunt for the guerrillas.

**Name:** ARVAN, tai-Vinsar

**Rank/Title:** Lieutenant Commander

**Current Assignment:** Star Fleet Intelligence Command  
*USS Dixie Lady* NCU-9182

**Position:** Chief Intelligence Officer

**Race:** Klingon/Human Fusion

**Age:** 39

**Sex:** Male

### Attributes:

STR - 72	CHA - 59
END - 68	LUC - 50
INT - 83	PSI - 12
DEX - 64	

### Combat Statistics:

To-Hit Numbers:	Bare-Hand Damage: 1D10+6
<i>Modern:</i> 61	AP: 10
<i>HTH:</i> 50	

### Significant Skills

	Rating
Bribery	32
Clandestine Operations	75
Communications Systems Operation	35
Computer Operation	42
Language	
Galacta	39
Klingonaase	60
Leadership	28
Marksmanship, Modern Weapons	58
Personal Combat, Unarmed	36
Security Procedures	32
Streetwise	48
Surveillance	35

### Distinguishing Physical Characteristics:

Arvan is tall, slim, and fairly typical of Klingon/Human Fusions. His most notable feature is the fact that his left leg contains a series of metal rods replacing the thigh bone and knee joint. These were implanted in his flesh to repair massive injuries sustained in his flight from Klingon space. When encountered, tai-Vinsar is battered and bruised by torture, but still resisting his captors after a year of intermittent interrogations (which have been tempered by Mouhkta's desire to keep Arvan alive until the location of the real Dixie data has been found and the information destroyed).

### Brief Personal History:

**Birthplace:** Gnuu Re, Quadrant Delta.

A scion of a notable Human Fusion Line, Arvan was a young officer serving aboard a *D-7M* battlecruiser when the Emperor ordered the elimination of the traditional racial divisions that had previously left specific frontier areas in the hands of the various Fusion races. Arvan's line was one of many that resisted. Facing execution, he stole a shuttlecraft and fled after suffering the severe wounds that ruined one of his legs. After being rescued by a Federation starship, he was operated on by Star Fleet surgeons, and nursed back to health.

Arvan then became employed by the SFIC as a source of information and translator, until the organization of Operation Dixie prompted his assignment to the *USS Dixie Queen*. He later transferred to the *Dixie Lady* before being captured and sent to Marram IX.

### Personality:

**Motivations/Desires/Goals:**

Though he works for Star Fleet, Arvan is still very much a Klingon. Torture has failed to break him. Indeed, it has only stiffened his resolve. Knowing that he has the Dixie information, Arvan wants to escape and return to the Federation. His other great desire is to see the traitor Mouhkta die an agonizingly slow and painful death.

**Manner:**

Arvan is now grim, his whole world narrowed down to his quest for vengeance and freedom. He speaks only rarely, and then haltingly and in great pain.

### Special Knowledge/Powers:

Prior to making the last, ill-fated attempt to contact Star Fleet, Arvan took the precaution of duplicating the Dixie information on a tiny microchip, then injecting it subcutaneously into his left thigh. Scanners pick this up as part of the set of artificial bones in the leg, and so his deception has not been discovered.





**Name:** ASTUR, vestai-Krinith  
**Rank/Title:** Lieutenant  
**Current Assignment:** Star Fleet Intelligence Command  
*USS Dixie Lady* NCU-9182  
**Position:** Chief Security Officer

**Race:** Klingon/Human Fusion  
**Age:** 34  
**Sex:** Male

**Attributes:**

STR - 88	CHA - 38
END - 72	LUC - 46
INT - 65	PSI - 01
DEX - 69	

**Combat Statistics:**

To-Hit Numbers:	Bare-Hand Damage: 2D10+6
<i>Modern:</i> 66	AP: 10
<i>Knife:</i> 69	
<i>HTH:</i> 64	

**Significant Skills**

	Rating
Clandestine Operations	32
Computer Operation	45
Interrogation	76
Language	
Galacta	40
Klingonaase	60
Leadership	38
Marksmanship, Modern Weapons	62
Mechanical Engineering	31
Personal Combat, Knife	58
Personal Combat, Unarmed	68
Security Procedures	75
Shuttlecraft Pilot	18
Small Unit Tactics	53
Streetwise	39
Surveillance	42
Warp Drive Technology	24

**Distinguishing Physical Characteristics:**

Astur is tall and heavy-set, a muscular figure whose Klingon/Human Fusion features make for an evil, menacing aura. He wears a ragged outfit stolen from a security guard at the prison camp during his escape.

**Brief Personal History:**

*Birthplace:* Kroja, Beta Quadrant

Astur vestai-Krinith fled to the Federation under much the same circumstances as his friend and comrade, Arvan, though he was not wounded in his escape. Selected for Operation Dixie, he served as security officer (in effect, the second-in-command of the intelligence group with a special interest in maintaining the Dixie cover identities of both *Dixie Queen* and, later, *Dixie Lady*). About three months ago, he managed a solo escape from the prison camp, and has been living on his own in the hills ever since.

**Personality:**

*Motivations/Desires/Goals:*

Astur is not particularly bright, but he hates captivity. His escape plan lacked finesse, but his strength and a healthy dose of luck made up for it. After guerrillas shot at him (thinking he was a Klingon guard), Astur avoided contact with everyone and bided his time.

His main goal is to save Arvan, an old comrade to whom he owes a life-debt. He escaped largely in hope of finding his friend, which remains his principal goal.

*Manner:*

Lieutenant vestai-Krinith is a surprisingly gentle Klingon who uses his physical prowess only when necessary. He mistrusts the guerrillas, but will be eager to cooperate with anyone who can help him get to Arvan.

**Special Knowledge/Powers:**

The gamemaster should introduce Astur only if it seems necessary to give the adventurers some added help in realizing that Mouhkta is the mole. Astur believes Mouhkta knows nothing about warp engines, and can identify this key clue if the group misses it. Moreover, his fierce desire to free Arvan (and his overpowering physical presence, which ensures that he will at least hold his audience during a debate) helps to spur the group on to recover the Intelligence Chief.



**Name: TYPICAL DIXIE PRISONER**

Race: Klingon or Orion  
 Age: Never less than 30 years  
 Sex: Male

**Attributes:**

STR	- 45+2D10	CHA	- 30+2D10
END	- 50+2D10	LUC	- 10+2D10
INT	- 55+2D10	PSI	- 1D100-50
DEX	- 50+2D10		

Significant Skills	Rating
Marksmanship, Modern Weapons	30+2D10
Personal Combat, Unarmed	40+2D10
Any Four Specialty Skills	40+2D10

**Notes:**

These statistics may be used to re-create any of the 20 or so Dixie prisoners not described elsewhere, should this prove necessary. The gamemaster should note that *no* character should receive *Warp Drive Technology* as a specialty skills area. The only two characters from the Engineering section of the *Dixie Lady* (Chief Engineer Koth and Engineer Roukaffen) with this skill were killed. This is very important to the flow of the adventure.

**Name: TYPICAL COLONIST**

Race: Human  
 Age: Gamemaster's Choice  
 Sex: Gamemaster's Choice

**Attributes:**

STR	- 40+3D10	CHA	- 50+2D10
END	- 40+3D10	LUC	- 1D100
INT	- 60+2D10	PSI	- 1D100-30
DEX	- 40+3D10		

Significant Skills	Rating
Negotiation/Diplomacy	20+2D10
Personal Combat, Unarmed	10+3D10
Social Sciences	
Preserver Archaeology	10+4D10

**Notes:**

Characters of this type will be encountered during visits to the Human colony. They may be "sheilas" (collaborators who will summon Klingon soldiers), or they may be reluctant but totally non-violent sources of assistance.

**Name: TYPICAL GUERRILLA**

Race: Human  
 Age: Gamemaster's Choice  
 Sex: Gamemaster's Choice

**Attributes:**

STR	- 50+2D10	CHA	- 50+2D10
END	- 50+2D10	LUC	- 1D100
INT	- 60+2D10	PSI	- 1D100-30
DEX	- 50+2D10		

Significant Skills	Rating
Marksmanship, Modern Weapons	30+2D10
Personal Combat (any 1 Armed)	30+2D10
Personal Combat, Unarmed	20+2D10
Planetary Survival, Warm Temperate	30+2D10
Small Unit Tactics	10+2D10

**Notes:**

These represent the various characters involved in guerrilla operations on Marram IX. They are primarily useful as 'cannon fodder' in the raid against the Klingon prison camp.

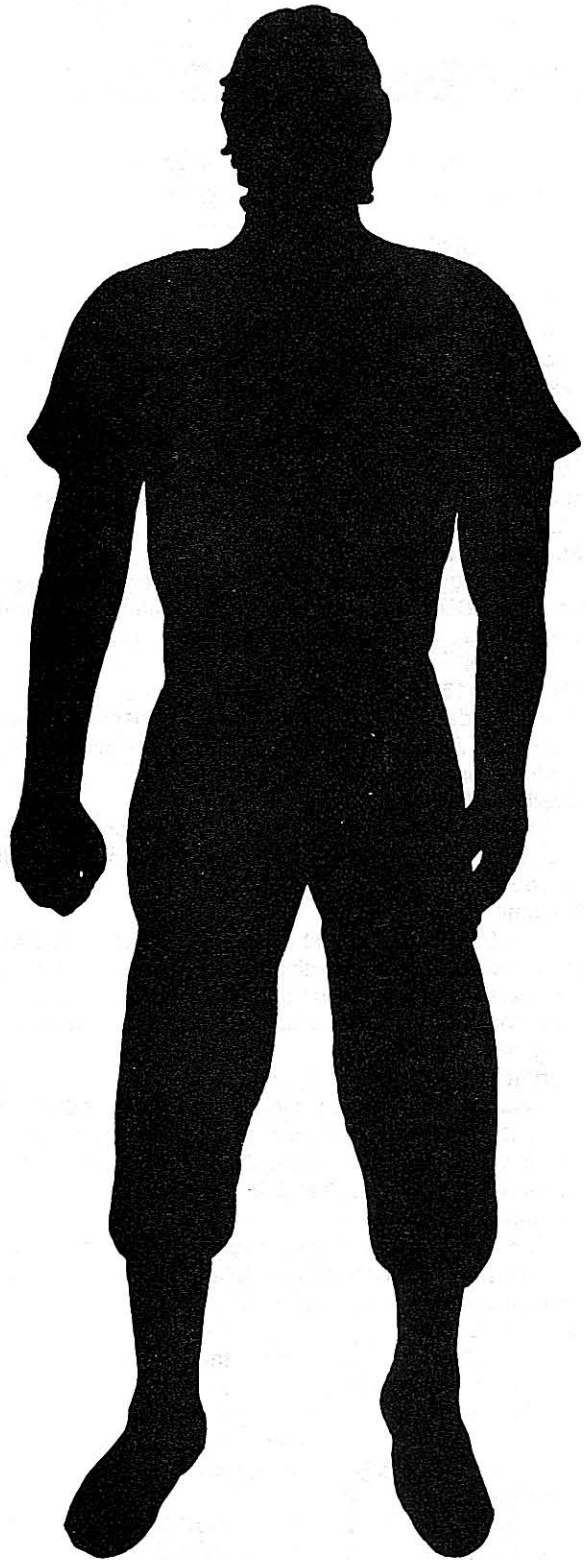

# GAMEMASTER'S NOTES

## HINTS ON PLAY

The following information is intended to assist the gamemaster in setting up and running the adventure.

### ADVENTURE TIMELINE

The timeline presented below summarizes the events that lead up to the start of this adventure. Once the adventure actually begins, there are too many variables involved to accurately plot the exact moment when specific events might take place.

#### **Stardate 2/1408.12**

Initial plans regarding Operation Dixie are filed with Admiral Nogura, Chief of Star Fleet Operations. Nogura approves the tentative proposal, whose projected start date is 2/1901.

#### **Stardate 2/1506.06**

The Klingon Sector of SFIC accelerates preparations for Operation Dixie, believing the mission offers the means of proving its superiority to its rival, Romulan Sector Intelligence.

#### **Stardate 2/1610.24**

Final orders for Operation Dixie are transmitted from San Francisco. All preparations in the field are now complete, and these orders constitute a go-ahead.

#### **Stardate 2/1702.15**

The three Operation Dixie ships depart on their planned five-year mission, nearly two years ahead of the originally scheduled start date.

#### **Stardate 2/1808**

The *USS Dixie Lady* at Jit receives a message from the *USS Dixie Queen* suggesting a rendezvous. This message was transmitted as a result of Mouhkta's manipulation of the *Dixie Queen's* wardroom officers. Marram IX is occupied by Klingons.

#### **Stardate 2/1907**

Rendezvous between the *Dixie Queen* and the *Dixie Lady*. Several crew members are swapped, and the ships exchange identities. The *Dixie Queen* sets course for Gnuu Re', while the *Dixie Lady* heads for Star Base 12.

#### **Stardate 2/1908**

The *Dixie Queen* is destroyed. The *Dixie Lady* picks up the Mayday broadcast. Mouhkta begins to work on arranging a rendezvous with the *Dixie Princess*.

#### **Stardate 2/2004**

The *Dixie Lady* contacts the *Dixie Princess* and arranges a rendezvous.

#### **Stardate 2/2011**

The two Dixie ships rendezvous, again exchanging crewmen. The *Dixie Princess* shapes course for Gnuu Re'.

#### **Stardate 2/2106.18**

The *Dixie Princess* is destroyed by Klingon patrols. Project Minuteman launched on Marram IX.

#### **Stardate 2/2201.26**

News of the destruction of the *Dixie Princess* reaches the *Dixie Lady*. A message is sent to Star Base 12, but only a portion of it gets past Klingon jamming.

#### **Stardate 2/2206**

The Dixie scandal begins to rock Star Fleet. Admiral Nogura resigns, Commodore Loomis retires, and Captain Tremaine is reassigned to Star Base 10.

#### **Stardate 2/2207**

The *Dixie Lady* reaches Marram IX. Mouhkta enlists the aid of Commandat Klinmar in his project to return to the Federation.

#### **Stardate 2/2211**

The *ex-Dixie Lady* is sold to Richmond Enterprises. Captain Tremaine arrives on Freeman's Port.

#### **Stardate 2/2303.18**

Nicholas Tremaine spots a shuttle belonging to the *Dixie Lady* on Freeman's Port. He sends the message that begins this adventure.

### JUDGING KLINGON CHARACTERS

Proper play of this module almost demands that the FASA supplement on **The Klingons** be available. Lacking this supplement, however, it is still possible to play the adventure if the gamemaster keeps the following points in mind.

The Klingons are a humanoid species that evolved on a hot, humid world orbiting a Type F star. Their society is strongly based on individual competition for power and prestige, which tends to promote the creation of numerous shifting power blocks as individual leaders emerge from the herd. Whatever promotes personal advancement is considered "moral," but each individual must be constantly on guard against a coup by rivals. This tends to create a balance that restrains Klingon leaders from total anarchy by their need for vigilance.

The master Imperial Race is supplemented by several "Fusion races" produced through genetic manipulation of basic breeding stock. Human, Romulan, and Orion Fusions have been identified. Others are possible but uncommon. Various servitor (*kuve*) races occupy a very low level in the Imperial hierarchy.



Larns Dromal

## Klingon Skills

Rules for character generation are given in **The Klingons**. With some variations, these are quite similar to the basic ST:RPG game procedures. Certain new skills, however, are of importance to the play of this adventure.

### **Bribery**

This is skill in subtle negotiation of bribes, kickbacks, and other quasi-legal and illegal payoffs. The skill comes into play whenever a character must make a secret pay-off or buys off a corruptible individual. Failure of a Skill Roll against *Bribery* means that the authorities detect the attempt, either because the bribe was not subtle enough, or the character being bribed turned in the person offering the bribe.

### **Interrogation**

This skill governs the questioning of prisoners, sometimes under duress or torture. It is necessary to make a Skill Roll against *Interrogation* to successfully gain information from a prisoner. If the roll succeeds, the victim gets a chance to make a Saving Roll against his INT score (if the interrogator is using trickery) or his END score (if duress or torture is used). If the victim's roll succeeds, he reveals no information. If not, the interrogator gets a significant piece of information, at the gamemaster's option. The gamemaster may give bonuses (or penalties) to victims based on the importance of their information, training, and temperament.

NOTE: If torture is used, it is possible that the victim may die before giving up a secret. If the questioner makes a successful roll against *Interrogation*, and the victim fails an END saving roll by more than 20 points, the victim passes out, taking 2D10 of wound-type damage in the process. (The damage can be cut in half if the victim is attended by support devices and/or medical personnel who make a successful roll against the appropriate *General Medicine* skill). The victim may be immediately revived. If the damage does not kill him or bring him below his unconsciousness level, the victim may be immediately revived. However, the process must begin again with another roll against *Interrogation* skill.

Also, each torture attempt does 1D10 wound damage (or half that, as noted above) to the victim, no matter what the outcome. Thus, the victim's END continues to drop under continued torture, making it all the more likely that the victim will pass out or even die under duress before talking. It is possible to administer medical aid to raise END before continuing torture.

Remember that Vulcans know mental techniques to 'turn off' pain. Thus, it is impossible to torture information out of a Vulcan.

### **All Technology and Operational Skills**

All skills of these types are effectively halved when working with the equipment of an unfamiliar race. Thus, a Klingon with a 48 skill rating in *Communication Systems Operation* would have a rating of only 24 when operating such equipment on a Federation vessel.

The penalty to skill ratings is negated if the character can make a successful Skill Roll against the appropriate language, or has had time to become familiar with the controls either through EXTENSIVE trial and error, or by having someone who reads the language (or is of the appropriate race) demonstrate the workings of the equipment.

In this adventure, player characters (only) are assumed to be fully familiar with both Federation and Klingon equipment, and so should suffer no penalty.

## Surveillance

This is skill in seeing without being seen, either personally or through technological devices such as hidden microphones or cameras. A successful roll against *Surveillance* will allow one character to follow another without being spotted (though, in some cases, the target may get a Saving Roll against INT.)

Other aspects of the skill are strictly limited to applications within the Klingon culture, and are discussed in **The Klingons** supplement.

### **Clandestine Operations**

This skill is not introduced in **The Klingons** supplement, but is related to espionage organizations of any culture. It represents skill in all facets of undercover work, including disguise, coding and decoding, the strategy and tactics of covert operations, and so forth. A skill roll should be used to determine success in any situation where a character's skill as an espionage agent would logically come into play.

### **Klingon Physiology**

Due to their different physiology, note the following game adjustments for Klingons:

Imperial Race Klingons take +1 point damage per die from projectile weapons such as bullets, and +2 points of damage per die from edged weapons such as swords and daggers.

Fusions take +1 point damage from edged weapons only.

Neural Drugs (sedatives, stimulants, neural paralyzers, etc.) add +1 point per die of effect. In addition, inhaled drugs of this type will also take effect ten percent faster in both Imperial Klingons and Fusions.

The following adjustments are made to stun damage taken by Klingons.

### KLINGON STUN DAMAGE

DAMAGE	Humans	Fusions	Imperials
Stun	75	60	50
(Graze)	25	20	20
Heavy Stun	120	100	80
(Graze)	40	35	30

The standard healing rates for Klingon Fusions are the normal rates given in the basic rules: 1/10 normal END score per half hour for 'temporary' damage and 1/20 (round down) normal END per day for wound damage.



## RELAYING PLAYER'S INFORMATION

### Judging Sensor/Tricorder Use

In an adventure of this type, where characters are Intelligence operatives whose lives may depend on how well they gather and analyze information, the gamemaster should strongly consider an interactive method of passing on facts to the players, rather than relying on straight descriptions. This will force players to *think* about what is happening around them, and can sometimes be a means of providing subtle clues.

FASA's **Tricorder/Starship Sensors Interactive Display** is an excellent example of such a system. The rules provided in this product, together with the display itself, allow information to be passed out and interpreted only as the players could reasonably expect to receive that data. It forces them to draw their own conclusions, rather than having the gamemaster hand them everything they need.

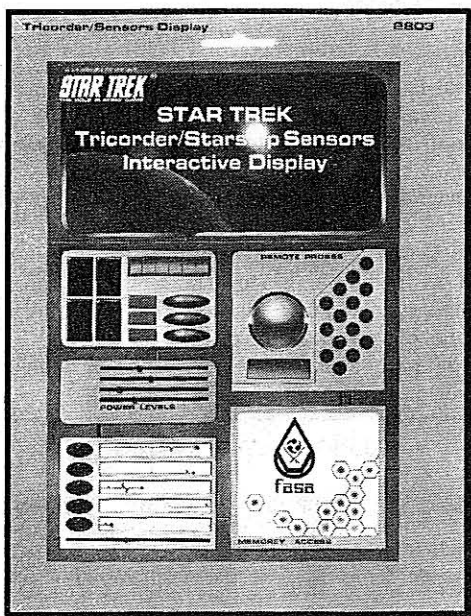

If the **Tricorder Starship Sensor Display** is used, the gamemaster must be consistent. Thorough familiarity with the rules for the display's use is important, and advance preparation of major readings (coded according to the procedures outlined in those rules) will be useful.

### Player Information Handouts

Included with this booklet are two **Players' Handouts** containing information for use by players of **The Dixie Gambit**. The gamemaster will probably find it easiest simply to lift out these pages, to be photocopied and passed around to the players. The gamemaster may also choose to withhold some of the material.

The material in the **Operation Dixie** handout provides everything Federation authorities know about the mission as of 2/2301.

The **Player's Background Information** includes computer file information on various topics of potential interest to players of **The Dixie Gambit**. However, not ALL the topics covered are important. Some entries are included merely for the sake of obscuring the plot of the adventure. Material from this handout would be available to any character making a successful Skill Roll against **Computer Operation**, or who makes a success Saving Roll against his INT score.

## PERSONAL OUTCOMES

In any ongoing campaign, reward for good play, in the form of skill improvements, should be granted from time to time. At the conclusion of this adventure, characters should have a chance to increase certain skills.



**Helen Johnson**

Each character who survives the adventure, no matter what its outcome, should receive 10 to 20 skill points distributed by the gamemaster and the players to reflect new knowledge and training *in the skills that character used in the adventure*. The number and distribution of skill point awards should reflect the character's participation in the adventure, the number of successful skill rolls made, and the *player's* skill in roleplaying or the creative use of skills.

If (and only if) the characters uncovered Mouhkta's deception without help from the NPCs, the characters should receive up to 10 extra points, to be applied in the skills of *Clandestine Operations, Leadership, Interrogation, or Surveillance*. The number of points applied should reflect the character's contribution to the discovery. A player who was quick to spot the inconsistency might get 10, while those who were less involved might get fewer points, and those who were completely fooled, none at all.

Non-Klingon characters who interact with Klingons (either NPCs or Klingon player characters) should apply at least half of *all* bonus points received to increasing the skills of *Language, Klingonaase, Klingon Culture/History, Klingon Law, or Psychology, Klingon*.

## FURTHER ADVENTURES

Many other situations are hinted at or can arise from this scenario for **The Dixie Gambit**. In terms of an ongoing campaign, the characters must still ferret out Mouhkta's ring in Star Fleet, as he must certainly have had accomplices inside the Federation. There is also the existence of the Kinshaya beyond the Klingon border, discovered here, but not yet explained.

Ambitious gamemasters can go further. They can mount operations in the MCA and on Marram IX. They could launch follow-ups to Operation Dixie. With this module as a blueprint, it would even be possible to set an adventure aboard the Dixie ships. For example, the events of this module could be altered so that Mouhkta is discovered and the Dixie information is actually retrieved instead of being lost for over a year.

With imagination and effort, any module can be the gateway to a whole universe of **STAR TREK** adventuring.

## ADVENTURE BACKGROUND

This chapter is for the gamemaster's eyes only. Although the narrative contained in **The Adventure** often gives background elements as they occur, this section summarizes all important background material. Information here may flatly contradict material given in the **Player's Information** handouts or that the players have acquired in other ways. It should *never* be given to the players, except as they can legitimately discover the truth in the course of the adventure.

### PLANETS

The planetary descriptions in the **Player's Handout** are correct in all essentials. In addition, following are full planet logs for the worlds that actually appear in this adventure. A *second* Skill Roll against the *Computer Operations* rating of players consulting computer records will produce this specific data, as will the use of sensors or tricorders (according to the rules given in the **FASA Tricorder/Starship Sensors Interactive Display**). This same data, along with information on all 120 inhabited worlds of the Triangle, is also contained in FASA's supplement on **The Triangle**.

#### World Log: FREEMAN'S PORT

##### System Data

System Name: Sivzunn  
 Map Coordinates: (10.7S 6.9E)  
 Number Of Class M Present: 1

##### Planetary Data

Position In System: 1  
 Number Of Satellites: 2  
 Planetary Gravity: .9G  
**Planetary Size**  
 Diameter: 11,700 km  
 Equatorial Circumference: 36,00 km  
 Total Surface Area: 459,000,000 sq. km.  
 Percent Land Mass: 96%  
 Total Land Mass: 440,640,000 sq. km.

##### Planetary Conditions

Length Of Day: 26 hours  
 Atmospheric Density: Terrestrial  
 General Climate: Cool Temperate

##### Mineral Content

Normal Metals: 22  
 Radioactives: 26  
 Gemstones: 13  
 Industrial Crystals: Trace  
 Special Minerals: Trace

##### Cultural Data

Technological/  
 Sociopolitical Index: 998776-98  
 Planetary Trade Profile: EDCEDEFD/B(C)

#### World Log: MARRAM IX

##### System Data

System Name: Marram  
 Map Coordinates: (12.3S 7.2E)  
 Number Of Class M Present: 1

##### Planetary Data

Position In System: IX  
 Number Of Satellites: 2  
 Planetary Gravity: 1.1G  
**Planetary Size**  
 Diameter: 14,300 km  
 Equatorial Circumference: 44,000 km  
 Total Surface Area: 561,000,000 sq. km.  
 Percent Land Mass: 29%  
 Total Land Mass: 162,690,000 sq. km.

##### Planetary Conditions

Length Of Day: 28 hours  
 Atmospheric Density: Terrestrial  
 General Climate: Warm Temperate

##### Mineral Content

Normal Metals: 36  
 Radioactives: 23  
 Gemstones: Trace  
 Industrial Crystals: Trace  
 Special Minerals: Trace

##### Cultural Data

Technological/  
 Sociopolitical Index: Klingon  
 Planetary Trade Profile: BDEDEFF/C(E)

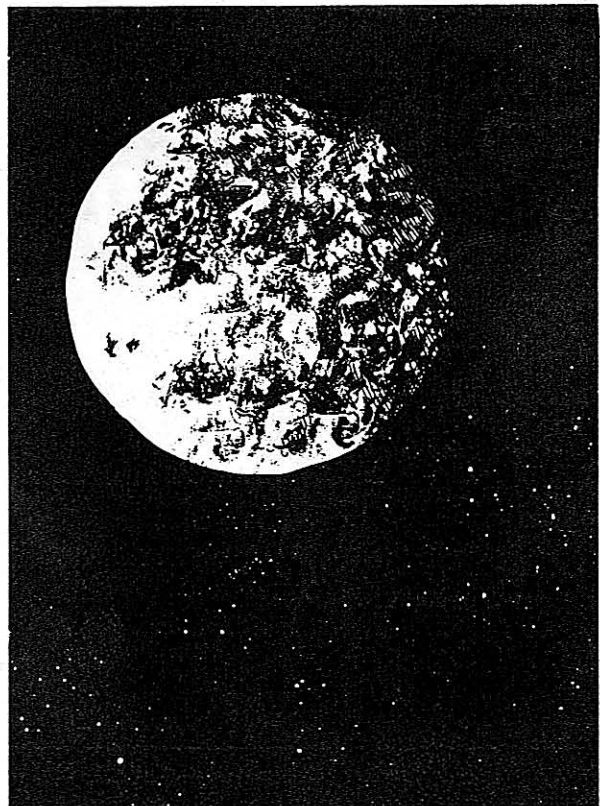

## World Log: THISISIT

### System Data

System Name: Sinnaway  
Map Coordinates: (11.3 S 6.7 E)  
Number Of Class M Present: 1

### Planetary Data

Position In System: VI  
Number Of Satellites: 1  
Planetary Gravity: 1.1G  
Planetary Size  
Diameter: 14,300 km  
Equatorial Circumference: 44,000 km  
Total Surface Area: 561,000,000 sq. km.  
Percent Land Mass: 87%  
Total Land Mass: 488,070,000 sq. km.

### Planetary Conditions

Length Of Day: 27 hours  
Atmospheric Density: Terrestrial  
General Climate: Warm Temperate

### Mineral Content

Normal Metals: 47  
Radioactives: 26  
Gemstones: 6  
Industrial Crystals: 8  
Special Minerals: 9

### Cultural Data

Sociopolitical Index: 998653-98  
Planetary Trade Profile: CBCEDF/B(C)

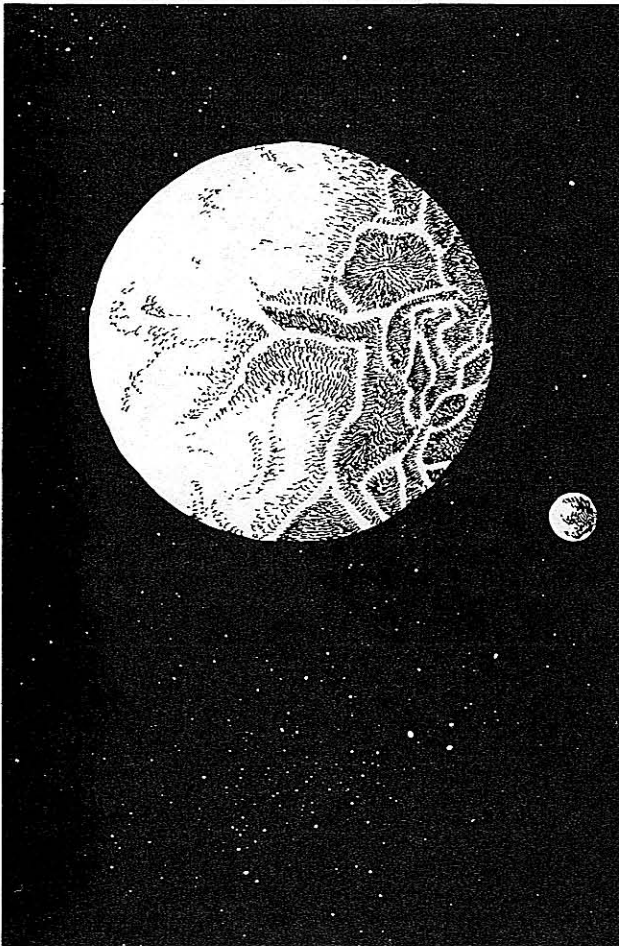

## OPERATION DIXIE

The bulk of the information in the *Operation Dixie Handout* is accurate, except where it has been necessary to make surmises based on the Federation's incomplete knowledge of what happened to the three Dixie ships.

### The Mole

The Klingon agent in *Operation Dixie* was Rashedi Mouhkta. He began as Communications Officer aboard the *Dixie Queen*, and then was transferred to the same post on board the *Dixie Lady*. Supposedly an Orion, Mouhkta is actually an extremely rare Klingon/Orion Fusion. Surgery has disguised the most obvious physical clues to his origins. To be even more sure, other Klingon agents in SFIC's Medical and Personnel sections made sure that there was no other evidence to suggest Mouhkta was anything but an ordinary Orion trader recruited for Intelligence work because of his familiarity with Klingon codes and operational procedures.

Mouhkta was planted in *Operation Dixie* before any of the principals really knew just what it was. The Dixie ships were made to warp out from base under sealed orders, and so it was only after they were underway that Mouhkta discovered the mission's goal. He realized he would have to make sure the goal remained out of reach, as Star Fleet could not be allowed to learn the secret of the Kinshaya.

Mouhkta possesses skills in *Engineering* specialties that do not appear on his service record, and these allowed him to sabotage the *Dixie Queen's* drive systems repeatedly to slow the freighter down while he began to work on a plan. The secrecy of the individual Dixie ship movements made betrayal of the entire operation difficult, and so Mouhkta bided his time.

The opportunity did not come until after the *Dixie Queen* had picked up the first bits of information on the Kinshaya frontier. Mouhkta very cleverly turned wardroom conversations toward the idea of calling for help in getting the data back to the UFP. Concern over the problems in Engineering and increasing evidence of the importance of the Kinshaya information led the Captain to make the decision Mouhkta was hoping for. He contacted the *Dixie Lady* and set up a rendezvous in which the two ships swapped identities so that the *Dixie Lady* could head back to UFP space while the *Dixie Queen* used nearby Klingon repair facilities before continuing the mission. Key personnel who would have to interact with the planetary authorities were exchanged between the two ships so that the deception could be more easily maintained. Mouhkta was one of them, but he left behind a computer-controlled bomb that would be triggered when approach data for the *Dixie Queen's* new destination was called up. The ship's destruction followed soon after.

Meanwhile, Mouhkta went to work once more on the officers of the *Dixie Lady*, subtly manipulating them to eventually advise the Captain to break silence and locate the *Dixie Princess*. Another rendezvous was arranged, and Mouhkta achieved what he needed: consolidation of the Dixie tapes from all three ships aboard his own vessel. He was able to provide a set of falsified communications codes to the Communications Officer of the *Dixie Princess*. Knowing that the ship must pass near Klinzhai, he was sure Imperial patrols would challenge and intercept it when these improper codes were given. The *Dixie Princess* was utterly destroyed by an over-eager Klingon ship captain.

That left the *Dixie Lady*. Mouhkta was cautious, and did not strike again for some time, except to sabotage the

ship's warp drive again to slow the freighter down and give him more time to plan. He wanted not merely to deny the Dixie information to the Federation, but to falsify it so that the UFP would not again contemplate an investigation. By this time, however, Intelligence Officer Arvan had become suspicious to the point of paranoia, and had locked out access to the material from all his shipmates. When Arvan went further and tried to transmit the information by subspace radio, he forced Mouhkta's hand. The spy had to act, jamming the transmission and then betraying the ship to the Klingons. His immediate aim had been foiled, but he quickly evolved a new one that would salvage his position.

#### The Dixie Information

The vitally important information gathered by Operation Dixie concerns an empire on the Klingon south-galactic boundary, which they call the *Komerex Kinshaya*. This territory has posed an increasing threat for about a century, and is a source of even greater concern to the Imperial government than is the Federation.

The Dixie tapes contain extensive data derived from Klingon sources on this mysterious interstellar power. The four officers originally from the *Dixie Queen* also know much of this information. However, the information has been classified under a Priority Red-Section 7 or 8 Top Secret heading, which means that only a select handful of SFIC people are permitted access to it. The tapes are set to wipe if replayed, and the officers are forbidden to reveal anything, under any circumstances, to anyone without the proper clearance. No member of the player-character party has the clearance necessary. In essence, the players will never have an opportunity to learn the Dixie information themselves. If the material is ever declassified, FASA will publish the material in other adventures or supplements.

#### THE KLINGON PLAN

Throughout the adventure, as the players think they are closing in on secret information that will hurt the Klingon Empire, they are actually playing right into the hands of a Klingon agent who has skillfully maneuvered events to help him deceive the UFP and score a major victory for Imperial Intelligence.

The plan is Mouhkta's. Realizing that he could no longer reasonably convey falsified Dixie reports to the Federation, the Klingon mole has now hatched a scheme worthy of a Thought Admiral. After the Klingons captured the *Dixie Lady*, he consulted with his superiors, who approved the plan. The ship and its captive crew were transferred to Marram IX in the Triangle. Then, the Klingon planted proof that Chief Engineer Koth was the real traitor. The Klingons carefully orchestrated things so that Koth would eventually be killed by the other prisoners, while Mouhkta remained among them. During frequent "interrogation" sessions (to which all of the crew were subjected), Mouhkta could put other aspects of his plan into operation.

The ship was sold to Richmond Enterprises. Mouhkta knew that the Mantiev Colonial Association would be swarming with Star Fleet agents, and that Richmond's traffic in rebel supplies would eventually attract notice to the freighter. Sooner or later, its origins would be discovered, possibly helped along by discreet rumors Mouhkta would eventually plant to help tip them off. The survival of the *Dixie Lady* would lead the SFIC, through Richmond, to Marram IX, while the falsified computer files on board would be sealed under Mouhkta's retinal patterns. If his fellow agents in the UFP had done their jobs, however, these prints would

be wiped from Star Fleet records. Star Fleet would be forced to rescue Mouhkta, whose revelation of the Dixie information would put him back in a position of trust inside Star Fleet Intelligence as a completely unsuspected mole.

The only member of the crew who could gainsay this was Arvan, the erstwhile Intelligence Chief who has been separated from the rest of the prisoners and subjected to much harsher treatment than his comrades. Arvan made copies of the Dixie tapes, which he hid somewhere on board the *Dixie Lady* before the takeover. Where these are no one knows, but their discovery could be embarrassing. Arvan has been kept isolated from the other prisoners, and so would not be rescued. Eventually, when he cracked, the Klingons could take steps to ensure the UFP never found those tapes. Their existence did not slow down the plan, however. Speed was essential to keep the Federation from mounting a new, better-screened version of Dixie. It was sheer luck, as far as Mouhkta was concerned, that the *Dixie Lady* was spotted so quickly. Once that happened, events moved inexorably forward.

#### RICHMOND ENTERPRISES

Richmond Enterprises, though involved in many shady deals, is a dupe of the Klingon Empire in Mouhkta's plan. No one at Richmond knows more than what is revealed in the various sections of *In Search Of Dixie*.

Background data on the company is given below. A second computer search on Richmond Enterprises will yield this information to the characters in the form of a Corporate Profile.

**Name:** RICHMOND ENTERPRISES

**UFPSC Symbol:** RicEnt

*Home Office Location:* DeLeone's Landing, Thisisit

*President/CEO:* Donald Richman

*Chartering Organization:* UFP Securities and Exchange Commission

*Founding Date:* 2/0109.11

**Stock Profile:** 4GG5

*Price/Date:* 32.86 Cr on 2/2301.01

*Dividend:* None

**Balance Sheet, Year Ended:** 2/2212

Cash	Assets	Liabilities	Ratio
46 MCr	917 MCr	1586 MCr	.58

**Business Summary:**

Richmond Enterprises is a trading firm whose operations have been severely disrupted by the civil war in the Mantiev Colonial Association. The nationalization of various ships and facilities in the MCA resulted in the seizure of three Richmond trading vessels, causing the company's fortunes to plummet.

Despite these setbacks, the trading firm has continued to operate in the Triangle. Frequent investigations by Star Fleet and by the UFPSEC have so far resulted in no convincing proof of wrongdoing, but suspicion of espionage and *sub rosa* violations of a variety of interstellar commerce laws have further damaged the corporate reputation.

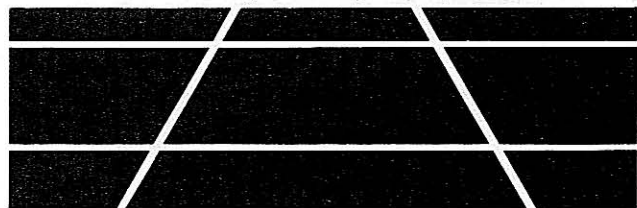



## PROJECT MINUTEMAN

The Klingon occupation of Marram IX in 2/1808 was not discovered by Star Fleet for some time. After two supply ships failed to return on schedule, an SFIC vessel posing as a free trader visited the system in 2/1906 and reported the Klingon presence. From information gathered, it became clear that the bulk of the colonists had surrendered after the initial Klingon attacks, while a few groups had scattered into the hills to mount a guerrilla campaign.

Klingon Sector Intelligence submitted a coherent plan for aiding the Marram IX colony, which was approved on 2/2003.18. The plan was named Project Minuteman.

Project Minuteman involved the infiltration of covert operations specialists onto the planet with weapons and supplies, with the intent of arming a large enough guerrilla force to temporarily overpower the Klingon garrison and steal transport ships to make good an escape. One of the key officers in the plan was Lieutenant Commander O'Mara, who was sent in with these teams to execute Project Phantom, to cover the escape of the refugees.

Unfortunately, the guerrilla bands have suffered heavily in each contact with Klingon marines, and there were very few new recruits after the Klingons instituted a policy of executing five senior colony figures for every colonist who failed to report on demand. Sheila Jones, leader of the colony, chose cooperation as the best hope for keeping her people alive. Some called it collaboration, and nicknamed willing Klingon supporters "sheilas". The Project Minuteman team of ten operatives remained on the planet, splitting into several parties to help individual guerrilla bands, but four have been killed and two others wounded, with no appreciable progress made toward executing the final uprising and escape plans.

## A RAY OF HOPE

Nicholas Tremaine shifted uneasily in his chair, then leaned forward against the briefing room table to study the data displays in the holographic chart tank. The presence of so much brass in the room—enough admirals and Commodores to give a Captain an inferiority complex—did nothing for his nerves, and rumor had it that Commander of Star Fleet would soon be arriving, too. Other rumors, hints that Tremaine himself would soon have the solid stripe of a Commodore, were almost equally unsettling. Tremaine didn't care about promotion, not now.

What he cared about most had already come to pass. Operation Dixie, years late and light years from its planned destination, had finally ended in success.

Commodore Ishimura, one of SFIC's specialists, interrupted the hubbub of voices. The waiting officers fell silent as he held up a slender cassette.

"Here's what we've been waiting for, gentlemen. This is the final briefing extract for Dixie. The detailed reports, of course, will be routed through proper channels as Analysis processes them, but this will give us a clue or two regarding the findings they made out there."

Ishimura strode purposefully down the row of chairs, stopping behind Tremaine. "Captain, this was your project," the Commodore continued, passing the cassette to him with a flourish. "Yours from first to last. Would you do the honors, sir?"

Tremaine looked down at the tiny plastic box that had cost so much to obtain. He turned it over in his hands, almost reluctant to carry on. At last, though, he slid it into the computer slot before him and sank back into his seat as the display glowed with the report heading: OPERATION DIXIE SUMMARY REPORT.

Admirals, Commodores, and a lone intelligence Captain watched as information, schematics, diagrams, and figures flashed before them. What they were seeing said more, though, than facts and figures could convey, for here was revealed the truth about the Klingons and their mysterious neighbors, the Kinshaya.

Tremaine was content. Dixie, for all its cost, had been worthwhile.

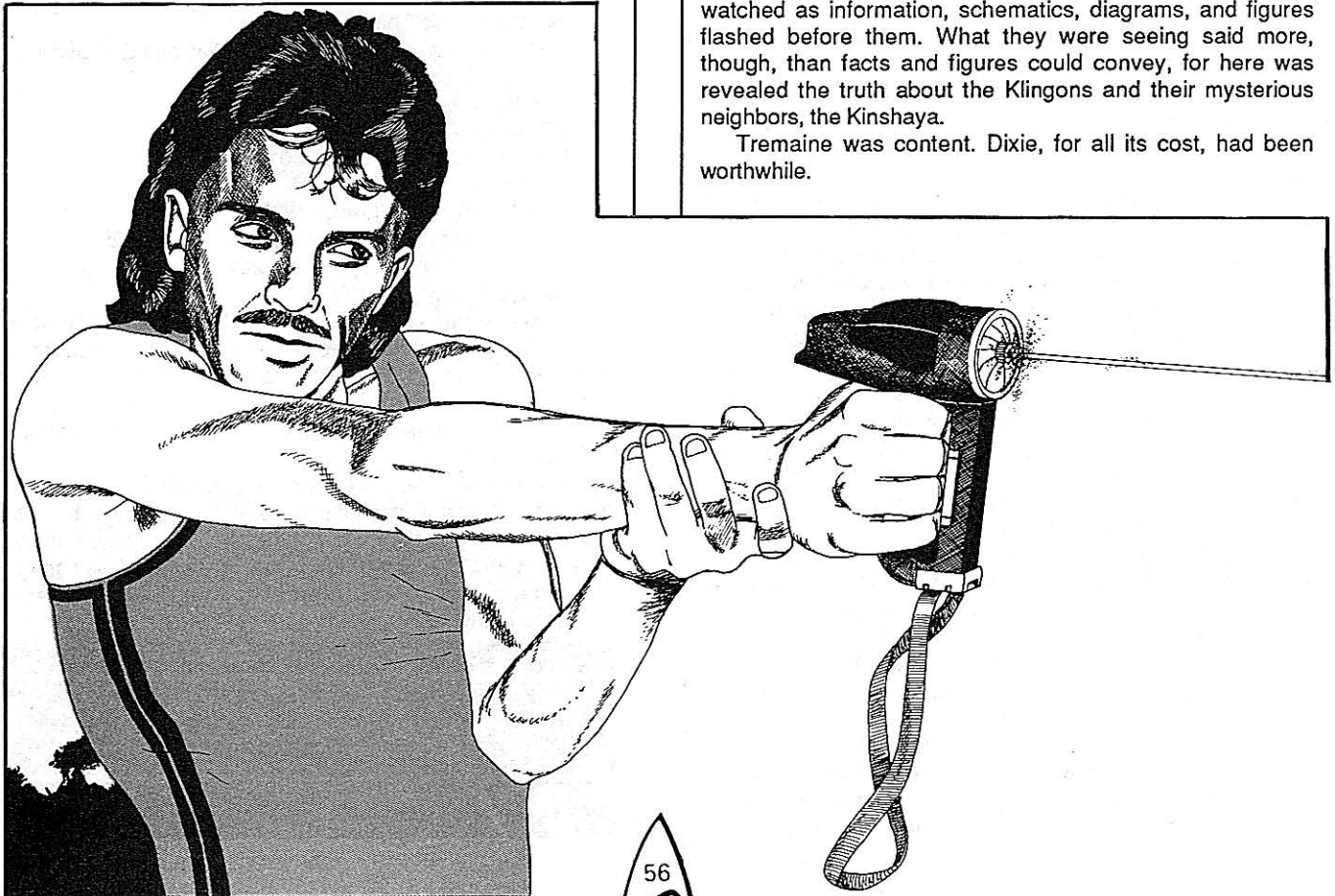

## OPERATION DIXIE . . .

These files describe the Federation's most ambitious Intelligence mission as "Lost-Presumed Destroyed." Three vessels, betrayed to the Klingons one by one, have been swallowed up behind the Imperial frontier, never to return.

Now the last of Dixie's ships has been spotted, owned by a shipping company in the Triangle, far from the place where it had presumably been destroyed. A crew of Intelligence Operatives has been given the crucial mission of discovering the fate of Operation Dixie and recovering the important data lost when the expedition failed.

But in the Triangle, things aren't always what they seem, and this is only the first move in a dangerous game of thrust and counterthrust . . . a move that leads to *The Dixie Gambit*.

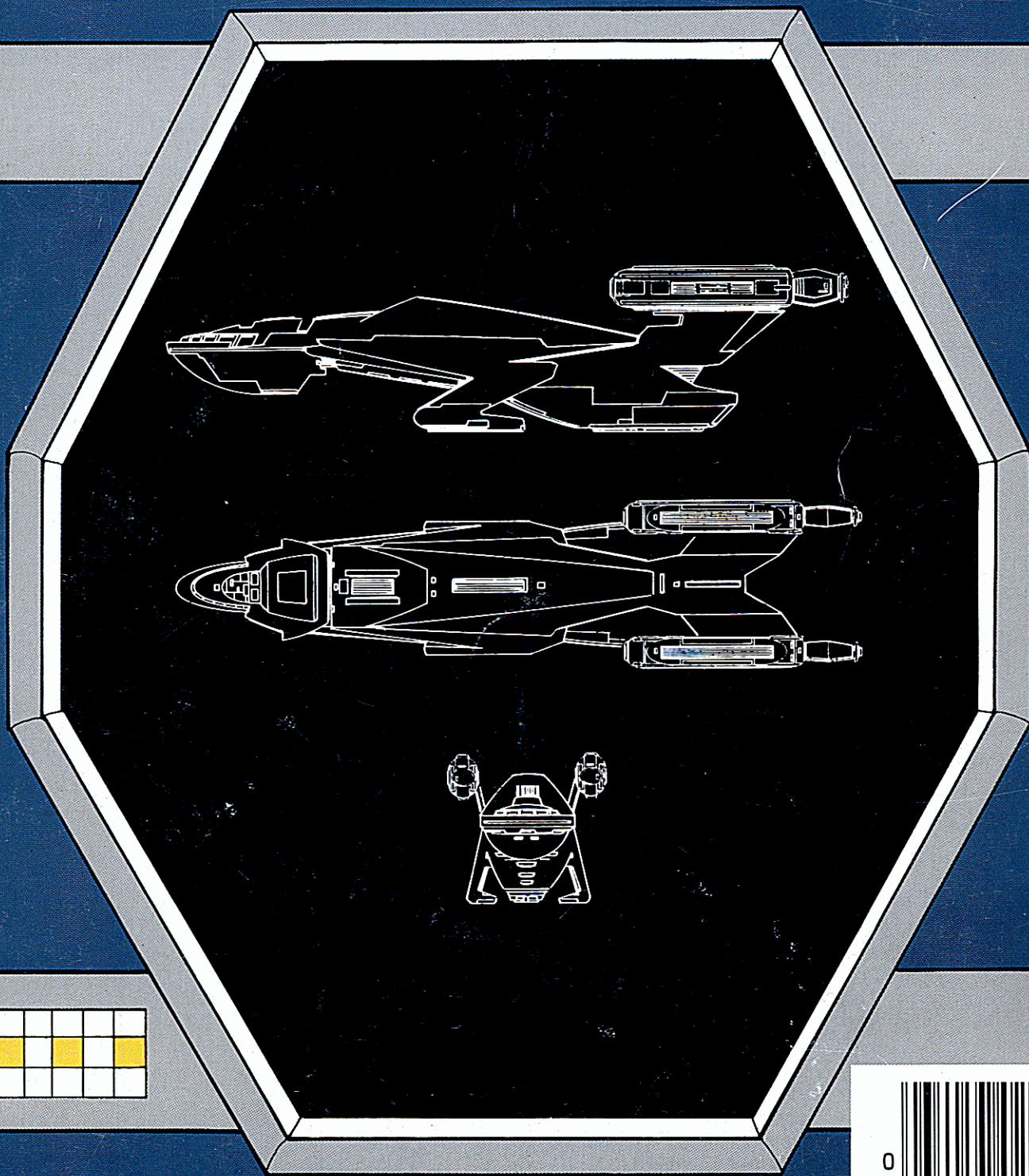



3 511

SENSORS: VISUAL  
344 88 060

# OPERATION DIXIE HANDOUT

# OPERATION DIXIE HANDOUT

This section contains all the information on Operation Dixie known to Federation authorities as of 2/2301.

## MISSION PLANNING

Initial plans for "A Deep-Probe Intelligence and Reconnaissance Mission Into Imperial Klingon Space" were filed with the Chief of Star Fleet Operations by Star Fleet Intelligence command on Ref. Stardate 2/1408.12. The original plans called for five primary and ten support ships disguised as Klingon and Orion trade vessels to make a sweep through the Klingon Empire. Their aim was to analyze starship production and deployment levels at various key Klingon worlds; to gather information on conditions on the far Klingon frontiers; to confirm or deny persistent rumors of another major power hostile to the Empire in that region. The plan was given preliminary approval by Admiral Nogura and returned to the Intelligence Command for refinement and further study. As 2/1901 was the earliest practical date for mobilization of sufficient ships and manpower for an undertaking of this scope, that was the tentative launch date for the project.

## INTER-SECTOR RIVALRY

Rivalry exists between the various sectors of Star Fleet Intelligence, particularly between that of the Klingon and Romulan Sectors. When word of Operation Dixie reached Romulan Sector Intelligence, they decided to launch their own deep-probe mission of Romulan capabilities and deployment centers. The mission was named Project Grey Ghost and was roughly contemporaneous with Operation Dixie.

When Klingon Sector Intelligence got wind of Grey Ghost, it stirred their own sense of rivalry. Work on the Klingon deep-probe mission was stepped up, and code-named Operation Dixie in 2/1506.6. Performance in the Operation Dixie and in Grey Ghost Projects became something of a contest between the two sectors, with each trying to produce better results faster.

Commodore Vincent Loomis, head of Star Fleet Intelligence during this period, felt that an immediate effort would be needed to assert SFIC's usefulness in the present Star Fleet hierarchy, and seized on the Klingon deep-probe mission as the ideal vehicle for such an attempt. Work on the plan was stepped up by order of Commodore Loomis on 2/1506.06, when the code-name Operation Dixie was adopted for the scheme.

## FINAL PLANS

The accelerated schedule for Operation Dixie resulted in major changes in the original proposals, so that the final orders for Dixie showed a significantly lower commitment of resources to the project. The objectives of Dixie, however, were even more ambitious than those approved by Nogura in 2/14.

The final version of Dixie was approved on Ref. Stardate 2/1610.24. The orders for the mission were transmitted from San Francisco that same day. Although the earlier proposals had been less concrete, they were better-reasoned.

Operation Dixie would make use of three primary and four support vessels. The primary ships were captured Klingon freighters, all of them G-8 Class IV vessels given false documentation as vessels sold by the Empire to various Orion trading concerns. Crews selected for these vessels included Orions and a number of Klingon/Human Fusion renegades in Star Fleet service. Each ship was to carry a crew of 24 and 6 'passengers' (who would go through elaborate identity changes after each port of call). These passengers, plus the crewmen who were assigned to cargo-handling, procurement, and communications duties, were charged with the principal intelligence activities, while other ship's personnel were responsible for ordinary starship operations and the maintenance of a solid cover identity. Known only by registry numbers to the Klingons, the three ships were carried on Star Fleet books as the *USS Dixie Queen*, the *USS Dixie Princess*, and the *USS Dixie Lady*.

The four support ships included one Klingon warp-shuttle, two Orion blockade runners, and a captured Klingon gunboat. These vessels were not to make any direct contact with Klingon worlds, but were to operate along the Imperial frontier in hopes of being able to make periodic contact with the Dixie primary ships for transmission of data back to the Federation prior to the end of the actual operation. Though support ships were always envisioned as a part of Dixie, the SFIC's desire to show quick results led to a relaxation of ordinary covert operations communications protocols so that frequent and (possibly) impressive information returns could be turned in throughout the projected five-year Dixie mission.

Operation Dixie was to be launched on Ref. Stardate 2/1702.15, when the three primary ships were to set out. The *USS Dixie Lady*, based at Star Base 27, was to slip across the Organian Treaty Zone. Its intended destinations were Runan, Kran, Jit, Gnuu Re', losia, Taamar, Veska, and then back to Star Base 27, the whole sweep to occupy the five-year mission period. One support ship, a captured Klingon warpshuttle, was assigned to work with the *Dixie Lady* during the early portion of the mission. The primary purpose of this phase of Dixie was to develop information on shipbuilding capacities and fleet deployments in the Imperial core.

Both the *Dixie Princess* and the *Dixie Queen* were to be based at Star Base 12 in Orion space. Each was assigned one Orion blockade runner as backup, as these ships were usually tolerated by authorities in the Klingon-dominated Orion worlds. The itinerary of the *Dixie Princess* included Mastocal, Kroja, Taamar, Karganth, Mustaka, Vero, Kaskal, Zonar, and then back toward the Federation. Meanwhile, the *Dixie Queen* would visit Veska, losia, H'Renn, Kodal, Nissa, Oran, Trang, Gnuu Re', and so back toward UFP space. The primary purpose of each of these voyages was twofold: first, to closely investigate the major Klingon bases and shipyards at Taamar, Karganth, and losia (which would be double-checked by the *Dixie Lady* on its return leg), and second, to scout the far boundaries of the Empire for information on the alien power believed to lie in this region. If necessary, the captains could alter their routes. Though communications among the Dixie ships was discouraged, it was officially approved if circumstances warranted such contact.

A seventh ship, a captured gunboat manned by a Klingon/Human Fusion renegade crew, was assigned as a special Dixie support ship, with authorization to probe more deeply into Imperial Space than any of the other support ships. Posing as a navy vessel, it could legitimately order the stop-and-search of freighters, and thus would serve as a physical link among the Dixie ships (and back to the Federation) at need.

By the time the final orders were issued, all Dixie preparations were complete, the ships and crews assembled and ready to go. It was later determined that the accelerated schedule for the mission resulted in a series of shortcut measures in the screening of personnel and in the establishment of preliminary information sources and cover materials. Where the first deep-probe plans had called for major contacts among the Klingon Orion Colonies and the prior operation of Dixie support ships among these colonies for at least a year to establish an ongoing presence, the final Dixie orders sent the support ships in only two weeks ahead of the primary mission with covers that would prove quite inadequate. Similar shortcuts were found at almost every turn. Indeed, the ultimate betrayal of Dixie by a Klingon agent aboard one of the Dixie ships was probably due to the poor job of screening operatives assigned to the mission.



## EXECUTION

The three ships of Operation Dixie left their home bases precisely on schedule. In the first month of the mission, however, two of the four support ships were lost. The warpsuttle attached to *Dixie Lady* blew up under mysterious circumstances (sabotage suspected, but never conclusively proved), while Klingon border patrols intercepted and destroyed one of the Orion blockade runners in an apparently coincidental tightening of security in the Klingon Orion colonies. The Operation Coordinator, Captain Nicholas Tremaine, was pressured from above to withdraw the other two support ships from active participation almost immediately, although on his authority he later released the gunboat for duty across the border.

By Ref. Stardate 2/1808, Operation Dixie had begun to bear fruit. The *Dixie Lady*, having reached Jit, was able to relay much useful information on Klingon ships and shipbuilding to the support gunboat, while the *Dixie Princess* sent back reports by way of agents already in place concerning the Karganth/Taamar naval complexes. According to incomplete reports, it was on 2/1808.30 that the captain of the *Dixie Queen* exercised his discretionary orders to contact *Dixie Lady* and suggest a change in plans. The two ships altered course to rendezvous in deep space in the middle of the triangle formed by Fonawl, Gnuu Re', and Kodal.

The exact reasons for this are uncertain. However, Captain Vorath's final report suggested that Captain Abkir of the *Dixie Queen* had obtained extremely urgent information concerning the race neighboring the Klingons on the far border, but was concerned over repeated mechanical malfunctions aboard his ship. Vorath and Abkir consulted face to face and made a fateful decision that altered the Dixie plan dramatically. Exchanging several passengers and crew members at their rendezvous in 2/1907, the two ships also swapped identities and missions. The *Dixie Queen*, still suffering from engineering problems, was to head for Gnuu Re' to keep the *Dixie Lady's* original itinerary. The malfunctioning drive system would explain the ship's late arrival and would also give the *Dixie Queen* an entry into the Klingon shipyards for closer observation of their spacedock capacity. The *Dixie Lady*, meanwhile, would head back to the Federation at maximum warp to deliver information considered too sensitive for subspace radio transmission.

On Ref. Stardate 2/1908.13, the *Dixie Queen*, en route to Gnuu Re', broadcast a brief Mayday signal and then abruptly ceased all transmissions. Intercepted Klingon subspace radio traffic later reported the complete destruction of a Type G-8 freighter in a matter/antimatter explosion of unknown cause.

On Ref. Stardate 2/2004, Captain Vorath, concerned over the loss of the *Dixie Queen*, broke radio silence and contacted the *Dixie Princess*, then on course for Mustaka after a lengthy delay at Karganth. The vessel's Captain Genth had uncovered information that reportedly confirmed and extended the *Dixie Queen's* original findings. Once again, the decision was made to rendezvous, and the meeting took place in deep space near Zonar on Ref. Stardate 2/2011.07. Another major change in plan was decided. The *Dixie Princess* transferred information and personnel over to the *Dixie Lady*, and then headed for H'Renn and Gnuu Re', intending to investigate the loss of

the *Dixie Queen* before resuming its patrol of the frontier region. The *Dixie Lady*, meanwhile, continued with the plan to return to UFP space with the data collected by the other two ships.

Intercepted Klingon messages reveal that two Imperial battle groups operating out of Klinzai intercepted an unauthorized freighter after it failed to give the proper recognition codes on being challenged. The freighter was reported destroyed in combat, but all reports confirm that it was almost certainly the *Dixie Princess*. This occurred on Ref. Stardate 2/2106.18, but word did not reach the *Dixie Lady* (which had been delayed by a series of engine failures) until it was near Kroja on 2/2201.26.

Now utterly convinced that the ill-fortune stalking the ships of the Dixie fleet was NOT accidental, Captain Vorath broke subspace silence with a direct transmission to Star Base 12, despite the risk of interception. The message summarized events up to that time, and gave Vorath's opinion that one of his crew was an agent in the employ of the Klingons, though he had no evidence against anyone in particular at the moment. He requested a rescue mission to assist the *Dixie Lady* in winning free of Klingon space, and went on to begin the broadcast of the data tapes made on board the last two ships. However, Star Base 12 communications operators reported that jamming, evidently near the source of the *Dixie Lady's* signal, made all but the first few seconds of the data tape transmission unreadable.

Although the Dixie support gunboat was sent to hunt for the *Dixie Lady*, no trace of the ship was ever found, and there was no report of the freighter's fate from Klingon sources. All Dixie personnel from all three primary ships are listed as "Missing in Action" due to the uncertainty surrounding their fates.

## AFTERMATH

The Dixie fiasco, which came on the heels of the Romulan Sector's triumph with Project Grey Ghost, led to the replacement of Admiral Nogura as Chief of Star Fleet Operations by Randolph Morrow. Other staff changes resulted in the reassignment of James T. Kirk (a protege of Nogura's) to Academy Testing. Commodore Loomis received a courtesy promotion and early retirement, while the mission coordinator, Captain Tremaine, was censured and reassigned to the Triangle desk at Star Base 10. Later, at his own request, Tremaine was reassigned to active field duty as SFIC resident agent at Freeman's Port in the heart of the Triangle. This was a position of virtual exile that headed off threats of a renewed inquiry into Tremaine's handling of Dixie operations before and during the mission.



## OPERATION FERRET

The Investigation Board convened on Ref. Stardate 2/2206.12 to examine the records on Operation Dixie in an attempt to discover the traitor or traitors responsible for the loss of the Dixie ships has noted the following:

1. As the last vessel lost and the only ship in contact with all three Dixie vessels, the *USS Dixie Lady* is probably the point of contagion. Probability is 97.86 percent that one (or more) crewman on board at the time the ship was lost was, in fact, a double agent.

2. This does not rule out the possibility that one of the crewmen on board the *USS Dixie Queen* and later transferring to the *USS Dixie Lady* may have been the traitor. In fact, this is most probable, due to the similarities between the engineering problems suffered by these two ships prior to their disappearance.

3. Accepting this as a working hypothesis, the most likely traitors were Rashedi Mouhkta, Koth tai-Livoss, Arvan tai-Vinsar, and Astur vestai-Krinith, the only officers to serve on both ships all the way through Dixie.

4. The loss of the *Dixie Queen* and the *Dixie Lady* suggests that engineering skills were necessary for this sabotage. Koth tai-Livoss, Chief Engineer, and Astur vestai-Krinith, Security Officer, are most likely under this finding.

5. The loss of the *Dixie Princess* by a wrong recognition code transmission suggests tampering with either the computer or the communications system, implicating Rashedi Mouhkta, Communications Officer, Koth tai-Livoss, Chief Engineer (with communications training), or Arvan tai-Vinsar, Intelligence Chief (with full computer access).

6. These findings are not conclusive. They are based solely on extant service records and on circumstantial evidence, but the considered opinion of the board is that one of four officers, in the order of probability listed below, is the likely betrayer of Operation Dixie:

Chief Engineer Koth tai-Livoss	34%
Intelligence Chief Arvan tai-Vinsar	26%
Security Officer Astur vestai-Krinith	15%
Communications Officer Rashedi Mouhkta	15%
Person or persons unknown	10%



**SERVICE ROSTER  
OPERATION DIXIE**  
Approved Ref. Stardate 1701.30

**USS Dixie Queen**

Name	Position (Assignment)	Notes
Elizar Abkir	Captain	O, Q
Fendiri Mustanza	Helm Officer	O, Q
Aleer Kimmala	Navigation Officer	O, Q
Rashedi Mouhkta	Communications Officer	O, T1, L
Koth tai-Livoss	Chief Engineer	K, T1, L
Ristath Mohainost	Engineering Officer	O, Q
Arvan tai-Vinsar	Cargo Officer (Intelligence Chief)	K, T1, L
Astur vestai-Krinith	Purser (Security Officer)	K, T1, L
Roustan Dellornoth	Bridge Crewman	O, Q
Pashera Sulivar	Bridge Crewman	O, Q
Kaliphesa Allebar	Bridge Crewman	O, Q
Altise Maunahr	Bridge Crewman	O, Q
Masra vestai-Drioll	Gunner	K, Q
Kreen tai-Nversta	Gunner	K, Q
Caimar Rouhosa	Engineer	O, Q
Alemir Bahrkandi	Engineer	O, Q
Ahmri Niaziir	Engineer	O, Q
Qamraz Zubeeri	Engineer	O, Q
Saveeda Kumalin	Transporter Technician	O, Q
Khava Nafeesud	Transporter Technician	O, Q
Morin tai-Vinsar	Cargo Handler/Steward (Field Agent)	K, Q
Anroth vesti-Lintron	Cargo Handler/Steward (Field Agent)	K, Q
Mirkif Harrid	Cargo Handler/Steward (Field Agent)	O, Q
Avolth tai-Kasall	Cargo Handler/Steward (Field Agent)	K, Q
Kornath vestai-Kenza	Passenger (Field Agent)	K, T1, T2, P
Green Korak	Passenger (Field Agent)	K, T1, T2, P
Minrath tai-Vregin	Passenger (Field Agent)	K, T1, T2, P
Amostai vestai-Rovir	Passenger (Field Agent)	K, T1, T2, P
Mreth tai-Grova	Passenger (Field Agent)	K, T1, T2, P
Karn vestai-Azith	Passenger (Field Agent)	K, T1, T2, P

**Notes:**

K - Klingon/Human Fusion  
O - Orion  
T1 - Transferred to *Dixie Lady*  
T2 - Transferred to *Dixie Princess*  
T3 - Transferred to *Dixie Lady*  
T4 - Transferred to *Dixie Queen*  
Q - Lost with *Dixie Queen*  
P - Lost with *Dixie Princess*  
L - Lost with *Dixie Lady*

Join the Official *Star Trek* Fan Club and receive the full-color Official *Star Trek* Magazine and Newsletter for a whole year!!

Send \$15.00-U.S., \$17.00-Canada, \$25.00-Foreign for 1 year membership to:

**STAR TREK**  
**THE OFFICIAL FAN CLUB**

P.O. Box 111000  
Aurora, Colorado 80011 U.S.A.

**USS Dixie Princess**

Name	Position (Assignment)	Notes
Genth Adissai	Captain	K, P
Ibranhai Taraja	Helm Officer	O, P
Farrookan Hakaam	Navigation Officer	O, P
Kenok tai-Ristam	Communications Officer	K, P
Azeishadik Muaddirin	Chief Engineer	O, P
Suramara Laihaba	Engineering Officer	O, P
Monax vestai-Dranth	Cargo Officer (Intelligence Chief)	K, P
Avrat tai Rougrim	Purser (Security Officer)	K, P
Roushvi Saayira	Bridge Crewman	O, P
Aminoghos Qarrinad	Bridge Crewman	O, P
Zarfada Homadou	Bridge Crewman	O, P
Jazarya Yeriamman	Bridge Crewman	O, P
Marna tai-Kethsed	Gunner	K, P
Mrain tai-Grontha	Gunner	K, P
Riadja Isadera	Engineer	O, P
Rudash Harazak	Engineer	O, P
Krant tai-Vistlak	Engineer	K, P
Tazeen Muvir	Engineer	O, P
Qanad Rouvalash	Transporter Technician	O, P
Irkac Ameerak	Transporter Technician	O, P
Greenak Dremessai	Cargo Handler/Steward (Field Agent)	K, T3, L
Zaikon Sigyarin	Cargo Handler/Steward (Field Agent)	O, P
Suvman Timoona	Cargo Handler/Steward (Field Agent)	O, P
Amrin vestai-Lorax	Passenger (Field Agent)	K, T3, L
Avox tai-Sannid	Passenger (Field Agent)	K, T3, L
Ahlen tai-Vresta	Passenger (Field Agent)	K, T3, L
Kreen vestai-Klinho	Passenger (Field Agent)	K, T3, L
Menax tai-Vroden	Passenger (Field Agent)	K, T3, L
Kirn tai-Kondro	Passenger (Field Agent)	K, T3, L

**USS Dixie Lady**

Name	Position (Assignment)	Notes
Vorath Msaikor	Captain	K, L
Nareesa Albarka	Helm Officer	O, L
Kallad tai-Narra	Navigation Officer	K, L
Karras vestai-Subrith	Communications Officer	K, T4, Q
Havreen Jumelkar	Chief Engineer	O, T4, Q
Mohaith Alamakirza	Engineering Officer	O, L
Kenga tai-Msaikor	Cargo Officer (Intelligence Chief)	K, T4, Q
Amrass tdai-Razath	Purser (Security Officer)	K, T4, Q
Immalla Saneekad	Bridge Crewman	O, L
Kethak vestai-Limbta	Bridge Crewman	K, L
Rouzhak Kandari	Bridge Crewman	O, L
Firin Azhabeth	Bridge Crewman	O, L
Morth ta-Hallur	Gunner	K, L
Medros vestai-Karak	Gunner	K, L
Yarist Navakom	Engineer	O, L
Haimul Roukaffan	Engineer	O, L
Jazzam Izraidka	Engineer	O, L
Amalkazeer Avrennan	Engineer	O, L
Tazadd Bohanglos	Transporter Technician	O, L
riadja Zobaiger	Transporter Technician	O, L
Arin tai-Rrad	Cargo Handler/Steward (Field Agent)	K, L
Andross Kenetha	Cargo Handler/Steward (Field Agent)	K, L
Kluthe tai-Droden	Cargo Handler/Steward (Field Agent)	K, T2, P
Roubillash Jaraila	Cargo Handler/Steward (Field Agent)	O, L
Arnen vestai-Donar	Passenger (Field Agent)	K, T4, Q
Klevas tai-Tr'teel	Passenger (Field Agent)	K, T4, Q
Kinrod Sainoth	Passenger (Field Agent)	K, T4, Q
Aloth tai-Verren	Passenger (Field Agent)	K, T4, Q
Miross vestai-Gron	Passenger (Field Agent)	K, T4, Q
Volkri tai-Amira	Passenger (Field Agent)	K, T4, Q

# LAST VOYAGES OF THE DIXIE SHIPS

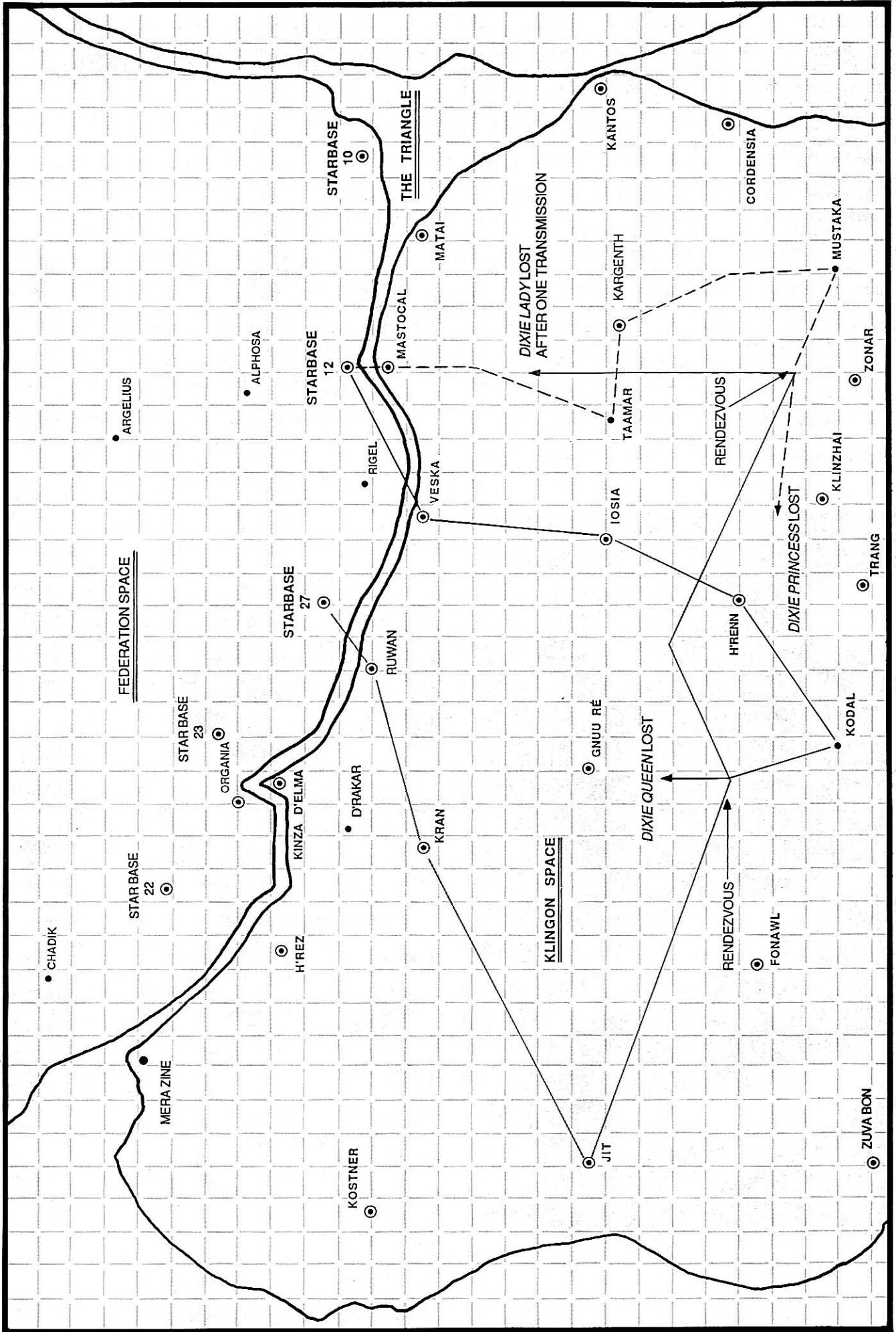

1 SQUARE = 5 PARSECS



# PLAYERS' BACKGROUND INFORMATION

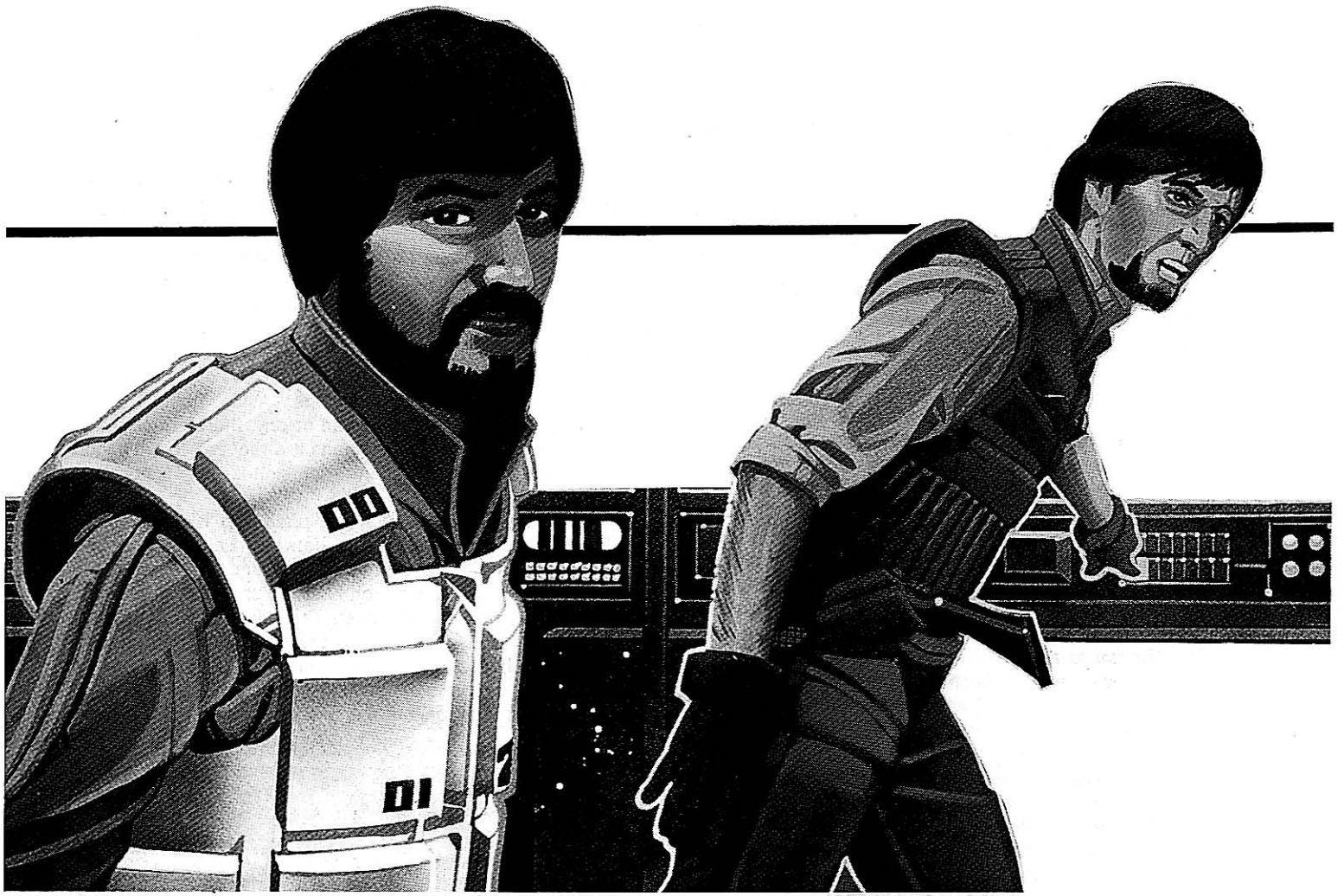

# PLAYERS' BACKGROUND INFORMATION

The following data entries are available through ship's computer files. Players may access the information through the names printed as headings.

## ETERNITY

Eternity is the third planet of Onza, a star inside the Klingon Empire at its border with the Triangle. Eternity was founded by a Human Jesuit priest and his followers who came into the Triangle region seeking religious freedom. Settling on this world, they discovered a mineral capable of curing some forms of cancer. They named it Eternium and traded it to support their colony's needs. The planet was later conquered by the Klingons, and the Human colonists perished.

Today, the Klingons control the planet and the Eternium. They continue to trade the mineral, but tariffs are high. The colony is self-supporting, but small. A flourishing black market exists on Eternity, as it does on most Klingon colony worlds.

## FREEMAN'S PORT

First planet of a star named Sivzunn, Freeman's Port is an independent world located in the heart of the Triangle near the edge of Romulan-controlled space and adjacent to the Mantiev Colonial Association.

This independent world is one large merchant's bazaar, with an extensive black market. Because it lies between the Romulan and Klingon spheres, goods from both empires are freely available here, although tariffs on incoming non-Romulan goods tend to be high.

Despite its proximity to the Star Empire, the Romulans have not yet molested the planet. The war in the Association has so far kept the Romulans too busy to be concerned with one small planet, although the 32 warp-capable vessels of the world's navy would be no match for a Romulan fleet. If the Romulans did become aggressive, the planet could expect little in the way of outside assistance. The Federation is too far away, and the Klingons are regarded with even greater distrust and fear than the Romulans.

The Freeman, as the world's Human inhabitants are generally known, are skillful negotiators, and have been doing their best to prove to the Star Empire that their planet is as useful to the Romulans as a free but willing trade partner as if it were a conquered tributary planet. Currently, they are attempting to reach an agreement involving the exchange of some of the planet's great mineral wealth for surplus Romulan warships. Progress is being made, albeit slowly. Some Romulan technology has already showed up on Freeman's Port, and a type F-2 orbital repair facility is in use there.

The planet's government is a participatory democracy in which voting on major issues via computer is mandatory for all citizens over 14 years of age. A representative structure elected by major interest groups handles routine governmental decisions.

## FEDERATION INTELLIGENCE OPERATIONS, TRIANGLE SECTOR

Federation Intelligence Operations are divided into ten sectors: Federation (Interior sectors Northeast, Northwest, Southeast, and Southwest), Klingon, Romulan, Orion, Triangle, Gorn, and Tholian. Triangle Sector Intelligence is responsible for all intelligence-gathering in the Triangle Zone and the worlds of the UFP, Klingon Empire, and Romulan Star Empire bordering this region. The sector is one of ten covering the whole of known space, and is under the auspices of the Star Fleet Intelligence Command. Its sphere of influence overlaps those of Klingon Sector Intelligence, Romulan Sector Intelligence, and Orion Sector Intelligence, all of which are expected to work closely together.

Major Triangle Sector Intelligence stations are maintained at Star Base 10 (headquarters of TSI), Outposts 1 and 2, Baker's World, and Remfrey. Most other independent worlds have one or more field agents attached on a more or less permanent basis, while trouble spots such as the Mantiev Colonial Association have a significantly larger assignment of agents.

## LANTOS

Fifth planet of the Agiirrat star system, Lantos is a world with a small percentage of land surface area. The Klingons recently occupied the colony, which was originally founded as a religious refuge by the Human followers of the Reverend Simpson. The Klingons have established (and are still expanding) a major military base on the planet, complete with six battle groups. Aside from a small contingent to control the Human colony, there are no major ground forces here. The Humans are required to grow food and mine radioactives and gemstones to support the Klingon presence.

Minerals mined here are shipped into Klingon space. There is no significant trade between Lantos and other worlds in the area, except as needed and approved by the Klingons. Reverend Simpson is still in control of the colony, under a Klingon commandant. The Klingons have found it necessary to use less force than usual in dealing with Simpson, because he and his people refuse to be intimidated and gladly accept martyrdom. The Humans provide forced labor, but the Klingons generally treat them quite well.



## MANTIEV COLONIAL ASSOCIATION

The MCA was originally formed as a league of four member planets (Mantiev, Chaniviev, Kallendeve, and Stork's Rest) in 1/25, primarily for mutual protection against larger aggressors such as the Klingons and the Romulan Star Empire.

Recently, civil war has broken out in the Association, a war that began as a Klingon-backed coup turned more serious when the Romulans stepped in to back the Loyalists. The Association has become a major hot spot in the Triangle, with advisors, hardware, and even some 'volunteer' military units from the two empires playing an active part in affairs. The UFP is attempting to play a peacemaking role in the dispute, but so far to no avail.

The sensitive nature of this region makes it of keen interest to the Federation, prompting Star Fleet Intelligence Command to keep observers and some active field units in the area. Klingon and Romulan covert operations are almost certainly equally active.

## MARRAM IX

Marram IX is the ninth planet of the Marram star system and another recent Klingon acquisition. The planet was previously settled by a Federation scientific mission studying the anomaly of a Type B star having life-bearing planets. The anomaly seems to be the result of tampering by the Preservers several millennia ago, as in the case of Rigel and other, similar worlds. The Preserver link also interests the Romulans, whose pseudo-religion is based on a Preserver heritage.

Marram IX, however, was conquered by Klingon forces who easily overcame the Human scientific team at work there. Those colonists not killed immediately in the Klingon occupation have been allowed to survive as workers, restricted to a small area of the planet and forbidden off-world travel or contact. Because of the planet's proximity to the Romulans, the Klingons are concentrating on the rapid construction (with the assistance of Human labor) of a large military base. Three battle groups are reportedly stationed in the city, together with both ground and orbital ship repair facilities.

Imports are limited to subsistence items for the colonist laborers, whom the Klingons consider little more than bargaining chips in talks with the Federation. The Klingons import the usual supplies needed to support the garrison. The black market, usually a major operation, is limited by the strict policies of the Klingon military governor, Klinmar. As trade is almost non-existent, tariffs are non-existent.

Sheila Jones, leader of the Human colony, is believed to be collaborating with the Klingons to ensure the colony's continued survival. Reports indicate an increase in Klingon activity in the last year, after the arrival of Admiral Kolath as senior battle group commander. Though a Klingon/Human Fusion, Kolath stands high in the Klingon naval hierarchy, and is known as an energetic and competent officer.

## MRAARDA

Ninth planet of the Sanurna system, Mraarda lies in Klingon space at the edge of the Triangle. The planet has a unique ecology that has made it a world-wide rain forest. There are no free-standing bodies of water of any significant size. Large, mossy trees absorb rain as it falls, with excess moisture evaporating again to continue the cycle. This may not always have been the situation (signs of sea-beds, since swallowed up by rain forest, have been discovered), but further investigation is impossible, due to the Klingon presence.

Mraarda is mineral-rich, and the Klingons have turned it into a prison planet to provide the work force needed to strip it of its resources. The "Work Project," as the Klingons call it, is supervised by the ruthless ex-Admiral K'Zinh, deposed and reassigned here some years ago. He runs a tight security net, with an excess of guards. There have been no successful escapes from Mraarda.

Trade is limited. The workers grow food locally, and mined resources are mostly shipped back to Imperial space. However, manufactured goods, particularly technical equipment, are imported (prisoners are not allowed to have a hand in any form of high-tech production, for obvious reasons). Like most Klingon military governors, K'Zinh is not overly concerned about the source of such goods. However, trading ships are subjected to close scrutiny to avoid attempted prison breaks.

## NEW PARADISE

Fifth planet of the Sanomar star system, New Paradise was colonized by the UFP, but declared independence once self-sufficiency was in sight. They are an open planet, trading freely with everyone. Trade agreements with both the Romulans and the Klingons have kept each power at arm's length. Both empires also have on-planet embassies, and neither feels a need to alter the balance of power. This is fortunate, as neither the eleven *Scout*-type ships of the New Paradise 'navy' nor the equally small ground forces could do very much against a determined enemy.

Tariffs on New Paradise are either very low or non-existent, especially for high-tech merchandise. The Lenfft Corporation, producers of power generators and heavy-duty batteries, is based here, and its products are a major part of the planetary exports. Radioactives are plentiful, and dilithium is present (though not abundant). Both of these furnish a solid base for a flourishing black market.

New Paradise is a democracy, with major issues settled by a vote of all inhabitants of legal age.

## OPERATION DIXIE

See the **Operation Dixie** handout for a detailed summary of this ill-fated SFIC operation.

## PROJECT GREY GHOST

Project Grey Ghost was a major intelligence operation mounted by the Romulan Sector of SFIC. Running from Ref. Stardate 2/1708 through 2/2206, it was roughly contemporaneous with Operation Dixie. Like Dixie, its purpose was to gather intelligence on the capacities, commitments, and deployment of forces of the Romulan Star Empire. Unlike Operation Dixie, Project Grey Ghost was an unqualified success that brought back much important new information on the nature, the organization, and the threat capabilities of the Romulans.

## RICHMOND ENTERPRISES

Richmond Enterprises is a shipping line operating in the Triangle. Founded in 2/0109 by James Richmond, the corporation is a privately-held firm that transports goods throughout the Triangle and beyond. Authorities of the UFP have investigated Richmond Enterprises five times in the past six years for suspected involvement in smuggling, espionage, and other illegal acts. The most recent occasion was related to the transport of Klingon war materials into the Mantiev Colonial Association at the start of the civil war there. The company maintains several lucrative contracts with Klingon authorities along the frontier, but appears to be innocent of any actual wrongdoing beyond poor taste in business associates.

## STAR FLEET INTELLIGENCE COMMAND

A branch of Star Fleet and subordinate to the Office of Star Fleet Operations, Star Fleet Intelligence Command is responsible for gathering, processing, and disseminating information that affects the security, planning, or policy of UFP forces throughout the Federation. Originally, SFIC carried out not only ordinary intelligence, counter-intelligence, and espionage activities, but also a variety of other functions not ordinarily part of the duties of any other Star Fleet branch or department.

The Intelligence Command is broken into three divisions: Administration, Plans and Policies, and Operations. Each division is headed by a Deputy Chief, who reports to the Chief of Star Fleet Intelligence Command. The Operating Forces of SFIC are divided among ten sectors that cover, among them, all parts of explored space, both within the UFP and in adjacent stellar empires.

Still recovering from the shakeup following the fiasco of Operation Dixie, the SFIC is in a period of flux and considerable uncertainty with regard to its ultimate role in Federation affairs.

## THISISIT

Sixth planet of the Sinnaway star system, Thisisit was discovered many years ago by Simone DeLeone, an explorer commissioned by the UFP-based Hathaway Foundation to locate an above-average Class M planet. He exclaimed, "This is it!" on seeing the first sensor readings

for the new world, and that became the planet's legal name, at DeLeone's insistence.

Settled by Federation races and maintaining close relations with the UFP, Thisisit is still fiercely independent. A Federation ambassador who attempted to promote economic sanctions against the Klingons and the Romulans was once ordered to leave the planet for three months. The government vigorously pursues its own policies, and resists any outside interference in planetary affairs. The world's close treaty ties with the UFP have discouraged the Klingons and Romulans from too much interest in the planet, however.

Trade on Thisisit is open to any and all interested parties. Tariffs are kept low to encourage trade and to keep the technological level of Thisisit high. Despite this, the black market thrives, largely as a result of the world's location. Illegal arms, for instance, were channeled through the legitimate mercantile interests here to help equip both sides in the early stages of the civil war in the Mantiev Colonial Association. Both factions continue to acquire goods, particularly Federation and Klingon products, from Thisisit.

The democratic government of Thisisit is currently undergoing extensive changes due to the recent influx of large numbers of immigrants. For the moment, voting is restricted to those citizens who can prove a residency of five or more years on the planet, though there is considerable pressure for a change in these laws (mostly from the disenfranchised immigrants).

## TRIANGLE, THE

A region of space bounded by the United Federation of Planets, the Romulan Star Empire, and the Klingon Empire, the Triangle is a wedge-shaped zone of 120 worlds spanning an area (at its widest) 30 parsecs across and 48 parsecs long. All three major powers, plus four smaller states, own worlds within the Triangle. Many other planets are completely independent.

Called "The Golden Triangle" in some works of popular literature, the region has been likened to the American frontier in the days of its expansion, or the Asteroid Colonies in the early period of space travel. The Triangle is a wild, often lawless region where there are many opportunities for turning a profit. The presence of all three of the major interstellar power blocs also makes the Triangle a source of great danger, intrigue, and double-dealing.

