

A supplement for use with  
**STAR TREK**<sup>®</sup>  
THE ROLE PLAYING GAME

2005

# THE ROMULANS

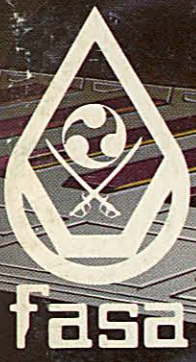
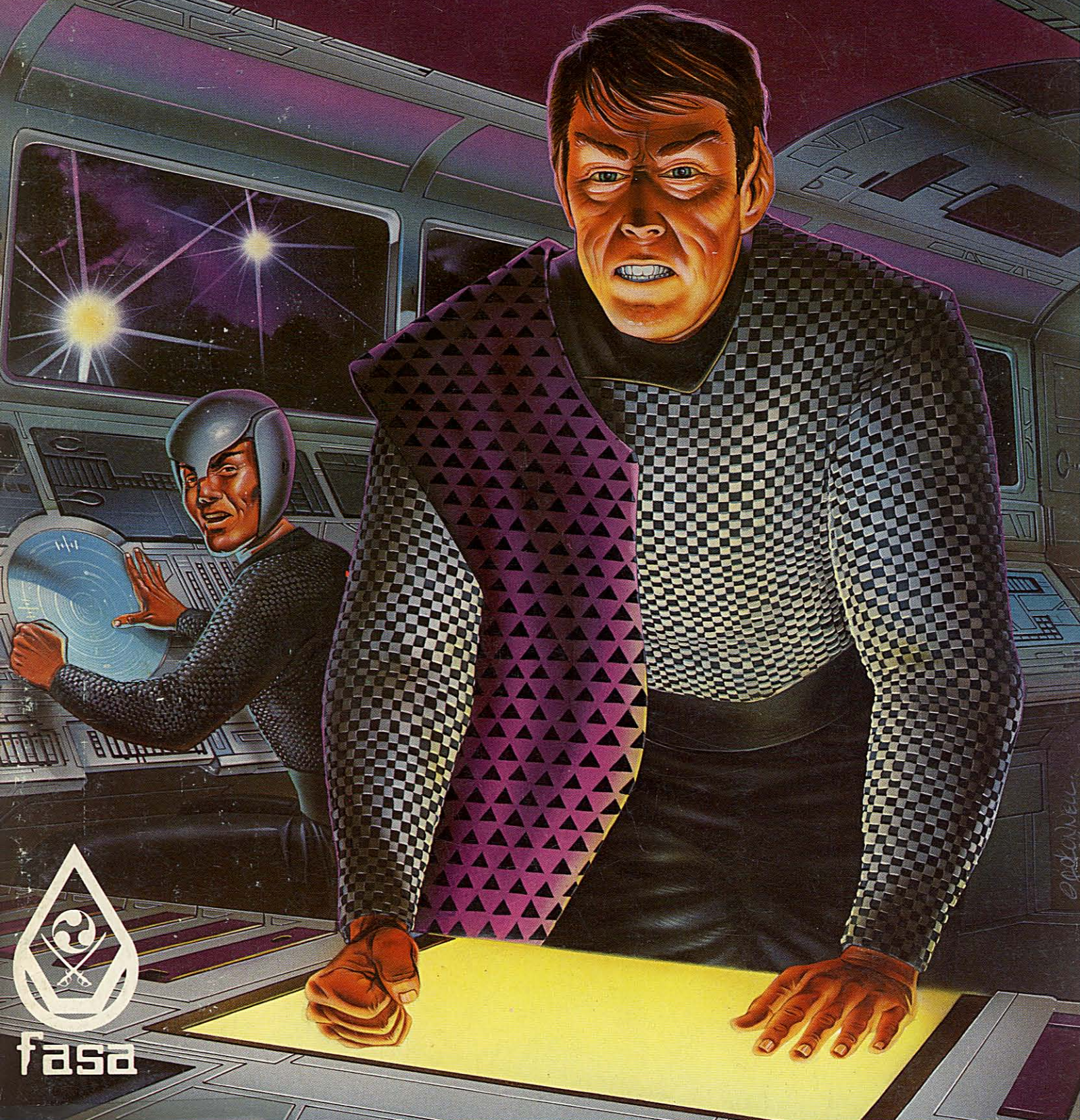

ISBN 0-931787-05-X

# STARDATE



Keep up with all that is happening in the *Star Trek* universe with **STARDATE**, the science fiction magazine for gamers and fans. Each monthly issue features articles on the ever-popular *STAR TREK: The Role Playing Game* and the *STAR TREK III Starship Combat Game*. Also contained in each issue are articles on other FASA games and games being developed. Sections include *Jaynz Ships of the Galaxy*, *Quartermaster Corps* (introducing all kinds of new equipment), *Ask Starfleet Command* (a question and answer column), convention schedules, movie reviews, and a complete adventure module for *STAR TREK: The Role Playing Game*. Stay informed on the final frontier with **STARDATE**. Available at better game, hobby and book stores throughout the galaxy.

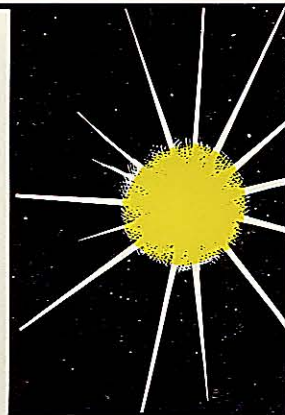

**UNITED FEDERATION OF PLANETS**

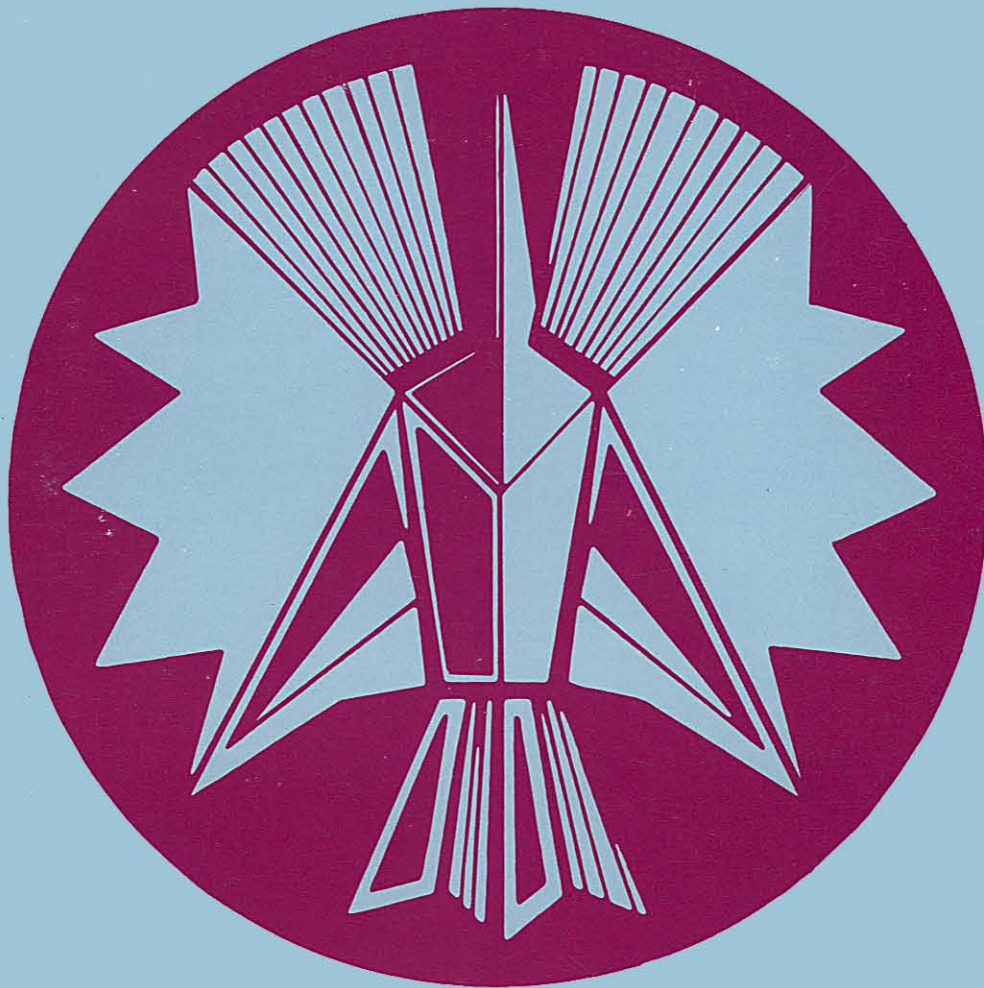

**THE ROMULANS:  
STARFLEET  
INTELLIGENCE MANUAL**

**STAR TREK<sup>®</sup>**  
THE ROLE PLAYING GAME

# Table Of Contents

<b>INTRODUCTION</b>	3
<b>Officers' Orientation Briefing</b>	3
<b>The Eridam Papers</b>	3
<b>Glossary Of Romulan Terms</b>	4
<b>Language</b>	5
Notes On The Romulan Language	5
<i>Nouns And Adjectives</i>	5
<i>Galacta Equivalents Of Romulan Names</i>	5
<i>Individual Names</i>	5
Pronunciation Guide	5
<i>Glottal Stop</i>	5
<i>Voiced Capitals</i>	5
<i>Pronunciation Key</i>	5
Dictionary Of Spoken Romulan Terms	6
<b>THE ROMULAN STAR EMPIRE</b>	7
<b>History And Time Line</b>	7
Pre-History And The Vulcan Heritage	7
<i>Body Structure</i>	7
<i>Environmental Influences</i>	7
<i>Seeding By The Preservers</i>	7
Environment's Impact On Culture	7
Time Line Of Major Events	7
<b>The Romulan Home System</b>	11
Planets In The Home System	11
<i>Romulus</i>	11
<i>Remus</i>	11
Life Forms	11
Guide To Romulus And Remus	12
<b>Extents Of The Star Empire</b>	13
Romulan-UFP Border: The Neutral Zone	13
Romulan-Klingon Border	13
Romulan-Gorn Border	13
The Triangle	13
<b>Interstellar Interactions</b>	15
Gorn Alliance	15
Klingon Empire	15
United Federation Of Planets	16
<b>THE ROMULAN PEOPLE</b>	17
<b>Personality Traits</b>	17
<b>Romulan Psionics</b>	18
<b>Religion</b>	19
<b>Stages Of Romulan Life</b>	20
<b>Government</b>	21

<b>THE ROMULAN IMPERIAL NAVY</b>	22
<b>Organization</b>	22
<b>Rank</b>	22
<b>Starship Recognition File</b>	22
<i>Bird Of Prey Class Light Cruiser</i>	23
<i>Stormbird Class Cruiser</i>	23
<i>Winged Defender Class Heavy Cruiser</i>	24
<i>Graceful Flyer Class Scout/Courier</i>	24
<i>Bird Of Prey Class Scout, Uprated Version</i>	25
<b>Romulan Starship Tactics</b>	26
<b>Typical Romulan Naval Officers</b>	27
<b>EQUIPMENT</b>	28
<b>Personal Equipment</b>	28
Antigrav	28
Communicator	28
Earpiece Receiver	28
Environmental Suit	28
ID Card	28
Image Recorder/Processor	28
Uniforms	29
<i>Rank Insignia</i>	29
<i>Salute</i>	29
Translator	29
Dueling Stick	29
<b>Medical Equipment</b>	29
Electronic Scalpel	29
Hypo	29
Medical Belt	30
Medication Pouch	30
Portable Power Supply	30
Protoplaser	30
Vital Signs Reader	30
<b>Sidearms</b>	30
Hand Disruptor, Klingon Mark I Design	30
Hand Disruptor, Romulan Design	31
Disruptor Rifle, Klingon Design	31
Wound Dressing Pads	31
<b>Shipboard Systems</b>	31
Beam Weapon	31
Cloaking Device	31
Plasma Bolt Weapon	32
Transporter	32

## THE ROMULANS

A supplement for use with *Star Trek: The Role Playing Game*

### Design:

*Fantasimulations Associates*  
David F. Tepool  
Guy W. McLimore, Jr.  
Greg K. Poehlein

### Development:

*FASA Design Staff*  
Wm. John Wheeler  
Forest G. Brown

**Writing:** Fantasimulations Associates

**Editing:** Wm. John Wheeler

### Production:

*Graphics And Layout*  
Dana Knutson  
Todd Marsh  
Jordan Weisman

*Illustration:*  
Norman Miller  
Dana Knutson  
Todd Marsh  
William H. Keith, Jr.

*Typesetting:* Karen Vander Mey

*Proofreading:* Donna Ippolito

STAR TREK is a trademark of Paramount Pictures Corporation.  
STAR TREK II: The Wrath Of Khan products are published by FASA Corporation under exclusive license from Paramount Pictures Corporation, the trademark owner.

STAR TREK: The Role Playing Game is published by FASA Corporation under exclusive license from Paramount Pictures Corporation, the trademark owner.

Copyright © 1984 Paramount Pictures Corporation  
All Rights Reserved  
Printed in the United States of America

No part of this book or the contents of the basic game may be reproduced in any form, or by any means without permission in writing from the publisher.

Published by FASA Corporation  
P.O. Box 6930  
Chicago, Illinois  
60680-6930

# Introduction

## OFFICER'S ORIENTATION BRIEFING

This sourcebook has been prepared to give line and staff officers a general overview of the Romulan Star Empire, the Romulan people, and the Romulan Imperial Navy. It is not intended to provide knowledge in depth; other manuals available from Star Fleet Intelligence cover that function. It merely provides enough background information that the average Star Fleet officer needs in dealing with the Romulans, long one of the most elusive of the Federation's interstellar rivals. From this background, an officer can expand his research in any direction that he chooses, though it must be cautioned that hard data on the Romulans is very scarce.

The structure of this book parallels that of other source books, and the information contained herein is similar. This introductory section gives information about *The Eridam Papers*, the major source of documentary evidence for the elusive Romulans. It also provides a glossary of Romulan terms and an overview of spoken Romulan language.

A section on the Star Empire provides information about its history, including a time line of such major events as are known at this time. It provides such information on the extent of the Star Empire as is currently known, including a map displaying this projected data. Such facts as are known about Romulus and Remus in the Romulan home system, including a translation from a Romulan tourist guide to these worlds. Essays on the interactions between the Romulans and the UFP, the Klingons, and the Gorn also are included.

The section on the Romulan people is a composite of various essays written by experts in their various fields; attempts have been made to balance the viewpoints so that no particular prejudice is shown. The Romulan personality, religion, life-style, and government are presented in capsule overviews that should provide a firm background for officers attempting to understand Romulans, though the scope of this book prohibits any detailed discussion.

The section on the Imperial Navy is perhaps the most important for officers seeing duty on the Neutral Zone. Military organization, rank and position, basic starship recognition and tactics, and a summary of the abilities of various Romulan Officers is presented. Notes on Romulan equipment also are included.



## THE ERIDAM PAPERS

On Stardate 2/1109.30, Federation scout vessels discovered a small research station that had been abandoned by the Romulans shortly before.

The 20- to 30-Romulan survey team was attacked by a virus, unknown to them but well known to Vulcans as LV-132. Three Romulans died, but the epidemic was brought under control with drugs and decontamination procedures. The Romulans left the base, destroying all material pertaining to the base's existence and leaving no clue about the nature of the research conducted there.

Nonetheless, the former base was a major find for the UFP, for a body of writings was recovered that has provided major insights about Romulan history, social structure, culture, religion and legends, and anatomy. Many personal diaries, children's books, works of fiction, and other non-military writings were recovered. Published as the *Eridam Papers*, they have become the core of the Federation's knowledge of Romulan life and history.

A half-destroyed child's anatomy text confirmed that the structure and function of the Romulan body is nearly identical to that of the Vulcans. Furthermore, references in some of the Eridam works were made to psionic development, but they confirm that Vulcanoid psionic disciplines are not practiced by Romulans.

A child's geography book revealed that the earliest settlements Romulan archaeologists have discovered are all on Romulus. There are 7 settlements in all, each established at the same time as the others. The settlements are located at what are today the city-states of Caranam, Portora, Kanasarum, Labasasz, Dinalla, Pulla'd, and Farrad, all confirmed as modern world leaders; remains of many of the walls surrounding the old cities can still be seen today, as evidenced by the photographs and drawings presented. The text indicated that the same tools and language were shared by the residents of these settlements, and argued that they were incontrovertible proof that people from the stars placed the earliest Romulans on the planet.

As an incidental note, the geography book also revealed that no native life forms similar to the Romulans have been found on either Romulus or Remus. It states that neither planet has seas with a high enough concentration of copper to have created such life forms.

Furthermore, a tourist guide to Romulus and Remus was found. Though its text obviously was produced for the tourist trade and thus the details in its text are suspect, the general information is likely to be valid. This comprises the only hard record of the Romulan home worlds. Based on the text, analysts have developed standard World and Civilization Logs for the Stelam Rom'Inz star system.

Other books deal with Romulan legends and myths, including the first Romulan to achieve the stars, a woman named S'Tanet. The descriptions of her exploits are so cloaked in legend that little, if any, information can be gained from them.

## GLOSSARY OF ROMULAN TERMS

### BIRD OF PREY

A species of bird native to Romulus, known for courage and ferocity. Two basic starship designs over the years have been called by this class name. The Romulan practice of painting stylized representations of carnivorous birds on their ships has led to the widespread use of the term to refer to any Romulan fighting starship.

### EDUCATION, THE

Romulan equivalent of elementary and secondary schools, college, and military school, attended by all Romulans between the ages of 5 and 20; one of the stages of Romulan life.

### ERIDAM PAPERS

The collection of Romulan writings, many written for children, found on the devastated colony at Eridam VII. Comprising fiction, history, and philosophy as well as personal diaries and family histories, these works offered many insights into Romulan psychology, social structure, and political structure. The edition most widely used in the UFP today is annotated by Spock of Vulcan and his protege Saavik.

### FAMILY GATHERING (Shrine)

Holy place maintained by each Romulan family, usually as a room of their house. It is here that communing with the gods takes place.

### GRAND SENATOR

Member of the 5-man governing council of any Romulan senate.

### GREAT BROTHERS

Romulan equivalent of gods, believed by the Romulans to be immensely powerful alien beings who first placed the Romulans on their homeworld, and instructed them to build a "road to the stars". The Romulans believe only that the gods hear their words and thoughts. They do not expect the gods to answer or take a direct hand in Romulan affairs, except perhaps to wish good fortune for their followers.

### GREAT COMET, THE

Military decoration for deeds securing new resources for the Star Empire.

### GREAT COMMUNING, THE

Romulan equivalent of prayer.

### GREAT DUTY, THE

Romulan compulsory military service; one of the stages of Romulan life.

### GREAT JOINING, THE

Romulan marriage; one of the stages of Romulan life.

### HONORABLE DEATH, THE

Death of a Romulan whose efforts in some way further the aims and goals of Romulan society, as opposed to the death of most Romulan citizens; one of the stages of Romulan life.

### NEUTRAL ZONE

Area of space between Romulan territory and that of the UFP, as established by treaty.

### PEOPLE, THE

Romulan citizens, especially members of the race left on Romulus by the Romulan gods.

### PRAETOR

Chief executive and presiding officer of a Romulan senate at any level. The equivalent post in the Imperial Senate would be called the Grand Praetor, or Emperor.

### PRESERVERS, THE

Ancient race believed by many scientists to be responsible for seeding many worlds with humanoid life forms similar to, and possibly genetically derived from, Terran Humans. The Preservers may be the historical basis for the Romulan gods. *Compare with GREAT BROTHERS.*

### REMUS

Common UFP name for *Rav's*, the sister planet of Romulus.

### ROAD TO THE STARS

Guiding philosophy and goal in Romulan society. Romulans believe that the first Romulans were directed by their gods, alien beings of immense power who transplanted the Romulan race to Romulus, to build a road to the stars. They believe that the gods themselves wait at the end of this road. The "Road to the Stars" is a symbol for Romulan expansion through the galaxy.

### ROMULAN

Common UFP name for the *Rom'Inz*, whose civilization developed on the planet *Rom'lasz*. Also, the language spoken by those people.

### ROMULAN CONFEDERATION

Original group of Romulan city-states, united on Romulus for the purpose of developing space travel. Later the confederation was altered to the Romulan Star Empire.

### ROMULAN STAR EMPIRE

The whole of Romulan-controlled or dominated space, including subject worlds and cultures, colonies, and outposts.

### ROMULAN WAY, THE

Lifestyle of a Romulan, as dictated by the discipline necessary to achieve their goals and fulfill their destiny by building a "Road to the Stars." Also, the body of common traditions and rituals that define this lifestyle.

### ROMULUS

Common UFP name for the Romulan homeworld, *Rom'lasz*.

### SENATE

Elected body, usually composed of 100 citizens, that governs Romulan life at any level, from individual city-states to the entire Star Empire.

### SHRINE

*See FAMILY GATHERING.*

### UNSEEN ONES

Romulan outcasts, stripped of rank, title, and family, who are not to be acknowledged in any way by any Romulan citizen.

### WEDGE, THE

Translation of the Romulan name for the Triangle.

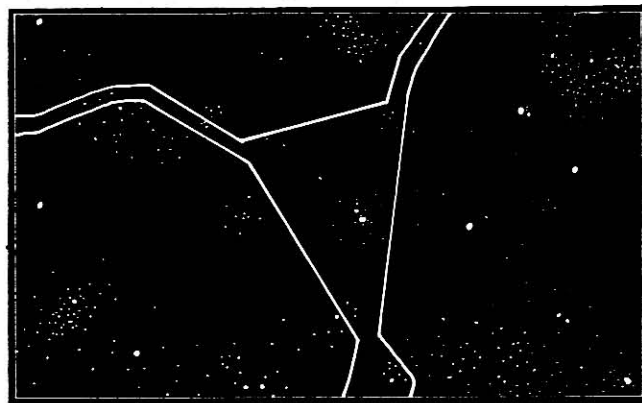

## LANGUAGE

The many intricacies of *Rom'lesta*, the Romulan tongue, are beyond the scope of this sourcebook, and the written form, either in the language's own symbols or in Galacta letters, is even farther beyond the limits imposed here. Instead, what follows is a short dictionary of common Romulan spoken terms, as well as those written words that find use in the accompanying source material. Included as well are notes on how *Rom'lesta* is constructed and pronounced. These will provide a quick reference to the Romulan terms used herein as well as insight into the culture that produced the language. All *Rom'lesta* terms book are written using the standard Federation alphabet for clarity and ease of pronunciation.

### NOTES ON THE ROMULAN LANGUAGE

#### Nouns And Adjectives

Regular singular nouns end in *-am*, and regular plurals end in *-i* or *-ri*; irregular forms vary. Adjectives sometimes merge with the word itself, but usually they follow the noun they modify. Thus, *safram* (senator) becomes *d'safram* (grand senator), but *safram Rom'Inz* (senator of the people or Imperial Senator).

#### Galacta Equivalent Of Romulan Names

The names *Romulus* and *Remus* are adaptations in Galacta of the true Romulan pronunciations, transliterated as closely as possible by an anonymous Communications Officer during the Romulan War, when all contact was by subspace radio. Romulans call themselves *Rom'Inz*, which literally means 'the People.' Their home planet is *Rom'lasz*, the 'home of the People,' and the language is *Rom'lesta*, 'speech of the People.' Even so, most Romulans themselves, when speaking Galacta or being translated into Galacta, say the Galacta words *Romulan* for the people or language and *Romulus* for home planet.

The companion planet of Romulus, called *Remus* by the Federation, is actually named *Rav's*, meaning brother. Federation translators couldn't resist the reference to the Roman legends of early Terran history. Early Federation intelligence incorrectly indicated the planet to be in a separate star system. This has been proved incorrect by more recent sources.

The Romulans believe that their elder gods placed them on *Rom'lasz* many, many years ago and instructed them to build a road to the gods' home in the stars. This idea shapes their thought and language in many ways. What the Federation calls the Romulan Star Empire is *Latasam Stelai Rom'Inz*, literally 'Star Road of the People.' The original city-states of the planet Romulus were gathered together to form the Romulan Confederation or *Bresasam Rom'Inz*, 'Gathering of the People.'

#### Individual Names

Given names are reminiscent of the Latin language of old Terra, such as *Desus*, *Lorimus*, *S'Tava*, *S'Lar*, or *Hamalanus*. There are no family names. The closest to that would be "Desus of the family of old Cavilis from the city-state Kanassarum."

Individual names may have prefixes and suffixes. The *-us* ending denoting strength is common, particularly, but not exclusively, for males. The *S'T-* and *S'L-* prefixes, denoting bravery and honor, are almost as common for both males and females. Place names, particularly city-states, often end in *-n* or *-asz*.

### PRONUNCIATION GUIDE

Whereas most *Rom'lesta* words are pronounced using standard and familiar vowel and consonant sounds, there are two significant differences between the Romulan tongue and spoken Galacta. The glottal stop, causing a pause or catch in the smooth flow of sound is the most important. It is also used to voice important words or give them special meanings, much like capitalizing them would in written Galacta.

#### Glottal Stop

Apostrophes are used in many Federation-standard spellings of Romulan words to signify a glottal stop as used in many Terran English-based languages. This speech sound is produced by an interruption in the breath stream by sharply closing the glottis. It is a full, sharp stop that is not voiced, much like the stop in sound heard just before the second *t* in the word *bottle*.

#### Voiced Capitals

In the Romulan language, capitalization is used for proper names of people, places, and institutions but never for titles and the like, except when trying to emphasize the importance of something. Thus, it would be *safram Desus* (Senator Desus) in normal use, but if the implication were that Desus was the ideal senator, the words might be *Safram Desus*.

What passes for capitalization in the written Romulan language is a minor addition to the proper alphabet symbol. Unlike capitalized words in Galacta and other Terran English-based tongues, however, capitalized words in *Rom'lesta* are pronounced. Capitalized words have an additional glottal stop that comes before the word is said, creating a subtle, but distinctive, catch in the voice as the word begins.

This is, perhaps, the most difficult part of spoken *Rom'lesta* for non-natives to understand, hear, and reproduce. Thus, this flaw is the easiest way to spot someone who is speaking *Rom'lesta* with a 'Federation accent.' For this reason, Romulans who deal extensively with members of other races seem to expect non-native speakers to miss the pronounced capital and thus the honor it implies.

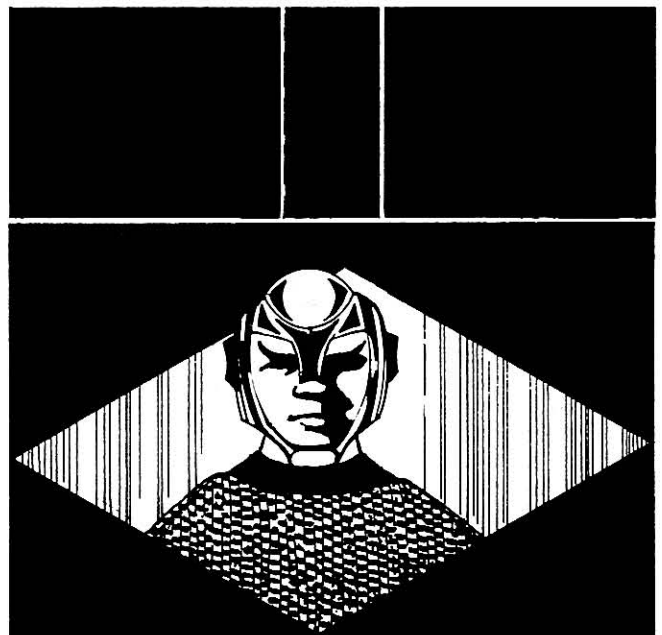



## Pronunciation Key

The following pronunciation key gives the closest Galacta equivalents to the sounds used in *Rom'lesta* words. It should help the reader to understand the pronunciation guide given for each word in the dictionary.

Where words are capitalized, the additional glottal stop in front of the word has been omitted for the sake of clarity.

a as in <i>hat</i>	o as in <i>hot</i>
ā as in <i>face</i>	ō as in <i>open</i>
ä as in <i>father</i>	p as in <i>cup</i>
b as in <i>bad</i>	r as in <i>run</i>
ch as in <i>children</i>	s as in <i>save</i>
d as in <i>done</i>	t as in <i>teller</i>
e as in <i>let</i>	th as in <i>thin</i>
ē as in <i>easy</i>	u as in <i>butter</i>
f as in <i>fine</i>	ū as in <i>rule</i>
g as in <i>get</i>	ū as in <i>music</i>
h as in <i>happy</i>	v as in <i>very</i>
i as in <i>fin</i>	w as in <i>wallet</i>
ī as in <i>mine</i>	y as in <i>yes</i>
k as in <i>king</i>	z as in <i>zipper</i>
l as in <i>large</i>	ə as the <i>a</i> in <i>about</i>
m as in <i>mouse</i>	ə as the <i>e</i> in <i>taken</i>
n as in <i>never</i>	ə as the <i>i</i> in <i>pencil</i>
ng as in <i>long</i>	ə as the <i>o</i> in <i>lemon</i>
	ə as the <i>u</i> in <i>circus</i>

## DICTIONARY OF SPOKEN ROMULAN TERMS

In the dictionary below, prefixes are followed by a hyphen and suffixes are preceded by a hyphen. Plural forms are indicated following singular nouns. In the pronunciation guides that follow each word, this stop is written as a slash (/) to avoid confusion with apostrophes that commonly act as accent marks. Accents are designated by slanted letters.

**al-** (al-) – A noun prefix denoting improvement.

**-am** (-ām) – The regular ending for singular nouns; irregular forms exist.

**-asz** (-ās̄z) – A common suffix for place names, equivalent to ‘-ton’ in English.

**avastam, -ai** (ä-vä-stām) – A wedge.

**Avastam** – The area of space known to the Federation as the Triangle. It borders UFP, Romulan, and Klingon space.

**bresasam, -ai** (brä-sä-sām) – Gathering or assembly.

**Bresasm** – The original group of assembled city-states often called the Romulan Confederation.

**calanam** (kā-lā-nām) – Large area or region.

**cav'sanalam, -alri** (cäv-/sā-nāl-m) – Class name of a Romulan shuttlecraft nicknamed the *Duck Of Doom*. Its Romulan name, best translated as ‘billed one,’ comes from that of a waterfowl noted for its prominent bill; the Romulan creature uses its prominent bill to strain algae and other pond plants for food. The shuttlecraft was nicknamed by Federation wags, who compared its shape to that of a Terran waterfowl.

**cl'vangam, -gri** (kl-/väng-am) – Act of revenge.

**d'** (d-/) – Prefix equivalent to ‘grand’ or ‘great.’

**d'anna** (d-/än-nä) – Marriage; literally, the ‘Great Joining.’

**d'bresassam rassam** (d-/bre-sä-sām räs-sām) – Family gathering or family shrine.

**deletham, -thri** (de-le-thām) – Defender or protector.

**D'ravsai** (d-/rāv-sī) – Gods; literally, ‘Great Brothers.’

**d'hannam** (d-/hän-nām) – Prayer; literally, ‘Great Communing.’

**d'navassa** (d-/nä-väs-sä) – Birth. This form used only in reference to birth of intelligent beings, especially Romulan children. Compare with *navassa*.

**d'latta** (d-/lät-tä) – Honorable death, used only when a Romulan has died to further the Romulan Way. Compare with *latta*.

**d'sora** (d-/sō-rä) – Ceremony, held at age 5, after which a child is no longer subject to euthanasia for genetic defects.

**D'takaram** (d-/tä-kä-rām) – The Great Comet, a military decoration presented for securing new resources for the Star Empire.

**d'talla** (d-/täl-lä) – Military service obligation; literally, ‘Great Duty.’

**hannam, -nri** (hän-nām) – Communication or message.

**hatham, -thri** (hā-thām) – Predator.

**hevam, -vai** (hā-vām) – Human.

**-i** (-ē) – Standard suffix for plural nouns.

**kalabam, -bi** (kā-lā-bām) – Storm or tempest.

**klivam, -vai** (klē-vām) – Klingon race.

**k'manatri** (k-/mā-nā-trē) – Cast-outs who are not acknowledged even by their families; literally ‘The Unseen Ones.’

**latasam, -sai** (lä-tä-sām) – Road or pathway.

**latta** (lät-tä) – Death or final ending; from the same root as *latasam*, the word for ‘road.’

**mandukar** (män-dü-kär) – Watchful, vigilant.

**-n** (-n) – A common suffix for place names, equivalent to ‘-ville’ or ‘burg.’

**narvasam, -sri** (när-vä-sām) – Nest or roost.

**navassa** (nä-väs-sä) – Birth, referring to non-intelligent beings only. From the same root as *narvasam* (‘nest’) and probably derived from the term for nesting.

**phi'lasasam** (fi-/lä-sä-sām) – Formal educational process, including military training; literally ‘The Education.’

**pratoram, -ori** (prā-tō-rām) – Leader or top official; usually the leader of a governing body at any level; ‘praetor’ in Federation nomenclature.

**Pratoram** – The Imperial Praetor.

**Rav's** (Räv-/s) – Remus, companion planet to *Rom'lasz*; literally, ‘biological brother.’

**rav'sam, -sai** (räv-sām) – Brother.

**re-** (rā-) – Prefix denoting freedom or lack of restraint.

**-ri** (-rē) – Standard suffix for plural nouns.

**Rom'lasz** (Räm-/läsz) – Romulan home planet, known to the Federation as *Romulus*; literally, ‘home of the People.’

**Rom'lesta** (Räm-/les-tä) – Romulan spoken and written language; in the Federation, this usually is known as ‘Romulan.’

**Rom'lnz** (Räm-/lanz) – The Romulan race or an individual Romulan; literally, ‘the People.’

**safram, -ri** (sä-frām) – Senator or member of a Romulan governing body at any level.

**sivas** (sē-väs) – Of or pertaining to a locality or a single city-state.

**stelam, -ai** (stē-lām) – Star or sun.

**Stelam Rom'lnz** – Primary star of the Romulan home system.

**stelai ler'hevai** (stē-lī lər-/hā-vī) – The Neutral Zone; literally, ‘the area of stars nearest the Humans.’

**S'L-** (s-/l-) – Common personal name prefix denoting honor.

**S'T-** (s-/t-) – Common personal name prefix denoting bravery.

**s'ten** (s/-ten) – Gallant, brave.

**takaram** (tä-kä-räm) – Comet.

**talas** (tä-läs) – To carry or lift.

**talasagam h'sarin** (tä-läs-ä-gäm h/-sä-rën) – Transporter; literally, 'matter-radio long-carrier;' sometimes simply *talasagam*; 'the long-carrier.'

**talla** (tä-lä) – Duty or obligation; from the same root as *talas*, to carry.

**-us** (-us) – Common personal name suffix denoting strength.

**vang'radam, -di** (väng/-rä-däm) – Traitor or betrayer; also used as an insult.

**vastam, -ri** (väs-täm) – Wing.

**vastaram, -ari** (väs-tä-räm) – Flying object.

**vas'** (väs/-) – Prefix referring to any flying creature.

**vas'deletham, -thri** (väs/-de-lē-thäm) – Class name of a Romulan Heavy Cruiser, named for an avian creature common to Remus best known for its extreme territoriality. Adults of the species, about the size of a Terran chicken, will fight to the death to defend the few meters of territory around their nest, driving away even full-grown Romulans.

**vas'hatham** (väs/-hā-thäm) – Class name for several types of Romulan warships, including an older-model light cruiser and a newer-model scoutcraft, both named for a flying predator native to Romulus and Remus, known for courage; best translated as *bird of prey*. The term has become so identified with Romulan military might that it is applied commonly to any Romulan warship. About twice the size of a full-grown Terran condor, the creature has iridescent red, gold, and brown plumage. Few unarmed humanoids would be a match for an angry or hungry bird of prey, which are said to attack people only rarely and can never be domesticated.

**vas'kalabam, -bri** (väs/-kä-lā-bām) – Class name given to Klingon D-7 Class Battlecruisers in the Romulan Imperial Navy. The name comes from a nocturnal predatory avian native to Romulus, best translated as *stormbird*. Stormbirds, often seen flying on the rising wind before a storm, are the size of a small Terran hawk; they are territorial and often fight among themselves.

**vas'teelis** (väs/-tā-ēl-ēs) – Class name of a Romulan shuttlecraft, named for a small bird, native to Remus, noted for its eerie, high-pitched warble; best translated as *songbird*.

**verelan** (vê-re-län) – Graceful.

**verelan vastarum** (vê-re-län väs-tä-räm) – Class name of a Romulan courier/scoutship, named for a Romulan migratory bird resembling an elongated Terran swan; best translated as *graceful flyer*. The creature, which has a long-tapered neck and sleek lines, is very fast for its size.



Marsh

# The Romulan Star Empire

## HISTORY AND TIME LINE

### PRE-HISTORY AND THE VULCAN HERITAGE

That Romulans and Vulcans share a common heritage is almost undeniable. The evidence for this stems from documents that came to light when a Star Fleet scout ship discovered the remains of a Romulan settlement on Eridam, near Federation Space.

#### Body Structure

A half-destroyed child's anatomy text among the Eridam papers confirmed that Romulans have the same body structure and appearance, the same anatomy, and the same physiology as Vulcans, right down to the copper-based blood. The placement of organs is the same, as is their function. For example, the transparent, inner eyelid in Vulcans exists in the Romulan eye structure as a vestigial fold of tissue. Romulans are psionic, as well, though they have not developed psionic techniques as highly as the Vulcans.

#### Environmental Influences

The climate of Romulus is responsible for physical differences between Romulans and Vulcans. The climate is not as harsh as Vulcan's, but is harsher than Terra standard, which explains why Romulans are hardier than most Humans, but not as tough as the average Vulcan. Though its climate is responsible for evolutionary changes, Romulans could not have evolved naturally on their home planet of Romulus. No native life forms similar enough have been reported to support any sensible theory of evolution, and Romulan seas have too small a concentration of copper to allow a copper-blooded organism to develop there.

#### Seeding By The Preservers

Until Star Fleet personnel came face-to-face with the Romulans, they had no idea that the Romulans were physically similar to their Vulcans allies. When the similarity was discovered, the Vulcan Science Council made public their theories about The Preservers, an ancient race who influenced the spread of early humanity throughout the galaxy. According to this theory, The Preservers deliberately seeded Humans and humanoids on widely scattered worlds. Now generally accepted, it accounts for the hundreds of undeniably Human and Humanoid civilizations found on so many worlds by the Federation.

To further uphold the theory, a child's geography text among the Eridam Papers states that Romulan archaeological findings give direct evidence that the Romulans of pre-history were placed on the planet and did not develop there. This is pointed to as evidence supporting one of the earliest Romulan legends: that the Romulans were placed on their homeworld and told to build a road to the stars.

#### ENVIRONMENT'S IMPACT ON CULTURE

The environment on Romulus is not only responsible for the differences in physical development between Romulans and Vulcans, but also the differences in cultural development. It forced the Romulans to fight for their mere existence. This, coupled with the fact that they started their existence on the planet in competing settlements (later developing into powerful city-states), caused them to value and develop physical rather than intellectual attributes. This, in turn, further emphasized differences between Romulans and Vulcans; Romulans tended to breed in faster reflexes and similar fighting qualities.

Romulus, a harsh planet today even with modern technology, must have been unimaginably harsh when the first cultures developed there over several thousand years ago. The planet's weather cycle makes most of its land surface very dry much of the year. The planet is extremely metals-poor, and most early farming tools and weapons must have been made from soft metals because of the lack of hard metals.

In order to survive, an early Romulan had to be tough. The weak were not allowed to live, because there was not enough of anything to support even the strong. The Romulan people have become very hardy, with inferior traits weeded out by selected inbreeding and elimination of undesirables. Romulan children continue to be tested for fitness, and those found to be defective are put to death.

### TIME LINE OF MAJOR EVENTS

*The early entries on this time line are speculative, based on data taken from the Eridam Papers, notably children's history books.*

#### Stardate -30/

The Preservers are thought to have seeded the Romulus/Remus system with Vulcanoids.

#### Stardate -3/

Romulans develop unmanned space flight.

#### Stardate -2/0300

The Romulan Confederation is organized, linking all city-states. L'Deus was elected first Emperor.

#### Stardate -2/0400

First Romulan-manned space flight, launched from the city-state of Kanassarum.

#### Stardate -2/1200

The first Romulan-unmanned probe lands on Remus.

#### Stardate -2/1800

The first Romulan-manned mission to Remus lands successfully, piloted by a female Romulan named S'Tanet. Her actual exploits soon became intertwined with fiction until the two are indiscernible.

#### Stardate -2/2900

The first permanent colony is established on Remus.

#### Stardate -2/3400

The Romulans mount their first expedition to nearby planets; it departs from the Remus port of Rinum.

#### Stardate -2/4100

The first Romulan-manned interstellar expedition is launched to Perhonies.

#### Stardate -2/5100

Romulans launch massive interstellar exploratory efforts coreward.

#### Stardate -2/6100

Romulans conquer the peoples on Gorwah, the first culture to be absorbed.

#### Stardate -1/

By this time, the Romulans have approximately 100 settlements on other worlds. The Romulan Confederation changes its name to the Romulan Star Empire and the Romulans establish the form of government they have today.

#### Stardate -1/0400

The Romulans are attacked spinward by a race unknown to them, the Corillians. The Romulans, having little force in this direction, sustain heavy losses. The valiant Corillians, much fewer than the Romulans, are eventually conquered, the first starfaring race to be subjugated by the Romulans.

**Stardate 0/0100**

Captured Klingon documents indicate that the Romulans first make contact with the Klingons during this year, leading to full-scale war lasting over 3 years, with neither side gaining any major advantage in the end.

**Stardate 0/9211.17**

Federation cargo vessel *Atlas* is listed as missing after failing to arrive when scheduled.

**Stardate 0/9302.21**

Marker/recorder buoy from the lost cargo vessel *Atlas* is recovered by Star Fleet. Tapes from the buoy reveal that the ship was not lost in space, but was fired upon by enemy aliens of unknown origin. Intercepted subspace radio transmissions are included, giving the UFP the first recordings of the Romulan language. Videotapes depict the second pass of the alien ship, painted like a gigantic bird. The *Atlas'* Captain reports his drive is inoperative and his shields failing, as the enemy vessel rounds for another run; he also reports his intention to release the buoy before the *Atlas* can be attacked again.

**Stardate 0/9511.30**

The Federation Council drafts and passes by acclamation a directive calling for the outfitting of a special UFP fleet to strengthen defenses in the area where the *Atlas* was lost. Twelve deep-space probes, each manned by 15 volunteers, scatter through unknown space in the region, trying to obtain information on the unknown enemy race. None returns.

**Stardate 1/0101.01**

Century Day celebrations on Luna and elsewhere throughout colonized space are interrupted with news of the destruction of 3 Federation heavy cruisers, presumably lost to forces associated with the unseen enemy. One small destroyer attached to the same fleet survives to report about the sneak attack, in which vessels painted as giant, winged creatures performed suicide runs with fusion-explosive missiles. Intercepted subspace radio transmissions from this battle are translated, finally giving the enemy a name – the Romulans. The UFP also obtains its first bearings on Romulan-held space.

**Stardate 1/0101 to 1/0601**

Several more run-ins between Romulan and UFP forces occur, the Federation beginning to develop some ideas on how to deal with Romulan hit-and-run tactics. On Stardate 1/0522.07, two Romulan vessels are crippled by a Star Fleet strike force. The Romulan commanders wait until several ships maneuver close for grappling and boarding, then self-destruct, taking the UFP ships with them as they explode. Standing orders are issued prohibiting Federation vessels from closing with even a badly-damaged Romulan vessel.

**Stardate 1/0610.14**

War is declared between the Federation and the Romulan Star Empire. In this unprecedented action, the UFP moves against an enemy whose planetary holdings and bases, political structure, aims and philosophies, and even appearance is completely unknown. Intercepted and translated subspace radio communications are translated and analyzed to help the UFP understand their foe.

**Stardate 1/0811**

A Federation fleet stumbles on a major Romulan base, dealing the enemy its first true defeat. Over 30 Romulan war-vessels, manned only by skeleton crews during resupply operations, are destroyed in orbit before they can fire a shot. Six Star Fleet vessels are lost in the engagement when the planetary base destroys itself after its shields had been damaged seriously. The loss to the Romulan fleet is crippling, and the Romulan war effort never fully recovers.

**Stardate 1/0909**

The Romulan-UFP War is ended inconclusively, after staggering losses on both sides. Neither side is able to supply

adequately or maintain a fleet in the war zone, and the UFP has been unable to mount a fleet strong enough to penetrate Romulan space to reach the supposed location of the Romulan home world. Because of this, Federation Senior Councilman Abraham Dannon convinces his colleagues to make a peace offer; the measure is accepted by a 1-vote margin. The treaty, negotiated by subspace radio, is accepted, with the provision that no members of the warring races meet face-to-face. No Federation forces have ever seen a Romulan face to face throughout the entire war, mostly due to the Romulan refusal to allow a ship to be captured intact.

**Stardate 1/0909.10**

The Neutral Zone, established by the peace treaty, is set up after much haggling over its exact dimensions and location. Ironically, the negotiations destroy the political aspirations of Councilman Dannon when his opponents claim that he, as chief negotiator, gave away too much of the disputed area to the Romulans.

**Stardate 1/1303.21**

Abraham Dannon, author of the Romulan/Federation peace treaty and chief negotiator of its provisions, dies at the age of 59, assassinated by a spectator at a political rally where he was scheduled to speak. A controversial, much despised figure in his own time, he is now revered for his contributions to galactic peace; the Terran civilian decoration for peace, The Dannon Prize, is named for him.

**Stardate 1/1804.03**

Star Fleet's initial network of manned and automated border outposts becomes operational along the Neutral Zone. The system is expanded and improved during the following 30 years, until most military theorists consider it impossible for a ship to cross the Zone undetected. It is assumed that a similar network has been created by the Romulans. This is supported by the fact that, of the 17 Federation space vessels known to have penetrated the Neutral Zone, none has returned nor has left any trace.

**Stardate 1/5105**

First contact with the Klingon Empire leads to armed conflict. Information obtained from spies and from Klingon prisoners lead to the inescapable conclusion that the Klingons and the Romulans have met. That they seem to be old and bitter foes comes as a relief. The "Klingon Menace" begins to overshadow conflict with the Romulans.

**Stardate 1/9409**

The Four Years War with the Klingons and the Axanar star system begins. Though tactical experts expect the Romulans to enter the war on one side or the other, they do not.

**Stardate 2/0710.21**

The vast build-up of Klingon military might, reported by Federation intelligence, has totally eclipsed all fear of the long-dormant "Romulan Problem." The complacency of Star Fleet and the UFP is shattered when a Romulan vessel, using electronic cloaking to shield it from detection, destroys 4 Neutral Zone border outposts with a new, powerful plasma weapon. Pursued by the *USS Enterprise*, the Romulan ship is chased into the Neutral Zone and destroyed before it can report. In the pursuit, the *Enterprise* taps into Romulan ship-board communications and picks up images from the Romulan bridge, revealing the Romulans to be Vulcanoid in appearance.

**Stardate 2/0711**

The Vulcan Academy Of Science stuns the Federation, but helps to allay fears of Vulcan/Romulan collusion, when it publicizes its theory concerning the Romulans' Vulcan heritage. This theory postulates a race known as The Preservers, who seeded the galaxy with Humans and humanoids; it is supported by Lt. Commander Spock, the *Enterprise's* own Vulcan Science Officer.

**Stardate 2/0803.21**

A Star Fleet-sponsored science team, composed of Vulcan researchers and lead by Lt. Cdr. Spock on temporary detached duty, re-discovers a Vulcan colony world that had been captured by Romulan forces. Located in the area between UFP/Romulan/Klingon space known as The Triangle, the mining settlement had been abandoned by the Romulans as unsuccessful when its ores played out. The Romulans destroy all records and equipment before leaving, stranding the Vulcan inhabitants. By the time the scientists arrived, most of the Vulcans had died, but a Vulcan/Romulan hybrid child, a girl of 5, survives. Sarek, a highly respected scientist/statesman from Vulcan, is given custody of the child Saavik, who was born soon after the Romulans had departed. Star Fleet has little opportunity to question her.

**Stardate 2/0801.09**

The first shots of what would have been the Second Klingon War are stilled by the Organians, who impose a peace treaty on both sides of the budding conflict. The preparation for war and the aftermath of the imposed peace delay the Federation Council's final action on the Romulan border attack and the theorized Romulan/Vulcan link. When the Council returns to the problem, first contact with the Gorn gives them yet another, more urgent matter to handle. Though Star Fleet doubles the number of patrols along the Neutral Zone and establishes new, larger, more heavily armed border stations, no direct action is taken against the Romulans at this time.

**Stardate 2/0911**

Deep-cover agents within the Klingon Empire report that the Klingons and the Romulans have been settling their border disputes and likely have sealed cease-fire agreements with exchanges of military technology. In the resulting, almost immediate shake-up in Star Fleet Intelligence, the entire staff of the Bureau Of Romulan Affairs is fired and replaced. Council members favoring a stronger stand against the Romulans feel they have a mandate because of the strength of public opinion, and they draft top-secret resolutions commissioning Operation Purloin.

**Stardate 2/1002**

Operation Purloin is put into effect when Captain James Kirk of the *USS Enterprise*, operating under sealed orders directly from the Federation Council, takes the *Enterprise* into Romulan space. The *Enterprise* is captured by 3 Romulan battlecruisers, of Klingon design and equipped with the Romulan cloaking device. Commander Spock, *Enterprise* Science Officer also acting under sealed orders, informs the Romulans that Kirk acted on his own initiative and out of a misguided and perhaps insane desire for personal glory. He gains the confidence of the Romulan commander and distracts her long enough for Kirk, disguised as a Romulan, to steal a prototype of the cloaking device from the Romulan flagship. The clever ruse succeeds, and the *Enterprise* escapes when Chief Engineer Scott is able to hook the purloined device into the Federation ship's own circuits and activate it. The Federation makes a major military gain when the device is delivered to Star Fleet Headquarters.

**Stardate 2/1004**

Despite intense examination by the best minds in Star Fleet, the Romulan cloaking device remains a mystery. Nevertheless, political pressure forces the Federation to make a public display of the stolen device. Again installed on a Federation ship, this one filled with dignitaries and influential people from all over the UFP, the ship vanishes from view. To the horror of the test's organizers and the Federation Council who pressed for the test over the advice from Star Fleet Research And Exploration scientists, the ship never reappeared. Subsequent attempts to duplicate the cloaking device meet with complete failure. Council members who

advocated a harder stance against the Romulans, and who gained in stature because of the success of Operation Purloin, lose credibility because of the disaster.

**Stardate 2/1109.30**

An abandoned Romulan planetary base is discovered on Eridam, a mining world near The Triangle, with its Romulan inhabitants wiped out by an epidemic disease known to affect Vulcans. No military information is gained, but personal diaries, children's books, works of fiction, and other non-military writings are recovered.

This body of work, known as the Eridam Papers, adds much to the Federation's meager store of knowledge about the Romulans. The Vulcan connection is supported by anatomical drawings, by Romulan legends, and by children's history books. Romulan history and motivations become better understood, giving some basis for understanding what has been a 'faceless' enemy.

Based on the Eridam Papers, some political thinkers speculate that negotiation may be possible with the Star Empire, though others see no hope for negotiation and press for even stronger measures to curb what conservatives have come call the Romulan Threat. The net result is both a stronger military presence along the Neutral Zone and near The Triangle, and a push to gather as much intelligence data as possible about the Romulans in hopes of making field commanders more aware of Romulan capabilities and tactics.

**Stardate 2/1808.10**

Saavik, ward of Sarek of Vulcan, enters Star Fleet Academy. Family prestige and the personal intervention of Sarek's famous son Spock heads off a storm of controversy over the admission of a "Romulan" to the Academy. Though only a half-Romulan and raised as a Vulcan, Saavik is seen as an enemy alien by many Federation bigots, including those who lost many family members to the Romulans.

Nevertheless, Saavik, who has embraced Vulcan teachings, is a valuable resource to Star Fleet, for whom she interprets intelligence data about the Romulans. Because of her help, many myths are put to rest and a better understanding of Romulan psychology develops.

**Stardate 2/2206.01**

Saavik graduates Star Fleet Academy at the top of her class. Promoted to Lieutenant, JG, she is assigned at the request of Captain Spock to take her Cadet Cruise aboard the *Enterprise*. She serves during the infamous "Wrath Of Khan" incident, and she is given a Star Fleet Commendation and a field promotion to full lieutenant. She is transferred to the *USS Grissom* for the survey of the Genesis Planet.

**Stardate 2/2206.27**

A Romulan-design, Klingon scoutship is delivered to Vulcan by James Kirk and his companions. Carrying a cloaking device, it was captured by Kirk after the destruction of the *USS Enterprise* in a Klingon attack before the Genesis Planet exploded.



## THE ROMULAN HOME SYSTEM

The exact location of the Romulan home system is not known to the UFP, and all information gathered on this topic is contradictory in the extreme. The mystery will be solved only when a Star Fleet vessel ventures close enough to establish the truth; to date, all who have tried have never returned.

On the one hand, it is known that the Romulans encountered the Klingon Empire long before their first contact with the UFP. This fact places their home system to galactic south and east of the Triangle and the major portion of the Klingon Empire.

On the other hand, estimates based on communication lags during the Romulan War place the system much closer to the present Neutral Zone boundaries. This would mean that the expansion of the Star Empire was mostly in the direction of galactic south, toward the galactic core, and that explorations in other directions were limited until after the first contact with the Klingons.

Much of the information that *is* known about the Romulan home system comes from publications in the *Eridam Papers*, particularly a book on popular astronomy and a tourist guide to Romulus and Remus. Confirming reports for this information have been surprisingly lacking, and much of the hard data comes from special long-range scans carried out by peoples friendly to the UFP.

### PLANETS IN THE HOME SYSTEM

The primary is Stelam Rom'Inz, a G-class star much like Terra's Sol. There are 7 planets in the system, including binary planets at IIA and IIB, the only planets inhabitable without artificial support. The planets in the system are as follows:

- Stelam Rom'Inz I: Aranusia
- Stelam Rom'Inz IIA: Rom'lasz (Romulus); Class M, Romulan home world
- Stelam Rom'Inz IIB: Rav's (Remus); Class M, orbits Rom'lasz
- Stelam Rom'Inz III: S'latas
- Stelam Rom'Inz IV: D'lanam, literally "The Great Wonder;" a gas giant
- Stelam Rom'Inz V: Ulunam
- Stelam Rom'Inz VI: Trijth

Although there are research stations on several of the other planets and some of the moons in-system, only Romulus and Remus will be covered in the following sections, because the bases are all research stations and/or mining facilities.

Both Romulus and Remus are Class M worlds, habitable by most humanoid races. Romulus (*Rom'lasz* – literally "home of the People") is the second planet in the Stelam Rom'Inz system. Remus (*Rav's* – literally "brother") is a satellite of Romulus, once most likely the third planet in the system. The two planets now form a binary system, with the two revolving around each other. The duo has no natural satellites, not surprising given the strange orbital pattern and the tidal stresses produced by their shared orbit. There are, however, several artificial satellite stations, including one massive station that serves as the primary base for the Romulan space effort.

### Romulus

Romulus is hotter and drier than Terra, but not as hot and dry as Vulcan. The climate is tropical/desert, with much of the planet being similar to Terra's Amazon area and Sahara desert. Coastal areas are typically lowland rain forests; the rainy season brings them monsoons and flash flooding, compounded by the strong tidal effects, and the dry season brings them drought. The interior is very high and dry; rainy season precipitation runs off rapidly to the lower coastal forests. The capital is D'Sivas. Romulus is very resource poor, particularly in fossil fuels, hard metals, and radioactives.

### Remus

The climate on Remus is more temperate than that of Romulus because of its thinner atmosphere and much more abundant standing water. Everywhere Romulus is resource poor, Remus is resource rich, with large deposits of hard metals, radioactives, and even industrial crystals.

Romulan legend holds that Rav's was placed in orbit around Rom'lasz as a stepping stone to the stars. Romulan scientists concluded very early that it had a breathable atmosphere and likely had life. After Rav's surface was reached, it was discovered that it teemed with life extremely similar to that on Rom'lasz itself.

The Alluram continent, the largest landmass, is the home of 71% of the inhabitants and the location of the planetary capitol, Biscae.

### LIFE FORMS

The two planets have remarkably similar native life forms, but none is advanced enough to be the ancestors of the Romulan race. Furthermore, their seas and oceans are not rich enough in copper salts to have allowed this in any reasonable evolutionary pattern. Strong tidal forces between the two planets makes sea navigation extremely hazardous and cause frequent ground tremors on both planets.

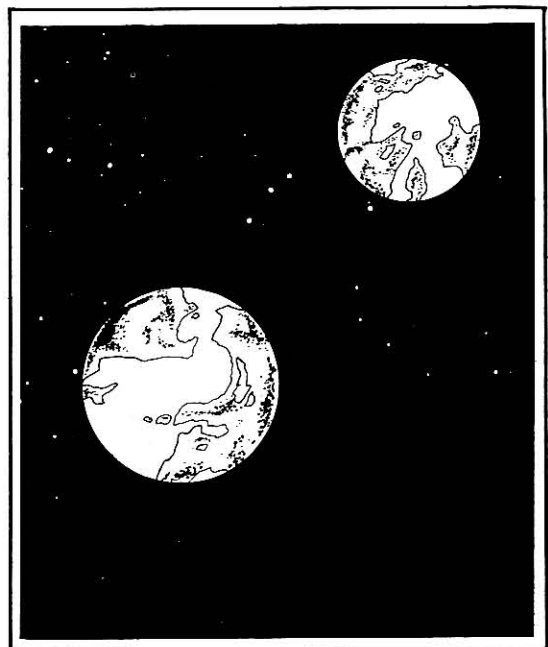

## GUIDE TO ROMULUS AND REMUS

*This text has been excerpted from The Eridam Papers: The People's Worlds.*

### THE CITY-STATES OF ROMULUS

#### Caranam

Highlighting the walking tour of Caranam are the ancient walls of the ancient city-state. Some wall sections have been rebuilt to their original size. What makes the walls truly remarkable is that all of the stones used were carried from the D'Kalla mountain range to the northwest. Visitors may climb the 3000-year-old stairways to the parapets. From here they may look over the sands to the north as lookouts did for many centuries.

Visitors at the T'Wakkan section of the wall in the north-east quarter should notice the stones are tainted greenish-brown; the stones are said to be stained from the blood of the defending warriors. The basis of this is from a ballad by L'Reanas, the great storyteller of all times.

*...and they stood, shoulder to shoulder, man and woman, child and great elder. They were outnumbered 100 to 1, yet they knew they could win. They stood singing the sharp songs of bloodlust. And when the Potorans climbed the walls, as a wall themselves they fought as the People have always fought. And when they died, they died as the People have always died — as one.*

*The battle raged for seventeen hours, with the Caranamians fighting although they were already dead. Yet, Balassor swore they would give every ounce of their blood for their city. He swore the walls would be stained with the blood of the attackers as well as that of the brave defenders. Balassor vowed the walls should forevermore weep blood for the people...*



#### Calanista

A must when near Calanista are the fields and shops of the nectar-makers. Here is produced what many feel is the finest ale in the galaxy. Indeed, the ale is one of the top exports of Romulus. Many imitators are to be found, even in the outlying colonies, but none compare to Calanistan Nectar.

The low fields near the river mouth provide year-round irrigation. The combination of temperature, water quality, and humidity make for perfect growth and ripening for the *ovila* grain used in this unique drink. Calanistan Nectar is very expensive because of the limited quantity of *ovila* that can be grown. Scientists have developed other ales that are chemically no different, but nectar experts say they can easily tell the difference. Why not stop by and make a comparison yourself?

#### Portora

Foremost of the places of interest in Portora is the site of the conferences which led to the forming of the Confederation, now a museum. Visitors may view holograms of the attendees arguing the various points of unification. One may see the figure of L'Deus, sitting calmly in a corner while all is havoc around him. The museum also contains the *D'Vatta* agreement sealed for protection from the ravages of time. The museum is always open, as it is one of the most popular tourist attractions on the planet.

#### Kanassarum

Kanassarum is situated at the foothills of the greatest mountain range on Romulus. It is these mountains that have given the city-state its glory, for they provided the scant resources for the first voyages to Remus. Kanassarum became the Confederation's first space center. The other city-states abandoned their space centers after the Confederation was formed so that all effort could be concentrated in one spot. The space center is basically a museum now, with exhibits dedicated to the various early efforts at reaching Remus. The landing fields are rarely used now, as it was found to be much cheaper to build vessels in orbit and shuttle or beam people and materials rather than use precious resources defeating gravity.

It is also at Kanassarum that the planet's most popular tourist attraction is located. In an open field near the space museum is a statue that gestures at the stars while stepping up onto a broken step. The statue is, of course, of S'Tanet, taking the first step on the Road To The Stars. Although it is well-known even to school children that her voyage began elsewhere, that first step of the People had its roots here, at Kanassarum.

#### Dinalla

At Dinalla live those who may be the planet's greatest hunters, plying their skill in the 47 game preserves that surround the city-state and even extend into the sea. Although there is little live game, the animoid game is real enough to capture the thrill and excitement of days gone by. For a small fee, one may hunt in any of the preserve areas.

The most fearsome, and hence the most popular, is the Vanawar preserve. Here, one may hunt real or animoid Grinawars; these 300-kilo beasts have teeth that can rip a man apart in seconds. Here, many fight the real beasts for an extra thrill, feeling the challenge is less with a beast that can be shut off when the going gets rough.

## D'Sivas

The Great City-State is the heart of society. What more need be said? More visitors come to here than any other city-state in the home system. Although many come on official business to the governmental offices, or even for audiences with the Emperor himself, most come because it is the heart and brain of the people.

Who has not felt the rush of pride when walking past the statue of L'Deus, with one hand holding *D'Vatta* and pointing to the stars with the other? It is best said in the inscription below the statue, in the words of L'Deus himself – the words he shouted at the assembly before storming out into the night:

*"We must join together or fail. We cannot reach our home, our destiny, by fighting among ourselves. We are one. We must be one. Let us act as one. To act any other way is to deny our children their right to the stars that are theirs."*

Another highlight of any tour of D'Sivas is The Arena of Life. Although many such arenas exist around the Empire today, this is the original arena. Although genetics have eliminated most of the original need for the Arena, it is used today as practice for hand to hand combat for the youth of the city. The Arena sits on a hill overlooking the Bay of Salvation. From this hill one has a commanding view of the entrance to the harbors of the city.

*Translator's Note: Terran readers may be puzzled by the absence of any mention of a Grand Palace or other official residence for the Emperor in the capital city. According to other documents that were part of the Eridam Papers, such a place does not exist, as such. By tradition, the leader of the Star Empire lives in a relatively humble compound, not particularly larger or grander than that owned by, for instance, a well-established merchant family.*

## THE CITY-STATES OF REMUS

### Levitasz

A statue here depicts S'Tanet stepping down onto the planet's surface, for it is here that she became the first to step onto Remus. She steps from a broken step, actually the other half of the step at the famous statue on Kanassarum. The inscription (*Translator's Note: "The first of many."*) is memorized by every child at an early age.

Nearby is a small museum containing the craft that bore S'Tanet to Remus, along with other artifacts from early exploration. Hologram recreations of the landing may be viewed.



## Biscae

The capitol of Remus is second only to D'Sivas in activity. This city serves as the headquarters for the Imperial Navy. As such, the city is alive with off-duty personnel, and the shops and restaurants flourish from the combined military and civilian trade.

Among the main attractions are the baths on the hillsides of Kannam, a small section in the southwest corner of town. These large buildings tap and channel hot mineral water flowing directly out of the hills. The baths are highly therapeutic in that they stimulate the muscles and nerves of the body. Citizens of the Empire come from all colonies to take the treatments offered here.

## Adrennan

The first permanent colony on Remus, Adrennan flourished from the beginning. The discovery of crystal deposits in the seabed nearby helped establish the early prominence of the city in the space program. Tours of the now-depleted crystal mines are conducted daily.

## EXTENTS OF THE ROMULAN STAR EMPIRE

The exact size of the Romulan Star Empire is not known, but rough estimates are shown on the accompanying map. The exact location of the Romulan home system is unknown, but a good estimate can be made based on travel-time estimates and intercepted messages during the Romulan war. A minority opinion among Romulan experts believes that the system is deeper within Romulan territory than widely accepted theory would have it, and that estimates to the contrary are based on false data deliberately supplied by the Romulans. The truth will probably not be known at any time in the immediate future.

### ROMULAN-UFP BORDER: THE NEUTRAL ZONE

Of course, the border between the Romulan Star Empire and the UFP itself is well mapped. The Neutral Zone agreements set down a maximum size and number for Zone border outposts, and monitoring sensors on either side confirm compliance with that agreement. It must be assumed, however, that the Romulans have more and larger bases constructed just out of the Zone agreement area, just as the UFP does. The known Romulan bases are shown on the map.

### ROMULAN-KLINGON BORDER

It is certain that Romulan holdings border the Klingon Empire along a large stretch of space, but the length of the border and its precise location are not known for certain at this time. Earlier, the border moved back and forth quite a bit as the two Empires fought over large sections of space. More recently, however, technological exchange agreements have put an end to open warfare.

### ROMULAN-GORN BORDER

Currently, the Romulan Star Empire seems to be unaware of the existence of the Gorn Alliance nearby, and vice versa. Since it seems diplomatically prudent to continue this situation, diplomats dealing with the Gorn have been instructed not to volunteer any information about the existence or extents of the Romulan Star Empire. Liberal estimates of Romulan expansion show an overlap between Gorn space and Romulan space, but conservative estimates figure it will be several years before their scouts encounter one another.

### THE TRIANGLE

It is known that the Romulans, for the most part in the guise of privateers, operate within the boundaries of the Triangle. Control of Romulan and Klingon activity in this area is imperative to UFP security over the next 5 to 10 years.



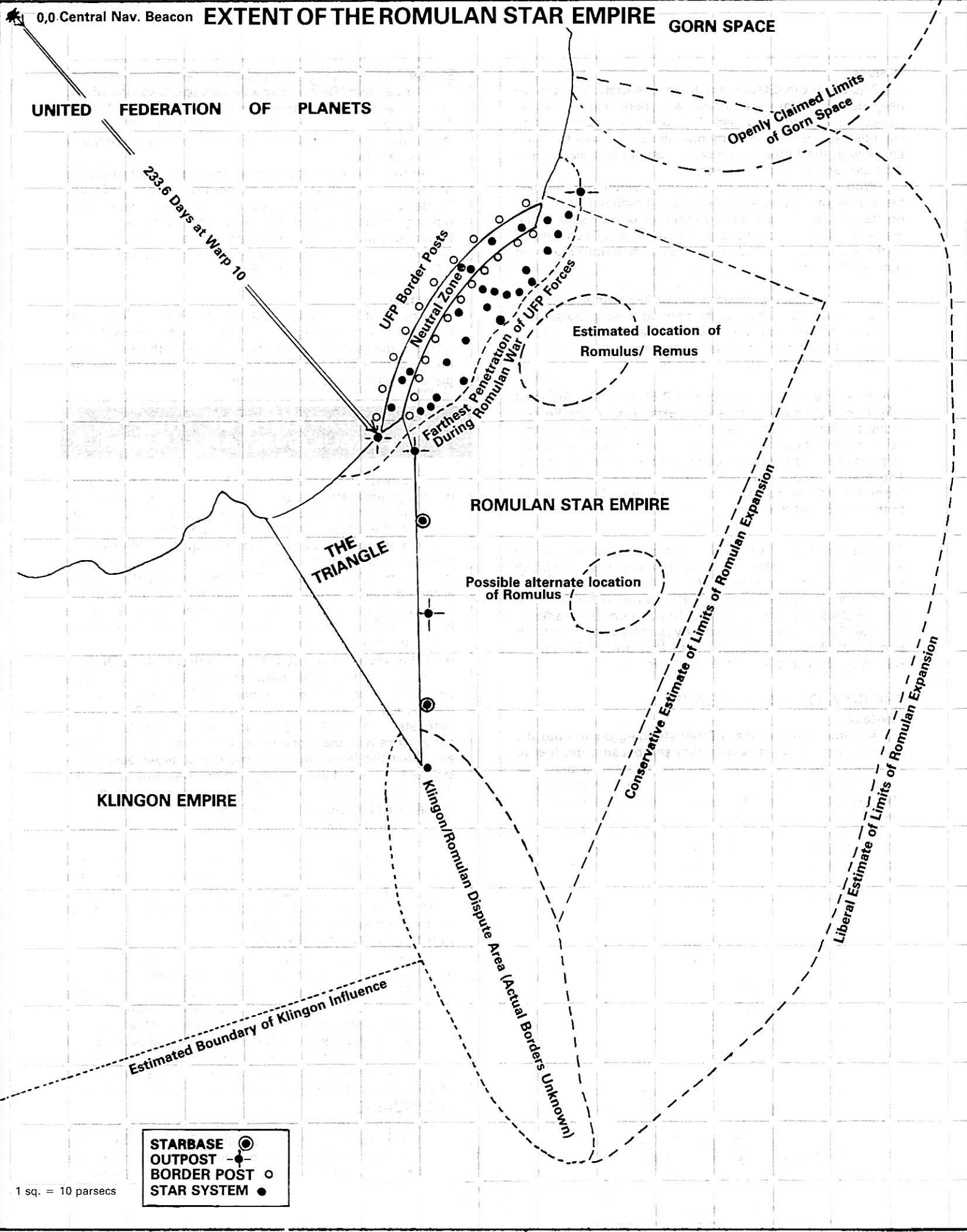

0,0 Central Nav. Beacon

# EXTENT OF THE ROMULAN STAR EMPIRE

GORN SPACE

UNITED FEDERATION OF PLANETS

Openly Claimed Limits of Gorn Space

233.6 Days at Warp 10

UFP Border Posts  
Neutral Zone

Farthest Penetration of UFP Forces  
During Romulan War

Estimated location of Romulus/ Remus

ROMULAN STAR EMPIRE

THE TRIANGLE

Possible alternate location of Romulus

Conservative Estimate of Limits of Romulan Expansion

Liberal Estimate of Limits of Romulan Expansion

KLINGON EMPIRE

Klingon/Romulan Dispute Area (Actual Borders Unknown)

Estimated Boundary of Klingon Influence

STARBASE	●
OUTPOST	—●
BORDER POST	○
STAR SYSTEM	●

1 sq. = 10 parsecs

## INTERSTELLAR INTERACTIONS

### GORN ALLIANCE

The known spheres of influence of the Gorn Alliance and the Romulan Star Empire are expanding in such a way that it is conceivable that these races will meet in the near future. In their expansion, the Romulans must move away from both the Klingon Empire and the UFP, which may take them directly into Gorn-claimed space.

The Gorn traditionally claim more area than they have the ability to hold and exploit. Thus, even when the two spheres of influence do intersect, it could be some time before individuals of the two races actually meet. Such a meeting is unlikely to be peaceful, given the Gorn extreme territoriality and the Romulan determination to expand at any cost.

In fact, there is some evidence to support the speculation that the Gorn may already have encountered the Romulans. UFP open records on the Romulan War are available to Gorn delegates to the Clanhaven Conference negotiations. Though UFP estimates of the extent of the Romulan Star Empire are *not* public knowledge, the Gorn may suspect that the Romulans are expanding in their direction. UFP negotiators have been instructed to note carefully any interest in the Romulans the Gorn might express. If the Romulans do move too close, the threat they impose may open doors to enhanced Gorn cooperation. On the other hand, if the Romulans find themselves boxed in on 3 sides, they also might be willing to consider a less-inflexible stance toward the UFP. Having the Gorn Alliance on one side and the Klingon Empire on the other could cause the Romulans to think of the UFP as a good neighbor instead of a threat to Romulan security.



### KLINGON EMPIRE

Though the Romulan Star Empire is an old rival of the UFP, their conflict with the Klingon Empire is even older – and far bloodier. Even so, those who took comfort in the old hatreds between the two major rivals of the UFP have discovered in recent years that things have taken a surprising and appalling turn for the worse.

Though most of the Federation's view about Romulan/Klingon conflicts is colored by the Klingon's perspective on them, it is obvious that there has been no love lost between the two cultures, and the history of their border disputes goes back long before the founding of the UFP itself. The Romulans have lost far more ships and men to the Klingons than to the Federation. Thus, the Federation was shocked to learn of recent agreements between the former deadly enemies. Border disputes seem to have been settled quietly and there are obvious signs of technology exchanges. The results have made both governments stronger. Furthermore, they have been able to divert more attention away from their mutual border and concentrate on their borders with the UFP.

Though Star Fleet Intelligence largely was to blame for not anticipating this incredibly dangerous turn of events, certain things must be said on their behalf. The agreements between the Klingons and Romulans were strongly suspected by Intelligence not long after they were reported to have been signed. They seem to have come about rather suddenly, as the result of a major change in both governments' diplomatic and military strategy. It is theorized that both governments were tired of wasting resources on endless, pointless battle between themselves, while the UFP, maintaining a peacetime economic footing, prospered and became stronger. Though many found it unthinkable that either of the two enemies would suggest even limited cooperation, both had lost wars with the UFP in the past, and thus their decision to concentrate on this common enemy and less on each other was, perhaps, inevitable.

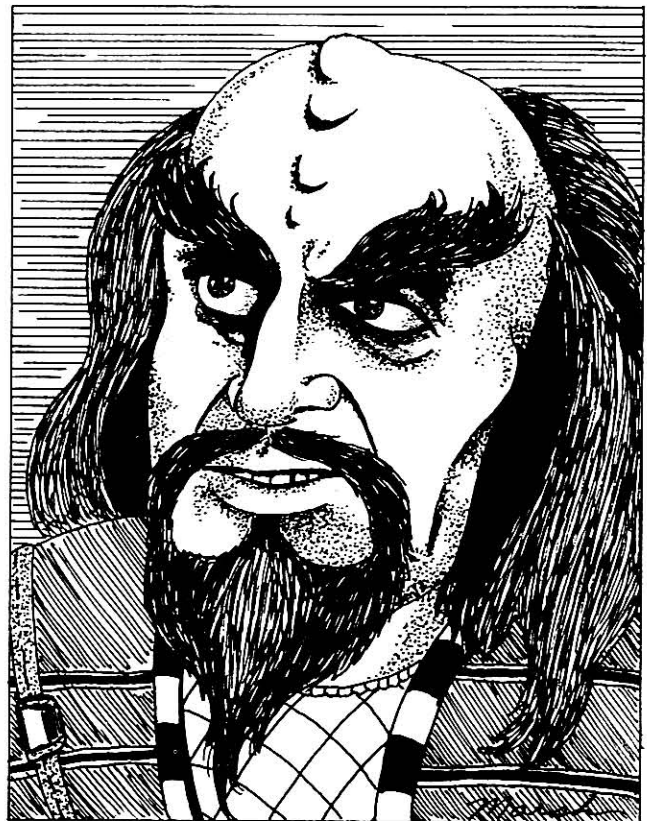

The news nevertheless shocked the Federation, but the situation perhaps is not as explosive as it first appeared, though it would be suicidal to underestimate the danger to UFP security that the situation poses. It appears that the agreements are not mutual defense pacts or agreements to mount joint combat actions. They appear, instead, to concern the exchange of technology and the settlement of border disputes.

The more-visible outcomes are these. Control over disputed border areas, once traded back and forth between the warring empires, has been stabilized, with the Klingons gaining most of the disputed territory. The Romulans have adopted the use of the Klingon hand disruptor and disruptor rifle. D-7 Class Battlecruisers are flying in Romulan Neutral Zone patrol fleets. More recently, the Klingons have adopted Romulan-style scoutcraft equipped with cloaking devices.

The major danger, however, is not the exchange of territory or technology. These exchanges merely allowed the Klingons and Romulans to reestablish the balance of power earlier than expected. Furthermore, it is considered unlikely that the exchanges will lead to mutual Klingon/Romulan expansion, and the continuing border incidents between the cultures is pointed to as evidence. The true danger is that the agreements have allowed both empires to divert their attention to the UFP, probing it for weak spots. If either empire decides that the other will wait long enough for it to be victorious over the UFP, galactic war could result. The only hope of avoiding that war lies in the Klingons' and Romulans' belief that they cannot trust their temporary allies long enough for victory to be accomplished.

Romulan treaties with the Klingons will be honored until such time as the Romulans find it expedient to ignore them. This tendency toward expedient action may blunt the danger posed by the exchanges. It does not seem to be the Romulan way to make strong allies. Past experience and current intelligence gathered from intercepted Klingon communications leads to the conclusion that the Klingons and the Romulans are as likely to attack each other today as they were 20 years ago. Even so, any cooperation between these vastly powerful, hostile, interstellar governments presents a direct threat to the security of the UFP and to the peace of the galaxy. Galactic peace relies first on the UFP's ability to maintain adequate defenses to insure that neither the Romulans nor the Klingons could hope to win a rapid victory independently, and second on diplomatic efforts that would make taking such a risk unprofitable.

## UNITED FEDERATION OF PLANETS

Interactions between the UFP and the Romulan Star Empire began with an unprovoked, surprise attack. The *USS Atlas*, one of the UFP's largest frontier cargo vessels, encountered a vessel of previously unknown configuration, painted like a huge hunting bird. The alien craft followed the *Atlas* for 11 hours, scanning her but ignoring friendly hailing messages. Without warning, the mystery ship attacked, devastating the cargo vessel; it cared not for the cargo nor the ship itself, repeatedly ignoring surrender messages. The UFP learned of the Romulans only because of the chance survival of the log buoy containing Captain Genevieve Horowitz' description of the encounter. The encounter established a pattern for many of the contacts over the next 120 years.

After the encounter, attempts were made to contact the alien civilization that launched the attack, in the hope that the destruction were some ghastly mistake. Efforts at communication, let alone diplomacy, met with failure. Envoys, both manned and automated, either were destroyed or ignored. Eventually, the Federation Council could no longer tolerate the destruction of innocent lives, and war was declared against a faceless, nameless enemy.

The Romulan War was perhaps the bloodiest series of space battles ever fought, far more bloody than the later Axanar conflict with the Klingon Empire. Though the Romulans had fewer ships, less sophisticated weaponry, and limited resources, they fought with unbelievable ferocity and exhibited a ruthlessness unmatched in interstellar history. In this war, the Romulans recognized no non-military targets; all incursions into space they laid claim upon were considered hostile automatically, and those inhabited planets that acted as bases for warships were fair game as well.

Federation forces, once alerted to the danger and uselessness of attempting to capture Romulan craft, matched the Romulan onslaught ship for ship, and more; the cost was high indeed. Hundreds of ships and thousands of beings aboard them died in the struggle.

The war ended without the satisfaction of total victory. Resources almost exhausted on both sides, the war was not won by either; it simply stopped. With no hope that the two cultures could share a universe in peace, a wall of empty space, the Neutral Zone, was established to separate them forever.

Far from lasting forever, the Neutral Zone was breached eventually by a Romulan warvessel equipped with an electronic invisibility screen that hid the vessel from both sensors and direct observation. Again, the first the UFP knew of renewed Romulan activity was when a number of Neutral Zone border outposts were destroyed without warning by the Romulans' devastating plasma weapon. Only good fortune and the combat expertise of Captain James T. Kirk and the crew of the *USS Enterprise* prevented the intruder ship from reporting its success by returning from its mission. By destroying the intruder, Kirk bought the UFP time to replace the destroyed outposts and beef up defenses in the face of the new threat.

Later, Kirk and his crew again preserved the balance of power by undertaking a mission deep into enemy territory to capture a working model of the cloaking generator. The highly dangerous mission, which was approved in the wake of reports concerning Romulan/Klingon alliances, was a complete success. Though attempts to use or duplicate the captured device have met with failure, the mission taught Star Fleet Command much about Romulan defenses and tactics, as well as the limitations of cloaked vessels.

In recent years, the initial fears about the Klingon/Romulan technological exchanges have died somewhat. The Romulans have shown little desire of late to intrude into UFP space in any significant manner. Nonetheless, the UFP must remain vigilant along the Neutral Zone. History shows that the status of any relationship with the Romulans may change – without warning, at any time.

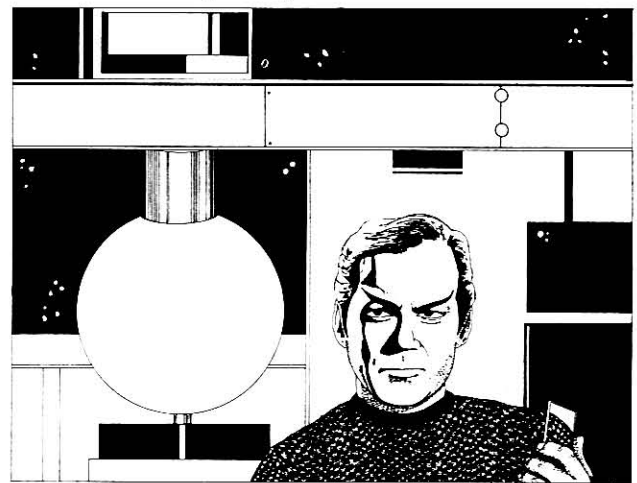

# The Romulan People

## PERSONALITY TRAITS



*The Romulan Personality, By Commodore Roger Calvin, Department of Psychological Studies, Alien Cultures Division, Star Fleet Intelligence Command*

The Vulcanoid appearance of Romulans and their overt tendency toward apparent emotionlessness often subconsciously leads officers into dealing with Romulans as though they were Vulcans. In fact, though the appearances and some of the personality traits are similar, the thought processes and personalities that produce these appearances are markedly different.

The Romulans, unlike the Vulcans, do not seem to believe in suppression of emotion. They do, however, maintain a very businesslike, perhaps even cold, presence when on duty. This passionlessness does not stem from a desire for inner serenity, but has been learned over the years by Romulans in dealings with other cultures. Quite simply, one is less vulnerable to an enemy if that enemy cannot tell from one's appearance what one is thinking or feeling.

A Romulan ship commander will not give away his plans in his voice or mannerisms. It is doubtful that the old saying that "Romulans know no fear" is true, but Romulans certainly *show* no fear.

Neither will they show mercy. A Romulan gives and expects no quarter in battle or in negotiations. In negotiations to conclude the Romulan War, Romulan diplomats had difficulty understanding an enemy who would not necessarily take advantage of any momentary weakness. Romulans are extreme pessimists, always expecting the worst of a rival. This personality quirk has been successfully turned against them in the past through use of reverse psychology.

Romulan officers show a dedication to duty that borders on the extreme. Certainly no Romulan would allow an enemy to capture his ship, and they are known to prefer death to being made prisoner. Circumstances that would make a Romulan prisoner worth more to his people alive and imprisoned than dead and safe from interrogation are most rare.

Therefore, under most situations, it is useless to risk one's ship and crew to attempt such a capture.

Romulan tacticians see no lapse of the morality of warfare in sneak attacks, or attacks against unprepared or unarmored installations. The enemy is the enemy, and little distinction is made between civilian and combat soldier. Romulans do not fight limited war or recognize non-military targets. For them, survival is the only rule of war. To expect any other view from a Romulan is to invite disaster.

The skill of Romulan commanders in hit-and-run tactical situations is legendary and certainly is the result of chronic shortages of men and materials. If one has few ships, one cannot take chances by attempting an open frontal attack. Strike from hiding and run away: these are the tactics of conservation, and the tactics most used by the Romulans.

The Romulans are not marauders of the Klingon fashion. They rarely take possession of what they cannot use, nor commit atrocities for no purpose other than demoralization of the enemy. But neither do they divide their efforts with infighting nor underestimate their enemy. And, unlike the Klingons, they are not vulnerable to appeals to personal greed or glory. One must not make the mistake of thinking of the Romulans as 'better' or 'worse' than the Klingons. They are simply 'different' – different in attitudes, motivations, and goals.

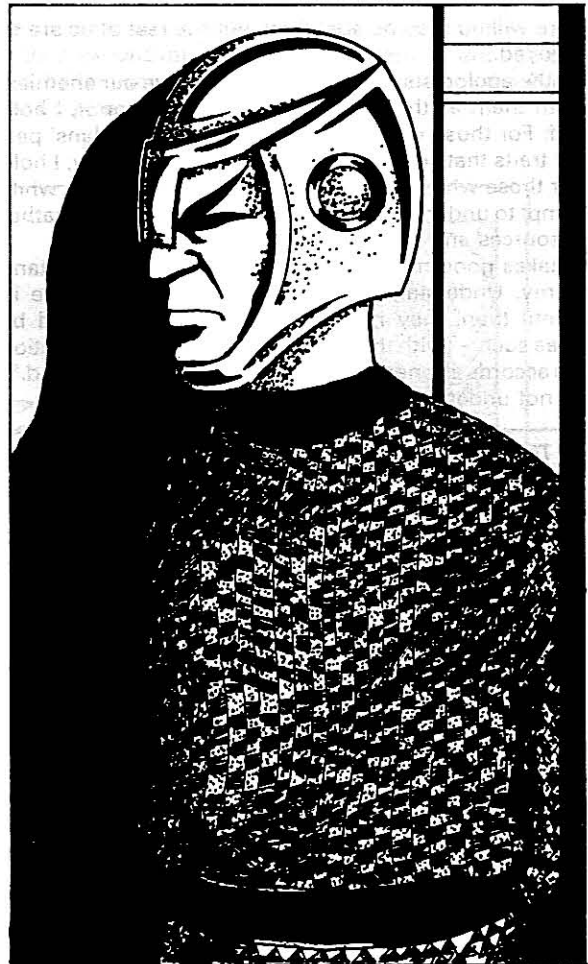

Though they have many personality traits that Federation citizens generally find admirable, their actions must be dealt with consistently, without allowing their similarities to imply that their motives, goals, and actions will be similar. One can never totally understand an alien viewpoint, even among allies. Instead, one must learn to recognize and respond to patterns in behavior.

*Excerpts from **The Faceless Enemy**, by Admiral Thaddeus I. Harden, Ret., former Sector Commander on the Neutral Zone.*

Make no mistake, Officers of Star Fleet, the Romulan is indeed The Faceless Enemy.

A good officer must use his own senses to decode the many words that have been written about the Romulan Menace, words that often portray the Romulan as neither evil nor good, but merely as being misunderstood.

His motives cannot be understood, but his actions can be. He strikes like the terrorist of old, faceless behind his cloak. He sneaks into our midst hidden by its artificial darkness and kills swiftly from the security of its hiding place.

He expects no mercy, and so he refuses to acknowledge the concept. With calm dispassion, he destroys all life when hope for victory is gone. Victory is more important to him than life itself.

He does not know or dares not show love, but he is quick to prey on our emotion. Thus, he makes no distinction between those who wage war and those who do not or cannot. He kills innocents wantonly, for the same reason that men have always climbed mountains – because they are there.

In his singleminded pursuit of galactic domination, he can brook no opposition, no obstacle in his “road to the stars.” The Romulan’s actions clearly show that cultures which are willing may be absorbed, but the rest of us are to be destroyed.

For the apologists who would have us love our enemies, treat with them as though they were men of honor, I hold disbelief. For those who would point to the Romulans’ personality traits that seem to be Human and exemplary, I hold pity. For those who would have us relax our vigilance while we attempt to understand our foes, and while our foes gather their resources and strength, I hold contempt.

It makes good military sense to attempt to understand the enemy. Understanding of the Romulans will come in time. Until then, they remain the enemy, and should be treated as such – with the same circumspection and caution that one accords all enemies whom one cannot understand.

Let not understanding come cloaked in underrating.

*Seeing The Enemy’s Face, A Reflection: by Commander Spock of Vulcan.*

As one who perhaps has had more dealings directly with Romulans than some others of my service, I believe that certain clarifications need be made about Romulan psychology.

Despite their passionless exterior, I would agree that Romulans tend to be a highly emotional race. Unlike the Human race, the Romulans have had reason to keep their emotions out of their dealings with other cultures. Unlike the Vulcans, they have not learned that emotion which is hidden from view but not considered as a force in one’s own life is perhaps as destructive as unrestrained expression of those feelings. My own biology bridges the gap between Human and Vulcan, and I can appreciate the difficulty of the Romulan position.

Among their own people, the Romulans exhibit loyalty and trust that even Humans would find exemplary. They do not make the mistake of denying the virtue of differences between cultures, but they are extremely single-minded in their view of their part in the universe, and willful enough to pursue that view no matter the personal cost, either to themselves or others.

Still, the individual Romulan trusts, where trust is considered appropriate. A Romulan is not gentle, but he is honorable. He is not flexible, but he is reasonable. He is not sentimental, but he is vulnerable.

It would be a mistake for a Star Fleet officer to think of the Romulans as a faceless enemy, even though they often try to maintain such an image. They are individuals with their individual virtues and failings. A wise commander will take this into account in his dealings with them, or with any group whose interests may conflict with our own.

## ROMULAN PSIONICS

Romulans have limited psionic development, lacking the intensive training of the Vulcans, but the potential is there should the race choose to exploit it. At present, the Romulans use their limited psionic potential to enhance the expression of emotion between individuals in close contact. This sharing is usually limited to family members.

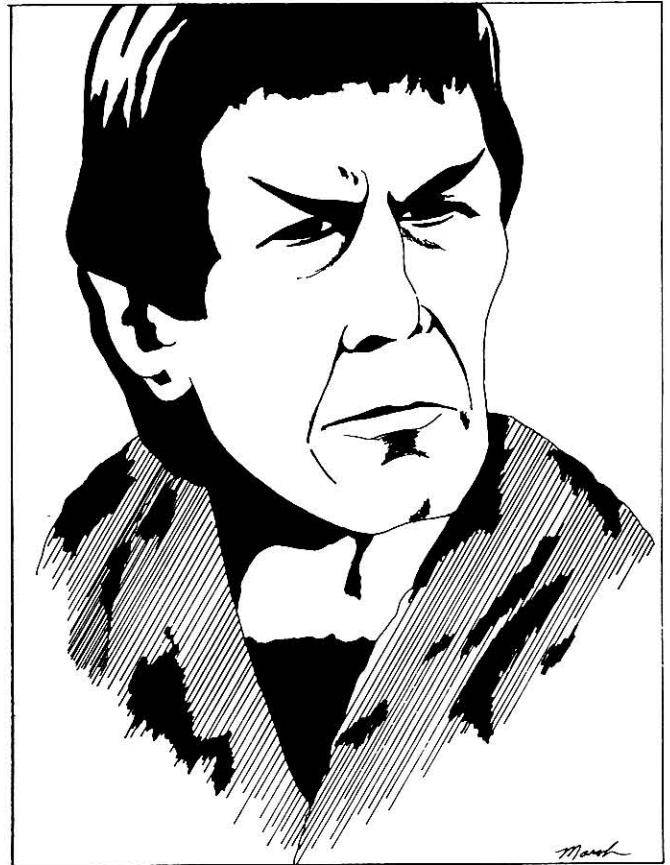

## RELIGION

From *Communing With The Great Brothers*, by Dr. Valerie Ho, advisor to *Star Fleet* and Professor of Comparative Religion, University of Luna.

Although references to Romulan religious beliefs and teachings are contained in many of the documents known as the *Eridam Papers*, every question we have answered has only created two more questions we cannot answer. It is quite dangerous to try to summarize a subject as complex as an incompletely understood religion, especially an *alien* religion. Even so, the Romulan religious beliefs are so important to understanding and anticipating their behavior that an attempt at summary must be made.

The Romulans are Vulcanoid, with the scientific community agreeing (as much as scientists ever agree) that the two races must have come from a common ancestry. The Vulcan Science Council has gone even further, noting that Romulan physiology has diverged little from Vulcan standards and suggesting that the Romulans must have been transplanted from Vulcan sometime soon before the stabilization of Vulcan civilization occurred with the embrace of logic and denial of emotion.

Theories vary widely, but some credence must be given to the widely-discussed possibility that an ancient race of space travellers transplanted Vulcans to the Romulan home system. Certainly, there is overwhelming evidence that such an effort by a race commonly called The Preservers is responsible for the wide dissemination of humanoids across this part of the Galaxy, at a time when Humans had not developed the wheel, let alone space travel.

What does this have to do with Romulan religion? The center of Romulan religious belief is that the Romulan people are not native to their home planet. All of their religious

writings maintain that a god-like race of super-beings brought their ancestors as savages to a new world, and charged them with a great task. The ancestors of the Romulans were told by these beings that it was their responsibility to build a "Road to the Stars" so that they might someday join their "Great Brothers" at the end of their task.

According to Romulan writings, the planet they occupied was poor in natural resources, purposely made that way as a test of the Romulan spirit. Above their world was a moon (actually, the other half of a binary planet system) that would contain all they needed to start on their "road," if only they had the strength and determination to reach it. Their early history, as recorded in children's texts found with the *Eridam Papers*, is a struggle to enter space and reach their companion planet – to build their "Road to the Stars." Romulan expansionism is religiously motivated.

The Romulan relationship with their gods or Great Brothers is unclear. Each family dwelling has a shrine or family temple. There seem to be many different individual gods, the ones prayed to varying from family to family. Though Romulans pray, they do not expect answers to their prayers any more than most Humans have expected such answers. This is unusual, because Romulans seem to have no concept of an individual afterlife, nor priests or religious leaders to interpret religious philosophy.

For the Star Fleet officer, it may be difficult to grasp the idea of a religion with no leaders, no consistent rituals, and supernatural overtones – a religion that nevertheless shapes the thinking of every member of a powerful and scientifically advanced race. If one must truly understand the Romulan Way to understand Romulans, we may never be able to make the connection entirely. But the memory of Terran religious wars coupled with the knowledge that the Romulans consider galactic expansion as a 'divine mission' is enough to give us a better idea of the danger we face from the Romulan Star Empire.

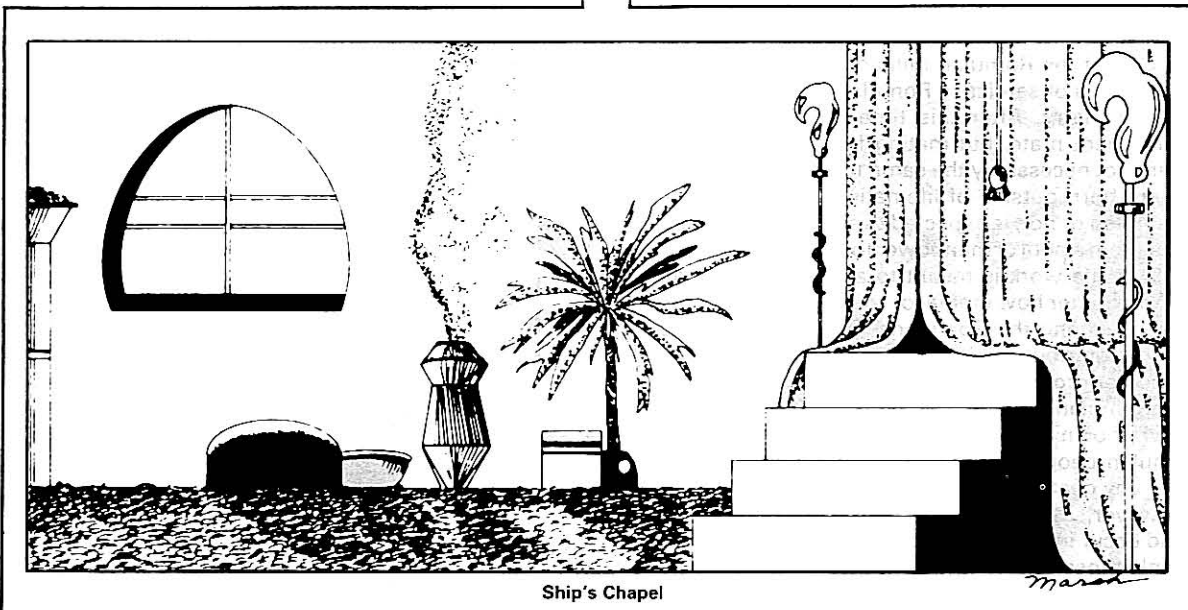

## STAGES OF ROMULAN LIFE

Prepared by Commodore Willis Valarian, Star Fleet Intelligence Command

According to references within the *Eridam Papers*, the life of the average Romulan is a series of obligations owed to the Star Empire and to the Romulan gods who set their race the task of expanding throughout the galaxy. These obligations are harsh and unforgiving, and the Romulans accept them with unquestioning obedience.

The Romulan Way has no room for individuals who are physically unable to meet their obligations to the Star Empire. Thus, children born with physical capabilities below strict minimums are not allowed to live. This practice of infant euthanasia is unspeakably horrible to the average UFP citizen today, but there are numerous precedents in the early history of Terran Humans, Andorians, Tellarites, and several other Federation member cultures.

The development of a Romulan child is closely watched until about age 5. By this time, monitoring the child's physical development can eliminate those with hidden birth defects. If fit, the child enters a rigorous program of schooling, cultural indoctrination, and physical training which lasts about 15 years. During this period, the child likely is tested and watched closely. It is in keeping with the Romulan reluctance to waste resources that a child who exhibits aptitudes for particular types of work gets special training, while those who cannot compete as fiercely are forever left behind.

Until the child reaches the age of 20, he can be found to be physically or mentally below Romulan standards. If this happens, the child must earn the right to stay alive by fighting a youth of approximately the same age. The combat is to the death, the theory being that the winner has proven his worthiness, and that the loser has been shown to be unsuitable for life as a Romulan citizen.

Without exception, all Romulans spend at least 5 years in military service. Men and women serve together with no distinctions at all drawn between the two sexes. This pool provides the bulk of the Romulan military forces.

After the 5 years of service, a Romulan is accepted as a citizen and may marry. After this time, a Romulan may choose a permanent mate, but mating for life and mating for children are not necessarily the same thing. Many Romulan children are born outside of lifematings. Indeed, every Romulan, lifemated or not, is expected to sire or bear several children to maintain a pool of manpower for the Star Empire.

A Romulan's life work is meant to advance the "Road to the Stars," no matter how menial or exalted the job. There is no retirement among the Romulans. One is expected to be a productive, contributing citizen until one dies. If an individual is injured or grows old in such a way as to become a burden upon Romulan society, the individual is expected to terminate his/her own existence for the good of all.

The Romulan people are not sentimental about death. They consider any death which does not advance the Romulan Way, however, as a waste of resources. Because all deaths should occur in advancing the Romulan Way, Romulans honor only those deaths without which the Way would suffer.

The Romulan Way is harsh – even brutal, but it is extremely efficient as well. We need not appreciate it or accept it as virtuous to attempt to understand how it works. Indeed, such understanding is vital to maintaining our continued vigilance against the "Romulan Menace."

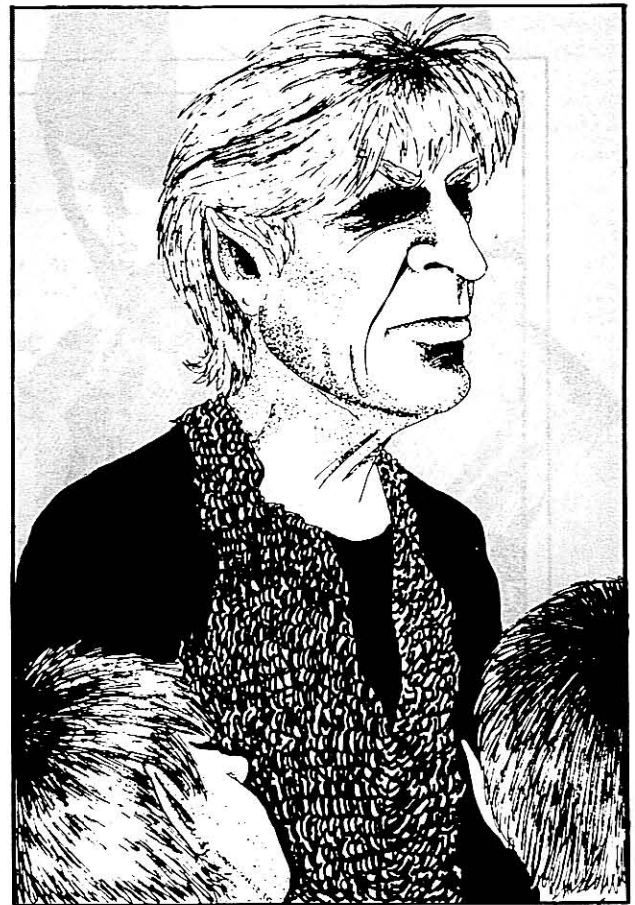
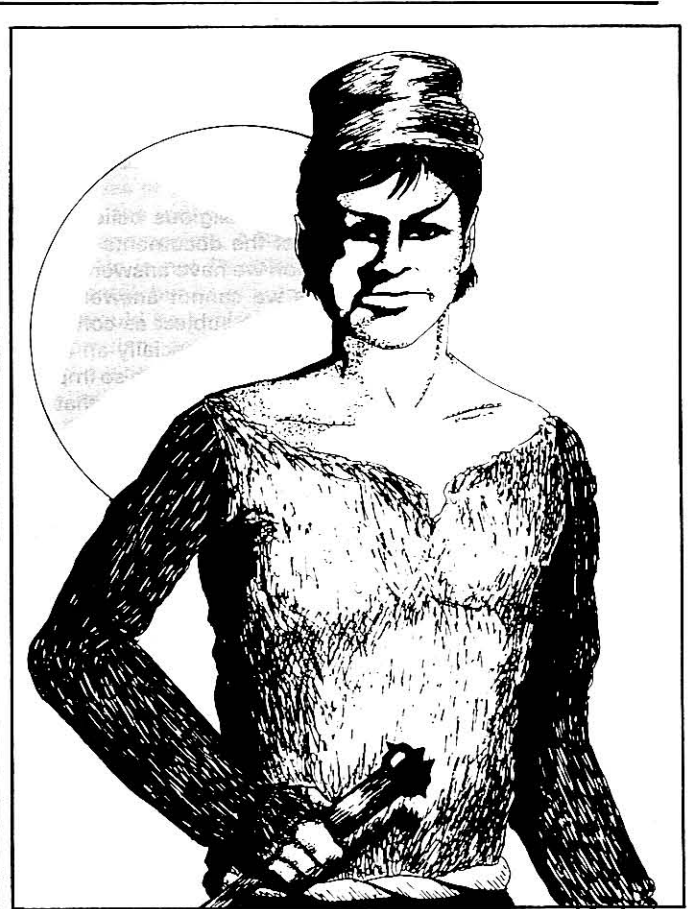

## GOVERNMENT

The Romulan Star Empire, according to available documents and reports, is a loose, semi-democracy. There are three levels of government, each controlled by a popularly elected Senate. Unlike such bodies on many Federation worlds, however, each Senate has an extremely stable composition, particularly at the Imperial level. The inevitable conclusion is that the Romulans put great store in tradition and do not change leadership rapidly.

There are no discernible power blocs or political parties. Even so, the general direction of governmental efforts seem to shift slowly from extreme expansionism to a more conservative stance and back again. This shift affects the government at all levels, with one group of Senators gradually being replaced by another.

Such a shift can be seen quite clearly in past Romulan/Federation relations. The first Romulan War took place at a time of extreme expansionistic fervor. By the time the war had ended, however, the Romulans had suffered from vast losses of men and materials. The need to replenish supplies and rebuild trade and industry brought more conservative Senators into Romulan government.

Another shift, back toward expansionism, led to Romulan incursion into UFP space that was stopped by the *USS Enterprise's* destruction of a Romulan raiding vessel. Subsequent relations were stormy, but the storms quieted as the pendulum swings back toward conservatism. Some analysts predict that the Romulans are due for another wave of expansionism. It is known that some Senators during the last period of Romulan expansion activity again hold power.

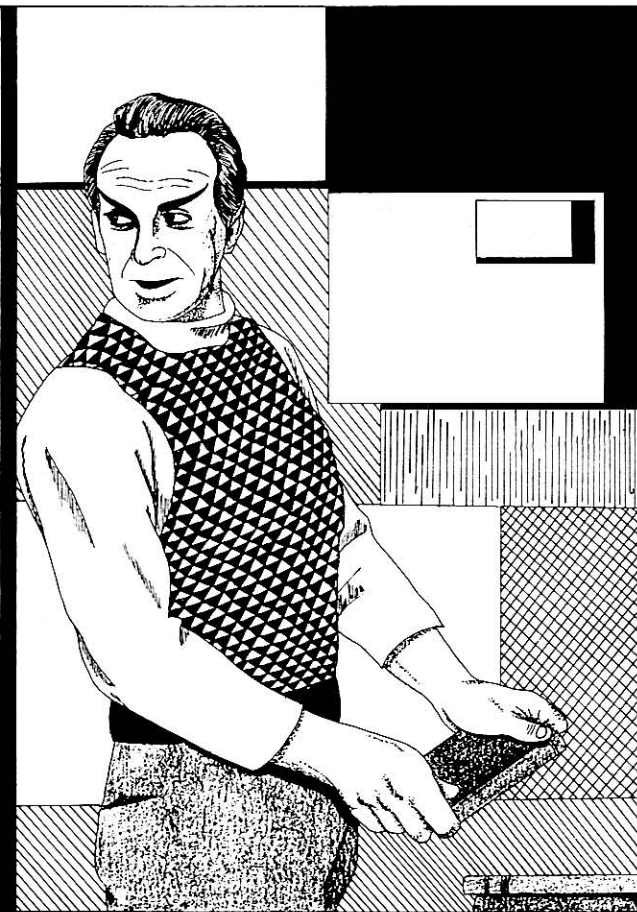

Manst

## CITY-STATE SENATES

The lower level of Romulan government is composed of Senates convened at each major city-state or important colony. The Senate's ruling council is composed of Grand Senators who are elected by their peers and remain in office for a long time, seemingly replaced only for infirmity or in one of the long periodic swings between conservatism and expansionism. The chief executive officer is a local Praetor, who has a great deal of discretionary power within his domain, but seems to have little direct say in interstellar affairs or direct command over military forces.

## REGIONAL SENATES

The middle-level, regional Senates control whole sectors of space. Most of the actual governing of the Empire's holdings seems to be done at this level. This Senate also selects a council of Grand Senators and a Praetor. The Praetors at this level are empowered to make decisions affecting interstellar relations, short of actual declarations of war, and thus they enjoy a great flexibility in deploying military forces. Regional Grand Senators are privy to much information about military operations, and Regional Praetors have been known to authorize secret missions into UFP territory on their own authority.

## IMPERIAL SENATES

The Empire's top level of government is an Imperial Senate. Imperial Grand Senators are the true elder statesmen of the Empire, and their word controls vast power. The Imperial Praetor is the chief executive of the Empire, but his position is not as volatile as that of the Klingon Emperor. One rarely leaves office, remaining insulated behind the Imperial Senators.

Only the Imperial Senate may declare war officially. It is possible that the Empire never viewed the First Romulan War as an actual war, because the initial conflicts apparently were coordinated at the regional level. Nevertheless, the final treaties were negotiated over subspace radio with the Imperial Senate.



Manst



# The Romulan Imperial Navy

## ORGANIZATION

Military organization for the Romulan Star Empire differs from that of Star Fleet. Although the Romulan military structure encompasses colonization and exploration operations just as Star Fleet does, the Romulans seem to have a full-fledged service branch devoted to maintaining the security of the Romulan borders. Furthermore, each branch seems to have its own internal structure for such things as research and development, supply, and so forth, whereas Star Fleet centralizes these functions for all service branches.

## RANK

Rank structure within the Romulan Imperial Navy is less stratified than that of Star Fleet. Those serving their required 5-year service form the lowest echelon of the Romulan armed services. All above this level are considered officers, though many perform duties that would be given to non-commissioned officers or enlisted personnel in the UFP services.

The lowest officer rank, called Equitoriam, comprises the second largest group of officers in the naval ranks and performs functions equivalent to an Ensign in Star Fleet. Most officers at this rank are in on-the-job training for their duties as leaders. Those who are not really leadership material will never rise higher.

Officers at the second rank (Secundam) and third rank (Trinam) have responsibilities roughly equivalent to Lieutenants, JG, and full Lieutenants respectively. They have responsibilities in operational subdivisions on board ships and actually command lower-ranking officers in combat.

Officers at the fourth rank (Centurion) comprise the bulk of the officer corps in the Romulan Imperial Navy. This rank encompasses a broad category. Some Centurions are barely more than security guards, taking orders more than giving them both from higher ranks and more importantly-placed fellow Centurions, whereas others head up the major departments aboard ship. For example, the second-in-command of a major ship-of-the-line will be a Centurion, and the guard outside his door may hold the same rank. Even so, the Romulans seem to recognize the various strata of this rank. No officer rises above the rank of Centurion until he is given a command of his own, and so the rank of Centurion is as high as most Romulan officers can hope to rise.

A Sub-Commander is actually equivalent to the rank and position of Captain in Star Fleet. Every Romulan fighting vessel, no matter how small, is directly under the command of a Sub-Commander. This indicates that Sub-Commanders of small vessels have less prestige than Centurion who are Department Heads of larger vessels.

The Romulans seem to have no higher military rank than Commander. A Commander actually commands a greater responsibility than just one ship, roughly equivalent to the responsibility of an Admiral in Star Fleet. A Commander may have control over a small group of ships, an entire strike force or fleet, or a departmental command for an entire region. The supreme military commander of the Romulan Imperial Fleet would seem to be no more or less a Commander than the officer who calls the shots for a battlegroup of 3 *Birds of Prey*.

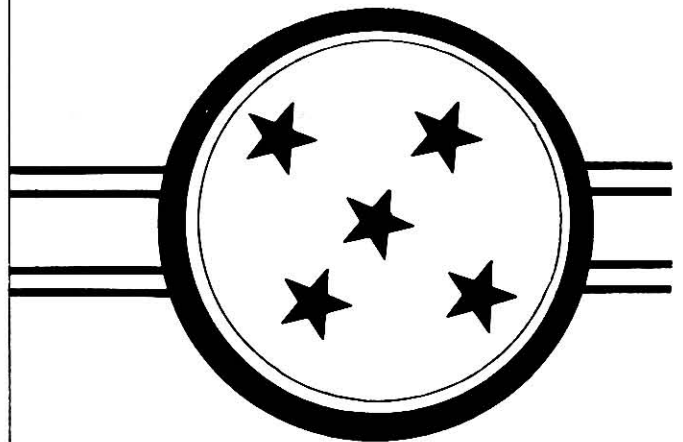

## STARSHIP RECOGNITION FILE

Complete details on known Romulan starships are better presented in other data volumes available from Star Fleet Intelligence. This section will concentrate on the known factors and operational history of 5 Romulan vessels commonly encountered along the Neutral Zone or known to be in service near the Triangle. All officers serving in areas near Romulan space should be able to identify these vessels on sight and know something of their operating history.

## BIRD OF PREY CLASS LIGHT CRUISER

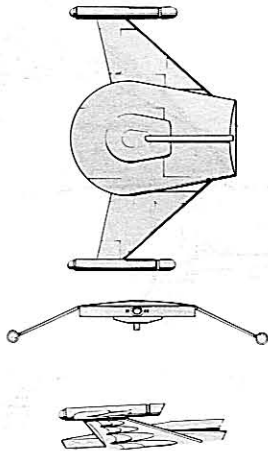

### Size Data:

#### Hull Size:

Length — 135 m  
Width — 200 m  
Height — 45 m

#### Other Data:

Weight — 65,000 mt  
Crew — 150

### Combat Data:

Known Top Speed — Warp 6

Known Armament —

Beam Weapon Type — Medium to heavy  
Number — 1, 2, or 4  
Firing Arcs — forward/port/starboard  
Missile Weapon Type — Plasma weapon  
Number — 1  
Firing Arc — forward

### Notes:

This ship, more than any other, is universally identified with Romulan military actions. With its smooth underside painted as a giant, stylized, hunting bird, the exact details of which seem to vary from ship to ship, this was for many years the mainstay of the Romulan fleet. It is best known for hit-and-run attacks.

Equipped with medium to heavy beam weapons having a wide field of fire, this ship is dangerous to smaller Federation vessels. Armed with plasma weapons, however, it is a much more formidable opponent. It almost always mounts a cloaking device and is landing capable.

Ships of this class often are deployed in groups of 2 or 3. A favorite tactic is to hide 1 ship, either cloaked or hidden in the sensor shadow behind a moon or planet or near a variable star; another ship is used as bait to draw a victim's attention. The bait ship often is damaged heavily in the maneuver, but the risk must be acceptable. Many larger Federation vessels were taken from an unshielded side with a plasma bolt from the hidden member of the partnership.

The role of this class as a capital ship largely has been taken over in recent years (after approximately Reference Stardate 2/1500) by the more powerful *Winged Defender* class ships. Ships of this design continue to be used as support or convoy vessels, particularly near the Triangle or the Klingon border.

During the Romulan war, the name became synonymous with Romulan spaceborne military power, so much so that it became popularly used for any Romulan vessel. The class name has been applied to another design.

## STORMBIRD CLASS CRUISER, KLINGON D-7 VARIANT

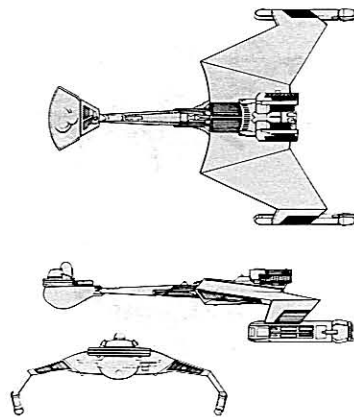

### Size Data:

#### Hull Size:

Length — 220 m  
Width — 150 m  
Height — 55 m

#### Other Data:

Weight — 110,000 mt  
Crew — 350  
Passengers — 200 troops

### Combat Data:

Known Top Speed — Warp 7

Known Armament —

Beam Weapon Type — Medium  
Number — 4  
Firing Arcs — 2 forward/port,  
2 forward/starboard

Missile Weapon Type — None, in some variants

OR Missile Weapon Type — Old-style plasma bolt

Number — 1 in some variants  
Firing Arc — forward

OR Missile Weapon Type — New-style photon  
torpedoes

Number — 2 in some variants  
Firing Arcs — 1 forward, 1 aft

### Notes:

This class is known all too well as the familiar Klingon *D-7* Battlecruiser. After about Reference Stardate 2/1001, the Romulans began using these ships in squadrons of 3 along the Neutral Zone, evidence of technological exchanges with the Klingons. The first encounter with one of these ships under Romulan command occurred Reference Stardate 2/1102 during *The Enterprise Incident*, in which Captain James T. Kirk and Commander Spock of the *USS Enterprise* were able to obtain a working model of a Romulan cloaking device for the first time.

The ships supplied to the Romulans are mostly older variants. Some seem to be identical to Klingon *D-7A* models, but most such ships are now equipped with cloaking devices. Some have been refit with Romulan beam weapons and plasma bolt generators. It is believed that the more-powerful Klingon warp engine pods are tapped directly to supply matter/antimatter mix for the plasma weapons, because the forward pod of these ships ordinarily would be too small to hold the required and bulky mix chambers. It is possible that some of these ships may be equipped with Romulan/Klingon-designed photon torpedoes.

## WINGED DEFENDER CLASS HEAVY CRUISER

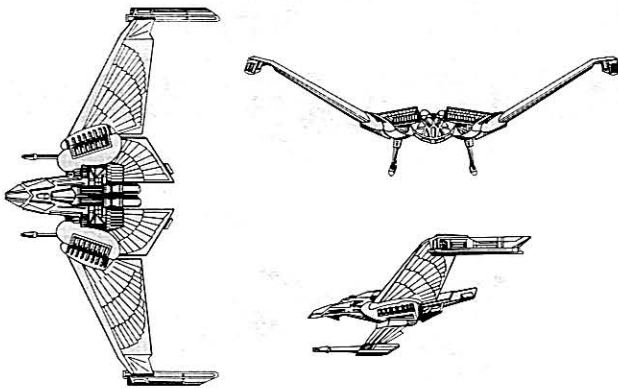

### Size Data:

#### Hull Size:

Length — 185 m  
Width — 295 m  
Height — 95 m

#### Other Data:

Weight — 200,000 mt  
Crew — 350

### Combat Data:

Known Top Speed — Warp 9

Known Armament —

Beam Weapon Type — Heavy Romulan beams  
Number — 8  
Firing Arcs — 4 forward, 1 port, 1 starboard  
1 aft/starboard, 1 aft/port

Missile Weapon Type — Heavy plasma weapon  
Number — 1  
Firing Arc — forward  
OR

Missile Weapon Type — Photon torpedoes  
Number — 2  
Firing Arc — forward

### Notes:

The new workhorse of the Romulan fleet, this vessel has been deployed along the UFP border since approximately Reference Stardate 2/1802. Equipped with a veritable arsenal of heavy beam weapons, it covers all arcs of fire almost equally well. In addition, it mounts a forward-firing plasma weapon more efficient than most. Some later variants have been observed to have Romulan/Klingon-designed photon torpedoes instead. It mounts a cloaking device and is not landing capable, but carries shuttlecraft instead.

Though there has not yet been a direct confrontation between a *Winged Defender* and an *Enterprise Class* vessel, most experts agree that the two ships are matched more closely in firepower than any pair of earlier Romulan ship and any major Federation warship.

Ships of this class seem to be everywhere, detected frequently on 'Zone-shadowing' missions, in which UFP and Romulan ships parallel each other's courses along their respective sides of the Neutral Zone. It seems, however, that individual ships are moved frequently, making estimates of their number difficult, and experts do not agree on the number of these in service. Some experts believe that the Romulans are trying deliberately to give the impression that they have far more of these ships than are really in service, going so far as to change the ships' names and assignments in a confusing manner to foster this misconception. Till now, it has not been worth risking war to find out.

## GRACEFUL FLYER CLASS SCOUT/COURIER

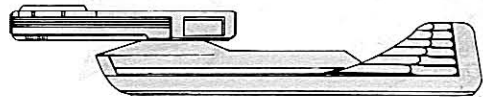
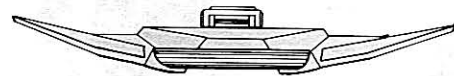
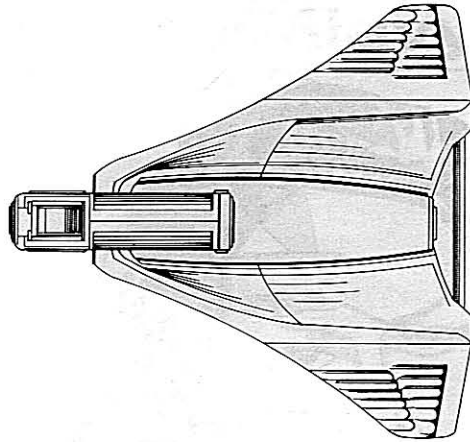

### Size Data:

#### Hull Size:

Length — 165 m  
Width — 155 m  
Height — 30 m

#### Other Data:

Weight — 50,000 mt  
Crew — 100

### Combat Data:

Known Top Speed — Warp 7

Known Armament —

Beam Weapon Type — Light to medium  
Romulan beams  
Number — 2

Firing Arcs — 1 forward/port,  
1 forward/starboard

Missile Weapon Type — none

### Notes:

Vessels of this class, not observed to be heavily armed or shielded but capable of atmospheric landings, seem to be used primarily as rapid couriers because of their ability to sustain at least Warp 7 for sustained periods. Sensor detections of *Graceful Flyers* near the Neutral Zone have decreased in recent years, though several civilian Romulan concerns still use them in and near the Triangle.

First encountered at the time of the Four Years War between the UFP and the Klingon Empire, these ships apparently were quite active in keeping the Romulans apprised of UFP and Klingon activities near their borders. The first contact occurred within the Neutral Zone area on Reference Stardate 1/9502.10, reported by an automated, zone-intrusion detection satellite. It was identified positively as Romulan by warp-train spectroanalysis, but it was found to be of a previously unknown type. Though the vessel remained in the Zone only a short time before exiting into the Triangle, its general configuration was recorded. The sighting was confirmed on several later occasions by ships within the Triangle and by intercepted subspace messages that discussed the vessel.

## BIRD OF PREY CLASS SCOUT, UPRATED VERSION

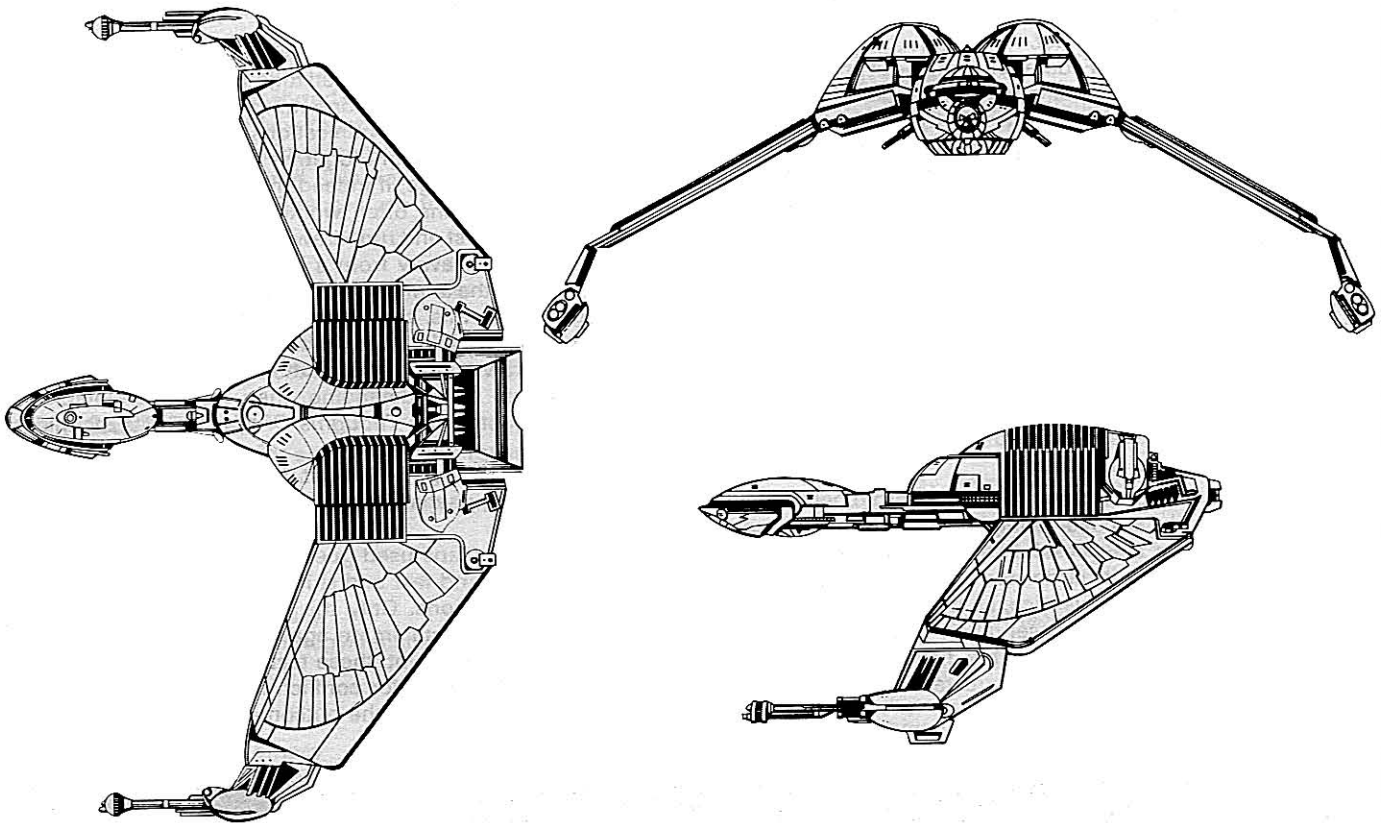

### Size Data:

#### Hull Size:

Length — 90 m  
Width — 130 m  
Height — 15 m

#### Other Data:

Weight — 38,000 mt  
Crew — 12

### Combat Data:

#### Known Top Speed —

Sustained — Warp 7  
Emergency — Warp 8

#### Known Armament, Klingon variant —

Beam Weapon Type — KD-8 Disruptors  
Number — 2  
Firing Arcs — 1 forward/port,  
1 forward/starboard

Missile Weapon Type — KP-5 Photon Torpedo  
Number — 1  
Firing Arc — forward

Known Armament, Romulan variant — unknown,  
but likely similar

### Notes:

Though not a light cruiser class, this newer vessel class has taken over the name of the venerable workhorse of the Star Empire. It is a class of armed scoutcraft designed to aid the Star Empire's new expansion efforts into hostile space. Though these vessels are no match for a Star Fleet capital ship, they are well armed for their size and quite flexible in their mission capabilities.

When Intelligence first reported its existence, this vessel class was being used in frontier regions between the Star Empire and the Gorn Alliance. At the time, only the scouting and advance guard capabilities of the class were recognized, and very little actually was known about it. It was not considered a serious development when Intelligence reported that these vessels were being supplied to the Klingons following supposed technology exchanges.

The situation changed dramatically Reference Stardate 2/2206.25. A Klingon version of this ship attacked and destroyed the *USS Grissom* in orbit about the Genesis Planet, and then ambushed the *USS Enterprise* and crippled her. No one had considered the possibility that the *Bird Of Prey* Scout, quite a small ship, could be equipped with a cloaking device, and thus become a perfect vessel for small-scale clandestine operations. The Genesis Planet, far within Federation space, ordinarily would have been thought safe from either Klingon or Romulan spy missions. Only this chance encounter with a Klingon variant revealed the new capabilities of the class.

The Romulans must have been chagrined indeed to learn from Klingon allies that their blunder had not only revealed the clandestine capabilities of the class, but also had delivered up *intact* a model of the ship to James T. Kirk and his crew. This incident leads to some nagging questions. Is this the first time the *Bird Of Prey* has been used for deep spy missions in Federation territory? If not, how many Klingon and/or Romulan vessels of similar type are even now being used to gather intelligence or prey on shipping in UFP space itself? The answers must come soon, one way or another; we may not like what we find out.

## ROMULAN STARSHIP TACTICS

Excerpted from *A Short History Of The First Romulan War*, by Adm. Richard Delgado, Ret.

When war with the Federation broke out in Reference Stardate 1/0610, the Romulans were ill-prepared to fight a prolonged war with a major power like the Federation. They had been fighting with the Klingons for a long time, which had put a severe strain on their resources, already poor.

The Romulans did not know for certain who they were fighting. Intercepted messages seem to indicate the possibility that during their first confrontations with the Federation, they thought they were fighting the Klingons. It was the discovery that they were fighting a new force that shaped the tactics they used in the war.

Even then, they did not know whether they were fighting a minor spacefaring race or a major power like themselves. In either case, they were relatively short of vessels and men to fly them. This made hit-and-run tactics, for which they later became famous, a necessity.

During the war, the Romulans used asteroid belts, small planets, and the like as cover, lying in wait for single vessels to wander by. After a successful strike or two, they shifted their location to make it harder for them to be discovered. To them, this was not cowardice, as it would have been to the Klingons, but merely conservation of forces. A quote from *Thoughts Of War*, a possibly fictional work found among the *Eridam Papers*, gives substance to this point of view.

*To hide is not cowardice. Neither is avoiding combat when the odds are not in your favor. It is using your limited resources to their best potential.*

The Romulans did not run when confronted, but fought and fought well. They worked together, vessels coordinating attacks as if directed by one mind. Monitored communications revealed no communications in combat. Evidently the ships' crews had fought together so long they acted as one, a distinct advantage, if indeed this is the case.

The Romulans often worked in pairs. The first vessel would strike first and run, drawing out the defending vessels in a convoy or away from a base. Then the second vessel would strike the unprotected target. When Federation officers caught on to this, the Romulans employed a third vessel whenever possible, using what came to be known as the 'double draw method.' When the second vessel would draw out the last ships defending, then the third would strike. Another quote from *Thoughts Of War* emphasizes this.

*Work together. Strike fast. Hit and withdraw before they know what hit them.*

The Romulans used guerilla tactics to their advantage, striking hard and fast and shifting the battleground to their choice of locations. Only the Federation's superior forces allowed them a stalemate against the Romulans' superior tactics. Without doubt, these tactics will be used against us again in a future major conflict. Next time, given their advances in technology, the outcome might be different.



## TYPICAL ROMULAN NAVAL OFFICERS

Because Star Fleet officers need a guide for evaluating the Romulan naval personnel they are likely to encounter, Star Fleet psychologists analyzed sub-space radio communications and transcripts of face-to-face interviews with Romulans, provided by Star Fleet Intelligence. Computer generated average Attribute Scores and Skill Ratings are provided in this section. Individual differences are to be expected, of course.

### ATTRIBUTES

The attributes of a typical Romulan career naval officer are given in the table below.

STR 50 + 2D10	END 50 + 2D10	INT 50 + 2D10
DEX 55 + 2D10	CHA 40 + 2D10	LUC 35 + 2D10
PSI 20 + 2D10		

### SIGNIFICANT SKILLS

The significant skills for a wide range of ranks and positions are given in the table below. Combine them for a thumbnail analysis of a high-ranking specialist.

#### Commander

Administration	40 + 2D10
Leadership	60 + 2D10
Negotiation/Diplomacy	40 + 2D10
Starship Combat Strategy/Tactics	50 + 2D10

#### Sub-Commander

Administration	30 + 2D10
Leadership	50 + 2D10
Negotiation/Diplomacy	40 + 2D10
Starship Combat Strategy/Tactics	40 + 2D10

#### Centurion

Starship Helm Operation	
or	
Starship Weaponry Operation	40 + 2D10
Starship Sensors	30 + 2D10
Starship Combat Strategy/Tactics	20 + 2D10



#### Security Guard

Marksmanship, Modern Weapon	60 + 2D10
Security Procedures	40 + 2D10
Small Unit Tactics	30 + 2D10
Unarmed Personal Combat	60 + 2D10

#### Engineering Officer

Cloaking Device Technology	
or	
Starship Weaponry Technology	
or	
Warp Drive Technology	50 + 2D10
Space Sciences, Astronautics	50 + 2D10
2 Technical Specialties	50 + 2D10

#### Science Officer

Computer Operation	30 + 2D10
Starship Sensors	30 + 2D10
2 Science Specialties	55 + 2D10

#### Medical Officer

General Medicine, Romulan	50 + 2D10
Pathology	40 + 2D10
Psychology, Romulan	30 + 2D10
Surgery	40 + 2D10

#### Administrator

Administration	50 + 2D10
Leadership	40 + 2D10
Negotiation/Diplomacy	30 + 2D10

#### Diplomat

Administration	40 + 2D10
Language	20 + 2D10
Leadership	20 + 2D10
Negotiation/Diplomacy	50 + 2D10

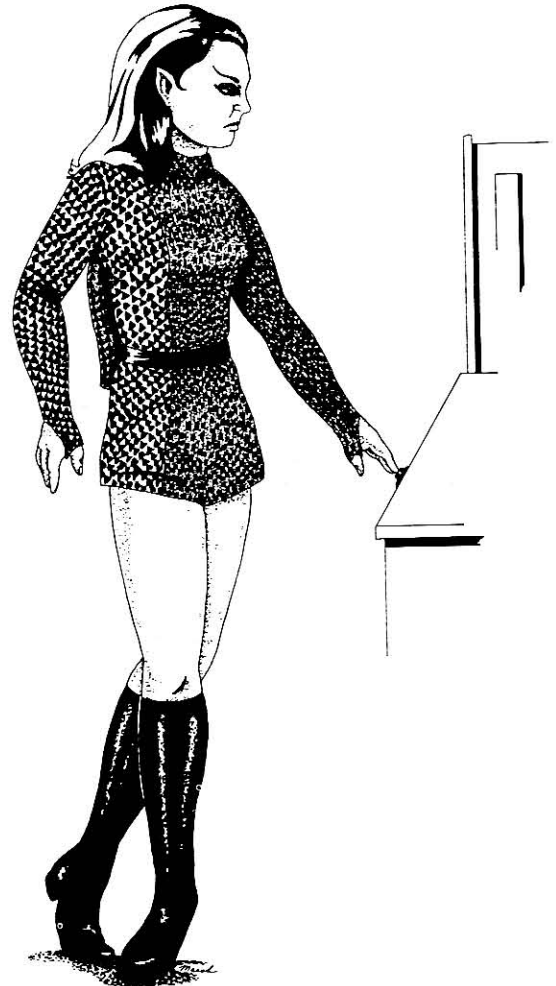

# Equipment

## PERSONAL EQUIPMENT

This section contains descriptions of many common pieces of personal equipment available to Romulans. In many cases, the equipment will be very similar to Federation equipment. In these situations, simply refer to the appropriate sections in the **Cadet's Orientation Sourcebook**. The appearance of these pieces of equipment may be very different, but they will function exactly the same unless otherwise specified.

### ANTIGRAV

These units function as Federation units do.

### COMMUNICATOR

This transmitter/receiver is a small, cylindrical unit, about 7.5 cm tall and 4 cm in diameter. The front third of the cylinder slides down, revealing a small speaker grid and a tuning dial. When the cover is fully extended, the antenna rises about 1 cm out of the top, lowering again when the cover is pushed back into the closed position.

The communicator has the same maximum range as a Star Fleet unit, about 26,000 km (16,000 mi), and the same transmission characteristics. Like the Federation communicator, it may be used for person-to-person or person-to-ship voice communications as a homing device. In addition, it has a small jack in the bottom that may be connected to various pieces of equipment for transmission of data back to the ship's computer.

Some Romulans use Klingon-designed communicators as well as their own.

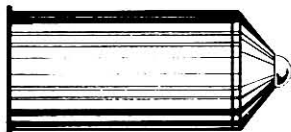

Top

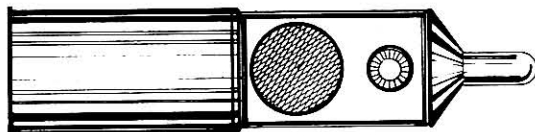

Top (open)



Side (open)

### EARPIECE RECEIVER

These devices, like those of Star Fleet, are used extensively in personal communications aboard starships. Unlike the Federation units, these have a standard shape and are held to the ear during conversations. The user's replies are picked up by a microphone built into all consoles.

### ENVIRONMENTAL SUIT

These suits are functionally equivalent to the suits worn by Federation personnel.

### ID CARD

All Romulans, citizens or not, are issued a plastic information card containing coded citizenship and military information, personal and medical histories, security clearances, and the like. They are very difficult to forge.

### IMAGE RECORDER/PROCESSOR

The image recorder/processor, the functional equivalent of the Federation tricorder, is used heavily by Romulan science specialists and medical personnel. Somewhat gun-shaped, the unit is pointed toward the object to be recorded, very much like a portable television camera. The unit can be operated by pulling the trigger, or it may be set for hands-free operation by manipulating the controls on the top. The small screen on the back may be used to call up and view any information in the memory, which stores about 2 hours of continuous information. A small jack in the bottom of the grip allows the unit to be patched into the communicator for broadcast back to the ship's computers; one-burst transmission takes about 10 seconds, relaying all the information in the memory.

A large array of photocells atop the unit will operate even indoors in room light, and will keep the unit's batteries fully charged. In the event the unit must be operated in darkness, batteries will power the unit for about 6 hours.

As a portable sensor, the unit is more directional than the box-type Federation tricorder, but less so than the later-period UFP directional sciences tricorder. A single scan covers 90° of arc, requiring 4 scans to cover a complete circle. The range and sensitivity of this device are inferior to the Federation tricorder, as shown on the following table:

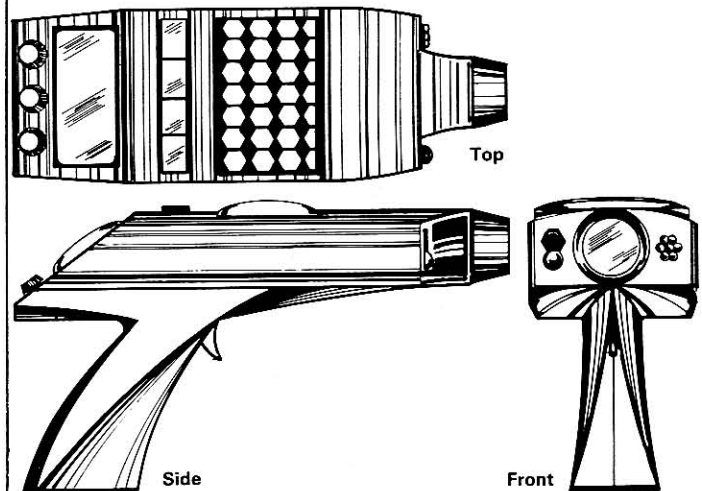

### IMAGE TRICORDER PROCESSOR

Scan	Type	Information	Range
Energy Source	General	Direction, Distance	750
	Specific	Identification of type	80
	Determinative	Level of output	5
Physical Comp.	General	Direction, Distance	750
	Specific	General composition	80
	Determinative	Complete chemical composition	1.5
Life Forms	General	Presense	400
	Specific	Number & type	80
	Determinative	Biological data	1.5

## UNIFORMS

The basic uniform for Romulan naval personnel is shown in the illustration. Females may wear either the same uniforms as males, including the trousers, or they may substitute a short dress.

The top half of all uniforms is dark-grey and the bottom half is blue. Uniforms are fashioned from a very light-weight, opaque mesh that allows the wearer to be much cooler than uniforms with a tighter weave.

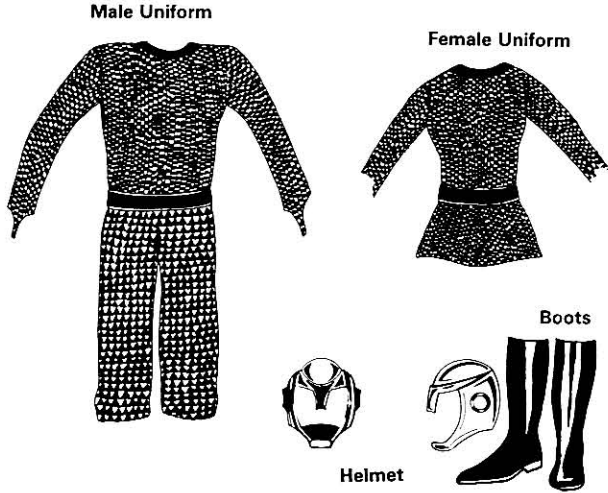

## Rank Insignia

All but the lowest two ranks wear sashes as shown in the illustrations. It is reported that the sashes and their colors denote rank, but rank insignia are commonly seen on the right shoulder, acting as a clasp if a sash is worn. These insignia are shown in the illustrations.

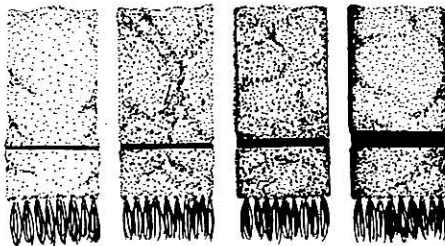

Equitorian    Secundum    Trinam    Centurian    Sub-Commander    Commander

## Salute

The Romulan military salute is performed by bringing the right fist, knuckles outward, up to the left chest with forearm stiff across the chest. The motion is performed crisply and held for a moment before allowing the arm to return to the side.

## TRANSLATOR

The Romulans have no version of the universal translator, using living translators or, infrequently, the ship's computer as a very sophisticated translation device, relayed through a communicator.

## DUELING STICK

The dueling stick is usually a short rod 25 cm in length, with a slight enlargement at one end and a roughened hand grip at the other. The stick is weighted and balanced like a fighting dagger. Most Romulan citizens have some training with this weapon, as it is used extensively in physical training and combat exercises.

In use, a knob below the handgrip is turned to one of two active positions. The first is the tip setting, which only energizes the enlarged end so that the stick may be used to simulate fighting with thrusting weapons. The second setting energizes the whole stick from the handgrip forward. Simply making contact with the opponent is enough to deliver a mild stun shock. If contact is solid enough, a larger jolt is transmitted.

A longer version is also available which is used like a sword, but it is not as widely used as the knife-sized model. Physically, it looks like the small model, with a longer shaft.



## MEDICAL EQUIPMENT

### ELECTRONIC SCALPEL

Romulan surgeons use a pencil-shaped object with a very thin wire at the tip. This wire is vibrated fast enough that it will cut through most tissue as easily as would a Federation laser scalpel. The internal battery will last for about one hour's continuous use before it requires recharging.

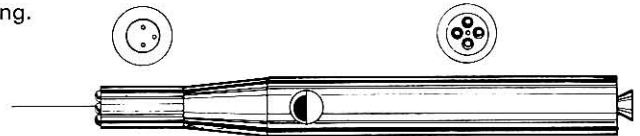

### HYPHO

This gun-shaped device has a slender barrel mounted on a squarish grip. An air cartridge in the grip supplies the injecting power. On top, a small panel not only controls the dosage, but also shows how much air pressure is left.

In use, the unit is pressed against the skin of the patient, and the trigger is pulled. The medication is forced from a gelatin capsule, which has been placed in a small opening just in front of the top panel. The sliding cover is closed, and the trigger is pulled. The expended capsule is vaporized in the process of the injection. For large-scale inoculations, a 10-capsule clip is available that attaches over the capsule chamber cover.

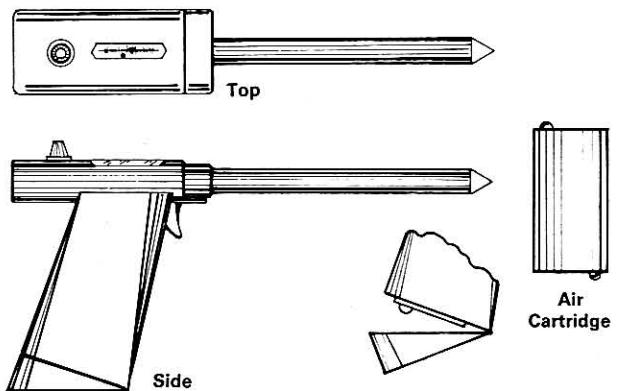



### MEDICAL BELT

To hold their equipment, Romulan medics use a version of the wide leather belt worn with all Romulan uniforms. These belts have numerous small pockets, compartments, and hooks from which or in which the medical equipment can be hung or placed, ready for instant use.



### MEDICATION POUCH

This small pouch holds 8 different types of medication capsules. Each compartment can hold 10 capsules each, and one capsule may be dispensed at a time by pushing the button on the appropriate compartment.

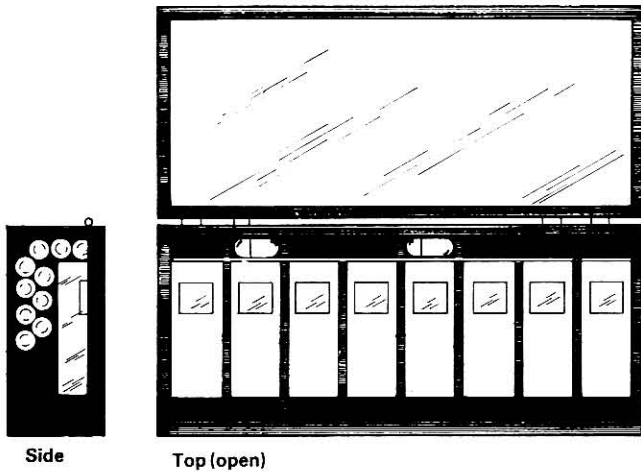

### PORTABLE POWER SUPPLY

This small (5 cm by 10 cm) folding photocell has a short cord that attaches to many of the smaller pieces of medical equipment and is used to charge their internal batteries. It is very efficient, and will charge a normal tool in approximately 20 minutes.

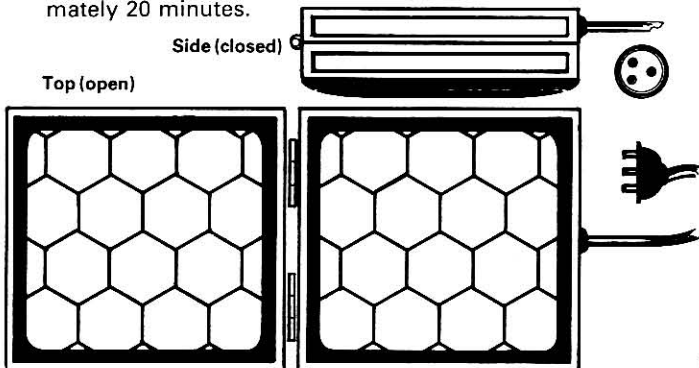

### PROTOPLASER

Other than size and shape, the function and use of these units are identical to those supplied to Federation doctors.

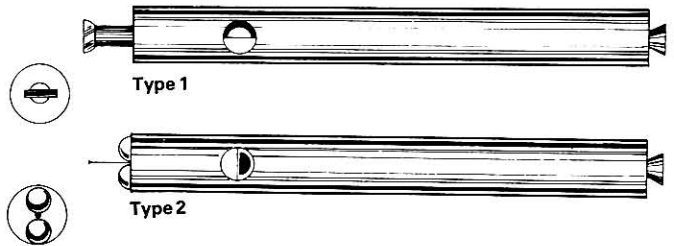

### VITAL SIGNS READER

This unit, used by Romulan doctors instead of the Federation Feinberger, is long and cylindrical, with a long cord attached to its back that plugs into the image recorder/processor. Although clumsier and bulkier than the Federation unit, it is capable of giving more information to the user by displaying this information on the screen of the image recorder/processor.

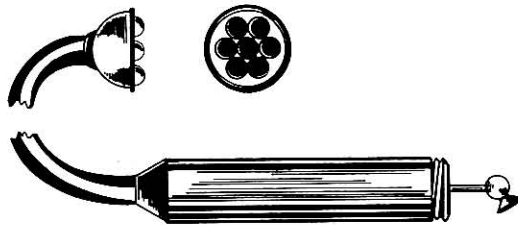

## SIDEARMS

### HAND DISRUPTOR, KLINGON MARK I DESIGN

As a result of their treaties with the Klingon Empire, the Romulans have made heavy purchases of the Klingon's versatile Mark I Hand Disruptor. Because Romulan hand weapons have several disadvantages in comparison to the Klingon model, the Klingon Disruptor was eagerly appropriated for use by the Romulan Star Empire. Now, with a few purely cosmetic differences, it is the standard sidearm of Romulan military forces, though some exploration and colonization units are still equipped with the original Romulan disruptor.

The solar charging feature of the Romulan disruptor has not been incorporated into Romulan-manufactured disruptors of Klingon design. The Klingon circuitry requires more power and is not easily adaptable to solar charging. The Romulans have made the field grids shielding the beam exciter cylinder less vulnerable to damage, freeing the Romulan variety from grid misalignment failure if dropped or mishandled.

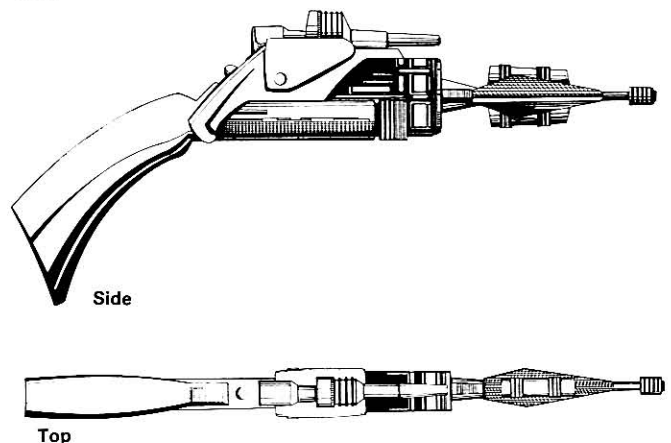

**HAND DISRUPTOR, ROMULAN DESIGN**

Until they discovered the Klingon Mark I Hand Disruptor, the principal sidearm of the Romulan Star Empire was a small unit that strapped to the back of the hand. It is fired by pointing the fist at the target and pressing a firing stud, set in the buckle so that it lies in the palm, with the middle finger. A small knob tunes the beam.

Photocells atop the unit keep the unit's batteries charged. They have a limited capacity for recharging the weapon in the field, but the weapon must be switched to charge mode for this purpose. When in charge mode, the weapon will not fire.

The Romulan-designed hand disruptor fell into immediate disfavor when the Klingon version became available. It is somewhat fragile, clumsy to recharge in the field, and takes about one minute to strap on. In principle, however, it works the same as the Klingon disruptor.

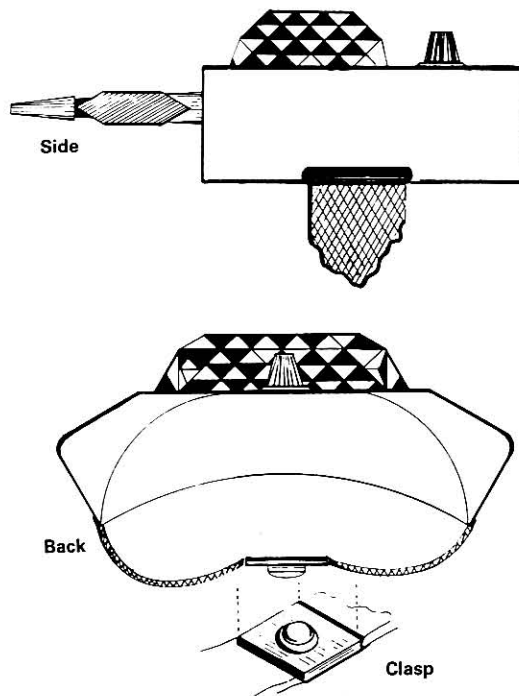

**DISRUPTOR RIFLE, KLINGON DESIGN**

The rifle-type disruptor used by Romulan forces is identical to the Klingon unit, and was adopted by the Romulans at the same time as the Klingon Mark I Klingon Hand Disruptor. It is used mostly by ground forces or security teams on alert status.

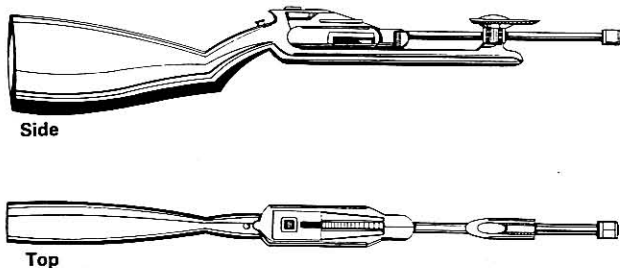

**WOUND DRESSING PADS**

Romulan doctors use organic bandages instead of foam dressings. They are porous enough that air may pass through to help heal the wound, and their inner layer is designed to integrate with the new tissue being formed. When the wound is nearly healed, the pad dries out and falls off.

**BEAM WEAPON**

The major beam weapon used by the Romulan fleet in actions after the UFP/Romulan War is an enhanced form of x-ray laser. The beam makes use of the phasing effect that is the major principle behind the UFP's phaser weapons. Though the Romulans had phased weapons long before the UFP made the phaser standard equipment, the Romulan beam only uses the phasing principle to enhance the destructive force of the beam and the phasing effect is not used to directly disrupt molecular structure.

The Romulan beam weapons have comparable ranges, but they have a greater weight-to-damage effect ratio and are bulkier and heavier than the equivalent Federation ship-mounted phaser. Much of the extra weight is due to the use of a bulky cooling system that uses a heavier liquid coolant not as dangerous as the efficient coolant in Federation phasers.

The Romulan beam weapon principles cannot be scaled down effectively for hand weapons, and so the Romulans usually prefer to use simple, easy-to-service disruptor sidearms similar to those used by the Klingons.

**CLOAKING DEVICE**

The Romulan cloaking device is the Star Empire's most closely-guarded secret. In operation, the device makes a ship invisible to either sensors or the naked eye. The device bends light waves, sensor scans, and other forms of information-carrying electromagnetic waves around the ship entirely. Thus, someone looking at a cloaked vessel will see only a background of stars beyond the ship, and sensor beams travel out and around the cloaked vessel without detecting it.

A cloaked ship can only be detected if it is in motion. This is accomplished by scanning for DeBroglie-type motion waves. Even this sort of scan will only tell where the ship has been recently, and in what direction it was moving. The data gathered in this way is very imprecise.

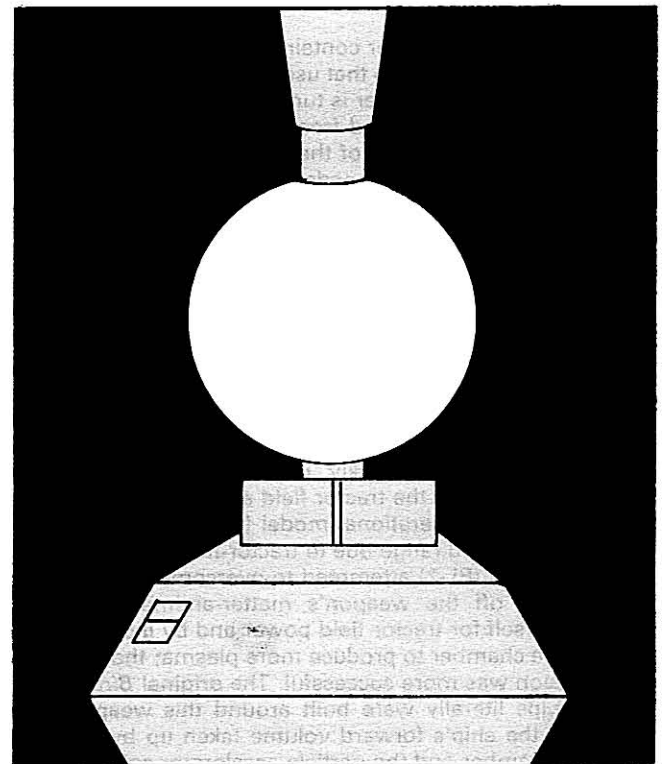

*Marshall*

Romulan cloaking devices have the drawback of drawing a great deal of ship's power. Most cloaked vessels cannot operate shields, weapons, or other power-expensive equipment such as transporters while the cloak is active. The cloak takes only a few seconds to activate or deactivate, but even this much time in a visible state is enough to render the ship quite vulnerable. This restriction limits the device's best use to concealment while a ship positions itself for a devastating surprise attack. Once a cloaked vessel's presence is known, scans for motion waves, computer course projections, and good tactical maneuvering can reduce substantially the device's usefulness in combat. Traditionally, the Star Empire has used the cloaking device to conceal a raiding ship's entry into enemy space until it can locate a vulnerable target and to help the raider return to Romulan space.

The cloaking device is one of the most important tools for assuring the security of the Romulan Neutral Zone. Despite the fact that the Federation has managed to capture cloaking devices intact, it has proved impossible to duplicate them, or even to get captured models to work consistently on other ships.

One captured cloaking device was taken in a clandestine operation involving Capt. James T. Kirk and Cmdr. Spock of the *USS Enterprise*. The device was successfully installed on the *Enterprise* and used to assure the ship's escape; even so, the next time the captured device was used, the vessel it was to have cloaked disappeared forever. A second device, captured intact aboard a Klingon *Bird of Prey* scoutship in the aftermath of the infamous Genesis Planet incident, has also failed to function, even though it was left intact aboard the Klingon vessel. Other devices captured with or without their ships in the past have either failed to function or, usually, explosively destructed when detached from their mountings. All efforts to discover the self-destruct circuits have failed.

### PLASMA BOLT WEAPON

The Romulan plasma bolt weapon produces a jet of white-hot plasma (a state halfway between matter and pure energy), which is channelled at the target, guided by a magnetic tractor-pressor field similar to the tractor beams used by many vessels for towing or grappling objects in space.

The plasma chamber contains a controlled matter-anti-matter mixture similar to that used in a warp engine. Matter pumped into this chamber is turned to a superheated, ionic plasma, which is skimmed from the mixture magnetically. The destructive potential of the plasma jet is enhanced by the addition of particles speeded up in a particle accelerator and guided to the weapon's muzzle through magnetically-shielded, ceramic tubes.

At the exit point, the plasma stream is picked up by a tubular, magnetic, tractor-pressor field. This field is extended from the ship and the plasma bolt pushed through it to the target. It must be maintained during the plasma's trip through space, or the plasma quickly disperses, its destructive force lost. Even with the field, the plasma cools rapidly. This, coupled with the limited range of the tubular tractor field, limits the effective range of the plasma bolt. The destructive potential drops off quickly until the bolt reaches the maximum range of the tractor field and disperses.

The earliest operational model (UFP designation RL-1) had a very limited range due to tractor-field limitations. The second model (RL-2) attempted to overcome this limitation by feeding off the weapon's matter-antimatter reaction chamber itself for tractor field power and by increasing the size of the chamber to produce more plasma; though huge, this version was more successful. The original *Bird Of Prey* Class ships literally were built around this weapon, with much of the ship's forward volume taken up by the huge plasma chamber and the particle accelerator coils.

Improvements in tractor field technology seemed unable to make much headway in extending the range. Nevertheless, a new plasma compression technique was discovered that made it easier and less energy-expensive to produce usable plasma. Furthermore, the plasma produced tended to cool less quickly. Thus, though the third operational version (RL-3) has only slightly better range and a lower overall damage potential than the RL-2, it maintains its damage potential longer, takes up far less room, and is far less wasteful of energy.

### TRANSPORTER

The Romulans did not develop the transporter until somewhat later than the Klingons, though their development group was still ahead of the Federation by several years. Their systems use the superheterodyning carrier wave that causes Federation transporters to be noisy (as opposed to the silent Klingon variety), but they have not adopted improvements that allow late-period UFP transporters to break down, transmit, and reassemble matter without suspending its motion first.

Romulan transporter designs are as efficient and safe as the Federation models, but they are still not a favored means of transportation. Most Romulans prefer to ride in a shuttlecraft or land on a planet directly, using the transporter only when it is significantly more convenient than other options. This is one reason why more Romulan ships have landing capability than is found in UFP fleets.

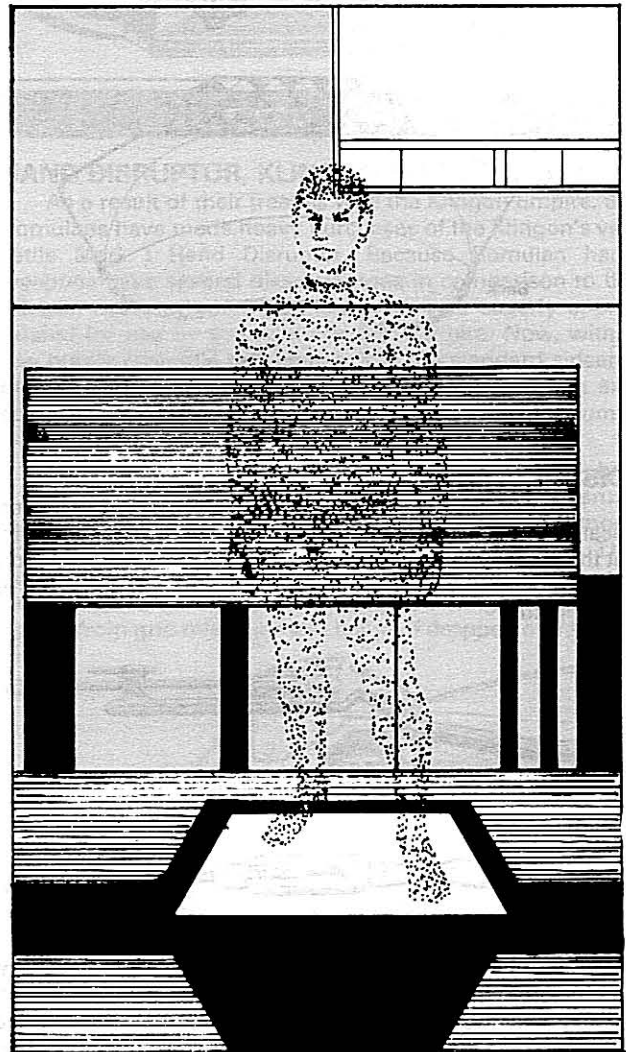



# THE ROMULANS: STARFLEET

# INTELLIGENCE MANUAL

**UNITED FEDERATION OF PLANETS**

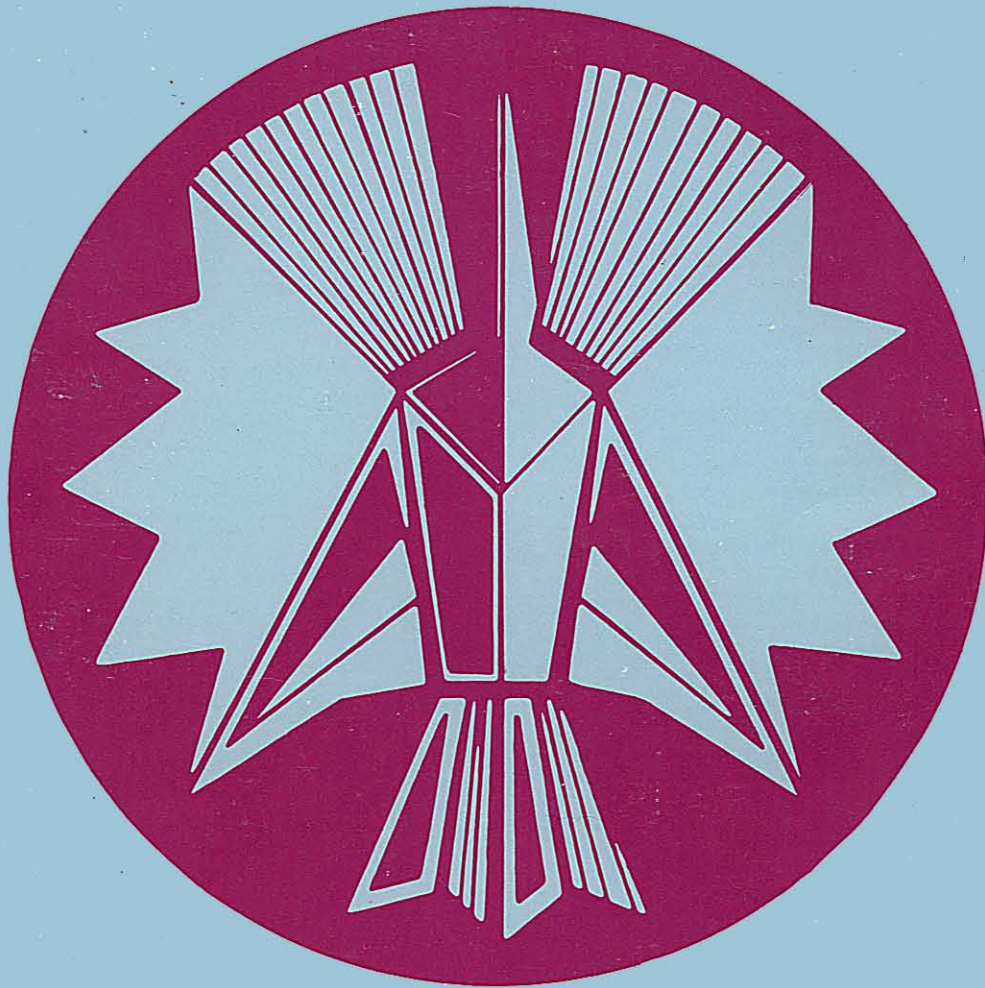

**THE ROMULAN WAY:  
GAME OPERATIONS  
MANUAL**

**STAR TREK**®  
THE ROLE PLAYING GAME

# Table Of Contents

<b>INTRODUCTION</b>	3
<b>Adventures For Romulan NPCs</b>	3
Mainstream Designs	3
Late History Designs	3
Merchant Character Designs	3
<b>Planetside Adventuring With Romulan</b>	
<b>Player Characters</b>	3
Romulans Vs. Klingons	4
Romulans Vs. The UFP	4
<b>THE ROMULAN STAR EMPIRE</b>	5
<b>History</b>	5
The Vulcan Heritage	5
The Impact Of Environment	5
<b>Time Line Of Major Events</b>	6
<b>Extents Of The Romulan Empire</b>	12
The Empire Map	12
Defense Complexes	12
Border Posts	12
Starbases	12
Frontier Outposts	12
<b>Interstellar Interactions</b>	20
Gorn Alliance	20
Klingon Empire	21
United Federation Of Planets	22
<b>THE ROMULAN PEOPLE</b>	23
<b>Personality Traits</b>	23
<b>Religion</b>	23
Family Shrines	24
<b>Stages In Life</b>	24
<i>D'Navassa</i> : The Great Beginning	24
The First Year	24
<i>D'Sora</i> : The Great Age	24
<i>Phi'Lasasam</i> : The Education	24
<i>D'Talla</i> : The Great Duty	25
Career Military Service	26
<i>D'Anna</i> : The Great Joining	26
<i>Latta</i> : The Departing	26
<b>Government</b>	27
City-State Level	27
Regional Level	27
Military Senate	27
Imperial Level	27
<b>The Unseen Ones: Romulan Outcasts</b>	28
<b>Medical Aid And Romulan Medical Philosophy</b>	28
<b>THE ROMULAN IMPERIAL NAVY</b>	29
<b>Organization</b>	29
Exploration Division	29
Outpost Division	29
Colonization Division	29
Military Division	29
<b>Rank And Position</b>	30

<b>Starship Recognition File</b>	31
<i>Songbird</i> Class Shuttlecraft	31
<i>Billed One (Duck-Of-Doom)</i> Class Heavy Shuttlecraft	31
<i>Praetor</i> Class Warpshuttle	32
<i>Bird Of Prey</i> Class Light Cruiser, Original Version	32
<i>Stormbird</i> Class Cruiser, Klingon D-7 Design	33
<i>Winged Defender</i> Class Heavy Cruiser	33
<i>Graceful Flyer</i> Class Scout/Courier	33
<i>Bird Of Prey</i> Class Scout, Upated Version	33
<i>Aviary</i> Class Defense Outpost	33
<b>JUDGING THE ROMULAN WAY</b>	34
<b>Judging Ground Action</b>	34
Injury, Medical Aid, And Death	34
<b>Judging Equipment Use</b>	34
Personal Equipment	34
Uniforms	34
Sidearms	35
Shipboard Systems	35
<b>Judging For Romulan Player Characters</b>	36
Player Character Roles	36
The Information Gap	36
Hints About Play	36
<b>CREATING ROMULAN CHARACTERS</b>	37
<b>Defining Romulan Characters</b>	37
Attributes	37
<b>Creating Romulan Characters</b>	37
Assigned Ship, Rank, And Postion	37
Choosing A Race	37
Creating Attribute Scores	37
Creating Endurance Statistics	38
Character Aging	38
<b>TRAINING PLAYER CHARACTERS</b>	40
<b>The Education</b>	40
The Beginning	40
The Broadening	40
Core Curriculum Specialty	41
The Coming Together Of Knowledge	42
<b>The Great Duty</b>	42
Officer Efficiency Ratings (OER)	42
Fifth-Year Training	42
Skill Improvement	42
<b>Advanced Officer's Training</b>	43
Core Curriculum	43
Specialty Skills	43
<b>Service Experience</b>	43
Number Of Tours Served	43
Tour Assignment	44
Tour Length	44
Tour Skill Advancement	44
<b>Combat Statistics</b>	44
Action Points (AP)	44
Base To-Hit Numbers	45
Bare-Hand Damage	45
<b>Character Age</b>	45
<b>GAME DESIGNER'S NOTES</b>	46

## THE ROMULANS

A supplement for use with *Star Trek: The Role Playing Game*

### Design:

*Fantasimulations Associates*

David F. Tepool  
Guy W. McLimore, Jr.  
Greg K. Poehlein

### Development:

*FASA Design Staff*

Wm. John Wheeler  
Forest G. Brown

**Writing:** Fantasimulations Associates

**Editing:** Wm. John Wheeler

### Production:

*Graphics And Layout*

Dana Knutson  
Todd Marsh  
Jordan Weisman

*Illustration:*

Norman Miller  
Dana Knutson  
Todd Marsh

*Typesetting:* Karen Vander Mey

*Proofreading:* Donna Ippolito

STAR TREK is a trademark of Paramount Pictures Corporation.  
STAR TREK II: The Wrath Of Khan products are published by FASA Corporation under exclusive license from Paramount Pictures Corporation, the trademark owner.

STAR TREK: The Role Playing Game is published by FASA Corporation under exclusive license from Paramount Pictures Corporation, the trademark owner.

Copyright © 1984 Paramount Pictures Corporation  
All Rights Reserved  
Printed in the United States of America

No part of this book or the contents of the basic game may be reproduced in any form, or by any means without permission in writing from the publisher.

Published by FASA Corporation  
P.O. Box 6930  
Chicago, Illinois  
60680-6930

# Introduction

This section includes information for gamemasters who wish to design or judge encounters, adventures, or campaigns that use Romulans prominently. The rules and information here will be useful as well to players who desire to have Romulan player characters. These rules and information present the Romulans as they are seen through **STAR TREK III: The Search For Spock**.

Gamemasters who are running mainstream adventures or campaigns – that is, campaigns centered around the activities of Star Fleet officers as player characters – will be able to use the detail and background in this set to flesh out the Romulans as a non-player race. Other gamemasters may wish to run adventures or campaigns in which the player characters themselves are Romulan officers, with the non-player foes being from the UFP or the Klingon Empire.

## ADVENTURES FOR ROMULAN NPCs

### MAINSTREAM DESIGNS

Adventures or campaigns set during the **STAR TREK** TV series should begin after Reference Stardate 2/0709.22, the date when UFP forces actually saw a Romulan, as depicted in the series episode *Balance of Terror*. That episode marked the first recorded incursion across the Neutral Zone since its establishment in Reference Stardate 1/0909. Encounters between Romulans and Star Fleet before this date would take place in an alternate universe where things happened differently than in the TV series.

Adventures or campaigns set at this time could involve UFP ships patrolling the Neutral Zone. A number of unofficial incidents occurred between Star Fleet ships and Romulan raiding vessels at this time, and there were several instances of accidental penetration of the Zone by UFP merchant ships or civilian vessels. The player characters could be assigned a patrol zone along the Romulan border, involving the players with other UFP shipping, border posts, merchant and civilian traffic along the frontier, and – inevitably – with their opposite numbers in the Star Empire's service just across the Neutral Zone.

Matching wits on a regular basis with a well-rounded group of non-player foes can be quite exciting. The rules sections on **Character Creation** and **Character Training** will allow gamemasters to create non-player Romulan characters that can serve as these interesting antagonists. The section on **Romulan Starships** will provide information on creating a vessel used by the Romulan NPCs.

### LATE HISTORY DESIGNS

Using this expansion set in conjunction with the **STAR TREK III Sourcebook Update** allows the gamemaster to set campaigns at the time of the **STAR TREK** movies. At this time, the cold war between the UFP and the Star Empire has cooled somewhat, but the technological exchanges between the Romulans and the Klingons have made Romulan ships more dangerous than ever.

Latter-day Romulan ships are better armed and more viable in one-on-one conflict against UFP ships of comparable size, particularly after Reference Stardate 2/1301, when Romulan ships begin to be equipped with true photon torpedoes. Politics in the border areas is particularly touchy during this time. The Romulan government does not wish war with the UFP, but the conservative factions within the

Star Empire warn against allowing the UFP "too much slack" in border disputes. The situation is quite volatile and can go either way.

Unless the Romulans or the UFP have undergone a major philosophical change, conflict is inevitable. The UFP is in the Romulan sphere of expansion, and thus in their "way to the stars." Adventures or campaigns set at this time could be quite interesting, as the cold war heats up.

### MERCHANT CHARACTER DESIGNS

Adventures and campaigns using merchant characters or other civilians can be designed in conjunction with **Trader Captains and Merchant Princes**. These campaigns may be enhanced by setting them near Romulan space. During the time of the TV series, the area of space known as The Triangle is first exploited. Star Fleet actions in this area are still few and far between, but civilian mining, agricultural, and trading interests have moved in, closely watched by both the Romulan Star Empire and the Klingon Empire.

A merchant ship operating in or near The Triangle might well deal with Romulan ships often. Romulan agents could operate freely, perhaps posing as Vulcan traders, and Human traders may moonlight as spies and traitors, selling information to Romulan agents.

Merchant designs during the time of the **STAR TREK** movies would occur in the Triangle's boom period. A number of small unofficial governments would be set up, and much trade and mining activity would be occurring. This is not yet regulated by the UFP, the Klingon Empire, or the Romulan Star Empire, who realize that they have been lax about extending their control over this area, once thought mostly useless but subsequently proved to be rich in valuable minerals and a thriving underground arena for trade. These governments would like to carve out large chunks of the action for themselves, but the small pocket governments and special interest groups that have established the area are actively resisting the change. This is a time of adventure and excitement, akin to Terran North America in its western territories during the beginnings of Human industrial expansion across that continent.

## PLANETSIDE ADVENTURING WITH ROMULAN PLAYER CHARACTERS

Creating planetside adventures using Romulans as player characters is not much different than with Star Fleet characters, but the players' approach to such adventures is likely to be much different (if they are playing their roles properly). Unlike the Klingons, the Romulans are not interested in conquest for conquest's sake alone. They are in need of resources, and will pursue new sources of materials and manpower (subject races) with great urgency.

Romulan officers seek service in the Exploration branch because prestige in the service is best gained by opening up new resources to the Star Empire. Officers assigned to this division, especially to larger ships and ships assigned to first contact duties, are likely to be the best the Star Empire can offer.

Use the procedures in the STRPG2 rules to generate "strange new worlds, new life and new civilizations" for Romulans to encounter and dominate. The Romulans will conquer those who stand in the way, but they have been



known to accept as "fellow travellers" races and individuals whose goals and ambitions do not conflict with their own. Unlike the Klingons, the Romulans do not classify all beings as either "our own kind" or "enemies." The Romulans have friends among alien races, though it is unlikely they have any who have developed interstellar travel independently. After all, any other space-travelling race is a rival for the same resources the Romulans seek and would likely be conquered or exterminated.

### ROMULANS VS. KLINGONS

Adventures and campaigns need not involve the UFP at all in the bulk of the action. There's plenty of excitement along the Romulan/Klingon borders at any time from Reference Stardate 0/0001.30 (long before Terrans had left their home system) right through the events of *STAR TREK III*. Though the scope of this expansion only covers the post-UFP period in detail, combined with **The Klingons** expansion, it allows players to play out interesting Klingon/Romulan conflicts.

Campaigns set between Reference Stardate 1/2312 and 2/0902 can be filled with combat action, as the players deal with a continuing series of border disputes. These disputes cool down a bit after the first technological exchange treaties, but only on the surface. Even after the treaties, both sides

conduct raids (mostly as "privateers", without official sanction of their governments) on each other's merchant shipping and frontier outposts and settlements. A Romulan captain on such missions would have to be crafty, experienced and very lucky indeed!

Adventures or campaigns also can be run with player characters on either side of the conflict. Experienced gamemasters with large player groups might find it interesting occasionally to have some players running Romulan characters and others running Klingons. This is guaranteed to be difficult to run as a gamemaster, but richly rewarding in terms of fun and excitement. It is not recommended for gamemasters with weak hearts, fragile egos, or easily-strained friendships among the players!

### ROMULANS VS. THE UFP

Romulan player characters can interact frequently with UFP characters. Such characters will participate in the cold war between these two powers as explained in the section above on mainstream campaigns, only from the other side. Most of the suggestions given in that section can be turned around for Romulan player characters, including establishing a continuing foe or two on the other side, by creating a UFP starship and its crew as non-players assigned to the same section of the Neutral Zone as the player characters.

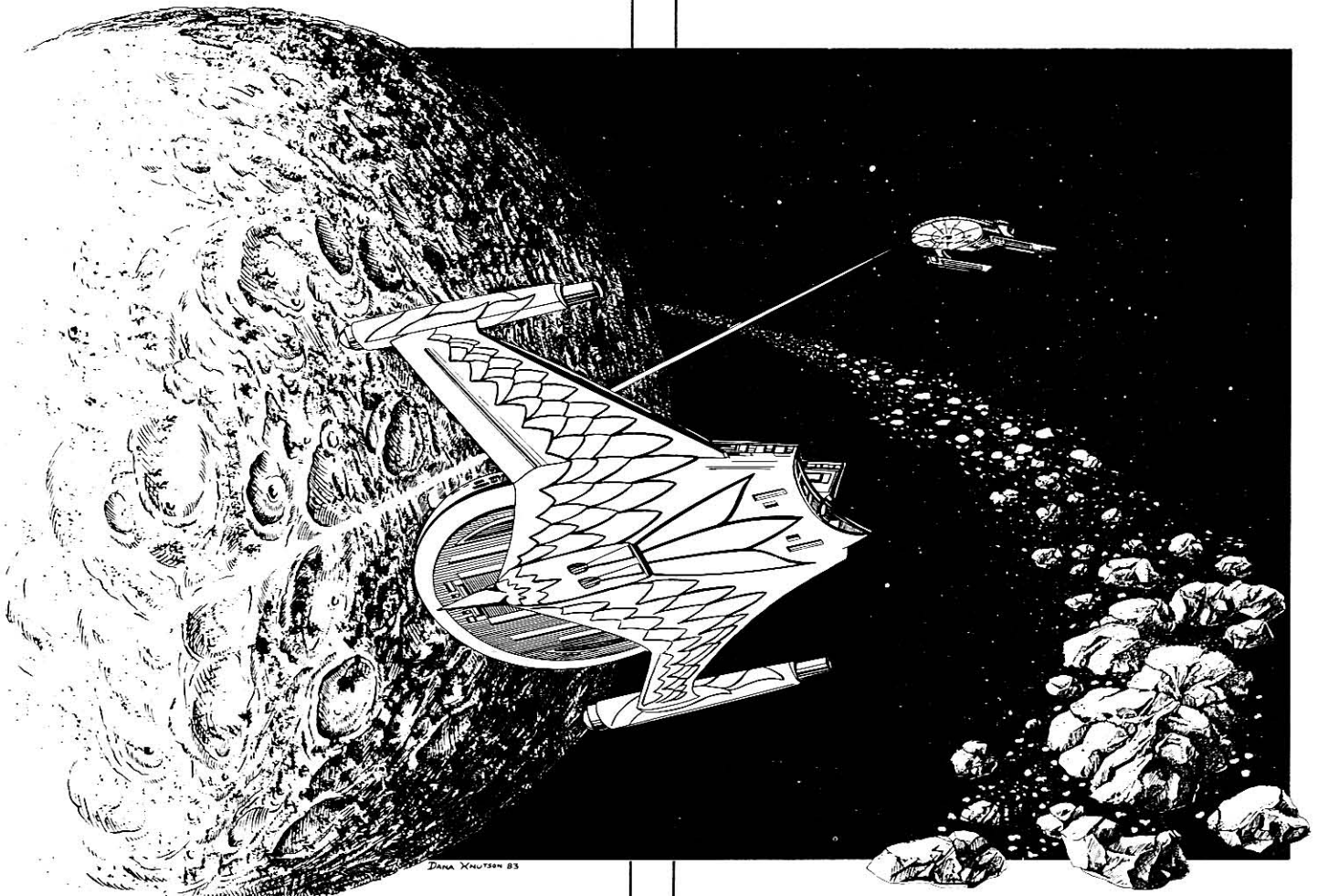

# The Romulan Star Empire

This information is presented for gamemasters only; it is accurate and complete. Federation players are *NOT* intended to have access to this.

## HISTORY

### THE VULCAN HERITAGE

That Romulans and Vulcans share a common heritage is almost undeniable. The evidence for this, available to the Romulans and in part to the Vulcans and the Federation, is biological, evolutionary, archaeological, and cultural.

Romulans have the same body structure and appearance, the same anatomy, and the same physiology as Vulcans, right down to the copper-based blood. The placement of organs is the same, as is their function. For example, the transparent, inner eyelid in Vulcans exists in the Romulan eye structure as a vestigial fold of tissue. Romulans are psionic, as well, though they have not developed psionic techniques as highly as the Vulcans. The climate of Romulus is responsible for the physical differences between Romulans and Vulcans. It is not as harsh as Vulcan's, but is harsher than Terra standard, which explains why Romulans are harder than most Humans, but not as tough as the average Vulcan.

Romulan science, once it developed sufficiently, was quick to discover that Romulans could not have evolved naturally on their home planet of Romulus. There are no life forms similar enough on the planet to support any sensible theory of evolution; the seas on Romulus are not soupy with copper salts like those on Vulcan, making it unlikely for a copper-blooded organism to develop there.

Furthermore, Romulan archaeologists have found 7 areas on Romulus that were all settled at the same time, with little or no deviation in cultural development. The settlements are located at what are today the city-states of Caranam, Portora, Kanassarum, Labasasz, Dinalla, Pulla'd, and Farrad, all world leaders; remains of many of the walls surrounding the old cities can still be seen today. There are no records of any earlier peoples on the planet from whom these settlements may have derived, nor artifacts or evidence of tool use prior to these settlements. Research also indicates that farming implements, tools, language, and art in all seven settlements were similar.

Lastly, from the earliest times, Romulan legend has said that the Romulans were placed on their homeworld and told to build a road to the stars. The archaeological evidence is very strong support for these legends. It is likely that the people in the earliest settlements had to be transplanted there – seven separate tribes do not develop nearly-identical language and culture at the same time.

### Seeding By The Preservers

Until the Humans from Star Fleet came face-to-face with the Romulans, they had no idea about the physical similarity between their Romulan foes and their Vulcans allies. When the similarity to Vulcan was discovered, many groups within the Federation were quick to point fingers of doubt at their Vulcan allies. Many debates were heard, on the political floors and off, about whether or not the resemblance of the two races was mere happenstance.

At this time, and partially because of the furor the discovery created (though Vulcans would deny that they were motivated by anything but pure logic), the Vulcan Science Council made public their theories about an ancient race who influ-

enced the spread of early humanity throughout the galaxy. This theory, which concerns the race now known generally as The Preservers who deliberately seeded human-types on widely scattered worlds, has since become widely accepted and backed up by much research. It accounts for the hundreds of undeniably Human and Humanoid civilizations found on so many worlds by the Federation. The serious scientific community has come to accept the possibility that most, if not all, of the galaxy's intelligent, upright-biped, mammalian species were offshoots of the same culture eons ago.

In the face of speculation concerning secret Vulcan/Romulan alliances, the Vulcans used their seeding theories to account for the physical similarity between them and the Romulans. As evidence supporting seeding and denying any secret alliance, they pointed to their recorded history, which predates space travel by 2000 to 3000 years and does not mention the existence of the Romulans. Unbeknownst to them at the time, the Romulans have similar recorded history that does not mention the Vulcans. It is clear that the split between the Vulcan and Romulan cultures must have occurred before either developed space travel.

The Preserver seeding theory is widely upheld today by many cultures. This, coupled with the physical similarity between Romulans and Vulcans, the difficulty or impossibility of Romulans evolving on Romulus, the unlikely archaeological coincidence of the early Romulan settlements, and the Romulan legends themselves provide overwhelming evidence that supports the fact that the Romulans are indeed an off-shoot of the same stock that bred the Vulcan race.

### THE IMPACT OF ENVIRONMENT

The environment on Romulus is not only responsible for the differences in physical development between Romulans and Vulcans, but also the differences in cultural development. It forced the Romulans to fight for their mere existence. This, coupled with the fact that they started their existence on the planet in competing settlements (later developing into powerful city-states), caused them to value and develop physical rather than intellectual attributes. This, in turn, further emphasized differences between Romulans and Vulcans; Romulans tended to breed in faster reflexes and similar fighting qualities.

Romulus, a harsh planet today even with modern technology, must have been unimaginably harsh when the first cultures developed there over several thousand years ago. The planet's weather cycle makes most of its land surface very dry much of the year. The planet is extremely metal-poor, and most early farming tools and weapons were made from soft metals because of the lack of hard metals.

In order to survive, an early Romulan had to be tough. The original 7 tribes spent most of their time just trying to survive. Nevertheless, the tribes ventured forth, slowly at first, and established many other settlements. Where tribes came together, fighting arose, always centered on what few resources there were. The weak were not allowed to live, because there was not enough of anything to support even the strong. The Romulan people have become very hardy, with inferior traits weeded out by selected inbreeding and elimination of undesirables.

Early Romulan development bears a remarkable resemblance to early Terra's Greek city-states, particularly that of Sparta. Romulan city-states evolved, simply because they were the best way to survive.

## TIME LINE OF MAJOR EVENTS

This time line is provided for gamemaster use only; the events and the dates that they occur are accurate as given below. This time line should *NOT* be available to most players. Gamemasters who intend to run adventures with Romulan player characters may give them this information in a general way, taking care not to divulge any information that may compromise the use of Romulans as NPCs. The details of the Romulan/Klingon treaties certainly should be guarded closely to preserve the players' sense of mystery.

**Stardate – 29/**

The Preservers seed Vulcanoid peoples in the Romulus/Remus system, previously devoid of intelligent life. Seven settlements were established at the sites of the modern city-states of Caranam, Portora, Kanassarum, Labasasz, Dinalla, Pulla'd, and Farrad.

**Stardate – 27/**

D'Sivas settled by Farrad.

**Stardate – 25/**

Labasasz and Portora make contact and combat over soft-metal deposit. The results are inconclusive.

**Stardate – 22/**

Ranassa settled by Portora. Timuraasz settled by Dinalla.

**Stardate – 21/**

Calanista and Manasan settled by Caranam.

**Stardate – 21/ to – 3/**

Constant conflict between city-states and tribes, frequently over Romulus' scanty resources. Caranam, Portora, Kanassarum, Labasasz, Dinalla, Pulla'd, Farrad, D'Sivas, Ranassa, Timuraasz, Calanista, and Manasan emerge as world leaders.

**Stardate – 3/8704.12**

Vaonus of Calanista postulates that Remus is inhabitable, heralding in the Age Of Discovery. Although legends existed of life on other planets, this is the first time scientific evidence is presented to support the legends and theories.

**Stardate – 3/9212.24**

L'Tokus of Dinalla successfully launches a large, payload-carrying rocket into the upper atmosphere. Previously, rockets, though used in celebrations, rarely had been used militarily.

**Stardate – 3/9306.21**

Timuraasz places first payload into orbit around Romulus.

**Stardate – 3/9608.12**

Dinalla puts first Romulan in orbit.

**Stardate – 3/9701.15**

War breaks out between Dinalla and Timuraasz over the resources necessary for space travel. The war soon spreads to other places on the planet, as no city-state dares allow others to gather the necessary resources for space travel, fearing the loss of military advantage. Up to this time, Dinalla and Timuraasz are the only two city-states that had managed to send anyone into space, though several others, most notably Labasasz and Caranam, are close to accomplishing space ventures.

**Stardate – 2/0001.12**

The treaty of Kanassarum is signed, the warring factions having exhausted themselves and their meager resources by this time. The war produces no real winners.

**Stardate – 2/0008**

At a meeting of the elder statesmen of all the city-states, the great scientist/statesman L'Deus of Portora proposes that the city-states band together to reach Remus. He shows without a doubt that limited resources would prevent any one city-state from accomplishing the goal on its own. He uses the old legends and combines it with the example of the past and the realities of the present to make his appeal. After 7

months of effort, he gives up in disgust. The meeting breaks up without the unification needed.

**Stardate – 2/0204.21**

Dinalla attempts a launch to establish a semi-permanent space station. The vessel, using inferior fuel, exploded on the pad.

**Stardate – 2/0210**

Second Conference of Portora is held, with representatives from all city-states. L'Deus refuses to lead the conference or to even participate except for answering questions. The conference lasts 4 months. Seeing that alone their city-states could not reach the stars, the representatives agree to join together.

**Stardate – 2/0302.10**

The *D'Vatta* (Great Paper) is signed, unifying all city-states into one organization, the *Bresasam Rom'inz* (Romulan Confederation). The debates over the form the government will take last less than 4 months.

**Stardate – 2/0306.20**

L'Deus is elected first Emperor of the Romulan Confederation by the Imperial Senate after the Senators convince him that the position is part of his destiny.

**Stardate – 2/0312.29**

Because of its location central to needed resources, Kanassarum is chosen as the site of the new united space effort.

**Stardate – 2/0405.10**

The first Confederation manned flight is launched.

**Stardate – 2/0406 to – 2/1206**

This period of many manned flights culminates in the establishment of a large orbital station to be used as a platform for the Remus effort.

**Stardate – 2/1210.20**

The first unmanned probe lands on Remus.

**Stardate – 2/1811.13**

The first manned mission lands on Remus, with only one astronaut aboard the vessel. S'Tanet, since become not only famous for her adventure but intertwined with legend, reports that the surface has a breathable atmosphere and life.

**Stardate – 2/1904.03**

A temporary research facility is established at Levitasz, the site of S'Tanet's historic landing; it is abandoned one year later.

**Stardate – 2/2000**

A large, manned station is constructed orbiting Remus. This base is continually enlarged over succeeding years, serving as the launch facility for further expeditions to Remus.

**Stardate – 2/2100 to – 2/2900**

Seven manned and 36 unmanned landings are made on Remus. None of the manned bases, used primarily as centers for mapping, testing, and research expeditions, lasts for more than 1 year.

**Stardate – 2/2902.18**

The first permanent colony, called Adrennan, is established on Remus. Thirty-seven settlers arrive aboard 3 shuttles from the orbiting station.

**Stardate – 2/2908.10**

The Remus colony of Bisciae is established near large mineral deposits.

**Stardate – 2/2912.17**

The port of Rinum is established on Remus, destined to become the major planetside port, used to export resources both to the orbiting station and to Romulus.

**Stardate – 2/3103.01**

Levitasz, the site of the first manned landing on Remus, is established as a permanent settlement.

**Stardate – 2/3100 to – 2/5100**

These two decades see the first 4 colonies on Remus grow into city-states, recognized alongside those on Romulus. Population and trade grow geometrically, and the Remus government at Biscae is forced to allow other colonies to be established. The other 8 city-states on Remus were established to provide homes for the rapid influx of settlers.

**Stardate – 2/3105.10**

Shanerea colony is established on Remus.

**Stardate – 2/3310.27**

Hetharri and Yenallan settlements on Remus file papers establishing permanent colonies the same day, beginning the tradition of friendly rivalry between them.

**Stardate – 2/3401.15**

The first expedition to the planet S'Latias departs from D'Raxna station in orbit about Remus. The expedition consists of 9 scientists, 2 astronaut/pilots, and 5 military/security specialists.

**Stardate – 2/3402.21**

The S'Latias expedition arrives in orbit about the third planet and finds it lifeless and uninhabitable. One of the planet's 2 moons, however, has a very thin atmosphere and mollusk-like primitive life. The moon is named S'Tanet.

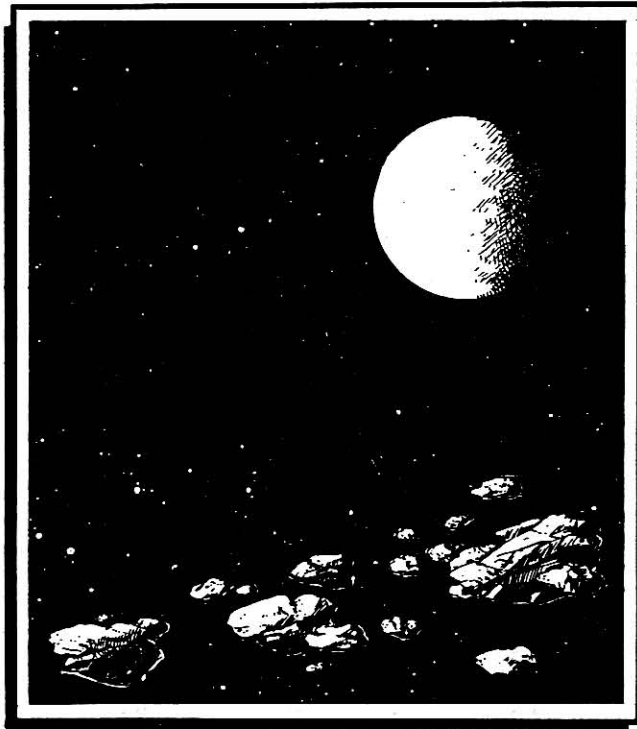

**Stardate – 2/3403.03**

A small shuttle with 2 military/security specialists, 1 pilot, and 2 scientists lands on S'Tanet, discovering it to be rich enough in resources to make domed facilities worthwhile.

**Stardate – 2/4001**

The moons of the planets D'Lanam and Ulunam are found to be relatively rich in mineral resources, starting immense mining efforts there.

**Stardate – 2/4101.28**

The first manned starfaring expedition is launched to the nearest star, Perhonies.

**Stardate – 2/4002.03**

Patarrasz settlement is established on Remus.

**Stardate – 2/4310**

The settlements of Destallasz and Valassa are established on Remus.

**Stardate – 2/4900**

The Paieu settlement is opened on Remus.

**Stardate – 2/4903.17**

A habitable planet is found in the Perhonies system. The planet is in an earlier stage of development than Romulus and has no intelligent life forms.

**Stardate – 2/5100**

The Nabatha colony is established on Remus.

**Stardate – 2/5103.17**

Several expeditions are launched simultaneously from the Romulus system to neighboring star systems in a search for usable planets and valuable resources. All are launched coreward, in keeping with the "Road to the Stars" philosophy.

**Stardate – 2/6002.12**

Biscae is made capital city-state of Remus. Its mineral deposits have made it the fastest-growing colony on Remus for 40 years or more, as well as the planet's commercial center.

**Stardate – 2/6102.29**

The expedition to Gorwah lands on a planet dominated by a humanoid life form having a civilization not as advanced as the Romulans'. The people are conquered easily, making Gorwah the first culture to be absorbed into the Confederation.

**Stardate – 2/7500**

By this time, the Romulan Confederation has established colonies on 27 planets coreward.

**Stardate – 1/0000**

At this point, the Romulans have 73 colonies and have conquered 27 other planets, resulting in 100 Romulan settlements. The Romulan Confederation changes its name to *Latasam Stelai Rom'Inz* (Romulan Star Empire), which translates literally as "Star Road of the People." It takes the form of government it has today.

**Stardate – 1/0401**

The Romulans are attacked spinward by the Corillians, a race previously unknown to them. Having little force in this direction, the Romulans sustain heavy losses. The war lasts six months, after which the Corillians, a much less populous culture than the Romulans, are conquered. They are the first space-faring culture to be subjugated by the Star Empire.

**Stardate – 1/0600 through – 1/8600**

The Corillian Incident points out the necessity of watching all directions, not just the coreward direction of main expansion. Because of this, the Empire enters a period of consolidation, strengthening their existing borders.

**Stardate – 1/8601**

Expansion begins spinward.

**Stardate 0/0001**

At this point, the Romulan Empire numbers 216 colonies and planets.

**Stardate 0/0001.30**

First contact with the Klingon Empire occurs at Delta Khinah II, when a Romulan scout vessel is attacked without provocation. The vessel, the *L'Sattak*, self-destructs after sending log tapes homeward.

**Stardate 0/0002.01**

The First Romulan-Klingon War starts.

**Stardate 0/0306.15**

The First War ends. Having taken heavy losses, the Star Empire pulls back slightly, giving up two outposts. The Klingons do not pursue, not being in a position to do so, though this is unknown to the Romulans. From this time to present, minor skirmishes occur between the Romulans and the Klingons.

**Stardate 0/0912.21**

The Star Empire begins a period of slow, cautious expansion in the direction of the Klingon Empire. The expansion ends 40 years later, setting the boundaries for what is known today as The Triangle, where many of the recurring skirmishes between these two powers and the UFP take place.

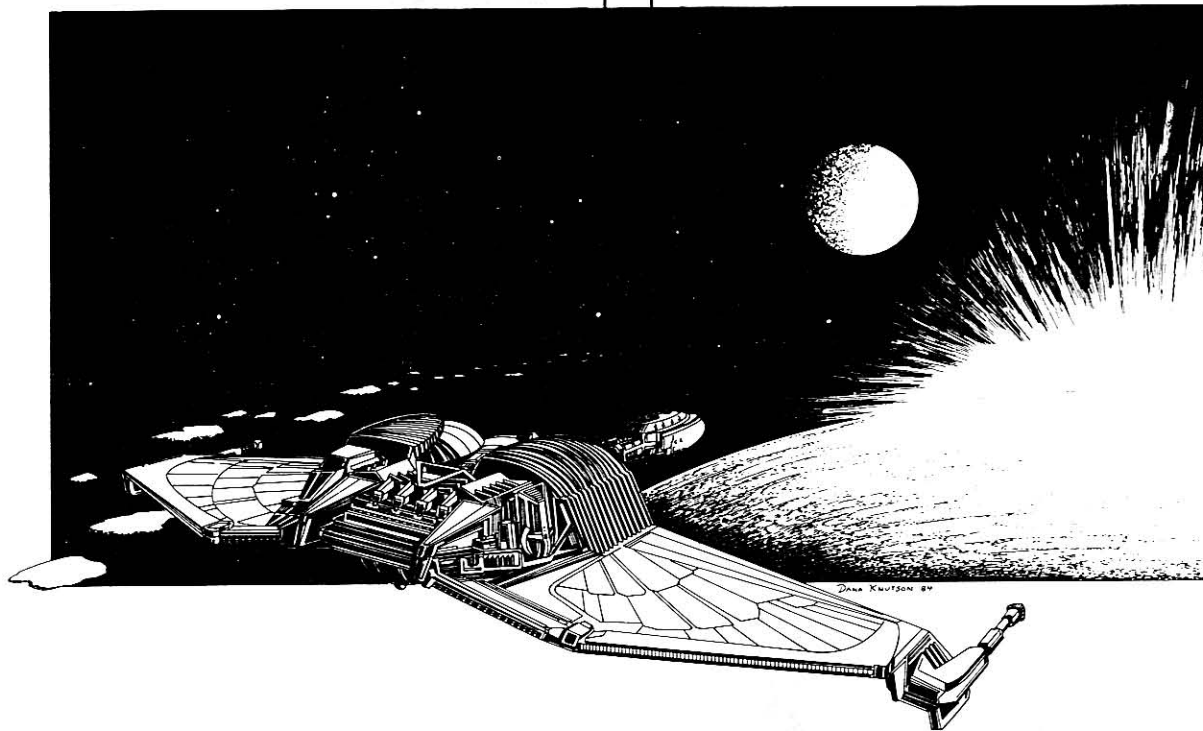

**Stardate 0/9211**

First contact with the United Federation of Planets occurs when a Federation cargo ship wanders into Romulan territory. It is destroyed by Romulan patrol craft. At first, the Romulans suspect that Federation incursions into their space may be a Klingon deception. Later, the Imperial Council, remembering the 'Klingon lesson,' decides not to risk negotiation with the UFP, in the hope that destruction of all intruders will keep the UFP from expanding into Romulan Space.

**Stardate 1/0610**

The Star Empire declares war on the UFP.

**Stardate 1/0909**

The Romulan-UFP War is ended inconclusively, after staggering losses on both sides. The treaty, negotiated by subspace radio, establishes a Neutral Zone no ships are allowed to cross between the two powers. No Federation forces have ever seen a Romulan face to face, mostly because the Romulan refuse to allow a ship to be captured intact.

**Stardate 1/0910**

At this time, realizing that they are technologically out-classed and outnumbered, and that they have no hope of winning a prolonged conflict, the Romulans consolidate along the new UFP-Romulan Neutral Zone. They begin major construction of outposts to keep track of Federation forces and keep them in check. Just homeward of these outposts, forces for future expansion into Federation territory are built.

**Stardate 1/8312**

The plasma weapon is invented, giving new hope to the Star Empire forces on the Klingon and Federation borders. The weapon is made operational in 2 years, and modifications are made periodically, resulting in several variants at present.

**Stardate 1/8610**

The cloaking device is perfected and is used successfully in vessels on the Klingon border.

**Stardate 1/9501**

Cloaking devices, much perfected by this time, are installed on vessels operating on the UFP border. Smaller vessels are equipped first and sent into Federation territory to learn what they can of Federation forces and their disposition.

Instructed not to let the Federation discover they are Romulan vessels, they are given orders to self-destruct if caught. These privateers capture or destroy many Federation merchants and scouts. The Federation is unaware of the true nature of the disappearances for some time, and attributes them to Orions and other pirates.

**Stardate 2/0902**

In an attempt to stop the seemingly endless and inconclusive battles between the two powers, the first Romulan/Klingon non-aggression and technological treaties are signed at Villam III, near The Triangle. Afraid of the apparent growing military might of the UFP, the Romulans and Klingons decide to concentrate on this common enemy.

The Romulans, currently ahead in territory, give up many disputed planets as well as the plans for an older-model cloaking device and the plasma weapon. In return, the Klingons provide a number of older D-7 ships equipped with Klingon weapons and engines.

**Stardate 2/1002**

The *USS Enterprise* seizes a cloaking device on a mission in the Romulan Neutral Zone. The unit is made to function once, but is later catastrophically destroyed, preventing the UFP from gaining the secret of its construction.

**Stardate 2/1109**

The second Romulan/Klingon treaty is signed. The Romulans gain bases coreward of The Triangle. The Klingons gain a much-desired, mineral-rich planet in The Triangle itself. Both sides feel they have come out ahead.

**Stardate 2/1801**

The third Romulan/Klingon treaty is signed. The Romulans gain access to new weaponry and advanced mining equipment. The Klingons gain a 12-man, scout-size *Bird-of-Prey*, which they put into widespread use as a raider, and on which they base several larger ship designs of their own.

**Stardate 2/2112.02**

A Romulan scoutship is fired on by a Gorn battleship while in a system recently brought under Gorn control. Gorn fire severs the warp engine nacelle of the Romulan craft, limiting its self-destructive capability. The Gorn salvage much of the wreckage, learning about the Romulans.

# THE ROMULAN HOME SYSTEM

This information is presented for gamemasters only; it is accurate and complete. Federation players are *NOT* intended to have access to this.

## ROMULUS AND REMUS

**System Name:** Stelam Rom'Inz      **Dominant Life Form:** Rom'Inz (Romulans)  
**Number Of Class M Present:** 2

### LIFE AND CIVILIZATION LOG

**System Name:** Stelam Rom'Inz  
**Code:** 9 9 9 9 5 - 8 7  
**Dominant Race:** Romulans  
**Life Form:** Mammalian

STR	3D10+50	END	3D10+50
INT	3D10+40	DEX	3D10+45
CHA	3D10+40	LUC	D100-10
PSI	D100-20		

### Technological Index

Space Science Index: 9  
 Physical Science Index: 9  
 Engineering Index: 9  
 Planetary Science Index: 9  
 Life/Medical Science Index: 9  
 Psionics Index: 5

### Sociopolitical Index

Social Science Index: 8  
 Cultural Attitude Index: 7

**World Name:** Rom'lasz (Romulus)  
**Position In System:** II; binary with Remus  
**Number Of Satellites:** 0  
**Planetary Gravity:** 1.1G  
**Planetary Size**  
 Diameter: 14,300 km  
 Equatorial Circumference: 44,000 km  
 Total Surface Area: 561,000,000 sq.km  
 Percent Land Mass: 53%  
 Total Land Mass: 297,330,000 sq.km  
**Planetary Conditions**  
 Length Of Day: 22 hr  
 Atmospheric Density: terrestrial  
 General Climate: tropical  
**Mineral Content**  
 Normal Metals: 12%  
 Radioactives: 2%  
 Gemstones: 6%  
 Industrial Crystals: trace  
 Special Minerals: trace

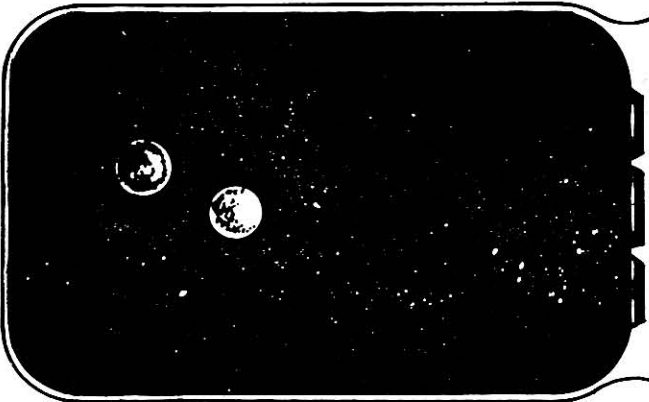
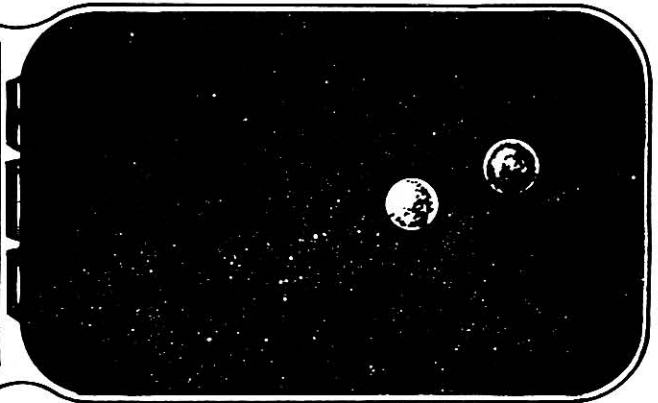

**World Name:** Rav's (Remus)  
**Position In System:** IIB; binary with Rom'lasz  
**Number Of Satellites:** 0  
**Planetary Gravity:** 0.6G  
**Planetary Size**  
 Diameter: 7800 km  
 Equatorial Circumference: 24,000 km  
 Total Surface Area: 306,000,000 sq.km  
 Percent Land Mass: 26%  
 Total Land Mass: 79,560,000 sq.km  
**Planetary Conditions**  
 Length Of Day: 16 hr  
 Rotational Period: 900 hours  
 Atmospheric Density: Thin  
 General Climate: Warm temperate  
**Mineral Content**  
 Normal Metals: 36%  
 Radioactives: 16%  
 Gemstones: 9%  
 Industrial Crystals: 5%  
 Special Minerals: 8%

THE SURFACE OF ROM/LASZ

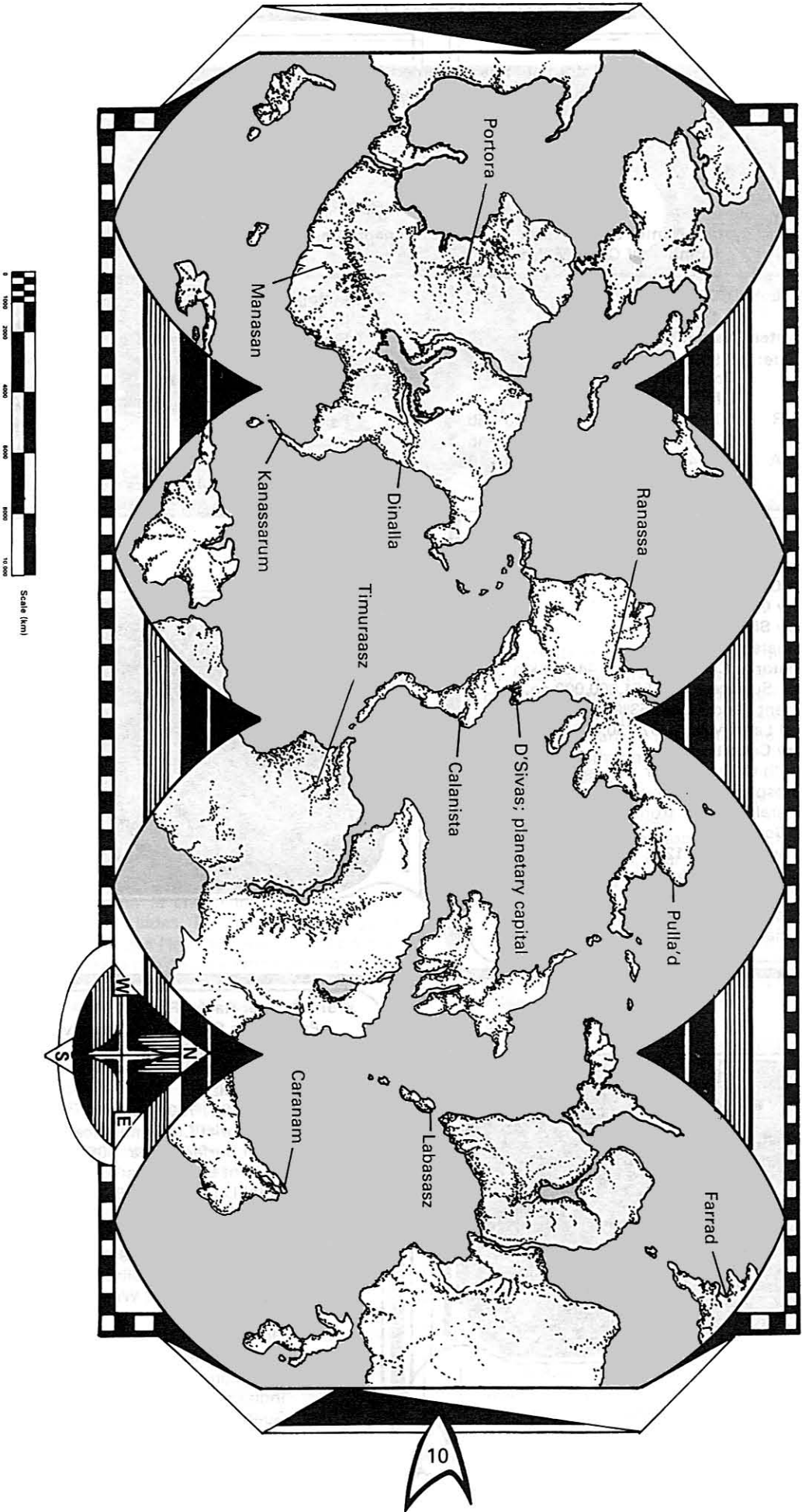

THE SURFACE OF RAV'S

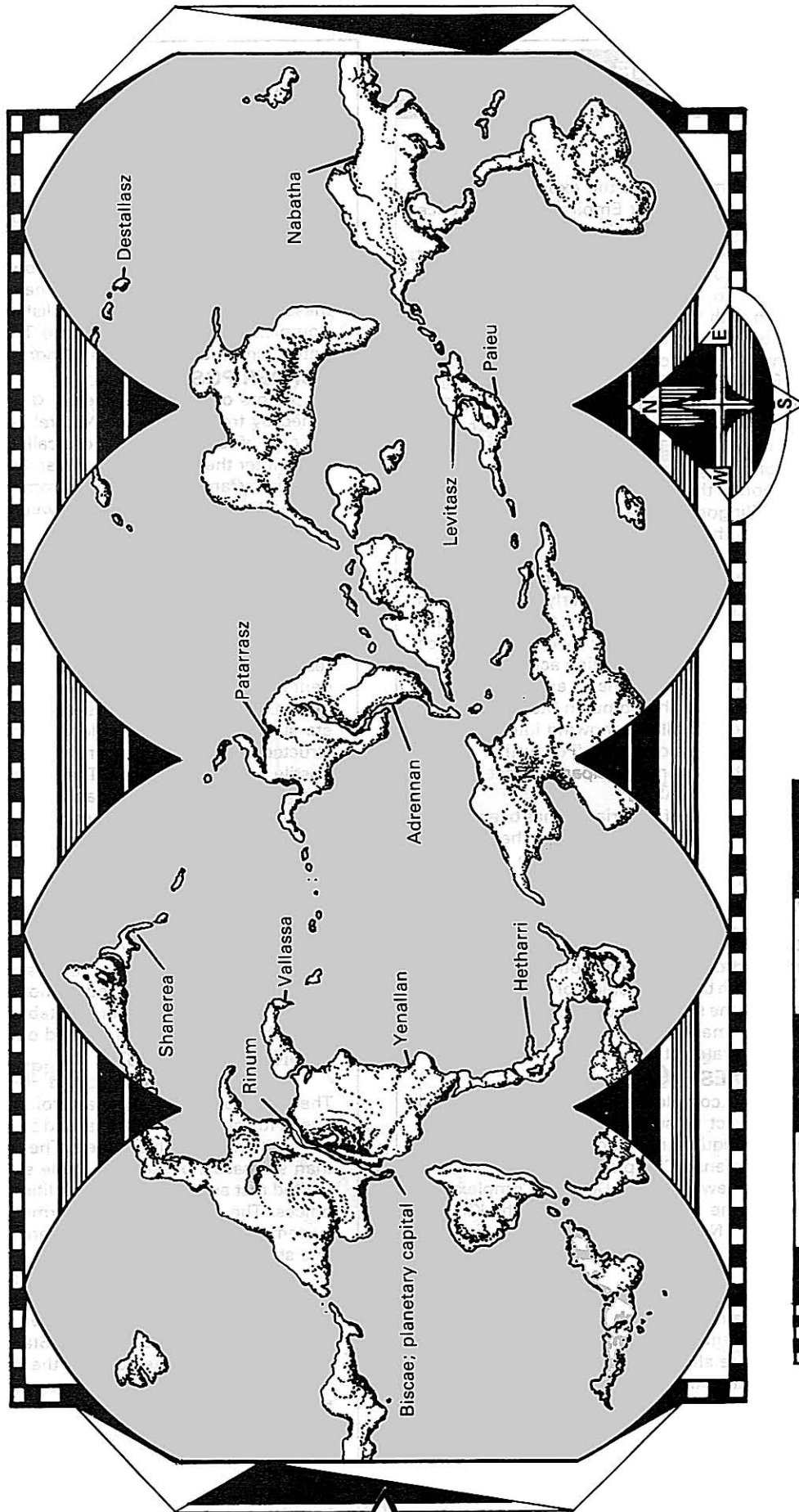



## EXTENTS OF THE ROMULAN STAR EMPIRE

### THE EMPIRE MAP

The accompanying map shows the explored and controlled extents of the Romulan Star Empire as of Reference Stardate 2/2206. The major thrust of most early Romulan expansion was toward the Galaxy's core. A chance encounter with the Corillian race led to their expansion in other directions and, ultimately, to their encounters first with the Klingon Empire, then with the UFP.

The limits of expansion, as of Reference Stardate 2/1200, show the Star Empire's boundary during the time of the *STAR TREK* television show. Further expansion occurred after that time but prior to the time of *STAR TREK III: The Search for Spock*. The large arrows indicate planned expansion efforts for the near future. The major thrust is still coreward, but expansions to galactic north and east also are proceeding. Expansion to the northwest and west is blocked by the UFP and the Klingon Empire respectively.

The area known to the Romulans as *Avastam* (literally, "the Wedge") and to the UFP as the Triangle largely has been left alone by the governments bordering it until recently, simply because nothing particularly valuable was thought to exist there. In more recent years, the Triangle has been found to be the site of a number of valuable resource worlds, and currently is a hotbed of trading activity, containing a number of independent governments and less-formally organized groups. At present, the Romulan Star Empire, the Klingon Empire and the UFP all are showing interest in obtaining a foothold in this part of space. (For further details on the Triangle, see the upcoming expansion set on this area, available in 1985 from FASA.)

The area to galactic south of the Triangle has been fought over for many years by the Klingon Empire and the Romulan Star Empire. The farthest penetrations of Klingon and Romulan control are shown on the map, as well as the Reference Stardates for each. The current boundary was established on Reference Stardate 2/1109 as part of treaty negotiations between these two governments. Theoretically, it extends forever in the indicated direction, with both sides agreeing not to explore or establish bases, colonies, or outposts across the line. The area is still the site of frequent raids on merchant shipping, but the governments of both sides deny any official connection with such pirate activities.

### DEFENSE COMPLEXES

Two major defense complexes have been established by the Star Empire to act as supply bases, manufacturing centers, and major headquarters stations. The oldest, once called the Southern Defense Complex, is now the Central Defense Complex. The new Southern Defense Complex was established soon after the first skirmishes with the Klingon Empire. There is no Northern Defense Complex, the Romulus/Remus system itself serving in its stead for the present.

Defense complexes are interior defenses, and not intended as frontier installations. Each is charged with coordinating military efforts in its region, and supplying those efforts if the Star Empire should be invaded. It is said that, should Romulus fall, that either defense complex could continue to prosecute a major war alone. Security is tight near these worlds, and no starship could hope to approach within half a parsec without detection and challenge. No civilian ship may approach these worlds.

Each defense complex is a major industrial world run entirely by the military and devoted solely to military produc-

tion. Arms are stockpiled here, and many starships are built in orbit around these worlds, the most heavily defended in Romulan space. Resident populations of about 2 million are all military personnel and dependents.

Plans are being drafted for a Northeastern Defense Complex, to be established in some yet-to-be-named system beyond Kalabestasz, and for a Southeastern Defense Complex, to be placed along the line of coreward expansion. Neither of these complexes will be constructed, however, until expansion efforts secure major sections of space in these directions. Talk of establishing a Western Defense Complex near the border of the Triangle has been tabled until such time as that area is more stable.

### BORDER POSTS

Points on the map labeled  are border posts established by treaty along the Neutral Zone. These stations are the only official border stations called for by the agreements made after the UFP/Romulan War. Even so, they are supplemented by larger stations back from the Zone and by unmanned early-warning stations between the border posts and closer to the Zone's boundaries.

### STARBASES

Points on the map labeled  are the equivalent of starbases. The bulwarks of Romulan military presence on the frontier, they are major installations providing full orbital ship construction, docking and repair stations, rest and recreation facilities, communications relay equipment, and resident regional headquarters centers for Romulan military activities. Established even in systems where there are no planets suitable for normal colonization, these bases are constructed underground where necessary, as on worlds with hostile surface conditions. The bases are then defended and supplemented by orbital facilities and their own fleets of system-defense boats. The combination makes these bases extremely difficult to attack successfully.

Starbases have resident populations of 30,000 to 75,000 persons, including dependent families. Despite their size, they are not intended as permanent facilities. As the borders of the Star Empire grow, they are stripped and abandoned, with defense of the area being turned over to more conventional bases in habitable solar systems. Occasionally, a former starbase is converted to another use or remains intact and operational if no more suitable base is located in the area when the frontier is pushed outward.

### FRONTIER OUTPOSTS

Points on the map labeled  are frontier outposts. These outposts are hollow-asteroid facilities established between full starbase locations, and are located in orbit around stars with no habitable planets. They are much less elaborate than starbases, possessing some starship repair capability, limited rest and recreational facilities, and only local military offices. The stations are well armed, but have no resident system-defense craft. Even so, there is almost always at least one star vessel in residence.

Frontier outposts have resident populations of 10,000 to 25,000, including dependent families. They are also temporary facilities that are closed down when new exploration efforts push the borders of the Star Empire outward. They are never reused. The policy of the Romulan Navy's outpost branch is to destroy them once abandoned, though many have simply had their orbits changed so they cannot easily be relocated. Such 'lost bases' are left with stores of military hardware that has been mothballed and preserved against later need; their location is known only at the highest levels of command, by whom they can be reactivated in case of invasion.

# EXTENT OF THE ROMULAN STAR EMPIRE

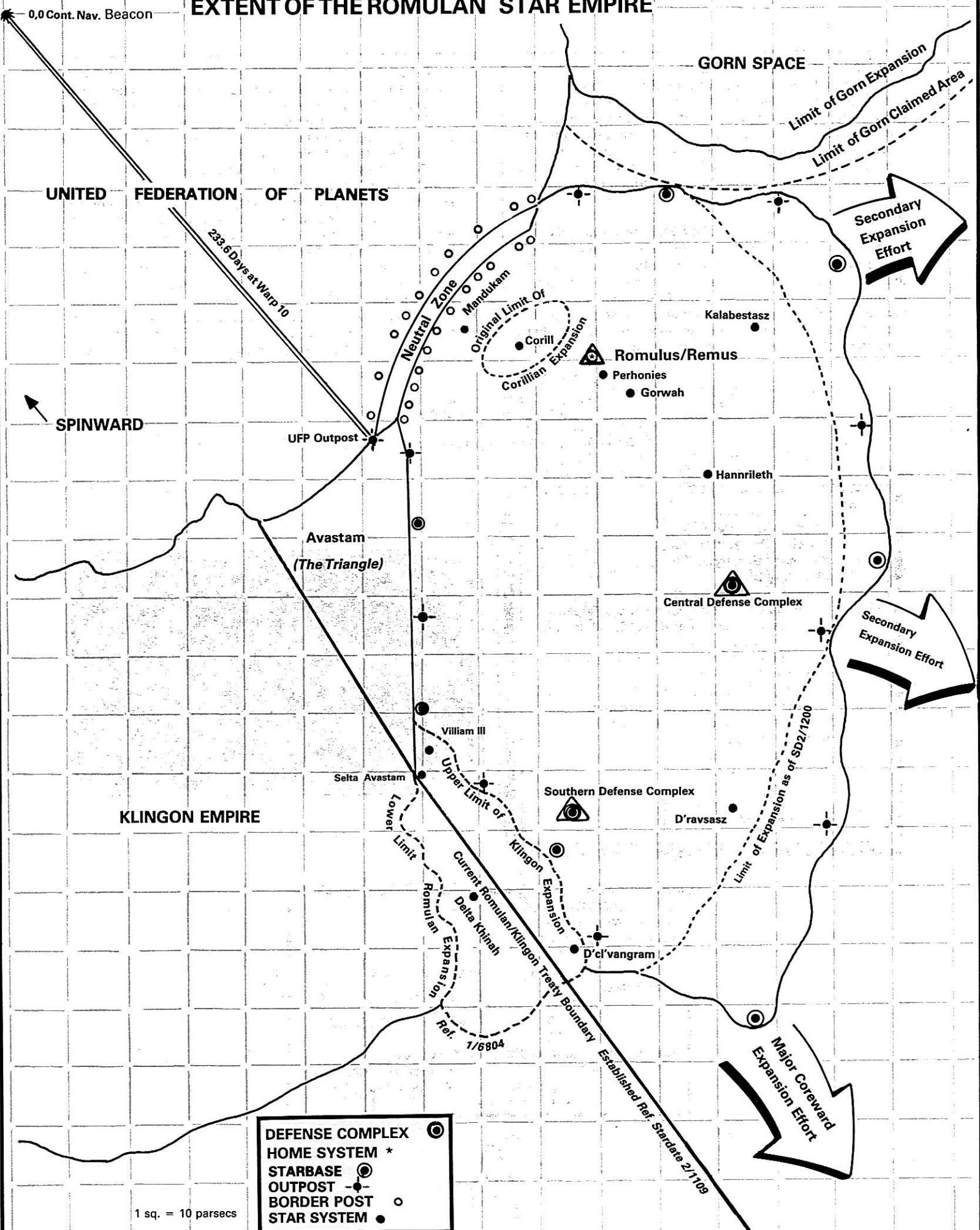

0,0 Cont. Nav. Beacon

UNITED FEDERATION OF PLANETS

GORN SPACE

233.6 Days at Warp 10

SPINWARD

UFP Outpost

Avastam  
(The Triangle)

KLINGON EMPIRE

Selta Avastam

Upper Limit of

Southern Defense Complex

Lower Limit

Current Romulan/Klingon Treaty Boundary

D'ravsasz

Romulan Expansion

Delta Khirah

D'cl'vangram

Ref. 1/6804

Established Ref. Stardate 2/1109

Limit of Gorn Expansion  
Limit of Gorn Claimed Area

Secondary Expansion Effort

Secondary Expansion Effort

Major Coreward Expansion Effort

DEFENSE COMPLEX	☉
HOME SYSTEM *	★
STARBASE	⊙
OUTPOST	⊙
BORDER POST	○
STAR SYSTEM	●

1 sq. = 10 parsecs

## COLONIZED STAR SYSTEMS

Colonized star systems are identified on the map with dots, either unlabelled or listed by the name of the most prominent planet. Stars with no colonizable planets usually are identified only by catalog number in Romulan records. It would be impossible on a map in this scale to show all the colonized star systems in Romulan space, but the map shows the several prominent ones described below.

### CORILL

This was once the capital of the Stellar Kingdom of Corill, the borders of which are shown on the map. This kingdom was a rather smallish group of star colonies controlled by the first space-travelling race encountered by the Romulans. (Actually, the Corillians found the Romulans first, and attacked a small group of Romulan ships, destroying all but two, who escaped and returned to Romulus.) The Corillians were technologically advanced enough to tackle the Romu-

lans, but their numbers were simply too few. They were overwhelmed by superior Romulan numbers and their planets were taken as prizes of war. Supposedly, the Corillians died to the last individual, and are now extinct. Even so, rumors pop up every few years about a lost Corillian colony that still exists, and thirsts for vengeance.

Furry, lemur-like creatures with large, yellow eyes, the Corillians are fast, graceful, and stronger than they look. Descended from arboreal mammals, they developed the beginnings of an interstellar empire before encountering the Romulans. They handled their first interstellar encounter badly, attacking a small Romulan squadron and allowing several ships to escape. The result was war, and the Corillians were destroyed by the more-numerous Romulans.

Legends remain about lost Corillian colonies that the Romulans never found, colonies that even now are plotting revenge. Assuming there is no truth to these legends, and there is no proof either way, the Corillian race is now extinct.

## WORLD LOG

System Name: CORILL

Number Of Class M Present: 1

Dominant Life Form: Corillians, now extinct (?)

### World Name: CORILL

Position In System: II

Number Of Satellites: 2

Planetary Gravity: 1.3 G

#### Planetary Size

Diameter: 16,900 km

Equatorial Circumference: 52,000 km

Total Surface Area: 663,000,000 sq. km

Percent Land Mass: 42%

Total Land Mass: 278,460,000 sq. km

#### Planetary Conditions

Length Of Day: 26 hr

Atmospheric Density: Terrestrial

General Climate: Cool temperate

#### Mineral Content

Normal Metals: 34

Radioactives: 8

Gemstones: 27

Industrial Crystals: 10

Special Minerals: trace

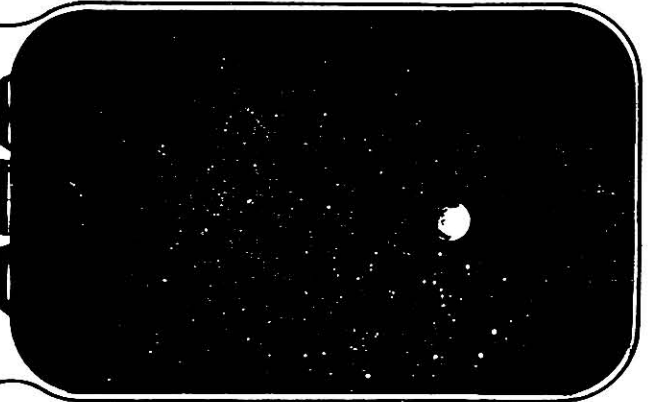

## LIFE AND CIVILIZATION LOG

System Name: CORILL

Code: 9 8 8 7 7 4 - 7 4

Dominant Race: Corillians

Life Form: Mammalian, medium-sized omnivore

#### Attributes:

STR - 55	END - 55	INT - 50
DEX - 60	CHA - 60	LUC - 20
PSI - 20		

#### Tactical Movement And Combat Statistics:

AP: 7	Combat Skill Rating: 40
Damage: +1, vestigial claws	Armor: none

### D'CL'VANGAM (Place Of Vengeance)

This Romulan colony world was taken by the Klingons during a border skirmish, as a result of a particularly treacherous Klingon ruse. The Klingons then fortified the world heavily to avoid its being retaken. Unfortunately for the Klingon occupation force, the Romulan thirst for revenge overwhelmed their reluctance to waste resources. Romulan ordinance engineers prepared a number of special matter/anti-matter bombs that were delivered by a specially-modified ship, while a Romulan suicide squadron baited off the Klingon defenders. The first bomb was used to destroy one of the planet's moons. The rubble created a ring of debris

about the planet.

The Romulans then waited 6 hours before delivering the other bombs to the surface of the planet, informing the Klingons of these intentions so they might "think about the price of betrayal." The occupation force offered surrender, which the Romulan Commander refused to accept. The Commander then laid waste to the planet's surface, rendering it uninhabitable.

Ironically, when the final Romulan/Klingon agreements were reached along their common border, this planet fell within the Romulan sphere of influence. It still remains, a monument to Romulan vengeance.

### WORLD LOG

System Name: D'CL'VANGRAM

Number Of Class M Present: 1

**World Name:** D'CL'VANGRAM

**Position In System:** IV

**Number Of Satellites:** 2, one now destroyed

**Planetary Gravity:** 1.4 G

#### Planetary Size

Diameter: 18,200 km

Equatorial Circumference: 56,000 km

Total Surface Area: 714,000,000 sq. km

Percent Land Mass: 70%

Total Land Mass: 500,000,000 sq. km

#### Planetary Conditions

Length Of Day: 18 hr

Atmospheric Density: Thin, former atmosphere dispersed

General Climate: Desert, formerly warm temperate

#### Mineral Content

Normal Metals: 18    Industrial Crystals: 6

Radioactives: 8      Special Minerals: 6

Gemstones: 23



### DELTA KHINAH II

This planet, though it now lies in Klingon space and has a *Klingonaase* name meaning 'bravado,' is notable as the

planet near which the Romulans made first contact with the Klingon Empire.

### WORLD LOG

System Name: DELTA KHINAH

Number Of Class M Present: 1

**World Name:** DELTA KHINAH II

**Position In System:** II

**Number Of Satellites:** 2

**Planetary Gravity:** .8 G

#### Planetary Size

Diameter: 10,400 km

Equatorial Circumference: 32,000 km

Total Surface Area: 408,000,000 sq. km

Percent Land Mass: 34%

Total Land Mass: 139,000,000 sq. km

#### Planetary Conditions

Length Of Day: 32 hr

Atmospheric Density: terrestrial

General Climate: warm temperate

#### Mineral Content

Normal Metals: 1%

Radioactives: trace

Gemstones: 22%

Industrial Crystals: trace

Special Minerals: 8%



### D'RAVASASZ (Place Of The Great Brothers)

This world started as the site of a Romulan mining operation until the discovery of an underground complex obviously built by an advanced civilization. To the Romulans, the historical value of the site, believed to be an artifact of the Great Brothers, is enormous. This planet has become the closest thing the Romulans have to a sacred place, and it is heavily defended. It is visited by Romulan scholars and sci-

entists regularly; no non-Romulan has ever been allowed on the planet. The loss of this historical/sacred treasure trove would be a heavy blow to Romulan morale.

The underground complex strongly resembles a similar structure in the UFP found on a planet inhabited by humanoids resembling American Indians. Unlike the structure found in the UFP, this installation seems to have no purpose other than as a temporary base, now long abandoned.

#### WORLD LOG

System Name: D'RAVASASZ

Number Of Class M Present: 1

#### World Name: D'RAVASASZ

Position In System: IV

Number Of Satellites: 0

Planetary Gravity: 1.4 G

#### Planetary Size

Diameter: 18,200 km

Equatorial Circumference: 56,000 km

Total Surface Area: 714,000,000 sq. km

Percent Land Mass: 19%

Total Land Mass: 135,700,000 sq. km

#### Planetary Conditions

Length Of Day: 23 hr

Atmospheric Density: Terrestrial

General Climate: Arctic

#### Mineral Content

Normal Metals: 23%

Radioactives: trace

Gemstones: 22%

Industrial Crystals: trace

Special Minerals: 6%

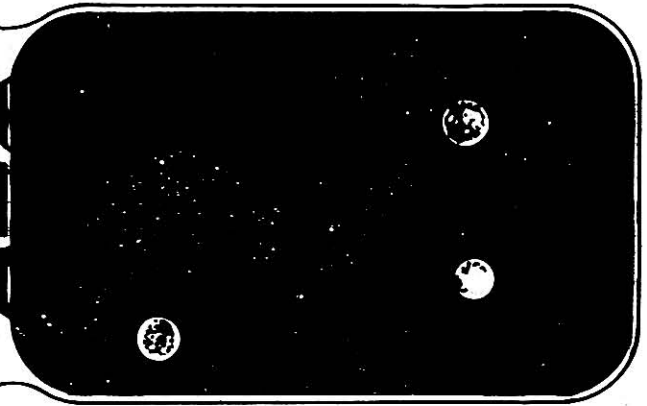

### GORWAH

Named for the local word for the native race, this planet was the first on which the Romulans encountered intelligent life. The reptilian Gorwah, though physically hardy like the Gorn they somewhat resemble, were technologically unprepared for the Romulans and became the first Romulan subject race.

Now, the Gorwah work the mines, bringing out raw

radioactive ores from places the Romulans themselves could never reach. The Gorwah metabolism is resistant, but not totally immune, to long-term, low-level radiation poisoning. The Gorwah never leave their home planet, as several experiments with exporting Gorwah laborers to other mining worlds met with failure; the Gorwah metabolism needs certain trace elements found only in their own ecosystem, and they die soon if moved elsewhere.

#### WORLD LOG

System Name: GORWAH

Number Of Class M Present: 3

#### World Name: GORWAH

Position In System: VI

Number Of Satellites: 3

Planetary Gravity: 1.3 G

#### Planetary Size

Diameter: 16,900 km

Equatorial Circumference: 52,000 km

Total Surface Area: 663,000,000 sq. km

Percent Land Mass: 12%

Total Land Mass: 795,600,000 sq. km

#### Planetary Conditions

Length Of Day: 20 hr

Atmospheric Density: Thin

General Climate: Warm temperate

#### Mineral Content

Normal Metals: 9%

Radioactives: 27%

Gemstones: trace

Industrial Crystals: trace

Special Minerals: trace

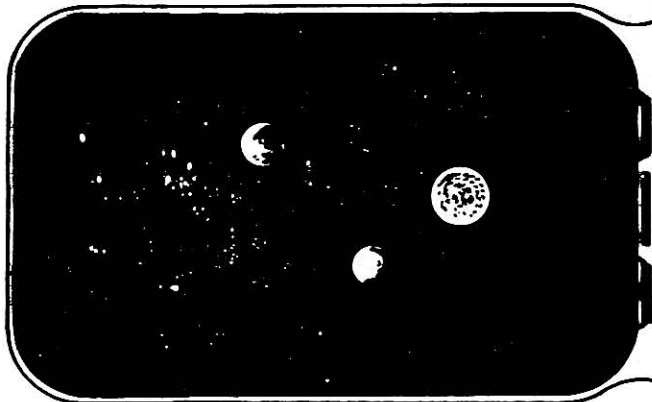

## LIFE AND CIVILIZATION LOG

**System Name:** GORWAH

**Code:** 1 1 2 2 1 0 - 2 2

**Formerly Dominant Race:** Gorwah

**Life Form:** Reptiles, large omnivores

**Attributes:**

STR-85                      END-55                      INT -50

DEX-50                      CHA-40                      LUC-20

PSI -10

**Tactical Movement And Combat Statistics:**

AP: 6                              Combat Skill Rating: 45

Damage: +5, massive,  
  clawed hands                      Armor: 12

## General Description:

These massive reptiles are perhaps related to the Gorn, though they had not yet developed into a technological society before becoming the first subject race of the Romulan Star Empire. They serve as laborers and miners on their home planet, under strict regulations prohibiting the teaching of advanced technology.

Possessed of a racial inferiority complex, the Gorwah have never revolted or provided much resistance against their Romulan masters. This could change, however, given charismatic leaders and the knowledge that a similar reptilian race (the Gorn) is highly advanced. This knowledge would have to come from elsewhere, because the Romulans themselves do not yet know about the Gorn.

## HANNRILETH (Swift Messages)

Hannrileth is not a rich world, but its position in space makes it an ideal site for a major subspace relay station. Because it is strategically important, it is well defended.

## WORLD LOG

**System Name:** HANNRILETH

**Number Of Class M Present:** 1

**World Name:** HANNRILETH

**Position In System:** VII

**Number Of Satellites:** 0

**Planetary Gravity:** 1.1 G

**Planetary Size**

Diameter: 14,300 km

Equatorial Circumference: 44,000 km

Total Surface Area: 561,000,000 sq. km

Percent Land Mass: 86%

Total Land Mass: 482,500,000 sq. km

**Planetary Conditions**

Length Of Day: 22 hr

Atmospheric Density: Terrestrial

General Climate: Desert

**Mineral Content**

Normal Metals: 19%

Radioactives: trace

Gemstones: trace

Industrial Crystals: trace

Special Minerals: trace



## KALABESTASZ (Place Of Storms)

This world is a mining colony best known for the spectacular electrical storms that occur here. The mountains of this world have deposits of an odd metallic compound that conducts electricity at room temperature better than any other known substance. The metal is used extensively in very critical circuitry design, but it is too scarce for general use.

## WORLD LOG

**System Name:** KALABESTASZ

**Number Of Class M Present:** 1

**World Name:** KALABESTAZ

**Position In System:** VI

**Number Of Satellites:** 0

**Planetary Gravity:** .7 G

**Planetary Size**

Diameter: 9,100 km

Equatorial Circumference: 28,000 km

Total Surface Area: 357,000,000 sq. km

Percent Land Mass: 53%

Total Land Mass: 189,000,000 sq. km

**Planetary Conditions**

Length Of Day: 24 hr

Atmospheric Density: Terrestrial

General Climate: Warm temperate

**Mineral Content**

Normal Metals: 47%

Radioactives: 35%

Gemstones: trace

Industrial Crystals: trace

Special Minerals: 3%

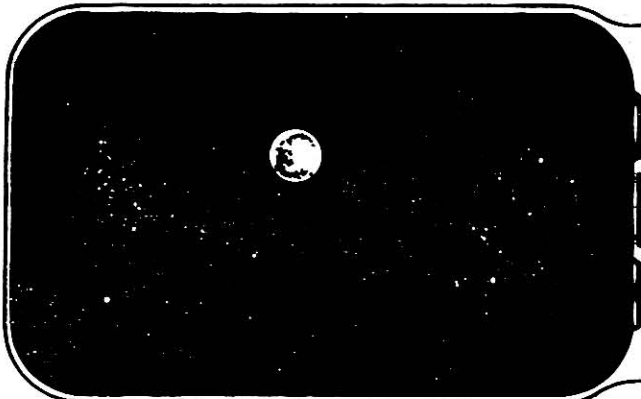

### MANDUKAM (Vigilance)

This world is the nearest major colony to the Neutral Zone. It serves as the base for the Outpost Division headquarters concerned with all operations along that strip of space.

### WORLD LOG

System Name: MANDUKAM

Number Of Class M Present: 1

#### World Name: MANDUKAM

Position In System: VIII

Number Of Satellites: 0

Planetary Gravity: 1.0 G

#### Planetary Size

Diameter: 13,000 km

Equatorial Circumference: 40,000 km

Total Surface Area: 510,000,000 sq. km

Percent Land Mass: 80%

Total Land Mass: 408,000,000 sq. km

#### Planetary Conditions

Length Of Day: 24 hr

Atmospheric Density: terrestrial

General Climate: Cool temperate

#### Mineral Content

Normal Metals: 34%

Radioactives: trace

Gemstones: 34%

Industrial Crystals: trace

Special Minerals: trace



### PERHONIES (Near-Light)

The only major significance of this world is its place in Romulan history as the first inhabitable planet settled by Romulans outside their own solar system. The early mining

operations brought many Romulans here, and it is now heavily populated and industrialized, despite the unpleasantly thick atmosphere.

### WORLD LOG

System Name: PERHONIES

Number Of Class M Present: 1

#### World Name: PERHONIES

Position In System: IX

Number Of Satellites: 3

Planetary Gravity: 1.3 G

#### Planetary Size

Diameter: 13,000 km

Equatorial Circumference: 52,000 km

Total Surface Area: 663,000,000 sq. km

Percent Land Mass: 24%

Total Land Mass: 159,000,000 sq. km

#### Planetary Conditions

Length Of Day: 20 hr

Atmospheric Density: Thick

General Climate: Warm temperate

#### Mineral Content

Normal Metals: 33%

Radioactives: 22%

Gemstones: trace

Industrial Crystals: trace

Special Minerals: trace



**SELTA AVASTAM (Point Of The Wedge)**

This metals-rich world was traded to the Klingons in one of the Romulan/Klingon technology exchange treaties. It

marks the farthest penetration of a Klingon colony into Romulan space, as it lies just past the agreed borderline.

**WORLD LOG**

**System Name:** SELTA AVASTAM  
**Number Of Class M Present:** 1

**World Name:** SELTA AVASTAM

**Position In System:** X

**Number Of Satellites:** 2

**Planetary Gravity:** .6 G

**Planetary Size**

Diameter: 7,800 km

Equatorial Circumference: 24,000 km

Total Surface Area: 306,000,000 km

Percent Land Mass: 57%

Total Land Mass: 174,000,000 km

**Planetary Conditions**

Length Of Day: 24 hr

Atmospheric Density: Terrestrial

General Climate: Warm temperate

**Mineral Content**

Normal Metals: 62%

Radioactives: trace

Gemstones: 9%

Industrial Crystals: trace

Special Minerals: 9%

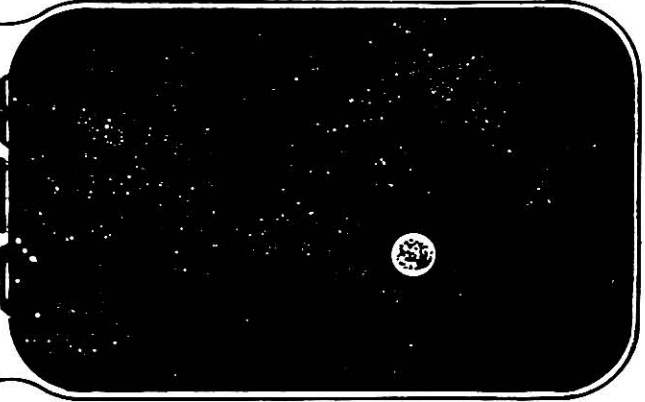

**VILLIAM III (Speaker)**

Unsuitable for mining and with an atmosphere too thin for agriculture, this planet is not of great strategic significance, and is notable only for its place in Klingon/Romulan

history. This world was the site of the first Klingon/Romulan conferences on technology exchange agreements, and the first treaties were signed here.

**WORLD LOG**

**System Name:** VILLIAM  
**Number Of Class M Present:** 1

**World Name:** VILLIAM III

**Position In System:** III

**Number Of Satellites:** 1

**Planetary Gravity:** 1.3 G

**Planetary Size**

Diameter: 16,900 km

Equatorial Circumference: 52,000 km

Total Surface Area: 663,000,000 sq. km

Percent Land Mass: 9%

Total Land Mass: 60,000,000 sq.km

**Planetary Conditions**

Length Of Day: 24 hr

Atmospheric Density: Terrestrial

General Climate: Cool temperate

**Mineral Content**

Normal Metals: 1%

Radioactives: trace

Gemstones: 24%

Industrial Crystals: trace

Special Minerals: 3%





## INTERSTELLAR INTERACTIONS

Further detail on the history of interaction with the UFP and Klingons may be found in the time line of historical events.

### GORN ALLIANCE

Gorn-controlled space lies close to the farthest galactic-northern borders of the Romulan Star Empire, and thus an encounter with the Gorn seems inevitable. Gorn expansion in recent years has been somewhat limited, perhaps due to continuing negotiations with the UFP and a desire for consolidation before trying to take control of more territory. The Romulans, on the other hand, have been sending scouts much farther into unexplored space in attempts to find new resource-worlds that do not conflict with either UFP or Klingon spheres of influence.

In fact, although neither the Federation nor the Romulans themselves are aware of it, the Gorn have encountered Romulan ships on two occasions.

#### First Contact

A Romulan scout wandered into Gorn space on Reference Stardate 2/1702.14 and was detected by a Gorn patrol craft. With typical Gorn lack of subtlety, the patrolling vessel reported the intrusion and attacked the Romulan craft immediately. Though the Romulan scout was not equipped with cloaking equipment because no encounter had been expected, it did return fire and, with some difficulty, destroyed the Gorn vessel.

The Romulan Commander, perhaps fearing to attract attention by transmitting, did not report the encounter immediately, but maintained the usual strict radio silence when in unknown or hostile territory. Unfortunately for the Star Empire's intelligence network, the damaged Romulan was pursued and overtaken by a Gorn task force before it could leave Gorn space. The Commander destroyed his vessel to avoid capture.

Neither race learned much from this first encounter. The Gorn recovered no wreckage and could not be certain that the ship was not of Federation origin, despite its strange appearance. The Romulans were not alarmed, for scout missions are inherently dangerous and many scouts do not return.

#### Second Encounter

The second encounter occurred on Reference Stardate 2/2112.02, when a Romulan scout entered a system recently claimed by the Gorn for asteroid mining. The scout had the bad luck to encounter a Gorn battleship at close range in the asteroid belt. The battleship, cruising the system to discourage rebellious Gorn known to be operating there, crippled the scout with close-range fire. The Romulan Commander and most of his crew were killed in the first volley, which also severed the scout's single warp engine nacelle from its pylon.

Left with no chance of escape, the remaining crew activated a backup self-destruct mechanism, but it was of limited effectiveness because it was unable to use the raw destructive power of the warp engine. The crew and ship's computers were destroyed, but much of the vessel was salvaged, giving the Gorn their first evidence of the Star Empire.

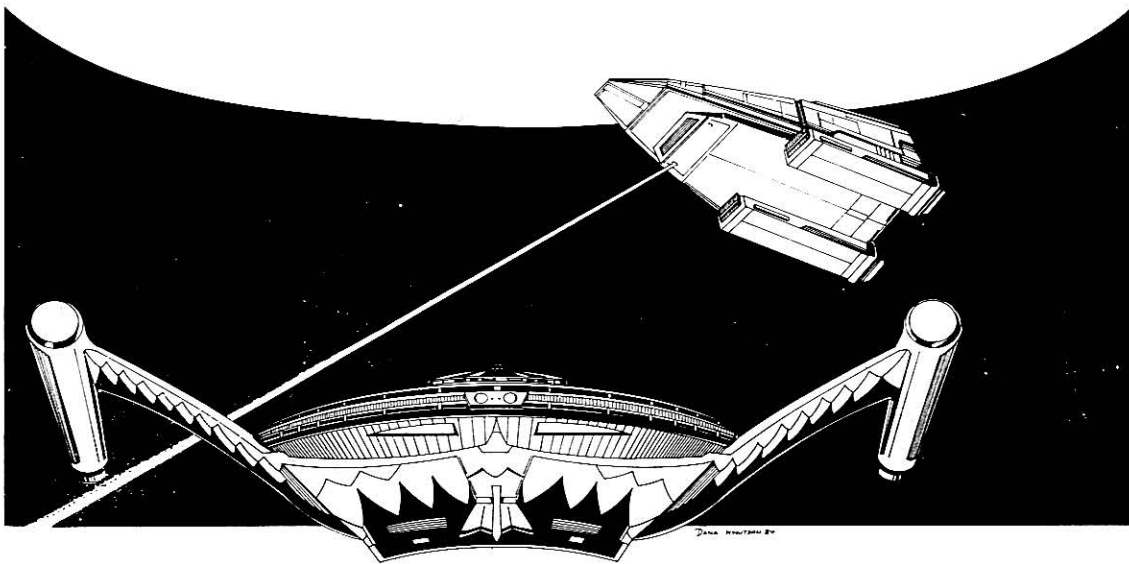

### Present Interactions

Currently, the Gorn are biding their time. They have reinforced defenses on the Gorn border facing Romulan space, but they have not made any overt, aggressive moves. Although they have deduced from open UFP records that their contacts have been with the race who once warred with the Federation, they have been reluctant to admit to UFP negotiators that they have encountered the Romulans themselves, likely fearing that word of the encounters would get back to the Romulans and rob them of their surprise.

The Romulans, for their part, have become suspicious. Though scouting missions are dangerous, the coincidence

of losing 2 vessels mysteriously in the same sector of space is great. The Star Empire knows little about the Gorn, their only source of information being random comments overheard by Romulan agents in the Triangle. They certainly do not know the exact location of the Gorn nor the extent of their holdings, but it likely will not be long before they send more-heavily armed ships to have a look around. The result could be explosive.

Of course, the UFP likely would warn the Gorn about the Romulans if they would simply ask the UFP for information. UFP negotiators are waiting, seeking to use such information as a bargaining point.

## KLINGON EMPIRE

The first Romulan contact with the Klingon Empire occurred on Stardate 0/0001.30, when the Romulan scout *L'Sattak* was attacked near the Romulan colony on Delta Khinah II. The Commander, seeing no way to survive an attack by 3 larger vessels, self-destructed, but not before the crew was able to dispatch a message pod back to their base carrying the vessel's log tapes, including the visual communications with the Klingons.

From these tapes, which showed who the attackers were and gave an idea of the enemy's technology, Romulan analysts were quick to declare the Klingons a worthy adversary, indeed a formidable one. The size of the expanding Klingon Empire was not known, and so the Romulans did not know whether they were up against a small planetary force that had a few good ships, or against a force larger than their own.

The Klingons declared war immediately. The Klingons, who were engaged in several other conflicts within and around their borders, could not afford a prolonged conflict with a powerful enemy. Nevertheless, the war lasted more than three years, with the Romulans suffering the worse losses, though the Klingons did not pay a light price. When neither side could afford to continue the fighting, the Klingons were very willing to negotiate a treaty, in their favor, of course. The Romulans conceded several small bases along with mineral rights to a large asteroid belt.

The Klingons and Romulans continued fighting informally for many years, neither side pushing for an escalation. Small raids were staged, usually with not more than 3 or 4 ships, all denied by the attacking side. Both sides made extensive use of privateers, and merchant vessels were armed and used as decoys. This see-saw activity continued for over 100 years. Much of the fighting centered in the area that has come to be known as the Triangle, that area of space where the Klingon, Romulan, and UFP areas of influence collide.

### First Romulan-Klingon Treaty

The petty bickering ended with the signing of the first of 3 non-aggression and technological exchange treaties, taking place on Reference Stardate 2/0902. This treaty allowed both sides to end the unofficial conflict and still save face, as it said nothing about ending any existing conflict, nor did it even acknowledge the existence of such conflict. Thus, it allowed them to act as if there had never been any fighting between them.

The galactic ramifications of this treaty have been immense. It allowed both sides to concentrate their main effort elsewhere. Specifically, it allowed them to concentrate on those who the Klingons were pushing as their common enemy – the UFP. The Klingons saw the alliance as a way to buy time. If the two powers jointly defeated the UFP, then the Klingons could attack and overwhelm the exhausted and depleted Romulan forces, especially if the Klingons held back and allowed the Romulans to do most of the fighting. In all practicality, the Romulans intended the same thing, but to a lesser extent.

Neither side gained any territory in this agreement, although disputes over contested areas, particularly in the Triangle, were settled. Both sides felt as if they had gained important concessions. They were publicly, if not privately, joined against the UFP. If nothing else, both sides gained valuable time to recoup losses and assess the future.

In the technology exchange, the Klingons gained older-model cloaking devices, which the Romulans equipped with a failsafe device that allowed only Romulans to work on them. If the Klingons attempted to open one to see what made it tick, it would self-destruct; this device caused the disappearance of several Klingon vessels shortly after the exchange was finalized. The Klingons also gained the plasma

weapon, a technology they much desired but had been unable to duplicate. This allowed them to develop their own version of the photon torpedo, which has technological roots similar to the plasma weapon.

The Romulans gained ships, most importantly the Klingon *D-7* Class Battlecruiser, though ore carriers, repair vessels, and a few scouts were gained. The *D-7* model gained was an older vessel, with some of the equipment stripped. The weaponry, an older model of the disruptor, was much-needed technology for the Romulans, who were able to adapt and modify it until their own versions became their main weaponry. The Romulans also gained hand disruptors, which rapidly became the personal weapon of choice.

Each side employed advisors to train the other in the use of the acquired equipment. Both sides fully realized that the advisors were little more than spies, and relegated the training vessels to back-water areas. As soon as was possible, both sides sent these advisors back home.

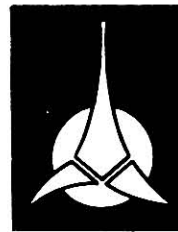

### Second Romulan-Klingon Treaty

With this treaty, signed on Stardate 2/1109.13, no technology of importance was exchanged. The main Romulan concession was to give the Klingons a much desired base in the Triangle, a base that the Romulans felt they were about to lose anyway. In return, the Klingons gave up several bases coreward of the Triangle.

### Third Romulan-Klingon Treaty

This treaty, signed on Reference Stardate 2/1801.18, gave the Romulans much-needed mining equipment of a type they had been unable to develop. The Klingons gained the new *Bird Of Prey* Class Scout. This 12-man vessel was deemed by the Romulans as being safe enough to trade, as it contained no technology the Klingons did not already have.

### Present Interactions

The Klingon-Romulan alliance is shakier today than it has been in many years. The Klingons have become more aggressive, openly attacking Romulan outposts, probing for weak spots and testing defenses for readiness and strength. Klingon diplomatic messages have had little real diplomacy in them, conveying lightly-veiled threats instead. The Klingons are readying for a major offensive, although it is doubtful if they could achieve real superiority in more than a small sector.

The Romulans, on the other hand, have taken a defensive posture. They are biding their time, hoping for a major UFP-Klingon conflict. They are more concerned with expansion coreward, but they are unwilling to give up any more of their territory.

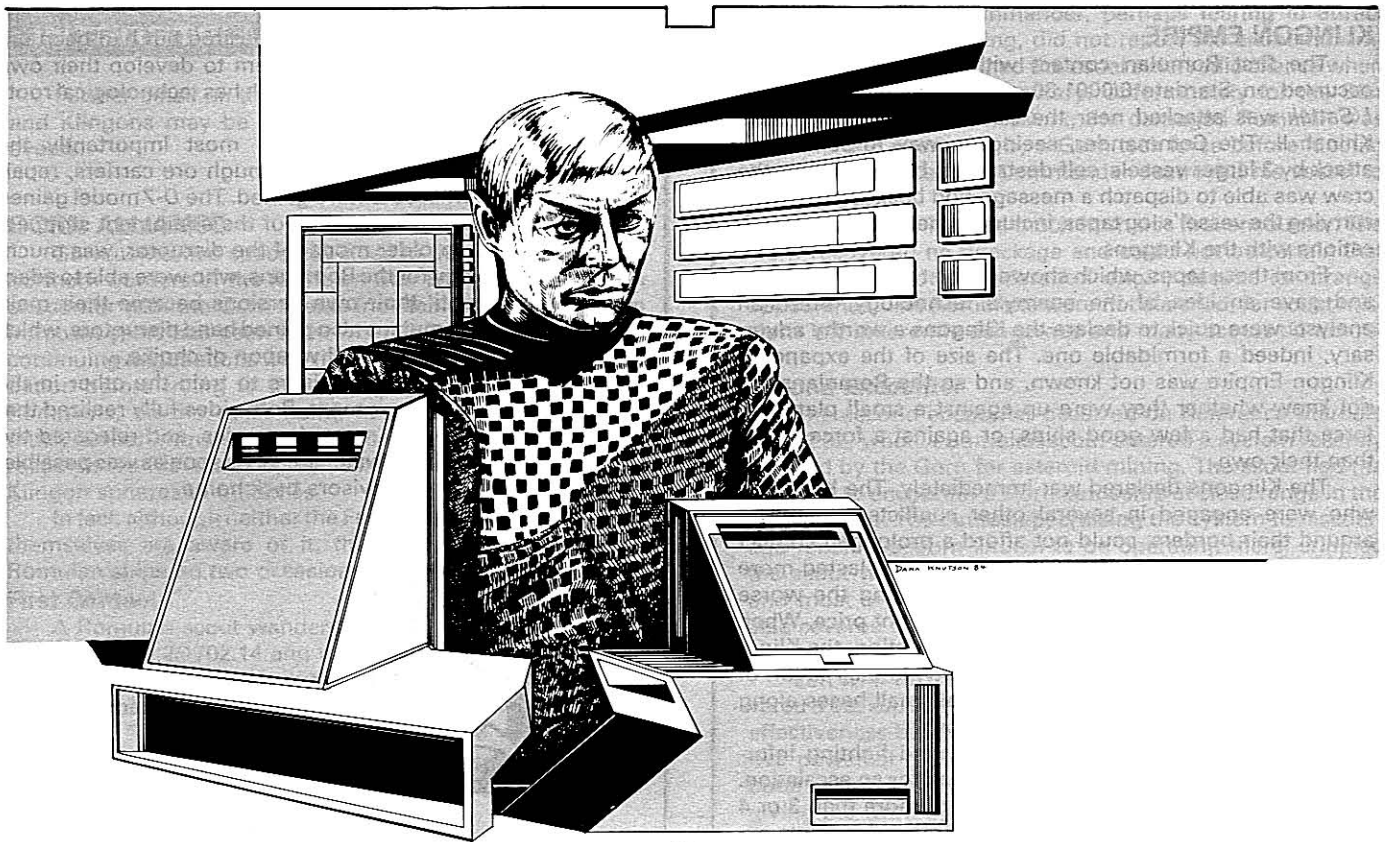

## UNITED FEDERATION OF PLANETS

The Romulans first encountered the UFP in Reference Stardate 0/9211, when a Federation cargo vessel strayed into Romulan territory and was destroyed. The UFP tried diplomacy with their new contact, but the Romulans, who had been unofficially at war with the Klingons for some time, suspected that it was a Klingon trick. They did not know at the time that the UFP was unaware of the existence of the Klingons.

Diplomacy failed, and war erupted between the two growing civilizations. The war was small compared to conflicts now, but at that time neither side was really prepared. The Romulans had most of their fighting vessels tied up nearer the Klingons, and the UFP did not possess many fighting vessels in the area. Heavy losses were taken on both sides during the 3 years of war. During the whole conflict, no one in the UFP ever once saw a Romulan, largely because none ever allowed himself to be captured.

### The Buffer Treaty

The Buffer Treaty established what is now called the Neutral Zone between the two cultures. This zone was not to be entered by either side for any reason, and any violation was to be treated as an act of war. No neutral third party was chosen to act as mediator, as none existed in the area. Over the years, each side has tested the other, probing for data and weak spots in the Neutral Zone. The situation has been likened to a period of Terra history known as the Cold War.

The treaty allowed outposts to be established on either side of the zone. No limitation was set on the number, but their size (crew complement of 37) and proximity to one another was set. Both sides were able to easily get around these limitations by building more-heavily manned outposts back from the zone and by using unmanned, remote listening devices between manned stations.

The remote listening devices are the target of much covert activity. Both sides have been known to not only si-

lence such devices but feed them inaccurate sensor data. Some have even been reprogrammed by inventive technicians. The most interesting example was the Federation manned station that reported a device was sending coded information for a popular Romulan game.

### Present Interactions

Neither side wants a war at this point. The Romulans are content to insure their rear lines are safe from attack. They are concerned with what they feel are expansionist tendencies of many UFP politicians. The Federation is concerned that the Romulans are greedy for domination of the galaxy. Many Federation leaders support a powerful front with the Romulans, but almost all are ready to concede that the greatest danger to both groups is the Klingons. Though many feel that the two cultures could be very good allies in a major conflict with the Klingons, very few feel that the two cultures will intermix well. Unlike the races that have intermixed successfully with the rest of the Federation, such as the Vulcans and Caitians, for example, the Romulans are much too large and much too different in their attitudes to coexist in the same space as the Federation. They could coexist peacefully side-by-side, but not intermixed.

There have been a few small skirmishes along and in the Neutral Zone. A few of these have come close to escalating into major conflicts, but cool heads have always prevailed. One of the most notable of these has come to be known as the Enterprise Incident, when Captain James T. Kirk, commanding the *USS Enterprise*, stole a cloaking device. In this incident, Kirk brought back the commanding Romulan officer when attempting to escape the zone. She was deposited on a neutral planet in the zone, but not before accusations started to fly from the Romulans. Fortunately, diplomats were able to calm things by returning her and by making other minor concessions, such as retrieval of Romulan buoys which had malfunctioned and strayed into Federation territory. To this day, relations with the Romulans are quiet, but shaky.

# The Romulan People

## PERSONALITY TRAITS

A Romulan's primary motivation is following his destiny. He takes literally the idea of building a road to the stars. Ever since the day that the first Romulan stepped onto Remus, Romulans have worked toward the steps necessary for galaxy-wide domination. This is their destiny, and they will not allow anyone to interfere with it.

Any culture that chooses to or that can be made to aid the Romulans in fulfilling their destiny is welcome to travel the road with them. Any culture that is likely to interfere with their destiny, however, will be crushed, of necessity. Thus, the Klingons and the Federation are to be fought, simply because they are in the way and not likely to be absorbed.

Asked to describe his people and their ways, a Romulan would state that they are creatures of duty. Duty, which is a way of translating destiny into personal behavior, is everything to a Romulan, and he will do what he feels duty-bound to do. A Romulan would not hesitate to give his life if he thought it his duty, or that dying would place his people one step closer to their destiny.

A Romulan's first duty is to his Great Brothers (gods); this duty to fulfill his destiny, to help build a road to the stars, is a Romulan's duty to his race. His next duty is to his family, whether it is his natural family (his parents and other relatives; his clan), or to his adopted family (his ship's officers and crew). His last duty is to himself; in Romulan society, the individual counts but little except as a cog on the greater wheel of Romulan destiny.

Their manifest destiny, coupled with a marked scarcity of resources, has caused the Romulans to adopt many interesting patterns of behavior. To conserve resources, they practice euthanasia (mercy-killing) of deformed or defective young and of the infirm and non-productive old; in battle, they practice it on the severely wounded. The Romulans practice complete equality of the sexes, because not to do so would be a waste of resources. Romulans practice none of the backstabbing or infighting typical of the Klingons; it simply is too wasteful of resources.

Because emotion often interferes with duty, Romulans suppress their emotions in a way similar to that of the Vulcans. Whereas the Vulcans suppress them to the point of not allowing them to show at all, the Romulans only suppress their emotions in public, outside small family groups. They express their emotions only in private, or share them with family or very close friends. At these times, they use their limited psionic abilities to enhance their emotions. The Romulans simply do not allow a stranger to see their emotional outpourings. To be allowed to share a family celebration or other event that deserves strong emotions is a great honor indeed, a privilege rarely granted even to other Romulans.

Other character traits shown by Romulans come out of those just described. Coupled with a Romulan's sense of duty is a sense of personal honor. For example, a Romulan would rather die than be forced to go back on his word. Among themselves, Romulans are generous, believing that "what's mine is yours."

Romulans appear to be warlike, largely because they have always had to fight to get what they wanted. This leads Romulans to believe that an item is not worth having if one does not have to fight for it. Thus, when an outsider gives a Romulan something, the Romulan is very skeptical and mistrusts the giver as he must be up to something.

Romulan law is based heavily on tradition: something is right because that is the way it has always been done. Anyone who scorns the traditions is soon outcast from society. Thus, Romulans frequently have a way of handling many situations. This may not be the easiest way, the most efficient way, or the best way, but it is "the Romulan way." The answer to many questions about why something is done usually is that "it is the Romulan way." In its final form, the Romulan Way (notice the capital) is the road to the stars.

Romulan law and traditions now are passed down in written form, necessary in a large stellar society. But these have been handed down over the ages in ballads. In the ancient days of individual city-states, the only person safe from harm was the traveling balladeer, the early historians. The stories, art, and especially songs still live today and play an important part in Romulan celebrations, and the storytelling art is highly valued. In short, Romulans love a good story.



## RELIGION

Religion influences all phases of Romulan society. The Romulans believe that the *D'ravsai* (Great Brothers), not supreme beings to be worshipped but a superior race to be emulated, placed the Romulan people on their planet and charged them to build a road to the stars. This task is the driving force behind Romulan civilization and culture.

Though this meshes completely with the theory about the Preservers, a race that seeded Humans and humanoids throughout the galaxy, Romulans do not fully support the Federation's view of that theory. They agree that a superior race put the original Vulcanoids on Rom'lasz, but they do not believe that this was incidental in a much larger seeding operation. They do not believe that the Preservers meant them to share the galaxy with any of the other humanoid peoples seeded there. Instead, they believe that they are the only race destined to rule the stars. And so, all Romulans are dedicated to build their road to the stars, one which they believe will bring them face to face with their Great Brothers.

Because of their view, the Romulans do not pray to gods, but commune, or talk, with personal Great Brothers, who are unseen, but present, during the discussions and dispense wisdom and advice. Communing Romulans do not expect their communication to be answered directly, and they do not seek divine intervention in daily activities. Instead, communing is a reminder that their actions are noted by their Great Brothers, and they ask support as one would ask moral support from one's family and friends. The relationship is not a casual one.

Romulan families have their own Great Brothers, who know all there is about the family through the generations. Though some families have a single, primary Great Brother, many families have several, acquired through the ages by inter-family marriage. Most Romulans acquire a new Great Brother upon entering The Great Duty, because all vessels and most bases have their own individual Great Brothers. There are not thousands upon thousands of Great Brothers, but a limited number shared by many vessels and families.

## FAMILY SHRINES

*D'hannam* (Great Communing, or Important Conversation) normally is carried out in a family shrine, called *d'bre-sasam rassam* (Family Gathering), though it may take place in any quiet location. Daily life centers around this shrine, and all important celebrations and activities take place here. All military vessels contain a shrine, which usually will be adopted as the individual's family shrine while he serves there.

Each Romulan takes great pride in his family shrine. This room is usually modestly furnished, with a seat or seats for the family Great Brothers to sit in during conversations. Many shrines have large tables where the family can gather and discuss family matters openly with the ever-present, unseen Great Brothers.

## STAGES IN LIFE

The life of a Romulan citizen often is discussed in terms of several stages, marked by events that are milestones in his history. The six stages discussed in detail here are more well-defined than the stages in a Human's life (birth, first word, first steps, first day at school, first date, first love, marriage, middle age, retirement, and so on). They are taken for granted by most Romulans. Often, other events in a Romulan's life are dated from one of these stages. For example, "Daltus was elected senator only four years after completing *d'talla*."

### D'NAVASSA: THE GREAT BEGINNING

The welcoming of a new-born Romulan is a solemn occasion, shared by the family with their gods. The ceremony does not occur until some hours after the child is born.

The birth itself occurs at home, with the help of a midwife. Only the mother and anyone involved with the actual birth see the child for the first few hours. The child is given a thorough physical examination to find any obvious defects. If there are problems, the child is taken away without the family ever seeing it. The child is put to death and the birth is treated as if it never happened.

If the child is physically acceptable, he is carried to the family shrine for presenting to the family gods and the family itself. The child, completely swaddled in a dark red robe, is presented to the family gods by the mother, who is expected to be up and about several hours after childbirth. Then, she presents the child to the family. The last in the family to see the child is the father, who presents the child to the gods again and gives the child its name.

### THE FIRST YEARS

Young children are given much love but are not babied; there is no pampering of Romulan children. They are raised in the home until the age of five. The Romulan family is a much extended one, so even if both parents are unable to raise the child, someone else in the family will do so. Many families have a form of day care, in which someone in the family has the responsibility of raising all the children in the family.

The first five years of the child are spent in informal education, with an eye toward discovering any hidden mental or physical defects. Basic language skills are taught, along with simple mathematical concepts, art, and music. Playtime is used to start development of interaction skills, including leadership. The family strives to correct any defects discovered, so that the child is fit when tested on his fifth birthday.

During these first 5 years, the child is examined annually. If any uncorrectable defects are found, the child is taken from his family and painlessly put to death. The Romulans look at this process as being better for the race, the family, and the child. Being resource-poor, they believe that if the weak are allowed to live, all will suffer. This is the Romulan Way.

## D'SORA: THE GREAT AGE

On his fifth birthday, a Romulan is inspected very thoroughly. If he passes the inspection, he is fully acknowledged and he comes of age at five. If he fails the inspection, he is put to death quietly.

The celebration of a child's coming of age is a great occasion. The child is dressed in bright robes with flowers atop his head. He is presented first to the family in the shrine. Then he is taken to the family great room, where friends have gathered. This is the child's first contact with non-family. A huge banquet is held, some lasting for several days. Entertainers perform, and stories are recounted of the family's past accomplishments. At sunset of the first day, the child stands and recites his family's lineage, a solemn ritual because family heritage and loyalty are revered above all else. At this ceremony, many children have their mate chosen for them.

If a child passes the inspection and a defect shows up before he is 20, the child (or young adult) may earn the right to live in the Arena of Life. In this arena, located in D'Sivas, the Romulan Capital, the youngster must fight a normal youth to the death. If the defective Romulan wins, then he has earned the right to live. Defects discovered after the age of 20 are ignored.

## PHI'LASASAM: THE EDUCATION

Unlike the children of most Federation worlds, a Romulan child is trained for duty, honor, and service to the Empire almost from birth. At the age of five, if he is one of the better than 95% (in modern times) who pass the final inspection, the young Romulan leaves his natural family and enters The Education, a combination of Federation primary school, secondary school, college, and Star Fleet Academy.

Between the approximate Terrestrial ages of 5 and 20, every Romulan attends school at training centers in every local town or large neighborhood, much like Terran public schools. He adopts his classmates and teachers as his 'family' during this process, without ever severing the ties that bind him to his natural family.

Physiological differences and centuries of selection and weeding out of the weak have caused Romulan children to develop much earlier than their Human counterparts. Romulan children naturally are able to assimilate teaching more readily than Federation children of comparable age. Furthermore, cultural differences accentuate this. Romulan children are pushed hard by their elders to succeed at a much earlier age; comparatively, Federation children are not pushed at all.

Thus, a Romulan child will spend a proportionally larger amount of time learning, training, and exercising than will a Human child, and so he gains skills at an earlier age. A Romulan at the age of 10 is about as mentally mature as a Human child at the age of 15.

This push for excellence causes Romulans to be somewhat deficient in the social skills that most Federation peoples take for granted. Romulans do not socialize as Humans do, preferring solitude whenever possible. Socialization skills are taught slowly throughout the teenage years to counteract the deficiency, and so social skills are present, but not instinctive, in most Romulans.

The Education is broken into three 5-year stages, as detailed below.

### Phi'navtasam: The Beginning

For the first five years of The Education, Romulan children learn the basics of Romulan life, general Romulan history, and basic physical fitness and athletics. During this five-year period, the child receives training in skills that will enable him to survive in the tough life of Romulan civilization. From the first, training is demanding and requires discipline and aptitude. Those who fall behind most likely will never catch up, and they will be forever denied the opportunity to gain the skills necessary to earn high rank and favor.

The Beginning concentrates mostly on physical training for good health, development of learning skills, indoctrination in Romulan customs, beliefs, and values, and aptitude testing. It is highly competitive, thus handicapping Romulan children more than their Terran counterparts in developing social skills. This handicap is felt in Romulan culture, but at the age of 10, a Romulan child has nearly as many skills and excellence in these skills as does a beginning cadet at Star Fleet Academy.

#### **Phi'deltasam: The Broadening**

During the second 5 years of his education, the Romulan child begins to learn the important skills involved in his chosen field. The results of the early aptitude testing allows the Romulan child to be guided into a general field of study. There are four major specialties in training that begin at this stage and continue throughout a Romulan's career: starship operation, starship function, sciences, and military operations. Each of these major specialties has 2 or more branches. In The Broadening, every Romulan's specialty and branch are selected. Although this choice is made by the school authorities, an important family may be able to somewhat influence the direction of their child's training. A child who has shown no particular aptitude for intellectual pursuits will be routed into combat training, and one who is less physical is likely to be routed into more intellectual fields.

During this stage, those destined for a naval career will actually be trained in general theories and overall familiarity with starship systems. This may seem incredible to a Terran, but the 10- to 15-year-old Romulan child is very advanced in temperament and training, compared to an Earth child of the same age. All Romulan children are well prepared for such studies by the time they reach this stage. Intensive work in logic, memory enhancement, and study discipline have been part of their lives since The Beginning. If, by this time, a child has shown no special aptitude, he may be tracked into a less sophisticated lane of study, to end up as a common laborer during the required military service. Once a child has been 'written off' as not being exceptional, it is very difficult for him to break out of such a training program and move up to more sophisticated education. Late bloomers rarely get a chance to rise above their early lack of promise.

#### **Phi'bresalsam: The Coming Together Of Knowledge**

The last five years of the student's education combine elements of both of the other stages of development. The student not only learns more of the things that make one a better Romulan, but he also expands his knowledge in his specialty. This phase continues the rigorous, semi-military training and directs the individual's attention toward specific goals, much like a Terran college student works toward a specific major and degree.

Some of the training is the same for each student, regardless of specialty. This will enable *all* to function equally well in most general situations aboard starships. It is in this stage that the student is expected to learn the social abilities that make civilization possible. The student is taught to work closely with others toward common goals. He also is taught to sublimate personal goals for the overall goals of the group. Of course, these ideas have been part of his daily life since birth, but now he is taught *why* this is so and why he must always do the best job possible for the Star Empire. Gaming and sports are planned parts of the student's curriculum to help him develop interpersonal relationships and teamwork skills and to reinforce the channelling of the pervasive competitive attitudes into productive ways.

#### **D'TALLA: THE GREAT DUTY**

After 15 years of formal education, every Romulan male and female enters military service. During this required 5-year tour of service, the student holds the rank of Equatoriam,

the Romulan Navy's lowest rank. The student is taught and tested for 1 year each in the Military Division, the Colonization Division, the Outpost Division, and the Exploration Division, serving under career officers in each posting. His fifth and final year is served in whichever division the student worked the best.

The young Romulan is now subject to military discipline, even if his job in each division is only a menial one. Here, those who are preparing for a career in the military get their on-the-job training, while those who will enter civilian life perform support duties in keeping with their education. These 5 years of service are considered to be the individual's payment, in advance, for the privilege of being a Romulan citizen. They also are an opportunity for a Romulan to get the finest professional training available.

At the age of 25, a Romulan has completed The Great Duty and becomes a full citizen with all a citizen's rights and privileges. At this time, any Romulan may enter the military as a career, a much-encouraged choice. Those whose education prepared them for such a life will have an easier time of it, but even one who has been trained only for manual labor may choose to spend his life in the service. Any Romulan, even those whose education prepared them for the military, may instead choose to enter civilian life; there is no stigma attached to such a choice. Even though career officers are treated with special deference and respect, many Romulan merchants, professionals, persons in the service industries, and family organizers (the Romulan equivalent of 'homemakers') will point with pride to their service in The Great Duty, with no particular desire to return to active military life.

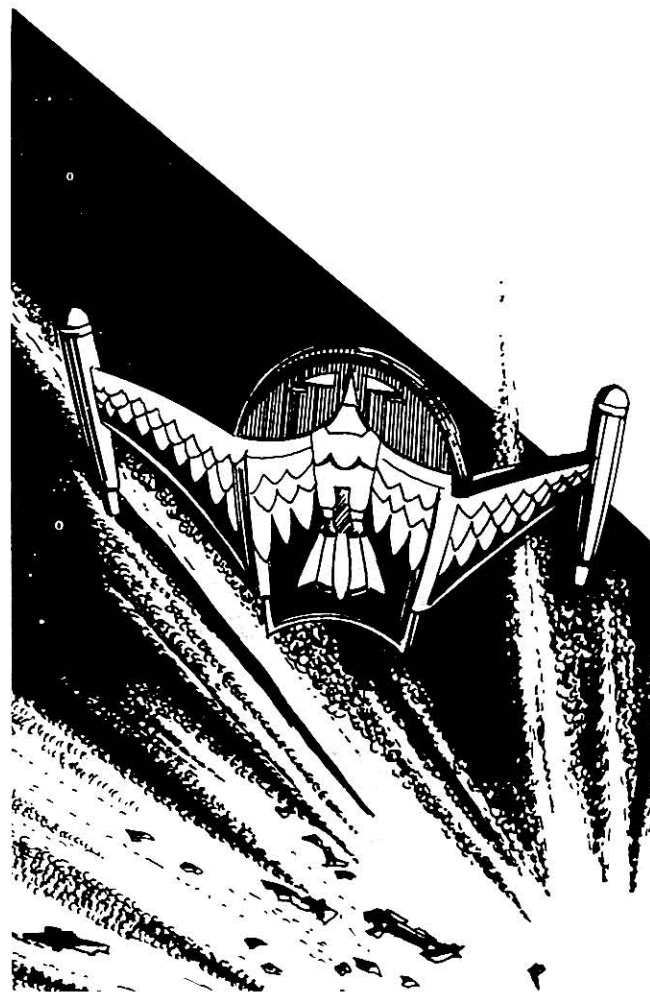

## CAREER MILITARY SERVICE

Military service in one of the four branches is encouraged, and many Romulans will continue to serve in the branch where they excelled; thus there is no need for a militia of civilian soldiers. Should a Romulan decide to remain in military service, he will be sent to Advanced Officer's Training. This 1-year course prepares the character for a career as an officer, teaching leadership, tactics, instruction skills and administrative skills. At the end of the year, the officer is automatically promoted to the rank of Secundam.

Any civilian may choose to reenter a military career at any time. Such a person would be assigned such duties and responsibilities as befits his capabilities. Some older Romulans reenter the military as a final gesture of service to the Empire.

In the same way, a career officer may decide to leave the military and reenter the private sector; he may return to duty, at which time he will be assigned a rank and position in keeping with the Navy's needs at the time. Furthermore, if the unique skills of one who has reentered civilian life are required, that person will be called upon to serve again, for whatever period his services are needed; *all* citizens are required to cooperate with such callbacks, and they are returned to their positions when their callback is ended. Because such service is directly in the needs of the Star Empire, no one may use a Romulan's absence to gain advantage over him; thus, he would not lose seniority or benefits, nor would he be passed over for promotion because he had been called up for special service.

## D'ANNA: THE GREAT JOINING

After serving The Great Duty and becoming a full citizen, a Romulan is allowed to marry; no Romulan may marry before this time. Marriage may occur at any age, although it is encouraged within 5 years after The Great Duty. A Romu-

lan is not forced to marry, but he is expected to have children whether he is married or not. Children born out of wedlock usually are raised by the mother's family, but this is not always the case if it is agreeable to both parents; no social stigma is attached to such children.

A mate may have been chosen for the Romulan at age five; if so, he will be encouraged to fulfill the family wishes and proceed with the marriage. Neither prospective partner is bound to the choice, however, and they may go their separate ways or choose to marry others. This is common if one of the two enters the military as a career and the other does not, because many married couples serve together aboard ships. In fact, many vessels are crewed by families, with the belief that they are more efficient from the closeness of the crew.

A wedding is celebrated because it joins two families into one. A wedding starts at the house of the groom. The couple arrives at the shrine, where only his parents will be waiting; the bride's family does not attend. Bride and groom are dressed in a simple, loose-fitting robe of the family color. When the couple enters the shrine, the groom's parents welcome the bride and then depart. The groom presents the bride to his family Great Brothers in a short communing. Afterwards, the groom drapes a long scarf-like shawl of his family's color around his bride's shoulders and leads her to a celebration with the groom's family.

The couple is expected to stay for several hours before they depart to the waiting bride's family, where the process is started all over. In the ceremony at the bride's house, she presents the groom to her family Great Brothers and places a shawl in her family color over the groom's shoulders.

After a celebration with the bride's family, the couple departs for their new home. Many young couples choose to be colonists, thus advancing the road to the stars.

## LATTA: THE DEPARTING

Death is a time of quiet reflection in Romulan society. Death is more final here than in many cultures, because the Romulans do not believe in life after death. There is no after-death joining with their Great Brothers, who are alive and well somewhere in the stars.

The word for death is *latta*. A Romulan's death is only called *d'latta* if the person died with great honor, as in a battle. To have it said that one died with honor is the greatest tribute a Romulan can be paid. *D'latta* is normally associated with the military, but this is not always the case. Anyone who contributes to the Romulan goal by his death is said to have died with honor.

*"... and let them stand shoulder to shoulder on the field of battle. Together they shall stand, and will stand together or fall together, for that is the way."*

## GOVERNMENT

The Romulan Star Empire is semi-democratic, with governmental control at 3 levels: the city-state level, the regional level, and the imperial level. The leaders of each governmental level are elected by vote of the Romulans at that level.

The Romulans do not have the problems with politicians common to most cultures; graft, corruption, and excess are practically unknown. The system is designed so that once someone is in a position of power, it is difficult to remove him. Romulan leaders look upon their elected positions as a serious duty, and the Romulan political system tends to breed professional politicians, men and women who are all dedicated to one immense goal – building the road to the stars.

The city-state, or local, level includes all city-states, colonies, or stations with populations of 10,000 or more. Small settlements and stations below this population normally are controlled by private industry (such as a mining company) or by the Romulan Navy. What governmental control, supervision, and services they require is handled by the regional governmental unit under whose jurisdiction they fall.

There are exactly 100 regions. From 60 to 120 city-state governments band together to form regions. The boundaries of the region are not fixed, but are adjusted every 10 years if needed to handle new settlements of voting size.

### CITY-STATE LEVEL

After their compulsory military service, every citizen 25 years and older is eligible to vote in local elections and to hold office. Because major lawbreakers are stripped of their citizenship, they are not allowed to vote or hold office. A Romulan's right to vote is not taken lightly, and most Romulans follow election proceedings regularly.

#### City-State Senators

There being no district elections, all 100 city-state senators (*safri sivas*) are elected from the city-state at large. Each serves a 5-year term. Elections are held on a rotating basis, so that about one-fifth, actually 19, are elected every year. This totals 95 of the 100 seats; the remaining 5 seats are for the Grand Senators.

One of the 95 city-state senators is elected by the senate to represent the city-state in the regional senate.

Any citizen may run for office. Except for those listed below, a citizen cannot refuse to stand for election, nor refuse to serve if elected. Active-duty career officers who would not be in the location long enough to serve, citizens who have served at least one term in the past, and those few citizens with sensitive jobs or rare skills who cannot be spared may refuse to accept an elected position. If a person with a sensitive job or a rare skill chooses to accept, accommodation for their service is made.

#### Grand Senators Of The City-State

The 5 Grand Senators (*d'safri sivas*) are chosen by their 95 peers from among themselves to serve permanent terms. These Romulans serve until they resign their office (unusual), are voted out by 80 or more members of the city-state senate (also unusual), or die. When a new Grand Senator is elected, his seat among the 95 city-state senators is filled by normal election.

#### Praetor Of The City-State

The 5 Grand Senators choose one of their number the city-state's top leader, the Praetor (*pratoram*). This position also is permanent, with the individual holding the position until he resigns, is voted out, or dies. A Praetor may be removed from office only by a vote of 95 members of the full 100-member senate.

Before a new Praetor can be chosen, his vacant seat among the Grand Senators is filled by election within the city-state senate. Then the Grand Senators choose the Praetor, and the open seat in the senate is filled by general election.

### REGIONAL LEVEL

There are 100 regions, each with its own Senators, Grand Senators, and Praetor. Each of these is elected just as within the city-states themselves, with each position being filled by election from within the rank just below.

Each city-state senate elects one of its members to represent the city-state in the regional senate. The exact number of these Regional Senators (*d'safri calanas*) varies from region to region. No region has fewer than 60 senators or more than 120. When a region gets larger than 120 city-states, regional boundaries are re-defined.

The number of Regional Senators elected each year depends on the size of the regional senate. Just as with the city-state senate elections, the regional senate elections are held on a rotating basis. About one-fifth are elected each year to serve a 5-year term.

Five Regional Senators are chosen as Grand Regional Senators by the members of the regional senate. These positions are permanent. The 5 Grand Senators choose a Regional Praetor, whose position also is permanent. Each regional senate also elects one of their members to serve on the Imperial Senate.

### MILITARY SENATE

The Imperial Navy behaves as though it were a separate region. It has its own senate, the largest of the few military systems in the galaxy to choose its top military policy makers by election.

One hundred Commanders are elected by their peers to sit on this senate. They choose 5 of their number to govern the senate in the same manner as the civilian senates. The military senate sends one of its members to represent it on the Imperial Senate, giving it a direct, though small, political voice in the Empire's affairs.

### IMPERIAL LEVEL

The Imperial Senate has 100 Senators, one from each of the regional senates. These 100 Imperial Senators elect 5 of their number to be the Grand Imperial Senators, and these 5 elect from among themselves the Emperor (*Pratoram Rom'Inz* – the Leader of the People).

Although the Imperial Senators are elected for 5-year terms just as with the lower-level senators, the positions of the 4 Grand Imperial Senators and the Emperor are permanent. As with any of the lower senates, vote of the Imperial Senate as a whole could remove a Grand Imperial Senator or even the Emperor himself. This has happened only once in Romulan history, however, and it was due to brain damage suffered in an accident. Emperors usually die in office, some perhaps having been assassinated.



## THE UNSEEN ONES: ROMULAN OUTCASTS

A Romulan who violates tradition in the extreme becomes a non-person, the most severe punishment in Romulan society. These *k'manatri* (literally, unseen ones) are the most wretched of individuals. As far as other Romulans are concerned, a *k'manatum* no longer exists. He will not be talked to, will not be fed, and will be looked through as if he is not even there. To acknowledge the existence of one such individual brings extreme dishonor.

Most *k'manatri* seem preoccupied with a struggle to regain their status. There is precedent for such a hope, but instances of *k'manatri* who have been readmitted to Romulan society are extremely rare. Simply dying in service to the Romulan Way is not enough, however, and to obtain redemption one would have to perform an act of extreme self-sacrifice in the Romulan cause, making a noteworthy step along the 'Road to the Stars.' Most legends and rumors of such *k'manatri* end with redemption coming hand-in-hand with death.

*K'manatri* frequently do not live long, becoming victims of accidents, particularly if they are troublesome. Some have lived a long time, though, with a few being 'underground legends' – never discussed but still well-known. A very small number are said to have managed to leave Romulan space altogether. Such individuals, if they indeed exist, could be an extreme embarrassment to the Empire.

Star Fleet Intelligence is aware of the existence of the *k'manatri* through rumor and legend, though the average Federation citizen or even the average Star Fleet officer is not. Naturally, such an individual could be very valuable for the information about the Romulans that he could tell. Several attempts have been made to recruit a *k'manatum* agent from among those reportedly located in The Triangle, but without success. A Romulan outcast is still a Romulan, in his own mind, and those approached have refused to help a government they still think of as 'the enemy.'

## MEDICAL AID AND ROMULAN MEDICAL PHILOSOPHY

Medical practices of the Romulans are similar to those of the Federation. Romulan doctors are very well trained and will usually work very hard to repair an injured comrade. They are relatively unconcerned, however, with bedside manner. Romulan physicians tend to be hard, practical, and very businesslike, an image fostering more respect than a friendly, concerned attitude.

Romulan medical personnel usually are not sent into combat. Not that Romulan physicians abhor violence or killing, because they are as capable of killing as any other Romulan race. Romulan physicians are not assigned to direct combat duties because of the time and training required to train them. Losing a physician in combat would be an unacceptable waste of resources. This does not mean that they will not endanger themselves at all. In a pinch, a Romulan medical officer is every inch a fighting soldier, and many have died alongside their comrades to prove it.

A Romulan physician will fight his enemies savagely to reach an injured comrade, regardless of the extent of the injuries. If the comrade cannot be saved, the doctor will consider himself duty-bound to save the patient from the dishonor of falling into the hands of the enemy – alive. In fact, allowing a fellow Romulan to be captured alive and not killing him first would be, to the Romulan, a disgrace second only to surrendering to the enemy. All Romulan physicians in the field carry swift-acting drugs for patients who request mercy-killing.

The same release would be routinely available to any Romulan who was injured or afflicted in a way that would make them incapable of functioning normally. No adult capable of rational decision would be forced to accept euthanasia, but the Romulan Way does not allow support and aid for the handicapped. Romulans do not consider the loss of limb use as necessarily being a handicap. Strength of mind is as valuable a commodity to the Romulans as strength of body, particularly if the stricken individual has useful skills that he or she can teach to others. Many Romulans who are injured or otherwise physically limited become teachers or fill other non-physical pursuits. Euthanasia would only be chosen by a Romulan if he felt he could make no useful contribution to Romulan advancement, but if this were so, he would most likely accept euthanasia rather than become a burden to his family.



# The Romulan Imperial Navy

## ORGANIZATION

The Romulan Imperial Navy is divided into four divisions, as shown on the accompanying organizational chart. Unlike Star Fleet, each division has its own substructure to supply its needs. Rather than have one scientific research unit responsible for supporting all the operating forces, one medical command, or one quartermaster corps, the Romulans found that their unique priorities made it more efficient for each division to handle all its own affairs. Because each division usually operates in different parts of the galaxy, rarely working with any other division, this makes some sense.

Though it might appear that this duplication of effort might make cooperation more difficult, it is not so, largely because all Romulans have the same goals and do not let petty rivalries or jealousies interfere.

### EXPLORATION DIVISION

The Exploration Division's task is to explore unknown areas of space. Extensive surveys are made, as the Romulans are not looking just for M-class planets to inhabit, they are looking for raw materials to fuel their economy. Its vessels, mainly smaller manned and unmanned scoutcraft, explore unknown regions, mapping as they go. Their data continually is sent back to the nearest exploration base or larger ship.

The Exploration Division is the most sought-after spot in the Romulan armed forces. The exploration team that makes an important discovery is sure to be respected. All Romulans look upon these groups as being the surveyors for their "Road to the Stars."

Because there are not enough manned vessels to cover all of the exploration projects, the Exploration Division makes extensive use of unmanned probes and landers. Many 'mother' ships are in use, carrying as many as 150 unmanned landers. When they reach a new star system, they launch several landers at a time, one to each planet holding promise for either settlement or mining. If the first unmanned lander returns promising data, then several more landers are sent to explore various sites on the planet. Only if enough convincing data is received is a manned party sent to do further investigation. The advantage of this method is that it uses much less man-power and enables a very small group to examine an entire solar system quite thoroughly. The disadvantage is that the unmanned probes might overlook unusual situations outside their programming.

### OUTPOST DIVISION

After exploration, the Outpost Division handles the next step in the 'road building' process. This division group maintains a wary eye on all borders of the Empire, not just along UFP or Klingon zones of influence. This division is considered to have the second best assignments in the navy, as this group is "next to the gods."

The Outpost Division constructs, places, and mans the Star Empire's outposts, which take many forms. The most common outpost is a small base, possibly domed, on a small planet or asteroid. Many of these asteroids have been hollowed out and fitted with impulse drive, allowing them limited movement. Other outposts are deep-space stations or satellites.

### COLONIZATION DIVISION

Although colonization is vital to the survival of the Romulan race, the Colonization Division is the smallest in the navy. The only naval personnel in this division are assigned to armed escort vessels and small ground units used to protect beginning settlements. The division moves and protect more people than any other, but the majority are non-military.

Many cultures colonize to relieve overpopulation. The Romulans, on the other hand, need the resources that colonies can provide, and so most Romulan colonies are mining or farming settlements. The Colonization Division forces establish a small colony, transport settlers there, and protects it while it gets organized.

When it is running efficiently and the route to it is deemed relatively safe, the colony is turned over to private ventures. The division's military personnel that helped settle the colony are given the option of staying or moving on to settle a new world. Most move on unless they have acquired a family in the process.

### MILITARY DIVISION

The Military Division, by far the largest arm of the Romulan navy, carries out the normal duties associated with military forces. It is responsible for the offensive and mobile defensive needs of the Romulan people. It organizes and mans primarily pre-emptive strikes against a world or culture that does not wish to cooperate with Romulan directives. The Military Division's policy is to remove a problem before it becomes worse. Thus, 'problem' worlds or cultures are eliminated as threats; frequently the whole culture is not eliminated from existence, but any of the culture's groups that may be a thorn in the Romulan side are eliminated.

Whereas the Outpost Division provides an early-warning system, so to speak, the Military Division provides the needed mobile line of defense. It can respond to an offense anywhere along its borders within a reasonable amount of time. The division's main forces, fleets capable of handling most problems that may arise, are stationed just within the borders of the Romulan sphere of influence.

Ground forces and internal security forces are also in this division. Internal security is much different and smaller than in many forces, as the Romulans do not have much of a problem with their own people.

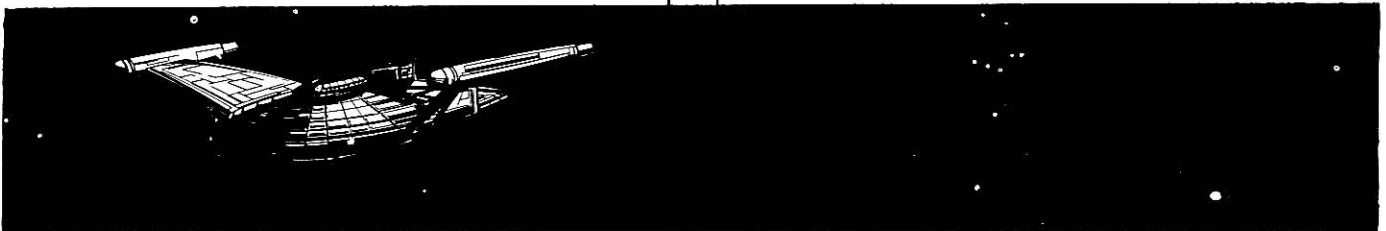

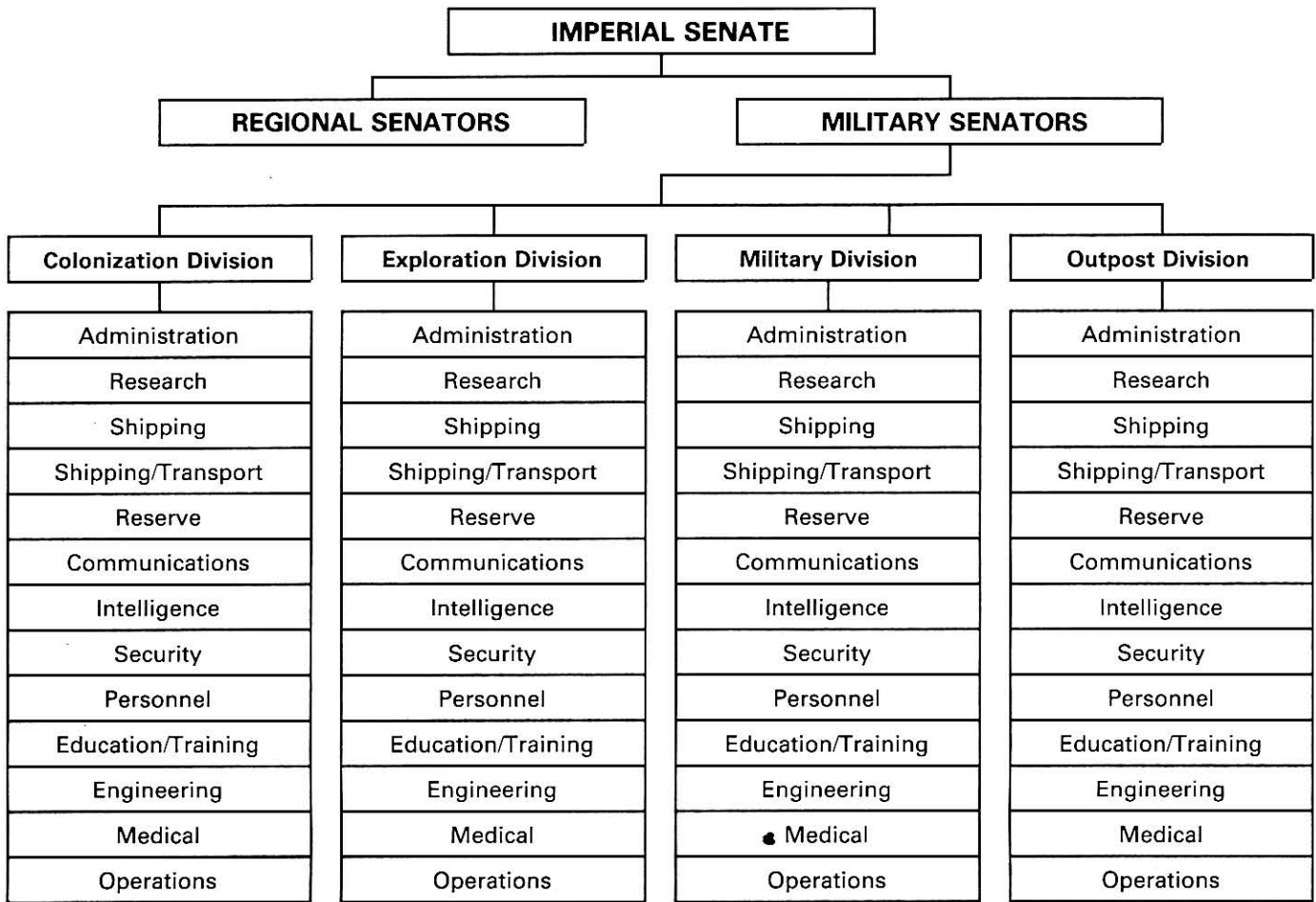

## RANK AND POSITION

In keeping with their resistance to artificial honors, the Romulan military uses fewer distinct ranks than either UFP Star Fleet or the Klingon military. These ranks are listed in the accompanying table.

### RANKS IN THE ROMULAN IMPERIAL NAVY

Equatoriam Secundam Trinam Centurion Sub-Commander Commander
---

Romulan rank structure seems confusing without the knowledge that ranks in the Romulan service are not meant as a gauge of achievement as much as a reminder of increased responsibility. The rank an officer attains is determined solely by need. A very good officer, respected and admired by all, may never be promoted past Centurion if there is not a need for a Sub-Commander with his particular skills. No Romulan would think that this lack of promotion marked the individual as incompetent or otherwise undesirable. Indeed, a less-experienced officer might be promoted before an older officer if the younger man had skills or training that made him a better choice for the job at hand.

All Romulans in their compulsory 5-year tour hold the rank of Equatoriam. Only if they remain in the military do they attend Advanced Officers' training and attain the rank

of Secundam. Further experience brings an increase in rank to Trinam.

A Romulan who is not in line of command, such as a medical officer, usually will not rise above the rank of Centurion, though more years of service will confer greater status even if rank remains the same. Because each one commands a ship, outpost, or group of men, there are a limited number of Sub-Commanders; no full-fledged star vessel will be directly commanded by a lesser rank. Also, if a Sub-Commander is assigned to command a vessel, no other person of that rank will be assigned to that same vessel; all other officers will be Centurions or below. A Commander is usually found in charge of a group of ships or larger unit, or perhaps in command of one particularly important ship or outpost.

## STARSHIP RECOGNITION FILE

### CAV'SANALAM (BILLED ONE; DUCK OF DOOM) Class Heavy Shuttlecraft

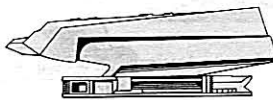
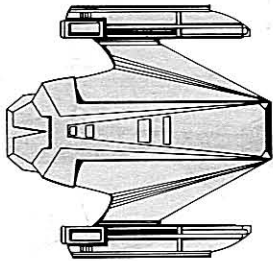

The *Billed One* heavy-duty shuttlecraft, with room for pilot, copilot, and 12 passengers, is carried only aboard vessels of cruiser size and larger, under normal circumstances. It is quite rugged, famous for getting in and out of rugged situations and for surviving rough landings. It can be refit easily in about 30 minutes for mass carrier duty, carrying up to 20 passengers, or for heavy cargo use.

*Billed One* shuttles are not armed, as such, but they are equipped with very powerful auxiliary jets as emergency landing thrusters. More than once, these have been brought to bear on unsuspecting ground targets to a devastating effect, but only during landing or takeoff. They are not accurate enough for use in a strafing run, and the ship must hover for a full 10 seconds to bring them to bear. The target may be up to 20 meters below the ship.

The emergency thrusters carry enough fuel to do this twice before they must be refueled. If the fuel is exhausted, the standard landing thrusters will still function, but the ship will have no emergency backup system if the standard thrusters fail.

#### Game Data

Attack with the emergency landing thrusters takes 1 game turn (10 seconds), during which the shuttlecraft must hover over a specific point. The backblast will do 80 damage points to all targets within a 15-meter- (10-square-) radius circle around the point directly below the shuttle. At the gamemaster's option, targets that make a successful Saving Roll against LUC may take half damage.

After 2 uses, the emergency landing thrusters will be out of fuel. If the standard thrusters fail, which occurs 1% of the time under normal conditions, there will be no backup. The failure chance increases to 10% if the thrusters are under unusual strain from a heavy load or if the shuttle has been damaged in some way.

### VAS'TEELIS (SONGBIRD) Class Shuttlecraft

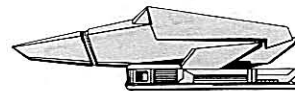
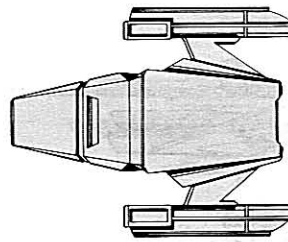

This shuttlecraft is carried by many Romulan vessels, especially those not capable of atmospheric landing. It is quite versatile, able to be refit within about 30 minutes from its usual capacity of 1 pilot and 7 passengers to an emergency landing craft carrying up to 12 passengers or to a cargo craft with the passenger seats removed.

The *Songbird* travels at a maximum of .82 lightspeed and is not capable of warp drive. Some models, usually those aboard combat vessels, are mounted with twin disruptors. These are mounted under the nose and have a 180° field of fire; they are useless against spaceborne targets like ships, but are effective against ground targets. The disruptor cannons used emit a characteristic high-pitched whine when fired, and it is this sound that bought the craft its unusual name.

### PRATORUM (PRAETOR) Class Warpshuttle

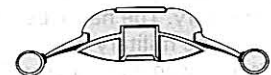
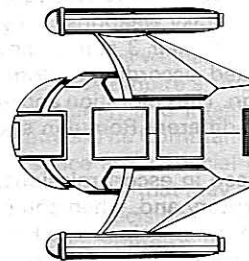

The *Praetor* is the only warpshuttle the Romulan Star Empire has produced in quantity. It is big for a shuttlecraft, with a crew of 2 and passenger facilities for 8, and thus it is usually ground-based, station-based, or carried aboard large vessels. These unarmed craft are fast and powerful, and they are rather luxurious by Romulan standards; for these reasons, they often are used for VIP transport and courier duty. The design is an old one, older even than that of the *Duck Of Doom*.

**VAS'HATHAM (BIRD OF PREY) Class Light Cruiser,  
Original Version**

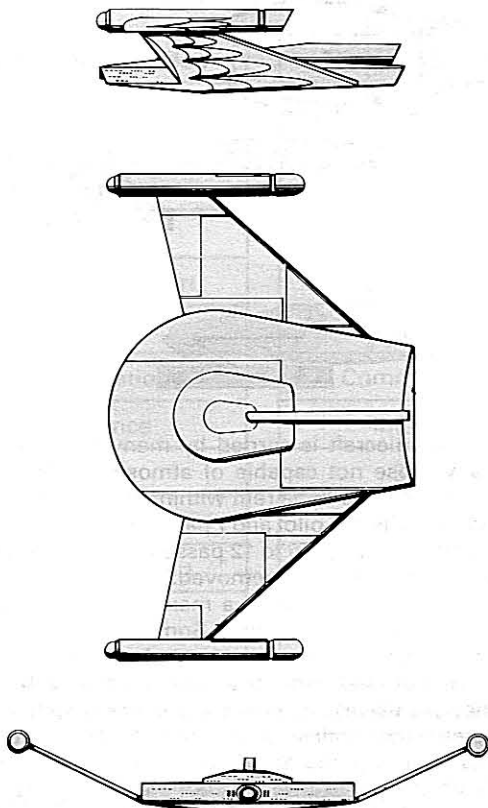

This most-familiar of all Romulan vessels was for many years the mainstay of the Romulan fleet. The original *Bird Of Prey* Class ended official operational status at approximately Reference Stardate 2/1200, but many variants still exist and are used in non-sensitive areas.

The original *Bird Of Prey* Class was the first Romulan ship built especially for use with the plasma weapon, the first ones literally built *around* the bulky weapons. They are capable of atmosphere landings on their 3 sturdy landing legs. The belly of the ship is painted, according to Romulan tradition, with a stylized bird design. The coloration and exact type of bird decoration identifies different Romulan squadrons.

The class was extensively used in escort missions, on quick-strike raids into Klingon territory and, when equipped with a cloaking device, on hit-and-run missions into Federation territory. The name became synonymous with Romulan spaceborne military power, so much so that the name 'Bird Of Prey' became popularly, if incorrectly, used for any Romulan vessel, not just ones of this class.

After the original was no longer being manufactured, the class name later was applied to another ship of which the Romulans were particularly proud. This was a good public relations move on the part of the Star Empire, as the name 'Romulan Bird-of-Prey' is known and feared as no other in space.

**VAS'KALABAM (STORMBIRD) Class Cruiser,  
Klingon D-7 Design**

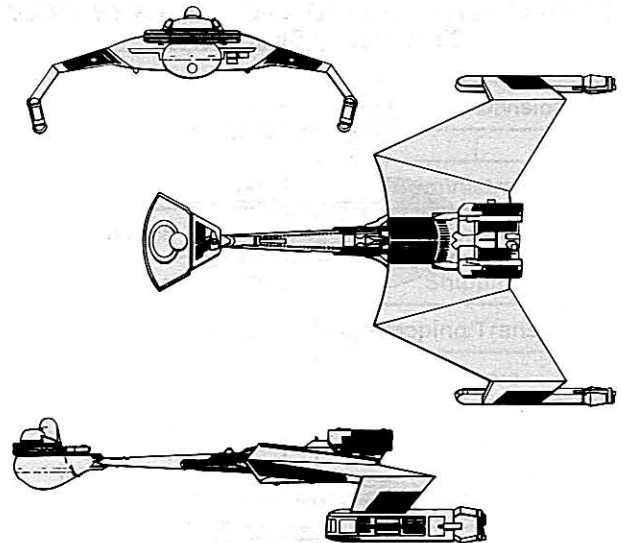

Variants of the familiar Klingon *D-7* Class Battlecruiser have been adapted and used by the Romulans ever since the technological exchanges. Most such ships have been fitted with cloaking devices, and later variants have plasma weapons or the very late-development, Romulan torpedoes.

Though they are efficient and inexpensive to operate, Romulan commanders do not really like these vessels. Romulan pride prevents a Commander from being really comfortable in what is essentially an enemy vessel. Even so, they fill an important niche in the Star Empire's spaceborne forces, and continue to be purchased from the Klingons for use along the UFP borders.

**VAS'DELETHAM (WINGED DEFENDER)  
Class Heavy Cruiser**

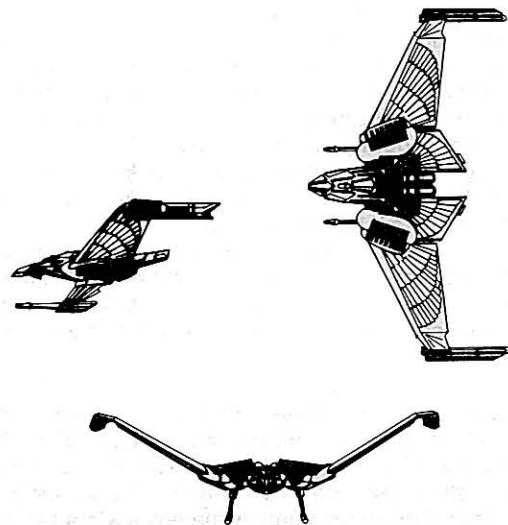

The *Winged Defender* Class is the great Romulan hope for eventual replacement of the Klingon-designed *Stormbird* Class vessels that they have been using. It has a new variable-geometry design with impressive firepower and performance, but it will take time for it to be deployed in large numbers. The wing-like outriggers sweep up for cruising and down to full-spread position for attack runs.

**VERELAN VASTARUM (GRACEFUL FLYER)  
Class Scout/Courier**

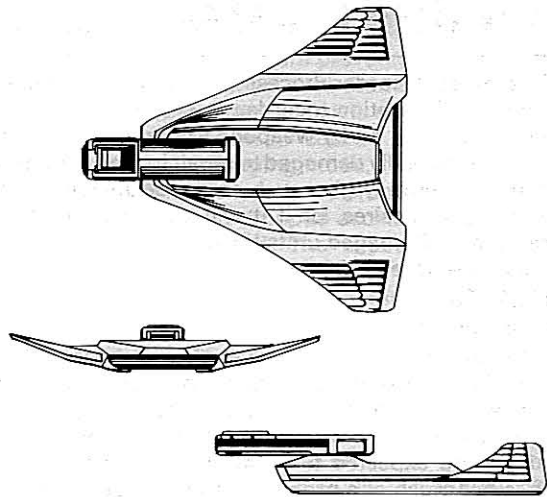

This design is used extensively by the Exploration Division as a first-contact scout and by the Military Division as a fast courier. Though it is not heavily armed or shielded, its versatile design serves very well for non-combat duties. It is capable of atmospheric landings, and so it carries no shuttlecraft.

**ALVAS'HATHAM (BIRD OF PREY)  
Class Scout, Up-rated Version**

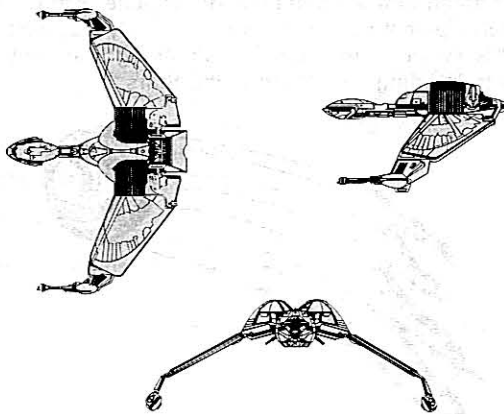

This ship design blends Klingon and Romulan technology and is used by both fleets. The power plant and weapons are of Klingon design, but the basic hull design is unmistakably Romulan. Its resemblance to Romulan carnivorous flyers and the need to have an operational ship of this name led to the adoption of the class name. This ship is capable of atmospheric landings and is well-armed for its size, though it is no match for a big combat ship.

The Klingon version of the scoutship is designated as the *K-22 Class* by the UFP; called the *D'Gavama Class* by the Klingons, one of these vessels was captured intact by Adm. James T. Kirk at the breakup of the Genesis Planet. Furthermore, much to the chagrin of the Romulans, the Klingons liked this design so much that they have used its basic lines in the construction of at least 2 classes of larger ships. Thus, the Star Empire may find itself attacked someday by vessels that are based on their own design and that they themselves do not have!

**VAS'CALANAM (AVIARY) Class Defense Outpost**

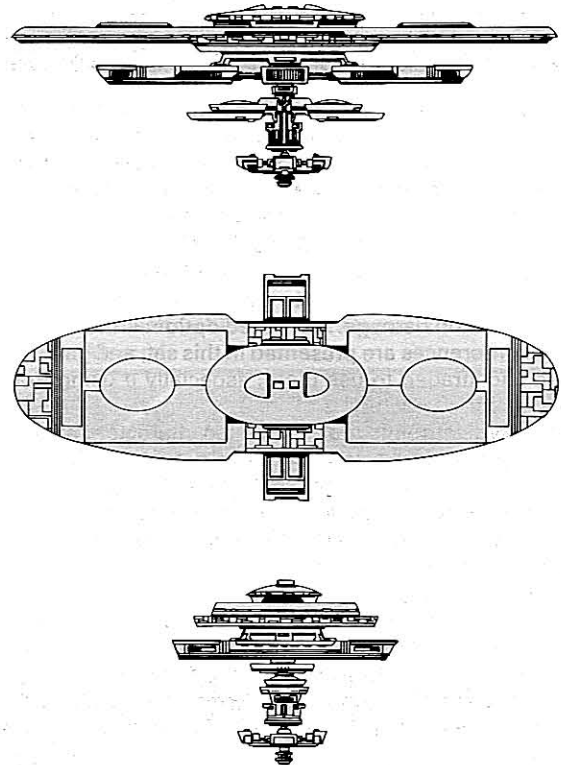

This type of defense outpost, one of the mainstays of the Outpost Division, is used in major sensitive areas along both the UFP neutral zone and the Klingon border. The station's power is provided by matter/antimatter generators, backed up by auxiliary generators operating on principles to similar that of the impulse engine; similar generators may be found on Star Fleet space stations. These generators are much like engines for all purposes except mobility, and may not be used to move the outpost.

Usually, its crew is charged with monitoring several smaller posts as well as automated sensors along a perimeter. The Star Empire's finest experts on electronic surveillance, security, and intelligence can be found assigned to these posts. The Commanders of these far-flung, sentry towers in space are a special breed, akin to the UFP's starship commanders, in that they are frequently called upon to make life-or-death decisions on split-second notice. In addition to the outpost, some of them have several small vessels assigned under their overall command.

# Judging The Romulan Way

## JUDGING GROUND ACTION

In general, ground action with Romulans may be judged using the rules given in ST:RPG2. The few procedures that differ between Romulans and Star Fleet officers, or involve new ideas presented in this expansion, are detailed in this section for the convenience of the gamemaster.

### INJURY, MEDICAL AID, AND DEATH

In order to keep play simple, the STRPG2 rules do not take differences in non-Human physiology into account in determining stun damage. Advanced optional rules allowing for these differences are presented in this set, and gamemasters are encouraged to use them, especially if using Romulans as player characters.

These adjustments make Romulan characters more viable as long-term characters, and also provide more realism for the game by adjusting for the alien nature of the race. If the optional adjustments are used for Romulan characters, they also should be applied to Vulcan characters whose physiology is similar.

### Stun Damage For Non-Human Races

The table below shows the differences in stun damage for Humans, Romulans/Vulcans, and Klingons (presented for comparison). The slight reduction in effect is due mostly to Romulan training in resisting the effects of shock, and the less-vulnerable nervous system of the Romulan/Vulcan physical type.

#### DIFFERENCES IN STUN DAMAGE FOR VARIOUS STAR TREK RACES

	Humans	Romulans Or Vulcans	Klingons Fusions	Imperials
<b>STUN DAMAGE</b>				
Hit	75	70	60	50
Graze	25	25	20	20
<b>HEAVY STUN DAMAGE</b>				
Hit	120	110	100	80
Graze	40	40	35	30

## JUDGING EQUIPMENT USE

Unless information is presented here, Romulan equipment use is judged in the same way as the use of comparable Star Fleet equipment.

### PERSONAL EQUIPMENT

#### Image Recorder/Processor

The user of this device must state what type of scan is being made, and in what direction. The detection arc of this unit is 90°. Any activity in this area that is within range will be detected. A single, directional scan takes about 10 seconds.

Common scans require no Skill Roll for operators with a rating of at least 10 in *Computer Operation*. If the scan is unusual (for alien life forms, or for a specific type of energy reading), the operator must make a Skill Roll against the rating in *Computer Operation*.

The Image Recorder/Processor is a bit more rugged than the standard Federation tricorder. It will remain operational unless it is directly hit by weapons fire or a heavy object. If so, it will be too badly damaged to repair in the field, although the gamemaster may give such an opportunity in marginal cases, if he so desires, or if it will advance the plot in a desirable way. Damaged units have a 50% chance of losing the data they were carrying.

### UNIFORMS

#### Rank Insignia

Though rank insignia are used, they are worn rarely except outside of a Romulan's vessel or current assignment area. Sash color normally is enough to distinguish those ranks that are due extra respect and military courtesies. Romulans are expected to know their superiors on sight, which is not much of a problem because most serve on the same vessel or at the same station for a long period of time.

#### Decorations

There are very few decorations for duty in the Romulan forces, as all Romulans are expected to do a good job in the performance of his duty. There are no decorations like Terra's Purple Heart or Good Conduct Medal, but there are a few decorations for outstanding service. Two of these are described and illustrated below. These are never worn on the uniform, but are displayed in the privacy of one's quarters. **D'takaran (The Great Comet):** This decoration is given to one who makes a great advance in exploration or scouting, such as the finding of a large deposit of valuable resources or of a habitable planet nearer the core. The only way a Romulan wins this award is to discover something that contributes greatly to building the "Road to the Stars."

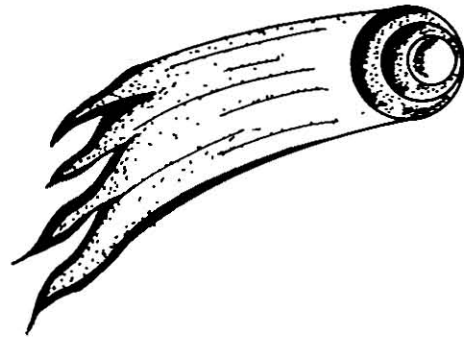

**Ranam Valassa (Shining Star):** This award is given to a great hero for service above and beyond the normal call of duty. Terra's Medal of Honor is an equivalent.

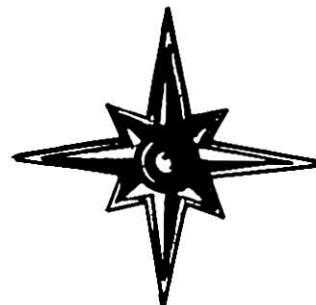

## SIDEARMS AND OTHER WEAPONS

### Hand Disruptor

To operate this weapon, a character must strap it onto the back of the hand to operate, which will take about one minute (6 turns). A safety feature prevents the weapon from firing when it is not strapped onto the hand (or a similarly sized and shaped object, perhaps). It is always ready for use, and thus there is never an AP cost to draw or ready this weapon unless it is in charging mode.

Because the Romulan-design disruptor fits on the back of the hand, it cannot be dropped accidentally, or knocked out of the operator's hand. The exposed nature of the weapon, however, renders it somewhat vulnerable to damage. If the operator of such a weapon is involved in hand-to-hand combat, a Saving Roll against the average of the character's LUC score and his Skill Rating in *Unarmed Personal Combat* should be made if damage is scored by the opponent. If the save fails, the weapon is struck instead of the user. The user suffers no damage, but the weapon is rendered inoperative. The gamemaster may also require a LUC Saving Roll if the character falls down a slope, is slammed against a wall, or otherwise flails about in a manner that might get his weapon banged up.

A damaged weapon can be repaired in the field about half the time (1 - 50 on D100) by an individual trained in *Personal Weapons Technology*. Small tools must be available, and the character must make a successful Skill Roll. Occasionally (91 - 00 on D100), the weapon is reduced to metal and plastic junk and must be scrapped. The rest of the time (51 - 90 on D100), damage is fairly extensive and the unit must be returned to a shipboard or planetside workshop for repair.

The solar array can recharge the weapon, even if it is not strapped to the hand. The *Adjust Weapon Settings* tactical option is used to make this adjustment, at a cost of 2 AP. It will convert available sunlight to power at a rate of 1 point every 5 minutes, but only if there is sunlight or bright artificial available; candlelight, moonlight, and other dim light sources are not sufficient.

## SHIPBOARD SYSTEMS

### Cloaking Device

The secret of constructing a cloaking device and of disarming its defense booby-traps is known to only a few key scientists and technicians in the Romulan Star Empire (Skill Rating of at least 85 in *Cloaking Device Technology*). These few individuals are heavily hypno-conditioned so that any attempt to force the secret from them, or even any attempt by the individual to reveal the secret willingly, results in the immediate death of the technical expert. The Klingon Empire is known to have captured one of the cloaking device technicians, but even the reknowned Klingon subtleties in interrogation were to no avail.

The Klingon Empire has purchased several ships equipped with cloaking devices as allowed by the technological exchange treaties. These devices given the Klingons, however, were constructed and installed by Romulan technicians. The Klingons have been taught to operate them and even service them to some extent, but they remain totally ignorant of cloaking theory or the device's internal configuration. Despite warnings of the consequences, the Klingons still lose a ship every now and then trying to find out the secret. Most, but not all, of the cloaking devices in service with the Klingon Empire are installed aboard Romulan-designed ships.

### Plasma Bolt Weapon

The following rules revision alters the damage effects of Romulan plasma weapons to more accurately reflect the destructive potential of these devices. The new rules spread the damage throughout the ship instead of concentrating it

on one spot. They also allow lucky commanders to maneuver their ships out of the way of a direct hit, taking only a graze.

**Graze Damage:**When a player-character ship is struck by a plasma weapon, the ship's commander makes a Saving Roll against his LUC score. If the roll is successful, the commander managed to maneuver his vessel out of the direct path of the bolt, causing it only to graze his ship. In this case, the ship takes only half damage from the graze. A gamemaster may disallow the Saving Roll in unusual circumstances (such as when the target vessel is immobile, or otherwise handicapped) or even allow it for non-player character ships.

**Damage Table:**The table below gives the total damage for each plasma weapon type as a function of range. In the table, the damage number before the slash represents the normal damage and the number after the slash is the graze damage for the weapon. This chart replaces those in the STRPG game rules, the *STIII Starship Combat Game*, and the *Ship Construction Manual*.

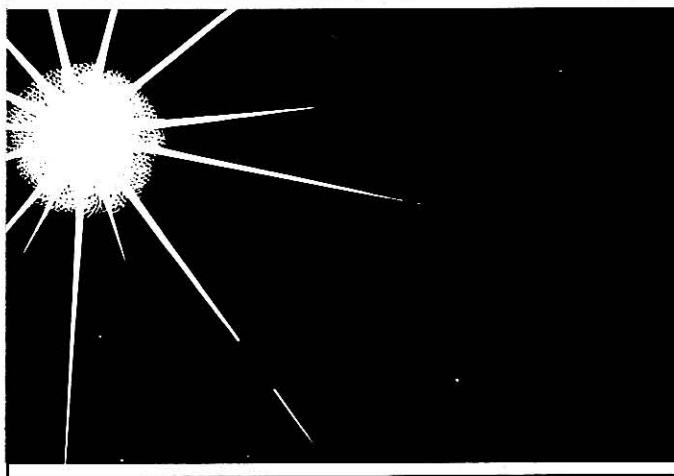

### TOTAL DAMAGE FROM ROMULAN PLASMA WEAPONS

Range	RL-1	RL-2	RL-3
1	24/12	32/16	28/14
2	20/10	32/16	28/14
3	20/10	32/16	28/14
4	16/8	24/12	28/14
5	16/8	24/12	24/12
6	12/6	24/12	24/12
7	8/4	20/10	24/12
8	4/2	20/10	24/12
9	—	16/8	20/10
10	—	16/8	20/10
11	—	12/6	20/10
12	—	12/6	16/8
13	—	8/4	16/8
14	—	8/4	12/6
15	—	—	12/6

**Spreading The Damage:**A plasma bolt that penetrates shielding may damage several systems because the effects from a plasma bolt tend to spread, as opposed to being concentrated as with beam-type weapons. Thus, damage taken from plasma attacks is spread among possible targeted systems. When a plasma bolt scores a hit, reduce damage according to shield strength as normal. Then, for each 5 points of damage that got through the shield, roll for damage location. Continue rolling damage locations separately for each 5-point block until all damage is recorded.



## JUDGING FOR ROMULAN PLAYER CHARACTERS

It is strongly suggested that gamemasters not start players into a game as Romulan player characters until they have had some experience at playing non-humans within the context of Star Fleet campaign play. Learning to play an alien within a familiar society is easier than starting fresh with an alien character in an alien society.

### PLAYER CHARACTER ROLES

Playing the role of an alien character is much more difficult to do well than playing a Human character. All readers of this game have a lifetime of experience (their own lifetime up till now, anyway) at being Human, and no experience whatsoever at *being* a Romulan, Klingon, Vulcan, or whatever.

One cannot ask a Human player to "think like a Romulan." It *is* fair, however, to try and encourage him to *imagine* how a Romulan might think! Of course, not all Romulans think alike, any more than all Humans do.

Encourage players to develop distinctive personalities for their alien characters, and not to play them as if they were all stamped out with one cookie-cutter. Distinctive need not mean extreme. Playing a vastly atypical Romulan is just a way of avoiding playing a Romulan at all. If all the characters are misfits, what are they doing representing the Romulans as officers, anyway?

Local color provided by the gamemaster adds enormously to the players' ability to assume an alien role. Remind the players with description and example that they are on a *Romulan* ship. Emphasize cultural points that are uniquely Romulan, and have non-player character Romulans reflect their culture and background in their interactions with player characters.

### THE INFORMATION GAP

The gamemaster has a more difficult job when trying to work with a player group with alien characters. More than ever, a gamemaster must remember that the *character* has a background in the alien society being played, even if the *player* does not. Do not expect players to know details about their society unless they have had an opportunity to learn them as part of the game, or have been briefed on them in advance. It is not good form to have the climax to an adventure depend on the players knowing some fact of Romulan existence that any *Romulan character* of 6 would know, but that the *players* have had no chance to learn. Neither is playing much fun if the gamemaster specifically briefs the players on critical points in advance of play, as this removes the element of surprise.

In some cases, the gamemaster may cleverly plant knowledge in advance, much as a mystery writer will plant important facts in early parts of a whodunit novel. Unfortunately, few of us gamemasters are Agatha Christie. A clumsily-revealed piece of data is enough to spoil a whole adventure. Work on subtlety, or find another way. In many cases, it is quite permissible to use Saving Rolls or Skill Rolls to determine if a character remembers a crucial piece of information that the *character* would know, but the *player* would not.

This can also work the other way. A Romulan *character* would not know much about Star Fleet organization, perhaps, but a *player* might, especially if he were playing a Star Fleet character only last week. It is perfectly permissible to require an appropriate saving roll for the *character* to know or find out something that the *player* knows perfectly well.

It is best, however, not to have crisis points in adventures hang on obscure alien knowledge. Judgement and logic do not vary as much with culture as one might think. Let players and characters be guided by the situation as presented by the gamemaster, rather than things outside their control during the game.

### HINTS ABOUT PLAY

A game with Romulan player characters will most likely involve more violent confrontation than a game with Star Fleet characters, but much less than a game with Klingon characters. Things should not degenerate into a shooting gallery all the time, however. Romulans don't tend to shoot their way out of situations, and many adventure situations must be played through rather than shot away! The gamemaster's skill in designing and running scenarios will determine the tone of the campaign. He must keep control of the game, and be careful not to set up situations that can be solved easily by disruptor fire or a well-placed plasma bolt.

In a game with Romulan characters, neither the gamemaster nor the players should make the mistake of thinking of the Romulans as evil. They are *different*, and often these differences shape their thinking in a way that conflicts with Human goals and philosophies. Their environment has created in them a devotion to the group, rather than the individual.

The Romulan Way should be uppermost in the gamemaster's mind as he plans and controls a Romulan-centered game. If the gamemaster has the proper line of thought, the players will follow. Gamemastering for an alien player group is an even more mind-stretching exercise than *playing* an alien, and stretching one's mind is more than half the fun of any role-playing game!

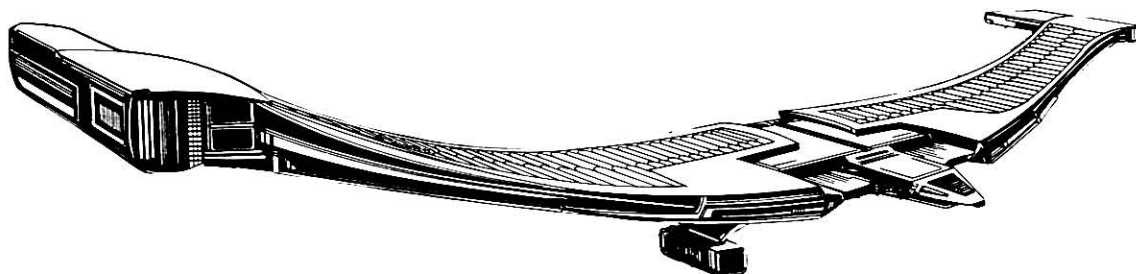

# Creating Romulan Characters

## DEFINING ROMULAN CHARACTERS

Like other people, not all Romulans are the same in every area. Each is an individual, and may be stronger or weaker, faster or slower, and even luckier or less so than his or her neighbor. Furthermore, different Romulan's skills and talents also vary, and so each character will have a different set of skills and Skill Ratings representing his relative ability to do things. It is in the areas of attributes and skills that Romulan characters will be defined. In creating a Romulan character, many decisions pertaining to these areas must be made. These decisions will make the character unique.

This section outlines the seven attributes and 50 skills used in STRPG2 and will give a brief insight as to what Attribute Scores and Skill Ratings mean in relation to Romulans.

### ATTRIBUTES

The seven attributes are strength (STR), endurance (END), intellect (INT), dexterity (DEX), charisma (CHA), luck (LUC), and psionic potential (PSI). As with Star Fleet Officers, once these numbers have been determined for Romulan characters, they will not normally change during the course of a game. The descriptions of attributes and how they are used in the game is the same for Romulan characters as for the Federation characters created by the STRPG2 rules.

It is interesting to note that, whereas the Star Fleet officers created with the STRPG2 rules are the best that the Federation can train, Romulan characters created with these rules are *AVERAGE* members of the race. Thus, to create a character at any point during his or her time in The Service, simply stop character creation at that spot. Any member of the Romulan race can be created with these rules, because any Romulan with lower Attribute Scores will not survive past the age of five.

### SKILLS

Skills and their use by Romulans is the same as the skills and skill use given in the STRPG2 rules. Gamemasters using the first-edition rules will note that some skill names have changed, some skill areas have been added, some skill areas have been subdivided, and some skill areas combined in the STRPG2 rules. Furthermore, the meaning and use of Skill Ratings has been clarified and changed. This expansion follows the STRPG2 use exclusively.

### Cloaking Device Technology

This skill covers knowledge of the intricate workings of the Romulan cloaking device. Development includes study of cloaking theory and its reverse, cloaking penetration, with extensive practice in cloaking device construction. Training also is given in cloaking device maintenance and emergency repair.

High-level training (Skill Ratings of 85 or more) involves the automatic destruct mechanism built into the circuitry. Training involves separating the destruct mechanism from the cloaking circuitry and bypassing the mechanism in emergencies.

### Cloaking Procedures

This skill is involved in the use of the cloaking device on all classes of starships. Training is given in selecting power settings, jamming frequencies, reflective and refractive grid combinations, and the like to fit many combat situations. Training also is given in detecting cloaked objects, and in the operation of the special cloaking detectors that bypass all cloaking devices sold to the Klingons.

## CREATING ROMULAN CHARACTERS

This section will provide all that is needed to generate the Attribute Scores and Endurance Statistics of a Romulan character. It follows the same format as that developed in STRPG2, and all tables have been adjusted to account for the differences between Human characters and Romulans.

*A sample character is created using these rules. This character's attributes and skills will be created in the examples given in each rules section. The character is Tevus, a female.*

### ASSIGNED SHIP, RANK, AND POSITION

As in Star Fleet characters created by using the STRPG2 rules, the first step in Romulan character creation is deciding the character's ship, his rank, and his position.

The character's gender (sex) will have no bearing on play. Romulans demand the same minimum physical standards from all citizens, be they male or female, and equal opportunities are available to either gender. For Romulan NPCs, roll the gender randomly.

For Romulan player characters, the gamemaster will decide on the ship to be used and what positions will be available. Then, the players and the gamemaster will decide which player's character will take each position.

The assigned ship, rank, and position, along with the character's name and gender, is recorded on a *Romulan Character Data Record*.

*Tevus will be a department head aboard one of the mighty WINGED DEFENDER Class Cruisers. She will be a Helm/Navigation Specialist of Centurion rank.*

### CHOOSING A RACE

The rules in this expansion assume that all characters will be pure-strain Romulans.

It is possible, however, to create Romulan/Vulcan hybrids such as Lt. Saavik from the *STAR TREK* movies, but this is very rare. Only one character in a group, at most, should be a hybrid. For hybrids, the dominant parent race should be chosen.

The character's race should be recorded on the *Romulan Character Data Record*.

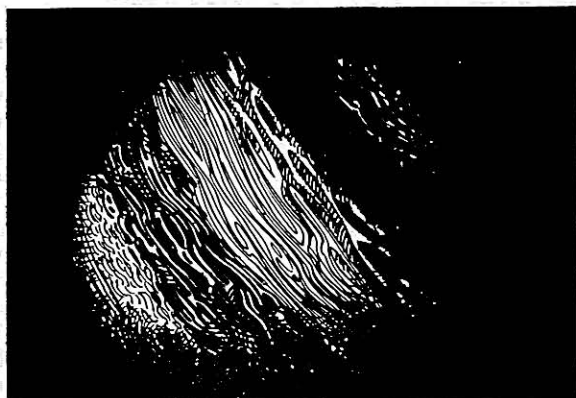

## CREATING ATTRIBUTE SCORES

Attribute Scores are created using dice rolls and applying the racial modifiers unique to Romulans. Bonus points are then applied to build a unique character. Follow the step-by-step procedure below.

### Initial Dice Roll

Each of the character's STR, END, INT, DEX, and CHA Attribute Scores are created by rolling 3D10 and adding 40. This means that the lowest number possible is a 43 ( $1 + 1 + 1 + 40 = 43$ ), the highest is 70 ( $10 + 10 + 10 + 40 = 70$ ), and the average is 57 ( $43 + 70 = 113$ ;  $113 / 2 = 56.5$ , rounded up to 57). The LUC and PSI Scores are rolled with percentile dice (D100).

For our example, Tevus' strength rolls are 7, 4, and 5, so Tevus' initial STR roll is 56 ( $7 + 4 + 5 + 40 = 56$ ). The rest of her rolls are:

END = 53    INT = 54    DEX = 20  
CHA = 58    LUC = 60    PSI = 84

### Racial Modifiers

Romulans tend to be somewhat stronger, more hardy, and more agile than Humans, but they are not very lucky. They tend to have a somewhat lower Psionic Potential than do the Vulcans.

#### RACIAL MODIFIERS TO ATTRIBUTE SCORES

	STR	END	INT	DEX	CHA	LUC	PSI
Modifier	+10	+10	none	+5	none	-10	-20

Add or subtract the modifiers to the attributes already created to adjust for Romulan racial differences. If the attribute score is zero or less, then adjust it upward to 1.

In our example, Tevus has the following adjusted Attribute Scores:

STR = 66 ( $56 + 10$ )    END = 63 ( $53 + 10$ )  
INT = 54 ( $54 + 0$ )    DEX = 65 ( $60 + 5$ )  
CHA = 58 ( $58 + 0$ )    LUC = 50 ( $60 - 10$ )  
PSI = 64 ( $84 - 20$ )

### Bonus Points

Bonus points are available to distribute among the Attribute Scores to create unique individuals. To determine the number of bonus points, roll D100 and divide by 2. These may be added to any attribute except PSI, with two restrictions. No more than 30 points may be added to one attribute, and no attribute may be adjusted to more than 99 by using bonus points.

As our example, Tevus' player had 34 bonus points ( $69 / 2 = 34.5$ , rounded down to 34), which were divided between INT, DEX and LUC. The final scores are:

STR = 66    END = 63    INT = 64  
DEX = 75    CHA = 58    LUC = 64  
PSI = 64.

## CREATING ENDURANCE STATISTICS

Each of the 6 endurance statistics is discussed in detail in the STRPG2 rules section on **Injury, Medical Aid, and Recovery**. Gamemasters and players who are familiar only with the first edition rules will find these statistics and their use substantially altered, making for better play. As the endurance statistics are created, record them on the *Romulan Character Data Record* in the appropriate places.

As in STRPG2, a character's END score is used to determine his Maximum Operating Endurance (MAX OP END), which describes his overall physical condition, and his Current Operating Endurance (CURR OP END), which describes his condition from moment to moment, including his fatigue. The character's Wound Healing Rate and Fatigue Healing Rate are also determined from the END score. How to calculate these is given below.

A character's Inaction Save Level (INACT SAVE), the point at which he can no longer function normally because of injury or fatigue, is fixed at 20 as in STRPG2, unless the optional rules are used as given below. A character's Unconsciousness Threshold (UNC THRESH), the point at which a character passes out, is fixed at 5.

### Maximum Operating Endurance (MAX OP END)

At the beginning of the game, and at any time when the character is not suffering from wound damage, his MAX OP END is the same as his END score. Wound damage is subtracted from this score. Thus, this number should be recorded in pencil, because it will change as he suffers from wound damage and is later healed.

In our example, Tevus' original MAX OP END is 63.

### Current Operating Endurance (CURR OP END)

At any time when the character is not fatigued or suffering from other temporary damage, his CURR OP END is the same as his MAX OP END. As fatigue, stun damage, or other temporary damage build up, it is subtracted from this score. Thus, this number should be recorded in pencil, because it will change as a character grows tired and then has a chance to rest and recover.

In our example, Tevus' original CURR OP END also is 63.

### Wound Healing Rate

The rate at which a character recovers from wound damage is related to his END score. To find this number, divide the END score by 20 and round down. This gives the number of points of wound damage that will be healed after 1 day of rest.

For example, Tevus has a Wound Healing Rate of 3 points per day ( $63 / 20 = 3.15$ , rounded down to 3).

### Fatigue Healing Rate

The rate at which a character recovers from temporary damage also is related to his END score. To find this number, divide the END score by 10 and round down. This gives the number of points of temporary damage that will be restored after 30 minutes of inactivity.

For example, Tevus has a Fatigue Healing Rate of 6 points per half hour ( $63 / 10 = 6.3$  rounded down to 6).

### Inaction Save Level

The INACT SAVE LEVEL for Romulan and Vulcan characters may be varied from the STRPG2 rules at the option of the gamemaster, more accurately simulating the Romulan/Vulcan physiology. Romulans and Vulcans are more resistant to pain, fatigue, and physical shock than are Humans or most other humanoid races. This does not imply that Romulans use Vulcan pain reduction techniques, but merely reflect that, in general, Vulcans and Romulans have a more resistant physiology.

To simulate this, set the INACT SAVE LEVEL for ALL Romulan and Vulcan characters, both player characters and NPCs, at 15, as compared to 20 for the other STAR TREK races. Use of this rule adds to realism, but also adds complexity, and thus it is completely optional. Record the value chosen, whether it is 15 or 20 in the space provided on the *Romulan Character Data Record*.

## CHARACTER AGING

Romulans are relatively long-lived. The critical age at which a Romulan character's scores for STR, DEX and END may fall off is 70 years of age.

# Romulan Star Empire Character Data Record



Name: TEVUS Age: 46  
 Rank: CENTURION Sex: F  
 Assignment: EXPLORATION DIVISION Race: ROM.  
 Ship: \_\_\_\_\_  
 Position: HELM/NAVIGATION

STR <b>66</b>	END <b>63</b>	INT <b>64</b>	DEX <b>75</b>	CHA <b>58</b>	LUC <b>64</b>	PSI <b>64</b>																
INACT SAVE 15	UNC THRESH 5	MAX OP END <b>63</b>	CURR OP END <b>63</b>	TO-HIT, MOD <b>63</b>	TO-HIT, HTH <b>61</b>	To-HIT, Dueling Stick <b>59</b>																
WOUND HEAL RATE <b>3</b>	FATIGUE HEAL RATE <b>6</b>	<table border="1"> <tr> <td>Pre-Education</td> <td>The Education</td> <td>Service Year 1</td> <td>Service Year 2</td> <td>Service Year 3</td> <td>Service Year 4</td> <td>Service Year 5</td> <td>Adv. Off. Train.</td> </tr> <tr> <td></td> <td></td> <td></td> <td></td> <td></td> <td></td> <td></td> <td></td> </tr> </table>				Pre-Education	The Education	Service Year 1	Service Year 2	Service Year 3	Service Year 4	Service Year 5	Adv. Off. Train.									BARE-HAND DAMAGE <b>1019+8</b>
Pre-Education	The Education					Service Year 1	Service Year 2	Service Year 3	Service Year 4	Service Year 5	Adv. Off. Train.											

## Service Experience Charts

Assignment:

- Exploration Division
- Outpost Division
- Colonization Division
- Military Division
- Tour Length (years)
- Efficiency Report (%)

5	15	1	1	1	1	1	1	1											

## Skill List

Administration	<u>20</u>	* Marksmanship, Archaic	<u>51</u>	Small Unit Tactics	_____
* Artistic Expression	_____	Marksmanship, Modern	_____	* Social Sciences	_____
Carousing	_____	Mechanical Engineering	_____	Romulan Culture/History	<u>19</u>
Cloaking Device Technology	_____	* Medical Sciences	_____	Romulan Law	<u>10</u>
Cloaking Procedures	_____	General Medicine	_____	* Space Sciences	<u>ASTROGATION 51</u>
Commun. Systems Operation	_____	Negotiation/Diplomacy	<u>10</u>	Astronomy	_____
Commun. Systems Technology	_____	* Personal Combat, Armed	<u>DUELING STICK 42</u>	<u>ASTROPHYSICS 10</u>	
Computer Operation	<u>19</u>	_____	_____	* Sports	<u>ACROBATICS 9</u>
Computer Technology	_____	Personal Combat, Unarmed	<u>47</u>	* Starship Combat Strategy/Tactics	<u>51</u>
Damage Control Procedures	<u>20</u>	Personal Weapons Technology	_____	Starship Helm Operation	<u>54</u>
Deflector Shield Operation	<u>37</u>	* Physical Sciences	<u>PHYSICS 27</u>	Starship Sensors	<u>47</u>
Deflector Shield Technology	_____	_____	_____	Starship Weaponry Operations	_____
Electronics Technology	_____	_____	_____	Starship Weaponry Technology	_____
Environmental Suit Operation	<u>39</u>	* Planetary Sciences	<u>GEOLOGY 20</u>	Streetwise	_____
* Gaming	<u>BACKGAMMON 10</u>	_____	_____	Transporter Operation Procedure	<u>24</u>
Instruction	<u>20</u>	_____	_____	Transporter Systems Technology	_____
* Language	<u>5</u>	_____	_____	* Trivia	_____
_____	_____	* Planetary Survival	_____	_____	_____
_____	_____	<u>COOL TEMPERATE 10</u>	_____	_____	_____
Leadership	<u>34</u>	Security Procedures	_____	_____	_____
* Life Sciences	<u>ZOOLOGY 13</u>	Shuttlecraft Pilot	<u>17</u>	* Vehicle Operation	_____
_____	_____	Shuttlecraft Syst. Technology	_____	Warp Drive Technology	_____
_____	_____	Small Equipment Syst. Operation	<u>17</u>	Zero-G Operations	<u>38</u>
Life Support Syst. Technology	_____	Small Equip. Syst. Technology	_____		

AP
18
17
16
15
14
13
12
11
10
9
8
7
6
5
4
3
2
1

# Training Player Characters

The process of generating the list of skills that a character possesses is complex, but it does give an idea of what the character lived through before the game actually begins. Not only will this section explain how to generate these skills, but it also will provide some insight into the education and development of a Romulan child.

As with characters created using the STRPG2 rules, Romulan characters gain skills in a step-by-step fashion. This is described in this section. A shortened form, containing only the tables necessary to create Romulan characters quickly, is provided as well. This form should not be used without first following the procedure given below.

The skill list is identical to that in STRPG2, as are the skill descriptions. As with those rules, a skill preceded by a star (\*) requires further definition. A specific specialty or class must be chosen as well. As Skill Ratings are created, they should be recorded in pencil on the *Romulan Character Data Record* in the places provided. When a Skill Rating is increased, the old value should be replaced by the new one.

## THE EDUCATION

Because Romulans attend only one school from the age of 5 until the age of 20, there is no exact equivalent of Pre-Academy Skills for Romulan characters. Instead, these skills are part of those gained through the education process.

### THE BEGINNING

In the first 5 years of The Education, Romulan children learn the basics of Romulan life and the general knowledge necessary to survive in the tough life of Romulan civilization. During this 5-year period, fewer skills are learned than in later periods, and the Skill Ratings in these are only 5.

#### Core Curriculum

Each Romulan child receives training in the following skills, gaining the given Skill Ratings automatically:

Computer Operation	5
* Language	5
Marksmanship, Modern	5
Personal Combat, Armed (Dueling Stick)	5
Unarmed	5
Romulan Culture/History	5
Small Equipment Systems Operation	5
* Sports	5



### Beginning Electives

During this period of time, the character also gains 2 skills chosen from the Beginning Electives list below. These skills may not duplicate the skills above, but a different specialty may be gained in one of the broad categories. The Skill Rating in each beginning elective is 5 points.

#### Communication Systems Operation

- \* Language
- \* Leadership
- \* Life Sciences
- \* Marksmanship, Archaic Weapons
- \* Personal Combat, Armed
- \* Physical Sciences
- \* Planetary Sciences
- \* Planetary Survival
- \* Sports
- \* Social Sciences
- \* Space Sciences

*In our example, because Tevus wishes to become a starship officer some day, she chooses Space Sciences (Astronomy) as a beginning elective. She also finds that the rest of the children in her school tend to follow her lead, and she learns the skill of Leadership. The Skill Ratings in each of these will be 5 points.*

### THE BROADENING

During the second 5-year period, from age 10 to age 15, the child will begin to learn the important skills involved in his specialty. Four main specialties are possible, each having several sub-specialties. The sub-specialty for the character should be chosen at this time from the list below.

#### FIELDS OF SPECIALIZATION FOR ROMULAN CHARACTERS

##### Starship Operations

- Helm/Navigation
- Communications
- Weapon Systems

##### Starship Support

- Propulsion And Power
- Support Systems
- Small Equipment

##### Sciences

- Computer Science
- Medicine
- Specific Field

##### Military Operations

- Security
- Ground Forces

##### Administration

- Business
- Law
- Diplomacy

Many of the skills learned in this period are associated with the operation or function of a starship. The Skill Ratings given in the lists below are due to training in background, theory, history, and simulation. Though a 15-year-old Romulan Navigation specialist could possibly control a starship under careful supervision, Skill Rolls would be required for any other use.

## Core Curriculum Specialty

### STARSHIP OPERATIONS SPECIALTIES

#### HELM/NAVIGATION

Deflector Shield Operation	10
Small Equipment Systems Operation	5
Space Sciences, Astrogation	20
Starship Combat Strategy/Tactics	10
Starship Helm Operations	20
Starship Sensors	10

#### COMMUNICATIONS

Communication Systems Operation	20
Computer Operation	10
Damage Control Procedures	10
Small Equipment Systems Operation	5
* Language	30 total, Used in any way

#### WEAPON SYSTEMS

Cloaking Procedures	10
Computer Operation	10
Small Equipment Systems Operation	5
Starship Combat Strategy/Tactics	20
Starship Sensors	10
Starship Weaponry Operation	20

### STARSHIP SUPPORT SPECIALTIES

#### PROPULSION AND POWER

Computer Operation	10
Mechanical Engineering	10
Small Equipment Systems Operation	5
Space Sciences, Astronautics	20
Shuttlecraft Technology	10
Warp Drive Technology	20

#### SUPPORT SYSTEMS

Cloaking Device Technology	10
Computer Operation	10
Computer Technology	10
Deflector Shield Technology	10
Life Support Systems Technology	10
Small Equipment Systems Operation	5
Starship Weaponry Technology	10
Transporter Systems Technology	10

#### SMALL EQUIPMENT

Computer Operations	10
Electronics Technology	20
Personal Weapons Technology	10
Small Equipment Systems Operation	5
Small Equipment Technology	20
Shuttlecraft Technology	10

### SCIENCE SPECIALTIES

#### COMPUTER SCIENCES

Computer Operation	10
Computer Technology	20
Electronics Technology	10
Physical Science, Computer Science	20
Small Equipment Systems Operation	5
Starship Sensors	10

#### MEDICAL SCIENCES

Computer Operation	10
* Life Sciences	three at 10
* Medical Sciences	
General Medicine, Romulan	20
Psychology, Romulan	10
Small Equipment Systems Operation	5

#### SPECIFIC SCIENCES

Computer Operation	10
* Science (Except Medical)	
Major	one at 20
Minor	two at 10
Small Equipment Systems Operation	5
Starship Sensors	10

### MILITARY OPERATIONS SPECIALITES

#### SECURITY

Marksmanship, Modern	10
Personal Combat, Unarmed	10
Personal Weapons Technology	10
Security Procedures	20
Small Equipment Systems Operation	5
Small Unit Tactics	10
Social Science: Romulan Law	10

#### GROUND FORCES

Marksmanship, Modern	20
* Personal Combat, Armed	10
Personal Combat, Unarmed	10
Personal Weapons Technology	10
Small Equipment Systems Operation	5
Small Unit Tactics	20

### ADMINISTRATION SPECIALTIES

#### BUSINESS ADMINISTRATION

Administration	20
Computer Operation	10
Leadership	10
Negotiation/Diplomacy	10
Small Equipment Systems Operation	5
Trade And Commerce	20

#### LAW

Administration	10
Leadership	10
Negotiation/Diplomacy	20
Social Sciences	
Romulan Culture/History	10
Romulan Law	20
Small Equipment Systems Operation	5

#### DIPLOMACY

Administration	10
* Language	
Major	one at 20
Minor	two at 10
Negotiation/Diplomacy	20
Small Equipment Systems Operation	5

*In our example, Tevus will become a Starship Operations Specialist concentrating on Helm and Navigation. She records the Skill Ratings listed, increasing her ratings in Computer Operation and Small Equipment Systems Operation.*

#### Outside Electives

The character may gain skill in 2 electives of his choice. These skills may not be among those already known. The Skill Rating in each is 10 points.

*Tevus chooses to gain the physical sciences skill of Physics and the space sciences skill of Astrophysics. She adds these skills to her list, each with the Skill Rating of 10.*

#### Advanced Training

The character also may increase his Skill Rating in 3 skills of his choosing. These must be skills that have been acquired previously. For each skill, the Skill Rating increases by 1D10 points.

*In our example, Tevus decides to better her skills in Marksmanship, Modern (9); Personal Combat, Unarmed (6), and Personal Combat, Dueling Stick (8).*

## THE COMING TOGETHER OF KNOWLEDGE

The last 5-year period of the student's education, from age 15 to age 20, combines elements of both other periods. He also will gain skill in social interaction lacking from early training. The core curriculum of this period expands his base of knowledge and his advanced training gives him the experience needed to perform his job.

### Core Curriculum

The training is the same for each character, regardless of specialty. Ratings in the following skills are increased automatically, as shown.

#### COMING TOGETHER CORE CURRICULUM

##### Starship Skills

Damage Control Procedures	10
Environmental Suit Operation	10
Zero-G Operations	10

##### Socialization Skills

Administration	10
* Gaming	10
Instruction	10
Leadership	10
Negotiation/Diplomacy	10
Social Sciences	
Romulan Culture/History	10
Romulan Law	10
* Sports	10

##### Combat Skills

Marksmanship, Modern	10
Personal Combat, Unarmed	10

*Tevus increases her Skill Ratings in Leadership, Romulan Culture/History, Gymnastics (Sports), Modern Marksmanship and Unarmed Personal Combat by 10 points each. She adds the other skills to her list, including the skill of Romulan gaming, by learning the Romulan equivalent of backgammon.*

### Advanced Training

**In Specialty:** The character receives extra training in his chosen specialty. Each character gets at least 10 chances to improve the skills, and even more if he is intelligent. The character gets 10 chances plus 1 for each 10 full points of INT score more than 50. For each chance, choose the skill to be improved; then roll 1 die to determine the increase in Skill Rating. A skill may be improved as many times as desired.

**Outside Specialty:** The character receives advanced training in skills of his choice outside his chosen field. The skills advanced are chosen from skills the character already knows, and each skill may be chosen more than once. A total of 10 skills may be improved; for each skill chosen, roll 1 die and add the points to the Skill Rating.

*As our example continues, Tevus' INT score is 64, and so she gets 11 chances to improve specialty skills (10 + 1 for the 14 points her INT score is greater than 50). She chooses to improve her ratings in Starship Combat Strategy/Tactics (5 + 8); Starship Helm Operation (5 + 3 + 6); Starship Sensors (4 + 9 + 4); and Deflector Shield Operation (9 + 3 + 7) for her 11 chances.*

*She also selects to improve her ratings in Environmental Suit Operations (2 + 9); Computer Operation (6); Physical Sciences, Physics (10); Personal Combat, Unarmed (7); Space Sciences, Astrogation (6); Space Sciences, Astronomy (9); Sports, Gymnastics (4); and Transporter Operation Procedure (6 + 10).*

*This completes her training in The Education.*

## THE GREAT DUTY

During this compulsory 5-year tour of service, the student holds the rank of Equatorium, the Navy's lowest rank. The student will be taught and tested for one year each in the Military Division, the Colonization Division, the Outpost Division, and the Exploration Division. The fifth and final year will be served in whichever division the student worked the best.

### OFFICER EFFICIENCY RATINGS (OER)

For each of the first 4 years, percentile dice are used to determine the student's Officer Efficiency Ratings, which tell how well the student performed his duties. There are no modifiers for LUC or INT. These 4 rolls will give the character separate Efficiency Ratings for each of the 4 divisions.

#### Bonus Points

If the player chooses, a bonus of 20 points may be added to the OER in one division, usually the division in which the character will serve. This modifier is strictly optional, and can be applied only once. If the modified roll is greater than 99, the OER should be set at 99.

### FIFTH YEAR TRAINING

The highest OER determines the division in which the student will serve his fifth year of service. To determine the OER for this year, roll percentile dice and add 20. If the total is greater than 99, make it 99.

*In our example, Tevus will end up serving in the Exploration Division, and so the 20-point modifier will be added to that division's roll. Thus, her Efficiency Ratings are:*

First Year: Military Division	42
Second Year: Colonization Division	39
Third Year: Outpost Division	04
Fourth Year: Exploration Division	99 (97 + 20 = 117, set back to 99)

*This shows us that she apparently excelled in the Exploration Division, so her last year of The Service will also be in the Exploration Division.*

Fifth Year: Exploration Division	94 (74 + 20 = 94)
----------------------------------	-------------------

### SKILL IMPROVEMENT

The Great Duty, a form of on-the-job training, gives the Equatorium a chance to improve skills in his specialty, in other areas, and in areas specific to each year of duty.

#### Specialty Skills

For each of the five years, the Equatorium has 3 chances to improve the skills in his specialty. This is a total of 15 chances, and so each skill will be improved more than once. For each chance, choose the skill, roll 1 die, and add the roll to the Skill Rating. The skills chosen must be those the character chose in The Broadening. This means that Sciences Specialists may only improve the major and the minors chosen at that time.

*Tevus chooses to improve Deflector Shield Operation (5 + 3 + 4 + 1), Astrogation (4 + 5 + 7 + 4), Starship Combat Strategy/Tactics (1), Starship Helm Operation (7 + 3 + 7 + 4 + 6) and Starship Sensors (5 + 5). She adds these rolls to the ratings she already had.*

## Other Skills

For each of the 5 years, the Equatorium has the chance to improve any 3 skills outside his specialty. For each of the 15 skills to be improved over the 5-year term, choose the skill, roll 1 die, and add the roll to the Skill Rating. No specialty skills may be improved, but any other skill may be chosen more than once.

*For the skills outside her specialty that Tevus will improve, she chooses Zoology (5 + 3), Personal Combat With Dueling Stick (5 + 8 + 6 + 3 + 7), Transporter Operation Procedures (4 + 4), Small Equipment Systems Operation (7), Modern Marksmanship (7), Unarmed Personal Combat (5), Physics (7), and Shuttlecraft Pilot (8 + 9). For each of these, she records the new Skill Rating.*

## Duty Skills

For each of the five years, the Equatorium will improve the skills used in carrying out his duties in that division, as shown from the lists below. The Skill Rating is improved by the total points shown. When the character has a chance to improve a skill marked with a star (\*), any specialty within that skill may be chosen.

### SKILLS IMPROVED IN THE GREAT DUTY

#### For One Year In The Military Division

Marksmanship, Modern	10
Personal Combat, Unarmed	10

#### For One Year In The Colonization Division

* Planetary Sciences	one at 10
* Planetary Survival	one at 10

#### For One Year In Outpost Division

Damage Control Procedures	10
Environmental Suit Operation	10

#### For One Year In Exploration Division

* Planetary OR Space Sciences	one at 10
Zero-G Operations	10

*While serving in the Colonization Division, Tevus is able to increase her Skill Ratings in the planetary science of Geology and in Cool Temperate Planetary Survival. For her two years in the Exploration Division, she is able to increase her Skill Ratings in the space science of Astronomy and the planetary science of Geology. She increases the ratings as shown.*

## ADVANCED OFFICER'S TRAINING

Should a character decide to remain in military service, he will be sent to Advanced Officer's Training. This 1-year course prepares the character for a career as an officer, teaching leadership, instruction skills, and administrative skills. Other skills depend on the character's chosen specialty. At the end of the year, the character is automatically promoted to the rank of Secundam.

### CORE CURRICULUM

The following skills are taught to all officers, adding the points shown to the ratings in these skills.

#### ADVANCED OFFICER TRAINING CORE SKILLS

Administration	10
Instruction	10
Leadership	10

### SPECIALTY SKILLS

The skills taught to each officer depend on his specialty. For some specialties, it does not matter what sub-specialty was studied originally, and the training is the same. For others, however, the training is markedly different. Specialists in law, medical science, and other sciences have a longer training period than do other officers. Because of the complex subjects they must study, they must spend an extra year at Advanced Officer's Training.

## ADVANCED OFFICER TRAINING SPECIALTY SKILLS

#### For All Starship Operations Specialists:

Starship Combat Strategy/Tactics	20
----------------------------------	----

#### For All Starship Support Specialists:

Space Sciences, Astronautics	20
------------------------------	----

#### For Medical Science Specialists:

General Medicine, Romulan	20
Pathology	20
Psychology, Romulan	10
Surgery	20

#### For All Science Specialists Except Medical:

Computer Operation	10
Starship Sensors	20
* Physical Sciences	one at 10
* Life Sciences	one at 10
* Planetary Sciences	one at 10
* Space Sciences	one at 10

#### For All Military Operations Specialists:

Small Unit Tactics	20
--------------------	----

#### For All Law Specialists:

Administration	10
Computer Operation	10
Negotiation/Diplomacy	10
Social Sciences	
Romulan History/Culture	20
Romulan Law	20

#### For All Administrative Specialists Except Law:

Administration	10
Computer Operation	10

## SERVICE EXPERIENCE

After a citizen leaves Advanced Officer's Training, he is ready to enter active service, and the character is almost ready to be used. The character may have one or more assignments, depending upon his rank. Service tours in the Romulan Navy generally last longer than those in Star Fleet.

### NUMBER OF TOURS SERVED

To determine the number of tours served, roll 1D10 and divide by 3, rounding up. Modify the result by the following table to find the total number of tours served.

#### MODIFIERS TO NUMBER OF TOURS SERVED

##### For Attribute Scores

INT 60 +	- 1 tour
LUC 30 or less	+ 1 tour

##### For Destined Rank

Secundam	No Modifier
Trinam	+ 1 tour
Centurion	+ 2 tours
Sub-Commander	+ 3 tours
Commander	+ 3 tours

*After her 1-year Advanced Officer's Training, in which she gains 20 points in Starship Combat Strategy/Tactics, our friend Tevus must now find out how many tours of service she will have already completed. Her roll is 5, which is divided by 3 and rounded up to become 2 tours. Her INT score modifies this to 1 tour, and her destined rank modifies it to 3 tours.*



## TOUR ASSIGNMENT

Just like service in Star Fleet, a Romulan officer's performance rating on a tour affects his future tour assignments. To a Romulan, all areas of service are equal, though some may be more desirable than others. Nevertheless, an officer's abilities must not be wasted, and so where he serves his tours will be determined partly by his Officer Efficiency Ratings. His first term will always be where he excelled in The Great Duty.

### First Tour

An officer's first tour after Advanced Officer's Training will be in the division where he served his fifth year of training as an Equatorium.

### Officer Efficiency Ratings

Roll percentile dice and add 10 to determine the OER. Experience, intelligence, and luck help an officer be efficient, and so the original roll must be modified as shown below. For an OER of greater than 99, make the rating 99.

#### Modifiers To OER Rolls

##### For Experience:

Per Tour In Division + 5

##### For Intelligence:

INT Score 70+ + 10

INT Score 60 - 69 + 5

INT Score 40 or Less - 5

##### For Luck:

LUC Score 60+ + 10

LUC Score 50 - 59 + 5

LUC Score 30 or Less - 5

### Additional Tours

If an officer continues to do well in his posting as measured by his Officer Efficiency Ratings (OERs), he will remain there. If, however, his OER shows that he is not performing as expected, he will be transferred at random to another division, hoping he will find his niche. The divisions are not of equal size, and so the chance that he will be posted to the Military Division is the greatest.

To find out if the officer moves to another division, look at the OER for his last term. If the OER is 50 or greater, there will be no change. If it is less than 50, then the next tour will occur in another division, chosen at random. To determine the next division, roll percentile dice and add or subtract the LUC modifier, if any. Compare the result to the table of Additional Tour Assignments shown below. Reroll if the posting remains the same.

#### Additional Tour Assignments

##### Die Roll Posting

01 to 15 Exploration Division

16 to 35 Outpost Division

36 to 60 Colonization Division

61 to 00 Military Division

#### Luck Modifiers To Tour Assignment Rolls

LUC 60+ - 10

LUC 50 - 59 - 5

LUC 30 or less + 5

*Because Tevus' INT score is 64 and her LUC score is 64, she receives a modifier of +20 to each OER roll. In addition, her first term after her Advanced Officer's Training will be in the Exploration Division, where she served two terms previously as an Equatorium. Thus, 40 will be added to her percentile dice roll. This roll is a 23, giving her an OER of 63 (23 + 40 = 63). Her next term will be served in the Exploration Division as well.*

*Her second OER roll is modified by +45 because of her additional successful tour. Her roll is 05, giving her an OER of 50, just barely enough to remain in Exploration! Evidently she had a superior with whom she did not get along.*

*Her final tour is served in the Exploration Division, with a total modifier of +50. Her roll of 71 gives her an OER of 99 (71 + 50 = 121, set at 99), showing she more than made up for her previous OER.*

## TOUR LENGTH

Romulan tours generally last from 1 to 10 years to increase the feeling of comradery between people stationed together. The length also reflects the more regimented Romulan lifestyle.

Tour length is determined by rolling 1D10 to tell how many years were spent in the tour.

*In our example, Tevus spent 8 years in her first tour, 5 years in her second, and 7 years in her third.*

## TOUR SKILL ADVANCEMENT

For every 2 years served, the character may advance the rating in 1 skill of his or her choice. A character's LUC and INT may also add to the number of skills the character may improve, as indicated in the table below. A skill may be improved more than once, but the skills improved must be among those that the character already has. The ratings for skills improved are increased by 1D10 points.

#### Skill Advancement Due To Service

##### For Tour Length

Per two years of tour length 1 roll

##### For Attributes

INT 70+ 2 rolls

INT 60 - 69 1 roll

LUC 60+ 1 roll

*In our example, Tevus served a total of 20 years. Dividing that by 2, she may improve 10 skills. Her INT score of 64 and her LUC score of 64 increase this to 12. She will improve her Skill Ratings in Leadership (9); Environmental Suit Operations (8); Computer Operation (8); Marksmanship, Modern (8 + 2); Personal Combat, Unarmed (4); Small Equipment Systems Operation (10); Social Sciences, Romulan Culture/History (4); Starship Combat Strategy/Tactics (8); Starship Helm Operation (3); Starship Sensors (10); and Zero-G Operations (8).*

## COMBAT STATISTICS

Several combat statistics must now be generated in order to use the character in combat. These numbers tell how many combat actions are possible for a character in a given turn, how easy it is for the character to hit his or her target with modern weaponry, how easy it is to hit one's opponent in hand-to-hand combat and how much damage is done with each punch. These topics are covered in more depth in the **Tactical Movement And Combat** section in the STRPG2 rules.

### ACTION POINTS (AP)

As in creating Star Fleet characters with the STRPG2 rules, to find a Romulan character's AP, divide his DEX score by 10, round down, and add 4. Circle this number in the Action Point Track on the right hand side of the *Romulan Character Data Record*.

*In our example, Tevus has a DEX score of 75, and so she has 11 AP (75 ÷ 10 = 7.5, rounded down to 7; 7 + 4 = 11).*

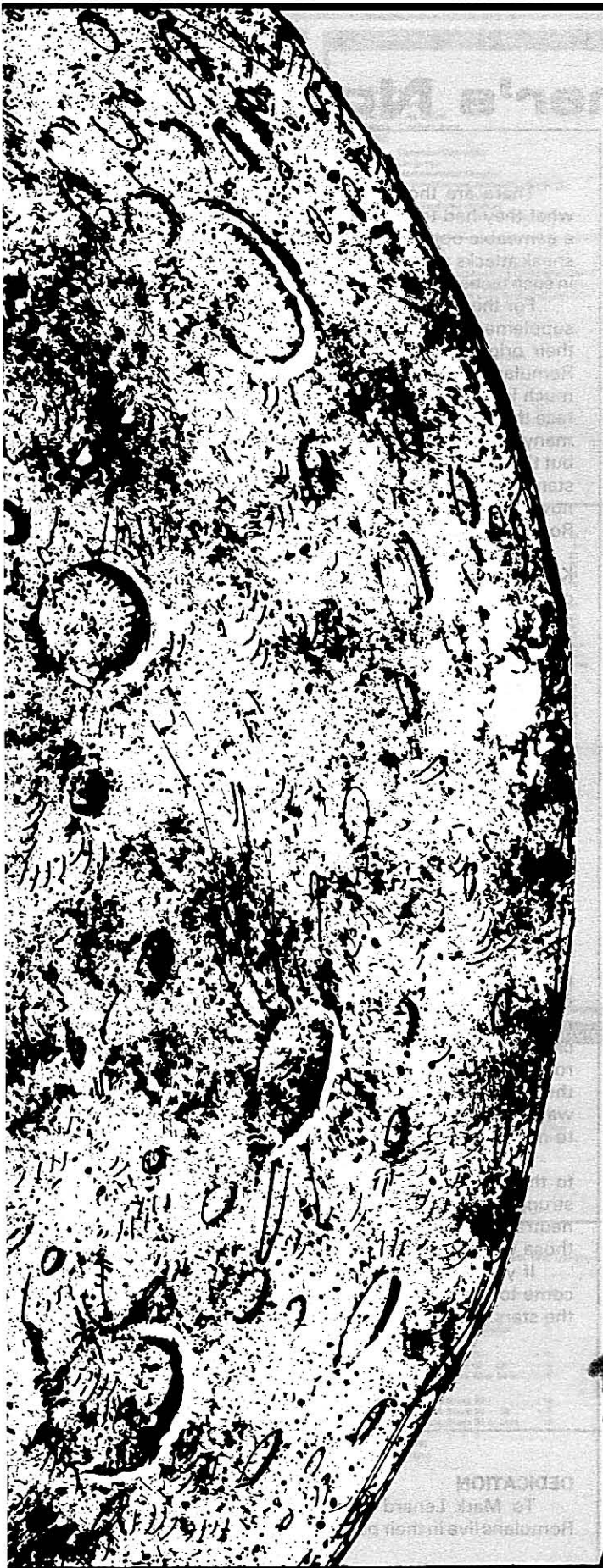

## BASE TO-HIT NUMBERS

At least 3 Base To-Hit Numbers must be calculated for each Romulan character. One of these determines the chance to hit with a modern weapon, another determines the chance to hit with a dueling stick, and the third determines the chance to hit in unarmed combat.

These Base To-Hit Numbers are calculated using the method from the STRPG2 rules. The character's DEX score is averaged with the appropriate Skill Rating and the result is rounded up. For the *To-Hit, Modern* base, use the rating in *Modern Marksmanship*. For the *To-Hit, Dueling Stick* base, use the rating in *Armed Personal Combat, Dueling Stick*. For the *To-Hit, Hand-To-Hand* base, use the rating in *Unarmed Personal Combat*. The Base To-Hit Numbers should be recorded on the *Romulan Character Data Record* in the spaces indicated.

*Tevus has a DEX Score of 75 and a Skill Rating in Modern Marksmanship of 51. Her Base To-Hit, Modern, is 63. (75 + 51 = 126; 126 ÷ 2 = 63). Her Base To-Hit, Dueling Stick, is 59, and her Base To-Hit, Unarmed, is 61.*

## BARE-HAND DAMAGE

The damage that a character can do in unarmed (HTH) personal combat is determined as in the STRPG2 rules, but the tables are reproduced here for convenience. First find the damage the character can give due to his STR score, and then add the bonus for his Skill Rating in *Unarmed Personal Combat*. Bare-hand damage should be recorded on the *Romulan Character Data Record* in the space provided.

### Bare-Hand Damage Due To Strength

STR Score	Damage
01 - 25	1D10 - 3
26 - 50	1D10
51 - 75	1D10 + 3
76 - 100	2D10
101 - 125	2D10 + 3
126 - 150	3D10
151 - 175	3D10 + 3
and so on.	

## MODIFIER FOR SKILL

Add 1 damage point for each 10 full points in *Unarmed Personal Combat*.

*In our example, Tevus has a STR score of 66 and a Skill Rating of 52 in Unarmed Personal Combat. Her base damage is 1D10 + 3 damage points. Her Skill Rating of 52 gives her a modifier of 5 more points. This gives her a final Bare-Hand Damage of 1D10 + 8.*

## CHARACTER AGE

All Romulans enter The Service at the age of 20 and finish it at the age of 25. This is the base age for all characters. Advanced Officer's Training takes one year, with the first tour of service following.

To find the character's age, total the number of years from all tours of service, add 1 year for Advanced Officer's Training, and add this to 25.

*Tevus served 3 tours totalling 21 years. This means that she is 46. (25 + 1 year for Advanced Officer's Training + 21 = 46). This is well below the critical age for Romulans.*

# Game Designer's Notes

It has often been said that some of fiction's most interesting characters have been villains. *STAR TREK's* villains always were as interesting as the heroes, but the Romulans transcended even that level. For many fans, the Romulans weren't the villains at all. They were misunderstood, perhaps, and most certainly alien in their outlook and priorities, but not really "evil."

It's understandable how this feeling came about. Our first view of the Romulans, in the TV episode *Balance of Terror* introduced a Romulan commander, played superbly by Mark Lenard. The commander was a dedicated, selfless soldier whose nobility, personal honor, and devotion to duty made him an admirable adversary for Captain Kirk. This is the way some fans looked at the Romulans overall – it was a shame that this fine, noble race had goals and priorities that made conflict with the Federation inevitable. Little was said about the early war with the Romulans that led to the establishment of the Neutral Zone, the feeling was left that it was a great tragedy that the first contact between Humans and Romulans had not been peaceful.

Later, in the TV episode *The Enterprise Incident*, Joanne Linville showed *STAR TREK* viewers that Romulan women were as strong, capable, and dedicated as the men. She showed that Romulan society took full advantage of those qualities by granting men and women an equal chance for command and advancement in the military. Furthermore, this episode showed that the Vulcanoid heritage of the Romulans took a different turn than that of their cousins. Though the Romulans exhibited a Vulcan-like stoicism in their attendance to duty, privately they had maintained their contact with their emotions and feelings. Romulans *feel* with the same intensity as that with which they fight.

Given these two outstanding portrayals, it was no wonder that many fans became fond of the Romulans and admired them in a way that they never admired the Klingons. The Romulans were unlike Humans (and so us) in many ways, but they exhibited admirable traits that made them seem more Human nonetheless. Or perhaps fans saw in them qualities that they wished more Humans would exhibit.

The Romulans have another, more ominous side, especially for gamers who play Federation characters. They are the unseen enemy, who strikes without warning and without pity. If the Klingons are the "Mongol hordes," the Romulans are the "Ninja" – silent, mysterious, and deadly. Humans and Romulans fought a lengthy, bloody war, with incredible numbers of casualties, yet no Human ever saw a Romulan face during the entire conflict. The Romulans struck quickly, with unpredictable hit-and-run tactics. They never took prisoners nor left survivors, and no Romulan could ever be captured, dead or alive. They were known only as cold voices over subspace radio, offering no compromise, accepting or giving no quarter. Is it any wonder that Federation citizens learned quickly to fear the sleek ships painted like gigantic birds of death? Can those who lost family and friends to these Romulan tactics, or those who lived with the constant fear of Romulan raids be so detached and objective?

There are those who say that the Romulans did only what they had to do because of their limited resources. But a gameable option certainly lies in exploiting the Romulans' sneak attacks and warfare of terror. Can a race that specializes in such tactics be as admirable as some would like to believe?

For these reasons, there has been a great demand for a supplement that would tell more about this noble race and their origins, and that would allow players to role-play as Romulan characters if they chose. Unfortunately, there was much less to go on in developing the Romulans as a player-race than there was for developing the Klingons. There were many episodes featuring Klingons and *The Final Reflection*, but there were only two episodes that showed anything substantial about the Romulan race. Unfortunately, the many novels, pieces of fan fiction, and other material about the Romulans were contradictory on almost every point.

We took the most prudent course and prepared the Klingon supplement first. Then, with that experience under our belts, and bolstered by the success enjoyed by that supplement, we tackled the task of taking what little has been revealed about the Romulans and expanding on it. This supplement presents them as a fully-developed civilization.

Because much of the material herein had to be developed from scratch, we know we are not going to please everyone. Fans take the Romulans very seriously, and each fan has his own idea of what their culture is like. Nonetheless, we hope we have prepared a balanced, reasonable look at a Romulan race that is gameable, yet consistent with the portrait painted by actors Lenard and Linville, and by writers Paul Schneider and D.C. Fontana (who wrote the two *STAR TREK* episodes which tell the most about the Romulan Way). More importantly, we hope we have managed to present a Romulan race that *STAR TREK* devotees will find as admirable and fascinating, or cold and mysterious, as they expected.

The Romulan Way is not an easy road, and those who tread it must be strong. It is not always fair, but the gods do not promise fairness. The gods have placed the Romulan race on a poor world with many hardships. They have decreed that this race must prove their worth by building a road to the stars. This the Romulans have set out to do, and they will tolerate no obstacles. If someone stands in their way, he must fall, or every Romulan must fall in the attempt to move him.

But if a person can find the courage to shape his destiny to theirs and move with them on their seemingly-endless struggle, he can be worthy of the gods' favor. There are no neutrals and none who can "wait and see." There are only those who stand in the way and the Romulans.

If you would join them, here is your opportunity. Welcome to the Romulan Way. If you would block their road to the stars... be warned.

David F. Tepool  
Guy W. McLimore, Jr.  
Greg K. Poehlein

## DEDICATION

To Mark Lenard and Joanne Linville, who made the Romulans live in their portrayals of the Star Empire's finest.

### ATTRIBUTES

**INITIAL ROLL**  
Dice Roll: As Below  
Modifiers: As Below

**INITIAL DICE ROLLS**

Attribute	Dice Roll
STR	40 - 3D10
END	40 - 3D10
INT	40 - 3D10
DEX	40 - 3D10
CHA	40 - 3D10
LUC	D100
PSI	D100

**RACIAL MODIFIERS TO ATTRIBUTES**

STR	END	INT	DEX	CHA	LUC	PSI
-10	+10	none	-5	none	-10	-20

### BONUS POINTS

Dice Roll: D100 + 2, round down  
Choice: Any but PSI  
Restrictions:  
No more than 30 can be added to one attribute score.  
No attribute score may be more than 99.

### ENDURANCE STATISTICS

MAX OP END: Equal to END  
CURR OP END: Equal to MAX OP END  
Wound Heal Rate: END - 20, round down  
Fatigue Heal Rate: END - 10, round down  
INACT SAVE: 15  
UNC THRESH: 5

### THE GREAT DUTY

#### OFFICER EFFICIENCY RATINGS (OER)

Dice Roll: D100 roll for each year of training.  
Bonus Points: Optional 20 points added to 1 roll.  
Restriction: OER may not be more than 99.

#### FIFTH-YEAR TRAINING

Division: Division with highest OER.  
OER Dice Roll: D100 + 20  
Restriction: OER may not be more than 99.

#### SKILL IMPROVEMENT

In Specialty  
Number: 15  
Rating: 1D10 increase  
Choice: Specialty skills from The Broadening only.

Outside Specialty  
Number: 15  
Rating: 1D10 increase.  
Choice: Any skills already known except specialty skills.

Because Of Duty  
Number: As below.  
Rating: As below.

Skills	Rating
For One Year In The Military Division	
Marksmanship, Modern	10
Personal Combat, Unarmed	10
For One Year In The Colonization Division	
Planetary Sciences	one at 10
Planetary Survival	one at 10
For One Year In Outpost Division	
Damage Control Procedures	10
Environmental Suit Operation	10
For One Year In Exploration Division	
Planetary OR Space Sciences	one at 10
Zero-G Operations	10

### SKILLS FROM THE EDUCATION

**THE BEGINNING**  
Core Curriculum  
Number: As below.  
Rating: 5 points each.  
Skills:  
  Computer Operation  
  Language  
  Marksmanship, Modern  
  Personal Combat, Armed (Dueling Stick)  
  Romulan Culture History  
  Small Equipment Systems Operation  
  Sports

Beginning Electives  
Number: 2  
Rating: 5 points each.  
Choice:  
  Communication Systems Operation  
  Language  
  Leadership  
  Life Sciences  
  Marksmanship, Archaic Weapons  
  Personal Combat, Armed  
  Physical Sciences  
  Planetary Survival  
  Sports  
  Social Sciences  
  Space Sciences

**THE BROADENING**  
Curriculum Skills  
Number: As below, depending on specialty choice.  
Rating: As below, depending on specialty choice.  
Choice: Core Curriculum skills from one specialty.

Outside Electives  
Number: 2  
Rating: 10 points each.  
Choice: Any skill not already known.

Advanced Training  
Number: 3  
Rating: 1D10 increase.  
Choice: Skills previously acquired.

STARSHIP OPERATIONS SPECIALTIES	
HELM/NAVIGATION	
Deflector Shield Operation	10
Small Equipment Systems Operation	5
Space Sciences, Astrology	20
Starship Combat Strategy/Tactics	10
Starship Helm Operations	20
Starship Sensors	10
COMMUNICATIONS	
Communication Systems Operation	20
Computer Operation	10
Damage Control Procedures	10
Small Equipment Systems Operation	5
Language	30 total, used in any way
WEAPON SYSTEMS	
Clothing Procedures	10
Computer Operation	10
Small Equipment Systems Operation	5
Starship Combat Strategy/Tactics	20
Starship Sensors	10
Starship Weapons Operation	20

SCIENCE SPECIALTIES	
COMPUTER SCIENCES	
Computer Operation	10
Computer Technology	20
Electronic Technology	10
Physical Science, Computer Science	20
Small Equipment Systems Operation	5
Starship Sensors	10
MEDICAL SCIENCES	
Computer Operation	10
Life Sciences	three at 10
Medical Sciences	
General Medicine, Romulan	20
Psychology, Romulan	10
Small Equipment Systems Operation	5
SPECIAL SCIENCES	
Computer Operation	10
Science (Except Medical)	one at 20
Minor	two at 10
Small Equipment Systems Operation	5
Starship Sensors	10

**ADMINISTRATION SPECIALTIES**

BUSINESS ADMINISTRATION	
Administration	20
Computer Operation	10
Leadership	10
Negotiation Diplomacy	10
Small Equipment Systems Operation	5
Trade And Commerce	20
LAW	
Administration	10
Leadership	10
Negotiation Diplomacy	20
Social Sciences	10
Romulan Culture History	10
Romulan Law	20
Small Equipment Systems Operation	5
DIPLOMACY	
Administration	10
Language	
Major	one at 20
Minor	two at 10
Negotiation Diplomacy	20
Small Equipment Systems Operation	5

### THE COMING TOGETHER OF KNOWLEDGE

Core Curriculum  
Number: As below.  
Rating: 10 points each.  
Skills:  
  Starship Skills  
    Damage Control Procedures 10  
    Environmental Suit Operation 10  
    Zero-G Operations 10  
  Socialization Skills  
    Administration 10  
    Gaming 10  
    Instruction 10  
    Leadership 10  
    Negotiation Diplomacy 10  
    Social Sciences 10  
    Romulan Culture History 10  
    Romulan Law 10  
  Sports 10  
  Combat Skills  
    Marksmanship, Modern 10  
    Personal Combat Unarmed 10

Advanced Training, In Specialty  
Number: 10 plus 1 for each 10 full points of INT above 50.  
Rating: 1D10 increase.  
Choice: Specialty skills only.

Advanced Training, Outside Specialty  
Number: 10  
Rating: 1D10 increase.  
Choice: Skills already known outside specialty.

### ADVANCED OFFICER'S TRAINING

**CORE CURRICULUM**  
Number: 3  
Rating: 10  
Skills:  
  Administration  
  Instruction  
  Leadership

**SPECIALTY SKILLS**  
Number: As below, depending on specialty.  
Rating: As below, depending on specialty.  
Skills:  
  For All Starship Operations Specialists: 20  
  Starship Combat Strategy/Tactics  
  For All Starship Support Specialists: 20  
  Space Sciences, Astrology  
  For Medical Science Specialists:  
  General Medicine, Romulan 20  
  Pathology 20  
  Psychology, Romulan 10  
  Surgery 20  
  For All Science Specialists Except Medical:  
  Computer Operation 20  
  Starship Sensors 20  
  Physical Sciences one at 10  
  Life Sciences one at 10  
  Planetary Sciences one at 10  
  Space Sciences one at 10  
  For All Military Operations Specialists: 20  
  Small Unit Tactics  
  For All Law Specialists:  
  Administration 10  
  Computer Operation 10  
  Negotiation Diplomacy 10  
  Social Sciences 10  
  Romulan History/Culture 20  
  Romulan Law 20  
  For All Administrative Specialists Except Law:  
  Administration 10  
  Computer Operation 10

### SERVICE EXPERIENCE

**NUMBER OF TOURS SERVED**  
Dice Roll: 1D10 - 3, round up.  
Modifiers: As below.

For Attribute Scores	
INT 60 -	- 1tour
LUC 30 or less	- 1tour

For Desired Rank	No Modifier
Secundam	
Trinam	- 1tour
Centurion	- 2tours
Sub-Commander	- 3tours
Commander	- 3tours

**TOUR ASSIGNMENT**  
First Tour  
Assignment: Same division as Fifth-Year Training.

Officer Efficiency Ratings  
Dice Roll: D100 - 10.  
Restriction: OER may not be more than 99.  
Modifiers: As below.

For Experience:	
Per Tour In Division	- 5
For Intelligence:	
INT Score 70 -	- 10
INT Score 60 - 69	- 5
INT Score 40 or Less	- 5
For Luck:	
LUC Score 60 -	- 10
LUC Score 50 - 59	- 5
LUC Score 30 or Less	- 5

**TOUR LENGTH**  
Die Roll: 1D10

**TOUR SKILL ADVANCEMENT**  
Number: 1 per 2 years served.  
Modifiers:  
  For Tour Length  
    Per two years of tour length 1 roll  
  For Attributes  
    INT 70 - 2rolls  
    INT 60-69 1roll  
    LUC 60 - 1roll  
Rating: 1D10 increase.  
Choice: Skills already known.

### COMBAT STATISTICS

**Action Points**  
(AP): DEX - 5, round down. - 4.  
Base To-Hit Numbers  
To-Hit Number: Skill Rating - OER - 2, round down.  
Skills:  
  Armed Personal Combat, Dueling Stick  
  Modern Marksmanship  
  Unarmed Personal Combat

**Base-Hand Damage**  
Base Number Due To STR Score:

STR Score	Damage
01 - 25	1D10 - 3
26 - 50	1D10
51 - 75	1D10 - 3
76 - 100	2D10 - 3
101 - 125	2D10 - 3
126 - 150	3D10
151 - 175	3D10 - 3
and so on.	

Modifier For Skill: 1 point for each 10 full points in Modifier For Skill: Unarmed Personal Combat.

### CHARACTER AGE

Base Age: 25  
Modifiers:  
  Advanced Officers Training - 1 year.  
  Additional Tours - As determined previously.

# Romulan Star Empire Character Data Record



Name: \_\_\_\_\_ Age: \_\_\_\_\_  
 Rank: \_\_\_\_\_ Sex: \_\_\_\_\_  
 Assignment: \_\_\_\_\_ Race: \_\_\_\_\_  
 Ship: \_\_\_\_\_  
 Position: \_\_\_\_\_

AP
18
17
16
15
14
13
12
11
10
9
8
7
6
5
4
3
2
1

STR	END	INT	DEX	CHA	LUC	PSI
INACT SAVE 15	UNC THRESH 5	MAX OP END	CURR OP END	TO-HIT, MOD	TO-HIT, HTH	TO-HIT, Dueling Stick
WOUND HEAL RATE	FATIGUE HEAL RATE	<i>Pre-Education</i> <i>The Education</i> <i>Service Year 1</i> <i>Service Year 2</i> <i>Service Year 3</i> <i>Service Year 4</i> <i>Service Year 5</i> <i>Adv. Off. Train.</i>			BARE-HAND DAMAGE _____	
					<i>Tour 1</i> <i>Tour 2</i> <i>Tour 3</i> <i>Tour 4</i> <i>Tour 5</i> <i>Tour 6</i> <i>Tour 7</i> <i>Tour 8</i> <i>Tour 9</i> <i>Tour 10</i>	

## Service Experience Charts

### Assignment:

- Exploration Division
- Outpost Division
- Colonization Division
- Military Division
- Tour Length (years)
- Efficiency Report (%)

5	15	1	1	1	1	1	1

## Skill List

- |                                     |                                       |  |
|-------------------------------------|---------------------------------------|--|
| Administration _____                | ★ Marksmanship, Archaic _____         | Small Unit Tactics _____                 |
| ★ Artistic Expression _____         | Marksmanship, Modern . . . _____      | ★ Social Sciences _____                  |
| Carousing . . . . . _____           | Mechanical Engineering . . . _____    | Romulan Culture/History _____            |
| Cloaking Device Technology . _____  | ★ Medical Sciences _____              | Romulan Law . . . . . _____              |
| Cloaking Procedures . . . . . _____ | General Medicine _____                | ★ Space Sciences _____                   |
| Commun. Systems Operation _____     | Negotiation/Diplomacy . . . . _____   | Astronomy . . . . . _____                |
| Commun. Systems Technology _____    | ★ Personal Combat, Armed _____        | ★ Sports _____                           |
| Computer Operation . . . . . _____  | Personal Combat, Unarmed . _____      | ★ Starship Combat Strategy/Tactics _____ |
| Computer Technology . . . . . _____ | Personal Weapons Technology _____     | Starship Helm Operation . . . _____      |
| Damage Control Procedures . _____   | ★ Physical Sciences _____             | Starship Sensors . . . . . _____         |
| Deflector Shield Operation . _____  | _____                                 | Starship Weaponry Operations . _____     |
| Deflector Shield Technology . _____ | _____                                 | Starship Weaponry Technology . _____     |
| Electronics Technology . . . _____  | _____                                 | Streetwise . . . . . _____               |
| Environmental Suit Operation _____  | _____                                 | Transporter Operation Procedure _____    |
| ★ Gaming _____                      | ★ Planetary Sciences _____            | Transporter Systems Technology _____     |
| Instruction . . . . . _____         | _____                                 | ★ Trivia _____                           |
| ★ Language _____                    | ★ Planetary Survival _____            | _____                                    |
| _____                               | _____                                 | _____                                    |
| Leadership . . . . . _____          | Security Procedures . . . . . _____   | _____                                    |
| ★ Life Sciences _____               | Shuttlecraft Pilot . . . . . _____    | ★ Vehicle Operation _____                |
| _____                               | Shuttlecraft Syst. Technology . _____ | Warp Drive Technology . . . . . _____    |
| _____                               | Small Equipment Syst. Operation _____ | Zero-G Operations . . . . . _____        |
| Life Support Syst. Technology _____ | Small Equip. Syst. Technology _____   |  |

# THE ROMULAN WAY: GAME OPERATIONS MANUAL



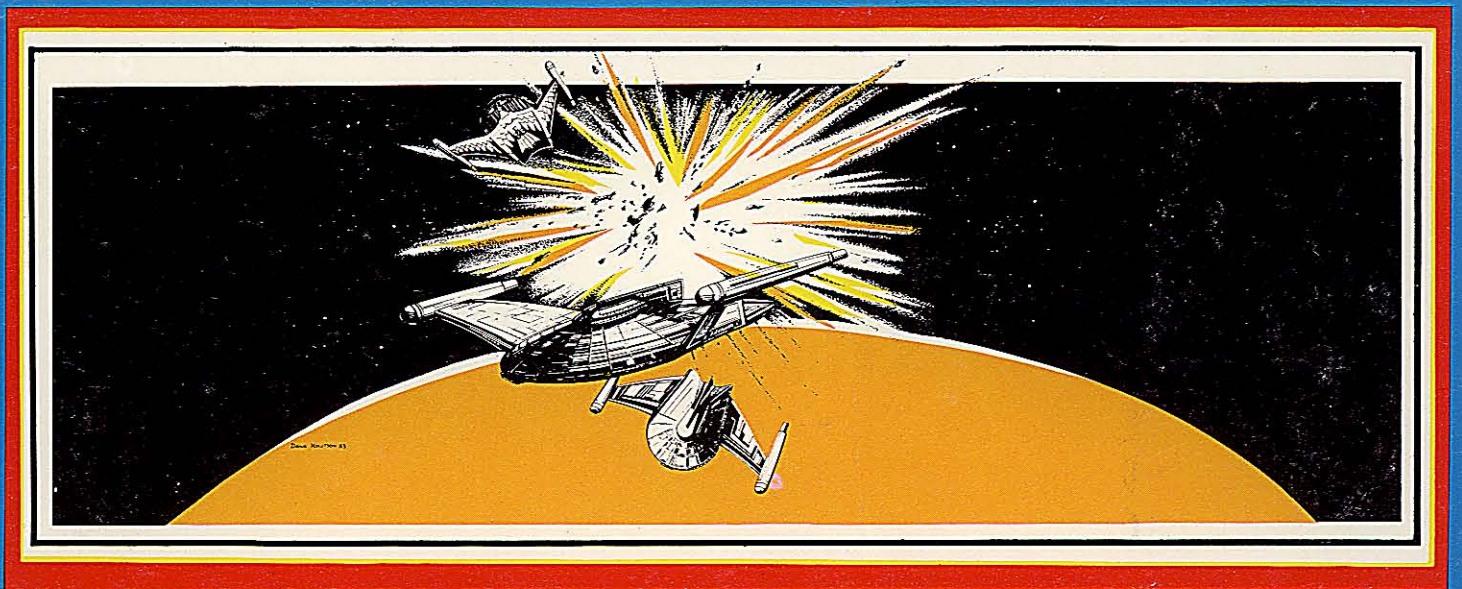

"I can appreciate the Romulan position."

"Among their own people, the Romulans exhibit loyalty and trust that even Humans would find exemplary... They are extremely single-minded in their view of their part of the universe, and willful enough to pursue that view no matter what the personal cost, to themselves or others."

"Still, the individual Romulan trusts, where trust is considered appropriate. A Romulan is not gentle, but he is honorable. He is not flexible, but he is reasonable. He is not sentimental, but he is vulnerable."

"It would be a mistake for a Star Fleet officer to think of the Romulans as a faceless enemy."

From *Seeing The Enemy's Face:*  
*A Reflection*  
By Cmdr. Spock of Vulcan

"Make no mistake, Officers of Star Fleet, the Romulan is indeed The Faceless Enemy."

"His motives cannot be understood, but his actions can be. He strikes like the terrorist of old, faceless behind his cloak. He sneaks into our midst, hidden by its artificial darkness and kills swiftly from the security of its hiding place..."

"...For the apologists who would have us love our enemies, treat them as though they were men of honor, I hold disbelief. For those who would point to the Romulans' personality traits that seem to be Human and exemplary, I hold pity. For those who would have us relax our vigilance while we attempt to understand our foes, and while our foes gather their resources and strength, I hold contempt..."

"...Understanding of the Romulan will come in time. Until then, they remain the enemy."

From *THE FACELESS ENEMY*

By Adm. Thaddeus I.  
Harden, Ret.,  
Neutral Zone Sector  
Commander

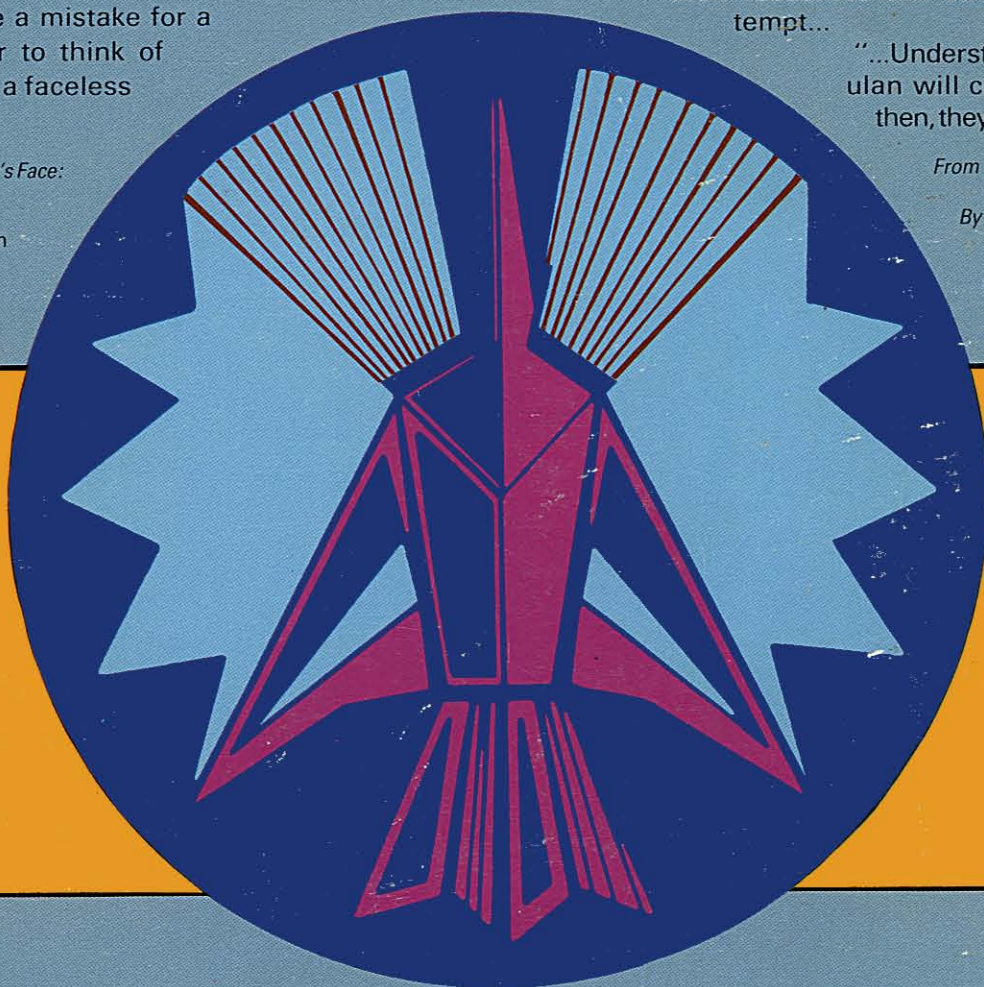

This rules-expansion for **STAR TREK: The Role Playing Game** provides hundreds of interesting facts about the Romulans, their personality, their history, and their religion. These books also tell about the Romulan Star Empire, the fascinating *Eridam Papers* that describe it, its government, its relations with the UFP and the Klingons, and its extent. And they tell about the Imperial Navy, its starships, its weapons and equipment, its organization, and its combat tactics.

Now you can find out about the Romulans. All you need is right here to add these mysterious aliens to **STAR TREK: The Role Playing Game**. Included are the following:

**The Romulans: Star Fleet Intelligence Sourcebook** – This 32-page book contains the latest intelligence on the Romulan people, the Romulan Star Empire, and the Romulan Imperial Navy. It includes up-to-date information that every Star Fleet officer should know if he is to serve anywhere near the Neutral Zone or the Triangle. Its many illustrations show uniforms and equipment, as well as starships, and Romulans engaged in various activities. It also contains short articles written by Commander Spock and others about the Romulans, as well as a short dictionary of common Romulan words.

**The Romulan Way: Game Operations Manual** – This 48-page book contains all the information necessary for designing and running games that feature the Romulans. It provides the information necessary to create and train Romulan characters; a Romulan Character Record also is provided. This information is complete and accurate, unlike the information possessed by Star Fleet Intelligence. With it, a gamemaster may add the Romulans to his game, keeping much of their mystery to his players.