

# STAR TREK

THE ROLE PLAYING GAME

2001  
TM

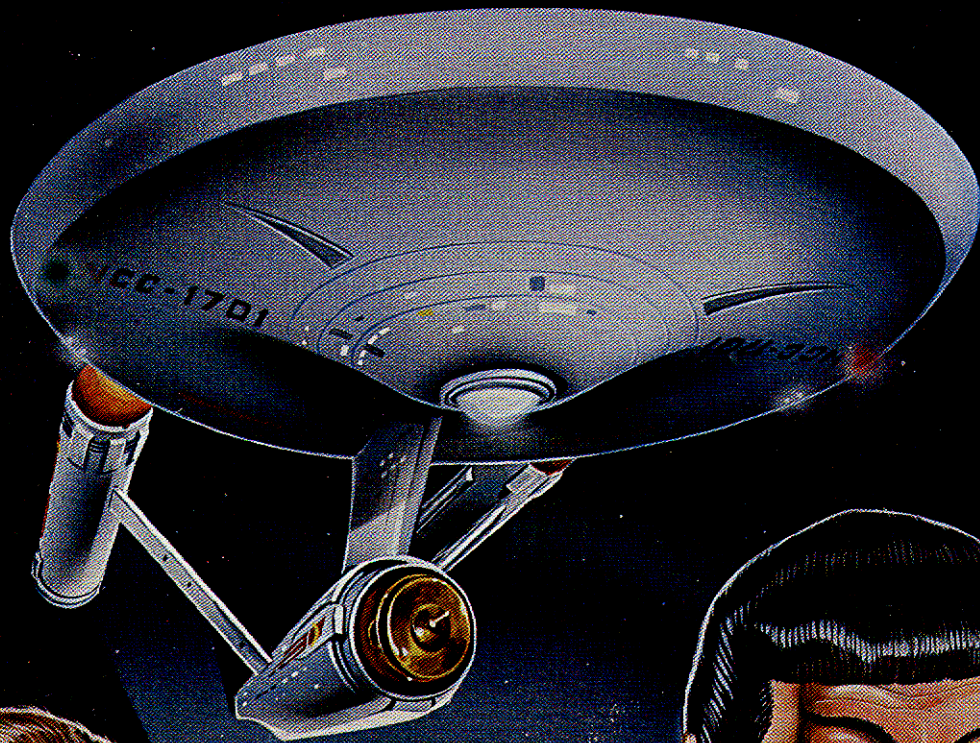

© 2001 CONNELL



# STAR TREK™

THE ROLE PLAYING GAME



W. CONNELL



*Space ... the final frontier.*

*These are the voyages of the Starship Enterprise.*

*Its five-year mission: to explore strange new  
worlds, to seek out new life and new civilizations  
to boldly go where no man has gone before...*





Game Design by Fantasimulations Associates

Designers: Guy W. McLimore, Jr.  
Greg K. Poehlein  
David F. Tepool

Additional Development: Jordan Weisman  
Ross Babcock

Original Artwork: Mitch O'Connell

Graphic Design: Jordan Weisman  
Mitch O'Connell

Editors: Ross Babcock  
Helena Szepe

Box Art: Mitch O'Connell

Ship Deck Plans: Dana Andrews  
Ross Babcock  
Mitch O'Connell  
Jordan Weisman

Copyright © 1966, 1983 Paramount Pictures Corporation

All Rights Reserved

Printed in the United States of America

STAR TREK<sup>TM</sup> is a trademark of Paramount Pictures Corporation

No part of this book or the contents of the basic game may be reproduced in any form, or by any means without permission in writing from the publisher.

STAR TREK<sup>TM</sup>: The Role-Playing Game is manufactured by FASA Corporation under exclusive license from Paramount Pictures Corporation, the trademark owner.

Manufactured by Patch Press, Inc.

Published by FASA Corporation  
P.O. Box 6930  
Chicago, Illinois  
60680-6930

Playtested by: Chris Fell  
Sam Lewis  
Michael McAuliffe  
Dave Fell  
Lawrence Leeper  
Karen VanderMey





---

# Table of Contents

---

Introduction . . . . .	5
Glossary . . . . .	7
Defining a Being . . . . .	10
Player Character Races . . . . .	13
Vulcan Telepathic Techniques. . . . .	15
Familiar Characters . . . . .	18
Non-Player Character Races . . . . .	26
Creating Player Characters. . . . .	30
Player Character Record Sheet . . . . .	37
Skills and Skill Levels . . . . .	38
Combat and Tactical Movement . . . . .	44
Action Point Table . . . . .	45
Map Symbols. . . . .	48
To Hit Table (with adjustments) . . . . .	52
Weapon Range and Damage Table. . . . .	54
Medical Aid and Recovery. . . . .	62
Medical Glossary . . . . .	66
Equipment . . . . .	70
Weapons . . . . .	74
Planetside Adventures . . . . .	77
New Life and New Civilizations: Life Form Creation. . . . .	81
Planetary/Cultural Designation Index . . . . .	83
Animal Creation . . . . .	85
Historical Update - United Federation of Planets . . . . .	88
Shipboard Systems . . . . .	96
Starship Combat . . . . .	102
Encounters in Space: A Handbook for Star Vessel Protocols . . . . .	116
Starship Data. . . . .	119
Gamemaster Hints and Suggestions . . . . .	123
Designers' Notes . . . . .	126



## ACKNOWLEDGEMENTS

With three independent-minded authors, it is inevitable that this work have three independent dedications:

To my mother, Lula McLimore, who passed away 10/29/82 during the development of this work. With love and memories. . .

Guy McLimore, Jr.

To my mother, Carolyn, who may not have understood me, but who supported me nonetheless. . .

Greg K. Poehlein

To my wife, Joan, for tolerating the long nights of work, and to my son, Jason, whose future was my fiction. . .

David F. Tepool

Finally, a combined vote of thanks to Gene Roddenberry, the cast and crew of STAR TREK, and the millions of STAR TREK fans everywhere, who have kept its spirit of adventure alive for so very long.





# Introduction

**STAR TREK: The Role-Playing Game** is not a standard family boardgame; it doesn't feature a board around which players move playing pieces, with dice rolls determining movement and random events. This game uses a board (at times), dice, and playing pieces, but these are used differently than in standard boardgames.

Those familiar with the popular pastime of role-playing games (RPG for short) need not continue reading this section, which describes the procedures for this type of game. Experienced players may wish to review the mini-glossary at the end of this section before continuing or can move on to the system overview. Those unfamiliar with how role-playing games are organized and played should read on.

Role-playing games (RPG's) differ in a number of ways from boardgames or card games. In an RPG the rules define situations and conditions in a fictional world of the players' choosing. Many RPG's derive from the fictional worlds of myth, such as Camelot of the *Legends of the Knights of the Round Table*; or from the universes of heroic fantasy such as Professor J. R. R. Tolkien's Middle Earth from his *Lord of the Rings* series of books. Other fictional settings include the swashbuckling era of the Three Musketeers, the ingenious combat of World War II, comic book worlds populated by superheroes, and many others.

The object of role-playing games is to follow the rules in establishing a character who might have lived in the fictional world being used and to play that character during the game, much as an actor plays a role on stage or in the movies. To succeed in the game, one must think like the character would think and react to situations just as that character would, inhabiting that fictional world.

Unlike most plays or movies, however, there are no set lines and characters don't know what will happen until it occurs. RPG's are like improvisational theater in this regard. The situations characters will encounter are set up in advance by a referee, known as a gamemaster, who uses the rules to structure the adventure situations. The gamemaster does not play a specific character himself, but sets up the adventure and plays any people or animals met by the characters in the fictional world.

There are no set winners or losers in a role-playing game. Instead of competing with each other, players

cooperate toward common goals. As they meet challenges set by the gamemaster and overcome them, they learn new skills and become better at what they do. The gamemaster's job is therefore not to constantly block the player's progress, but rather to set up challenging situations. Within the framework of the rules, the gamemaster must provide enough challenge to make the game interesting, but not boring and frustrating.

In this game you will play characters who are officers and crew of a spacecraft of the United Federation of Planets. The setting is the rich fictional universe of **STAR TREK**, television's most popular science fiction series.

During three seasons on the air, the **STAR TREK** television series created a fascinating universe of science fiction adventure that captured the imagination of its viewers in a way no television series before or since can rival. Despite the fact that it has not appeared on network television since 1969 (except for an all-too-brief revival as an animated cartoon series in 1973-74), **STAR TREK** is more alive in the hearts, minds and imagination of its fans than ever before. The series has spawned two feature motion pictures, several series of popular novels, toys, collectibles, and the most well-organized and devoted fan organization in the history of creative endeavor.

In this game, players are able to take the role of Captain James Kirk, Science Officer Spock, Lt. Uhura, and any of the other familiar characters from the series. If you prefer, you may create new characters to play aboard the famous USS **ENTERPRISE**, or on any other Star Fleet vessel.

The basic game rules provide for all characters to be Star Fleet officers. In later expansions to these rules, material will be provided for creating other types of player-controlled characters, including Klingons and Romulans — **STAR TREK** villains! For now, such Bad Guys and other non-starfleet individuals will be played by the gamemaster as non-player characters (NPCs).

Star Fleet officers as player characters may be human beings like Kirk and Dr. McCoy, Vulcans like those of Spock's home world, or members of any of four other major United Federation of Planets cultures. Humans tend to be more numerous in Star Fleet and have some advantages in play because they are familiar. Playing an alien character can be extremely rewarding, however, because it

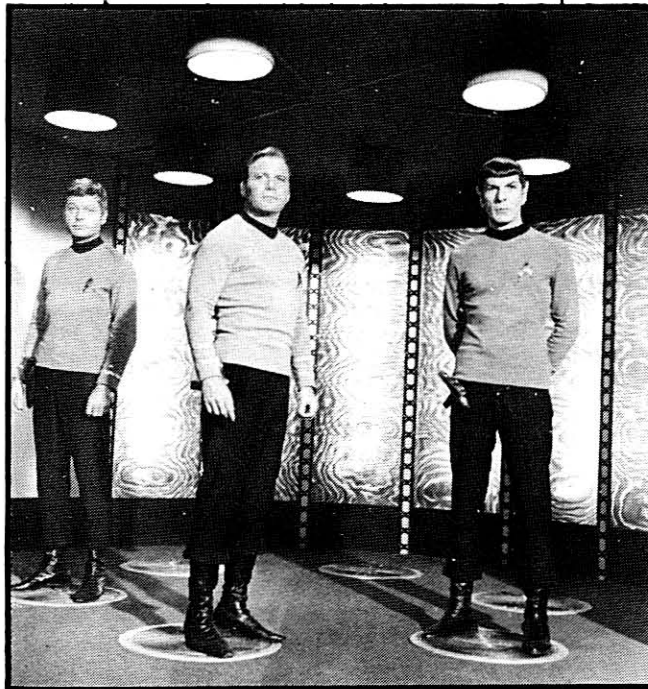



encourages players to develop a whole new way of thinking and acting within the game.

Game characters have various strengths and weaknesses defined by the rules, the gamemaster and the players themselves. Within personal limitations they try to accomplish tasks set forth by the gamemaster as part of Star Fleet's mission to "explore strange new worlds...seek out new life and new civilizations...and to boldly go where no man has gone before!"

When combat between players and non-player characters is called for, it is done on Star Ship deck plans, in buildings or on the surfaces of alien worlds, as drawn up by the Gamemaster on a grid of squares. The characters are represented by cardboard markers (or metal miniature figures, if the players have them) which are moved about

the board according to the rules to simulate combat. A character can be injured (or rarely, killed outright) in such combat. (Fortunately, in a game, such a calamity only results in developing a new character for the player!)

Combat between Star Ships is simulated in this game as well, using a unique system of Starship control consoles. Unlike many science fiction games, this Starship combat system involves all the players in the action, recalling the exciting scenes on board the bridge of the Enterprise in episodes of the STAR TREK TV Series!

Players during a game will try to take on the personality of their favorite STAR TREK character, or develop a new character's personality in interesting ways. The adventure possibilities are as unlimited as the Universe itself with STAR TREK: The Role-Playing Game.





# Glossary

The following is a mini-glossary of words, phrases and abbreviations that have special meanings in this set of rules for the game. Many of these will be familiar to already experienced role-playing game enthusiasts. Some terms may be new to most of you. Take a few minutes to look over this list and refer to it later if any explanation of role-playing terms is required.

## ACTION POINTS

A number which varies with a character's dexterity and represents the number of things or actions the character can do in one 10-second combat turn. Often abbreviated "AP".

## ADVENTURE

One mission, designed to stand alone or as part of a continuing campaign. Usually a single adventure or mission will only take one or two game sessions to complete.

## AP

See ACTION POINTS .

## ARCHAIC

Ancient or outdated. An archaic skill is one that hasn't much use anymore (like buggy whip making). In STAR TREK's time, many common skills, weapons, and even languages used today are outmoded and considered archaic.

## ATTRIBUTE

A number representing a character's potential in a certain area of physical or mental development. In this game, basic attributes are Strength, Endurance, Dexterity, Intellect, Charisma, Luck, and Psionic Potential. See listings under each of these for specific information.

## BLAST RADIUS

The area of destruction created by an explosion, such as a phaser overload.

## CAMPAIGN

A series of missions or adventures using the same cast of player characters and important non-player characters. In a campaign characters grow, develop and change, learning new skills and rising in rank and responsibility. Campaigns can last a long time or only a few adventures, as the gamemaster and players see fit.

## CHA

See CHARISMA .

## CHARACTER

The fictional identity taken on by a player for the game, as opposed to the player himself.

## CHARACTER CREATION SYSTEM

The procedure (explained in this book) by which player characters are developed before play. This is a method of determining attributes, skills and pre-game experience.

## CHARISMA

A character attribute governing the amount of personality, force and attractiveness possessed by a character. Charisma is not the same as physical beauty, though physical attractiveness can add to charisma.

## COUNTER

A cardboard square used to represent a character, animal, or other moving object on the tactical combat map.

## D10

Short for "10-sided die". Usually preceded by a number indicating how many dice are to be rolled. For example, "1D10" means roll one 10-sided die, "2D10" means roll two 10-sided dice (or roll one twice) and add the number together, etc. If something like "roll 1D10+5" is indicated, it means roll one 10-sided die and add 5 to the result.

## DAMAGE ROLL

A roll of dice which indicates how much damage is done to a character by an attack during combat. The number of dice rolled varies according to the weapons used in the attack.

## DEPARTMENT HEAD

A position of top responsibility on a starship. Department heads on Constitution-class starships include Chief Communications Officer, Chief Medical Officer, Chief Engineer, Chief of Security, Chief Helmsman, Chief Navigator, and Science Officer.

## DEX

See DEXTERITY .

## DEXTERITY

A character attribute governing a character's physical control, speed and accuracy.

## DIE MODIFIER

A number which is added to or subtracted from a roll of the dice to make an adjustment to that roll. Modifiers are sometimes used to make a saving roll harder or easier.

## DIE ROLL

The number generated by throwing one or more dice. (In this game, special 20-sided dice are used.) There are various types of die rolls made in this game. (See D10, PERCENTILE DICE).



**END**

See ENDURANCE

**ENDURANCE**

A character attribute denoting the amount of physical punishment, deprivation or abuse a character can absorb without losing consciousness or dying.

**GAMEMASTER**

The referee of a role-playing game. He is responsible for writing the background for adventures, much as a television writer prepares a script. Sometimes abbreviated "GM".

**GAME TURN**

A complete round of movement and actions for all players during the combat sequence.

**HAND-TO-HAND**

Combat between characters using just fists or other natural extensions like claws; no weapons. Sometimes abbreviated "HTH".

**INT**

See INTELLECT .

**INTELLECT**

A character attribute reflecting the mental processing ability, memory retention and the reasoning power of a character.

**LINE-OF-SIGHT**

A direct line between a character and a potential target. A clear line-of-sight, with no obstructions, must exist for the character to fire a ranged weapon at the target. Often abbreviated as "LOS".

**LOS**

See LINE-OF-SIGHT .

**MODIFIER**

See DIE MODIFIER .

**NON-PLAYER CHARACTER**

A character in the game who is played by the gamemaster, not a player. Sometimes abbreviated "NPC".

**OPPORTUNITY ACTION**

A combat action taken at a time other than the character's own turn.

**OPPORTUNITY FIRE**

Weapons fire done as part of an opportunity action.

**PERCENTILE DICE**

A dice roll involving two 10-sided dice. One die is designated as showing the tens digit of a two-digit number. The other is the ones digit. Rolling these dice generates a number from 01 to 00 (read as one hundred). Such a roll is sometimes abbreviated as "% dice".

**PERSONAL COMBAT**

Combat between characters, either hand-to-hand or using non-ranged weapons.

**PHYSICAL ATTACK**

See PERSONAL COMBAT .

**PHYSICAL COMBAT**

See PERSONAL COMBAT .

**PLAYER**

A person who plays this game (as opposed to a character).

**PLAYER CHARACTER**

A character operated by a player, not the gamemaster.

**PLAYER TURN**

The actions of a single player during a combat sequence.

**POSITION**

The job held by a Star Fleet Officer. This has nothing to do with rank, except on some ships an officer must be of a certain rank or higher to hold a specific position. Positions are such titles as Science Officer, Helmsman, or First Officer.

**RACE**

A group of sentient beings separated by species. All Earth humans, along with all inhabitants of human colonies, are considered to be of the Human race. Natives of Vulcan and Vulcan colonial worlds are of the Vulcan race. Races are usually separated by significant differences in physical structure (internal or external). Some races are denoted as humanoid or human-like (including Vulcans, Andorians, Klingons, etc.) Others are totally alien to the human form (such as the Tholians, Horta, and the true form of the Organians). Within each race are relatively insignificant differences of form or features (such as skin color, epicanthal folds, eye color, etc., among humans and humanoids). These minor differences have no effect on the game.

**RANGED ATTACK**

See RANGED COMBAT.

**RANGED COMBAT**

Combat or attacks made with weapons used at a distance, whether they be phasers or crossbows.

**RANK**

A denotation of military standing. Rank has nothing to do with position, except that some positions on some ships must be filled by someone of a certain rank or higher.

**ROUND DOWN**

Adjust a fraction number of the next lower whole number. For example, if told to divide 23 by 5 and round down, you would perform the division (23 divided by 5 is 4 and 3/5, or 4.6), then drop the fraction part (for a final result of 4).



### SAVING ROLL

A roll of dice (usually percentile dice) which is compared to either a character attribute or a skill level. If the die roll is higher than the attribute or skill level tested, the saving roll fails. If the roll, however, is the same or lower than the score being tested, the roll succeeds.

### SCENARIO

A single adventure or mission on which characters work toward one overall goal.

### SIDE

One group of related characters acting toward the same goal in a combat. This may be a group of player characters or a group of non-player characters (like a Klingon landing party) operated by the gamemaster. It is possible in some unusual situations to have more than two sides in a combat.

### SKILL

A learned ability in a specialized area, such as instrumental music, marksmanship, or transporter operational procedures.

### SKILL LEVEL

A numerical score showing the relative expertise of a character in a skill. Also known as "Skill Points" or "Skill Rating".

### SPECIALTY

A general area of concentration in which a character will probably center his efforts in gaining skills and increased skill levels. This area also determines the position (but not the rank) a character is likely to hold. Also known as "Specialty Area".

### STATISTICS

Another word for ATTRIBUTES . Also known as "Stats".

### STR

See STRENGTH .

### STRENGTH

A character attribute describing relative physical power.

### "TO HIT"

A score or number denoting the roll necessary on percentile dice to hit a target with a ranged weapon, or hit a foe with a weapon or fist. TO HIT rolls are made in a similar manner to saving rolls, in that any score on the dice which is equal to or less than the TO HIT number is successful. Any number rolled on the dice higher than the TO HIT number denotes an unsuccessful attack.

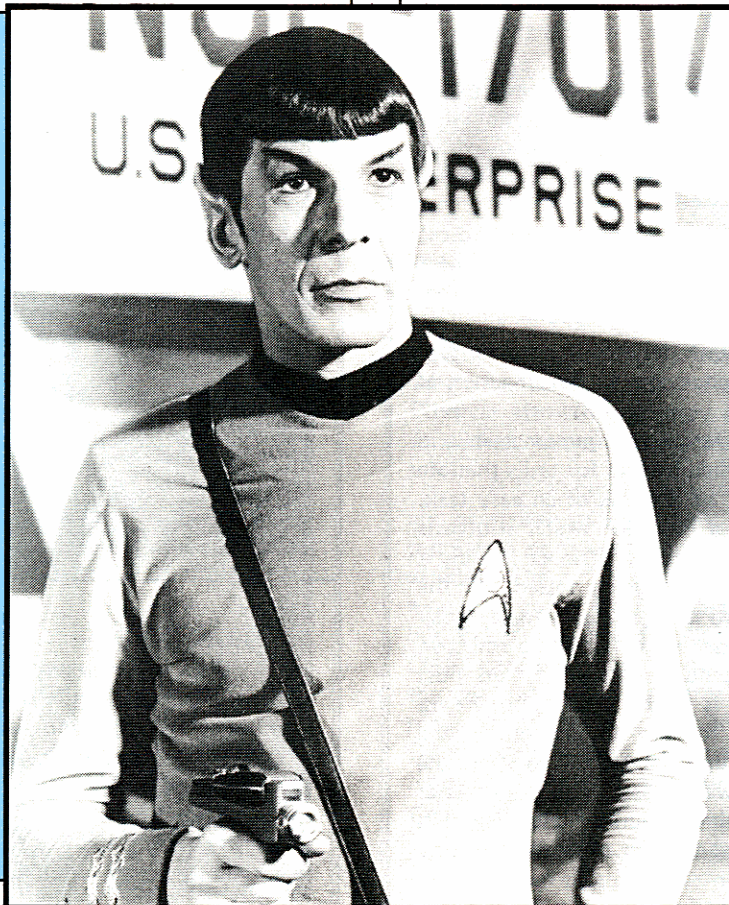



# Defining a Being

To play the role of either a familiar character from STAR TREK (like Captain Kirk, Mr. Spock, or Lt. Uhura) or a created character based in the same setting, a way of defining their relative strengths and weaknesses must be determined. Using humanity as a base (with one exception, see PSI), this game will define the capabilities of a character by a series of skills in various areas possessed by the character.

The attributes in this game are based on a scale of 1 through 100, 1 being the minimum score possible for a human, and 100 being a practically unattainable maximum for a human being. Non-human races may have more or less range in an area, and so have their possible range adjusted somewhat. It is possible to have a non-human character (or an extremely unusual human character) with a score of over 100 in an attribute.

Of course, the player characters, and many of the non-player characters, are not average human (or non-human beings). Only the best and the brightest get through Star Fleet Academy and survive the dangers inherent in space exploration. Therefore, the character creation system for this game is designed to produce the better-than-average character. Non-players who are not of Star Fleet or equivalent programs designed to weed out the less competent should be created by the gamemaster with this thought in mind.

At times in the game, it may be necessary to determine the character's ability to perform an action; the success or failure of which depends on the score in one or more attributes. To test a character's capability in an area a saving roll is usually made.

A saving roll in this game is made with % dice; the player tries to roll a number that is the same or lower than the character's score in the attribute being tested. Success means that the attribute was high enough to allow the character to perform the task desired. If not, the task cannot be completed by the character in that manner, at that time.

Saving rolls are called for by the gamemaster, and the requirements may be modified by him for tasks that are easier or harder than average. In the case of an easy task, the gamemaster may specify a modifier which subtracts from the saving roll, making it smaller and hence making it easier to score under the attribute being tested. On the other hand, for particularly hard tasks, the gamemaster may wish to add to the die roll, making it harder to roll low.

Such modifications should be consistent, and must be announced before the roll is made. (Exception: Where the circumstances of a saving roll are not obvious to the player. For example, when rolling a saving roll to affect the situation the player is not aware exists. The gamemaster may make the roll for the player secretly. He then tells the player nothing at all about the roll or modifiers, only the results.)

The basic attributes, and what they are used to describe, are presented here:

## ATTRIBUTE EXPLANATIONS

### STRENGTH (STR):

STR refers to a character's physical power—the ability to lift, carry, and apply force. It affects unarmed physical combat and is to some extent a measure of physique and size. A character with a STR score of 50 can carry about 50 lbs. at length without tiring, lift about three times that without strain and drag a 200 lb. weight for a short time without exhausting himself. This is about the minimum performance for a Star Fleet cadet, but is pretty good as humans go.

During the game, STR does not decrease from injury. It is a measure of potential based on a well-operating body. It may be reduced by other factors, or at gamemaster's option as the result of a debilitating injury that limits the character's potential.

A saving roll on STR might be made when something heavy must be moved, or when a character must force open a door or perform other physical feats of power.



### ENDURANCE (END):

END is a measure of how much abuse and neglect the body can stand; the body's defenses against adversity. Combat damage is removed directly from this statistic, as would be penalties for ingestion of poison, for the effects of disease, and exhaustion.

Reductions to END from exhaustion (and similar-appearing effects such as a Vulcan nerve pinch and phaser stun) are regained quickly. Damage done to the body in combat, however, regenerates much more slowly, depending on the level of medical aid available (see Damage Effects and Recovery and Medical Aid sections of the



rules.) Players and the gamemaster should keep a separate record of END loss for injury and for exhaustion, stun effect, etc. These effects may combine, however, to incapacitate a character and reduce the character to unconsciousness.

An END saving roll could be made to determine how long a character can undergo adversity, such as holding one's breath underwater, or undergoing torture at the hands of the Klingons.

#### INTELLECT (INT):

INT measures the character's mental processing potential just as STR measures the physical potential. INT scores determine how well a character can store and process information; that is, how well the character can think and reason. Some of this potential is genetically determined and some is determined by environment. Even in Star Trek's time, scientists and educators do not agree on which is more important.

A saving roll on INT may be made whenever the character needs to reason out a problem or gather and process new knowledge not fitting into an existing skill description. (Example: Puzzling out the operation of a totally alien device beyond their experience). If a skill on the skills list would be of help in such an effort, the skill score and the INT score should be added together and averaged (divided by 2) and a saving roll made on the result. (If the character's score in that skill is zero, use  $\frac{1}{2}$  the INT score to make the saving roll. This is one time when the gamemaster may want to make the roll secretly, as if a player does not know the function of a device, the character should not be told which skill affects his roll to figure it out!)

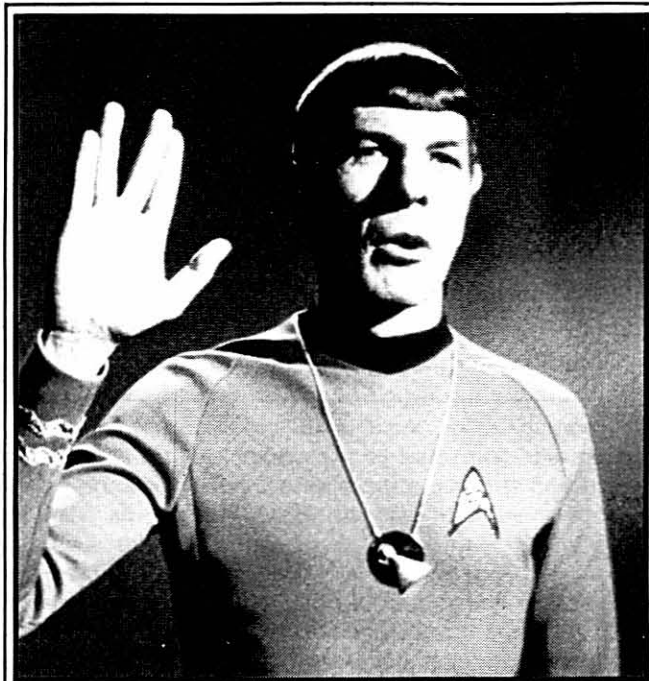

#### DEXTERITY (DEX):

DEX is a measure of the physical control a character possesses in terms of agility, aim, balance, etc. DEX affects how well a character uses a weapon, how clumsy the character is, how quickly he or she can physically react to danger or opportunity, etc.

A saving roll on the DEX attribute might have to be made for the character to perform an act requiring physical coordination (like walking over a slippery rope bridge) or quick physical reactions and reflexes (such as playing a game of zero-gravity handball, one of Kirk's favorites!) It also affects (along with weapons skills) use of hand weapons, projectile weapons, and other combat styles. (See combat rules).



#### CHARISMA (CHA):

This attribute is not merely a measure of physical attractiveness. Physical attractiveness is meaningless when dealing with members of other races from other worlds. Alien standards of attractiveness may be quite different. Physical attractiveness may enter into the charisma of an individual, but more important is force of personality (or will).

A character with a lower than average charisma is not necessarily plain or ugly. The character may be a handsome man or woman who does not possess as much personal magnetism or force of personality as some others. Conversely, a high charisma character may be physically average but a dynamic, forceful speaker. The interpretation of the CHA attribute score is up to the player to decide and the gamemasters to interpret. Players and gamemasters are reminded of the Vulcan philosophy of the IDIC – Infinite Diversity in Infinite Combinations. Beauty is in the differences in people and cultures, not in conformity to standards.

A CHA saving roll might be required to catch the eye and attention of a member of the opposite sex (as Captain Kirk was often doing, sometimes as a requirement of his duty to protect his ship and crew, but more often because he has little resistance to a charming woman!) CHA is

averaged with the leadership skill score for saving rolls when attempting to lead or influence an unfamiliar or hostile group, but CHA is used alone when trying to influence individuals.

#### LUCK (LUC):

When it comes right down to it, luck is a part of all endeavor. Cmdr. Spock has observed that human history is a series of lucky breaks, as human society survived crisis after crisis despite great odds against survival. For this reason, and because so many times luck has saved the life or career of one or more of the Star Trek characters, this statistic must be part of the game.

Luck seems to affect humans more than any other race, as Spock observes. Somehow, being a human being (that is, of Earth ancestry) gives an edge during a crisis. Of course, such luck is unpredictable and capricious, and lucky breaks can happen to anyone (as simulated to some extent by the use of dice in this game to add the random fact to the interactions of beings within their environment and each other).

LUC saving rolls are used in this game when the game-master believes situations may be affected by pure chance and coincidence. The object of this game for the game-master is not to kill off player characters, and setting up a total adversary relationship between players and the game-master limits the enjoyment of the game. Therefore, the game-master should use a LUC saving roll attempt at times to give a player a chance to bail himself out of a tricky situation. A saving roll of this type should always be given to a player character (or a non-player who is an established STAR TREK character) who is in imminent danger of death or other tragedy. Temper the use of such saving rolls with common sense, but do use them when necessary. Sure, it hampers realism, but STAR TREK should reflect television realism, not reality.

On the other hand, the breaks go both ways. At crisis points, LUC rolls should be applied, with things going badly if the rolls are failed. This is a good way for a game-master to introduce another plot complication to a scenario if players are getting bored.

One important use of the LUC attribute saving roll is to limit damage from energy weapons. Thus, a fatal shot should be reduced to a Graze from energy weapons if a LUC save can be made by the victim.

In reference to the large LUC penalty given in the rules to Vulcan characters, observation shows only that Vulcans are logical, strong, and psionically gifted. They do not seem to be lucky. Such is the price you pay for higher than average attribute scores in STR, END, and INT!

#### PSIONIC POTENTIAL (PSI):

This statistic reflects the potential psionic power of an individual character. Note that this does not mean that a person with a high PSI score will necessarily have psionic abilities in evidence. Cultural development and training are of prime importance in developing psionic powers, and most cultures do not place educational emphasis on such training.

Earth and Human culture is mostly lukewarm toward psionic development. We know that Star Fleet tests all personnel for psionic potential (see the episode *Where No Man Has Gone Before*), but most of the rest of humanity has no idea what psionic potential they possess. Even Star Fleet has no formal training in psionics offered at the Academy, though especially promising students may get the opportunity to study on Vulcan (game-master's option—such a character would probably adopt Vulcan ways and attitudes. See the episode *Is There in Truth No Beauty?*)

Vulcan culture, on the other hand, trains all Vulcan children in certain psionic disciplines, such as mind linking. It is part of the Vulcan heritage. Actually, Vulcans as a race probably started out with no more psionic potential than humans. Their cultural emphasis on mental control has acted as a form of natural selection for centuries. The psionically gifted are more likely to survive and have children on Vulcan.

Thus, Vulcan player characters may realize their psionic potential to a greater extent, using PSI saving rolls to judge succession applying Vulcan psionic techniques. (See racial data for Vulcan characters for details). Humans and most other races will apply PSI saving rolls only as resistance to unwanted PSI prying by others into their minds, and as modifiers to other types of psionic activity and attack.

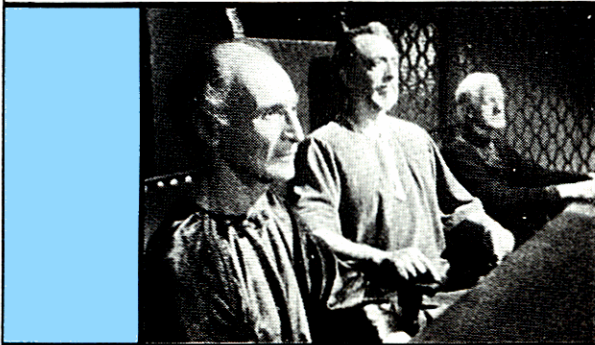



# Player Character Races

There are six Federation races commonly found as starship crewpersons. Actually, there are many, many starfaring groups among Federation-affiliated populations, but quite a number are of these six basic types and the character creation system in this game centers on these groups.

Each player character race has its own set of unusual physical and psychological peculiarities. Humans are, by far, the easiest to play. After all, you have plenty of experience! It is suggested that new players start with a human character, especially if the player is not already intimately familiar with the STAR TREK universe.

When playing non-human characters, the role-playing aspect of the game is more important than ever. Gamemasters must insist that non-humans act like non-humans! Emotional Vulcans, meek Tellarites and life-of-the-party Edoans should not be tolerated in a game situation.

## HUMANS



Humanity is the most numerous sentient species in the Federation. Besides Earth-born humanity, there are also thousands of human colony worlds. On some of these worlds, particularly those long colonized, the human population has changed and evolved to better adapt to local conditions.

Besides Earth colonies, there are a number of civilizations with no known ties to Earth that have nevertheless produced native species identical to Earth humans in virtually all respects. Scientists have not answered the questions this raises, nor have they explained why even some definitely non-human races (Vulcans and Klingons, to name only two) still bear so many resemblances to Humans.

It is believed by some scientists that all of these races are offshoots from some common space-travelling race in the distant past. This theory is not proven, however, and is widely disputed.

At any rate, all planetary cultures with basically Human physiology are considered as Human in this game, despite unimportant variations in height, weight, skin coloration, sensory enhancement, etc. Note also that not all "Human" cultures are part of the Federation. Thus "Humans" may turn up as a non-player or even an enemy race at times.

Remember that though Humans are basically the same physically, their motivations and backgrounds may be very different. Each character's personality and actions should be developed by the player based on the background he creates. A person who grew up on a small agricultural world will have a different point of view than one who grew up in the cities of Earth.

## VULCANS



Vulcans were the first alien species encountered by Humans that were significantly different in physiology and psychology from people of Earth. They are human-like in many respects, but in other ways they're totally different.

Vulcan (the home planet, as translated from their tongue) is a harsh world, dry and hot with higher gravity and a thicker atmosphere than Earth. These conditions affected the Vulcan physical development.

Vulcans are stronger than Humans, with more physical endurance. Their blood chemistry is based on copper (rather than iron) as a carrier of oxygen. This makes their blood greenish in color, and gives them a somewhat greenish-yellow complexion. Their eyes are protected from the harsh Vulcan winds and sand by a thin transparent membrane, much like a second eyelid.

Vulcan's culture is far older than Earth's own. In prehistory, Vulcans were tribal and warlike- as savage as early Humans, if not more so. Their savagery threatened to bring about their extinction through constant warfare.



## VULCAN PSIONIC TECHNIQUES

Eventually the ancient Vulcan philosopher Surak turned the people of Vulcan away from violence by introducing a philosophy of rejection of emotional expression. Today's Vulcans refrain from expressing all emotions, letting logical thought and a rational decision-making process rule their lives.

A commonly held misconception among Humans is that Vulcans have no emotions. This is not true, but it is so widely believed that some Vulcans believe it themselves. Actually, Vulcans suppress emotional reactions, depending on mental discipline to keep emotions from affecting their thinking and actions. This process is so ingrained in Vulcan tradition and society that it is almost automatic for Vulcan adults, even under great stress. In fact, the expression of emotion is considered to be in extremely bad taste in Vulcan society—only a barbarian or a mental defective would think of such a thing.

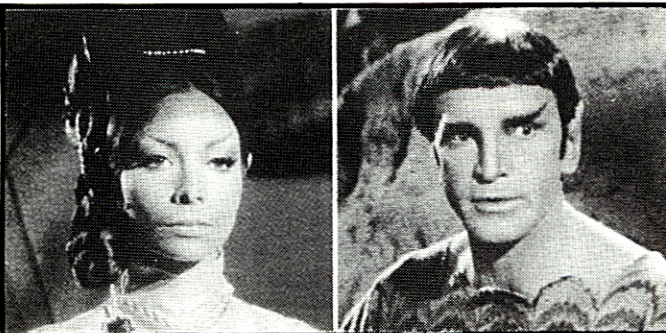

T'Pring

Surak

Interactions with other cultures, particularly Human, is slowly affecting Vulcan attitudes, especially among those often exposed to Human culture. Sophisticated, well-travelled Vulcans find Human emotional expression baffling and somewhat distasteful, but are able to live and work around Humans nevertheless. A less worldly individual might be horrified by open Human emotionalism. (If so, the Vulcan would of course never show his dismay. He or she might, however, avoid Human contact whenever possible.)

Vulcan logical development grew out of an avoidance of war. This wish to avoid war has affected their culture in other ways as well. Vulcans do not believe in killing other thinking life unless absolutely necessary. All Vulcans are vegetarians, finding the idea of killing animals for food repulsive. Some Vulcans are extreme pacifists, believing that there is never any reason to kill any living being, but all Vulcans will avoid killing except in the direst need. For this reason, Vulcan characters rarely carry arms, and will not use deadly force against another thinking beings except under direct order, or in the most extreme emergency.

The Vulcan pursuit of the logical ideal has led them to great accomplishment in both the sciences and arts. Intellectual pursuits come naturally to Vulcans.

Another result of the intellectual/mental introspectiveness of Vulcan culture is their development of certain psionic disciplines to a level unmatched by most other sentient races. There have been attempts to teach these ancient disciplines to members of other races, and some partial successes have been noted. But centuries of psionic exercise and mental discipline have made the Vulcan race capable of some amazing psionic feats. Knowledge of these disciplines is ingrained in the culture, and most Vulcans can perform them to some degree. Those who are especially adept are revered and respected by all.

It is widely known that members of the Vulcan race are somewhat telepathic, some individuals more than others (according to their PSI score in the game). The ability to use this telepathic tendency manifests itself in various ways.

In modern Vulcan society, the use of telepathic contact to pry into another's mind is unthinkable. Such contact is intimate and somewhat embarrassing. Mind contact is not practiced for trivial reasons.

Vulcans use several mind contact forms (if they use any at all). The most common is the mind touch. Physical contact between the Vulcan telepath and the subject is desirable, but not absolutely necessary. In the mind touch, the minds of two individuals become attuned, to the point where the thoughts and feelings of each are shared and communicated. The depth of sharing and communication depends on the wishes of both parties, and the conditions under which the attempt is made.

Vulcan mind fusion is a deeper form of the mind touch technique. With mind fusion, the two minds actually become one, with total sharing of not only thought but motivations and memories as well. This technique would only be attempted under the most extreme circumstances, as it is very difficult and embarrassing for the Vulcan, and somewhat dangerous because the two personalities involved may be hard to sort out and split apart to terminate the fusion.

The Vulcan mind meld is a multiple-mind touch, where several minds are in communication/communion at once. This, too, is a very different technique.

## GAME MECHANICS - VULCAN PSIONIC DISCIPLINES

When a character must use one of the described Vulcan psionic abilities, a basic % dice saving roll must be made against the character's PSI score. Modifiers from the following tables should be applied to the roll, according to the type of telepathic communication desired, and the conditions under which it is being attempted.

An attempt to make any sort of telepathic link takes 1 minute (6 turns, in the combat scale), during which the character may take no other actions. Quiet is desirable, and there must be no distractions or concentration will be broken. Thus there is no way that a mind touch or other psionic discipline could be attempted in combat!



VULCAN TELEPATHIC TECHNIQUES

DIE MODIFIERS

CONDITION	MODIFIER
MIND TOUCH—One-way transfer of a basic concept or feeling (such as hunger, fear or a feeling of relaxation)	+0
MIND TOUCH—One-way communication of a short message or complex concept or feeling (such as “the prisoners are escaping” or “we are not hostile”)	+10
MIND TOUCH—Two-way telepathic conversation (equivalent to a vocal discussion of about one hour, with visual aids and sharing of memory)	+20
MIND TOUCH—Two-way sharing of thoughts and feelings (surface) and communication of true intentions	+30
MIND TOUCH—Total exchange of memory data and thought sharing	+40
MIND TOUCH—Modifications of subject’s memories or attitudes (by other than persuasion)	+20
MIND FUSION—Complete sharing of self	+50
MIND MELD—Per additional person in any of the above levels	+½ cost as above
Total quiet and isolation (no other persons present in room)	-15
Comfortable, familiar surroundings	-10
Subject is also willing telepath	Use the highest PSI No. and subtract ½ the other’s PSI from the roll
Subject is non-telepathic, but willing	-25
Subject is unresisting or unaware	-10
Subject is aware and resisting mentally	- ½ the subjects PSI
Subject has been mind touched before by same Vulcan telepath	-10
Subject and Vulcan telepath are friends or are otherwise mentally sympathetic	-10
Subject can be physically touched	-20
Subject is in sight and near, but not touched	+0
Subject is distant (depending on distance, and at game-master’s option)	+10 or more...
Subject is Human/Vulcan-like sentient being	-10
Subject is non-humanoid sentient being	-10
Subject is semi-sentient	+10
Subject is non-sentient (animal)	+25
Subject is an unknown type of creature, never before encountered	+20

Gamemasters are encouraged to apply other modifiers as needed for special situations or to modify the figures given above if the situation warrants it.

The above list of rules and modifiers is complex, but the complexity is necessary. Vulcan mental techniques are a useful part of **STAR TREK: The Role-Playing Game**, but they are usually misused if Vulcan characters are allowed to apply them indiscriminately. Thus, these rules permit their use where appropriate, but allow the gamemaster to restrict them for the sake of play balance. Gamemasters must keep Vulcan telepaths on a "short leash" and not allow psionics to dominate the game!

Because of the complexity of these rules, let's look at an example of Vulcan mind touch at work. Suppose a landing party from the U.S.S. Enterprise, commanded by Dr. Spock, is captured by hostile natives and locked in a cell. The jailer is right outside the locked steel door, dozing in a chair. The use of Vulcan mental abilities might get our heroes out of the spot they are in!

Spock can see the jailer through a small window in the door. He calls for silence and begins to concentrate...

The player running the character of Mr. Spock must now determine his chances of placing a suggestion in the mind of the jailer. He tells the gamemaster that Spock is trying to communicate to the jailer the feeling that the prisoners are escaping, hoping in his half-waking state he will get up and open the door to see.

Looking at the chart of modifiers, we can see that Spock is trying for a "one-way communication of a short message or feeling". The modifier is +10 to the saving roll made.

Also, the subject is unaware (-10), in sight and near (+0) and a humanoid, sentient being (-10). Since the jailer is half-asleep, he's probably easier to confuse, so the gamemaster decides to give Spock an additional -5 bonus. (Gamemasters: Feel free to give bonuses and penalties beyond the charts when you feel they are deserved). Thus, Spock's total modification is -15.

Spock has a PSI attribute score of 98, and must roll under that (after modifications) to be successful. The roll is made, but it's not a good one—99! Fortunately, the -15 modifier brings that roll to 84! The jailer jumps up and groggily unlocks the door to look for the prisoners. The other members of the landing party jump the jailer and knock him unconscious, and the party is freed!

### VULCAN NERVE PINCH



This is another technique only Vulcans can apply, since it requires great strength and detailed knowledge of the nervous system. Not all Vulcans can perform this, but many can. (All Vulcan player characters are probably trained in this technique, if they were raised on Vulcan or by Vulcans).

The nerve pinch is applied by grasping the area just between the neck and shoulder and applying pressure in a certain manner. If properly executed, the victim is almost instantly rendered unconscious, having no chance to cry out or take any action.

The technique is only effective against upright bipeds (humanoids) who are not protected by natural or artificial armor. Thus, Humans, Vulcans, Andorians, Klingons, Edoans and the like could be affected, but a Gorn's hide is too tough, and some other alien species may be too large, or have no definable head and neck, or simply have less sophisticated or entirely different nervous systems.

### GAME MECHANICS -VULCAN NERVE PINCH

The Vulcan nerve pinch is applied like any other hand-to-hand attack in the combat game, with a few modifications to the die roll "to hit", as noted below.

Victim is unaware of attacker's presence (sneaking up from behind, for example)	-30
Victim is caught by surprise or distracted in some manner (Victim must fail a standard saving throw on INT to be tricked in this manner...)	-20
Victim is on guard in general against attacker	+20
Victim is on guard, and aware of nerve pinch technique	+40

If the "to hit" roll is successful, the victim is reduced to unconsciousness immediately, regardless of END. The effect lasts a number of minutes equal to 2D10+10, as with phaser stun. Like phaser stun, there is no residual loss of END upon regaining consciousness.

Vulcans also know techniques for relieving pain with nerve pressure. It would be impossible to provide a full set of rules for such action, but the gamemaster should be aware of the possibility should the need arise. Note that such techniques do not reduce the severity of an injury, nor revive an unconscious person. In fact, masking pain in this manner could cause an injured person to make his/her injuries worse without being aware of it! This technique, however, might be employed to save a character a saving roll for unconsciousness upon reduction to ½ END. A Vulcan cannot apply the pain-reduction technique to himself.





## ANDORIANS



Physically, Andorians are blue-skinned humanoids with white hair and a pair of knobbed antennae extending from the sides of the crown of the head. Their slim builds conceal a well-muscled warrior's body.

Andorian history is one of conflict, though like the Romulans who are foes of the Federation, they do not battle without reason. The martial spirit is still alive in Andorian culture. Andorians are a stoic, unsentimental people for the most part, but they do respect and revere ties of family.

The Andorian antennae are sensitive organs of hearing—more sensitive in some ranges than those of humans or Vulcans. (However, they are also more vulnerable and exposed.)

Andorians are fond of technology, but insist on its use in concert with nature. For this reason, their wars of conquest in early Andorian history were fought with a regard for planetary environment. As such, they avoided much of the ecological devastation suffered by Earth humans and many other cultures.

Andorians are extremely disciplined, and possess a strong sense of duty and personal honor. As such, they make excellent military officers.

## CAITIANS

This race walks erect as bipeds, but they are descended from creatures similar in some respects to Earth felines. They possess sleek bodies covered with soft fur, which also covers their faces and hangs about the head like a mane. They have large golden eyes, long tails, and voices with a purring quality.

Caitians are extremely dexterous and fast. Their ancestors were hunting carnivores, but a large portion of the Caitian population is now vegetarian! They have acute senses of sight and smell.

Caitians practice total equality of the sexes, and have throughout recorded history. Even Caitian names have no gender indicated, so a male child is as likely to be named after his mother as after his father.

## EDOANS

The Edoans are a more recent addition to the Federation. They walk upright and have some resemblance to Humans, but are tripedal; possessing three arms and three legs. Their skin is orange and hairless. They have round yellow eyes and a concave structured head.

Edoans are among the best toolmakers in the Federation, due to their sensitive hands and great dexterity. They are meticulous about detail and make good scientists and technicians.

The Edoans are reserved and prize privacy. They tend to be shy and introverted, making few close attachments.

## TELLARITES



Tellarites are basically humanoid, but with a pinker skin tone than human caucasians (due to higher normal blood pressure). Tellarites have more facial and body hair than humans, with hair covering all but the frontal face and the hands. Such hair is not as thick as animal fur, but is more reminiscent of an extremely hairy person. Their home worlds have a thinner atmosphere than Earth, leading to their overdeveloped nasal openings, which have been unkindly compared to the snouts of Earth swine. (Tellarites take immediate and strong offense to such comparisons!) Members of the Tellarite race are racially suspicious, argumentative and brash, at least by Human standards. Those who trust too much or give in too easily are considered weak fools in Tellarite society. Tellarites, needless to say, make poor diplomats. They enjoy a good argument, and a merchant's bazaar on a Tellarite world is a very lively place, indeed!

Tellarites are fond of food and drink — and lots of it. Fortunately, alcohol has little adverse effect on them. (It only makes them more stubborn). Nevertheless, they are capable of going twice as long without food or water as the average human, since they carry an extra abdominal roll of fatty tissue. This abdominal tissue makes them look portly, but such is natural for a Tellarite, and they can, in extreme cases, live off this fatty deposit for quite a while. Generally, though, they'd rather not skip a meal.

# Familiar Characters

The crew of the U.S.S. Enterprise are the most capable crew members in Star Fleet. As such, they are far above the average in both character attribute scores and skill levels. Player characters created with the player character creation system are not likely to have the depth and breadth of skill levels possessed by the Enterprise crew.

Skills and attributes for STAR TREK's familiar characters are based on observations in the series, traditional fan thoughts, and additions, and rational speculation. Gamemasters should feel free to add to or alter these statistics if they wish. All series regulars have complete character statistics provided, with recurring (but not regular) characters provided in a shorter format, which may be expanded by the gamemaster if desired.

Players and gamemasters not already experienced with role-playing games such as this one are encouraged to play at least a couple of adventures with the familiar STAR TREK characters already provided. More experienced players may wish to proceed directly to creating their own, original Star Fleet officers with the player character creation system.

---

## STAR FLEET PERSONNEL FILE – U.S.S. Enterprise – NCC-1701

---

KIRK, James Tiberius / Captain / Human, male / Age 34  
 Commanding, U.S.S. Enterprise  
 SERIAL No: SC937-0176CEC

STR 68                  END 77                  INT 84                  DEX 79                  CHA 94                  LUC 98                  PSI 29  
 "TO HIT" (modern arms) 79 (hand-to-hand) 80

### SKILL LEVELS

Administration	60	Planet survival	66
Astron/astrop	53	Ship weap tech	29
Carousing	62	Psychol (Human)	49
Computer oper	50	Shuttle Pilot	49
Computer tech	10	Shuttle syst tech	11
Electronics tech	10	Sm equip sys tech	11
Envir suit oper	51	Sm unit tactics	64
Federat history	64	Stshp cmbt tac/str	96
Federation law	86	Stshp commun proc	38
Gaming	82	St engrg (genrl)	22
Instruction	55	Stshp helm oper	62
Languages (ORION)	21	Stshp navigation	79
Leadership	92	Strshp security	32
Mrksmshp (arch) - (ANCIENT FIREARMS)	36		
Mrksmshp (mod)	78	Strshp sensors	41
Negot/diplom	97	Streetwise	79
Pers weap tech	21	Trans op proc	66
Pers Cmbt (unrmd)	81	Warp drive tech	33
Trivia (LIFE OF ABRAHAM LINCOLN)	91		
Trivia (AMERICAN HISTORY)	77		



Commendations: Palm leaf of Axanar Peace Mission; Grankite Order of Tactics, Class of Excellence; Prantares Ribbon of Commendation, first and Second Class

AWARDS OF VALOR: Medal of Honor; Silver Palm with cluster; Star Fleet Citration for Conspicuous Gallantry; Karagite Order of Heroism

MEDICAL NOTES: Once contracted Vegan choriomeningitis & still carries microorganisms in bloodstream

BIRTHPLACE: Earth/United States of America



SPOCK / Commander / Vulcan (half-vulcan, half-human), male / Age 40+  
 First Officer, Science Officer, U.S.S. Enterprise  
 SERIAL No: SI79-276SP

STR 93            END 82            INT 102            DEX 73            CHA 62            LUC 41            PSI 97  
 "TO HIT" (modern arms) 53    (hand-to-hand) 65

SKILL LEVELS

Admin	56	Physics	77
Astron/astrop	65	Plan ecol	45
Botany	35	Plan surv	51
Com sys tech	44	Sh wpn tech	39
Comp arch (EARTH)	56	Psych (human)	14
Comp op	91	Rac clt/his (human)	62
Comp tech	48	Shutt pilot	47
Elect tech	26	Shutt sys tech	23
Env suit op	29	Sm eq sys tech	31
Fed Hist	56	St cmbt tac/str	55
Fed law	65	St comm proc	14
Gaming	87	St engrg (gen)	46
Geology	44	St helm op	35
Instruction	34	St navig	46
Inst mus (Vulcan lyr)	86	St sensors	92
Lang (ENGLISH)	98	Trans op proc	71
Leadership	52	Trans sys tech	42
Mech eng	21	Zero-G op	38
Neg/dipl	71	Zoology	41
Phys chem	31		

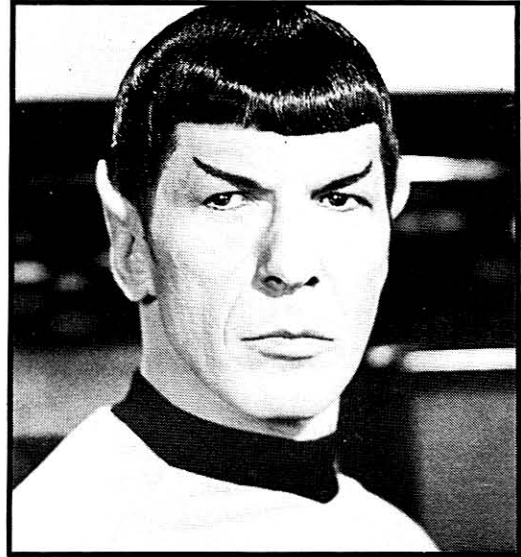

Trivia (EARTH ARTISTS) 37  
 Trivia (EARTH POETRY) 42  
 Trivia (EARTH RELIGIOUS LITERATURE) 27

COMMENDATIONS: Vulcan Scientific Legion of Honor; twice decorated by Star Fleet Command

AWARDS OF VALOR: Star Fleet Award of Valor

MEDICAL NOTES: Rare blood type (T-negative)

BIRTHPLACE: Vulcan/ShiKahr

SULU, Hikaru W. / Lieutenant / Human male / Age 31  
 Chief Helmsman, U.S.S. Enterprise  
 SERIAL No: SH7730-4967

STR 65            END 63            INT 82            DEX 88            CHA 79            LUC 81            PSI 21  
 "TO HIT" (modern arms) 75    (hand-to-hand) 68

SKILL LEVELS

Admin	40	St cmbt tac/str	68
Astron/astrop	62	St comm proc	31
Botany	77	St engrg (gen)	23
Carous	41	St helm op	89
Comp op	44	St navig	78
Comp tech	29	St sensors	59
Def sh tech	28	Streetwise	51
Elect tech	45	Trans op proc	35
Fed hist	30	Trivia (ANCIENT FIREARMS)	89
Fed law	32		
Instruction	31		
Leadership	48		
Marks (arch) — (pistols)	54		
Prs cmbt (ar) (sword)	66		
Sh wpn tech	42		
Shutt pilot	57		

BIRTHPLACE: Earth

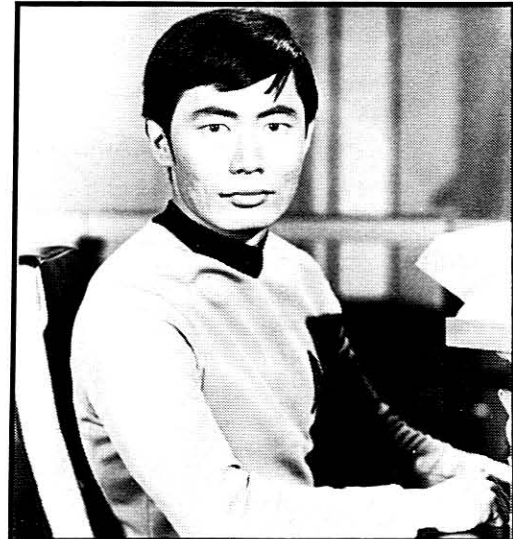

McCOY, Leonard (M.D.) / Lt. Commander / Human, male / Age 45  
 Chief Medical Officer, U.S.S. Enterprise  
 SERIAL No: SM831-3840

STR 56            END 54            INT 83            DEX 79            CHA 81            LUC 66            PSI 52  
 "TO HIT" (modern arms) 50    (hand-to-hand) 52

SKILL LEVELS

Admin	43	Medicine (human)	96
Astron/astrop	10	Medicine (vulcan)	42
Botany	53	Neg/dipl	66
Carous	44	Phys chem	46
Comp op	42	Plan ecol	52
Env suit op	24	Plan surv	26
Fed Hist	38	Psych (human)	56
Fed law	44	Psych (vulcan)	32
Instruction	49	St sensors	31
Lang (LATIN)	47	Streetwise	52
Leadership	47	Zoology	38
Life sup tech	33		

COMMENDATIONS: Legion of Honor

AWARDS OF VALOR: decorated by Star Fleet Surgeons; Star Fleet Award of Valor

PERSONAL NOTES: Divorced with one child (daughter Joanna, 20)

BIRTHPLACE: Earth/United States of America



UHURA / Lieutenant / Human, female / Age 29  
 Chief Communications Officer, U.S.S. Enterprise  
 SERIAL No: SK2561-1122

STR 54            END 62            INT 87            DEX 89            CHA 86            LUC 71            PSI 41  
 "TO HIT" (modern arms) 57    (hand-to-hand) 58

SKILL LEVELS

Admin	42	St navig	48
Astron/astrop	31	St sensors	51
Carous	36	St services	22
Com sys tech	92	Streetwise	39
Comp op	61	Trans op proc	43
Comp tech	33	Vocal music	94
Elect tech	38	Trivia (ANCIENT AFRICAN CULTURE)	86
Fed hist	39	Warp dr tech	27

BIRTHPLACE: Earth/United States of Africa





SCOTT, Montgomery / Lt. Commander / Human male / Age 45  
 Chief Engineer, U.S.S. Enterprise  
 SERIAL No: SE197-514

STR 61            END 57            INT 91            DEX 66            CHA 62            LUC 71            PSI 22

SKILL LEVELS

Admin	42	Prs wpn tech	34
Astron/astrop	32	Physics	62
Carous	72	Sh wpn tech	37
Com sys tech	39	Shutt pilot	29
Comp op	49	Shutt sys tech	69
Comp tech	47	Sm eq sys tech	45
Def sh tech	34	St cmbt tac/str	31
Elect tech	78	St engrg (gen)	99
Env suit op	34	St helm op	28
Fed hist	32	St sensors	33
Fed law	36	Streetwise	48
Instruction	43	Trans op proc	81
Inst mus (Bagpipes)	54	Trans sys tech	94
Lang (GAELIC)	48	Trivia (alcohol. Bev)	89
Leadership	52		
Life sup tech	62	Warp dr tech	97
Mech eng	77	Zero-G op	35
Neg/dipl	33		

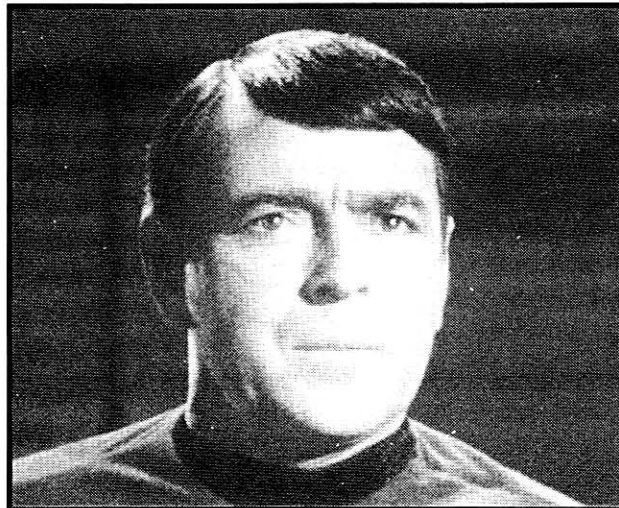

BIRTHPLACE: Earth/Scotland

CHEKOV, Pavel Andreievich / Ensign / Human, male / Age 22  
 Navigator, U.S.S. Enterprise  
 SERIAL No: SN2304-0121

STR 64            END 59            INT 81            DEX 68            CHA 81            LUC 60            PSI 11  
 "TO HIT" (modern arms) 55    (hand-to-hand) 54

SKILL LEVELS

Admin	30	Shutt pilot	18
Astron/astrop	76	Sm unit tact	19
Carous	30	St cmbt tac/str	48
Comp op	33	St comm proc	23
Comp tech	21	St engrg (gen)	24
Elect tech	22	St helm op	32
Env Suit op	25	St navig	77
Fed Hist	41	St security	15
Fed law	39	St sensors	34
Gaming	16	Streetwise	11
Geology	12	Trans op proc	17
Instruction	20	Warp dr tech	39
Lang (RUSSIAN)	96	Zero-G op	21
Leadership	52		
Neg/dipl	21		
Plan ecol	19		
Plan surv	21		
Sh wpn tech	36		

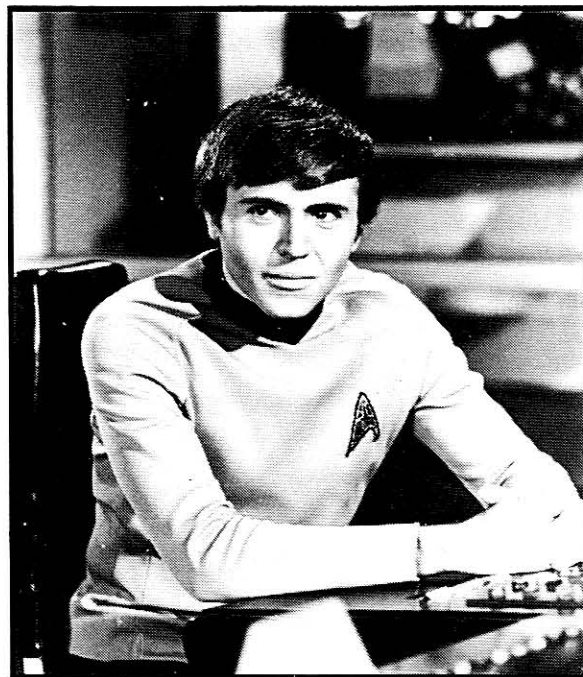

BIRTHPLACE: Earth/Russia

CHAPEL, Christine / Ensign / Human, female / Age 31  
 Head Nurse, U.S.S. Enterprise  
 SERIAL No: SM3561-9943

STR 59            END 53            INT 79            DEX 71            CHA 73            LUC 31            PSI 39  
 "TO HIT" (modern arms) 46    (hand-to-hand) 48

SKILL LEVELS

Admin	53	Medicine (vulcan)	22
Astron/astrop	15	Neg/dipl	51
Botany	84	Phys chem	32
Carous	29	Plan ecol	66
Comp op	39	Plan surv	19
Elect tech	11	Psych (human)	24
Env suit op	16	Psych (vulcan)	11
Fed hist	33	St comm proc	20
Fed law	31	St sensors	31
Instruction	54	Streetwise	13
Language (VULCAN)	15	Trivia (VULCAN COOKING)	29
Leadership	44	Zoology	69
Life sup tech	34		
Medicine (human)	24		



PERSONAL NOTES: Originally research biologist - sciences section. Transferred to medical after death of fiance, Dr. Roger Korby.

BIRTHPLACE: Earth

RAND, Janice / Ensign / Human, female / Age 26  
 Yeoman, U.S.S. Enterprise  
 SERIAL No: SV8100-222

STR 52            END 56            INT 69            DEX 68            CHA 71            LUC 20            PSI 45  
 "TO HIT" (modern arms) 53    (hand-to-hand) 44

SKILL LEVELS

Admin	69	Plan surv	31
Astron/Astrop	35	Psych (human)	19
Carous	29	St comm proc	28
Comp op	31	St helm op	22
Env suit op	16	St navig	30
Fed Hist	52	St security	11
Fed law	41	St sensors	25
Gaming	38	St services	66
Instruction	49	Streetwise	14
Lang (FRENCH)	10	Trans op proc	41
Leadership	28		
Neg/dipl	32		
Plan ecol	16		



BIRTHPLACE: Earth



## OTHER ENTERPRISE CREWMEN

RILEY, Kevin / Lieutenant / Human, male  
 Navigator (transferred from Engineering), U.S. S.  
 Enterprise  
 Birthplace: Tarsus IV colony  
 STR 56 END 61 INT 67 DEX 62 CHA 81  
 LUC 27 PSI 19  
 Significant skills: Starship Engineering (general) 48  
 Starship Navigation 62  
 Trivia (IRISH HISTORY) 81  
 Vocal Music 02

M'BENGA (M.D.) / Lieutenant / Human, male  
 Medical officer, U.S.S. Enterprise  
 Birthplace: Earth/United States of Africa  
 STR 62 END 70 INT 84 DEX 71 CHA 77  
 LUC 41 PSI 61  
 Significant skills: Medicine (Human) 64  
 Medicine (Vulcan) 53

DESALLE, Vincent / Lieutenant / Human, male  
 Asst. Chief Engineer (tranf. from Navig.), U.S.S.  
 Enterprise  
 STR 71 END 60 INT 76 DEX 59 CHA 61  
 LUC 38 PSI 13  
 Significant skills: Starship Navigation 61  
 Starship Engineering (general) 80  
 Leadership 77

KYLE, Winston / Lieutenant / Human, male  
 Transporter chief (tranf. from Helm), U.S.S.  
 Enterprise  
 Birthplace: Earth/Great Britain  
 STR 62 END 55 INT 71 DEX 81 CHA 76  
 LUC 28 PSI 22  
 Significant skills: Starship Helm Operation 72  
 Starship Sensors 51  
 Transporter Oper. Proc. 84  
 Transporter Sys. Tech. 39

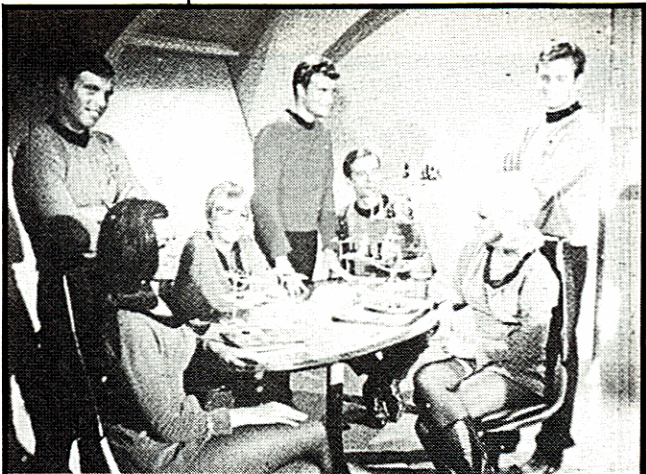

## TYPICAL FEDERATION PERSONNEL

Use these guidelines for creating non-player crewmen for Star Fleet ships. Add or subtract appropriate modifiers for the character's racial type (Human, Vulcan, etc.). These guidelines enable a gamemaster to fill out a landing party quickly.

### SECURITY GUARD

STR 60+2D10 END 60+2D10 INT 50  
 DEX 60+2D10 CHA 40+1D10 LUC % die  
 PSI % die  
 Significant skills: Marksmanship (modern) 40+3D10  
 Personal Combat (unarmed)  
 40+3D10  
 Starship Security 25+3D10

### ENGINEERING SPECIALIST

STR 60 END 55 INT 55+3D10 DEX 60  
 CHA 50+2D10 LUC % die PSI % die  
 Significant skills: Starship Engineering (general)  
 50+4D10  
 Any technical specialty 50+4D10

### SCIENCES SPECIALIST

STR 55 END 55 INT 55+3D10 DEX 60  
 CHA 50+2D10 LUC % die PSI % die  
 Significant skills: Any science specialty 55+4D10

### COMMODORE or ADMIRAL (serving planetside)

STR 35+3D10 END 30+4D10 INT 55+3D10  
 DEX 35+3D10 CHA 55+3D10 LUC % die  
 PSI % die  
 Significant skills: Administration 55+4D10  
 Negotiation/dipl 50+3D10  
 Leadership 50+4D10





## OTHER STAR TREK CHARACTERS

Some skills listed for characters in this section are not from the Federation Star Fleet skills lists. Such skills are noted with an asterisk (\*) and described at the end of this section.

**SAREK** / Vulcan, male / Age 102

Former Vulcan ambassador to Federation Council; Chief Vulcan negotiator at Babel Conference; Married to Amanda Grayson of Earth; One child, Spock, serving with Star Fleet.

STR 90 END 79 INT 105 DEX 69 CHA 81  
LUC 50 PSI 89

Significant skills: Astronomy/astrophysics 96  
Computer technology 81  
Negotiation/diplomacy 98



**MUDD, Harcourt Fenton (Harry)** / Human, male / Age 51  
Con man and rogue. (Alias WALSH, Leo Francis among others . . .)

STR 50 END 47 INT 81 DEX 48 CHA 73  
LUC 24 PSI 14

Significant skills: Carousing 78  
Federation Law 81  
\* Small Vessel Piloting 72  
(license suspended)  
\* Trade and Commerce 92  
\* Forgery 67  
\* Bribery 59  
Negotiation/Diplomacy 83



**JONES, Cyrano** / Human, male / Age 46  
Space trader and independent scout.

STR 41 END 32 INT 62 DEX 42 CHA 88  
LUC 02 PSI 17

Significant skills: Carousing 87  
Federation Law 32  
Negotiation/diplomacy 77  
Small Vessel Piloting 61  
\* Trade and Commerce 89

**SINGH, Kahn Noonian** / Human, male (genetically improved)

Eugenics Wars tyrant; absolute ruler of ¼ of Earth from 1992 to 1996; escaped Earth aboard "Botany Bay" sleeper ship; exiled to Ceti Alpha V (after being awakened by crew of U.S.S. Enterprise) for attempted hijacking of that Federation vessel.

STR 91 END 104 INT 96 DEX 98 CHA 99  
LUC 56 PSI 62

Significant skills: Administration 71  
Leadership 98  
Negotiation/diplomacy 67  
Personal Combat (unarmed) 69  
Psychology (human) 84  
Planetary Survival 89

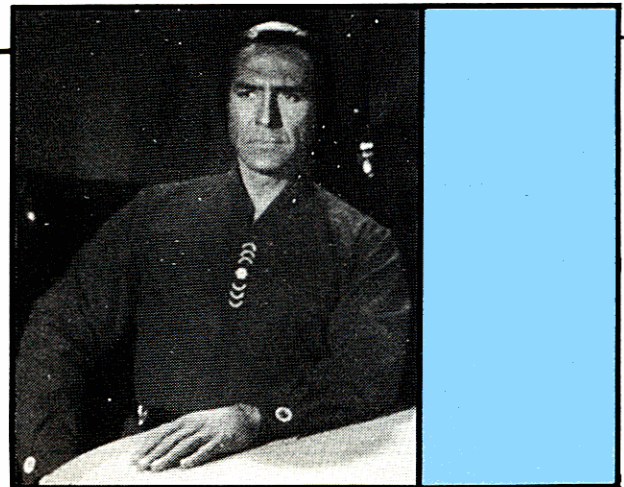



## NEW SKILLS



KOR / Captain / Klingon, male  
Commanding, Klingon D7 Battlecruiser "Klothos"  
STR 83 END 77 INT 62 DEX 74 CHA 31  
LUC 21 PSI 16  
Significant skills: Leadership 81  
Marksmanship (modern) 62  
Personal Combat (unarmed) 75  
Negotiation/diplomacy 27  
\* Interrogation 83  
Starship ComTactics/Strategy 49

KOLOTH / Captain / Klingon, male  
Commanding, Klingon D7 Battlecruiser "Devisor"  
STR 79 END 81 INT 76 DEX 71 CHA 59  
LUC 36 PSI 21  
Significant skills: Leadership 79  
Marksmanship (modern) 57  
Personal Combat (unarmed) 41  
Negotiation/diplomacy 42  
\* Interrogation 69



### BRIBERY

Skill at subtle negotiation of bribes, kickbacks and other illegal payoffs.

### FORGERY

The ability to prepare phony documents and signatures without detection.

### INTERROGATION

Skill governing the questioning of prisoners, sometimes under duress or torture. A saving roll is used here to successfully gain information from a prisoner. If the roll succeeds, the victim gets a saving roll try on the INT score (if the interrogator is using trickery) or the END score (if duress or torture is used). If the victim's roll succeeds, no information is given. If not, the questioner gets a significant piece of knowledge, at gamemaster's option.

NOTE: If torture is used, it is possible that the victim may die before giving up a secret. If the questioner makes a successful roll, and the victim fails the END save by more than 20 points, the victim passes out, taking 2D10 of wound-type damage in the process. The victim may be immediately revived (if the wound damage hasn't killed him . . .), but the process must begin again with another successful save on the Interrogation skill.

Also, each torture attempt does 1D10 wound damage to the victim no matter the outcome. Thus, a victim's END continues to drop under torture, making it all the more likely that the victim will pass out or possibly die under duress before talking. It is possible to administer medical aid to raise END before continuing torture.

Please note also that Vulcans know mental techniques to "turn off" pain. Thus it is impossible to torture information out of a Vulcan.

### SMALL VESSEL PILOTING

Skill in operation of small 1 to 10 man star vessels of a non-military nature, usually pilotable by a single person.

### TRADE AND COMMERCE

Ability and experience in buying and selling commodities on the open market, including interstellar trading.



# Non-Player Character Races

This section deals with creating non-player characters of various non-human races who often interact with Federation Star Fleet crews. This section will cover the most prominent rivals of the Federation, giving adjustments for rolling character attributes and providing statistics for typical characters found in certain important positions.

Expansions to these rules are planned to allow players to create player characters who are Klingons, Romulans, etc. Meanwhile, these rules and guidelines will allow gamemasters to prepare non-player characters from these races for use in scenarios and campaigns.

## KLINGONS

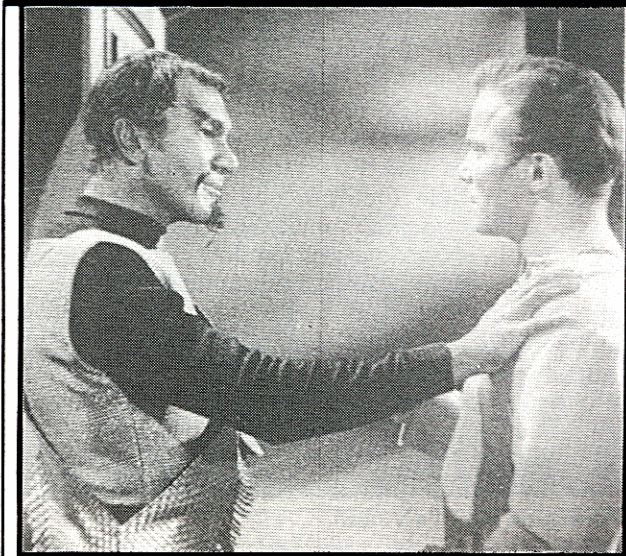

The Klingon Empire is a military dictatorship that is the chief foe of the United Federation of Planets. War between the two organizations is only prevented by the Organian peace treaty imposed by the powerful, peace-loving residents of Organia. Under this treaty, no open hostilities between the Empire and the Federation are allowed. The disputed area bordering both spheres of influence is administrated by Organia, with planets within it allowed to fall under the control of the government who is best able to develop the planet efficiently.

Physically, the Klingons are similar to Earth humans, at least on the outside. They tend to be of dark complexion and hair color. Male Klingons often wear beards and moustaches. Their internal construction is quite different, however. A cursory scan with a standard medical scanner will detect Klingon physiology instantly, even though it is quite easy to disguise the outer appearance as a human.

The Klingon racial philosophy is that of ruthless warriors; but they are not berserk. They wage war with forethought and cunning, yet war is the natural, preferred state for most Klingons. For this reason, Klingon society

stresses physical strength and martial skill above scientific achievement. Most Klingon scientific effort is placed into development of weapons.

The Klingon government suppresses the development of psionic activity, considering such to be a risk to Klingon security. Personal charisma is less important in Klingon society than strength and cunning, as advancement in one's field is often through blackmail, betrayal, or other use of overt or covert force.

### KLINGON NPC ADJUSTMENTS

STR +10 END +5 INT standard DEX standard  
CHA -20 LUC -40 PSI -50

### TYPICAL KLINGON CAPTAIN (Battlecruiser or other major warship)

STR 60+2D10 END 55+2D10 INT 50+2D10  
DEX 50+2D10 CHA 30+2D10 LUC 10+2D10  
PSI 2D10

Significant skills: Leadership 50+2D10  
Negotiation/Diplomacy 20+2D10  
Interrogation 60+2D10  
Starship cmbt tact/strat 40+2D10  
Marksmanship (modern) 40+2D10  
Personal cmbt(unarmed)40+2D10



### TYPICAL KLINGON SOLDIER/GUARD

STR 65+2D10 END 60+2D10 INT 30+2D10  
DEX 60+2D10 CHA 20+2D10 LUC 5+2D10  
PSI 2D10

Significant skills: Marksmanship (modern) 40+2D10  
Personal cmbt(unarmed)45+2D10  
Starship security 20+2D10  
Small unit tactics 2D+2D10

**EQUIPMENT:** Landing parties carry hand disruptors and Klingon communicator/'corders. Security personnel carry disruptor rifles and sometimes wear armored vests (-2 points damage from all hits). Command personnel (captain, first officer, security officer, medical officer) carry agonizers.



## ROMULANS



The Romulan Confederation is the other major rival of the Federation. The Romulan race is thought to be an offshoot of the Vulcan race which never got over its militaristic ways.

Though physically similar to the Vulcans, the Romulans are not physically as strong. (The Romulan planets are believed to be less harsh and demanding of climate than Vulcan. Thus, the Romulans have not developed into quite as hardy a race.) Also, since Romulan culture favors obedience over original thought and action, Romulan intellectual achievement is not as high as that on Vulcan, on the average.

In development of psionic abilities, Romulans are, unlike their Vulcan cousins, lukewarm toward such research. Thus psionics are not a widely developed or prized ability class. Romulans, however, have not abandoned reliance on intuition and hunches to the extent that the Vulcans have done so, causing them to have a "luckier" reputation than Vulcans.

The Romulan lifestyle is a Spartan existence, with personal wants sublimated for the good of the whole. The Romulans are great warriors, but fight in a cool, calculating manner. They take no prisoners, ask and give no quarter, and demand instant obedience from soldiers and populace alike. In one sense, the populace is the army, as all Romulan citizens are required to serve with armed forces in some capacity for a period of time. The Romulans are intelligent, dedicated, and very efficient.

First contact with the Romulans led inevitably to war. So devastating was this early conflict that in no engagement did Federation personnel who actually made contact with the enemy survive to tell about it. The first Romulan war was fought a century prior to the mission of the U.S.S. Enterprise, but only since the Enterprise fought off a Romulan raid in recent times (Stardate 1709.0; *The Balance of Terror*) has the Federation known what they look like.

The first Romulan War was an enormous drain on both sides, as it was fought over a period of many years by slower-than-light spacecraft. But the many worlds of the Federation had the resources to maintain the battle and the Romulans did not. Eventually, the Romulans sued for peace.

A so-called neutral zone was established between the Federation and Romulan space. Border posts were placed on both sides, with all ships permanently banned from entering the no-man's-land thus established. But the Romulan pride eventually asserted itself, leading to a number of incidents between Federation and Romulan vessels in recent years.

Most recently, the Romulans have made contact with the Klingon Empire and formed certain trade and technology-swapping agreements. This had led to the adoption of Klingon-design ships (including D-class battlecruisers) by Romulan fleets, replacing to some extent their less powerful Bird-of-Prey class ships. Romulan soldiers and guards also are known to use Klingon-design sidearms.

Unlike the Klingons, Romulans practice equality of the sexes, being more interested in the efficiency of an officer than his/her sex. Romulans, unlike Vulcans, are very much creatures of pride, emotion and passion, possessing the capacity for great violence when provoked.

### ROMULAN NPC ADJUSTMENTS

STR +10 END +10 INT standard DEX +5  
CHA standard LUC -10 PSI -20

### TYPICAL ROMULAN SUB-COMMANDER

(commands one ship of a fleet)

STR 60+2D10 END 60+2D10 INT 50+2D10  
DEX 55+2D10 CHA 50+2D10 LUC 40+2D10  
PSI 30+2D10

Significant skills: Administration 40+2D10  
Negotiation/Diplomacy 40+2D10  
Leadership 60+2D10  
Starship cmbt tact/strat 50+2D10



### TYPICAL ROMULAN CENTURION

STR 70+2D10 END 70+2D10 INT 40+2D10  
DEX 65+2D10 CHA 35+2D10 LUC 30+2D10  
PSI 10+2D10

Significant skills: Marksmanship (modern) 60+2D10  
Personal cmbt(unarmed)60+2D10  
Starship security 40+2D10

EQUIPMENT: Landing parties carry hand disruptors and communicators (similar to Federation design); security personnel carry disruptor rifles and wear armored vests and helmets (-2 points damage per hit).



## GORN

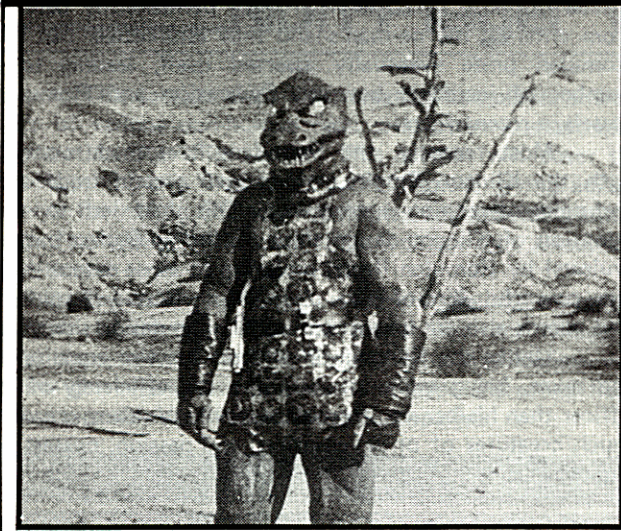

The Gorn are a reptilian race of warriors. Though battle is not the overwhelming preoccupation with them as it is for the Klingons and Romulans, the Gorn do prize physical strength and endurance over intellect.

The Gorn planets are heavier gravity worlds than Earth, with a harsher climate. Their reptilian bodies have developed harder and more enduring for this reason.

Gorn society, and Gorn individuals, are not given to subtlety. Even Gorn engineering is of the "push hard until it moves" variety. The Gorn do not attempt to be charismatic, preferring to persuade by physical domination. They consider psionics a fidgety and unworthy discipline, and do not pursue such studies.

Though initial contact with the Gorn led to a violent confrontation (that was abruptly halted by the Metrons—see the episode *Arena*), talks are now progressing slowly, with each side grudgingly (at least on the part of the Gorn) avoiding impingement on the space of the other until border disputes can be resolved.

### GORN NPC ADJUSTMENTS

STR +30 END +25 INT standard DEX -20  
CHA -20 LUC -20 PSI -40  
Personal cmbt damage +4 (claws and teeth)  
Natural Armor -5 points/attack (reptilian skin)



### TYPICAL GORN CAPTAIN

STR 80+2D10 END 75+2D10 INT 50+2D10  
DEX 30+2D10 CHA 30+2D10 LUC 30+2D10  
PSI 10+2D10  
Significant skills: Negotiation/Diplomacy 20+2D10  
Leadership 40+2D10  
Personal cmbt(unarmed)50+2D10

### TYPICAL GORN SOLDIER

STR 90+2D10 END 85+2D10 INT 30+2D10  
DEX 25+2D10  
CHA 10+2D10 LUC 20+2D10 PSI 10+2D10  
Significant skills: Personal cmbt(unarmed)65+2D10  
Marksmanship (modern) 40+2D10  
Small unit tactics 40+2D10

EQUIPMENT: Landing parties carry Gorn blasters and communicators (similar to Federation design).

## THOLIANS

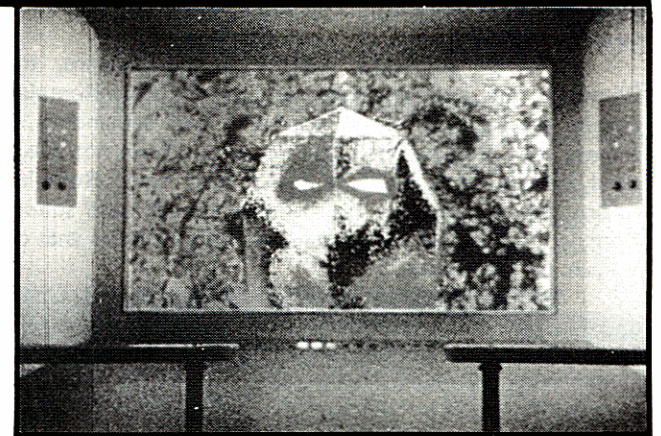

Little is known about the Tholian race. No member of this race has ever been seen in person by a Federation representative, and almost nothing is known about their physical capabilities.

The following information is extrapolation based on starship-to-starship encounters, viewscreen observation, and expert opinion based on limited data.

The Tholians guard their small area of space rigorously, allowing no traffic there without challenge. They are punctual, precise, and extremely suspicious. Though no state of war exists between the Tholians and the Federation, Federation vessels avoid Tholian space whenever possible. The Tholians, for their part, have never been known to venture beyond the boundaries of their own space.

### THOLIAN NPC ADJUSTMENTS

STR unknown END-10 INT +10 DEX unknown  
CHA -20 LUC -20 PSI unknown

### TYPICAL THOLIAN CAPTAIN

STR ? END 40+2D10 INT 60+2D10 DEX?  
CHA 30+2D10 LUC 30+2D10 PSI?  
Significant skills: Leadership 50+2D10  
Negotiation/Diplomacy 20+2D10  
Starship cmbt tact/strat 60+2D10

EQUIPMENT: No significant information is known about Tholian personal weapons or equipment.



## ORIONS



The Orions, from a planet in the Rigel star system, are an allegedly neutral group. They tend to encourage privateers (pirates), however, on an informal and unofficial basis. Orion pirates and smugglers are sometimes encountered by the Federation.

Orion males, for the most part, are human-like beings, with skin color ranging from a ruddy golden orange to more humanlike tones similar to Earth caucasians. There are females of this race as well, but some females are born who appear very much like human females, but with green skin. The green-skinned women are held in semi-slavery arrangement by the Orion men.

The green-skinned Orion women are seductive, with legend holding that human males cannot resist them. They are less intelligent than the dominant Orion species (or are said to be, though this may be more from lack of educational opportunity than genetics) and behave in a semi-animalistic fashion. Such women usually have long sharp nails and a greater physical dexterity than the dominant Orion male.

Transport of slave women beyond the neutral Orion planets is prohibited and, of course, slavery is outlawed at all levels of the Federation. Few Federation Star Fleet personnel have ever seen an Orion slave woman, but it is a frequent boast during the traditional male "bull sessions" around the mess table.

ORION NPC ADJUSTMENTS—Dominant males and females  
STR +10 END standard INT standard DEX standard  
CHA -10 LUC -25 PSI -30

ORION NPC ADJUSTMENTS—Green slave females  
STR standard END standard INT -30 DEX +30  
CHA +30 LUC -10 PSI -10

### TYPICAL ORION SMUGGLER CAPTAIN

STR 60+2D10 END 50+2D10 INT 50+2D10  
DEX 50+2D10 CHA 50+2D10 LUC 25+2D10  
PSI 20+2D10

Significant skills: Marksmanship (modern) 40+2D10  
Personal cmbt(unarmed)30+2D10  
Leadership 60+2D10  
Negotiation/Diplomacy 65+2D10  
Starship cmbt tact/strat65+2D10  
Streetwise 60+2D10  
Trade and commerce 60+2D10  
Bribery 60+2D10

EQUIPMENT: All smuggler crew carry sidearms, usually disruptor type, similar to Klingon design. Phasers may occasionally be used of Federation manufacture.

### TYPICAL ORION SLAVE WOMAN

STR 40+2D10 END 40+2D10 INT 20+2D10  
DEX 80+2D10 CHA 90+2D10 LUC 40+2D10  
PSI 30+2D10

Significant skills: Personal cmbt(unarmed)20+2D10  
Streetwise 60+2D10  
Vocal music 40+2D10  
Artistic ability (Dance) 70+2D10  
Courtesan 70+2D10 \*  
Carousing 70+2D10

EQUIPMENT: Slave women employed in public entertainment often carry small knife-like weapons concealed. Some may be poisoned or drugged. Also, slave women have claw-like fingernails, helpful in hand-to-hand combat, that add 2 points of damage to hand-to-hand attacks, beyond damage done according to STR.

### SPECIAL SKILL:

COURTESAN: The skills involved in attracting and seducing the opposite sex of one's own race, or similar racial type. (Humans, Klingons, Romulans, Vulcans, Andorians and Orions are all of similar racial stock and would tend to be attracted by the same physical qualities. Tellarites and Caitians are somewhat different, but attraction across these racial differences is possible. Tholians, Edoans and Gorn are totally non-humanoid and are unlikely to be physically attracted outside their own race.)

# Creating Player Characters

For those players and gamemasters who wish to use characters that are created from the ground up, the following system is provided. In this way, players may develop a character whose background and abilities suit the player's own tastes and the gamemaster's needs.

If this system is to be used, the gamemaster must decide ahead of time to what type of Star Fleet vessel the new characters will be assigned and what jobs on that vessel must be filled by player characters. Gamemasters may choose to make players anything from the crew of a small scout ship to department heads of an Enterprise-type starship.

The object for the gamemaster is to set up a situation where players are in the roles of action-oriented, decision-making people. Obviously it's no fun to play a junior research chemist stuck in a lab while everyone else gets landing party duty! On small ships, landing parties will be made up of junior officers. (On very small ships, a Lt. J. G. may even command!) On larger ships like the Enterprise, however, the goal should be to make players responsible middle-level or senior officers, so they have some say in what they do.

On large ships, player characters can be department heads. In Star Fleet, department heads often go on landing parties, in charge of junior officers.

Exactly what posts the characters are to fill is up to the gamemaster to decide. Department head positions available on large ships include Chief Engineer, Chief Communications Officer, Chief Navigator, Chief Helmsman, Chief Medical Officer, Science Officer, and Chief of Security. Players may hold these posts, plus those of Captain and First Officer, if the gamemaster wishes.

The gamemaster and the players should decide what position the character is to hold during the adventure or campaign before characters are actually created! This way, the player can aim for the rank and skill levels needed for the job the character will eventually have to fill.

This procedure of filling in the skills necessary to hold a position may take longer (in number of years spent in Star Fleet) for one character than another. This means that as characters are created, they will enter the game at a variety of ages, as it should be.

Once a character's eventual specialty is decided, actual character creation begins.

## CHARACTER ATTRIBUTES

First, choose the character race. In most ships, the crew is mostly made up of one group (Humans, Vulcans, etc.) with a sprinkling of other types. It is up to the gamemaster to decide whether or not a player may have a non-human character and what type of non-humans are available.

Next, roll 3D10 and add 40 for each character attribute except LUC and PSI. Apply the racial modifiers from the chart below. Some races tend to have higher or lower scores in some areas. If a character should be a hybrid (like the half-Human, half-Vulcan Mr. Spock), decide which half is dominant and use those modifiers.

For LUC and PSI, roll % dice and apply racial modifiers. In all cases, any score that finishes as less than zero is raised to one, but any score going above 99 is allowed to do so.

Finally, roll % dice once and divide by two to determine the number of bonus points available. These bonus points may be added to any attribute (except PSI) to raise it, with certain restrictions. No attribute may be increased higher than 99 with bonus points. (If it's already over 99, it cannot be increased after all.) Also, no attribute may have more than 30 points added to it.

This completes the determination of character attributes. These scores do not change during the game by normal means. (Academy entrants are screened carefully, and must be in the best physical shape possible just to get in!) They may be modified by the gamemaster later as a result of accident, or other changes brought about as part of an adventure.

### RACIAL MODIFIERS/ATTRIBUTES

	STR	END	INT	DEX	CHA	LUC	PSI
HUMAN	-	-	-	-	-	-	-30
ANDORIAN	+10	+5	-	-	-	-20	-20
CAITIAN	-	-5	-	+20	+5	-10	-30
EDOAN	-5	-	-	+15	-	-15	-35
TELLARITE	+5	+5	-	-	-10	-20	-40
VULCAN	+20	+10	+10	-	-	-40	-

## PRE-ACADEMY

What a character did before entering the Academy may be important to his career. To give the character some background, skills may be chosen at this time, and a background story worked out (if the player so desires).

A player makes a number of pre-academy skill rolls equal to 1/10 the character's INT attribute score (round down). Pre-academy skills are chosen from the pre-academy skill lists given below.

Each time a skill is chosen, roll 1D10 plus 5 for the number of skill points gained in that area. The game skill



may be chosen more than once to build it up. Any skill in which a specific area must be chosen (like languages or medicine) must be specified at this time.

At least half of the skill rolls must be made from the personal development table, with the other half from the educational background table (divide as nearly as possible).

One exception to this process is the character preparing to hold the position of Medical officer. These characters enter the academy as MDs at a later age than other cadets. Thus, complete the normal pre-academy procedure for such characters, then give them 40 skill points in medicine (native). (This is the equivalent of an MD degree).

Characters preparing to be medical officers enter the Academy at age 25 instead of at age 18, but when they finish their cadet cruise they are automatically promoted to Lieutenant, Junior Grade. A character preparing to be in the medical field, but not a doctor, goes through the pre-academy and academy procedures in the usual way.

### PRE-ACADEMY SKILL LISTS

PERSONAL DEVELOPMENT
Administration
Artistic Ability
Carousing
Gaming
Instruction
Instrumental Music (instrument)
Languages (language)
Leadership
Marksmanship (archaic) (weapon)
Marksmanship (modern)
Negotiation/Diplomacy
Personal Combat (armed) (weapon)
Personal Combat (unarmed)
Planetary Survival
Streetwise
Trivia (category)
Vocal Music
EDUCATION BACKGROUND
Astronomy/Astrophysics
Atmosphere Craft Pilot
Botany
Comparative Archeology (race)
Computer Operation
Computer Technology
Electronics Technology
Federation History
Federation Law
Geology
Ground Vehicle Operation
Medicine (race)
Physical Chemistry
Physics
Planetary Ecology
Psychology (race)
Racial Culture/History (race)
Small Unit Tactics
Water Vehicle Operation
Zoology

### STAR FLEET ACADEMY

Once pre-academy skills are determined, the character is ready to enter Star Fleet Academy for four years, starting at age 18. The passage of years should be kept track of by the character, as it will determine the character's age upon entrance to the game.

During four years in the Academy, a character will gain a solid background in the skills important to all Star Fleet officers—the Academy's general education requirements. The character gains skill points in each of the following skill areas added to any existing totals:

Administration (10)  
 Astronomy/Astrophysics (10)  
 Computer Operation (20)  
 Federation History (10)  
 Federation Law (10)  
 Instruction (10)  
 Languages (language) (10)  
 Leadership (10)  
 Marksmanship (modern) (20)  
 Personal Combat (unarmed) (20)

A character will also be concentrating on her/his specialty area, which must be chosen at this time, based on the job the character is to hold in the game. There is a specialty area for each department head position.

A character being prepared to command a ship may be in any specialty field except medicine or security, with navigation or helm preferred.

Under each department below is a list of skills and skill points gained during the Academy years in each specialty. The character gains the indicated skill levels (added to any she/he already has).

In addition, the player gets at least 10 skill rolls on any combination of skills desired (including repeated rolls on the same skill), gaining 1D10 in skill points for each. The player may use these rolls to expand knowledge in the specialty or gain useful skills outside it.

For every 10 points (or portion thereof) over 50 in the character's INT score, take one extra skill roll of 1D10. A character with an INT attribute of 74 would get 3 extra skill rolls, for a total of 13. These bonus rolls must be taken on the same skills listed as part of the character's specialty to build them up further.

Skills should be chosen in a way that moves the character toward having the skills necessary to hold the job selected for the game. Once these skills are chosen, the character is detached from the Academy for a Cadet Cruise.

## STAR FLEET ACADEMY

### SCIENCES

Astronomy/Astrophysics—20  
Computer Operation—10  
Environmental Suit Operations—10  
Planetary Ecology—20  
Starship Sensors—20  
Any Other Sciences Skills (Botany, Comp. Archeology, Geology, Physical Chemistry, Physics, Zoology)—90 (In any combination, but at least two must be at least 10)  
Transporter Operational Procedures—10

### ENGINEERING

Computer Technology—20  
Deflector Shield Technology—10  
Electronics Technology—20  
Environmental Suit Operations—10  
Life Support Systems Technology—20  
Mechanical Engineering—20  
Personal Weapons Technology—10  
Physics—10  
Ship's Weaponry Technology—10  
Starship Engineering (general)—40  
Starship Sensors—10  
Transporter Operational Procedures—20  
Transporter Systems Technology—10  
Warp Drive Technology—30

### SECURITY

Federation Law—20  
Ground Vehicle Operation—10  
Marksmanship (modern)—20  
Personal Combat (armed) (weapon)—10  
Personal Combat (unarmed)—20  
Personal Weapons Technology—10  
Planetary Survival—10  
Psychology (native)—10  
Shuttlecraft Pilot—20  
Small Unit Tactics—20  
Starship Security—30  
Zero-G Operations—20

### MEDICINE

Botany—10  
Environmental Suit Operations—10  
Life Support Systems Technology—10  
Medicine (native)—20  
Medicine (non-native)—20  
Negotiation/Diplomacy—10  
Psychology (native)—20  
Psychology (non-native)—10  
Starship Sensors—20  
Zoology—10

## SPECIALIZATION SKILLS GAINED

### NAVIGATION

Astronomy/Astrophysics—30  
Computer Operation—10  
Computer Technology—10  
Deflector Shield Technology—10  
Electronics Technology—10  
Ship's Weaponry Technology—10  
Starship Combat Tactics/Strategy—20  
Starship Communications Procedures—10  
Starship Helm Operations—20  
Starship Navigation—40  
Starship Sensors—30  
Warp Drive Technology—20

### HELM

Astronomy/Astrophysics—15  
Computer Operation—10  
Computer Technology—15  
Electronics Technology—20  
Ship's Weaponry Technology—20  
Shuttlecraft Pilot—20  
Starship Combat Strategy/Tactics—20  
Starship Communications Procedures—10  
Starship Engineering (general)—10  
Starship Helm Operations—40  
Starship Navigation—20  
Starship Sensors—20

### COMMUNICATIONS

Communications Systems Tech—30  
Computer Operation—20  
Computer Technology—10  
Electronics Technology—10  
Languages (language)—40 total (may be all in one language or spread among several)  
Small Equipment Systems Technology—10  
Starship Communications Procedures—40  
Starship Sensors—10  
Starship Services—10  
Transporter Operational Procedures—10

### ALL DEPARTMENTS

10 skill rolls (1D10) in any skills  
1 bonus skill roll for every 10 points (or fraction) over 50 in INT attribute score. (These must be taken on same skills listed for specialty).



## CADET CRUISE

Upon completing classwork at the Academy, the cadet is sent on a one-year cruise in space, where his performance is evaluated by starship officers. During the cruise, the officer-in-training carries the rank of Midshipman (just below Ensign).

Sometimes, a cadet who completes a year's cruise but has had little opportunity to learn or distinguish him/herself will be required to take a second or possibly even third cruise. This is not unusual or frowned upon, but it is a mark of special achievement to be passed and promoted to full Ensign after only one cruise.

To determine the nature and results of a character's Cadet Cruise, follow the procedure outlined below:

### CADET CRUISE ASSIGNMENT

Roll % dice against the following table, applying the die modifiers shown where appropriate, to determine on which type of ship a character will serve the Cadet Cruise.

less than 15	Starship (Constitution class)
16-25	Exploration Division
26-50	Military Division
51-75	Colonization Division
76+	Merchant Marine Division
<b>Die Modifiers</b>	
-10	LUC 70+
-5	LUC 60-69
+5	LUC 40 or less
-10	INT 70+
-5	INT 60-69
+10	Failed to pass last cruise

### CADET CRUISE RESULTS

Roll % dice and apply the die modifiers as below to determine the results of the character's Cadet Cruise.

Less than 05	Passed with High Honors (Promoted to Lt. J.G -20 1st Post-Academy Assignment roll)
06-15	Passed with Honors (Assigned as Ensign -10 1st Post-Academy Assignment Roll)
16-60	Passed (Assigned as Ensign)
60+	Did not Pass (Repeat Cruise Procedure)
<b>DIE MODIFIERS</b>	
Starship Service (Constitution Class)	-20
Exploration Division	-10
Military Division	-10
Colonization Division	No Modifier
Merchant Marine Division	+10
LUC 70+	-10
LUC 60 - 69	-5
LUC 40 or less	+5
Second (or later) Cruise	+10

## CADET CRUISE SKILLS

A character gains 5 rolls (1D10) for any skills of his choosing when he/she passes the cadet cruises.

### NOTE

A cadet M.D. in the medical specialty area (MEDICINE (NATIVE) skill 40+) who passes the Cadet Cruise is promoted to Lt. J.G. automatically. Such a character, if also graduating with high honors, does not gain another automatic promotion.

## COMMAND

Characters who are to be department heads or top command personnel are required to attend Command School for two years following their Cadet Cruise. At Command School, they will obtain the skills important for holding a position of responsibility and authority over other officers.

(Department heads are defined as the persons holding the following positions: Chief Communications Officer, Chief Engineer, Chief Medical Officer—also referred to as "Chief Surgeon", Security Chief, Science Officer, Chief Navigator, and Chief Helmsman. Top command personnel are a ship's Captain and First Officer.)

At Command School, the character receives the following skill points:

- Administration—30
- Computer Operation—20
- Federation History—20
- Federation Law—20
- Instruction—20
- Leadership—30
- Negotiation/Diplomacy—20
- Starship Combat Tactics/Strategy—20

Graduates of Command School are automatically raised one rank at the end of the two-year period.

## POST ACADEMY EXPERIENCE

Now that the character has been through the Academy and the Cadet Cruise (and Command School, if such is applicable), it is time to put on the finishing touches. The post-Academy experience procedure determines in what areas the character has been assigned before the "current" assignment. (That is, before the game begins).

Naturally, characters in higher positions of responsibility will tend to have more experience in the field. Therefore, these characters will tend to be older and have more skills with higher skill levels. (This is not always true, Captain Kirk being a good example of an exception. However, Kirk is the youngest starship captain in the fleet. His meteoric rise to that post in only a few years is legendary).

Before the game, the gamemaster and players should have determined what position each player's character is supposed to fill and what rank that character will hold. How long it takes to get there depends on the player's success with the post-Academy experience charts.

First, the player must determine how many terms of service have gone between the completion of the Cadet Cruise (or Command School) and the beginning of the adventure campaign. Use the following procedure for establishing terms served:

#### TERMS SERVED

Roll 1D10 and divide by 2 (round down). (Minimum roll allowed is 1.) Add and/or subtract the following modifiers to determine the number of terms served.

#### MODIFIERS

Character is preparing to command a ship (Captain or First Officer)	+2 terms
Character is preparing to be a Dept. Head	+1 term
LUC 60+	-1
LUC 40 or less	+1
INT 60+	-1
Character will enter campaign as an Ensign	-1 term
Lt. JG or Lt.	No Modifier
Lt. Cmdr. or Cmdr.	+1 term
Captain	+ 2 terms
Commodore or above	+3 terms
Character will enter campaign as Dept. Head or top command personnel on board a Constitution class starship	+1 term

(NOTE: This term is served last. Character is automatically placed in the same position as she/he will hold in the campaign, but on a lesser ship. Roll 1D10. On a roll of 5 or less, it is a smaller exploration ship. On a roll of 6 or more, it is a military vessel. The Constitution class starships like the Enterprise are commanded by the best Star Fleet can find. There would be no beginners here.)

#### TERM LENGTH AND ASSIGNMENT

Each "term" served is on a different ship or in a different location such as a starbase. These terms can vary in length from one to five years. The following tables will allow a player to determine what type of vessel each term was served aboard, and how long the character served there.

Much of this information is to fill in the character's background for role-playing. Players and the gamemaster are encouraged to elaborate on this information as much as possible. Perhaps two or more characters in the game have served together before, or a character distinguished herself in some way in a past assignment. Fill in the details! It makes playing the character that much more fun!

This information is also used to determine how old the character is when the game campaign starts. Most students enter Star Fleet Academy at age 18 (doctors at 25). The Academy adds 4 years to this, plus 1 year for each Cadet Cruise taken. If the character went to Command School, add 2 more years. This should give you the character's age at the time service as an officer begins. At the end of the next section, you can add the character's prior service to that total to find out how old the character

is as the game begins. This age is important in determining your final skill rolls.

Complete the following procedure as detailed by the charts:

#### TERM LENGTH AND ASSIGNMENT

Roll 1D10 and divide by 2 (minimum roll=2) for each term of service. This equals the number of years the term lasted before the character was transferred elsewhere. Then roll on the following table to discover where each term was served.

Starship (Const. class)	10 or less
Exploration Division	11-20
Military Division	21-30
Colonization Division	31-60
Merchant Marine Division	61-80
Starbase Duty	81-90
Academy Instructor	91 or more

#### Die Modifiers

INT 70+	-10
INT 60-69	-05
LUC 70+	-10
LUC 60-69	-05

Graduated with HIGH HONORS (1st assignment only)	-20
Graduated with HONORS (1st assignment only)	-10

#### SERVICE SKILL ROLLS

Add up the number of years of service from all terms (not including Academy, Cadet Cruises, or Command School) to determine the number of years spent in service. The character gains 1 skill roll (1D10) per 2 years spent in service, with the following additions:

INT 70+	2 extra rolls
INT 60-69	1 extra roll
LUC 70+	2 extra rolls
LUC 60-69	1 extra roll

per 2 years service aboard starships (Const. class)	1 extra roll
per year as Academy Instructor	1 extra roll in Instruction
per year on starbase duty	1 extra roll in Streetwise, or Gaming
per additional cadet cruise beyond first	1 extra roll in Streetwise, Carousing or Gaming

Now the character is ready to enter the adventure or campaign. Record the character's information on a Character Record Sheet.



## CHARACTER AGING

Some of the physical faculties may start to decline if characters reach advanced ages during the post-Academy experience procedure. Once a character reaches the critical age (listed below, and different for each race), character attribute scores for STR, DEX, and END will begin to fall off.

For each 10 full years the character has lived beyond the critical age, roll 1D10 for each attribute and reduce that attribute by the amount rolled.

Once a campaign has begun, if the gamemaster and players wish to keep track of character ages, they may do so. In this case, a LUC saving roll is made each game-year for aging on STR, DEX and END. If the roll fails, the attribute in question drops one point. In game terms, the aging of characters will not play a big part. In Star Trek's time, many of the troubles of old age have been avoided or postponed by advanced geriatrics. Nonetheless, the rules are included for those who want to use them. If a gamemaster wishes, aging rules can simply be ignored.

CHARACTER RACE	CRITICAL AGE
Human	50
Andorian	85
Caitian	45
Edoan	75
Tellarite	50
Vulcan	110

## ENLISTED MEN

Occasionally, the need may arise to create a non-player character who is an enlisted man (as opposed to an officer, like all player characters). Such persons would be encountered frequently by players on shore leave or at Federation installations.

Although all personnel aboard Constitution class starships are of Ensign grade and above, this is not true of other types of Star Fleet vessels, where enlisted men and non-commissioned officers (those of the rank of Chief Petty Officer and above, but below the rank of Ensign) often outnumber the officers. If a campaign is set on such a vessel, many important nonplayer characters may be "non-coms" or enlisted men.

To quickly create such a character, roll % dice for all attributes of the character. Throw out any result of under 30 and roll that attribute again (except LUC and PSI, which cannot be rerolled no matter how low they are . . . ) and apply normal racial modifier. If an attribute drops below 30 because of racial modifiers, it remains at 30. (Again, this does not apply to LUC and PSI, which may drop to 1, but no lower). Racial modifiers may raise these characters above 99 in an attribute. Enlisted NPCs get no bonus attribute points to distribute.

For all enlisted men, roll 3 skill rolls of 1D10 each on any skills of your choosing. These represent pre-enlisted background or interests. Two skill rolls of 1D10 is then made for each of the following: Computer Operation, Marksmanship (modern), Personal Combat (unarmed).

Ten rolls are then made from among skills in the chosen area of specialty (as listed in the character creation section under Star Fleet Academy). Usually, enlisted personnel will concentrate these rolls in one or two special skills that reflect his or her job.

Non-commissioned officers also receive two 1D10 rolls each in the Leadership and Administration skill areas.

More detailed non-commissioned officer and enlisted personnel character generation will probably be provided in future supplements to this game, as part of a package devoted to the military aspects of Star Fleet. For now, this system will suffice for quick creation of non-player enlisted men.

## RANK AND POSITION--A QUICK DISCUSSION

It is important to denote the difference between rank in star Fleet (Chief Petty Officer, Ensign, Lieutenant, etc.) and Position aboard ship (Transporter Chief, Chief Navigator, Communications Officer, First Officer, etc.) The distinction is an important one in character creation and in other very important game subsystems.

Rank is supposedly a distinction based on experience, ability, and degree of responsibility. Rank crosses all divisional lines in Star Fleet, with the same system of ranks being used by scientist and soldier alike. Rank affects duties performed only in regards to chain of command within your division and the appropriateness to command responsibility of various rank levels in various command positions.

Some specific jobs can only be held by a person of sufficient rank. For instance, the commander of a Constitution class starship must hold the permanent rank of Captain or above. Though an officer of lesser rank may command for a time in the field, an officer must be elevated to the rank of Captain before being given permanent command of such a vessel.

This is not necessarily true of all such positions. A science officer aboard a Constitution class vessel must have the rank of Lt. Commander or above, but on a smaller vessel the position may be filled by a Lieutenant, an Ensign, or possibly even a non-com on a very small ship.



Under general conditions, an officer must take the orders of an officer of higher rank. There are exceptions, however. Orders or tasks given by superior officers that are in direct supervision of your activities (such as Science Officer over science specialists) may sometimes take precedence over orders given by superior officers of other departments. Also, a superior officer's orders may be

countermanded by medical authority or by the next lower officer in chain of command if proof can be shown that said officer is in dereliction of his duty or is unfit mentally or physically for command responsibility. Such cases are extremely rare, however.

When referring to a character in a general sense, he/she is referred to by rank (Lt. Uhura, Ensign Chekov, Lt. Cmdr. Scott).

Position is a measure of immediate responsibility and specific training, and does not in itself convey the privileges of rank. One's position aboard ship denotes what type of duties one performs. Position also affects chain of command, in that officers in certain positions are not eligible to command a vessel no matter what their rank, as long as an officer in an eligible position is available.

The terms "First Officer", "Science Officer", "Transporter Chief", "Yeoman", "Helmsman", etc. all denote positions, not rank. A yeoman, for instance, is a clerical position as an aide to an officer. This is not a position of particularly high responsibility, usually, so lesser ranking personnel will normally be found in it. Janice Rand in the STAR TREK TV series, for instance, held the permanent rank of Ensign and the title or position of Captain's Yeoman. Christine Chapel, also an Ensign, held the title/position of Chief Nurse. Later (in *STAR TREK: The Motion Picture*), both officers had been assigned positions of greater responsibility (Transporter Chief and Medical Officer, respectively), and had also attained rank (Lieutenant) appropriate to such responsibility aboard a major vessel.

A character is referred to by the title of his/her position when dealing with that character's specific responsibilities in that position. Thus Captain Kirk might introduce McCoy as "Chief Surgeon McCoy" or simply "Dr. McCoy" because what McCoy does aboard ship is more important than his rank.

One area of confusion occurs because of the similarity of the rank of Chief Petty Officer and positions such as Transporter Chief, Chief Engineer, etc. Both types of characters may be referred to informally as "Chief Smith", for instance, but the former is a permanent rank, while calling the latter two "chief" is only providing the respect due an officer who has such important responsibilities.

In fact, there is one position that is accorded a special measure of respect — that of commander of a vessel in space. The person in command of a vessel is that vessel's "captain". Such a person, while on board her/his ship or performing duties relating to that ship is always referred to as "Captain Smith", even if the permanent rank is lower. Thus, a small scout ship bearing three or four low-ranking officers is commanded by "Captain Smith" even if the officer Smith is only a Lieutenant! Off the ship, or in general terms, that officer is "Lieutenant Smith". Either way, Smith is still subordinate in rank to Lt. Commanders and higher ranking officers.

Another privilege also peculiar to the captaincy is the fact that it is possible for a lesser-ranking officer to have direct command responsibility over a higher ranking officer, if the lesser ranking officer is "in command" of the vessel. In practice, Star Fleet attempts to avoid assigning higher ranking personnel to duties aboard ships commanded by lower ranking officers, but it can and does

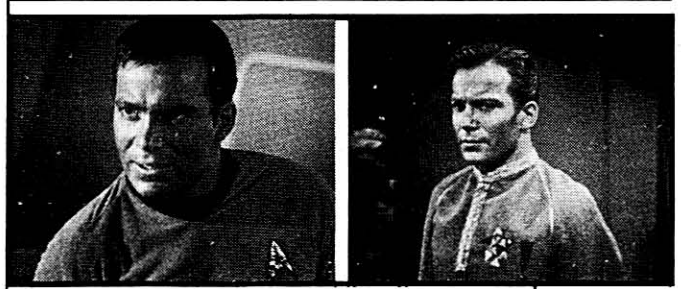

happen from time to time. If so, the "captain" has direct command over the higher ranking officer, if the higher ranking officer has a position subordinate to the captain. This would, then, not grant command control over a visiting admiral, but would give a lieutenant command responsibility over a Lt. Commander if the Lt. Commander were assigned as Science Officer on a temporary basis.

The succession of command responsibility (in the event that the assigned commander cannot fulfill his or her duties) is dependent on neither rank nor position, solely. It depends, rather, on established chain of command. For an explanation, see the chain of command notes in the section on Star Fleet organization.

One final note: the term "Mister" in naval parlance is neither a mark of rank or position. Any commissioned officer may be referred to in a general sense as "Mister". This is used by a lesser ranking officer as a term of respect, or by a higher ranking officer as a formal or informal mode of address. It is never used for someone who has a medical degree. (Thus, always "Dr. McCoy", never "Mr. McCoy"). It is also never used for the commander of a star vessel while in active pursuit of those duties, no matter how high-ranking the officer speaking.

A higher ranking officer may call a lower ranking officer simply "Mister", leaving off the name entirely, but this form of address is usually reserved for reminding the officer addressed of his subordinate status. (An annoyed Kirk might snap, for instance, "Get us back on course, Mister, and right now!")

"Mister" is a term used across sexual barriers as well. Thus, a female officer is never referred to as "Miss Uhura" or "Ms. Chapel" except very informally. If the term "Mister" used to address a woman is annoying or undesired by either the officer speaking or the officer being addressed, the rank or title is substituted. Thus, while Uhura was always called "Lt. Uhura" on the TV series, and Christine Chapel was always called "Nurse Chapel", Lt. Saavik in *The Wrath of Khan* was referred to as "Mr. Saavik". The usage for women is a matter of personal preference.



Starship (Const. class)  
 Exploration Division  
 Military Division  
 Colonization Division  
 Merchant Marine Division  
 Starbase Duty  
 Academy Instructor  
 Passed  
 Honors  
 High Honors

**CADET CRUISE**

1st Cruise										
2nd Cruise										
3rd Cruise										
4th Cruise										
5th Cruise										
6th Cruise										

**SERVICE EXPERIENCE**

1st Term										
2nd Term										
3rd Term										
4th Term										
5th Term										
6th Term										
7th Term										
8th Term										
9th Term										

Term Length

CHARACTER		
PLAYER		18
RANK	AGE	17
RACE	SEX	16
CURRENT ASSIGNMENT		15
SPECIALIZATION AREA		14
Marksmanship (modern)		13
To Hit Modern		12
Personal Combat (unarmed)		11
To Hit H-T-H		10

STR	END	INT	DEX	CHA	LUC	PSI
-----	-----	-----	-----	-----	-----	-----

- |                                |                                |                               |
|--------------------------------|--------------------------------|-------------------------------|
| Administration . . . . .       | Mechanical Eng. . . . .        | Starship Sensors . . . . .    |
| Atmosphere Craft Pilot. _____  | Medicine . . . . .             | Starship Services . . . . .   |
| Astron./Astroph. . . . .       | Negot./Diplomacy . . . . .     | Streetwise . . . . .          |
| Botany . . . . .               | Personal Wpn. Tech . . . . .   | Trans. Op. Proc. . . . .      |
| Carousing. . . . .             | Prs. Comb. (Ar.) _____         | Trans. Systems Tech . . . . . |
| Commun. Sys. Tech. . . . .     | Physical Chem. . . . .         | Vocal Music . . . . .         |
| Comp. Arch. _____              | Physics . . . . .              | Trivia _____                  |
| Computer Operation . . . . .   | Planetary Ecology . . . . .    | Water Vehicle Op. . . . .     |
| Computer Tech. . . . .         | Planetary Survival . . . . .   | Warp Drive Tech. . . . .      |
| Def. Shield Tech . . . . .     | Psych. _____                   | Zero-G Operations. . . . .    |
| Electronics Tech . . . . .     | Rac. Clt./His. _____           | Zoology. . . . .              |
| Env. Suit Operations . . . . . | Ship's Weaponry Tech . . . . . | _____                         |
| Federation History . . . . .   | Shuttlecraft Pilot. . . . .    | _____                         |
| Federation Law. . . . .        | Shutt. Sys. Tech . . . . .     | _____                         |
| Gaming . . . . .               | Sm. Eq. Sys. Tech . . . . .    | _____                         |
| Geology. . . . .               | Small Unit Tactics . . . . .   | _____                         |
| Grav. Veh. Operation . . . . . | St. Cmbt. Tac./Str. . . . .    | _____                         |
| Instruction. . . . .           | St. Comm. Proc. . . . .        | _____                         |
| Inst. Music _____              | St. Comm. Proc. . . . .        | _____                         |
| Lang. _____                    | St. Engrg. (General) . . . . . | _____                         |
| Leadership. . . . .            | Starship Helm Op . . . . .     | _____                         |
| Life Sup. Tech . . . . .       | Starship Navigation . . . . .  | _____                         |
| Marks (Arch.) _____            | Starship Security. . . . .     | _____                         |

18
17
16
15
14
13
12
11
10
9
8
7
6
5
4
3
2
1

# Skills and Skill Levels

The relative competence of an individual character in a given field of endeavor is measured by his skill level in that area. Skill levels, like attribute levels, run in a range of 1 to 100 points. In the case of skill levels, however, 100 is an attainable ideal. No skill level in this game is allowed to be higher than 99.

Saving rolls are made against skill levels much as they are made against attribute levels when attempting an action which requires the use of that skill. These rolls need not be made for routine use of the skill, however. Lt. Uhura, for instance, need not roll % dice every time she opens a hailing frequency. Instead, a minimum skill level of 10 indicates competence in an area for routine matters. For a character to handle routine matters in an area where the necessary skill level is less than 10, make a saving roll using one 10-sided die (not % dice). If the roll is over the skill level, the attempt fails and something goes wrong. Someone attempting to do something he/she has no skill for may botch it entirely, but should get a LUC saving roll and/or INT saving roll to figure it out anyway.

The levels of skill above 10 come into play when asked to perform unusual actions requiring skill or experience in an area. For instance, if Lt. Uhura is asked to open a hailing frequency, in the face of an ion storm which is making communication difficult, she may be asked to make a saving roll against her STARSHIP COMMUNICATIONS PROCEDURES skill level. If her communications panel loses power due to a Klingon near miss with a disruptor bolt, she may have to make a saving roll on her COMMUNICATIONS SYSTEMS TECHNOLOGY skill level.

Skill levels between 10 and 20 usually indicate familiarity with both routine practice and basic theory of an operation in the subject being dealt with. Scores between 20 and 50 indicate increased experience with the skill area. A score of 50 or above denotes the character as an authority on the subject, with greater-than-normal knowledge and ability.

Skills are gained and increased as a part of the character creation process. Skill levels are given for the major STAR TREK characters, as well as for typical people in certain areas, in the "Familiar Characters" section of this book.

Once play has begun, skills may increase with use. After each adventure scenario, or each major mission of a continuing campaign, the gamemaster should have each player who saw action make a saving roll against his character's INT score. If the roll is successful, the player may roll 1D10 and add the resulting number of hits to his skill level in any one skill he possesses that was used during the course of the adventure.

Gamemasters are encouraged to give a few bonus points (maximum of 3) in a skill to a player who pushes his skill to the limit in the course of an adventure (that is, makes a difficult saving roll), thus learning something in the process. Extra points should also be awarded to anyone who has the opportunity to closely observe someone of a higher skill level engaged in skill-related activity of a more

routine nature. To get this bonus, however, the person who is teaching (not the one receiving the extra skill points) must make a saving roll on his or her own INSTRUCTION skill. If the saving roll is failed, no skill is gained by watching.

Gamemasters should also provide the player characters with the opportunity to gain new skill levels. Between adventures, a player should have a chance to make a saving roll vs. INT score to gain 1D10 of points in a brand new skill. This roll should only be made when the player specifically requests to devote time to learning something new, and it should be a bit harder to make this die roll. Adjust the roll by adding 20 to the score on the die, thus making it more difficult to roll equal to or below one's INT score.

In fact, gamemasters may adjust any skill saving roll in the same manner (and with the same constraints) as with attribute saving rolls, to allow for harder and easier tasks. And a gamemaster must not be afraid to rule that no roll at all is allowed if the action a player wants to perform is clearly impossible, or highly improbable, for someone of his expertise and capability. (Remember to allow for a LUC saving roll at crisis points, however).

The following list of skill areas is not exhaustive. Gamemasters are encouraged to devise additional skill areas to fit their own campaigns and own tastes. (Send any good ideas you come up with to the designers, care of FASA; we may be able to use them in later supplementary material. All material we use will be acknowledged in print!) If a new skill is developed, the gamemaster may wish to assign a certain level in this skill to some player characters (or non-players) if it is reasonable that they would have some knowledge in this area. If this is the case, do so, even if the player characters had no opportunity to learn it in the character generation system. (Once again, if there are new skill areas gamemaster and players feel should be part of the Academy procedure, adapt them and let us know the results for future reference!)

Most of all, gamemasters should not allow skill level increases to become too easy, or allow skill levels to rise too quickly and too cheaply. Remember that skill levels above 40 or 50 are (or should be) hard to attain—the result of intensive study and experience. Also note that it will be very rare indeed—almost unheard of—for player characters using the character generation system in the game to ever gain skills and levels to rival the foes listed in the familiar characters section for such persons as Kirk, Spock, McCoy and the like.

After all, the heroes of STAR TREK are semi-legendary figures—the best of the best. If players in your campaign are rivalling the top echelon Enterprise personnel, either your campaign has been going on a very long time, or you are giving out points much too freely. Feel free to bend the rules—even the rules on when to give rolls for new skill points just given—when necessary to maintain some semblance of play balance and game integrity.



## SKILL AREAS -ALPHABETICAL LISTING

Administration  
Atmosphere Craft Pilot  
Artistic Ability (form)  
Astronomy/Astrophysics  
Botany  
Carousing  
Communications Systems Technology  
Comparative Archeology (race)  
Computer Operation  
Computer Technology  
Deflector Shield Technology  
Electronics Technology  
Environmental Suit Operations  
Federation History  
Federation Law  
Gaming  
Geology  
Ground Vehicle Operation  
Instruction  
Instrumental Music (instrument)  
Languages (language)  
Leadership  
Life Support Systems Technology  
Marksmanship (archaic) (weapon)  
Marksmanship (modern)  
Mechanical Engineering  
Medicine (race)  
Negotiation/Diplomacy  
Personal Combat (armed) (weapon)  
Personal Combat (unarmed)  
Personal Weapons Technology  
Physical Chemistry  
Physics  
Planetary Ecology  
Planetary Survival  
Psychology (race)  
Racial Culture/History (race)  
Ship's Weaponry Technology  
Shuttlecraft Pilot  
Shuttlecraft Systems Technology  
Small Equipment Systems Technology  
Small Unit Tactics  
Starship Combat Tactics/Strategy  
Starship Communications Procedures  
Starship Engineering (general)  
Starship Helm Operation  
Starship Navigation  
Starship Security  
Starship Sensors  
Starship Services  
Streetwise  
Transporter Operational Procedures  
Transporter Systems Technology  
Trivia (category)  
Vocal Music  
Water Vehicle Operation  
Warp Drive Technology  
Zero-G Operations  
Zoology

Some skills require developing a different skill level in a number of separate divisions. These skills have the areas of division noted in parentheses (like this). Examples are medicine, which has a different skill division and different level required for each racial type (Humans, Vulcans, etc.), and Personal Combat (armed) which requires a different rating for each weapon type. Sometimes, skill in one division may confer a smaller level of skill in another automatically. See the individual skill explanations for details.

## SKILL EXPLANATIONS

### ADMINISTRATION

The ability to keep records and manage a hierarchy. This is essential for most department heads and anyone who has responsibility over the actions of a number of people.

### ATMOSPHERE CRAFT PILOT

Skill with any and all modern (in STAR TREK's time) aircraft. ½ this skill level may be applied to operation of archaic aircraft such as biplanes and helicopters. If a character wishes to specifically develop skill with ancient aircraft (as a hobbyist, for instance, pre-academy), the character should choose "Ancient Aircraft" as a category of the trivia skill and develop at least 10 points in that trivia area. The character will then be able to apply full ATMOSPHERE CRAFT PILOT skill to ancient aircraft.

### ARTISTIC ABILITY (FORM)

Those choosing this skill must specify what type of artistic endeavor is practiced. This may be recognized fine art, such as sculpting or something more esoteric, such as zero-G ballet. Instrumental and vocal music are widely practiced, so they have separate skill areas.

### ASTRONOMY/ASTROPHYSICS

A much more exacting science in STAR TREK's time, including stellar growth and decay, planetary ballistics, etc.

### BOTANY

Encompassing both terrain and extra-terrestrial botanical studies and including microbiology.

### CAROUSING

The fine art of drinking, bar-hopping, gambling and chasing each other around. When Star Fleet personnel get shore leave, look out! Use this skill for saving rolls on having a good time, and average it with END for determining how well a character can hold his Saurian Brandy.

### COMMUNICATIONS SYSTEMS TECHNOLOGY

The technical skills and knowledge involved in modern communications, including log recordings, message buoys, personal communicators, and sub-space communications. Also used to recognize such ancient communications methods as radio and television signals.

### COMPARATIVE ARCHEOLOGY (RACE)

A study of the ancient history, cultures, and lifestyles of a particular race or planet. Each race or culture studied must be specified and developed separately. A character is considered to have an automatic skill level of 10 in the archeology of his home planet.

When studying a race similar to the one the player has knowledge of, he may apply ½ of his Comparative Archeology skill to discover how environmental and technological factors would influence the development of that culture. Thus a player could hypothesize on how the introduction of high tech weapons would cause the culture to diverge from its normal development.

### COMPUTER OPERATION

Very important in Star Fleet, as computers are used to analyze data for nearly all purposes. Kirk is competent in this, but Spock, McCoy, and Uhura are all very skilled here, each for different reasons. This represents the ability to get the information you want from a ship's computer banks. In the case of the Enterprise and her sister ships, the computer's memory banks are very extensive indeed. Just about any encyclopedic bit of knowledge one needs is there, but a saving roll on COMPUTER OPERATION skill should be needed to ask the right questions to find obscure pieces of data, using various types of tricorder. (Interpreting this data may require a specialist. See tricorder entries in the equipment section of this rule set.)

### COMPUTER TECHNOLOGY

Unlike the COMPUTER OPERATION skill, this skill is geared toward the technical side of computers—how to design, build, and most importantly to players, repair them. Dr. Richard Daystrom, designer of the M5 computer (*The Ultimate Computer* episode of STAR TREK) would probably rank about 98 in this skill. The person who programmed the Enterprise computer's female voice (which called Kirk "dear" in early episodes) probably needed to add to this skill, at least from Kirk's point of view.

### DEFLECTOR SHIELD TECHNOLOGY

Repair and maintenance of the devices that produce a ship's protective screens, which protect it from stray meteors and space junk as well as energy and missile attacks in combat. This skill also covers the technology behind tractor and pressor beams.

### ELECTRONICS

A general skill area encompassing any and all electronics work. This can be applied at ½ level to saving rolls in any of the specialized electronics technology not possessed by the character, or to any area not specifically covered by another skill. Also useful for developing new electronic devices.

### ENVIRONMENTAL SUIT OPERATIONS

Knowledge of the functions of an environmental suit. Used by Star Fleet personnel for work in hostile environments. Also knowledge and experience in performing normal work in these suits. A player's skill here should be used as a saving roll when attempting to perform any

delicate task while wearing an environmental suit. This skill area also covers use of the life support belt sometimes worn by Star Fleet personnel (See equipment lists.)

### FEDERATION HISTORY

Knowledge of the history of the United Federation of Planets, including significant dates, people, and events in the development of that organization, and its military history.

### FEDERATION LAW

Rules and regulations of the UFP, including the non-interference directive (Prime Directive) and the regulations of Star Fleet. Also knowledge of the laws of all Federation-member planets and cultures.

### GAMING

Knowledge and experience at games of skill, including three-dimensional chess (and perhaps Fizzbin as well).

### GEOLOGY

The study of rocks and minerals, and of planetary tectonic structure. Useful for detecting harmful (or useful) ores, finding dilithium crystal deposits, discovering planetary structure instability or volcanic tendencies when reading sensor-gathered information, etc.

### GROUND VEHICLE OPERATION

In scope, much like ATMOSPHERE CRAFT PILOT skill, including handling of archaic ground vehicles. (In the matter of archaic ground vehicles, we may note that Kirk's skill level here is not very high, and perhaps non-existent. See the episode *A Piece Of The Action* for details).

### INSTRUCTION

This skill area is important if one is to pass on knowledge of others. It is necessary for a player character to have this skill for that character to teach skills he knows to other player characters during or between adventures. (See skill rules earlier in this section.)

### INSTRUMENTAL MUSIC

This skill shows expertise in playing a musical instrument. Many of STAR TREK's central characters were musically inclined. Spock played the Vulcan harp (which Uhura also learned to play), and Scotty is an accomplished player of traditional Scottish bagpipes. An instrument (like bagpipes) or a general class of instrument (keyboard instruments) must be specified.

### LANGUAGES (LANGUAGE)

This skill area covers both terrestrial languages and alien languages. It can even be extended to ancient written languages, or languages that are so non-human like as to be not even sound-based (flashing lights, waving tentacles, etc.), where the communicator must use mechanical devices to convey information. Even with the use of the universal translator device in Star Fleet, people will still learn, and be fascinated by, languages. Each language learned requires a separate skill level record. One is considered to have a skill level of 99 in one's own tongue. In addition, all Star Fleet personnel have an automatic skill level of 90 in the standard



Federation language, if it is not native to them. (This language is native to many humans). The standard Federation language is translated to and treated as English in the TV series and in this game.

#### LEADERSHIP

Perhaps one of the most important skills on the list, especially for those who aspire to command. Leadership is averaged with the CHA attribute for saving rolls made when attempting to sway a crowd or lead a group of people you are not used to commanding. (For influencing a small group of professionals, or an individual, use the NEGOTIATION/DIPLOMACY skill level).

#### LIFE SUPPORT SYSTEMS TECHNOLOGY

Operation, repair, and modification of life support machinery, both on board ship and as landing party equipment (such as environment suits and life support belts). Those possessing this skill may also be called to repair and modify medical life support equipment, such as that used by Star Fleet medical personnel on board ship during surgery.

#### MARKSMANSHIP (ARCHAIC) (WEAPON)

This skill area encompasses all ancient (in STAR TREK terms) projectile weapons, including everything from slings through crossbows to 20th century firearms. Each weapon type (like crossbows, pistols, rifles, etc.) must be specified separately.

#### MARKSMANSHIP (MODERN)

Modern marksmanship covers all types of Star Fleet issue weaponry, plus the similar types carried by Klingons, Romulans, and other known races. There is no need to specify individual types, as one of these weapons works very much like another as far as aiming and firing are concerned. For unfamiliar weapons, use  $\frac{1}{2}$  this skill level to determine accuracy until basic familiarity is gained.

#### MECHANICAL ENGINEERING

This general skill class describes the knowledge of mechanical (as opposed to electronic) devices. Saving rolls on this skill would be used to rig a temporary airlock, make field repairs to a ground vehicle with a damaged gear box, etc.

#### MEDICINE (RACE)

A skill level of 10 in medicine confers the ability to perform advanced first aid and paramedic-style help. For the level of knowledge possessed by a trained nurse, a level of 20 is needed. Skill levels of 40 and above are the equivalent of a degree in medicine. Although a separate skill level must be maintained for each separate race, someone who has competence in medicine for human-like races (including Vulcans, Romulans, Klingons, and all other character races) may make saving rolls when working on both at  $\frac{1}{2}$  his level. This skill also includes use of medical tricorder.

#### NEGOTIATION/DIPLOMACY

Another very important skill. This skill is averaged with the CHA attribute (in much the same way as the LEADERSHIP skill) for saving rolls in an attempt to influence a small group (like a planetary council) or an individual (like an ambassador). Generally, non-player characters cannot be induced to change their minds drastically without motivation. (It is doubtful that even Kirk could talk a Klingon into being nice to small animals and children, for instance), but in making a first impression in a dubious official or recalcitrant native, it is a most vital talent.

#### PERSONAL COMBAT (ARMED) (WEAPON)

This skill is similar to the MARKSMANSHIP (ARCHAIC) skill, but for hand weapons used in personal combat. Each class of weapon (sword, club/mace, etc.) must have a separate skill level developed.

#### PERSONAL COMBAT (UNARMED)

Simulating all unarmed combat styles (judo, karate, boxing, etc.), this skill is all-inclusive, not requiring separate skill level designations. This skill provides a modification to damage done in hand-to-hand combat. (See combat section).

#### PERSONAL WEAPONS TECHNOLOGY

This is the skill needed to repair and modify personal weapons such as phasers.

#### PHYSICAL CHEMISTRY

Chemical analysis and synthesis, and laboratory techniques. This skill is used to analyze unknown substances, both in the field and on board ship.

#### PHYSICS

Knowledge in the areas of the laws of motion and thermodynamics, including nuclear physics and the theory behind warp drive and matter/antimatter engines.

#### PLANETARY ECOLOGY

The study of interaction among life forms in a planetary environment. This skill is most useful to landing parties among possible dangerous flora and fauna.

#### PLANETARY SURVIVAL

The skills needed to survive under extreme conditions planetside are covered under this area. Lt. Sulu got a quick course in this area in the field, in the episode *The Enemy Within!*

#### PSYCHOLOGY (RACE)

As with MEDICINE,  $\frac{1}{2}$  the skill level developed with any human-like race is applicable for saving rolls for other human-like races. Races must be specified and skill levels kept separately. Someone with a psychology skill level of at least 30 may operate and interpret data from the psychotricorder.

### RACIAL CULTURE/HISTORY (RACE)

This skill area is intended for characters who wish to learn about interstellar cultures other than their own. A character automatically possesses a skill level of 50 in this area for his own native culture.

### SHIP'S WEAPONRY TECHNOLOGY

This covers both phaser weaponry and photon torpedoes, allowing the character to repair and do maintenance on such devices.

### SHUTTLECRAFT PILOT

A skill level of 10 indicates minimum competence to operate the standard shuttlecraft used by Star Fleet and carried on many larger ships. In practice, however, this type of duty is rarely assigned to any character with less than a skill level of 20. Higher skill levels are helpful in operating the shuttle under arduous conditions, or running special purpose shuttles, such as the aquashuttle sometimes used on starships calling at water worlds. (Using the aquashuttles requires a minimum 10 point skill level in water vehicle operation).

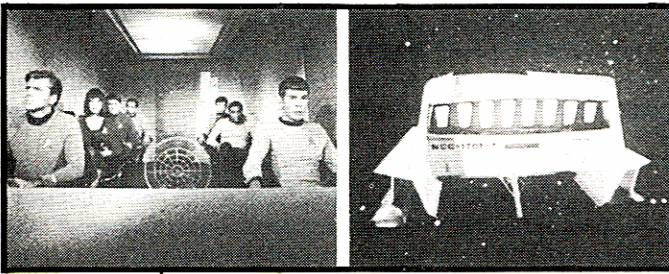

### SHUTTLECRAFT SYSTEMS TECHNOLOGY

The necessary skills for supporting, maintaining, and repairing standard and special purpose shuttles. It was knowledge in this area, possessed by Mr. Scott, that got the Galileo Seven off the ground in the episode of that name.

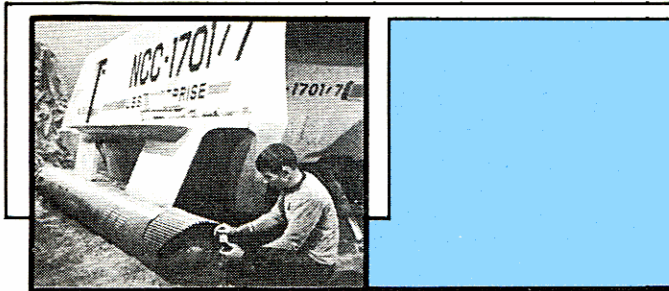

### SMALL EQUIPMENT SYSTEMS TECHNOLOGY

The ability to repair small hand-held equipment such as communicators, tricorders, universal translators, etc. It was this skill that was in play when Spock converted crystals in a subcutaneous transponder into a crude laser (*Patterns of Force*).

### SMALL UNIT TACTICS

Knowledge of military and/or police tactics used in small skirmishes or commando actions. Useful for security personnel or anyone commanding a landing party in a hostile area. Use saving rolls on this to determine if a character can set up effective defenses or command a boarding party.

### STARSHIP COMBAT TACTICS/STRATEGY

This skill area refers to knowledge and experience in commanding a ship in battle. Those choosing to develop this skill can be considered to be familiar with the great space commanders and battles throughout Federation history, and have probably spent many hours in simulation runs recreating these battles and fighting hypothetical enemies, even if they have not participated in a real space battle as a commander. Captain James Kirk has developed this area practically to the limit, and is considered by Star Fleet to be one of the finest military commanders ever known in space, second only to Garth of Izar. This skill affects play during the starship combat system presented in this set of rules.



### STARSHIP COMMUNICATIONS PROCEDURES

Remember those hailing frequencies Lt. Uhura always opens? This skill covers knowledge of those frequencies and how to use them, plus Federation codes, operation of communications equipment, and other standard and emergency communications procedures of Star Fleet.

### STARSHIP ENGINEERING (GENERAL)

This general area skill encompasses knowledge of starship construction—bulkheads, decks, stresses and strains, hull repair, etc. Saving rolls would be made on this skill area for damage control, rerouting power from one area to another, and other non-specific engineering functions. This also covers any specific engineering function not already dealt with by a specific skill area.

### STARSHIP HELM OPERATION

Skill with the actual controls for warp and impulse engines that steer a starship, plus other helm-based controls. This skill area also includes knowledge of standard orbits, (and how to establish them), evasive maneuvers, battle maneuvers, etc.



## STARSHIP NAVIGATION

This is the other half of taking a starship from one place to another. Helm does the steering and navigation points the way. This skill area controls star mapping and plotting courses through space. It takes a navigator to know where a ship is, where it is going, and how soon it can expect to get there. Navigation skill is also necessary for plotting intercept courses with another vessel or object, or other special maneuvers of a ship in space.

## STARSHIP SECURITY

Knowledge of ship security procedures, including alert status, repelling boarding parties, controlling and confining prisoners, and supplying protection to VIP passengers.

## STARSHIP SENSORS

Operation of the probing ship's sensors, which can detect life and energy sources in other ships and on planetary sources. This skill is important in battle, or before sending a landing party down to an unknown planet. The ship's sensors also provide planetary gravity and climate data from standard orbit and detects moving objects at long range likely to pass near a ship.

## STARSHIP SERVICES

This covers all the red-uniform jobs not covered by other skills including food service, clerical, and administrative duties. This skill would be important for a captain's yeoman, and desirable for anyone wishing to know more about how the ship's crew functions.

## STREETWISE

This skill isn't really taught at the Academy—you get knowledge in this area only by interaction with people on shore leave planetside. A character with high levels in this skill can find what he wants in port, whether it be an illegal gambling parlor or a contact with information about what ships have been in or out of port in the last two months. Streetwise characters know how to fit in with the natives in Federation ports, and know how to move in the back alleys and back rooms. Scotty and Dr. McCoy are well equipped in this area. Kirk is less so, but he can manage. Spock, however, seems to possess no street savvy at all (which is understandable, given his background).

## TRANSPORTER OPERATIONAL PROCEDURES

When Dr. McCoy complains about "scattering his atoms all over the universe" he is at least hoping the person running the transporter has a high level in this skill area. Anyone with a skill level of at least 10 in this field can run the transporter for routine matters, but the higher skill levels are vital when you need a quick lock-on and beam-up, or when atmospheric conditions or other hazards make beaming difficult, or when trying to be extremely precise about transporting, such as transporting into an unknown area via sensor readings only, or when intra-ship beaming, as was done in the episode *Day of the Dove*.

## TRANSPORTER SYSTEMS TECHNOLOGY

When something goes wrong with the transporter (as it so frequently seemed to do in the series), this is the skill required to fix it. It took a high level of skill in this area to find the flaw that split Kirk into two beings in *The Enemy Within*. Saving rolls in this area will have to be made whenever correcting a transporter malfunction, or modifying transporter circuitry for a special purpose.

## TRIVIA (CATEGORY)

This is the catch-all category for any specialized knowledge not covered by other skills. Categories chosen for trivia must be well defined and not too general. (One could not have a trivia skill in "Literature", for instance, but might have one in "Earth poetry" or "Vulcan mating rituals"). Trivia categories are intended so players can individualize their characters, giving them depth by establishing hobbies and interest for them. The gamemaster should encourage imagination when choosing trivia skill areas. (An expert on 20th century television programs who went around quoting them all the time would be interesting). However, the gamemaster should not allow skills under trivia that would unbalance the game. Each separate trivia skill must have its category defined and a separate skill points record kept for it.

## VOCAL MUSIC

Lt. Uhura has a very high skill level here. Perhaps not useful in battle, but who knows what will be important when exploring strange new worlds?

## WATER VEHICLE OPERATION

Like GROUND VEHICLE OPERATION and ATMOSPHERE CRAFT PILOT, this skill area encompasses modern (in STAR TREK's time) water borne vehicles. Ancient vehicles can be operated at ½ this skill level (unless a trivia skill of at least 10 in ancient water vehicles is known). Also, some knowledge in this area is needed for operation of the Federation Star Fleet's aquashuttle used for landing on water worlds.

## WARP DRIVE TECHNOLOGY

Knowledge of matter/antimatter mix formulas, cold starting the engines in emergencies, and warp drive maintenance and emergency repair.

## ZERO-G OPERATIONS

This skill is necessary for making repairs outside a ship in space, and also for engaging in zero-g combat. In the latter case, average the appropriate combat skill with the ZERO-G OPERATIONS skill to arrive at a skill level for zero-g combat.

## ZOOLOGY

The study of animals, including both terrestrial and non-terrestrial beasts.

# Combat and Tactical Movement

When interaction that might lead to man-to-man combat is necessary, **STAR TREK: The Role-Playing Game** uses tactical movement/combat system based on a grid of ½ inch squares. Each square represents an area of 1.5 meters on a side. All maps of buildings, ship interiors, exterior areas, etc., will be done on this type of grid. Counters placed in these squares and moved on the square grid represent the characters themselves. (Miniature metal figures may also be used, if available).

Each turn of movement and action in this tactical system represents 10 seconds of game time. During this time a character may move, fire a weapon, or take other action according to his/her capabilities.

## FACING

When on the grid, each counter must be placed so that it occupies only one square, as shown below. Facing affects combat, so it is important that all counters be placed correctly. (The front of a counter is the side nearest the head of the figure.)

An imaginary line drawn outward from the counter as shown is the boundary between what is in front and what is to the rear of the counter. (See diagram at right.)

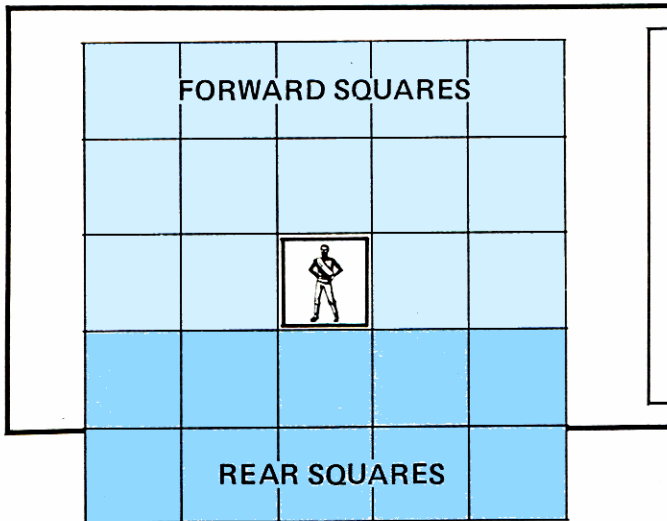

## PLAY SEQUENCE

At the start of each turn, each side determines which character on the side has the highest DEX. (If using the tactical system as part of a campaign or role-playing scenario, the gamemaster will do this.) These are then compared and the side having the man with the highest dexterity has the choice of acting first or second that turn. (On a tie, opposing players or the gamemaster roll one die each, with the choice going to the highest roll.)

The player or side moving first chooses which character to begin with. (This need not be the highest DEX character.) This character performs any normal actions, as per the rules for action points below. The second player or side then chooses a character and completes those actions.

In a campaign situation, where the players are acting as a group (such as a Federation landing party) the gamemaster is playing the other side. It is even possible that there may be three or more sides, in which case there will be a three (or more) way rotation of play.

Play alternates, one character at a time, until one side or the other has no more characters who wish to act. If the other side still has characters, they may then complete their actions, one character at a time.

Each character may perform actions only once during the turn (Exceptions: See OPPORTUNITY ACTIONS).

After all characters have moved, the gamemaster notes the end of the turn. Play then starts over again for the next turn as before. Note that the player with the highest DEX must be newly determined each turn, as it may change due to DEX adjustments, death or unconsciousness of a character, etc.

## MOVEMENT RESTRICTIONS

Barring obstacles such as walls and furniture, figures may move through any square, with the following exceptions.

At the end of any given character's turn, there may be no more than four figures in the same square. Figures may be freely moved through any group of friendly figures, but may not end the turn in a square where doing so would stack more than four figures.

A figure which moves into a square with one or more enemy figures must stop if the enemy wishes to initiate combat. It is the responsibility of the enemy player to tell the moving figure to stop if combat is desired. If a figure ends the turn in a square with one or more enemy figures, the enemy may initiate personal combat on his turn, or using an opportunity action.

An enemy figure who stops a figure from moving through a square need not expend the action points to make a personal combat attack! The figure simply may deny passage without actually making an attack, even if the enemy figure denying passage has no AP left!

If a figure is denied passage through a square containing enemy figures, that figure's movement must end in that square immediately, but action points may be used to perform other actions than movement. If before the end of the turn all enemy figures who wish to block movement can be killed, rendered unconscious, or removed from the square, movement may be resumed with whatever AP the figure has left. (See discussion of Action Points below).



## ACTION POINTS

At the beginning of each turn each character has a given number of action points (AP) as determined by the following formula:

DEX divided by 10 (rounded down) + 4 = Action Points. Example: Lt. Sulu has a Dexterity of 87. 87 divided by 10 equals 8.7 which we round down to 8. Add 4 equals 12 AP.

Remember to always round down before adding 4. That is, drop the remainder or fraction in the division.

Every action a character is to perform costs a set number of AP. These costs are given below in table form, then explained in detail.

Each player must keep track of his character's AP usage. The character sheet has an ACTION POINT TRACK numbered 0 through 20. At the start of each turn, each player places an "Action Points" counter on the number of AP his character has. As actions are performed, this counter is moved to reflect the number of AP expended.

EXAMPLE: Lt. Sulu has a DEX of 87. Therefore he has 12 on his AP track. He moves 7 squares first so his AP counter is moved 7 spaces, now resting on the 5. He has 5 AP left to expend in his current turn.

When the marker is on 0, the character may perform no further actions that turn. AP may not be saved from turn to turn; any not used are lost. The character may wish to save some, however, for opportunity actions later in the same turn, if he thinks he may have to perform some.

## OPPORTUNITY ACTIONS

Actions may normally only be taken during the character's turn unless the action is an allowable opportunity action. Opportunity actions may be taken at any time, even during an opposing player's turn or before the character's own turn has come, as long as the character has enough AP left to do so.

EXAMPLE: Sulu ended his turn a moment ago with 5 AP left. After he finishes, the gamemaster moves a Klingon guard into view. Sulu decides he wishes to kneel behind a console and fire his phaser. Each of these are opportunity actions and cost 1 AP each.

A player announces an opportunity action at any time. The player who is completing his turn at that time must halt his actions long enough for the opportunity action to be executed.

EXAMPLE: The Klingon guard in the example above was moving down a corridor when Lt. Sulu spotted him. The Klingon intended to move 7 squares, but the player operating Sulu says "O.K., stop after 3 squares. I'm kneeling and firing!" This is two opportunity actions. The Klingon stops at the third square, and Sulu kneels (1 AP expended on the track). The Klingon may, if he wishes, stick an opportunity action of his own in at this moment (like moving an extra square). At this point, Sulu can force a stop for his second opportunity action, firing his phaser (1 more AP down). Once the shot is resolved, the Klingon may continue his turn (if he isn't stunned into unconsciousness.) He may continue to move, or change his mind and fire back at Sulu instead, if he has enough AP to do so. Remember, all actions are done one at a time.

## ACTION POINTS TABLE

<b>Movement</b>	
Move 1 square orthogonally (straight)	1
Move 1 square diagonally	1½
Move and evade 1 square orthogonally	2
Move and evade 1 square diagonally	3
Turn in place (only)*	1
Crawl 1 square orthogonally	2
Roll sideways (in prone position)*	2
Crawl 1 square diagonally	3

### SPECIAL MOVEMENT NOTES

Swimming—twice normal AP—no other actions

Climbing stairs—twice normal AP

Climbing ladder—twice normal AP—DEX save for other action

Climbing rope—3 x normal AP—DEX save for other action

If running full speed (no other action during the turn) DOUBLE the available AP for the turn for purposes of movement ONLY. (Running speed is faster than normal combat movement speed). If running 2 turns in a row, and for every subsequent uninterrupted turn of running, the character must make a fatigue saving roll. (See fatigue rules under Damage).

<b>Position change</b>	
Stand to kneel (and reverse)*	1
Kneel to prone (and reverse)*	1
Dive to prone*	2
Dive roll (evade—from stand to kneel or from kneel to prone)*	4
Stand to sit (and reverse)	1

<b>Weapon and equipment use</b>	
Draw weapon (or device) and ready	2
Fire ready weapon/throw weapon*	1

<b>Reset weapon setting</b>	
Reload weapon	2
Short communication (one sentence)*	1
Operate familiar device*	2
Aim weapon	2

<b>Personal combat</b>	
Parry blow*	2
Personal combat attack (with or without ready weapon* all remaining (min. 3)	
Flying tackle (must move 3 sq. directly towards opponent) all remaining (min. 4)	

\* DENOTES POSSIBLE OPPORTUNITY ACTION



## ACTION POINTS EXPLANATIONS

### MOVEMENT

**MOVE 1 SQUARE ORTHOGONALLY (STRAIGHT)—1 PT.**  
AS SHOWN AT RIGHT

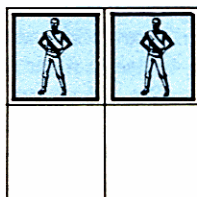

**MOVE 1 SQUARE DIAGONALLY—1½ AP**  
AS SHOWN AT RIGHT

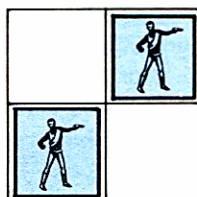

**EXAMPLE:** Combining orthogonal (straight) and diagonal movement. Numbers are cumulative expenditure.

		2½	3½		5
0	1	AP points		6½	

**MOVE & EVADE 1 SQUARE ORTHOGONALLY (STRAIGHT)—2 AP**  
Movement as above, except evading makes one harder to hit with a weapon.

**MOVE & EVADE 1 SQUARE DIAGONALLY—3 AP**  
As above.

**\*TURN IN PLACE (ONLY)—1 AP**  
During movement a character may change facing as often as desired at no extra AP cost. However, if the figure does not move to a new square, it will cost 1 AP to change its facing within its square. This is an opportunity action.

**CRAWL 1 SQUARE ORTHOGONALLY—2AP**  
Movement as above, but character is crawling (prone) instead of walking.

**CRAWL 1 SQUARE DIAGONALLY—3 AP**  
As above.

**ROLL SIDeways—2 AP**  
Roll in prone position 1 square to either side (not forward or backward). This counts as evading.

### POSITION CHANGE

A character must be either standing to move normally or prone to crawl or roll. No movement is possible in sitting or kneeling positions. Players must state if a character is kneeling, prone, or sitting; otherwise character is assumed to be standing. Note that for a character to go from prone to standing he must go through two actions—first prone to kneeling, then kneeling to standing.

**\*STAND TO KNEEL (OR REVERSE)—1 AP**  
The same action point cost applies for moving either direction from one position to the other.

**\*KNEEL TO PRONE (OR REVERSE)—1 AP**  
As above.

**\*DIVE TO PRONE 2 AP**  
Character either kneeling or standing moves forward one square and assumes prone position. Counts as evading.

**\*DIVE ROLL (FROM STAND OR KNEEL TO KNEEL OR PRONE)—4 AP**

Counts as evading. Character can attempt to dive roll any orthogonal (straight) direction. Character must roll her/his DEX or less on % dice to be successful. If she/he makes the roll successfully, the counter is moved 2 squares in the desired direction and the player announces whether she/he is coming out of the roll in kneeling or prone position. If the DEX roll fails, the counter is moved only one square and is placed in the prone position. A character who completes the maneuver successfully may use a weapon at the end of the action if she/he has AP left to do so. If unsuccessful, the character may not do so. (This is a favorite maneuver of Capt. Kirk's for taking cover or getting the drop on someone).

**STAND TO SIT (AND REVERSE)—1 AP**  
For sitting on chairs the ground, etc.

**DRAW WEAPON (OR DEVICE) AND READY -- 2AP**

This action must be taken first for a weapon or device (like a communicator or tricorder) to be used or fired. If the item has been readied (i.e. taken in hand in a ready position) earlier, it may then be used without readying it again. This action is also used to put away an object or weapon, or exchange two objects or weapons on your person (putting one away and readying the other). Dropping a weapon or device to the ground costs no action points, but it will lie there until picked up later, using this action.

**\*FIRE READY WEAPON/THROW WEAPON—1 AP**  
See combat section for details.

**RESET WEAPON SETTINGS -- 2AP**  
Must use this action to "set for stun" or make other adjustments to weapons, such as attaching a phaser I to a Phaser II pistol grip.

**RELOAD WEAPON—2 AP**  
Must use this action to reload a weapon that uses ammunition or projectiles. Most beam weaponry (phasers, Klingon disruptor pistols, etc.) must be recharged, which



cannot usually be done in the field. This action is mainly used for archaic projectile weapons such as bows, pistols, and submachine guns. 2 AP is the cost for loading one round (if separate rounds are used), or one clip or one arrow.

**\*SHORT COMMUNICATION (1 SENTENCE)—1 AP**

During combat, communication between players must be limited to prevent long, unrealistic exchanges of tactics. The gamemaster should use discretion here, limiting such exchanges to short, one-sentence orders such as "Take the one on the right", "Phasers to stun", or the ever popular "Beam is up, Scotty!". (Note that the latter requires having a communicator out and ready, having the transporter locked in on your coordinates, and having Scotty on the other end to save your hide! And it is still going to take a turn or so to energize!

**OPERATE FAMILIAR DEVICE—2 AP**

This is the AP cost to simply activate a device the character is familiar with. Unfamiliar things take more time and AP (like captured enemy weapons, communicators, etc.), as does any extended manipulation. Device descriptions in this game gave AP modifiers for operating them listed. Gamemasters should use their own discretion when players want to fool around with control panels, unlock doors, etc.



**\*AIM WEAPON—2 AP**

This action is not required to fire a weapon, but it does give a character a positive die modifier to his "to hit" roll. Firing without taking time to aim is shooting from the hip, and hence is less accurate, but faster.

**PERSONAL COMBAT**

**\*PARRY BLOW—2 AP**

A character attacked in physical combat may attempt to parry (block) the attack. If attacked by an opponent who is unarmed (or at least has no ready weapon with which he can attack in personal combat), the defender may parry or block without having any weapon or object to parry with. If being attacked by an opponent with a chair, sword, club, or the like, however, he must have a weapon marked with a "P" on the weapons chart, or some other maneuverable object (like another chair) with which to intercept the attack. In either case, the player who is

defending rolls % dice, trying to roll his character's DEX or less. If the roll is successful, the blow is parried and no hit is scored. If the roll is missed, the blow, if successful itself, does normal damage.

**IMPORTANT NOTE!** An attempt to parry must be declared after the attacker has announced his intent to attack, but before the attacker's "to hit" roll is made! If the parry is tried for, the 2 AP are used up, even if the original attack later misses!

Ranged attacks (arrows, phaser fire, thrown daggers, etc.) cannot be parried, of course, nor can any attack made by an attacker who is behind the defender at the time of the attack. (See facing diagram earlier for clarification of what is in front of and behind a counter.)

**\*PHYSICAL ATTACK—ALL REMAINING AP (MINIMUM 3)**

In order to attack someone hand-to-hand (judo, boxing, etc.), the character moves into the same square as the opposing character. If attacking with a weapon like a sword, dagger, club, etc., the attack can be made from an adjacent square. (A Vulcan nerve pinch attack can be made from an adjacent square as well. It can also be parried.) To attack in either manner, the character must expend all remaining AP to make the attack, thus ending his portion of the turn when the attack is completed. The character must have a minimum of 3 AP left, or no attack can be made. Combat is then resolved according to personal combat rules.

**FLYING TACKLE—ALL REMAINING AP (MINIMUM 4)**

To perform this special attack, the attacking character must move a minimum of three squares directly toward his opponent, ending in the same square with the opponent. (The AP movement cost of this move is included in the AP cost of the flying tackle). This action expends all the attacker's remaining AP points, with a minimum of 4 required to perform the action at all. Both attacker and defender end prone in the defender's square.

Note involving movement and doors: Most doors on board Federation, Klingon, Romulan and other ships are automatic, opening whenever someone steps into the space adjacent, facing the door. These doors require no AP to open or close. Locking one (in open or closed position) requires an "Operate Familiar Device" action, as does opening or closing a non-automatic door.

Any actions not listed that players wish their characters to perform should be estimated by the gamemaster and players, using the existing list as a guide. (The designers would appreciate hearing from anyone who wishes to suggest any particularly useful additions to the list! Please, though, no "stroke tribbles" or "raise eyebrow" actions! Let's keep the list as simple and easy to understand as possible!) Remember when estimating AP for other actions that a turn is only 10 seconds long and 10-15 AP worth of actions may be fit into one turn by an exceptionally dexterous individual.

## MAPS AND MAPPING

The scale used to draw ship layouts and buildings for tactical movement and combat is  $\frac{1}{2}$  inch = 1.5 meters. The normal deck layouts are drawn so that 1 side of a square of the grid overlay equals  $\frac{1}{2}$  inch. This scale is very convenient for tactical combat because 4 characters can fit in a square. Also, control panels and consoles, furniture, doors, etc. can be shown in a size that is easy to see and use.

However, there will be many times when a landing party will beam down to a planet's surface and want to see what the surrounding area looks like. They may want to see settlements, bases, oceans, or any of the other thousands of places and things on a planet. You can easily see how our scale of  $\frac{1}{2}$  inch = 1.5 meters would be impractical here. To show an area the size of a small town would require hundreds of sheets of paper. To move characters at a rate of 12 or 15 meters in 10 second turns across the town would be a waste of time and energy on the part of all participants.

Therefore, we must use other scales of distance and time when covering larger areas. The easiest way to do this is a telescoping system, multiplying all factors involved by 10. Our first scale, that of 1.5 meters to the half inch, 10 seconds to the turn we will call the tactical scale. This is the scale used for all combat and physical interaction between sides in a situation. This scale will show detailed interiors of buildings, individual trees and similar obstacles. Our second scale we will call the "area" scale. In this scale a side of a square is 15 meters in length and a turn is roughly 1.5 minutes long. This scale is used to show small villages, bases, and similar areas. This will show relative sizes of buildings, terrain in the area, and elevations in 5 meter steps. This scale is of moderate use.

The third scale of greater use for our purposes is called the "large area" scale here; a square is 150 meters across and a turn is 15 minutes long. This scale is useful for showing larger areas where greater detail is not important, but terrain and general situation and relation to surrounding area is important. Elevations are shown in 10 meter increments.

The fourth scale is called the "region" scale. In it, a square is 1500 meters, or 1.5 km, or roughly 1 mile across. A turn is 150 minutes, or 2½ hours long. This scale is of great use when large regions, many miles across, must be crossed. In this scale, individual buildings cannot be discerned; only towns, rivers, rough areas, larger hills and mountains, etc. can be shown. Elevations are shown in 50 meter increments.

Gamemasters may wish to keep telescoping this scale upward, using the same scale throughout. By going upwards 4 or so more jumps whole planets could be mapped.

## PLAYING THE GAME WITH SCALES

All combat and player interaction with opposing forces must be carried out in the tactical scale. When maps are not provided for an area needed at this scale, the gamemaster should sketch it on blank graph paper. Many times

interaction can be carried out (ie. combat) by just showing the gamemaster how a character will move. A large tactical map and counters are not always necessary to resolve actions. Action points are used normally in this scale, regardless of whether the characters are on board ship or planetside.

In the larger scales — area, large area, and region — movement is carried out a bit differently. All characters retain their AP rating for purposes of movement only. Actions from the Action Points table are negligible when dealing with turns of 15 minutes or 2½ hours long. The time needed to work a communicator or ready a weapon are minimal in these scales. Players and the gamemaster must use common sense when working with these scales. Think about how long an action would take and translate it into these scales. Remember, combat and enemy interaction is not carried out at these scales. At any time interaction occurs or is imminent ( a prepared ambush) everyone must revert to the tactical scales.

Action points in the higher scale is used to regulate movement only. Each type of terrain crossed costs a variable number of AP's dependent on type of terrain dominant in that square. Crossing elevation hachures (lines of demarcation) cost extra APs in addition to the terrain dominant in the square. Only basic types of terrain are used in this basic game package. Future expansions and adventures may list new types of terrain or special types particular to a region or planet. Some adventures may require more specification due to the situation. Gamemasters should feel free to add to or alter AP costs in a situation where warranted.

### AP COSTS – LARGE SCALES

Clear, road, path	1 AP
Rough, rocky, lt vegetation	2 AP
Hvy vegetation, swamp	3 AP

Any type of terrain may be fit into these three classifications.

## MAP SYMBOLS

CLEAR

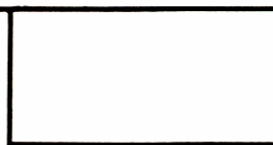

ROAD, PATH



ROUGH, ROCKY

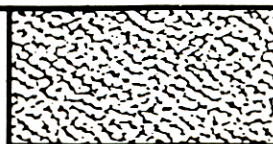

LT VEGETATION

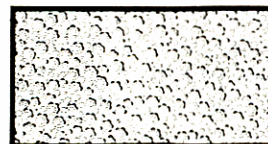



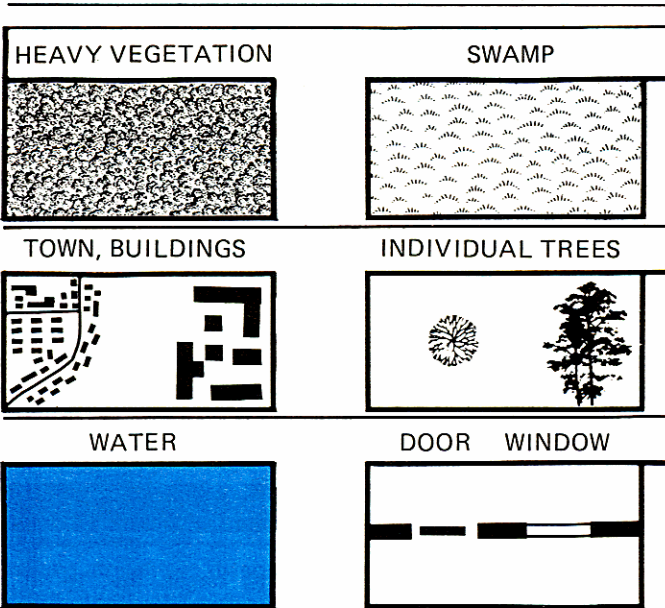

Other terrain features such as hedgerows, fences, etc. may be added as needed. Terrain changes caused by weather (snow, mud) will be announced by the game-master. These will cause movement to be slowed. Normally, AP costs are doubled.

Example of movement: Ensign Johanson normally has 9 AP in the tactical scale. In the area scale he still has 9 AP for purposes of movement. He could move through 2 rough terrain squares (2 AP each) and 5 clear squares (1 each) for a total of 9 AP used. A character cannot move into a square if he does not have enough AP to do so. AP not used in a turn are lost. They cannot be saved for use in the next turn.

### MOVEMENT ACROSS HACHURE LINES

Movement along elevation lines of demarcation (hachures) costs the AP of the terrain in the square. When a character announces he/she is crossing the hachure, an additional AP cost is imposed according to the scale being used, as below:

Area scale: No AP penalties.

Large area scale:

- 1 line in square - no cost.
- 2 lines in square - +1 AP.
- 3 lines in square - +2 AP.
- 4 lines in square - impassable, except with climbing equipment and skill.

Region scale:

- 1 line in square - +1 AP.
- 2 lines in square - +2 AP.
- 3 lines in square - impassable except with climbing equipment and skill.

NOTE: Roads negate the cost of terrain in the square except for hachure line penalties.

Crossing terrain may incur endurance penalties in the form of fatigue checks. Fatigue checks should be made whenever crossing rough or rocky terrain, swamp, or snow. The check is made at the end of any turn during which

more than ½ a figure's AP was used in crossing such terrain. (See the damage section under combat for information on fatigue checks.)

### VEHICLE MOVEMENT

Vehicles move at such high rates of speed that on all the smaller scale maps they will be able to cross the map easily in a turn or two or three. Only when you set to the scales larger than the region scale will vehicle movement be of importance. In most scenarios or adventures the only movement of vehicles that is important is to show where they move to at the start of the situation. In other words, where it will be located in case the placement becomes important when a character seeks shelter in it, for example.

Vehicle speeds are given in kilometers per hour (kph) on the data charts in the vehicle section of these rules. To use them in a situation, convert kph to squares per turn for the scale you are in. For example, if a vehicle moves at 45 kph, then it would move 75 squares in one turn in the region scale.

### SCALE USE IN GAMING

As noted previously, combat and interaction take place only in the tactical scale. The larger scales exist to move players quickly from one encounter to another. If players and gamemaster find it convenient to use other scales for movement, feel free to do so. These are intended as guidelines.

Given adventures and scenarios will list how often an encounter will occur (other than those planned by the gamemaster or given in the situation). There may be a chance for an encounter every turn in the region scale, for example. How often encounters occur and the type of encounter will depend on the area the characters are currently in. One would not normally encounter all kinds of strange little beasties in the middle of a Star Fleet base (unless it was deserted and overrun by the planet's ecology). Encounter charts and directions for using them are given in the individual scenarios and adventures.

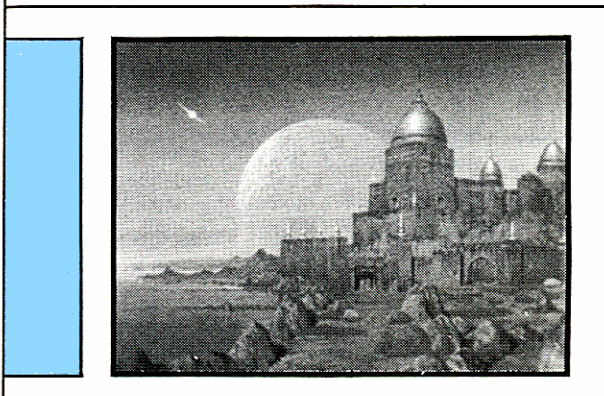

## COMBAT RESOLUTION

Combat must be resolved whenever a character chooses the fire weapon or personal combat attack options. Weapons used may be anything from a club to a phaser rifle. Two attributes, END and DEX, along with a character's skill rating with a weapon are needed to resolve combat.

To fire a weapon at another character requires a clear line-of-sight (LOS) with no obstacles in the way. To fight hand-to-hand (HTH), both characters must be in the same square. Fighting with hand-held weapons like swords, clubs, etc., is done with characters in adjacent squares.

A "to hit" number is obtained, based on a character's DEX and skill with a weapon, and modified by factors such as range, size of target, etc. Percentile (%) dice are then rolled to see if the attack was successful. If so, damage is computed and effects are noted.

## LINE-OF-SIGHT (LOS)

To fire a ranged weapon like a phaser or a bow at a target, the attacker needs a clear line-of-sight (LOS) to that target. A clear LOS exists if a straight line can be drawn from the center of the square containing the attacker to the target's square without passing through any square containing an obstacle.

The position (kneeling, prone, standing, sitting, or whatever) of the attacker and the target character must be considered, along with the height of obstacles. Obviously, someone prone behind a console cannot be fired on (or seen), but neither can that figure fire on you! On the other hand, if the figure is kneeling behind the console, peeking over the top, she/he can still fire freely, and still remain somewhat concealed behind the obstacle. The gamemaster must decide, using common sense, what obstacles do and do not block LOS in a given situation.

Other figures in a target square do not block LOS as such, but when figures are so tightly grouped, it is possible to strike the wrong target. (See explanation below under "to hit" rules.) Figures in intervening squares do block LOS if they are standing. Kneeling or prone figures do not block LOS.

### EXAMPLES OF LOS DETERMINATION:

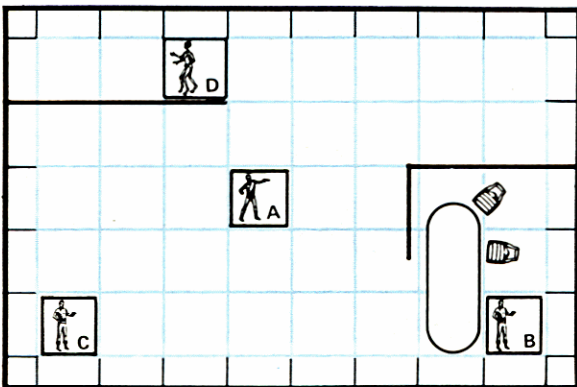

A is firing at C and C at A. No intervening obstacles are present. Clear LOS exists and each can fire at each other.

If B is standing behind the console, A can fire at him, and B is between 1/3 and 2/3 concealed. B also has a clear LOS to A. If B is kneeling behind the console, however, A can fire, but will make the "to hit" adjustment for targets more than 2/3 concealed. B will have a modification to his roll to hit A. If B is prone behind the console, neither can see or hit the other.

If D is standing completely behind the wall, LOS is blocked to A, and the reverse is also true. However, if D states he is peeking around the wall's edge to shoot at A, he can fire at A with a modifier. A can also shoot at D with a modification because D is more than 1/2 concealed.

## "TO HIT" PROCEDURE

If a clear LOS exists to the target, the "to hit" roll is made with % dice. If the "to hit" number or less is rolled, the target has been hit by the weapon. "To hit" rolls are figures for both ranged weapons and physical attacks (both armed and unarmed). The procedure to determine the "to hit" number is as follows:

### A. DEXTERITY & SKILL LEVEL

Take the character's DEX attribute score and add it to his skill level with the appropriate weapon. Marksmanship (modern) covers all phasers and similar energy weapons, marksmanship (archaic) must be gained in each specific projectile weapon type like bow, 20th century pistol, etc., and personal combat (armed) must be gained in each type of non-projectile weapon. Take the sum of the two numbers and divide in half to obtain the base "to hit" score for that weapon. If you have no skill with a weapon, you may still use it, but at a base score of 1/2 your DEX score itself.

Of course, if you don't know how to operate or point a weapon (as with some possible alien device not designed for humanoids), you can't fire it at all without luck. For this situation, make a % role. If the role is equal to or less than the character's LUC roll, he figures out how the weapon is fired, and may use it.

EXAMPLE: Sulu is still trying to shoot that Klingon. When we left him, he was kneeling and about to fire his phaser (set on stun) at the Klingon, who was coming down the corridor. Sulu's DEX is 87 and his marksmanship (modern) skill level is a respectable 62. Added together they are 149; divided by 2 is a base "to hit" number of 74.

### B. SIZE OF TARGET

Adjust the "to hit" roll according to the size of the target. A "small" target is considered to be one the size of an eight-year-old human or smaller. It is this adjustment one would use if one were aiming to hit a portion of the body (like a leg), or shooting something out of someone's hand. A large target is anything the size of an adult horse or larger. Anything in between is considered "man-size". Small targets give a -15 to the "to hit" number, while large ones give a +15. There is no modification for a man-sized target.





EXAMPLE: The Klingon above is definitely man-sized, so Sulu has no modifier here. "To hit" = 74.

#### C. RANGE

Range is determined by counting the number of squares from firer to target along the most direct route (moving straight or diagonally). Include the target's square in the count, but not the attacker's. Then compare the count to the WEAPONS CHART to see in what range class the count falls. Anything beyond extreme range for a weapon cannot be hit. A target in the same or an adjacent square to the attacker gives the attacker a +15 modifier. At short range, there is no modifier. Medium range gives a -15. Long range gives a -30 and extreme range gives a -45!

NOTE: Hand-held personal combat weapons like swords and daggers are always used in adjacent squares to the target, thus they always receive a +15 modifier.

EXAMPLE: Sulu is 22 squares from the advancing Klingon, and is using a Phaser 1. According to the WEAPONS CHART, that puts him at long range, for a -30 adjustment. "to hit" roll is now 44.

#### D. TARGET MOVEMENT

The movement of the target also modifies the chances to hit. A stationary target gives a +15 to hit. A moving target gives no modifier, but one who is evading (that is, has just performed or is performing an action noted in the action points list as counting for evade) gives a -15 modifier.

EXAMPLE: Sulu's target, the Klingon guard, is moving (you'll remember, Sulu stopped the Klingon's movement for an opportunity action) but not evading, so there is no adjustment. "To hit" = 44.

#### E. AIMED SHOT

Aiming a shot before firing (not "shooting from the hip") gives a +25 modifier.

EXAMPLE: Sulu can't aim opportunity fire, so there's no modification.

#### F. TARGET PARTLY CONCEALED

If the target (not the attacker) is behind an obstacle, obscured by smoke, or otherwise concealed, there may be a modifier. The gamemaster should use common sense, discretion, and the following examples when applying this rule.

A human standing behind a crate that covers him up to his knees is less than 1/3 concealed—no modifier.

A human standing behind a waist-level console is more than 1/3, but less than 2/3 concealed—die modifier -10.

A human standing behind a shoulder-height bank of instruments or peeking around a door or from behind a partition is over 2/3 concealed—die modifier -20.

In addition, a person firing from more than 2/3 concealment is at a severe disadvantage himself, as it is impossible to get a good look at the target from such a position. Apply a -30 modifier to any shot made from more than 2/3 concealment!

EXAMPLE: The Klingon is right out in the open—no modifier.

#### G. TARGET PRONE

If the target (not the attacker) is prone, he's harder to hit. Apply a -5 adjustment.

EXAMPLE: This doesn't apply here either. No modifier.

#### H. WRONG HAND

If a left-handed person fires right-handed (or vice-versa), apply a -20 modifier. Same if the character is using a hand weapon like a sword wrong-handed. Unless you specify otherwise when your character is created, assume he uses the same hand you do. True ambidexterity is rare. Gamemasters should not let more than one out of ten characters be ambidextrous.

EXAMPLE: Sulu is firing with the correct hand. No modifier.

#### I. TWO WEAPONS

It is possible to use two weapons in combat (like a knife and a sword), or even to fire two weapons, if both can be operated one-handed (like some of the Earp brothers did in the STAR TREK episode *Spectre of the Gun*). This applies an additional -10 modifier to both attacks. This is in addition to the wrong hand modifier (as H above) for the weapon used in the wrong hand.



NOTE: Star Fleet officers never carry two phasers, nor are other advanced cultures using energy weapons in the habit of doing this (not even Klingons). Mostly, this rule is established for archaic weaponry. Gamemasters should not allow misuse of this rule.

EXAMPLE: Sulu occasionally fights saber-and-dagger when practicing fencing but wouldn't think of using two phasers. No modification.

### "TO HIT" TABLE (WITH ADJUSTMENTS)

Basic "to hit" number:	DEX + weapon skill divided by 2	
Size:	small	-15
	man-size	0
	large	+15
Range:	same or adjacent sq.	+15
	short	0
	medium	-15
	long	-30
	extreme	-40
Target movement:	stationary	+15
	moving	0
	evading	-15
Aimed shot:		+10
Target 2/3 or more concealed:		-20
Target 1/3 to 2/3 concealed:		-10
Attacker more than 2/3 concealed:		-30
Target prone		-5
Wrong hand:		-20
Two weapons:		-10 to each

Once all modifiers are figured in, you have the final "to hit" number. If the number is less than 0, make it 0. If it is over 100, make it 100. Roll % dice. If the number rolled was higher than the final "to hit" number, the character misses and no damage was done. If the roll was the same or lower than the "to hit" number, the target is hit and damage must be figured.

Optional rule: Any roll of 100 (00 on % dice) misses, no matter how high the "to hit" number. Likewise, any roll of 01 hits, no matter how low the "to hit" number.

EXAMPLE: Sulu's final "to hit" number came out 44. He rolls the % dice, which comes out 36. The Klingon guard is hit by Sulu's phaser beam!

One more determination must be made at this time. Some energy weapons (such as phasers and disruptors) are listed in the weapons charts with results in the column marked GRAZE. This means it is possible that a marginal hit may not strike the figure solidly, and hence may do less damage. This can be important with this type of weapon, especially if someone is shooting at your favorite player character with a phaser set on disintegrate! If the "to hit" die roll is ten or less below the necessary "to hit" number,

the result is only a grazing shot, and the GRAZE damage is done. If the weapons table shows no graze result, the full normal damage is done.

EXAMPLE: Unfortunately for Sulu, he only grazed the Klingon, since his "to hit" roll was 36 and his needed "to hit" number was 44, a difference of only 8. The Klingon takes the lesser amount of damage under GRAZE on the WEAPONS CHART.

### DAMAGE

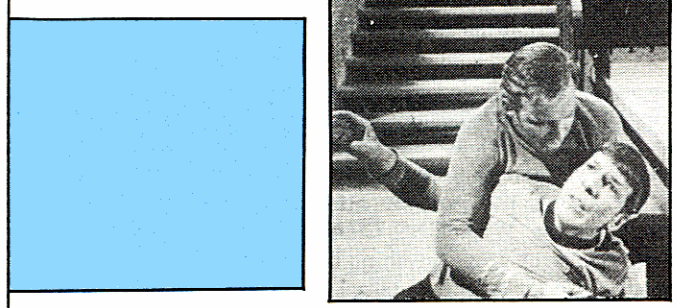

If the roll to hit was successful, the damage done to the target needs to be determined. Using the weapons chart, cross-index the row for the weapon used with damage column. This will list how many dice to roll for damage done. For some weapons, there are various rows, depending on the setting on the weapon. Some weapons do predetermined number of points of damage, while others have a die roll, or perhaps a die roll with a + or - number after it. If the latter, roll the indicated number of 10-sided dice and add the bonus points to the number rolled to determine the total damage.

For example, the Phaser 1, when set on stun, does a standard 75 points of damage with a hit. On the other hand, if set on disintegrate, no damage roll is necessary. The disintegrate setting totally vaporizes any man-sized or smaller target it hits solidly. Any larger target has a man-sized hole in it, which will kill any normal living creature, or make a mess out of a large console or a wall! For an archaic firearm like an M1 Carbine, the table specifies 4D10+10 which means you roll 4 10-sided dice and add 10 to the result to determine the total damage.

NOTE: If you are used to playing many other fantasy or science fiction role-playing games, you may find the combat damage much more devastating than you are expecting. The weapons of the STAR TREK universe are rather deadly when used indiscriminately. Fortunately, weapons are never used indiscriminately by Federation Star Fleet personnel and are rarely used so by the other space-faring races. (No one likes a diplomatic incident, not even a Klingon.)

Players and gamemasters are reminded — this is not a shooting gallery! Also, you will find when reading the rules on recovery and medical assistance that people don't die easy when Dr. Leonard "Bones" McCoy and his fellow Star Fleet medical officers are around. There is very little one can do about disintegration, but many "dead" characters can yet be saved by the timely arrival of medical help, or a quick beam-up to the ship and a trip to sick bay and intensive care.



A weapon with a number listed under GRAZE does less damage on a marginal hit (see rules on GRAZE above).

Any damage generated by a weapon is taken directly off the endurance ("END") attribute. Keep track of the original Endurance, but keep a tally of how many points are knocked off by damage.

The effects of damage on a character are discussed in the section on Damage Effects in his book.

Damage done in unarmed combat depends on the STR attribute of the attacker and, to a lesser extent, on the personal combat (Unarmed) skill he possesses. Use the chart below to determine damage done to the defender. This damage is delivered no matter how long the normal roll.

STR	DICE
01-25	1D10-3
26-50	1D10
51-75	1D10+3
76-100	2D10
101-125	2D10+3
126-150	3D10
151-175	3D10+3
....and so on for higher STR levels	

Note that the chart continues beyond a reasonable level for human-like characters. This is because animals and creatures (introduced later) may have a higher STR base, and hence do more damage. Animals, creatures, and some intelligent races like the Gorn may have bonuses for claws and teeth as well. (See Beasts and Creatures, Character Races).



## ARMOR

Some beings may wear some sort of armored protection, and some beings (as well as some animals and creatures) may have natural armor. Armor reduces the amount of damage done by physical weaponry, but usually has little or no effect vs. stun, disrupt, or disintegrate effects of phasers, nor against other forms of beam weapons. (Armor effective vs. such weapons has been developed by most advanced cultures, but it is bulky and seldom used except by armored ground troops not dealt with in this game, or occasionally by starship security personnel on hazardous duty).

Armor subtracts from damage, and is usually described by the number of points of damage it absorbs per turn. Subtract this armor rating from damage occurring. If the result is 0 or less, no damage is taken at all. Armor is equally effective in personal combat (armed or unarmed), and vs. projectile weapons or thrown weapons. Some heavy armor may slow a character down, causing a modification in the DEX statistic when it is worn.

## THROWN WEAPONS

If a character has a personal combat (armed) skill in dagger/knife, he may throw this weapon at a target as well as stab with it. The "to hit" roll is determined in the same manner as firing a projectile weapon.

This is also the case for throwing a rock or bottle or tossing something to a friendly character. When throwing or tossing something small that is not primarily a weapon like a dagger, use the dagger/knife ranges, but use the raw DEX score itself to determine the "to hit" roll rather than a skill level. No special skill is needed for such throwing or tossing.

## PHYSICAL ATTACKS WITH HAND WEAPONS

Some weapons do not have ranges listed for them. To use these weapons, the characters must be in the same or adjacent squares. The "to hit" roll and modifiers are determined in the same manner, essentially, as with ranged combat. The knife/dagger is the only listed weapon that may be used in either ranged or non-ranged combat.

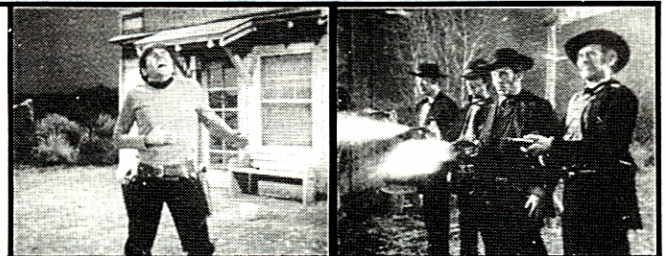

WEAPON	PARRY	DAMAGE	Short	Med	Long	Extreme					
Club, other	P	2D10	—	—	—	—	POWER				
Mace, Flail, Axe	P	4D10+10	—	—	—	—					
Dagger, Knife	—	2D10	1-5	6-10	11-15	16-20					
Sword	P	4D10	—	—	—	—					
Pole Weapon	P	4D10+5	—	—	—	—					
Bow	P	4D10	1-20	21-60	61-130	131-190				20	
Crossbow	P	4D10+10	1-12	13-35	36-60	61-90				20	
Pistol	—	4D10	1-10	11-25	26-40	41-75				6	
Carbine	P	4D10+10	1-15	16-50	51-100	101-170				15	
Rifle	P	4D10+5	1-30	31-100	101-200	201-300				30	GRAZE
Shotgun	P	4D10+10	1-10	11-25	26-50	51-100				2	
SMG	P	4D10+20	1-15	16-45	46-80	81-120				32	DRAIN
MG	—	4D10+30	1-50	51-150	151-300	301-500				50	

Hand Disruptor	—	75 pts.	1-4	5-10	11-25	26-45	20	25	2
Hvy Rifle Disruptor	P	75 pts.	1-10	11-25	26-50	51-100	50	25	2
Gorn Blaster	—	50 pts.	1-4	5-8	9-20	21-45	25	20	1

Phaser I	—	—	1-5	6-12	13-30	31-50	20	—	—
On Stun		75 pts. (non perm)						25	1
On Hvy Stun		120 pts. (non perm)						40	2
On Heat		40 pts.						20	1
On Disrupt		150 pts.						50	2
On Disintegrate		DESTROYED						50	4

Phaser II	—	—	1-10	11-24	25-60	61-100	35	—	—
On Stun		75 pts. (non perm)						25	1
On Hvy Stun		120 pts. (non perm)						40	2
On Heat		40 pts.						20	1
On Disrupt		150 pts.						50	2
On Disintegrate		DESTROYED						50	4

Phaser Rifle	—	—	1-15	16-35	36-90	91-150	50	—	—
On Stun		75 pts. (non perm)						25	1
On Hvy Stun		120 pts. (non perm)						40	2
On Heat		40 pts.						20	1
On Disrupt		150 pts.						50	2
On Disintegrate		DESTROYED						50	4

Phaser I, II and rifle stun effects last 2D10+10 minutes.  
Heavy stun effects last 3D10+20 minutes.



## FIRING ARCS

All weapons are fired in a straight line through a front square of the firing character (see below). The only exception is the shotgun, which fires a pattern that may strike and damage any and all figures in the affected area (see below) a separate "to hit" roll and damage roll must be made for all figures in the affected area.

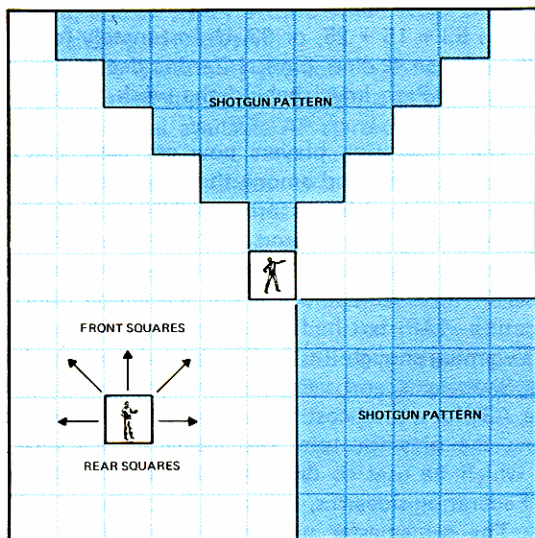

## DRAIN

Numbers under DRAIN represent the amount of power used for each shot of the types listed. Players must keep track of the drain on the powerpack of the weapon.

EXAMPLE: Sulu has just fired a Phaser 1, set for stun, at a Klingon guard. It is the first time the weapon has been fired. The power before use was 20, now it is 19. If he fires it again, this time at heavy stun (and with that Klingon still coming, he'd better do something), he will drain off two more points of power, leaving 17 power points.

When a weapon has been drained of all power, it must be recharged. See Weapons list for information on recharging weapons.

## OVERLOAD

A phaser can be set to overload, building up a charge that will eventually cause it to explode, taking much of the surrounding area with it. The action "Reset Weapon Settings" must be taken to set a phaser for overload. The same action will disarm it. Six turns after being set, it will explode, destroying everything in the listed blast radius, as below:

- Phaser I - 30 squares
- Phaser II - 100 squares
- Phaser rifle - 125 squares

A phaser on overload makes a characteristic whine, rising in pitch as time runs out. This noisemaker effect is inherent in the circuitry and cannot be bypassed for safety reasons. It can be heard over a wider area than the blast radius, again for safety reasons. Thus, a phaser does not make a good booby trap or grenade. The only real use for this setting seems to be as a time bomb or to scare the bejabbers out of Capt. Kirk in *The Conscience of the King*.

## COMBAT EXAMPLES

The following examples should serve to show just how the combat system works in practice. New players are advised to actually set up each of these encounters and play along as described to get the feel of combat.

The first example of combat takes place in a small (19.5 m x 12 m) supply and storage room at a planetside Federation base. (See Figure A1 below.) A cross grid of letters and numbers is used to locate personnel and fixtures.

(EXAMPLE: There are chairs illustrated at E6 and F6 in the room, and the door on the left is between A5 and B5).

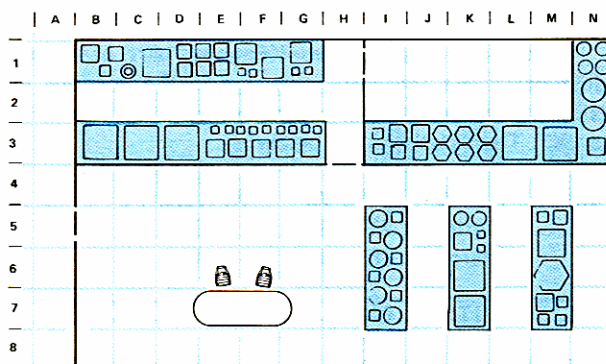

FIGURE A-1

The entrance mentioned above at A5-B5 is a double automatic sliding door, as seen aboard ships like the U.S.S. Enterprise. It opens automatically whenever a figure enters either A5 or B5 and is facing the door.

E6 and F6 are large chairs, E7-F7 is a work table with a computer screen for inventory.

I5-6-7, K5-6-7 are shelves and bins from floor to ceiling. They cannot be seen through, as they are fully stocked on both sides with a dividing wall down the middle.

The doors at H3-4 and H1-11 are one panel sliding doors, also automatic. The shaded areas in these rooms are storage bins and shelves, also solid and running floor to ceiling.

At the start of our combat example, there are three Star Fleet officers in the room. (See Figure A2, showing placement of counters and facing.) Lt. Wagner is denoted by a "W", Ens. Simbala by an "S" and Ens. Horowitz by an "H". The statistics we need for our example are below:

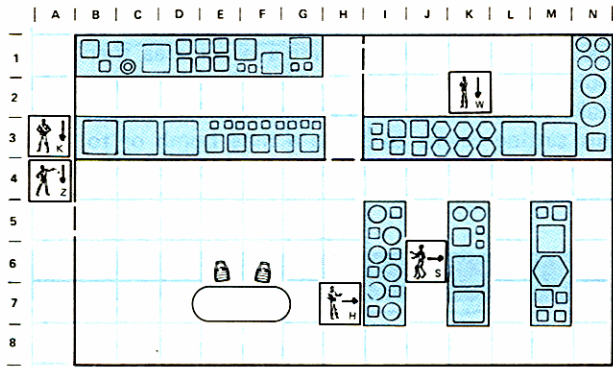

FIGURE A-2

SYMBOL	NAME	DEX	AP	WPN SKILL
W	Wagner	76	11	44
S	Simbala	52	9	28
H	Horowitz	37	7	11

BASIC "TO HIT"	END
60	83
40	77
24	34

The intruders are two Klingons, part of a larger raiding party. At the start, they are in the corridor just outside the room. Zardna is denoted by a "Z" and Klarn by a "K". Their statistics are below:

SYMBOL	NAME	DEX	AP	WPN SKILL
Z	Zardna	71	11	36
K	Klarn	68	10	41

BASIC "TO HIT"	END
53	81
54	54

As this base is in area recently contested by the Klingons, the base personnel have been issued Phaser I sidearms to wear at all times. The Klingons are armed with hand disruptors.

Follow along with the movement and action for the first turn on Figure A3.

TURN No. 1

Wagner has a DEX of 76, higher than Zarda's 71, so the Federation players would normally have the choice of moving first or second. However, the gamemaster decides that since the Klingons just broke into the base, the players do not even know they are there. The reason the Klingons gained surprise are not important here. But the gamemaster has decided that the Klingons have surprised the players and are thus automatically allowed to move first THIS TURN.

Zardna moves first, then, with 11 AP to use. Both Klingons already have their weapons ready. Zardna moves as shown in Figure A3 for a total of 6 AP, leaving him 5 AP.

Horowitz, having no weapon ready, (surprise attack, remember?) declares an opportunity action to turn and see who just came in the door. Turning in place costs 1 AP—Horowitz has 7 left.

Zardna aims his hand disruptor at Horowitz (cost: 2 AP) and fires (cost: 1 AP). He now has one AP left. Zardna's basic "to hit" score is 53. There is no modifier for target size (man-size) or range (4 squares-short). A +15 modifier is applied for stationary target (turning in place doesn't count as movement) and +25 is applied for the aimed shot. Since there are no other modifiers, the final "to hit" is 53 + 15 + 25, or 93. Unfortunately for Zardna, he rolls a 97 on % dice—a miss! Zardna decides to use his remaining 1 AP to kneel behind the work table for concealment.

The Federation players now get their first movement turn. It is decided among the players that Horowitz had better do something before he is hit—he can't be lucky forever. (Besides, the Klingon can't see the others yet!)

Horowitz has 6 AP left (he used one to turn, remember?) Horowitz could call out a warning (short communication—1AP) but he figures the sound of the disruptor bolt is warning enough. Instead, he intends to move back to where Simbala is and seek cover. He moves as shown in Figure A3 (for a total cost of 4 more AP) and announces he is using the bins for total concealment. This leaves him 2AP, which he uses to draw his phaser. The phaser, like most Federation sidearms, starts out set on "stun".

The gamemaster now moves Klarn into the room as shown, using up 9½ AP. That last ½ AP isn't enough to do anything with, so he ignores it. He is now facing the door at H3-4, which slides open.

The Federation players still have two characters to move—Simbala and Wagner. The players are not aware that Klarn has no AP left. (Players should not be told how many AP a non-player has in order to keep them guessing. "Does he have enough points for opportunity fire?" The only way to find out is to be a target.) Wagner is told by the gamemaster that he has heard the disruptor fire (the gamemaster reasoning that these are thin interior walls and a small room).

Wagner has 11 AP. He first draws his phaser (2AP) and moves as shown (3½ AP). Seeing Klarn through the now-open door he aims (2 AP) and fires (1 AP). He has used 8½ AP.

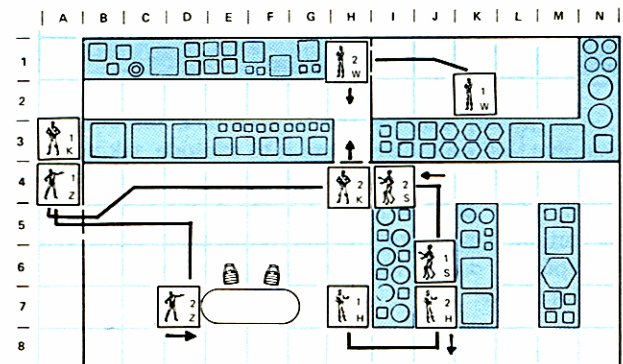

FIGURE A-3



Wagner's basic "to hit" number is 60. Target size, range and movement have no modifying effect. The aimed shot gains him +25. No other modifiers apply, so Wagner has a final "to hit" number of 85. The player rolls a 52—a hit! Phaser I on stun does 75 pts. non-permanent damage. Klarn's END is only 54, so he is stunned into unconsciousness for 2D10+10 minutes. The roll on two dice added together is 6, so Klarn is out of this fight for 16 minutes. (It will all be over by then).

Wagner has AP left over, but he has no other targets he can see, and so ends his turn. When Klarn drops to the floor, the sliding door closes.

Simbala is the only character who has not acted. He draws and readies his phaser (2 AP) and moves as shown (2½ AP). His total available AP started as 9, so he is now down to 4½ AP.

The player declares that Simbala is remaining 2/3 concealed, essentially peeking around the corner. He fires a quick shot at Zardna, who is down behind the desk. (This costs one more AP.)

Simbala's basic "to hit" score is 40. There are no modifiers for target size range or movement. (Zardna did move this turn, remember.) Zardna is kneeling, so he is considered to be more than 2/3 concealed, giving Simbala a -20 modifier. His final "to hit" number is 20, and the player rolls a 31—a miss. All characters have now moved and fired, so a new turn is begun!

#### TURN NO. 2

(Refer to Figure A4, with starting positions indicated by the counters with a "2" in the lower right hand corner.)

Wagner has the highest DEX, so the Federation Players get to decide which side moves first. The players decide to have the gamemaster move Zardna first, in hopes of drawing him out in the open.

The gamemaster announces that Zardna will not make a normal move, but will save his AP to use as opportunity actions.

Any of the Federation characters could be selected to move first, but the players decide on Horowitz. He moves as shown (1½ AP), aims (2 AP), and fires (1 AP). He has used 4½ AP this turn.

Horowitz's basic "to hit" is 24. There are no size or range modifiers, but Horowitz gets a +15 because Zardna did not move. He also gets a +25 for aimed shot and a -20 for Zardna's 2/3+ concealment. This yields a final "to hit" number of 44. The player rolls a 46—a miss. Also, because Horowitz did not declare his use of any cover, he is a perfect target.

The gamemaster, although he declined normal movement for Zardna, may take an opportunity action at any time. He does not do so yet, however.

The players decide Wagner will move next. Wagner moves as shown, coming through the door (which opens automatically), stepping over the fallen Klarn, and moving towards the door. The gamemaster stops Wagner and requires a normal saving roll on DEX be made to step over the fallen Klingon without tripping (since Wagner is moving fast under stress). Wagner's DEX is 76 and he rolls a 31—no problem!

Moving Wagner into the open like this is a brash move, but Wagner's player is role-playing him as an action-oriented person who likes to take chances. Wagner now has 4 AP left, and he confidently fires his phaser (forgetting to aim, even though he has enough points.)

Wagner's basic "to hit" number is 60. The stationary target modifier (+15) is the only modifier that applies, giving a final score of 75. The player rolls the dice, expecting an easy hit, but rolls an 81—a miss! He has points enough to fire again, but doesn't, saving the AP in case someone else comes through the door. (Who knows what the gamemaster has in mind?) He knows that if Simbala doesn't get the Klingon, he can always fire later as an opportunity action.

The gamemaster, knowing that Zardna isn't going to get reinforcements any time soon, decides to act. Zardna cannot aim a shot (since aiming is not a permitted opportunity action), but he can fire (1 AP), choosing Wagner as his target.

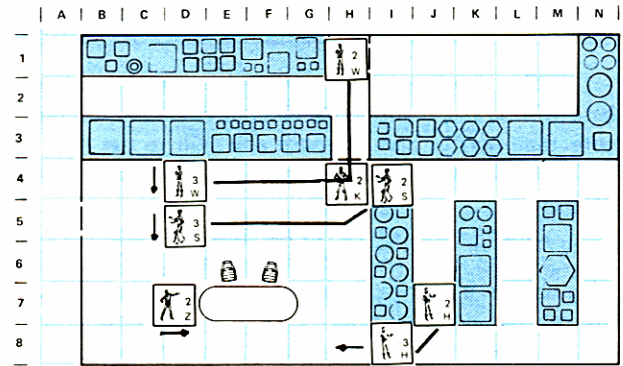

FIGURE A--4

Zardna's basic "to hit" score is 53, and no modifiers apply. (NOTE: Although Zardna is more than 2/3 concealed from Horowitz, Zardna suffers no "firer concealed" penalty when shooting at Wagner.) The roll is 37—a hit! Wagner's END is 83, and the disruptor does 75 points damage. Wagner falls, reduced to 8 points of END (which is his unconsciousness threshold).

Zardna has AP left, but decides to hold onto them for opportunity actions, in case any look promising.

The Federation players have one remaining character, Simbala, who has not acted this turn. Simbala moves as shown (5½ AP) and fires once he has a clear shot at Zardna (1 AP). He receives a +15 modifier because Zardna has not moved, giving Simbala a "to hit" number of 55 for this shot. He rolls a 47, which is a grazing shot (within 10 of the needed number). Zardna takes 25 points of stun damage, reducing his END to 56. He's not below half yet, so no unconsciousness save is needed.

Zardna interrupts at this point to take opportunity fire at Simbala. There are no modifiers applied to his basic "to hit" score of 53. The gamemaster rolls a 67—a miss.

It is still Simbala's turn. As he has several AP left, he uses one to fire again. His "to hit" score is still 55. The player rolls better this time; a 25, which is a good solid

hit! Zardna is stunned, well below the unconsciousness threshold, and will be unconscious for 2D10+10 minutes.

Thus ends the example, with both Klingons stunned and all the Federation officers alive (though Wagner will need prompt medical attention, as he is very gravely injured). As you can see, players must put some thought into their strategies. In the example, both sides missed opportunities and made mistakes. Care must be taken with movement, and full use of available concealment must be used. As you play, you will develop your own strategies.

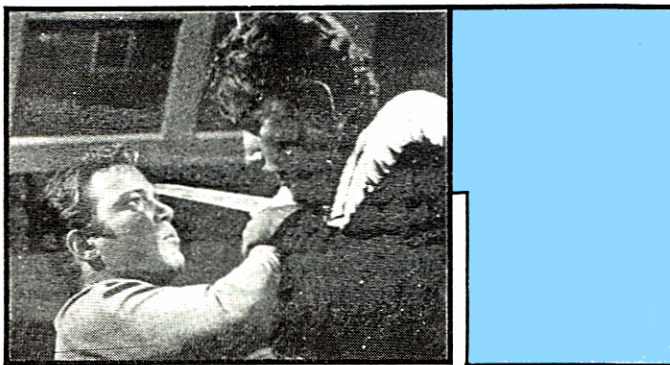

The above example is fine for armed combat, but there will be many situations where a character has nothing more than her/his own strength and skill to use in a fight. The next example involves the use of unarmed personal combat.

Shown in Figure B1 is the starting situation. Kavax, (at C2 on the map, and indicated with a "K") is a Klingon being held in a maximum security cell on a planetside base. The cell has no solid door. Like most Federation holding cells, it uses a force field across the doorway to hold the prisoner inside. The field controls are on the wall (at "A") with a duplicate control panel on the desk at G2.

Ens. Williams (at F2, indicated by a "W") is a junior security officer, delivering lunch to the prisoner. The regular jailer has gone down the corridor for a moment. At E4 is a monitor readout for all cells along this corridor. At G4-H4 is a cabinet containing medical supplies, uniforms and weapons.

The statistics needed for this example are given below:

NAME	DEX	STR	END	PRS	CMT	ROLL	EX	DM
Williams	62	56	61		38		1	
Kavax	71	80	74		65		3	

  

DMG ROLL	AP	TO HIT
1D10+3	10	50
2D10	11	68

EX DMG refers to the number of extra points of damage done in hand-to-hand combat due to combat skill. This number is found by dividing the Personal Combat (unarmed) skill level by 20 and rounding down. The DMG ROLL is the die roll made for damage done in hand-to-hand combat, and is based on the STR of the character.

Ens. Williams is armed with a Phaser I, but it is still at his belt in back. He has just given the prisoner his tray, but has failed to turn the force field back on. He realizes

his mistake, and is reaching across the desk to the desk control panel when Kavax makes his move.

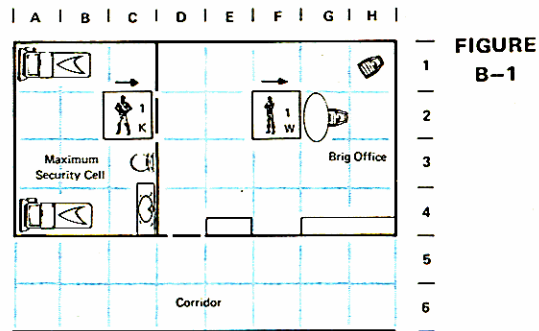

TURN NO. 1

Kavax, having the higher DEX of the two in this situation, has the choice to act first, which of course he takes (not wanting Williams to reach the field controls.) He decides to tackle Williams from behind. A flying tackle requires three squares of preliminary movement toward the target, which is no problem as Williams is three squares away exactly. The gamemaster moves Kavax's counter into Williams' square (see Figure B2). A flying tackle costs all of the acting character's available AP (minimum 4), so all of Kavax's 11 available AP are now used. Kavax and Williams are now both prone in square F2.

NOTE: A gamemaster could require a saving roll vs. DEX for each character in this situation to avoid hitting their heads on the edge of the desk at G2. This is one example of how a gamemaster can use saving rolls creatively in a gaming situation. If the roll were to be made here, it should be made easier by applying a die modifier of -20 or even -30, since this is not a difficult action. Still, the possibility of hitting the desk is there...

Williams decides to try to draw his phaser. The gamemaster requires a saving roll on DEX for success, since he is in combat and on the ground. The player rolls a 73, too high for Williams' DEX of 62. The action costs Williams 2 AP (draw weapon), even though it was unsuccessful. He now has 8 AP left, and decides to attack in unarmed personal combat. This action takes all his remaining AP.

Williams' base unarmed "to hit" roll is 50, determined by adding his DEX and his Personal Combat (unarmed) skill level and dividing by 2. The same basic combat procedures and modifiers are used in this type of combat as in the previous example. There is no modifier for size, but range in hand-to-hand combat is always "same or adjacent square", so a +15 die modifier is applied. The target is stationary (+15; note that any hand-to-hand target is considered stationary, even if it moved to get to you, as long as it is in the same square with you). Aimed shots do not apply in hand-to-hand combat, since no weapon is being used. The target is prone, which is a -5 adjustment. The final "to hit" number, after adjustments, is 75. The player rolls 63—a hit!

Williams' STR entitles him to a die roll of 1D10+3 for damage. He rolls a 6, adds 3 for 9. He has a Personal Combat (unarmed) skill level of 38, so he does additional damage of 1 point. (Skill level divided by 20, rounded



down to determine extra damage). Thus, the final damage scored to Kavax is 10 points, which is removed from his END.

No unconsciousness roll—Kavax is still above half END. This ends the turn.

FIGURE B-2

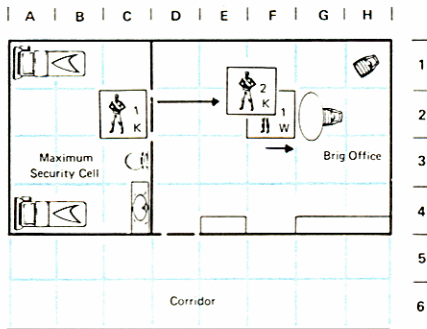

TURN NO. 2

Kavax again decides to act first. He has a good idea of where Williams has his phaser, and Kavax wants to try and get it himself. The gamemaster rules that the attempt is the same as a normal "draw weapon" attempt, in the number of AP involved (2 AP). He also rules that Kavax must make a saving roll on his DEX to reach the weapon and that Williams must fail a DEX roll for Kavax to get away from him!

Kavax rolls an 18 (his DEX is 71), so the phaser is his if Williams fails his own roll. Fortunately for Williams, his player rolls a 44 and retains the phaser. The gamemaster rules that stopping Kavax is the equivalent of a parry action so the save costs Williams 2 AP. Kavax is down to 9 AP, Williams to 8 AP and it is still Kavax's move.

Kavax decides to use the remaining points in a physical attack. The Federation player announces he will parry the attack (using up 2 more AP). Kavax's base "to hit" number is 68, and modifiers are applied for range (+15) and prone target (-5), giving Kavax a final "to hit" number of 78. The gamemaster rolls a 72, which is a hit if Williams doesn't parry. A parry attempt requires only a simple DEX saving roll, but Williams misses with an 87, so Kavax hits. He does 2D10 based on STR and rolls an 18. This is added to his 3 point bonus for Personal Combat (unarmed) skill level, so Williams takes 21 points of damage. This reduces his END to 40. Again, he's still above half, so no unconsciousness check.

Williams has 6 AP left this turn, so he decides to try for his phaser again, since Kavax is obviously a better brawler than he! The attempt to draw his weapon costs 2 AP, and he must again make a successful DEX saving roll. Rolling the dice, he gets a 23—success!

But the gamemaster rules he must get out of Kavax's grasp to bring his weapon to bear. Williams decides to try and wriggle away from Kavax and crawl into the next square for a shot. The gamemaster decides that getting away from Kavax will take a harder saving throw against his DEX score minus 20 (62-20=42). Williams makes a heroic effort, and rolls a 6! He crawls to the next square (cost=2AP; see Figure B3) and brings his phaser to bear.

Williams fires a quick shot at Kavax (1 AP). His skill with a phaser is 75. (He can't fight but he can shoot.) His base "to hit" score is 75 (skill) + 62 (DEX) divided by 2, for a base of 68. The modifiers are +15 for range, +15 for target stationary and -5 for target prone. The gamemaster also imposes an additional -10 because of the general confusion of the situation, for a final "to hit" number of 83. He rolls a 35—a solid hit! Kavax takes 75 points of non-permanent damage from phaser stun off his current END of 64. He is now below his unconsciousness threshold and automatically rendered unconscious for the next 2D10+10 minutes. Williams, though battered, is alive and much wiser!

FIGURE B-3

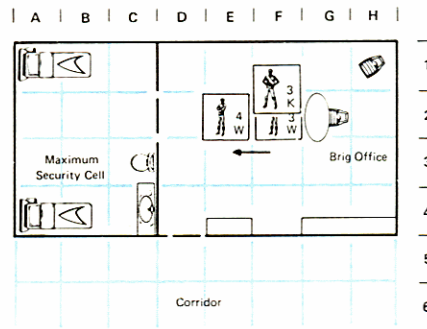

NOTE: The previous situation has several examples of saving rolls and instances of actions not detailed on the Action Point tables. Remember to use your imagination, common sense, and intelligence when dealing with a situation not specifically covered by the rules!

EFFECTS OF DAMAGE

Damage from all types of attacks is taken directly off the END attribute. There are two types of damage, however, that must be kept track of separately.

WOUND DAMAGE is of a semi-permanent nature, representing actual physical harm to the body. Wound damage also includes the debilitating effects of poisons and diseases, as well as damage caused by physical weaponry, lethal beams (like disruptors, lasers, phaser disrupt, etc.), and hand-to-hand attacks.

Wound damage heals slowly. A character will regain END points each day equal to his original END score divided by 20 (round down). Thus, a character with an original END of 50 will regain 2 points of END per day of recovery. (50 divided by 20 equals 2 1/2, rounded down to 2.)

Recovery from wound damage is automatic as long as the character has not been reduced below 1/2 his normal END. If the score drops below this level, the patient must be confined to bed or no healing results. Once the END score is raised above half, the characters may return to duty and continue healing.

Medical attention will greatly aid the healing process. See the section on Medical Aid and Recovery for details.





**TEMPORARY DAMAGE** is damage done by non-lethal means that may still induce unconsciousness. Such damage includes the effects of phaser stun, certain drug effects (especially sedatives), the results of a Vulcan nerve pinch, exhaustion due to fatigue, etc.

A separate record of temporary damage must be kept from wound damage. Both types may combine to incapacitate a character, but temporary damage is a lot easier to regenerate.

END lost due to temporary damage will be regained each half hour at a rate equal to 1/10 the character's normal END score, under normal conditions. This recovery does not take place unless the character is resting. During rest, the character may not perform any strenuous or continued action (prolonged walking, lifting, combat, prolonged duty, etc.) Under certain conditions, such loss may regenerate entirely in a shorter period of time.

Exhaustion due to fatigue is a common way to take temporary damage. When performing certain strenuous activities, a character must make a standard % dice saving roll on the END attribute to avoid END loss through fatigue. If the roll fails, the character loses 5 END points to fatigue. A list of strenuous activities is below. Gamemasters should note that this list is not exhaustive; require END saving rolls where you think them appropriate.

#### **FATIGUE SAVE ON END REQUIRED FOR:**

**RUNNING** full speed (using double the amount of all available AP for movement only during any turn).

**EVADING** full speed (using all available AP for move-and-evade only during any turn)/ -20 to die roll for save.

**SWIMMING** during full turn.

**DIFFICULT TERRAIN**—using over ½ available AP for movement over rugged terrain such as steep hills, sand, snow, rubble, etc.

**COMBAT**—after any combat involving hand-to-hand or hand weapons (swords, knives, etc.) fighting, once contact with the enemy is broken.

All of the above activities require an END save (against normal END) to avoid the fatigue loss of 5 END points.

If character takes enough damage of either type, the result will be unconsciousness. Death can result from wound damage unless medical treatment is received. The point at which a character becomes unconscious is known as the **UNCONSCIOUSNESS THRESHOLD**, and it may differ from character to character, based on END.

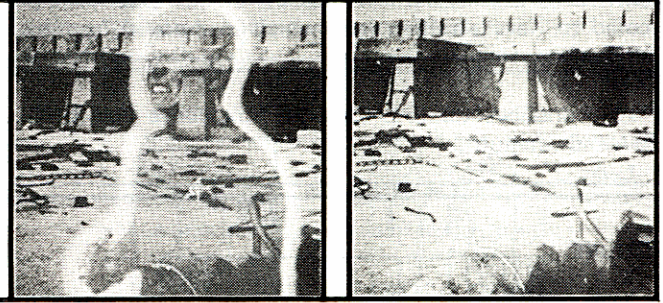

To determine the unconsciousness threshold, divide the character's END by 10, rounding down. If a character is brought below this END level at any time, by any means, unconsciousness results. Thus, a character with an END of 78 has an unconsciousness threshold of 7 points.

A character may lose consciousness long before reaching the threshold, however, from shock and pain or blood loss. When a character's END drops below ½ its normal value, a saving roll must be made against normal END. If the save is successful, the character may continue to function. If not, however, the character loses consciousness immediately.

Once unconscious, how long a character remains unconscious depends on the cause. A character who is rendered unconscious due to injury or exhaustion stays out for a number of minutes equal to 2D10+10. Phaser stun, heavy stun, and certain drugs may have different unconsciousness periods, which are specified in the appropriate section of the rules.

If, however, the character has been rendered unconscious by being reduced below the unconsciousness threshold, the END must be improved to above that threshold before the random period of time noted above can begin. In other words, a person who passes out from pain or shock is likely to come around by himself after a while. The person who passes out because he/she is near death, on the other hand, will not recover until the condition improves.

When the cause of unconsciousness is temporary damage (such as phaser stun or heavy sedation), the faster healing rate for this type of damage will cause a person to come above the threshold quickly. Physical injury, because it takes much longer to heal, may leave a character in a coma until medical help can raise his END.

Likewise, the cause of unconsciousness determines the condition of the character once the period of unconsciousness is over. Phaser stun and drugs have no lasting END effect. Once consciousness is regained, all END loss from these sources vanishes. Fatigue does not pass that quickly, however. Fatigue END loss is regained at the normal temporary damage healing rate. Wound damage is the worst of all, as it takes even longer to heal.

A character who is unfortunate enough to have the END score reduced to zero or below by wound damage is mortally injured. Unless medical help is speedily available, the character will die. Keep track of the number of points of END the character is reduced below zero as a negative number, as the extent of this damage is important in determining if the character can be saved. (See Medical Aid and Recovery.)



Temporary damage does not accumulate beyond the unconsciousness threshold, and any done thereafter is ignored. (Thus, you cannot stun further a man already stunned; you must wait until he is waking and stun him again.)

A few examples will help make unconsciousness, recovery and death easier to understand. Suppose during a battle near the Romulan border several Star Fleet officer are injured by Romulan hand disruptor fire, and several Romulans are captured after being hit with phaser stun. Below are the statistics of the men in question.

LT. CARSON: END=77	UNCON. THRESH.=7
ENS. YAMOTO: END=58	UNCON. THRESH.=5
ENS. TELEN: END=66	UNCON. THRESH.=6

SUBCMDR. MAVA: END=82	UNCON. THRESH.=8
CENTUR. HANTAL: END=73	UNCON. THRESH.=7

Romulan Subcommander Mava was hit solidly by a phaser on stun, which does 75 points of temporary damage. This brought him one point below his unconsciousness threshold. Phaser stun effect lasts a number of minutes equal to  $2D10+10$ , according to the weapons charts. Mava rolls 2 10-sided die for a score of 11 total, plus 10 for 21 minutes of unconsciousness. By that time, the one point of damage beyond the threshold will have regenerated, so that is when Mava will wake up. Once he does, he will have no END loss (permanent or temporary) from the stun effect. (It's sort of like passing out from too much alcohol, with no hangover.)

Hantal was grazed by a stun shot first, taking 25 points of non-permanent damage for a new END score of 48. He was not reduced below half, so carried on the battle and was grazed again. Now reduced to 23, he rolled a save on END and came up with an 84 on % dice. Hantal was then out for the count, and rolled a total of 7 on 2 10-sided dice, plus 10 for a total of 17 minutes of unconsciousness. He, too, will be at full END once he awakens from stun.

Carson was injured by a disruptor bolt which hit him solidly. He was reduced to a near death before he was found. Advanced medical techniques kept him alive, but he has a lot of healing to do. In a few days, he will heal to above his unconsciousness threshold and come out of his coma.

Yamoto was sent for reinforcements, having to run for miles across rough terrain. In so doing, he failed a number of saving throws for fatigue until his END dropped below half. He then failed his unconsciousness throw and passed out from exhaustion. Fortunately, he was not reduced below his threshold, so once his period of unconsciousness was over ( $2D10+10$  minutes), he woke up. He did regain some END lost from fatigue during his nap, but not all of it, so he had to slow down as he continued rather than risk missing another save and passing out again. Now, several hours after his ordeal, he is well on his way to feeling fine again!

Ens. Telen may get a citation for bravery under fire. He was struck a grazing shot by an enemy disruptor bolt (25 points damage, reducing him to 41; no save necessary yet), but stunned and captured the enemy officer anyway. Later, he was jumped in hand-to-hand combat by another

Romulan (taking 11 more points of damage; now he's less than half and must save vs. END or pass out), but overcame his injuries with a successful saving roll and subdued the enemy, making a second capture! He valiantly held off two more attackers until hit by another grazing disruptor shot (25 more points, bringing him to END 5) and rendered unconscious (because he's now below his threshold and must pass out). Fortunately, he was rescued by a group of reinforcements, and with prompt medical help is beginning his recovery!

One more note on unconsciousness and recovery. When a player character's life is threatened or unconsciousness on his part would cause some especially bad occurrences (such as the failure of an important mission), game-masters are urged to give a LUC save attempt. If the LUC save is successful, the player finds some inner reserve of strength and fights off unconsciousness. The LUC save is intended to give characters a last-ditch chance. Let Fate take a hand where necessary.



# Medical Aid and Recovery

The advanced medicine of STAR TREK's time can go a long way toward accelerating a character's recovery from END loss. There are limits to what even Dr. McCoy and his colleagues can accomplish, however. (For example, the condition of Captain Christopher Pike after his accident in *The Menagerie*).

A character who suffers mortal injury (END reduced to zero or less) will die if her/his condition is not treated promptly by a qualified individual. Emergency first aid is required to prevent death, and such can be provided by any character with Medicine skill.

Once a person with Medicine skill reaches the injured character, a saving roll on the Medicine skill appropriate to the race of the injured character must be made to determine if life can be preserved. If the only skilled medic available does not have the appropriate types of Medicine skill (such as someone with only the Medicine (Human) skill trying to aid an injured Vulcan), only ½ the available Medicine skill level is applied for the saving roll.

The saving roll is modified by a number of factors, including extent of damage below the zero level, the medical equipment available, and the amount of time that has passed since the character reached the zero level. These modifiers are shown in the table below:

## EMERGENCY FIRST AID SAVING ROLL

Make saving roll on appropriate Medicine skill, with the following modifiers to the number rolled:

+0	if no medical equipment available
-5	if using medical field kit or first aid kit only
-15	if using medical pouch (Star Fleet issue)
-25	if using modern Star Fleet sick bay facilities or equivalent
-5	if any skilled attempt has been made at first aid already (even if such attempt did not save the patient at that time)
ADD	time in minutes since zero level reached
ADD	damage beyond zero level

It is clear that time is of essence in saving the life of a mortally injured individual. Generally speaking, if transportation to Sick Bay would take more than 15 minutes, it is better to apply first aid on the spot, even if no equipment is available. Of course, only one person's Medicine skill level can be used here, so it should be the highest available. There is no adjustment for having assistants during first aid procedures.

If the roll succeeds, the injured character is stabilized at an END of 1. Further healing will take place at the normal healing rate, unless specific drugs or procedures are used to hasten the process. If the roll fails, the patient remains at the current mortally wounded level of END. Another attempt may be made if equipment or more skilled assistance becomes available, but time continues to tick

away. (Each attempt takes 5 minutes itself). If at any time the adjusted roll needed drops to zero or less, the patient is irretrievably dead.

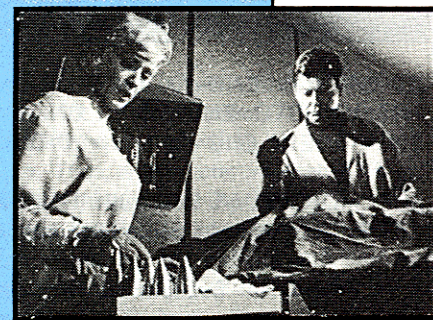

Again, an example will help illustrate the procedure. Ens. Carolyn Greentree is a security officer assigned to a landing party. While making her way through some rough, mountainous territory, she is injured in a landslide. Her basic END is 54, and she takes 57 points of damage, mortally injuring her. Without help, she will die.

The landing party, led by security chief Lt. James Hopper, cannot request immediate beamup, as local sunspot activity is making transporter lock-on impossible. Lt. Hopper calls for a medical team to be sent via shuttlecraft, but it will take 20 minutes for them to arrive. Meanwhile, Hopper, who has some medical training, decides to try and help Ens. Greentree.

Lt. Hopper is a trained paramedic, having a Medicine (human) skill level of 12. Unfortunately, he has no medical equipment to speak of. Hopper's player is pretty clever, however, and tells the gamemaster he will try and improvise splints and bandages out of his uniform shirt and fallen branches. This doesn't qualify as medical equipment but the gamemaster allows him a -3 modifier for such aid. (The gamemaster has considered the type of injuries; broken bones, concussion, etc.; when making his decision. For other types of damage, such measures might have been useless and no modifiers allowed for them.)

Besides the -3, there will be a +3 modifier for the 3 points damage Greentree took beyond her END score. (That is, her END was effectively reduced 3 points below zero level). In other words, the two modifiers cancel out, leaving Hopper trying to roll 12 or under to save Greentree with his improvised methods. There is no modifier for time, as Hopper started his efforts immediately, stopping only a turn or so to call the ship.

Hopper rolls a 15. Very close, but not low enough! The saving roll is unsuccessful and Greentree is still dying. There is nothing else to do but wait for the shuttlecraft, since no one else in the landing party has medical training.

When the shuttle arrives, Dr. Gerald Kaylor and his team decide to put Ens. Greentree aboard and return to the ship immediately to save time. During the 20 minute return trip, he uses a full medical pouch, and his Medicine (human) skill level of 69, in an attempt to stabilize Greentree's condition.



It has been about 20 minutes since Greentree was injured (+20 modifier to the number rolled), and she is still at END of -3 (+3 more to the roll), but Dr. Kaylor has a full Star Fleet med pouch at his disposal (-15 modifier) plus years of training. Hopper's initial efforts will help, too (-5 modifier for previous attempt). In fact, the game-master rules that Hopper's roll was so close, that he will allow an additional modifier of -5!

Kaylor rolls 73 on percentile dice.  $73 + 20 + 3 - 15 - 5 - 5 = 71!$  Dr. Kaylor finds Ens. Greentree's injuries are grave indeed, and he cannot stabilize her. It must wait for one final attempt on board ship in Sick Bay.

Once aboard, one final attempt is made to save Ens. Greentree. It has now been 40 minutes since her injury (+40), and she still is an END of -3 (+3 modifier). Full Sick Bay facilities are available (-25). Previous attempts have been made (only one -5 modifier is applicable, no matter how many attempts were made), and the extra modifier (-5) for Hopper's close roll is still in effect. Dr. Kaylor rolls % dice again, coming up with 58.  $58 + 40 + 3 - 25 - 5 - 5 = 66!$  It was a near thing, but Ens. Greentree's condition is stabilized at END of 1. She is badly hurt, but she will live.

When END is reduced to zero or below by injury (including such things as disruptor or blaster fire), the above procedure of first aid is the only way to improve the END above zero fast enough for the victim to live. The victim will not begin normal healing while the END is zero or lower! Diseases, poisons and certain other conditions may require the use of specific drugs or techniques which will directly affect the END, bringing it above zero and accelerating the end of this section, and development of others is discussed in the appropriate sections to follow.

## DISEASE

In **STAR TREK: The Role-Playing Game**, we divide diseases into two categories; acute and chronic. Each must be treated in a different manner.

An acute disease has a rapid onset (as short as several hours or as long as three days), a short course, and severe symptoms that start out mild, but gradually worsen as the disease progresses. A contemporary Earth example of of an acute disease is influenza, while an example of a chronic disease is cancer.

Many adventure situations can be built around diseases. The players may be required to deliver a serum of some kind to a planet suffering an epidemic, or a character might be stricken with a rare or unknown disease leading the players to search for a cure. The gamemaster must use imagination (as well as common sense) to create the conditions, symptoms, cures, methods of transmission, immunities, etc. related to a disease.

It is impossible here to give players and gamemasters a crash course in immunology, but a couple of examples will help gamemasters to learn to develop interesting (the players will use other words for it, certainly) diseases for their own campaigns. In addition, several diseases established in **STAR TREK** will be discussed in the medical glossary at the end of this section.

For an example of how a gamemaster might create a dangerous acute disease, we will work with the Symbalene

blood burn. Symbalene blood burn is mentioned briefly in the **STAR TREK** episode *The Changeling*, but we learn nothing about it except the name, and that it is considered to be a fast-acting, highly infectious disease. In this example, we will create a set of data for this disease so it can be used in a campaign.

Symbalene blood burn is a viral disease native to the planet Symbalus IV. It is transmitted by touch and has a very short incubation period (7 to 10 hours) before symptoms begin to appear.

The symptoms include a sharp rise in body temperature, severe internal pain (an abdominal burning sensation), destruction of red blood corpuscles and extreme reddening of the skin followed by bleeding from the pores. The disease is 97% fatal within two days.

Humans and other species with iron-based blood are affected. (Vulcans, Edoans and Andorians are immune—their blood chemistry is different). A person who contracts the disease and survives thereafter has total immunity.

The only real cure is an injection of antibodies. Antibodies for the blood burn can be produced artificially by large commercial medical laboratories, but the material is perishable. A certain amount can also be produced from the donated fresh blood of a survivor of the disease (about 1 injection per 2 pints of blood). Massive blood transfusions, periodic injections of tri-ox compound, and lowering body temperature will slow the progress of the disease.

In game terms, the disease has the following effects. Each time a susceptible character touches a diseased individual (or a recently dead victim of the disease), he/she is exposed and must roll an END save on % dice. Because blood burn is so virulent, a die modifier of +30 is added to the roll before comparing to the END attribute. This addition (but not the END save itself) is avoided if the character can make a LUC save first. If the END save fails, the disease is transmitted to the character. The rolls to catch the disease should be made by the gamemaster secretly! Thus, if the player is exposed, he will not know whether or not he has caught the disease until the symptoms start to appear.

The incubation period is 7 hours minus the character's END in minutes. Near the end of this time, the character will begin to feel a bit hot and feverish. When the incubation period is over, the disease strikes full force. A high fever results, and the character takes 4D10 points of END damage from it unless steps are taken to keep the body temperature down. (Using fever reduction drugs or drastic measures such as packing in ice will hold this damage to 2D10.)

At the end of the first 24 hours after incubation, the character takes another 6D10 points of damage from bleeding (from the pores) and oxygen starvation (as the

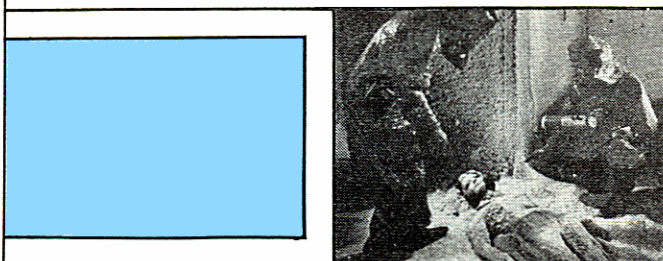

lungs begin to shut down). This damage can be reduced to 3D10 by administering blood transfusions and tri-ox compound. At the end of the second 24 hours, another 6D10 points of damage are taken as before, with the listed remedies having the same damage-reducing effects. Should the character survive this long, no further damage is taken and normal healing begins—the disease has run its course.

If an antibody injection is available, administration of one at any time after symptoms develop will prevent all further damage and normal healing begins. A vaccine is available to protect against Symbalene blood burn, but a booster must be taken every year. Since the disease is so rare, it is unlikely (3 chances in 10—roll a 10-sided die) that the average crewman will be up on his vaccinations unless he expects to be exposed.

Most larger Star Fleet ships should have supplies of the vaccine. Vaccination is useless once the disease is already contracted; then antibody shots are necessary. A well-equipped medical lab (as is found aboard such ships as the U.S.S. Enterprise) could process and prepare antibody injections, if blood donors can be found who have had and survived the disease. (Even on a large ship, however, there are not likely to be more than two or three such people!) Larger supplies would have to be transported from a starbase or some planet with advanced medical technology and industrial drug-making capacity. By then, it would likely be too late, if such a place is not nearby.

A chronic disease would work much more slowly, and be more difficult to cure. Let's create a totally fictitious disease, Jordan's Syndrome, as an example.

Jordan's Syndrome (named after the discoverer, the reknowned medical researcher Dr. David Jordan) is a wasting disease caused by the breakdown of a natural hormone in the human body. No other races are known to be susceptible, but it is suspected that certain hybrid-race individuals might prove susceptible as well. The first symptoms are increasingly frequent spells of dizziness, followed by a gradual loss of strength and coordination which eventually causes death. There is no known cure, but a periodic injection of the hormone in question can delay the final stages nearly indefinitely.

In game terms, this disease is very simple to implement. As Jordan's Syndrome is extremely rare, it would be up to the gamemaster to inflict it upon a character as he sees fit. It is not something that can be caught from a victim. This is a disease or condition more like diabetes, and may be genetically linked in some manner.

When the symptoms begin, a dizzy spell will occur lasting a number of turns equal to 2D10 (rolled by the gamemaster secretly). During this time, the character must roll a saving roll on ½ their normal DEX to even perform simple actions correctly! All other saving rolls on skill levels are halved (either randomly or on a pre-set schedule), but such attacks will start infrequently and become more frequent and last longer as time goes by.

After 2D10+5 weeks of game time, the character rolls 1D10, divides by 2 and rounds down, and subtracts this number from the character's STR. Do the same to DEX and END. The dizziness attacks also continue at intervals. If the character's END is allowed to drop below the unconsciousness threshold, the character goes into a coma.

Without treatment, the disease will continue to progress until the character dies.

Once the disease is diagnosed, regular shots of the hormone (1 per week) will stop further deterioration of STR, DEX and END and end the dizzy spells. The damage will not regenerate even with the shots, so the sooner the disease is diagnosed and the shots begun, the better!

Any person with a minimum skill level of 20 in the appropriate Medicine skill can automatically recognize a common disease after a thorough examination. Less common diseases require a saving roll on the Medicine skill level. The availability of a medical laboratory and medical library better the chances of diagnosis by 20 points. The gamemaster makes the diagnosis save secretly. If the roll is fairly close, the gamemaster may give partial information. If the roll was not particularly close, no information is given. If the roll was way off, however, the gamemaster may decide to give wrong information which might cause incorrect treatment to be administered. Incorrect treatment has no effect, or may actually hurt the patient!

Note that first aid is of no real help against diseases. If specific treatment against the disease is not administered, the disease will take it's toll. Please remember that the vast majority of diseases are not fatal. A character may just take some damage before the disease runs its course. Such damage heals just like wound damage once the disease has run its course. Chronic diseases linger, but acute diseases are over in a few days or weeks at most.

If a disease is unknown, it will not be found in the medical records. A medical officer must then go to the laboratory and try to determine causes and cures. A character must have an appropriate Medicine skill of 30 or better to do medical research on an unknown disease.

A saving roll can be attempted for every four hours of research. The research save is made at 1/4 the character's normal Medicine skill, making this a difficult roll indeed! In addition, a further die modifier of 1 point is added for every previous attempt that has failed. Thus, the roll gets harder and harder. Eventually the modifiers may accumulate until the character requires a roll of less than 1 to succeed. At this point, the research has run into a blind alley. No further attempts may be made by that researcher until such time that some new evidence or information becomes available. The gamemaster may wish to supply such information as part of the campaign action at this time. Then the procedure begins over again from scratch.

If a roll is successful, the cause of the disease is discovered. Further research may have to be done to find a cure, however. Half the time (roll randomly or flip a coin) the cause directly implies the cure, and the cure is found immediately. Otherwise, continue the research procedure until a second save is made.

The gamemaster should decide ahead of time on a cure or effective treatment for his "unknown" disease. It is possible to have a disease that absolutely has no accessible cure, but it is usually a bad idea to inflict such a disease in a role-playing game situation, especially on player characters. How difficult the cure or treatment is to secure and administer is up to the gamemaster.



## POISONS

Poisons are another health hazard that may be encountered while exploring the planet of the final frontier, and characters and medical personnel must be prepared to deal with them. Unlike disease damage, poison damage can usually be treated with first aid methods to some extent (induction of vomiting for some oral poisons, dilution of others, drawing out poison from bites by mouth or suction device, etc.). It is better to treat poisonings with specific methods where possible, however.

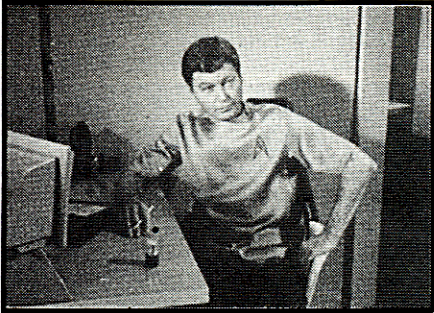

In this game, there are three basic types of poisons. Simple poisons are fast acting and leave little (if any) residual effect. They do from 1D10 to 5D10 of damage with such damage subtracted from END only once. Complex poisons are also fast acting, but their effects tend to last longer. A complex poison should do less damage at one shot than a simple poison (1D10 minus 5 to 2D10). This is subtracted from END as well, but is subtracted 1D10 times at intervals of 1D10 minutes between attacks until the poison is neutralized or all attacks are finished.

A specific poison affects one or more attributes other than END, leaving the rest alone. They may be of either simple (doing damage once) or complex (doing damage several times in multiple attacks) type. Specific poisons may affect a character's STR, DEX, INT or any combination of these. If a character's STR or DEX is reduced to zero in this manner, that character may perform no useful action at all (even standing up). If INT is reduced to zero, no action may be undertaken, nor can the character communicate in more than a few slurred mumbles. A poison that reduces INT may or may not have permanent effect, according to the gamemaster's intent. STR and DEX reducing poisons never have permanent effect. These attributes return to normal at  $\frac{1}{2}$  the character's usual wound damage END healing rate.

Antitoxins and antidotes may halt and/or cure damage done to a character by poisons. Some antitoxins and antidotes work against poisons introduced into her/his game. In some cases, a specific antidote may only work part of the time (a percentage chance, determined by the gamemaster and rolled on % dice).

An antidote for a simple poison will restore all or part of the damage done by that poison. This would be the same for either ordinary or specific poisons. Antidotes for complex poisons usually halt any further damage, and may also restore part of the damage already done. Assuming a character survives, damage done to END will heal normally, as for wounds.

Poisons can be encountered in various ways. They may be ingested with food or drink (or as food or drink, if a character nibbles the wrong kind of leaf on an unknown world.) They may be breathed in (like poison gas or spores), or taken taken in by touch (like poison ivy irritant) or injection (such as the bite of a poisonous animal). It is up to gamemaster to determine how successful first aid will be on a poisoned person, depending on the type of first aid administered by personnel on the scene. A character reduced to END of zero or less by poison may yet be saved either by quick administration of an appropriate poison antidote or by application of relevant first aid, as for wounds.

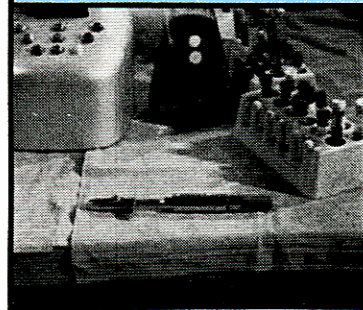



## STAR FLEET MEDICAL EQUIPMENT

There are two types of field medical sets used by Star Fleet personnel. These sets and the items they contain are listed below:

### Field Kit

Contains spray dressing, Feinberger, and hypo with small drug supply, including 6 doses each of light and medium sedatives, light and medium stimulants, Coradrenaline, Dylovene, Sterilite and Tri-ox compound. These items are carried in a small pouch with a fold-over top carried on the belt in the back under the uniform shirt.

### Med Pouch

Contains all of the above, plus a larger spray dressing, protoplasers types 1 and 2, laser scalpels and other field surgery equipment, and a larger drug supply including six doses each of generic heavy sedatives and stimulants, Hyronaline, Masiform-D, and a neural paralyzer. Also included are six extra doses of light sedatives and stimulants, Tri-ox compound and Sterilite. All of this is contained in a larger roll-up pouch with pockets, which can be carried in a shoulder sling.

Other items can be carried by a medical officer on landing party duty if he deems them necessary, with the approval of the Chief Medical Officer. Unless otherwise stated before leaving the ship, however, no items but those listed above are contained in the kits.

The field kit is always carried by medical officers on duty, even sometimes aboard ship, according to the wishes of the Chief Medical Officer. The larger med pouch is issued when medical help of an unspecified nature is expected to be necessary, or when the landing party is expected to have to make camp. Medical officers also carry medical tricorders when with a landing party on exploratory duty, or when expected to have to make field diagnosis. Medical officers usually do not carry sidearms of any type, but this is really up to the Chief Medical Officer and the Captain to decide on a case-by-case basis.

## MEDICAL GLOSSARY

The following glossary lists the names and descriptions of equipment and many drugs used by Star Fleet medical personnel. Each entry also specifies the effects such equipment has within the game.

**BIOCOMPUTER:** A portable unit about the size of a common portable television set. The biocomputer may be used to analyze samples of tissues and other substances and to process biological data. It can be tied into the ship's computer through a link with any communicator. To use the biocomputer, a character must have a Medicine skill level of 20 or more.



**CARDIOSTIMULATOR:** A future version of today's defibrillator, used to restart a stopped heart. The cardiostimulator is less of a shock and more dependable, however. A character reduced to END of zero or less through some kind of heart failure or shock (like electric shock) may require a successful application of this unit to be revived (gamemaster's option). A save vs. Medicine skill level is required to use this device successfully, and a minimum skill level of 20 is needed to know how it is used at all.

**CRYOSURGICAL FRAME:** This frame is placed over all or part of a patient's body to slow the patient's metabolism and body processes through use of cold. It is useful during surgery, but must be used under the supervision of someone with a Medicine skill of 40+.

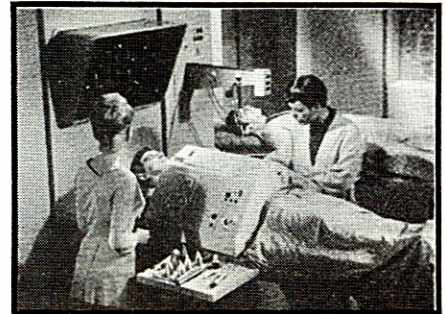
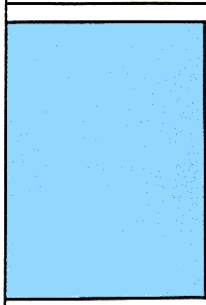

**DIAGNOSTIC TABLE AND PANEL:** This is the diagnostic bed as seen in the U.S.S. Enterprise Sick Bay. It continuously scans the patient for blood pressure, pulse rate, respiration, brain activity and other essential information and shows these on sliding scales on the face of the panel above the bed. Anyone can read the scales, but only someone with Medicine skill of 10 or more will be able to tell very much from them.

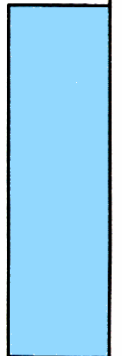
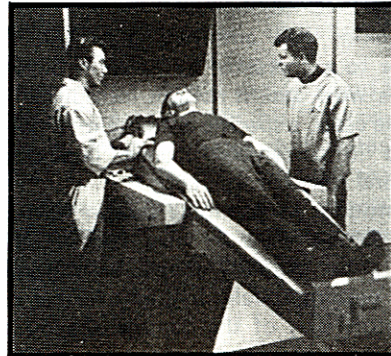
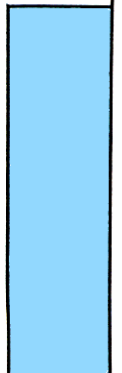
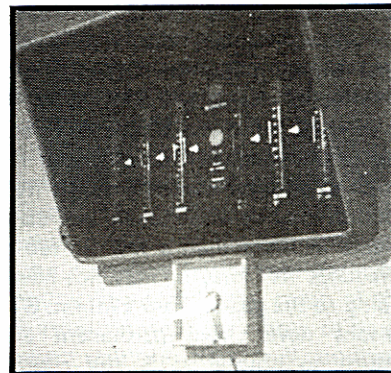



**FEINBERGER, MEDICAL:** Sort of a portable version of the diagnostic bed, in a palm-size unit. With a five-second scan, it gives a reading on heart rate, blood pressure, respiration, and body temperature of the patient. Anyone with a Medicine skill of 10 or more can use one.

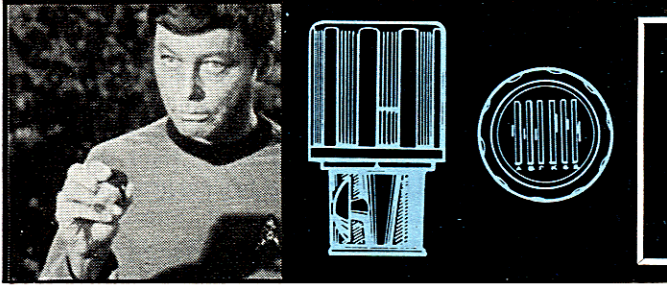

**HEARTBEAT READER:** A more sophisticated and specialized device than the Feinberger, this microphone-shaped instrument gives a digital readout of a patient's heartrate after a five second scan. It also contains a transmitter capable of tying in with the ship's medical computer (on board ship only) for correlation of data. This feature was used to "mask" the heartbeats of bridge personnel and reveal the presence of Lt. Cmdr. Finney aboard the U.S.S. Enterprise in the episode *Court-martial*. Medicine skill of 20+ is required for use.

**HYPO:** Short term for a hypodermic syringe. The STAR TREK version is actually a high-pressure pneumatic device that injects substances through the skin painlessly, without a needle. Almost all drugs can be injected in this way. Common drugs given in smaller doses are contained in micro-injector vials of several doses. Other less common drugs are attached in larger transparent or translucent vials before injection. Anyone with Medicine skill of 10+ can fill one, and anyone who is shown briefly how to handle it can give an injection under normal circumstances.

**LASER SCALPELS:** There are six types available. Scalpels designated 000-1, 00-1 and 0-1 are all single beam lasers, with the beam adjustable to 1, 1.25 and 1.5 cm. focal lengths respectively. These cut in a solid line from scalpel tip to end of beam. Scalpels designated 000-2, 00-2 and 0-2 are triple beam versions of the above with the same focal lengths. These cut only at the focal point, and are often used for vaporizing small growths. Each type (000, 00 and 0) have increasingly larger beam diameters. Generally speaking, Medicine skill of 40+ is necessary to perform surgery.

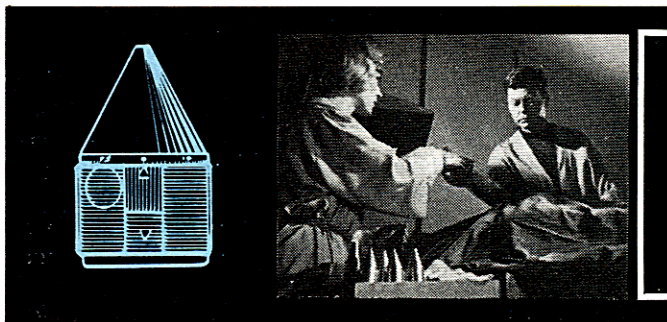

**PROTOPLASER:** Heals wounds without stitches, sutures, etc. and comes in two types. The small type 1 'Plaser is used for connecting small blood vessels and nerves. The larger type 2 model is used for closing connective tissue, muscles and epidermal (skin) layers. These devices will heal ½ the END loss from any wound doing less than 10 points of damage with a five-minute application. (Anyone with a Medicine skill of over 10 can use one for this purpose.) For more involved healing and surgery they are also used, but such use is factored into the already listed medical rules. Anyone with Medicine skill of 20+ can use a protoplaser for normal wounds, but major blood vessels, nerve tissue and delicate work requires a 40+ skill level.

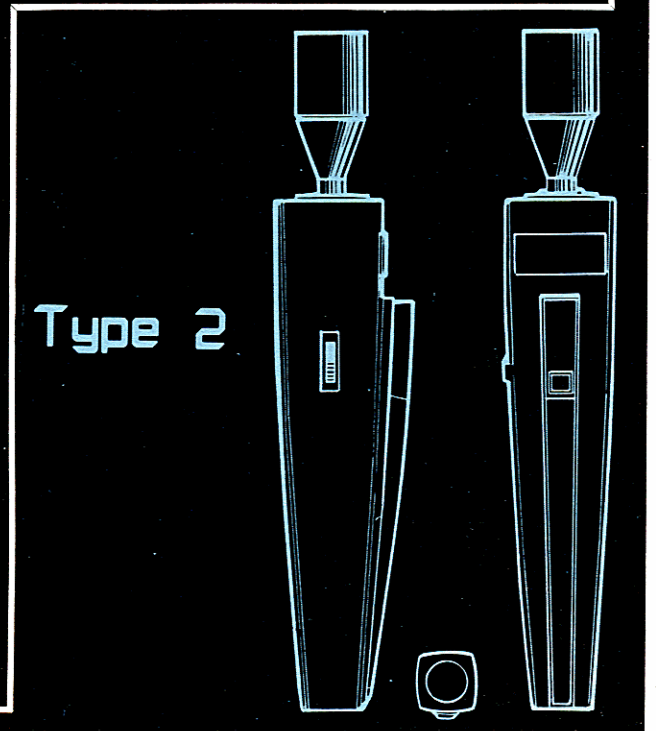
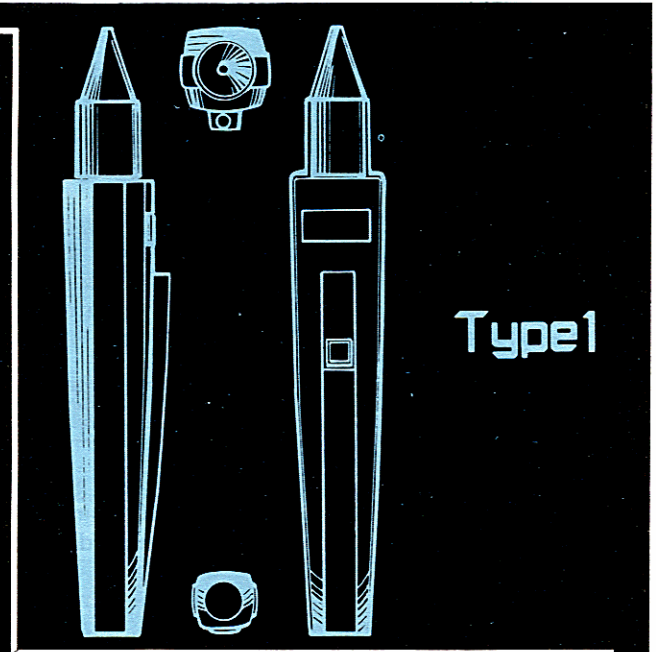

**SPRAY DRESSING:** Sprays a plastic/synthetic "skin" over a wound, which stops superficial bleeding and contains an antiseptic and anesthetic agent. When a wound heals, the dressing is absorbed. Anyone with a Medicine skill of 10+ may apply such dressings.

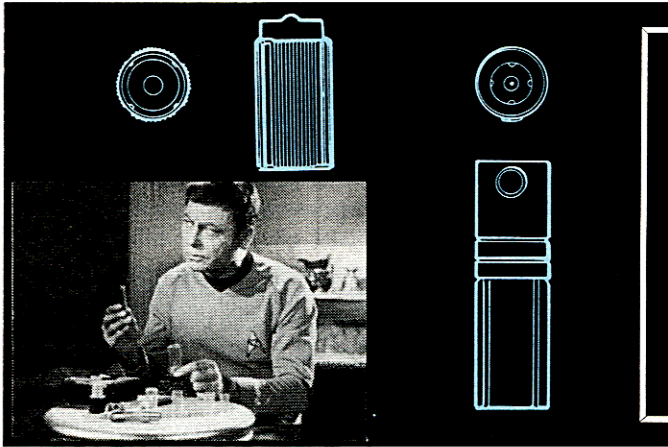

**TRICORDER, MEDICAL:** The use of the medical tricorder is discussed at length under Tricorder in the equipment section. Basically, it provides life sciences scanning functions and basic life signs monitoring in the field. It also has some limited use as a lie detector.

### SPECIALTY DRUGS

**CORADRENALINE:** Somewhat effective against exposure and frostbite. Will neutralize 2D10 points of damage from cold-based sources, and cuts further damage suffered by ½ for the next 3 hours.

**CORDRAZINE:** A heavy stimulant (see **GENERIC DRUGS** section for effects). An overdose (3 x normal or more) will cause severe mental imbalance and a feeling of acute paranoia. The effects last for anywhere from a few hours to a week, at gamemaster's option, depending on the size of the dosage and the END of the character.

**DYLOVENE:** A poison antitoxin sometimes (50% chance) effective against simple or complex plant poisons (not specific poisons). Check for effectiveness against any new plant-derived poisons encountered. If the roll is successful, Dylovene will cure 2D10 points of damage.

**FORMAZINE:** A light stimulant (see **GENERIC DRUGS** for effects) which can cause irritability (not dangerous to the patient, in itself) if administered in larger doses (2 x normal dosage or more).

**HYRONALINE:** For treating radiation sickness. Halts damage from radiation sickness (a form of poisoning, actually) and neutralizes 3D10 points of radiation END loss per day of use.

**MASIFORM-D:** Antidote against most muscle-relaxant type poisons (specific poisons affecting DEX and STR). Muscle relaxant poisons like curare work on the involuntary muscles such as the heart. Masiform-D will neutralize 5D10 points of END loss from such poisons, but has the side effect of causing nausea.

**MELANEX:** A light sedative (see **GENERIC DRUGS**) that has the side effect of causing a vivid yellowing of the skin while the victim is under its effects.

**NEURAL PARALYZER:** A type of drug used to simulate death. 1D10+5 minutes after injection, the character goes into a death-like coma that cannot be distinguished from death without sophisticated instruments such as a medical tricorder or diagnostic bed. The coma will continue until any stimulant is administered, whereupon the character returns to normal. The drug is somewhat dangerous, as if the stimulant is not administered within a number of minutes equal to the character's normal END, death will result.

**RYETALYN:** An antidote for Rigellian Fever. It must be absolutely pure to be effective. Halts all damage from this disease and begins normal healing process.

**STERILITE:** Used to prevent infection during surgery or wound treatment. A powerful antibiotic, but safe for use by almost any humanoid species. Especially useful for surgery in the field when conditions are less than ideal.

**TRI-OX COMPOUND:** A very useful substance for treating any sort of oxygen starvation, including landing party operations on planets with thin atmospheres or low oxygen content. (See planetary generation data.) On such worlds, an injection of Tri-Ox every three hours to avoid loss of END due to fatigue caused by lack of sufficient oxygen. Also useful during first aid treatment of decompression victims, and against any anaerobic disease organism or any disease inhibiting breathing. Tri-Ox is actually an organic fluorocarbon containing extremely high levels of oxygen in solution. It releases its oxygen for use in the bloodstream almost instantly.

### GENERIC DRUGS

There are two important types of generic drugs (that is, drugs where we are not specifying particular names) that have a great effect on the game—stimulants and sedatives. Often in episodes of *STAR TREK*, Dr. McCoy would need to administer a stimulant to a wounded, perhaps unconscious man because his advice or presence on the bridge was vital to the survival of the ship. Just as often, a sedative had to be applied (sometimes by surprise from a concealed hypo) to a guard to keep him quiet for a time.

The use of stimulants and sedatives must be carefully controlled by the gamemaster (much as real drugs must be controlled) to avoid unbalancing the game. They can be highly useful as a plot device or last-minute aid, but their use should be severely restricted.

Stimulants (in game terms) provide a temporary boost in END. Such a boost may revive an unconscious man (temporarily) or allow an exhausted character to continue to function without rest, but they take their toll in the long run.

There are three types of stimulants, classified by strength. A **LIGHT STIMULANT** adds 1D10 to END for a number of minutes equal to the character's original END score. A **MEDIUM STIMULANT** adds 2D10 and lasts twice as long. A **HEAVY STIMULANT** adds 3D10 and lasts three times as long.

If giving a stimulant to an unconscious person brings END above the unconsciousness threshold, consciousness is regained for as long as the stimulant's effects last. The



END score then returns to the original depressed state. This means that even a light stimulant will awaken a person who passed out before reaching the unconsciousness threshold. Unlike the more badly injured character, such a person will stay conscious unless END is dropped below the threshold by further injury.

When stimulants wear off, however, an END saving throw must be attempted. (A basic save on original END for a light stimulant, a more difficult roll with a +10 modifier for a medium stimulant, and a big +25 modified save for a heavy stimulant.) If the roll succeeds, there is no effect on the system (other than loss of the temporarily gained END boost) when the drug wears off.

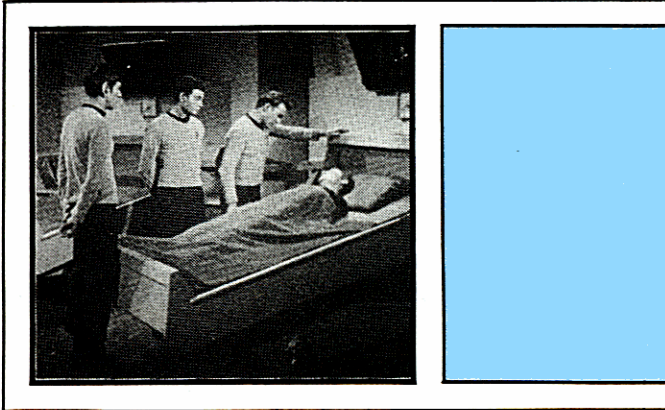

If the roll fails, however, the shock to the system caused by the stimulant does a certain amount of damage (treated like wound damage or disease damage) to the character. (1D10 minus 5 for a light stimulant, 1D10 minus 3 for a medium and 1D10 for a heavy stimulant. Final result of zero or less means no damage was taken after all.)

Thus stimulants are used only when absolutely necessary, and are carefully controlled by the wise game-master and the prudent medical officer.

Sedatives are also divided into light, medium and heavy types. They produce a temporary reduction in END which is treated much like fatigue. A LIGHT SEDATIVE reduces END by 2D10+10 for 2 hours. A MEDIUM SEDATIVE reduces END by 2D10+25 for 4 hours. A HEAVY SEDATIVE drops the END score by 2D10+40 for 6 hours.

If a sedative drops END below the halfway point, the character must make a normal saving roll to avoid unconsciousness. If the score drops below the unconsciousness threshold, loss of consciousness is automatic. When the sedative wears off, the END returns to its previous level (counting in any normal healing while unconscious).

There is a danger in using a sedative, however. If a sedative's effect would drop a character's END below zero, keep track of how many points below the END would go. Make an immediate saving roll on the character's full normal END minus the number of points below zero caused by the sedative effect. If the save fails, the character has been overdosed. The END level then actually does drop (as with wounds and disease) to the level below zero that was recorded. The character is in mortal danger and will die without medical attention and successful emergency first aid. (See EMERGENCY FIRST AID in the medical section).

The use of stimulants and sedatives is very tricky business. Only someone with a Medicine skill of 40+ (the equivalent of an MD degree) is allowed to administer them. Gamemasters are encouraged to keep a close eye on their use and find ways to discourage players if they misuse them to unbalance the game.

There is one other minor type of generic drugs classification that deserves mention. Since about 1/3 of the civilian population is adversely affected by zero-gravity, all Star Fleet sick bays have supplies of drugs to combat zero-G sickness. This malady is unlikely to afflict an Academy graduate or other experienced spacehand, nor is the situation likely to arise on board ships with artificial gravity. Nonetheless, if a civilian is exposed to zero-G for the first time, roll % dice. A score of 35 or less means the character is immediately stricken with zero-G sickness. STR, DEX and INT are effectively halved until gravity is restored or zero-G sickness drugs are administered. A dose of the drug eliminates the bad effects of zero-G for about 4 hours.



FIELD KIT

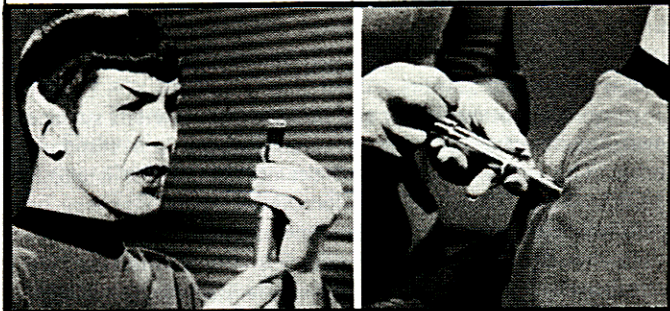

HYPO

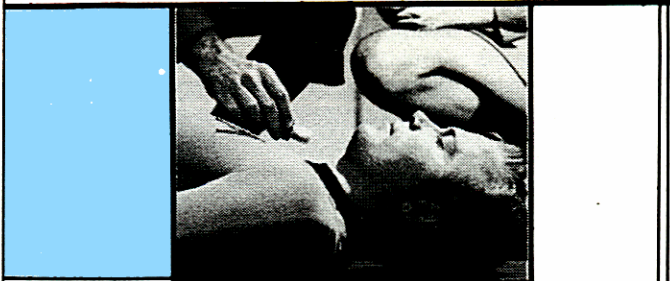

SCANNER



# Equipment

In this section, description of many common pieces of Federation Star Fleet issue equipment will be provided, including data on how to incorporate the equipment into your campaign. Although the equipment under discussion specifically is Federation issue, where similar equipment is available to non-player races the differences in such equipment will be mentioned.

**ANTIGRAV, PORTABLE:** Small hand-held devices with magnetic clamps or sticky pads. These units are attached to heavy equipment for moving it easily from place to place by neutralizing it's weight. A single antigrav can analyze and exactly compensate for up to 100 kilograms (about 220 lbs.) of mass. Several antigravs may be attached for more massy items. Antigravs cannot be set to produce a negative gravity effect. Objects attached to them have no effective weight, though, and can be suspended in mid-air, unsupported.

**AQUALANTERN:** A small hand-held light source that can be safely used underwater. Illuminates an area 10 meters cubic.

**BELT LIGHT:** A light source used by landing parties that fits around the waist as a belt, shining a light ahead of the wearer about 100 meters. These lights are useful because they illuminate while leaving hands free for other operations.

**COMMUNICATOR.** A palm-size voice transmitter/receiver used by Federation Star Fleet personnel, especially on landing parties. A Federation communicator looks like a small black box with a flip-open lid that serves at the unit's antenna grid. The voice circuit is automatically opened (with a characteristic soft beeping sound) when the grid is flipped up.

The communicator can be used on a planet's surface over line-of-sight distances, or to contact a ship in standard orbit. The maximum range of the communicator is about 16,000 miles (about 26,00 kilometers). The signal may be blocked by atmospheric disturbance, intervening terrain (like mountains), or dense materials. Communicators are not usually used aboard ship because strategically placed communications panels are more convenient.

Several channels are available on a Federation communicator, and one can select which other communicators to call. If a communicator is signaled, it beeps for attention.

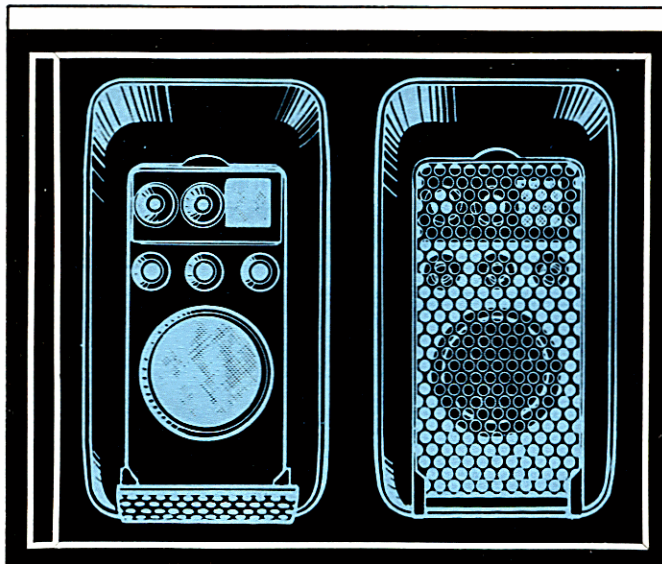
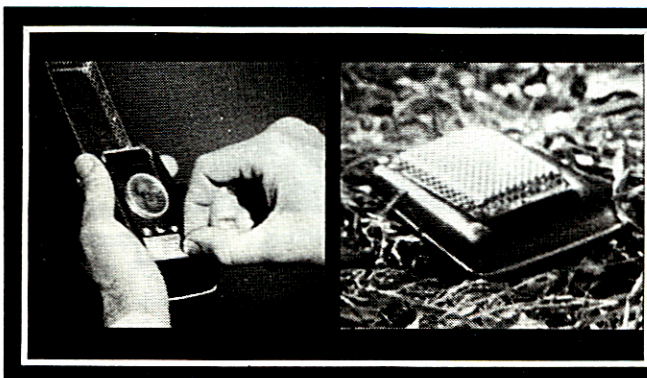

The Federation communicator also serves as a locating device for operation of the transporter. A communicator can be triggered to send a homing signal as well. The communicator also can be plugged in with other equipment to send data from portable data-gathering instruments to the ship for processing by the ship's computers.

Most starfaring cultures use a similar device to the Federation communicator. The Klingon version (used also by the Romulans, in a slightly different form) combines some of the functions of the Federation communicator and the Tricorder, in that it is capable of scanning for nearby energy sources (See TRICORDER).

**EARPIECE RECEIVER:** Used on the bridge and in engineering areas of larger ships, the earpiece receiver is a small earphone (molded especially to fit a crewperson's ear comfortably) which allows private reception of voice transmissions without distracting outside noise. The receiver is wireless, but has very little range and is never used out of the sight of a communications panel. These are most often worn by communications officers on duty.



**Earpiece Receiver**

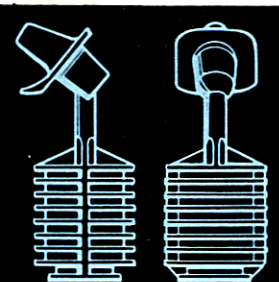



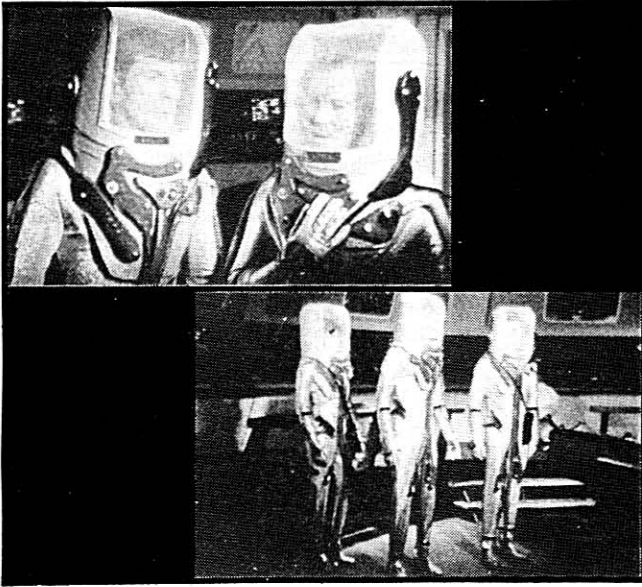

**ENVIRONMENTAL SUIT:** A "space suit" that maintains a self-contained artificial environment—air, heat and pressure—for up to 24 hours. The suit is used where maximum protection is required, and is safe for vacuum, environments with unlivable heat or cold, or poisonous atmospheres. The helmet is transparent all around, affording a clear 360 degrees view for the wearer.

Environmental suits are not particularly uncomfortable, but they are a bit bulky and require a bit of training to use properly. A skill level of 10 or more in Environmental Suit Operations is necessary to use one. With that skill level, normal tasks can be performed. To run, jump, fight, or do anything strenuous or requiring manual dexterity while wearing a suit, one must make a standard saving roll on the Environmental Suit Operations skill level. Failure indicates the action attempted has failed in some manner.

Environmental suits are self-sealing — it would be difficult to tear one. In fact, a standard spray hypo can be used right through the sleeve! The suits are no protection against modern energy weapons. Klingons, Romulans and other starfaring cultures can be assumed to have similar suits.

**FORCE FIELD BOX:** A special box with an interior force field that can be used to transfer and transport antimatter samples. The interior field can be switched on and off by remote control.

**I.D. CARD:** A small plastic card (the size of a credit card) with a small holographic picture of the bearer and molecularly coded information about the user. These are used to activate security locks on most Federation vessels and to provide other data about the bearer quickly (retina patterns, blood type, medical history, security clearances, etc.) These cards are made by the ship's computer and are very difficult to forge, but one could be altered by someone with the right tools and skills. (Requires a Forgery skill saving roll at a +30 penalty to the roll, plus electronic erasure and inscribing tools to change the existing information on an I.D. card.)

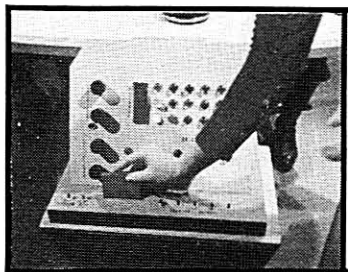

**LIFE SUPPORT BELT:** A wide, thick belt that provides a glowing greenish-yellow force field around the wearer for up to 4 hours. A person in the field is provided with air, heat, and pressure in space, hostile environments, and underwater. Not bulky like the environmental suit, the belts are still somewhat experimental. Their main drawback (aside from the fact that it is impossible to hide while wearing one because of the glow) is their vulnerability. A major impact (one doing over 10 points of damage) can cause the belt to malfunction and fail. Thus, they are not to be used in combat situations. So far, these units are only in use by Federation personnel on board larger ships, such as the U.S.S. Enterprise.

**LIFE SUPPORT MASK:** Breathing masks worn where bulkier or more fragile life support equipment is not needed. These can be used to remedy the effects of thin or thick atmospheres, to filter out harmful substances in the air, or whenever protection from airborne contaminants is necessary. The masks filter and adjust pressure, powered by a tiny energy cell that needs to be recharged or replaced only about once a month. The masks will not provide oxygen where there is none, however.

**PSYCHOTRICORDER:** This complex scanning device is about the size of a breadbox, and can only be used by a qualified technician. (Appropriate Psychology skill 50+, and Computer Operation skill 40+.) Its function is to scan the mind of the subject to obtain a detailed account of what the subject experienced during the past 24-48 hours.

The results of a psychotricorder scan are always 100% correct, but getting a good scan can be difficult. The operator and subject must be alone in a quiet place with no distractions. Successful saving rolls must be made on both the Psychology and Computer Operation skills at a penalty of +20 to the roll, or no information is gathered. According to Federation law, the subject must agree to the test, but once begun the true experiences will come out, despite any mental effort by the subject to conceal them.

The psychotricorder is a fairly recent development of Federation technology. It is believed that no other known starfaring group possesses a similar device.

**SUBCUTANEOUS TRANSPONDER:** This is a miniature transmitter which acts as a homing signal and a transporter lock-on aid in the same way as the communicator (though it cannot be used for voice communication). The device is inserted just below the skin, and is used by landing parties in possibly hostile areas where standard communicators might be confiscated, or where such devices would look too out of place.

The subcutaneous transponder has the same range as a communicator. These are also still in the semi-experimental stage, and are only in use aboard larger exploration and military vessels. A sharp blow (10 points or more of damage) to the area of insertion (usually the arm) will disable the transponder unless a LUC saving throw is made successfully by the wearer. A qualified doctor (Medicine skill 40+) is required to insert them, but they can be removed safely by anyone with a small penknife without significant harm.

**TRICORDER:** See separate rules material at the end of this section.

**UNIVERSAL TRANSLATOR:** A hand-held device looking much like a flashlight with a microphone grid at one end. This unit contains a sophisticated linguistics computer capable of translating most alien languages

spoken by humanoids. The translator must "listen to" enough of a totally new language to get the general idea of syntax, word meanings, etc. Usually, a half hour is sufficient, and this may be accomplished before leaving the ship if broadcasts can be picked up or conversations can otherwise be recorded.

## Universal Translator

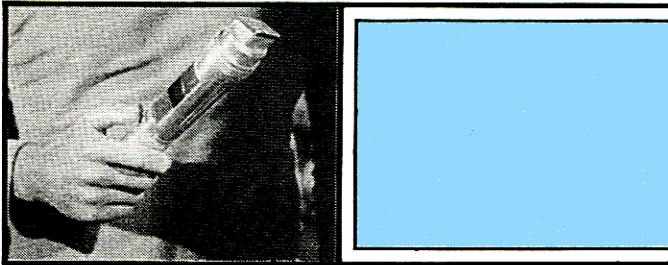
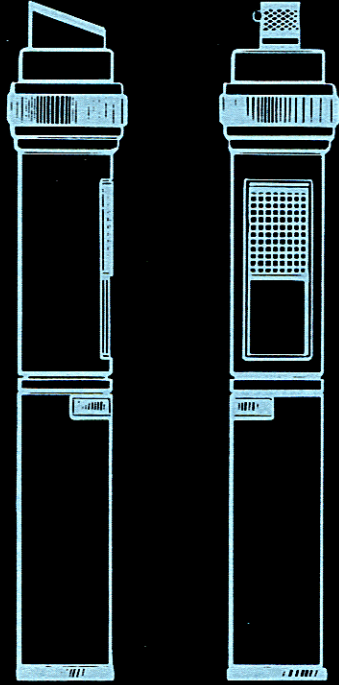

In many cases, however, a humanoid language that is similar in structure to a known language can be translated almost immediately. Even some non-humanoid tongues can be translated by this device, as long as the language is sound-based, rather than communicated by flashing lights or waving tentacles.

In the game, a roll of 30 or less on % dice means the language can be immediately translated. This gets easier by 10 points for each half-hour of conversation the device "overhears" or is fed in advance. A 10 point penalty is in effect if the language is spoken by a non-humanoid species.

The ship's linguistic computer banks can translate virtually any tongue in a matter of minutes. If this translation has taken place before a landing party is beamed down, the structure for the language will already be programmed into their hand-held translators when they beam down.

## TRICORDERS

The tricorder is the most versatile and widely-used data gathering and recording mechanism in the known galaxy. It is an invaluable tool for gathering information about one's immediate environment.

There are two major types of tricorder in widespread use on Star Fleet vessels—the MEDICAL TRICORDER and the SCIENCES TRICORDER. Both behave similarly, but are designed for different types of scanning.

Both the above types of tricorder will serve as simple sight-and-sound recorders, useful for making supplementary log entries, recording the observations of a landing party on the scene, or gathering evidence about a location for later viewing aboard ship. The tricorder can be set to record automatically, and can store up to 2 hours of continuous sight-and-sound data on each of the 8 molecular memory discs normally installed in it.

Tricorders can also scan for various types of specialized data (depending on the type of tricorder used). A quick 360-degree scan takes two full combat turns (about 20 seconds). A scan in a particular direction only takes one combat turn (10 seconds). The tricorder operator must first state what type of scan is being made, then attempt a saving roll on his/her Computer Operation skill level. If the roll is made successfully, the gamemaster gives the information revealed by the scan. If not, the readings are fuzzy and the operator may try again.

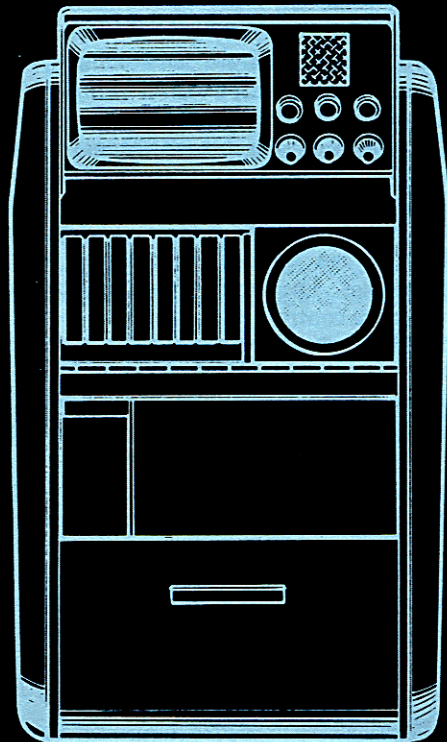



The range and exact performance of the tricorder depends on the type of tricorder and what type of scan is being made. More information is given in the data below on the individual types of tricorder.

Though the tricorder is not extremely delicate, it is possible to render one inoperative with rough treatment. If a character carrying a tricorder falls down, is shot by anything other than a stun weapon, or is attacked physically and knocked to the ground, roll 1D10. On a roll of 1, the tricorder is damaged and becomes inoperative. An inoperative tricorder can be repaired in the field 50% of the time (roll % dice) by a person with the Small Equipment Technology skill (if the person makes the appropriate saving roll, and is carrying basic tools). Otherwise, it must be returned to the ship for repairs. If return to the ship is necessary, there is a 50% chance that the tricorder is so badly damaged that data it was carrying is lost.

**SCIENCES TRICORDER:** Data pickups for the sciences tricorder are located in the flip-open top of the unit, which also houses main controls, data lights, and the video display. The sciences tricorder makes three basic types of scans, with several sensitivity levels available for each.

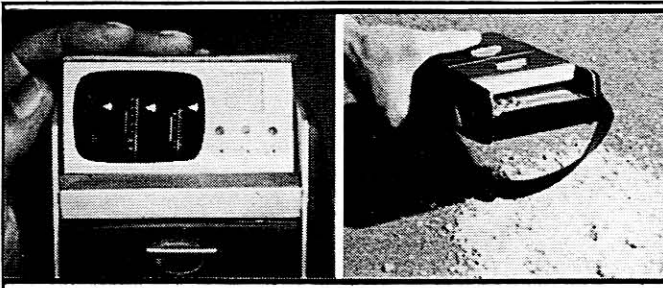

**Energy Sources:** A general scan for energy sources will reveal any major source of power within 1000 meters. If one is found, a second successful scan will pinpoint its general direction. As long as the source continues output, the tricorder will lead the user to the source with no further die rolls necessary. Once within 100 meters, a specialized scan may be made to determine the type of energy being used (atomic power, fusion reactors, electrical generators, stored battery power, etc.). If used adjacent to machinery, an even narrower scan will pinpoint from what source the machinery draws power (power cables, wall socket, internal battery, solar energy, etc.)

**Physical Composition:** A general scan may be made for the nearby presence of concentrations of one particular substance. (The substance must be specified at the time of the scan). If the scan is successful (and if the substance is present in quantity within 1000 meters), the presence and approximate distance of the deposit will be revealed. A second successful scan will reveal the direction. Within 100 meters, an object may be scanned to determine its general composition (that is, the substance it is primarily made of). Once adjacent to an object (within 1½ meters), the complete chemical composition of an object can be scanned. Only known substances will be analyzed in this manner. Unknown substances will be noted as unknowns.

**Life Forms:** The presence of other life forms will be detected by a life forms scan, within a maximum range of 500 meters. A second scan will tell direction and approximate distance. Once within 100 meters, the number of

individual life readings and their general type can be determined. (The tricorder could make out three humanoid forms at this distance, but could not tell if they were Klingons, Romulans, or humans. More precise data requires the use of a medical tricorder.)

**MEDICAL TRICORDER:** The medical tricorder has scanning heads similar to the sciences tricorder and also has a small hand-held sensor attached by a cable that can be used for finer control. The medical tricorder will give more detailed information on chemical composition and life form readings than the sciences tricorder, but it does not possess the sciences tricorder's range or versatility.

**Chemical Composition:** The presence of a substance and its general direction and distance can be determined at 100 meters or less in a similar manner to the sciences tricorder's physical composition scan as detailed above. Within 1½ meters, however, the medical tricorder will determine the chemical composition of a sample, plus give data on that substance's effects on various life forms. For instance, the medical tricorder can scan a plant and determine if it is poisonous, or if it is likely to be nutritious for humans.

**Life Forms:** The life forms scan of the medical tricorder does not have the range of the sciences tricorder, but it gives more detailed information. Within 10 meters it can identify any known life form and give considerable biological data even about an unknown form. If used within 1½ meters, complete medical data (similar to that given by the diagnostic bed) can be ascertained. In addition, the medical tricorder can detect the presence of foreign materials in the bloodstream, determining if a being has been poisoned or drugged.

As usual, other creative uses for the tricorder may be explored by players and gamemasters, bearing in mind that the tricorder is an inherently limited device. Analysis of samples taken aboard ship will give much more accurate and detailed information about most substances than tricorder readings.

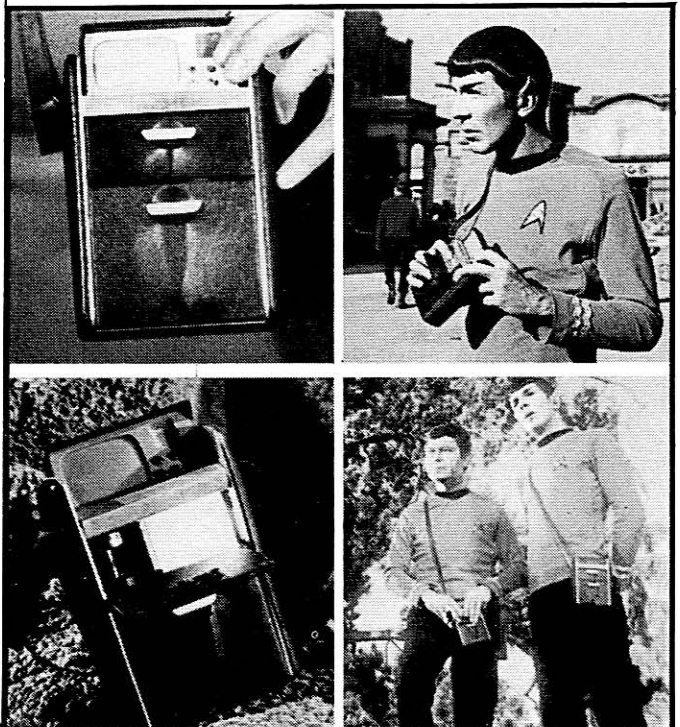

# Weapons

This section will provide detailed information on common hand weapons used by the Federation Star Fleet and by such rival forces as the Klingon Empire, the Romulan Confederation and the Gorn Alliance. The weapons dealt with herein will be sidearms commonly used by landing parties and non-military personnel. Heavy infantry weapons will be dealt with in upcoming supplements, where necessary. This section deals only with descriptions of weapons and how they are used. Range and damage information is included in the combat section of the rules on the weapons chart.

## FEDERATION STAR FLEET

**Phaser 1:** The most common hand weapon issued to Star Fleet personnel. The Phaser I is carried by all personnel on landing party duty, with the possible exception of medical personnel (at the option of the ship's captain and chief medical officer). It is a small palm-sized box with a power grid, setting wheel, charge indicator dial, warning light, and rectangular trigger button.

The Phaser I unit (also called a "hand phaser") is usually worn inconspicuously on the belt under the uniform shirt in back. Phaser I is carried on landing parties when the display of obvious weaponry would be inappropriate, such as when calling on a friendly planet or when on a diplomatic mission. Only security personnel are normally issued phasers on board ship. They carry Phaser I normally and Phaser II during a security alert.

The hand phaser has a variety of settings for different uses, as detailed below:

**STUN:** A non-lethal setting that affects the nervous system of the target, causing unconsciousness.

**HEAVY STUN:** A more potent, but still non-lethal setting for use with larger and/or stronger life-forms.

**HEAT:** This setting excites the molecular motion within an object, causing it to heat up rapidly. The setting can be used as a cutting or welding torch, or to light fires, depending on the beam-spread adjustment of the phaser emitter nozzle.

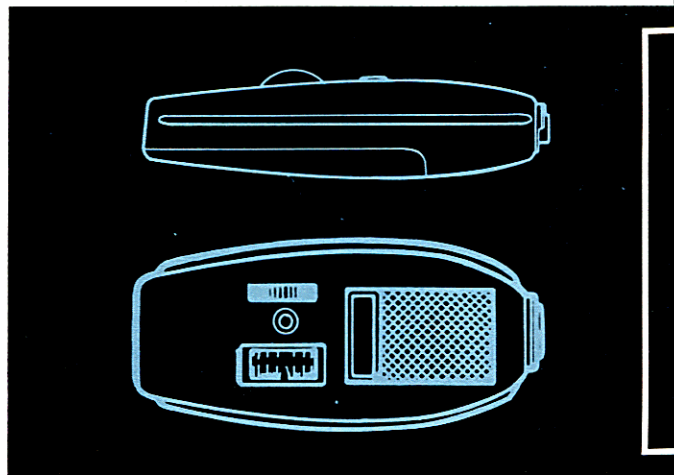

**DISRUPT:** This setting disrupts the nervous system in a lethal fashion. It also disrupts the crystalline structure of solid matter, shattering it.

**DISINTEGRATE:** This setting drains the most power, but is capable of completely breaking down the molecular cohesiveness of a single man-size target, causing it to disintegrate completely.

A phaser can also be set to overload and explode, releasing all stored power in one burst. Once set for overload, a phaser emits a characteristic whining sound, which rises in pitch. Sixty seconds after activation, the phaser will explode.

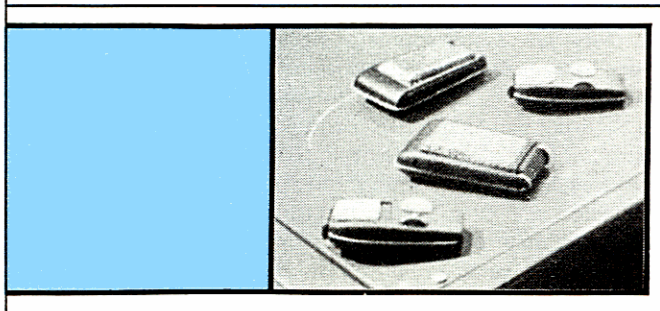

**Phaser II:** Also called a "phaser pistol" this sidearm consists of the Phaser I unit snapped into a pistol-grip mount that provides an extended power pack, finer control, longer range, and more stability than Phaser I alone. The Phaser II is carried by landing parties where hazardous conditions exist, and the open display of firearms does not matter. It is worn in a holster framework at the waist. Phaser II is issued to security personnel aboard ship only during a security alert.

Phaser II also operates at all settings above, with a corresponding increase in range. The overload explosion radius is also increased because of Phaser II's larger power pack.



## KLINGON EMPIRE

**Agonizer:** This hand-held device is applied to the left shoulder just above where the ear is located in humans. It produces pain through direct stimulation of the nervous system and is effective on all vertebrate life. The power can be adjusted from mild discomfort to crippling agony. On high settings, a character must make a successful saving roll against the END attribute to take any action at all, and the saving roll is at a penalty of 50 points! Thus, all but the hardiest individuals are helpless when under the influence of an agonizer.

One of the most insidious features of the Klingon agonizer is that it does not allow the victim to lose consciousness! Consciousness is maintained through direct manipulation of the nervous system, thus making it impossible for the pain to be escaped by passing out.

The agonizer is carried by Klingon officers, and is used for discipline and torture. (See rules on torture in the characters section under special talents). It does not make a good combat weapon since it must be applied to the body in the proper location to work properly. (The left chest position is preferred, but a location near any major nerve center will serve.)

**Sonic Disruptor, hand:** The disruptor sidearm carried by all Klingon officers and many Klingon soldiers works on the principle of cellular disruption through ultra-high frequency sound. The sound is focused into a tight beam resembling microwave radiation. A visible light beam is a parasitic effect of the focused sound/maser.

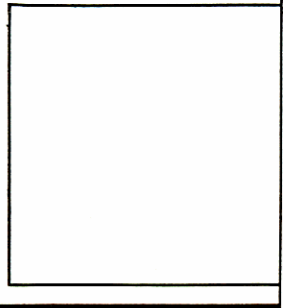
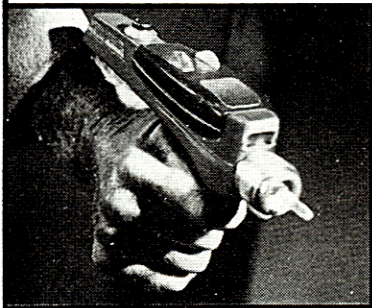
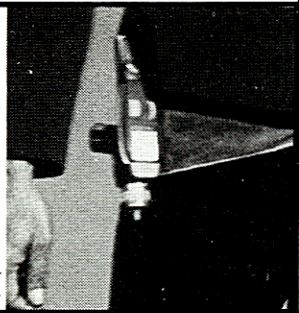
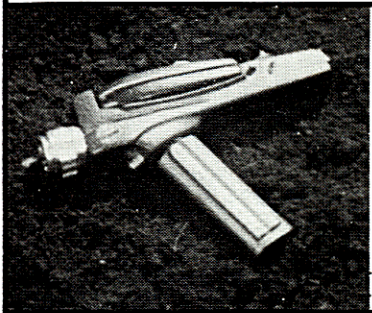
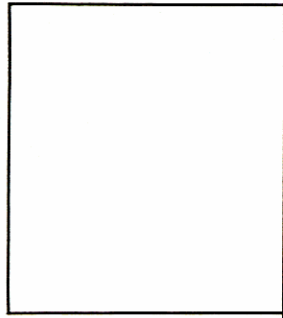
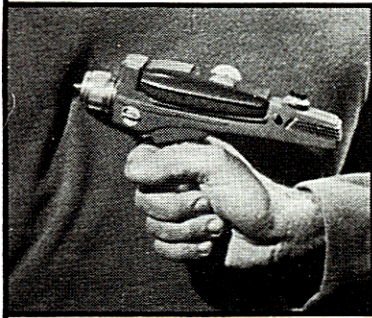
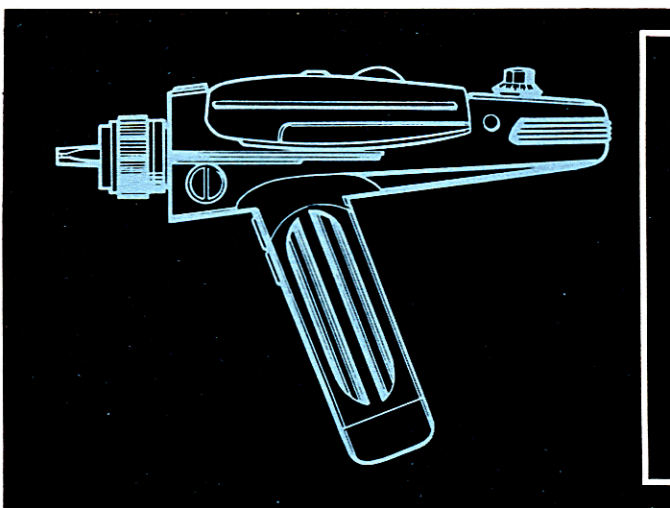

**Phaser Rifle:** The Phaser rifle is used only in combat or emergency situations by security personnel. The rifle consists of a rifle mount with extended powerpack into which the Phaser I/Phaser II combination is fitted. It further increases the range of all the settings listed for Phaser I above, and further extends the overload blast radius.

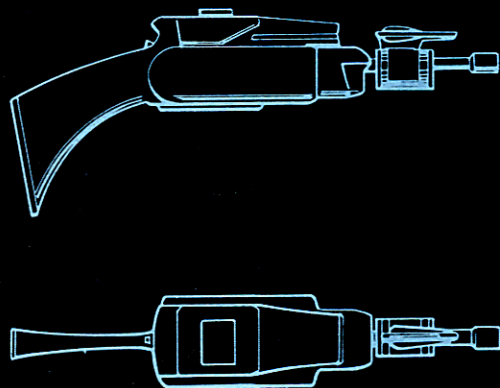

The disruptor affects the delicate nerve cells of a victim first producing pain and crippling. A grazing shot will produce first pain, then numbness of the extremity affected. A solid hit will continue producing damage through actual heating of the tissues. Prolonged fire will produce heating and disruption of any type solid matter.

The sonic disruptor is not effective across a vacuum, but a true microwave version is used as standard main batteries aboard Klingon war vessels. This version is quite effective across a vacuum, as it is not sound-based. More compact versions of the microwave disruptor are rumored, and this version will no doubt eventually replace the current sonic models as sidearms.



Sonic disruptors are a standard trade item with the Klingons (among those few interstellar groups that will trade with them at all!) Thus, they are widely used by other cultures as well. Romulan sidearms are a refinement of the same principle, differing only in appearance from the Klingon models. Klingon-designed disruptors often show up in the hands of smugglers, pirates, and other law breakers around the fringes of the Federation. They are cheaper and easier to build than the more versatile phaser, which accounts for their use by certain criminal elements, such as Orion-based privateers.

**Disruptor rifle:** A heavy-duty version of the disruptor pistol, this weapon is used by Klingon security forces and guards on active duty. It has a longer range than the pistol model, but does no more damage. This weapon is also widely used, in somewhat varying forms, among other cultures that are rivals of the Federation, notably the Romulans.

## ROMULAN CONFEDERATION

Weapons in use by the Romulan Confederation at this time seem to be refinements and copies of Klingon-design sidearms. Some of this can be attributed to the fact that the Klingons and Romulans have recently signed a technology-swapping treaty. Mostly, though, the Romulans

do not believe in redesigning something simply for the sake of being different. The disruptor principle is recognized throughout the known galaxy, and Romulan adoption of it is typical of their efficient thought in martial endeavors. Romulans do not make use of any device similar to the Klingon agonizer. This is also typical of Romulan psychology. The Romulans do not use demeaning methods of disciplining well-trained professionals. Nor do Romulans take prisoners or practice torture in search of information, as they assume that any worthy opponent would find some method of committing suicide before giving up information.

## GORN ALLIANCE

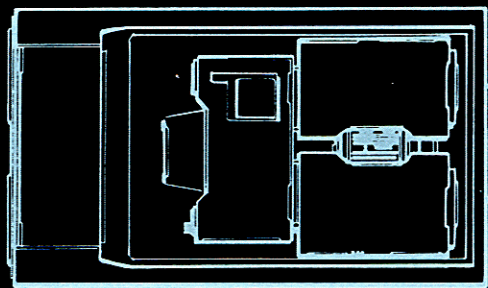
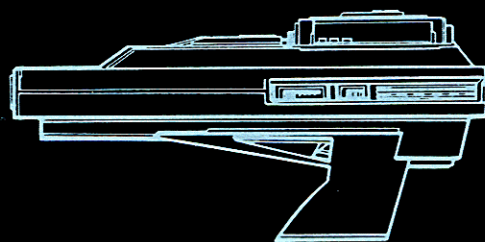

**Gorn Blaster:** As with other elements of Gorn technology, Gorn sidearms are not in the least subtle. The Gorn Blaster is just that. It fires a beam of semi-coherent energy that does damage through burning and cellular destruction.

The beam is not well focused, hence the Gorn Blaster has less range than the Klingon disruptor, though the basic hand disruptor has less raw power. Designed for the oversized Gorn hand, the blaster is clumsy for most other races to use (+10 penalty to the "to hit" roll).

Individual designs vary widely, as many Gorn family/tribal groups have their own weapons manufacturing facilities. All have about the same range and effectiveness, however.

Strangely enough, though larger rifle-type weapons have been observed in use by the Gorn, they do not seem to be much more effective than the sidearms!



# Planetside Adventures

A LANDING PARTY is any group sent out from a starship for exploration, diplomatic negotiations, first contact, or other official purpose. The responsibility for choosing a landing party usually falls to the captain, though he will respect the advice of subordinate officers in their specialized departments. The crewmen assigned to a landing party depends on the size of ship and type of mission. Presented in this section are guidelines for selecting and equipping landing parties from Constitution-class starships such as the U.S.S. Enterprise. These guidelines can be adapted, using imagination and common sense, for use on other vessels.

A basic EXPLORATION TEAM would be sent down to make the first survey of a new planet. This team would consist of at least one sciences specialist each in botany, zoology, and geology, two security specialists, and

A FIRST CONTACT TEAM will be beamed down to an unexplored planet where a sentient civilization is determined to be present. The Prime Directive calls for direct contact to be avoided with civilizations below a technological and intellectual level where they can handle the idea of "men from the stars". In such a case, the team would be disguised as natives, where such disguise is possible, and equipped with universal translators and no weapon larger than Phaser I.

The Prime Directive expressly forbids providing natives with technology beyond what they can develop themselves. This prohibition has only been broken where another starfaring culture has already disrupted the cultural ecology. In such a case, a starship captain has wide discretionary powers to restore a cultural balance if possible. The captain will have to face a tough hearing on

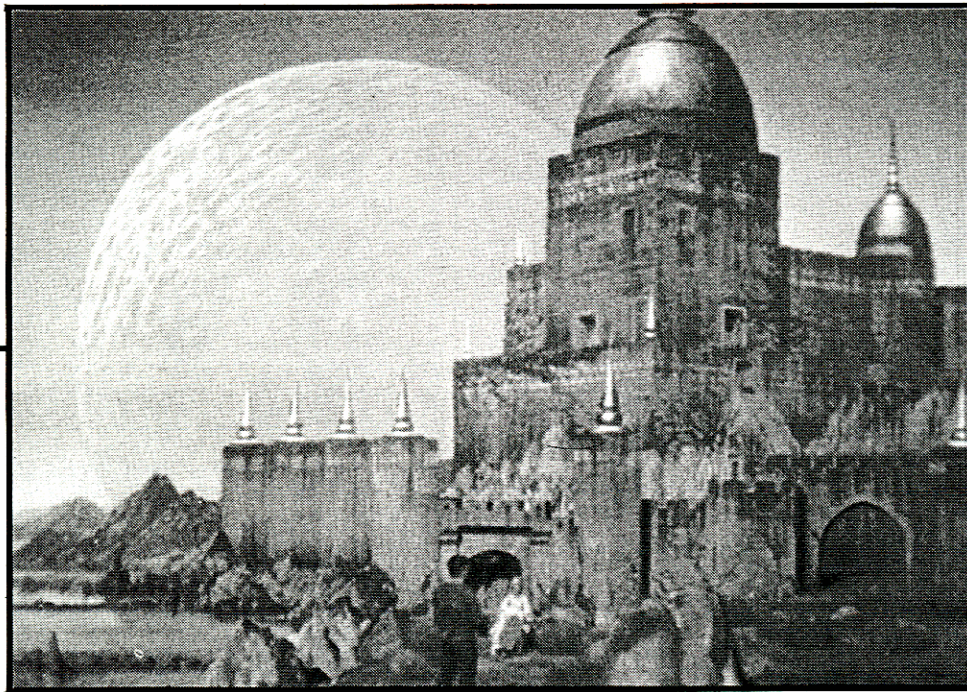

a medical officer. Often, if the survey were important enough or especially tricky, the science officer would fill the position of one of the sciences specialists, and act as team commander. If not, the senior sciences specialist present is in command.

The sciences specialists will be equipped with science tricorders, and the medical officer with a medical tricorder and small medikit. All but the medical officer will carry Phaser I. If the initial sensor scans indicate the presence of larger animals that might be dangerous, the chief of security or the captain may issue the security specialists Phaser II instead.

his actions later and will have to justify them to a Star Fleet Review Board.

A diplomatic contact landing party would be sent down when making first contact with a civilization sufficiently advanced to be approached about the existence of the Federation. Such a party is almost always headed by the ship's ranking officer, the captain. Since star vessels operate so far out, often weeks from a starbase by subspace radio, the captain of a large exploration vessel (like the U.S.S. Enterprise) is empowered to act as a Federation ambassador for purposes of establishing friendly relations with a new culture.



The other members of a diplomatic contact party would be selected based on the situation as observed. Weapons larger than Phaser 1 would be avoided on such a landing party, though 1 to 3 security specialists would be taken along. At least one sciences representative, often the Science Officer, would be assigned to the party as well. Other specialists might include sciences specialists (if the planet in question is important due to some scientific data to be gathered there), a medical officer, or members of the command division (helm or navigation). These last would come along as observers, learning the fine art of diplomacy by assisting the captain. On such a party, science personnel would not usually carry tricorders, nor would medical personnel. A tricorder (probably sciences) would be carried by a yeoman or member of the command division observing, for recording diplomatic negotiations, making supplemental log entries, etc.

Other types of landing parties would be formed by the captain based on the needs of the moment. It would be rare for both Captain and First Officer to leave the ship at the same time, unless the presence of both was absolutely necessary. The Captain would not beam down for a routine survey party, nor would any department head, unless something were unusual or important about the mission. The Gamemaster should encourage the players to be somewhat realistic about landing party composition. Gamemasters should definitely not allow the captain and all bridge personnel to beam down for every landing party, armed to the teeth and ready for anything. If they do this too often, after all, there's always the chance something important could happen on board while everyone was planetside! Keep player-characters involved in the action but every player character doesn't have to beam down for every landing party. Set up game situations cleverly, so everyone has a chance to do something, but not necessarily so everyone has to beam down.

### STRANGE NEW WORLDS

Much of the action and adventure in STAR TREK took place on the Class "M" planet investigated by the U.S.S. Enterprise on its five-year mission. Gamemasters will want to create a steady stream of "strange new worlds" to explore, and the "new life and new civilizations" to populate them.

Of course, there is no substitute for the human imagination. The designers recommend that gamemasters, like the writers who shaped the STAR TREK universe in the first place, create planets, animals and sentient races to suit (and delight) his campaign and the players involved. Space, and its variety, are infinite—**STAR TREK: The Role-Playing Game** should be a celebration of this variety.

But even the most creative gamemaster occasionally needs a push in the right direction and some guidance. Also, players have a tendency to surprise you, going in directions you don't expect and exploring places you don't anticipate! For those times, simple systems are provided to allow gamemasters to quickly generate the important data about class "M" planets, and the alien animals and sentient races that might be found there. Gamemasters can then take this basic data and expand on it to flesh out the campaign.

Only the class "M" planets are covered by this system, since those are the planets the U.S.S. Enterprise and her sister ships were assigned to explore. Class "M" planets are those which are capable of sustaining most Federation species (carbon-based oxygen-breathers) without major life support equipment. Occasionally, ships call at other worlds than Class "M", and some successful colonies have even been established, though they require major life support systems. Such worlds, however, are selected for their strategic location, not their hospitable climate. If a gamemaster needs a methane-atmosphere world or a gas giant for some reason, by all means create one! The planetary generation system, however, is designed for use with class "M" worlds only.

Class "M" covers a lot of ground, however, as it includes Vulcan, Alfa 177 (*The Enemy Within*), the volcanic satellite of planet Cepheus (*The Terratin Incident*), and probably even Rigel XII (*Mudd's Women*). Class "M" planets aren't always all that hospitable.

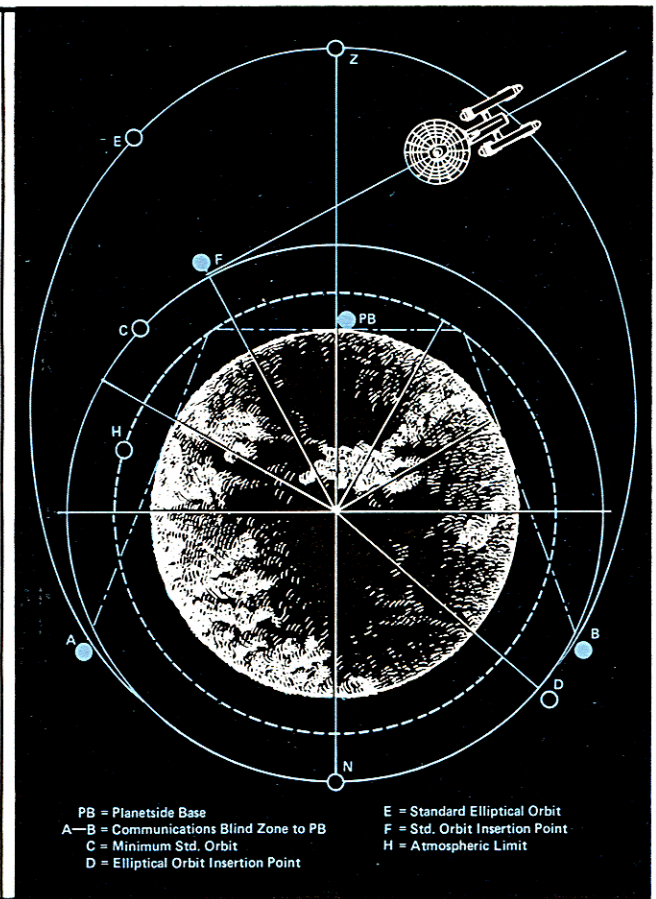

### PLANETARY GENERATION

This system is governed by a set of die rolls, but die rolls should only be used to spark a gamemaster's imagination or give her/him a push in one direction or another. Gamemasters should feel free to pick and choose data for planets if they wish, keeping in mind that the die rolls as presented provide a guideline to the relative chances of each planetary attribute appearing in a given system.



Step 1: Determine the number of class "M" worlds present in a system. (% dice roll)

01-90	1 class "M" world
91-97	2 class "M" worlds
98-00	3 class "M" worlds

Four or more class "M" worlds in one system would be extremely rare, but possible. This option is left to game-master discretion, as the chances of it are too small to appear in a random determination.

Step 2: Determine the number of natural satellites possessed by each class "M" world. (1D10 roll)

1-3	0 satellites
4-6	1 satellite
7-8	2 satellites
9	3 satellites
10	4 satellites

There is a small chance (roll 01 on % dice) that a satellite will itself qualify as class "M". Also, there is a small chance (05 or less on % dice) that a satellite of another, non-class "M" body like a gas giant will be a class "M". If so, generate their data just like separate planets.

Step 3: Determine planetary gravity for each class "M" world. Roll 1D10+5, and divide the resulting number by 10. (Do not round off the resulting number!) This gives a resultant gravity of anywhere from 0.5 G to 1.5 G (1G = Earth gravity). Planets with greater or lesser gravity than this do not qualify as class "M" worlds.

NOTE: Since planetary size is not often a factor in play, no separate generation system for size is provided. Should you need an approximation of planetary diameter, assume a planetary density similar to Earth's. Then you can multiply Earth's planetary size data, given below, by the gravity factor you have just rolled to get the size of your new class "M" world.

#### EARTH PLANETARY SIZE

Diameter: approx. 13,000 km (8,000 miles)
Equatorial circumference: approx. 40,000 km (25,000 miles)
Surface area: approx. 510,075,000 sq. km (196,940,000 sq. miles)

Step 4: Determine planetary rotation time in hours. Roll 2D10+14, generating a number of hours between 16 and 35 as the approximate length of one local "Day". (Actually, only about 1/2 of that number will be daylight.) The length of the local day can be important in some planetary scenarios.

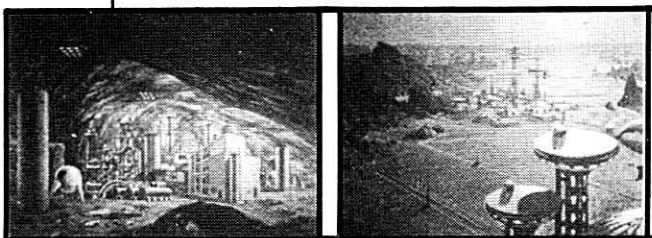

Step 5: Determine the atmospheric density of the planet. (1D10 roll)

1-2	Thin atmosphere
3-8	Normal atmosphere
9-10	Thick atmosphere

Note that both thin and thick atmospheres are breathable, but may cause fatigue over longer periods of time. If no special measures are taken (Tri-Ox injections for thin atmospheres, breathing masks for thick atmospheres), all fatigue rolls are at a +20 to the roll, with a save attempt necessary every two hours at least. Vulcans and Tellarites used to thin atmospheres and require no extra or modified saving throws for thin or normal atmospheres.

Step 6: Determine the amount of surface land (as opposed to water). Roll % dice. A result of 01 means there is 1% land surface, probably in the form of small islands. A result of 00 means 100% land, probably a desert planet with almost no free-standing water.

Step 7: Determine the planet's general climate. (% dice roll)

01-15	desert
16-35	tropical
36-60	temperate-warm
61-85	temperate-cool
86-00	arctic

The climate generated above is only a general description. An arctic planet will have temperate-cool zones, and a tropical planet may have temperate-warm areas. Earth would fall in the temperate-cool range, even though it evidences all the classes on the table! Also note that the gamemaster should not be bound hard-and-fast to the die rolls in this section. Random rolls here must be tempered with common sense. For example, a planet with less than 5% land area would be unlikely to qualify as a "desert" planet. The gamemaster is strongly urged to use these tables only as a guideline, to indicate a general direction. Feel free to substitute your own ideas for die rolls at any time!

Step 8: Determine the mineral content of the planet. This can be left out if the gamemaster does not need such information, but you never know what players will think about!

To eliminate the trouble of mapping each individual vein of ore (!), a simple system of determining the percentage chance of finding a certain mineral in a given area is provided. Mineral content is divided into five categories: normal metals (iron, copper aluminum, etc.), special metals (pergium, topalin, ryetalyn and other STAR TREK inventions), radioactives (uranium, plutonium, etc.), gem stones (diamonds, rubies, flame gems, etc.), and industrial crystals (dilithium, special silicates, etc.)

For each category (or each mineral, if the gamemaster needs such detail) roll % dice. This is the likelihood of finding a particular mineral in any given area. (The gamemaster may wish to grant plus or minus modifiers for certain areas. For instance, there may be more chance of finding titanium ore in a certain mountain range than elsewhere.) This general percentage can be determined by a ship's sensor scan from orbit, such a survey taking about 5

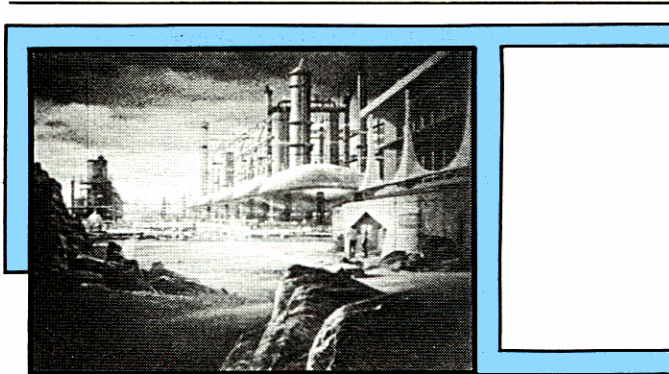

hours (times the planetary gravity factor, which modifies the roll to account for small or large planetary surface area; round off the result to the nearest hour).

Once the general percentage chance is determined, a landing party (which must contain at least one person with geology skill above 20 and a sciences tricorder) may beam down to make a close scan. The gamemaster then secretly rolls % dice to determine if this specific area has the mineral desired. If the % dice roll is equal to or less than the base chance for that mineral on that world, the deposit is present. The results of this roll are not communicated to the players!

It will take 10 hours for a landing party to check a square kilometer area for a mineral deposit. More than one party can be used, proportionally reducing the time. (Two parties can do it in 5 hours, three in 3 1/3 hours and so forth). Each party must have at least one geologist (skill level 20 or better) with a sciences tricorder. Also, the parties must separate (which means the other groups will likely be too far away to help if there is trouble).

At the end of the scan in an area, each landing party makes a saving throw on the geologist's Geology skill score. (Use the highest score if more than one geologist is in the party.) If the roll is successful, the deposit is found. How accessible the material will be is up to the gamemaster. If the search is negative, a second try may be made in the same area (taking as long as the first), with a modifier to the roll of +10. (The second try is always less likely to find anything.) This modifier is cumulative, adding over and over for each subsequent try. The group may also beam up and beam back down in a different area, starting from scratch. Doing this loses the party an hour while they pack up, beam up, and select a new site to beam down.

### PLANETARY GENERATION EXAMPLE

As an example of the operation of the planetary generation system, we will create the planet Spartal IV, just detected by the U.S.S. Potemkin. Rolling % dice for step 1, we get a 55, showing that Spartal IV is the only class "M" world in the system. A roll of 4 in step 2 tells us that Spartal IV has only one natural satellite (and a percentile roll of 74 means it is uninhabitable; not class "M").

The roll in step 3 for Spartal IV's gravity is 7.  $7 + 5$  divided by 10 yields a gravity of 1.2 G. (This translates out to an approximate size of 15,600 km in diameter.) Planetary rotation period (step 4) is 2D10 (result 12) plus 14, for a total of 26 hours. A roll of 10 in step 5 gives the planet a thick atmosphere.

A % dice roll of 56 indicates a percentage of land area (step 6). We roll % dice again in step 7 (result 42) to find that Spartal IV has a temperate, cool climate.

Finally, once standard orbit is achieved and sensor scans are taken, the mineral content must be determined (step 8). Our five basic area rolls yield the following results:

Normal metals	57
Special minerals	03
Radioactives	82
Gem stones	86
Industrial crystals	45

Our general information on Spartal IV is now complete. Other details (plant cover, volcanic activity, trace elements in atmosphere, etc.) are left to the gamemaster to decide.

### PLANETARY SURVEY SUMMARY – Spartal IV

Single class "M" planet in Spartal system

NUMBER OF SATELLITES: 1

PLANETARY ROTATION: 26 hours

GRAVITY: 1.2 G                      % LAND: 56%

ATMOSPHERE: THICK              CLIMATE: temperate-cool

MINERAL CONTENT: normal metals: 57%; special minerals: 3%; radioactive: 86%; gem stones: 86%; industrial crystals: 45%

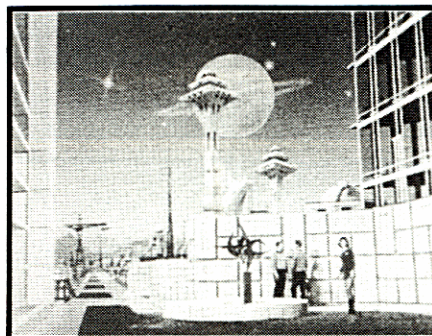
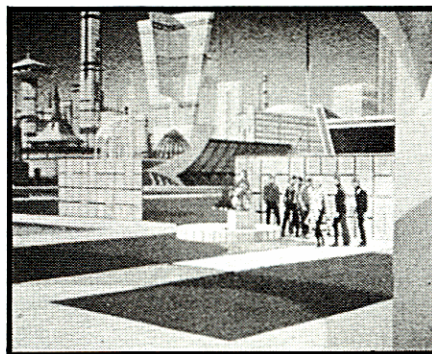



# New Life and New Civilizations

Once the physical parameters of a planet are determined, the gamemaster may determine what type of life exists. Class "M" planets are all capable of supporting life, and the poorest of class "M" worlds will bear at least microorganisms.

Again, gamemasters are encouraged to come up with imaginative, sensible and playable animals and sentient life forms on their own. The following creation system, however, will help a gamemaster decide what the highest form of life on a new planet is like, and if it is intelligent enough to qualify as a "being" and not an animal. (The quality of being above the level of "animal" intellectually is called "sentience", and such a race is called "sentient".)

Roll % dice against the LIFE FORMS TABLE below. The result will show the most highly developed, or dominant, life-form present. In addition, representatives of all groups below the dominant group will probably be in evidence on that planet. Thus, if the dominant form on a planet is an amphibian-like creature, there will likely also be animals in the classifications of fish, insects and mollusks, and plants and microorganisms. There will not likely be reptiles, birds, or mammals native to that world.

Note that the chart is heavily biased toward mammals. This is done to reflect the vast majority of known species in the STAR TREK universe. Most dominant species on worlds visited by the U.S.S. Enterprise were mammalian. Gamemasters should feel free to change this if they so desire.

LIFE FORMS TABLE (roll % dice)

01-03	Microorganisms	0% sentient
04-07	Plants	1% sentient
08-14	Insects/Mollusks	3% sentient
15-20	Fish	5% sentient
21-30	Amphibians	7% sentient
31-40	Reptiles	7% sentient
41-50	Avians (birds)	7% sentient
51-95	Mammals	10% sentient
96-00	<i>Special</i>	90% sentient



The *special* category can include life forms made of pure energy, with gaseous forms, crystalline creatures, or anything else the gamemaster comes up with. Also, with a special form dominant, there may or may not be any lower forms present (gamemaster's option). The percentage sentient indicates the number (or lower) that must be rolled on % dice for the dominant form on the planet to be an intelligent race.

If the sentience roll indicates that the dominant species is an intelligent race, use the rules for technological index and sociopolitical index to give you some direction for describing the type of civilization.

To develop the exact physical attributes of the race (STR, DEX and END levels) and other data (physical size, eating habits), the gamemaster may create these details whole cloth, or use the animal creation system tables presented in the next section. If using the tables, one is advised to keep most sentient races in size categories "small", "medium", or "large". It is advised that you simply choose a size and a set of eating habits (carnivore, herbivore or omnivore) that suit you and work from there. You already know the basic form from the roll for the dominant life form, of course. Again, feel free to ignore die rolls and structure your new race as you desire.

## INT, LUC & PSI FOR NEW ALIEN RACES

These traits should probably center around a % die roll, just as humans and other known sentient races do in STAR TREK: The Role-Playing Game. Die modifiers similar to those used for the known player and non-player races should be developed for each new race as well. Gamemasters are left to their own discretion here, but care should be taken to maintain game balance. Gamemasters should be extremely reluctant to create a race that is luckier than humans, or more psionically gifted than Vulcans, without handicapping them in some compensating way.

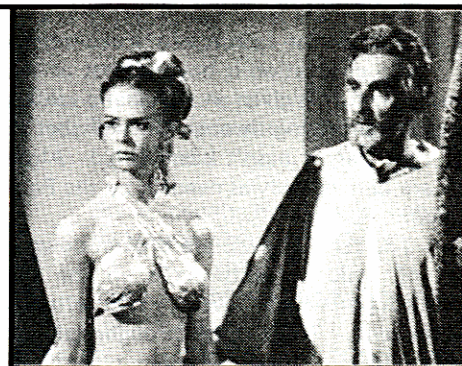

## STR, DEX & END FOR NEW ALIEN RACES

When generating these values from the animal creation tables in the next section, a single numerical value is found. This would represent a healthy individual of the race. For the sake of play balance, individual members of the race should not vary by more than 25 points to either side of the number generated by the animal creation system.

To roll this randomly, roll 1D10 first. On a roll of 1-5, your character will have a lower than average attribute score in that attribute. On a roll of 6-10, the character will be higher than normal in that attribute. Then roll 1D10 (if the average score is less than 50) or % dice and divide by 2 (if the average score is 50 or more). Add the number thus generated to the average score (if higher than normal) or subtract it (if lower than normal) to give the attribute score for the individual.

If a race is going to be important to a campaign, a more elaborate system of attribute score generation should be developed by the gamemaster.

## TECHNOLOGICAL AND SOCIOPOLITICAL INDEX

When an intelligent race of beings is encountered, a set of numbers (or letters) can be generated to describe the basic technological achievement level of their civilization in various areas. Similarly, an alphanumeric value can be stated to give a very general idea of the sociological/ political/economic structure of the society.

A series of six numbers or letters is used to represent the technological index of a civilization. The numbers cover a range from zero to nine, with nine arbitrarily representing the level of development of the Federation world ranking highest in that area at the time of the adoption of the system. In practical terms, all of the statistics are based on the development of the Federation world ranking highest in the area at the time of the adoption of the system. In practical terms, all of the statistics are based on the development of human civilization in STAR TREK's time except the indexes for Social Sciences and Psionics, which are based on Vulcan's development level. (This parallels the attribute system, which is arbitrarily centered around humanity, except for the PSI attribute.)

A civilization ranking zero has attained no noticeable accomplishment in theory or practice of the area of knowledge in question. One ranking at 9 is as accomplished as any in the Federation. Levels between are proportionally set. (Examples for each area of knowledge are given later.)

If a civilization is beyond that of the Federation in some respect, it is given an alphabetic value, beginning with "A" and continuing through the alphabet to "Z" if necessary. (So far, it hasn't been . . .) Alphabetic designations are defined only as needed, by the Federation Science Council.

The various levels are broken down by the development of major breakthroughs in the specialty area — breakthroughs which have a major effect on a culture's development. These breakthroughs take place on no set time schedule. Thus, where a planet's culture may be

highly advanced in life sciences, they may still know very little about physics or engineering.

The Psionics index is a fairly recent addition to the classification system, based upon the relatively recent discovery of a number of highly developed psionic species. The Psionics index is the only one where planets have been discovered that go far into the highly advanced alphabetic ranges. Examples of such cultures are the Organians (tentatively designated with a Psionic index of F) and the Metrons (tentatively designated with a Psionic index of D).

The indexes are stated in planetary/cultural designation as a six-place series of numbers and letters, in the following order: Engineering, Physics, Chemistry, Life Sciences, Social Sciences, Psionics. Thus, Earth's designation in STAR TREK's time is 999964 and Vulcan's is 789999. Earth is on the verge of gaining a rating of "A" in life sciences, due to widespread experimentation in large-scale organ regeneration. A major breakthrough would make them the most advanced Federation member planet in this regard. Vulcan, on the other hand, is on the verge of gaining an "A" rating in Social Sciences, due to studies in interspecies social dynamics.

The divisions in Technological Index for each classification, along with some representative accomplishments at each level, are shown in the TECHNOLOGICAL INDEXING CHART.

The Federation also uses a single digit SOCIOPOLITICAL INDEX to try and classify the social and cooperative development of a culture. Rather than indicating a specific form of government, the Sociopolitical Index denotes a culture's basic cultural orientation toward cooperation between individuals that shapes its specific government forms.

The scale, which runs from zero (0) to nine (9), is more circular than linear, with no one division of the index considered inherently "superior". Federation member cultures and associated cultures display a wide variety of index ratings, from anarchy to monarchy to unity and back again. The designation "tribal", held by some early sociologists to be inferior, has been proved on many planets to be a viable and very stable approach to cooperative effort. Modern Federation sociologists point to Earth's own Amerind cultures as being an excellent example of a very healthy form of advanced tribal structure. Vulcan also possessed an early tribal structure of great stability.

The divisions of the Sociopolitical Index are as follows:

0) ANARCHY — Lack of any form of enforced cooperation between individuals. This can be a very primitive development (those cultures which have not learned to cooperate). It can also be a very advanced development (in societies which have developed beyond the need to enforce cooperation). Thus, this classification both begins and ends the chart, forming a circular bond. This is not to say that cultures need necessarily move along the chart directionally — many do seem to develop in this manner, but a number of others have not.

1) PRE-TRIBAL — This level includes cooperation only by very small family groups or on a sporadic basis, such as temporary hunting alliances.



TECHNOLOGY LEVEL			
	ENGINEERING	PHYSICS	CHEMISTRY
0	NO ACCOMPLISHMENT		
1	Rudimentary toolmaking: shelter building	Control of fire	Knowledge of basic states of matter (solids, liquids, gases)
2	Basic metallurgy: pulleys and complex levers	Complex optics	"Kitchen" chemistry and first understanding of substances
3	Basic mechanics: steam power	Basic laws of motion (Newtonian)	Classification of basic minerals
4	Reciprocating engines and other complexly-powered mechanics	Basic electricity	Discovery of major chemical elements
5	Large-scale construction of tailored environments (heating/air conditioning and reshaping terrain . . .)	Radio communication: x-ray theory	Atomic structure theory
6	Transistors and basic computer science	Atomic fission: microwave theory	Organic chemistry
7	Silicon microchips and advanced computer circuitry	Controlled fusion: laser technology	Transuranic chemistry
8	Micromolecular circuitry	Gravity control: subspace radio	Advanced catalyst chemistry
9	Atomic-level circuitry: widespread commercial use of anti-gravity	Warp drive: transporters; phaser/disruptor technology	Limited transmutation of elements
	LIFE SCIENCES	SOCIAL SCIENCES	PSIONICS
0	NO ACCOMPLISHMENT		
1	Basic herbal medicine: cultivation of plants	Recognition of formal leadership	Psi activity almost unknown
2	Knowledge of basic anatomy: basic animal husbandry	Development of religion: specialization of profession	Psi activity rare but known in individuals
3	Detailed anatomy: blood typing	Development of social classes: symbolic economics	Psi activity well documented in individuals, but not understood
4	Basic mendelian genetics: microbiology	Basic socioeconomic theory	Psi activity widely recognized, but laws and practices unknown
5	Bacteriology and immunology	Basic psychology principles and theories	Basic theory of telepathic/psionic mechanics
6	Basic DNA and gene structure research	Psychoanalysis, behavior shaping and psychodynamics	Psionic resources conserved and cultivated
7	Gene surgery and advanced bionics: organ transplants	Large-scale social planning	Some talents measurable and detectable in many individuals
8	Portable medical scanners: "tailored" species	Elimination of ethnocentrism	Existence of telepathic sensitivity in most individuals
9	Protoplaser surgery: major nerve regeneration	Xenopsychology	Limited telepathy and empathy in widespread use

## RANDOM GENERATION

2) **EARLY TRIBAL** — This designation is at the level of permanent hunting or mutual protection groups beyond the members of a family. Strong individual leaderships, rituals and customs are not present to any significant degree.

3) **ADVANCED TRIBAL** — These groups are more stable, maintaining a strong cultural identity, tribal customs, strong leadership, and identifiable legends, traditions and history.

4) **FEUDAL** — At this level, the society has progressed beyond tribal living in a single area. Civilization and its control is more spread out. A interdependence of duty and obligation develops between leaders and followers. Choosing leaders becomes more ritualistic and less immediately practical.

5) **MONARCHY** — These cultures have developed extremely strong leader/follower divisions, with selection of leaders almost exclusively ritualistic. Power is exercised by a few over the many, with fewer obligations on the part of the leadership.

6) **CONTROLLED MONARCHY** — Strong leadership of a ritualized nature is combined with a set of checks and balances to insure the well-being and cooperation of the populace.

7) **REPRESENTATIVE STRUCTURE** — Leadership choice is by representatives selected from among smaller interest groups — regional or professional — with strong checks and balances.

8) **PARTICIPATORY STRUCTURE** — Individuals participate directly in major decision-making. Most of these cultures are either composed of a smaller number of individuals, or occur in technologically advanced societies.

9) **UNITY** — Societies where there is no need for individual difference of opinion, such as highly telepathic groups, hive cultures, or colony organisms.

The chart then returns to zero (0) and anarchy again.

When listed along with the Technological Index, the Sociopolitical Index precedes it, with the two separated by a hyphen. Thus, Earth (which rates a Sociopolitical Index of 7 in STAR TREK's time and our own) has a combined rating of 7-999964. Vulcan rates as an 8 on the Sociopolitical Index, but just barely. Earth is also nearing the point where its rating will increase to 8.



Ideally, it is suggested that a gamemaster use these indexes as a guideline, creating his cultures to suit his campaign needs. No system of random generation is even a fraction as good as the intelligent use of the human imagination. Nevertheless, if you wish to generate the indexes randomly, use the following procedure.

First of all, no interstellar-capable race can be generated randomly! The designers of this game strongly feel that the addition of another space-travelling race to the STAR TREK universe should be carefully considered by a gamemaster in the light of his campaign and the wishes of the players. Such a step should never be reduced to a series of die rolls. Thus, generate the Technological Index in physics first by rolling 1D10 twice. Take the lowest roll and subtract 1. This gives the physics index from 0 to 9.

Next, generate the engineering index with a roll of 1D10 twice. Take the lower result as a base number, as before. The physics index will affect this result as follows:

Physics index	Engineering index
0 or 1:	-2
2 or 3:	-1
4 or 5:	+0
6 or 7:	+1
8 or 9:	+2
A or greater:	+3

Thus, you can see that with good rolls a civilization can get quite advanced in engineering. The classifications above 8 in the chart or for those times when a gamemaster has already decided a culture will be at an interstellar travel level, and needs to generate other indexes.

Generate the Chemistry index in the same way, with the bonuses or penalties this time set by the Engineering level. Life sciences is also generated in this manner, influenced by Chemistry. The Social Sciences index is generated similarly, influenced by Life Sciences.

Psionics must be developed differently. Roll 1D10 five times and take the lowest roll for the Psionic Index, with appropriate bonuses or penalties based on the Life Sciences level. Any culture possessing a Psionics level of 7 or more will generate the PSI attribute with a basic % dice roll in individuals. This makes it very rare to find a highly developed psionic race, as it should be.

Gamemasters should not be bound by this dice rolling procedure! Use your imagination and throw out any results that make no sense given the physical type of the beings in question or the type of campaign situation you desire. Gamemasters should be reluctant to introduce many races that exceed the Federation in capability and extremely reluctant to introduce a race that exceeds the Federation's technology level in more than one area. Design your cultures with an eye toward play balance.



## ANIMAL CREATION

Animals in **STAR TREK: The Role-Playing Game** use only three of the 7 attributes: STR, END and DEX. Animals have no CHA, LUC or PSI scores under normal circumstances. (It is possible for some individual species to have a PSI score in very special cases. An individual animal—a pet, perhaps, might even be said to have a CHA score, if it is intelligent enough to be persuasive in some manner.) Animals also do not have a standard INT score. Only sentient beings have true intellect. Instead, animals are given a mentation rating (MNT) from 1 to 5, with 1 being the lowest, as follows:

MNT	CLASS	EXAMPLES
1	reactant	plants, sponges, oysters
2	low	insects
3	moderate	cow, bear
4	high	dog, cat
5	very high	chimpanzee, porpoise

(Designer's note: It is likely that the porpoise qualifies as sentient under our operational definition. But until the truth is settled one way or the other, we'll stick with "very high". We have no evidence of any cetacean delegates to the Federation council.)

Action points for an animal are figured according to MNT class. If using these tables for a sentient race, set AP just as for humans—by dividing DEX by 10 (round down) and adding a certain number of additional points. (Humans and other races we have met so far add 4 points). Adds to AP for animals and sentient races are determined by AP modifiers noted in the tables.

To generate an alien animal, simply follow the tables listed in this section. Note that this system does not use a "one from column A, one from column B" arrangement. The tables will allow you to develop a basic idea of what the creature is like and its physical attributes. The rest is up to the gamemaster to decide as he fleshes out the details.

The die rolls for animal type (eating habits), animal form, and size of creature are meant as guidelines. Feel free to pick and choose instead of rolling dice, if you have something specific in mind!

Decide on the basic type, form and size by rolling on (or choosing from) the type, form and size tables shown here.

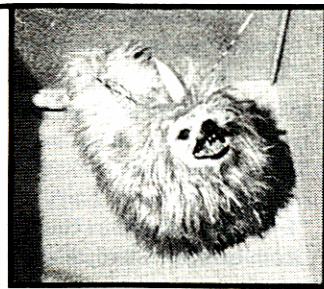

## ANIMAL TYPE (EATING HABITS)

ROLL 1D10	TYPE	BASIC DEX	MNT MOD.	AP MOD.	DAMAGE BONUS
1-4	Carnivore	%D/2+40	+1	-1	1D10 -4
5-8	Herbivore	%D/2+20	-1	+2	1D10 -6
9-10	Omnivore	%D/2+30	+2	+0	1D10 -5

BASIC DEX refers to the basic DEX of the animal, which will be modified by the results on the form and size tables. Note that the roll is on % dice, with the roll divided by 2 and added to a fixed number for the final result. MNT MOD is the amount to be added or subtracted from the MNT CLASS die roll on the MNT CLASS table. The AP MOD is the number to add to or subtract from the final AP determination, to be done later. DAMAGE BONUS is the amount of damage the creature does in addition to damage as figured by STR. (See the STR table under the COMBAT section of the rules.) The reason for the damage bonus is up to the gamemaster. It could represent fangs and claws, acid, other special attack forms, or just sheer bulk and fighting ability. If a DAMAGE BONUS determination ends up with a number less than zero, treat it as zero.

## ANIMAL FORM

ROLL % DICE	FORM	STR MOD	END MOD	DEX MOD	ARMOR MOD
01-05	Amorphous	x.5	x 1	x .5	-8
06-20	Insect/Mollusk	x .5	x .8	x 1.2	-4
21-35	Fish	x.8	x 1.5	x 1	-6
36-50	Amphibian	x 1	x 1	x 1.2	-4
51-65	Reptile	x 1	x 1.5	x 1.2	-3
66-75	Avian (bird)	x .6	x .8	x 1.5	-6
76-95	Mammal	x 1	x 1	x 1	-4
96-00	SPECIAL	?	?	?	?

The STR, END, and DEX modifiers are all multipliers to be applied to the BASIC STR and END rolled on the size table and the BASIC DEX rolled on the type table. ARMOR MOD is one of two modifiers to the armor factor generated later.

## ANIMAL SIZE

ROLL 2D10	SIZE (example)	BASIC STR	BASIC END	DEX MOD	ARMOR MOD
2-3	Tiny (mouse)	1D10	1D10	x 2	-4
4-6	Very small (housecat)	2D10+5	2D10+5	x 1.6	-3
7-9	Small (dog)	3D10+10	3D10+30	x 1	-1
10-12	Medium (lion)	3D10+30	3D10+30	x 1	-1
13-15	Large (horse)	3D10+60	3D10+60	x 1	+0
16-18	Very large (elephant)	3D10+90	3D10+90	x .7	+1
19-20	Huge (brontosaurus)	%D+100	%D+100	x .4	+2



BASIC STR and END set the basic STR and END, and are modified by the results in the form table. The DEX MOD is a multiplier applied to the BASIC DEX generated on the type table and modified by the form table. Likewise, the ARMOR MOD, which adds or subtracts from the armor factor generated later.

Next, the MNT CLASS must be determined. (If you are determining the INT of a sentient race instead of an animal's MNT, skip this step.) Roll 1D10, apply the modifier from the animal type table, and look on the MNT class table below:

MNT CLASS (roll 1D10)	
1 or less	Reactant (class 1)
2-3	Low (class 2)
4-6	Moderate (class 3)
7-9	High (class 4)
10 or more	Very high (class 5)

To generate the ACTION POINTS available to an animal, take the creature's DEX score and divide by 10. Then, roll 1D10, divide by 2, and add or subtract the AP MOD from the animal type table. Add or subtract the resulting number to the AP you just derived by dividing DEX by 10. This gives the final AP for the creature.

An animal (or sentient race) may have natural armor such as thick fur, tough hide, or scales. (The exact type is up to the gamemaster). To determine if any armor (and how much) is present, roll 1D10 and add or subtract the modifiers from the animal form and animal size tables.



#### EXAMPLE OF ANIMAL CREATION

Rolling 1D10 on the ANIMAL TYPE table, we get a 4, so our animal is a carnivore. We then roll % dice for a 79 on the ANIMAL FORM table, so our carnivore is a mammal. A 2D10 roll on the ANIMAL SIZE table results in a 14, so our animal is large (about the size of a horse).

Basic STR and END is determined from the ANIMAL SIZE table. In this case, we roll 3D10+60 for each. For STR, we roll 15 (+60=75). The STR modifier on the ANIMAL FORM table is x 1, so the final STR of our animal is 75. The END basic roll is 22 (+60=82). Again, the ANIMAL FORM table shows a x 1 modifier, so 82 is our final END score.

The basic DEX roll comes from the ANIMAL TYPE table, and calls for us to roll % dice (for a result of 48), divide by 2 (for 24), and add 40 (bringing the basic score to 64). Next we apply the DEX modifier from the Animal Form table (x 1.5, for a result of 96), then the DEX MOD from the ANIMAL SIZE table (x 1) leaving us with a final DEX score of 96.

To find the MNT CLASS, we roll 1D10 (result 9) and add the MNT MOD from the ANIMAL TYPE table (+1) for a result of 10. Comparing this to the MNT CLASS table, we get a MNT CLASS for this animal of "Very high (class 5)".

Action points (AP) for the animal are found next. Roll 1D10 (result 10), divide by 2 (result 5) and apply the AP MOD from the ANIMAL TYPE table (-1) for a result of 4. Add 1/10 the animal's final DEX attribute score (rounded down), which is 9. This gives the animal 13 AP.

Armor factor is next. Roll 1D10 (result 3) and apply the modifiers to armor from the ANIMAL FORM table (-4) and the ANIMAL SIZE table (+0). The result is -1. Since we cannot have a minus armor factor, the creature simply has no natural armor.

Finally, roll the DAMAGE BONUS from the ANIMAL TYPE table (1D10-4, with a roll of 9 resulting in a score of 5). Add this to the damage done by STR as noted in the combat section (in this case 1D10+3) for a combat damage of 1D10+8.

In summary, we have created a large mammalian carnivore, with a STR of 75, an END of 82, and a DEX of 96. Thus it is strong, agile, and hardy. It's a very intelligent animal, too (MNT CLASS 5; very high) and pretty fast-moving (AP total 13 per turn). It has no natural armor, but it does 1D10+8 in combat.

Now we can flesh out the description a bit. Obviously, we are dealing with a very dangerous animal here; both strong and fast. Our visualization is of an upright biped on the edge of sapience. It is about 8 feet tall, well muscled but sleek and fairly fleet of foot with golden brown fur. It resembles the Earth legends of Bigfoot or the Abominable Snowman, but is much more slim and agile—a natural climber, perhaps. We will give it a natural habitat in mountainous terrain. It scrambles up and down sheer cliffsides deftly, attacking any and all prey it can find. The animal in question is highly territorial and mates for life, forming no group larger than it's own family. The young are run out by the jealous parents as soon as they can fend for themselves. These things have a nasty temper!

Given another million years or so, these things might develop enough intelligence to be called truly sentient. For now, they are merely dangerous, violent beasts. Their native planet was first discovered by an Andorian military survey party, and the discoverers named "F'lanari", which in the Andorian language means "golden death-bringers" and refers to an old Andorian legend about berserk warriors made of gold created by a mad magician.



## ANIMAL LISTS

As illustrations of how animals can be created for use in your own campaigns, if you so desire, the following list of statistics for Earth and alien animals is provided. The alien animals list is followed by more detailed descriptions of some of STAR TREK's more colorful creatures.

### EARTH ANIMALS

ANIMAL	STR	DEX	END	MNT			ARMOR
				CLASS	AP	DMG	
Bear	80	45	65	4	9	2D10+4	2
Chimpanzee	50	65	60	5	9	1D10	0
Cow	80	55	75	3	11	2D10	0
Dog (small)	25	60	25	4	10	1+10	0
Crocodile	60	50	50	3	9	1D10+6	3
Dolphin	50	50	50	5	13	1D10	0
Elephant	105	40	100	3	8	2D10+6	6
Gorilla	85	55	70	5	8	2D10	2
Horse	85	75	85	4	15	2D10	0
Housecat	15	75	15	4	10	1D10	0
Lion	60	75	65	4	13	1D10+6	1
Rat	5	55	10	3	7	1D10-3	0
Snake (boa)	45	55	40	3	7	1D10	0
Snake (rattler)	30	65	30	3	8	1 pt. no.	0
Wolf	45	55	30	4	10	1D10+2	1

### ALIEN ANIMALS

ANIMAL	STR	DEX	END	MNT	AP	DMG	ARMOR
Cappellan power-cat	50	55	50	3	8	4D10+10 (shock)	3
Glommer	10	20	10	1	3	—	1
Horta	100	50	100	*	8	ACID	10
Le-matya	85	70	85	4	11	2D10+4	No. 3
Mugato	80	60	80	4	10	2D10+3	No. 1
Sehlat	95	65	95	5	11	2D10+5	6
Tribble	5	5	5	1	6	—	0

\* = damage from poisons in addition to stated damage

\* = damage being (not rated with animal MNT CLASS)

### GLOSSARY OF ALIEN CREATURES

**CAPELLAN POWER-CAT:** A large furry bobcat (about the size of an Earth brown bear) with gold eyes, reddish fur, brown spines along its back, and a small tail. The power-cat can generate an electric charge of 2000 volts (doing 4D10+10 damage if it touches you) when angry. It is nearly always angry.

**GLOMMER:** A genetic construct, designed by the Klingons. It is intended to do nothing but eat tribbles, and cannot attack anything else. When it catches a tribble it drops its long, multiple legs around the hapless furball and swallows it in one gulp.

**HORTA:** Not really an animal, the Horta is an intelligent silicon being thought to be the miners of Janus VI. It is about 7 feet long, three feet wide, and covered with mottled asbestos plating with multiple tentacles on the ventral surface. The Horta can burrow through rock very quietly (treat movement through solid rock as if the rock weren't there) by secreting a powerful molecular acid. This acid burns for 10D10 per turn until neutralized by washing it off. The Horta can spit this acid up to 3 meters for purposes of self-defense, but will not attack other life-forms unless forced to do so.

**LE-MATYA:** A very large creature, resembling a large mountain lion with unusual diamond-shaped markings. Its teeth and claws are very poisonous. (1D10 END damage for 1D10 turns unless antidote is administered. If victim is bitten or clawed again, extend the time by another 1D10 turns.) Native to the planet Vulcan's desert regions.

**MUGATO:** A native of the planet Neural, it is a large white ape-like creature with a red face and a large horn projecting from the top of its head. Its bite is poisonous (complex poison, 1D10 per hour until death). The only known cure is a native Neuralese root, from the mako plant. If the root is applied to the wound using a technique known only to the Kanutu witch doctors of that planet, the poison is neutralized, and no further damage is taken.

**SEHLAT:** The Vulcan "teddy bear" is a giant bear-like creature with six inch fangs. They can be dangerous, but Vulcans handle them with relative ease. Sehlat's can be tamed as pets, and are very loyal and loving. In these cases, they will defend their master to the death. Sehlat's are also very long lived creatures, some getting to be over 70 years old.

**TRIBBLE:** The tribble is a small (6-10 inch) ball of fur that has two real functions in life; to eat and to reproduce. It does both very well. The more a tribble eats, the faster it will reproduce because a tribble's entire metabolism is geared to reproduction. Tribbles are asexual, reproducing at will (and, as Dr. McCoy says, they have a lot of will) without the need for contact with another tribble. Tribbles are extremely affectionate and their purring has a tranquilizing effect on most humanoid species, the notable exception being Klingons. Tribbles hate Klingons and the feeling is mutual. In the presence of a Klingon, a tribble will screech in a rapid chattering fashion until either it or the Klingon is removed from the area. A second form of tribble was genetically engineered by Cyrano Jones. The second form of tribble does not reproduce when it eats. It merely grows! If the giant tribble is disrupted by some outside source (certain drugs, phaser or disruptor fire, or even a sharp blow), it breaks apart, being revealed as a colony creature composed of hundreds of normal-sized tribbles!

The gamemaster may use the above examples as guidelines for fleshing out the animals he/she creates with the animal creation system. Be imaginative in fashioning the background, shape, physical appearance, and actions of your alien creatures. A dozen logically developed animals are worth a hundred senseless random creations in terms of play value and enjoyment.

# U.F.P. Historical Update



The United Federation of Planets (known as the UFP or simply "the Federation") is an interstellar political alliance composed of a number of individual planetary systems, including Earth, Vulcan, Tellar, Andor and a great number of other autonomous planetary governments. The UFP is basically a representative democratic organization, with each member world sending delegates to the Federation Council, the UFP's supreme governing body.

The UFP governs all interstellar relations among member worlds, and between the member worlds and other non-member governments. Although member worlds have a great deal of independence with regard to their internal affairs, Federation laws and regulations have precedence in interplanetary matters.

The gigantic Federation bureaucracy has the enormous task of regulating a Federation-wide monetary and credit system, coordinating scientific research and development of new technology, arbitrating interculture disputes, developing incredible data banks of scientific, technical and historical data on many worlds, encouraging interculture trade and cultural sharing, and many other governing tasks.

In some ways the UFP is analogous to our present-day United Nations. Unlike the UN, however, the member cultures have given over to the UFP the authority to govern, not just advise. The realities of interstellar distances and dangers led member cultures to give up a bit of their independence to insure mutual security.

The two most important jobs of the UFP are protection of UFP citizens and exploration of the galaxy. Both of these tasks are largely the job of Star Fleet Command, the arm of the UFP entrusted with peacekeeping, law enforcement, trade regulation, and exploration. For more information of Star Fleet Command's duties, powers, and internal structure, see the next section.

The area of the galaxy known as "Federation space" is by no means limited to Federation-member cultures

alone. Though membership in the Federation is considered beneficial, it is in no way compulsory. Many non-member cultures exist within Federation territory, and live quite peacefully alongside their Federation neighbors. (The Orions are one such culture, though that particular relationship is constantly strained by privateer operations, despite Orion "neutrality".) On non-member worlds, Federation law is not in force, though many such worlds have extradition treaties, trade agreements, and mutual protection pacts with the Federation.

Those nearby friendly cultures who do not join the UFP usually have ambassadors sent to them to represent Federation interests in interstellar matters. Cultures not sufficiently advanced to be Federation members may become Federation protectorates if they wish, enjoying the benefits of advanced Federation medical and technical knowledge in developing their culture to a higher level.

Cultures within the Federation sphere of influence that are not intellectually or socially prepared to enter interstellar society or accept the idea of interstellar travel are watched over carefully by Federation sociologists with the help of Star Fleet. The Prime Directive (also known as "General Order 1") is the most important UFP law. It states that the normal and healthy development of alien life and culture may not be interfered with by the UFP.

This means that UFP member cultures are prohibited from influencing the cultural development of a more primitive world by manipulating its growth through superior knowledge or strength, or by providing a culture with advanced technology it is socially unprepared to use wisely. The Prime Directive may be violated only under the most extreme circumstances, such as when accident (*A Piece of the Action*, *Patterns of Force*) or deliberate action by an outside source (*A Private Little War*) have already upset the cultural balance of a world, to the immediate detriment of its people and causing a threat to the security of the Federation.

The chief interstellar rivals of the UFP are the Klingon Empire and the Romulan Confederation. Both cultures are long-time rivals of the UFP, though the Romulan conflict goes back farther, to the early days of the Federation.

The first encounter between the spreading Romulan Confederation and the then-youthful Federation came in the days before Warp Drive, over a hundred years before the current voyages of the Enterprise and her sister ships. War was inevitable in this conflict between Romulan expansionism and Federation exploration, but such a war had never been fought before.

The entire conflict was fought ship-to-ship. The Romulans took no prisoners and the Federation never had opportunity to capture a Romulan vessel. (Romulan captains do not surrender. They instead destroy a crippled vessel — and all aboard — when defeat is assured.) Thus, neither side ever saw the other face-to-face, nor discovered the location of the other's homeworlds.



The war was terribly costly in men and materials for both groups, and neither was able to gain any sort of decisive edge. Finally, an armistice was declared, with a treaty drawn up after negotiations by subspace radio.

A neutral zone was established between Romulan half space and the borders of the UFP. Entry into this area by either side was to be considered an act of war, with both sides setting up border monitoring stations to assure no ship would get across undetected.

The treaty remained unbroken until a lone Romulan ship, armed with a devastating plasma weapon and protected from detection by a sensor/visual "cloaking device", crossed the neutral zone and destroyed several manned Federation outposts. The ship was engaged by the U.S.S. Enterprise and pursued into the neutral zone. At this time, a skillful sensor probe penetrated the Romulan ship and UFP representatives got their first look at a Romulan. (See episode *Balance of Terror* for more information.)

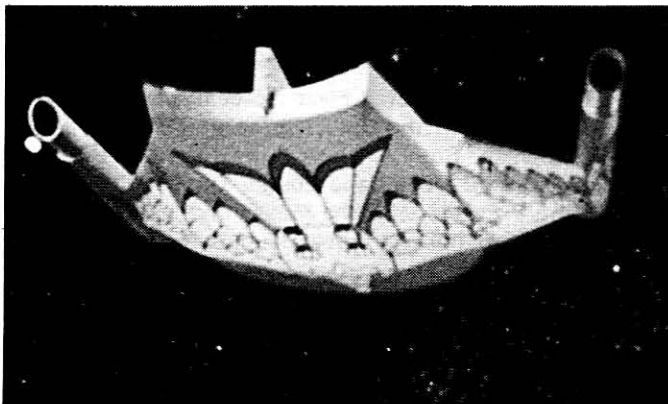

With no evidence remaining of Romulan incursion across the neutral zone, the treaty remained in force. There have since been other incidents, but an uneasy peace is maintained, largely because neither side wishes to risk the wholesale destruction implicit in a declaration of open war.

The Klingon Empire is a slightly more recent rival of the UFP, but the situation between the two cultures rapidly degenerated to the brink of open war. The Klingon social order can tolerate no culture other than their own. To the Klingons, domination of all within their reach is their destiny and their right. UFP/Empire relations were poor right from the first, but the final breaking point came with the Klingon invasion of the neutral planet of Organia.

The U.S.S. Enterprise, representing the Federation, was visiting Organia with an offer of protection from the spreading Klingon Imperial hold when the invasion came. Much to the horror of the peace-loving Organians, the two forces prepared to wage total war over Organia. Fortunately for galactic peace (but much to the consternation of both forces' commanders) the Organians were not the simple, humanoid farmers and peasants they at first resembled.

In actuality, the Organians proved to be highly advanced beings of pure thought energy, taking on human-like form in an attempt to put their visitors at ease. The Organians abhor violent conflict, and their incredible mental powers gave them the clout to back up their wishes for peace between the Klingons and the UFP.

The Organians drew up a peace pact (now known as the Organian Peace Treaty) and imposed it on both sides. It provides for the disputed area between the UFP and the Klingon Empire to be a protected zone administered by Organia. Inhabited planets in this area are protected by Organian mental might, and uninhabited class "M" worlds are to be developed under the guidance of whichever side is judged to be able to develop the world most efficiently. Forces of both governments in the disputed area must extend courtesies to their opposite numbers, with shore leave, medical attention, etc. to be allowed for members of either culture at bases within the disputed area. So far, there appears to be no way for either side to circumvent the Organian edict in any significant way.

Because of the Organian treaty, the Klingon Empire has had to resort to more subtle means than outright force to gain a toehold in the disputed area. They keep trying, however.

Most recently, Federation intelligence agents have discovered that the Klingon Empire and Romulan Confederation have made contact and concluded a widespread use of more advanced Klingon ship design and hand weapons among Romulan forces. Certain items of Romulan technology, including plasma weaponry, have become known to the Klingons. It is expected that though the Romulan plasma weapons are somewhat outdated, the Klingons will be able to merge this knowledge with their own technological knowledge and develop an analogue to Federation photon torpedo weapons within a few years.

Meanwhile, Federation expansion continues in other directions, with many cultures accepting Federation offers of membership or at least mutual protection and trade agreements. Two notable exceptions are the Gorn Alliance and the Tholian Assembly. Like the Romulan incident, first contact with both the Gorn and the Tholians led to immediate violence.

The Gorn first encountered a Federation base newly established in an area of space they claimed as their own. They reacted with typical Gorn brashness; they destroyed the base and everyone stationed there. Arriving in response to the base's distress call, the U.S.S. Enterprise pursued the fleeing Gorn ship into an uncharted area of the galaxy.

Once again, however, interstellar war was averted by the intervention of a preternaturally powerful race of beings. The Metrons refuse to allow two intellectually inferior species to wage total war in their area of space. They propose to settle the matter by placing both ships' commanders on an uninhabited asteroid to settle their differences with a personal combat to the death.

Captain James Kirk of the U.S.S. Enterprise won the combat, building a hand cannon from native materials as a weapon to offset the Gorn commander's greater physical strength and endurance. Captain Kirk refused to end the conflict by slaying the helpless Gorn, however. The Metron representative, impressed by Kirk's restraint, returned both commanders to their ships and transported them outside Metron territory. Talks were established with the Gorn, leading to an uneasy peace. The Gorn Alliance is too small and underdeveloped technologically to be a match for the Federation alone, but their warlike nature and refusal to negotiate a lasting peace make them a constant danger to Federation security. The Gorn Alliance

is officially recognized as an unfriendly power, but no declarations of war have been made, or are likely to be made in the near future.

The Tholian Assembly was known to the Federation by reputation among cultures encountered in the area long before any direct contact. First direct confrontation between the UFP and the Tholians came when the U.S.S. Enterprise (say, those folks get around, don't they?) was searching a previously uncharted region of space for the missing U.S.S. Defiant. The Enterprise is crippled by power loss caused by a tear in the very fabric of space-time, and attempting to retrieve the ship's captain, lost in space-time interphase while investigating the disabled Defiant.

At this time, a Tholian patrol vessel arrives, informing Enterprise First Officer Spock that the ship is encroaching on Tholian space. Despite Cmdr. Spock's efforts to explain their mission, the impatient Tholians finally open fire on the Enterprise, forcing the Federation vessel to return fire and cripple the Tholian ship.

A second Tholian vessel soon arrives, and the two ships begin weaving a Tholian tractor web about the damaged and power-loss hampered Enterprise. The Enterprise crew manages to rescue their captain and escape the Tholian tractor field, but the Federation is started off on the wrong foot with the mysterious Tholians.

At this time, little else is known about the Tholians or their government. Federation vessels attempt to avoid Tholian space, as the Tholians have made it clear that they do not wish visitors. However, the exact boundaries of Tholian-claimed space are not known, and those that are known keep being pushed outward by the Tholians. Eventually, if agreements cannot be made between the two governments, armed conflict on a larger scale may result. For now, the Tholians do not seem disposed to either make war or discuss peace.



## STAR FLEET TABLE OF RANKS

Recruit  
 Enlisted Second Class  
 Enlisted First Class  
 Petty Officer Second Class  
 Petty Officer First Class  
 Chief Petty Officer  
 Senior Chief Petty Officer  
 Master Chief Petty Officer  
 Warrant Officer  
 Chief Warrant Officer  
 Ensign  
 Lieutenant Junior Grade  
 Lieutenant  
 Lieutenant Commander  
 Commander  
 Captain  
 Commodore  
 Admiral

Attendees of Star Fleet Academy carry the rank of Cadet. While on the Cadet Cruise they carry the rank of Midshipman. Both of these fall in between the ranks of Chief Warrant Officer and Ensign. The Cadet and Midshipman are treated with the respect and courtesy due an officer, but do not yet carry the full responsibilities as such.

## STAR FLEET CHAIN OF COMMAND (Vessel)

Captain  
 First Officer  
 Chief Engineer  
 Chief Navigator  
 Chief Helmsman  
 Chief Communications Officer

On occasion, the captain of a vessel may be unable to command. The reasons are numerous; the captain may be planetside, he may be ill or injured, etc. This table gives the chain of command, or sequence, to be followed under normal circumstances. If any listed personnel are also unavailable, simply skip to the next available officer. Once these possibilities are exhausted, the chain of command follows the ranks from senior officer present on down.

## STAR FLEET CHAIN OF COMMAND (Planetside)

Base Commander  
 Deputy Base Commander  
 Chief of Staff  
 Chief Engineer  
 Chief Communications Officer

Same procedure as for vessels. Some bases may not have all positions listed. This is the case, merely skip the position.



## UNIFORMS

All Star Fleet personnel wear the same basic uniforms. Male personnel wear a tunic color-coded according to division (command, sciences, and engineer/support), black trousers, and black boots (see illustration).

Female personnel wear the uniform as shown below, consisting of a color-coded tunic, pantyhose, and black boots.

Dress uniforms also consist of a tunic and black trousers and boots. The tunic resembles a jacket, as seen in the illustration below. Notice the high collar and gold stripe down the front. A thin stripe is used for department heads, while a wide stripe is used for the captain and first officer. These tunics seal down the front with material similar to our present-day velcro. Also note that the trousers are bloused higher than with the duty uniform.

All tunics are color-coded according to job division; yellow-gold for command, blue for sciences, and red for services. Command includes captain, first officer, helmsmen, and navigators. Sciences includes all science related positions, including medical. Services includes engineering, security, fabrication; generally, anything that does not fit in the other two categories.

Many other uniforms are used by Star Fleet; ceremonial, outerwear, vac-suits, combat, etc., which are too numerous to be covered in detail here.

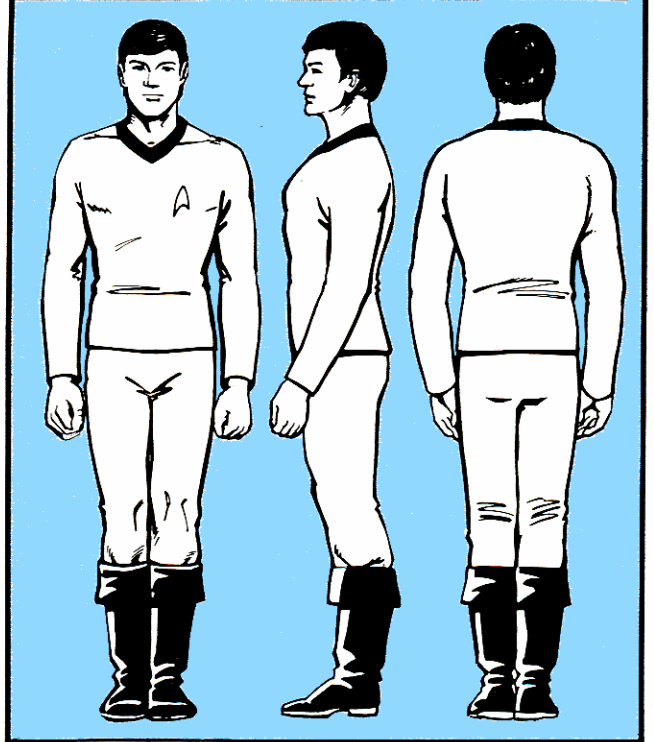
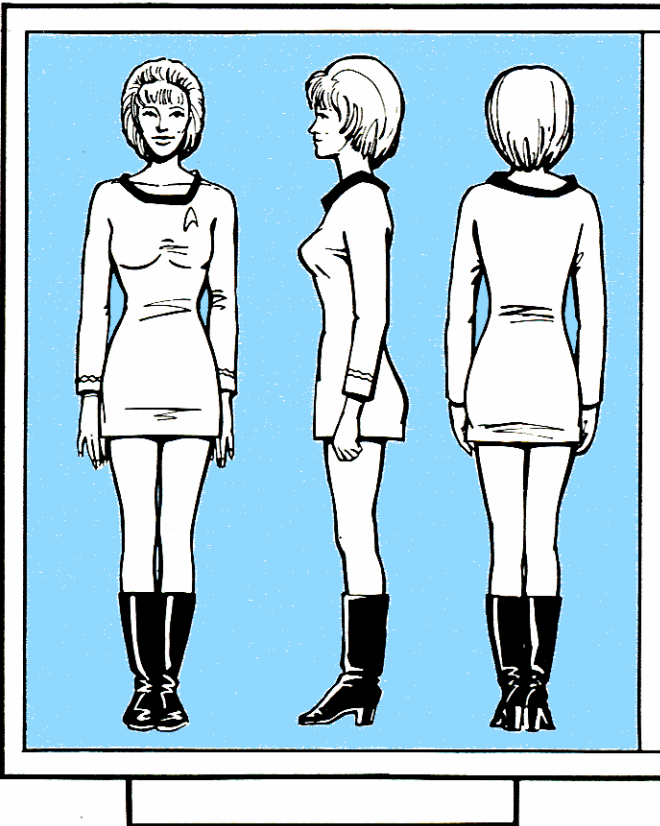



## INSIGNIA

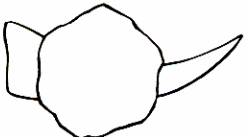
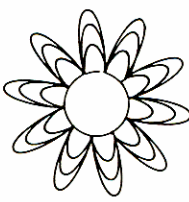

All uniforms carry insignia denoting rank and current assignment. The assignment insignia worn on the chests of officers and sleeves of enlisted personnel vary according to vessel served on or base assigned to. Each vessel or base has a unique insignia. The basic shape of the insignia will be the same for all personnel assigned to that particular vessel or base. The appropriate division device (see below) will be placed on this assignment insignia. There are thousands upon thousands of different assignment insignia. Shown below are some examples. Note that some variation is possible. Some vessels use individual devices for medical, security, etc. instead of the normal sciences, command or services insignia.

	U.S.S. Enterprise NCC 1701 (Hvy Cruiser)	
	Star Fleet Academy Assignment Insignia (in silver) (Filigree, not solid)	U.S.S. Sagan NCC 26100 (Research Vessel)



**DIVISION (DEPARTMENT) INSIGNIA**

		
Command	Sciences	Engineering and Support Sciences

**VARIATIONS IN USE**

		
Medical	Transporter Technician	Life Sciences

**COMBINATION EXAMPLES**

		
---	---	---

## RANK INSIGNIA

Shown below are the rank insignia worn on the duty uniforms. Officers' rank insignia are worn slightly above the cuff on both sleeves. Enlisted rank is worn midway between the shoulder seam and elbow on both sleeves. Officer rank insignia is gold, warrant officer, cadets, midshipmen, and enlisted ranks are in silver.

Note that Enlisted ranks wear assignment insignia on sleeves but not chest. Officers wear assignment insignia on chest but not sleeves.

### STAR FLEET RANK INSIGNIA

Assignment insignia is located 3 cm. below shoulder seam. Rank stripes/insignia are black. Distance between assign/rank is 3 cm.

#### ENLISTED



Recruit



Enlisted 2nd Class



Enlisted 1st Class

(Stripes are  
.5 cm. wide)



Petty Officer  
2nd Class



Petty Officer  
1st Class

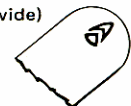

Chief Petty Officer



Senior  
Chief Petty Officer

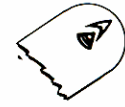

Master  
Chief Petty Officer

#### WARRANT

1 cm. wide  
Stripes  
are silver

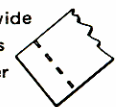

Warrant Officer

#### OFFICER

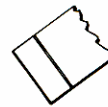

Chief Warrant Officer

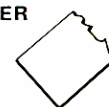

Ensign

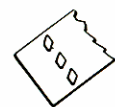

Lt. Jg.

All Officer stripes are located 6 cm. from cuff.  
2 cm. wide  
Braid is gold

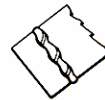

Lt.

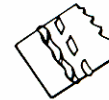

Lt. Commander

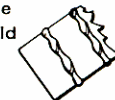

Commander

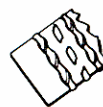

Captain

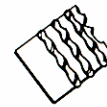

Commodore

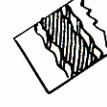

Admiral

#### ACADEMY



Cadet  
gold stripe 1 cm. wide



Midshipman



## DECORATIONS

Most decorations and awards in Star Fleet are triangular, with the color of the triangle varying by award. They are worn on dress and ceremonial uniforms only. These are worn in a single grouping in various geometric patterns. Several examples of positioning are shown below.

Only the highest awards or non-Star Fleet awards (presented by other governmental entities) are non-triangular.

### DECORATION LAYOUTS (See Dress Uniform photo)

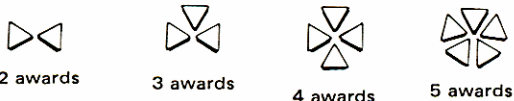

2 awards

3 awards

4 awards

5 awards



6 awards



8 awards

Awards are placed almost touching so patterns will be tighter than those shown.

## ORGANIZATION OF STAR FLEET

Star Fleet was brought into existence to act as the peace-keeping force of the United Federation of Planets. Similarities do exist between the UFP and today's United Nations. One major difference, however, is the fact that where today's UN members' military forces are non-permanent (assigned as needed temporarily), the UFP's Star Fleet is a single permanent entity. Any member planet's inhabitants may join Star Fleet if the individuals can meet Star Fleet's rigorous requirements. The fact that one force exists to act as military, police, and explorer shows how truly united the UFP members are.

Star Fleet is responsible for the protection of the Federation, the exploration of unknown areas, the colonization of habitable planets, and the safe transport of individuals and goods.

Star Fleet is composed of many departments. The four main departments are exploration, colonization, Military, and Merchant Marine. There are 17 smaller departments. All 21 departments draw upon individuals from the three divisions: command, sciences, and services. Also, individuals from all 21 departments cross over into other departments as needed. For example, the Enterprise is in the Exploration department. There are members from all three divisions (command, sciences, and services). There are chaplains, engineers, medical personnel, etc. on assignment to the Enterprise.

Basically, personnel from any department may be assigned to any vessel or base. On assignment, they report to their department head. The department head reports to the vessel's captain or base commander.

## STAR FLEET ORGANIZATION

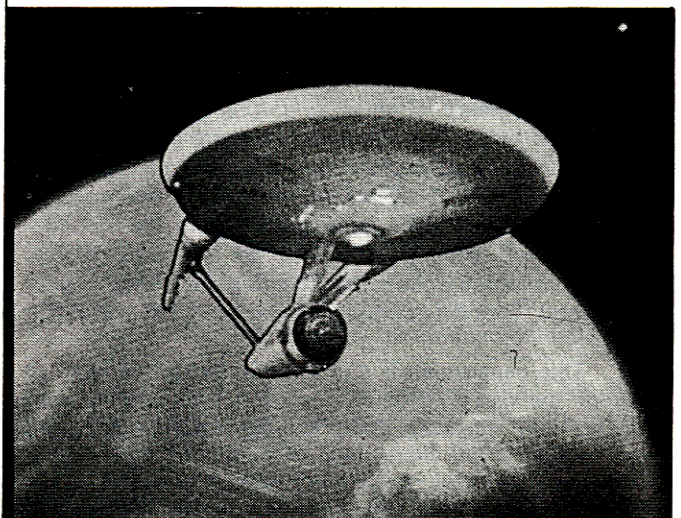
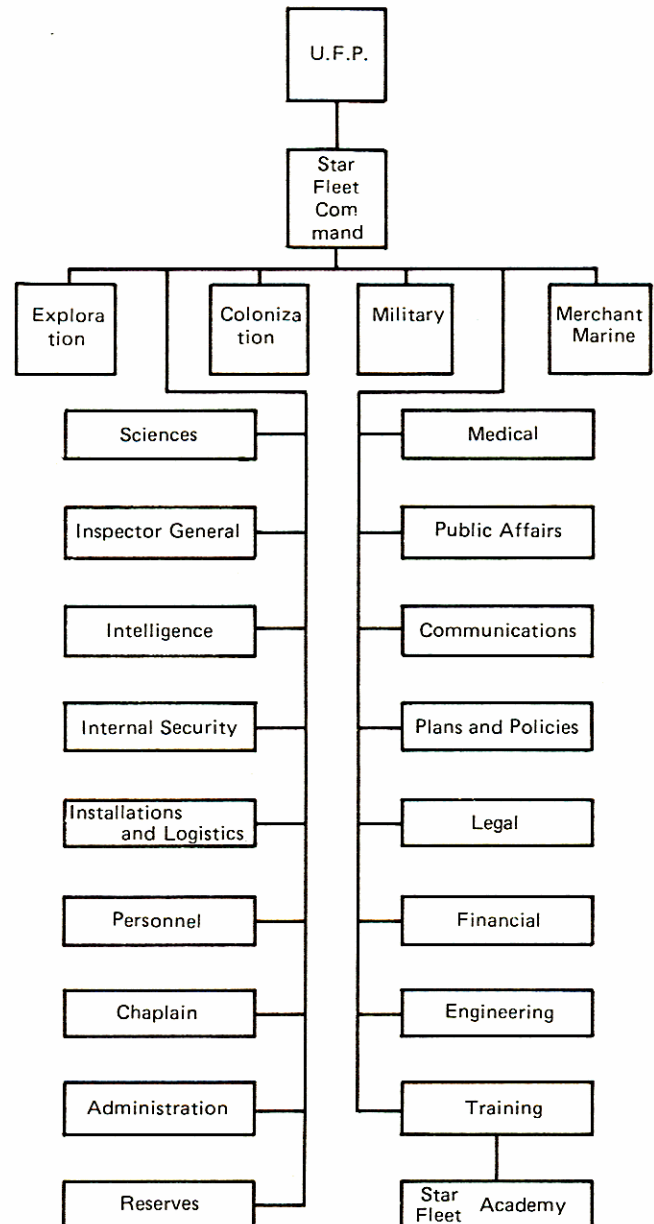



All personnel on Constitution class vessels are ensign grade and above. These ships are the best and the crews are the elite of the elite.

One item to note is that unlike today's military organizations where each department has its own planes, or vessels, etc., Star Fleet is a truly unified organization. The inter-service rivalries of the twentieth century are gone. The bickering and competition for better equipment than the other branches of service is virtually eliminated.

The 21 departments of Star Fleet are shown in table form below, then described briefly.

#### STAR FLEET COMMAND

Star Fleet Command (SFC) is the entity responsible to the UFP council for all actions of Star Fleet. "The buck stops here" is very appropriate to Star Fleet Command. When the size of the Federation is considered, along with the time necessary for communications, it can be seen how all units in Star Fleet are somewhat autonomous. However, SFC is broken down into 17 districts, each with one Star Base. These Star Bases are responsible for direction of all personnel and vessels in their command. Star Bases are commanded normally by a commodore.

Each Star Base will have thousands of personnel, vessels, and smaller bases under its jurisdiction. Constitution class ships (of which there were 12) are assigned as needed to Star Bases. These vessels operate independently, answerable only to the Star Base they are assigned to. These ships are rarely assembled into fleets except for short periods of time.

There are fleets under the jurisdiction of Star Bases. These may have any number of ships in them depending upon mission. Fleets may be assembled with several escorts protecting a convoy of colonization vessels, or tens of ships into a battle fleet in reaction to an attack on a border. A fleet may consist of several research ships, or research ships with military escort. Merchant marine ships could travel together for safety. The list is endless. Fleets are normally assembled only for short periods of time (a few months to a year) for specific missions (be it a diplomatic mission or a border skirmish). Normally, however, once a ship (except Constitution Class) is assigned to a star base it stays with that star base for the duration of its useful life due to the vast distances involved.

#### EXPLORATION

The Exploration Department is responsible for the exploration of the unknown areas of the galaxy. The department has vessels of all sizes, ranging from scouts with 5-man crews to the Constitution class starships with a crew of 430. Captains of exploration ships must be capable of independent action. They are far from higher command in time and space. In many instances, they are the first contact with new civilizations. They are like the explorers of old, establishing trade routes, fighting skirmishes (always defensively), acting as ambassadors of the UFP, and much more.

This department is also responsible for mapping all areas of the galaxy, finding planets to colonize by overcrowded UFP members, and making hazards known to other vessels.

#### COLONIZATION

The colonization department is responsible for settling suitable planets. Exploration finds appropriate worlds, and then the colonization personnel move in. First, a small (20-100 crew) survey ship makes a more thorough study of the planet, to make certain no intelligent native life is threatened and to survey and map the planet thoroughly. Studies are done of native flora and fauna. Possible sites for settling are determined. Geological formations are studied to determine if the planet has possibilities as an exporter of mineral wealth. At all times, a concerted effort is maintained to make sure the ecology of the planet will not be upset. Integration, not domination, is the watchword in Star Fleet.

Once the survey ship is satisfied that all is well, a medium size (25-150 crew, 200-750 permanent settlers) ship is sent to establish a small permanent colony (or colonies). A port and transporter facilities are among the first projects. Then come quarters, offices, and shops (maintenance). This group of colonists are the advance guard, so to speak, of the larger vessels that will arrive shortly, bearing thousands of colonists.

The largest colonial ships can carry up to one thousand people and their personal belongings. Once a permanent settlement has been established and no problems have been encountered, these ships arrive. They usually travel in groups with an escort of armed vessels. The number of ships depends on the size of colony to be established.

#### MILITARY

Yes, Star Fleet does have a military. Although Star Fleet and the UFP have peaceful goals, there are those who have other ideas, like the Klingons. The military department exists solely for defensive purposes. The military acts also as the "police" of the Federation, as no matter how peaceful militarily a people are, there will always be the thieves, pirates, and crooked con-men to be pursued.

The military has many different types of ships, some extremely powerful, but none to match the overall effectiveness of the Constitution class. Some ships may have more weapons than the Constitution, but none have the power and the quality of crew.

The military, besides having starships and fighting crews, also fields impressive ground forces. The ground forces are Marines, much as present day Marines cooperate with the Navy. These Marines are used as planetside police, as guards at large bases, and as defensive fighting units on hostile worlds.

It must be remembered that the military acts defensively only! Star Fleet does not exist to take over the galaxy, but to insure the peaceful coexistence of all peoples.

#### MERCHANT MARINE

The Merchant Marine is the trading and transport arm of the Federation. All merchant ships, privately owned or Federation owned, are regulated by this department. Most merchant ships are not armed unless they are normally involved in trade on the Federation's borders. The Merchant Marine is the source for many of the private and commercial traders. They will attend the Academy or



just serve as crew to 'learn the trade'. The Merchant Marine relies on the military branch to enforce the trading laws, having no enforcement vessels of its own.

Merchant Marine vessels range in size from ships carrying a few metric tons or passengers to ships carrying thousands of tons or hundreds of passengers. Here is where you will find liners rivaling twentieth century ships like the Queen Elizabeth II. Many ships have no live crew, being robot freighters. These ships are normally found on 'tame' routes deep within the Federation boundaries and safe from pirates and enemies.

#### SCIENCES

The sciences department encompasses any and all fields related to scientific research. Astronomy, astrophysics, geology, ecology, physics, and on and on. Research is carried out in a multitude of universities, space stations, laboratories, and ships. Research is funded by the UFP, corporate and private donations, and Star Fleet itself. Many of the science personnel are assigned to vessels in the Exploration and Colonization departments.

Responsible for research and development of all types not specifically under the jurisdiction of any other department.

#### INSPECTOR GENERAL

The inspector general's department is responsible for keeping Star Fleet personnel honest. This office conducts audits and investigations of any suspected wrongdoing.

#### INTELLIGENCE

This office is responsible for collecting data concerning any forces hostile to the Federation. This office would gather information about military forces, their disposition and strength, and possible motives. Data about enemy civilian locations, their ways and settlements, economy, habits, etc. would be collected. In short, the Intelligence Department collects data concerning anything about possible hostile forces. They must also keep all hostiles from accomplishing the same tasks with the Federation.

#### INTERNAL SECURITY

Responsible for providing security within Star Fleet itself, be it the individual who partied too much while on Shore Leave or assisting the inspector general on an investigation. These are the 'shore patrol' of Star Fleet.

#### INSTALLATIONS & LOGISTICS

This is the quartermaster of Star Fleet. The I&L is responsible for the construction and maintenance of all bases, be they planetside or space station. This department is also responsible for supply of all installations and vessels.

#### PERSONNEL

Responsible for recruitment of new personnel and records of all members of Star Fleet, active or retired. Responsible for appointments, promotions, awards, and decorations.

#### CHAPLAIN

Responsible for the religious and moral well-being

of Star Fleet personnel. Most large ships carry at least one Chaplain.

#### ADMINISTRATION

Controls correspondence, prepares and distributes forms, manuals, regulations, etc. In short, the secretaries of Star Fleet.

#### RESERVES

Responsible for keeping track of inactive Star Fleet members, for recall if necessary in an emergency situation. Fleet personnel may retire after almost any length of service, but Star Fleet doesn't lose sight of these valuable personnel.

#### MEDICAL

Originally part of the Sciences Department. It still is part of the Sciences Division, but became so large that Star Fleet made it a separate department. Psychology as well as microbiology, surgery, etc. are all here. This department has many personnel in the Exploration Department to study life on new worlds.

#### PUBLIC AFFAIRS

Handles community relations in areas where Star Fleet has bases near civilian populations.

#### COMMUNICATIONS

Handles communications of all types, whether it's sending a message within a ship or across the galaxy. Does R&D on communications equipment.

#### PLANS & POLICIES

Examines all plans & policies of Star Fleet to insure that they are in line with current doctrine.

#### LEGAL

Handles all legal matters within Star Fleet and in dealing with the public, up to and including court-martials of Star Fleet personnel.

#### FINANCIAL

Responsible for all monetary matters, including payroll, retirement funds, investments, monetary disputes, and funding for new projects, ships, and bases.

#### ENGINEERING

Responsible for maintenance, construction, and research of power units and related equipment for bases and vessels.

#### TRAINING

Responsible for the training of all Star Fleet personnel. Star Fleet Academy is part of this department. Normal entrance age for the Academy is 18, however exceptions are regularly made for exceptionally promising students. James Kirk entered at the age of 17. Star Fleet Academy is examined closer in the character creation rules of this game.

There are many other schools and institutions available to Star Fleet personnel. Many of the individual departments have teaching facilities of their own.

Training in Star Fleet never ends, with classes and instruction carried out anywhere and anytime feasible.

# Shipboard Systems

In this section, details are provided on many of the systems and features found on Federation starships. The Constitution class starships (such as the U.S.S. Enterprise) are used as the basis for the descriptions in this section, but many are found on other ships of Star Fleet, and some are found in altered versions on ships of other interstellar powers as well.

These descriptions are provided to give an adequate background for the capabilities of these systems in game terms. More detailed and specific information on systems are provided in the documentation accompanying STAR TREK ship design packets from FASA. (Packets on the U.S.S. Enterprise and her sister ships of the Constitution class and on the Klingon D7 Battlecruiser should be available from FASA at this time, with others to come.)

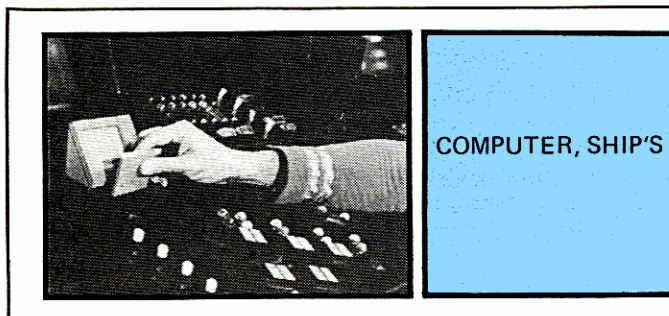

No interstellar vessel is flown totally by manual controls. Only incredibly sophisticated computer technology allows the harnessing of the matter/antimatter mix that powers Federation warp drives. (Ships of other star-faring cultures work in similar ways.)

Computer complexes control interstellar navigation, weapons systems, life support, power flow monitoring, and almost every aspect of life aboard a starship. In addition, reference data is stored in computer memory banks far more compact and sophisticated than those in use in the 1980s.

Because the functions of these computers overlap so much, most ship designs find it best to coordinate the efforts of these computerized controls through one central computer. Star Fleet ships larger than shuttlecraft all have centralized computer control, some more than others.

In the case of the U.S.S. Enterprise and similar starships, this central computer is programmed to respond to questions and other input in an almost human-like fashion. These Duotronic computers (so-called by their inventor, Dr. Richard Daystrom) are not truly capable of independent thought, but they are the next thing to it. (Daystrom's later development, the M-5 Multitronic computer, is a whole different story! See the STAR TREK episode, *The Ultimate Computer* for details.)

The central computer aboard Federation capital ships like the U.S.S. Enterprise responds to voice commands, and is capable of identifying a person unerringly

from a voice pattern. (And just as capable of denying information to those persons it considers unauthorized, though this feature can be worked around on certain material by a clever or well-trained individual). In addition, the computer can respond with a human-like voice and speech mannerisms.

(Early in its current five-year mission, the computer aboard the U.S.S. Enterprise was programmed with a distinctly female voice. Certain programming errors caused it to develop a much too humanlike attachment to the ship's captain, however, and the computer was later reprogrammed to behave a bit more mechanically!)

The central computers on large ships are tied in with huge memory banks of research and factual material known as library computer banks. The extent of knowledge in these banks varies from ship to ship, but the Constitution class starships have huge library banks that contain the entire body of factual knowledge known to the Federation! (Think of the Library of Congress at your fingertips, just a question away, and you'll have the right idea!) These memory banks also contain the ship's technical, medical, scientific and recreational libraries, and such information can be displayed on any terminal on the ship with the touch of a button or a verbal command.

Large ships have such terminals everywhere, including in the quarters of department heads and other important officers. There are study and recreational terminals in crew quarters on most ships. Of course, the most sophisticated and versatile terminal, including reprogramming controls, is on the bridge at the station of the science officer. The science officer is in charge of all computer operations on large ships.

The central computer on such ships is capable of translating languages instantly, of providing needed historical or cultural data, of analyzing data and coming to conclusions based on such analysis, and of monitoring every function of the ship. Many of these functions can be provided to landing parties, if they are equipped with communications equipment and data-gathering devices such as tricorders for feeding data by communicator link to the ship's computer.

These sophisticated computers make many of the ship's routine functions almost automatic. This is good, since a large ship can be made to operate with just a skeleton crew if necessary. It can also lead to problems, if the computer is tampered with or damaged. Manual controls are available for every system, but they do not operate with the speed or the efficiency of the computer-controlled methods.

In a very real sense, the central computer is the brain of the ship — its most useful, and potentially its most vulnerable part.



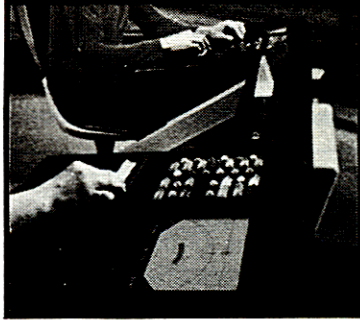

## DEFLECTOR SHIELDS

This electronic force screen is the first line of defense for most types of larger ships, including most Star Fleet capital ships. Deflector shields (also called "deflector screens") dissipate the force of any impact of matter or energy, preventing damage to the ship.

During normal operations, shields are held to minimum power. At this level, they can sweep aside space debris, small meteorites and other navigation hazards. (It is also effective against old-style radar, though not against the more sophisticated sensing devices of modern starships). Shield power can be increased to any part of the shield at a moment's notice (called "raising the shields"), if enough ship's power is available. At maximum shielding strength the drain on power reserves is enormous, and such a state cannot be maintained unless power is diverted from other major systems such as warp drive and weapons.

Shields are effective against both matter and energy — even antimatter in very small quantities. The more damage the shield absorbs, however, the more likely it is to be overloaded by the stress. If a shield is overwhelmed some of the kinetic energy is passed to the ship. In some cases, the shield generators may be damaged, causing the shield to "fall" or become unpowered.

Because deflector shields absorb energy discharge, their presence blocks the use of transporters in or out of a ship. A ship's weaponry can be used with shields up, however.

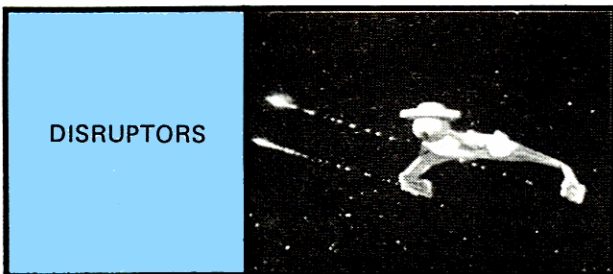

## DISRUPTORS

Disruptors are the prime ship-to-ship combat weapon of several spacefaring cultures that are rivals of the Federation, including both Klingons and the Romulans. Romulan craft are now, in fact, using Klingon-design ship disruptors as well as a number of Klingon-design ships, due to a recent technology-exchange treaty.

The shipborne disruptors do not work on the sonic principle, as do the disruptor sidearms carried by Klingons, but the effects are very similar. Disruptor fire causes

massive destruction of nervous tissue in living things, and also heats and breaks up the molecular structure of most solid materials.

Though disruptor bolts are not as versatile or powerful as phasers, Klingons prefer them (though some phaser technology is known to them) because disruptor banks are less of a power drain, easier to maintain, and less vulnerable than delicate phaser equipment.

Disruptors can be directed against ground targets, but they are not terribly accurate for that purpose. Klingon commanders, however, would mainly use such tactics as a move to induce terror in a population, or wipe out large areas, so this is not a particular handicap for their purposes.

## FOOD SYNTHESIZERS

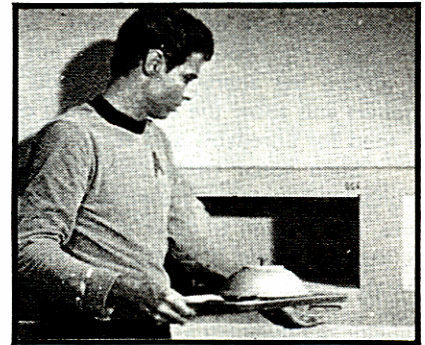

On most larger modern star craft, the problem of storing and preparing food has largely been solved by the use of food synthesizers. These computer controlled devices are stocked with basic protein, fiber and nutrient supplies. The machine then takes these basic foodstuffs and reworks them into textures, colors and flavors that are almost indistinguishable from freshly prepared meats, vegetables and fruits. Better food processing units can produce almost any meal desired, from memory banks containing millions of recipes and specialty food stocks in special storage.

On board Star Fleet vessels, synthesizers must be programmed with dishes that are palatable and attractive to the representatives of many very different Federation races. Synthesizers on larger ships also are prepared for the visits of many types of alien guests. It is the responsibility of the ship's commissary department to maintain and control food synthesizers and to gather and program new menu items.

Outlets for food synthesizers are food slots. A nearby keyboard allows selection of your meal. (Some units have visual displays as well). Production of a standard item takes almost no time at all, as part of the processing of such items (basic breads, meats & cheeses) is done in advance. More exotic dishes take a bit longer, but never more than a couple of minutes.

Food slots are found in the mess hall, of course, but some ships have several located in other areas so crewmen can pull a quick snack while on duty. The remote food slots are serviced by a miniature version of the turbolift system, in some cases paralleling the turbolift shafts themselves. Often, remote food slots are found near turbolift stations for this reason.



## FORCEFIELD, DETENTION



A detention forcefield is a variation on the principle of the deflector shield. It is used in a ship's brig to provide an invisible barrier across the open doorway of maximum security detention cells. Such a barrier is safer even than a steel door, since it will not only prevent escape, but absorb the energy of a weapon attack (on or by a prisoner) and allow the easy viewing of a prisoner without the need for unreliable and vulnerable surveillance cameras.

Such force fields provide a mild shock when a prisoner attempts to penetrate them — not enough to injure, but enough to deter escape attempts and to remind one that the shield is indeed on. The fields have their own separate power supplies, so that an interruption in ship's power will not allow an escape. Normal sidearms (such as phasers and disruptors) will not penetrate the field, unless fire is sustained. Heavier weapons may overload the field (as with deflector shields) and cause it to fall.

## GRAVITY, ARTIFICIAL

Since the development of cheap, effective means of controlling and simulating gravitation, almost every starship has been equipped with artificial gravity. Gravity controls are maintained by the ship's environmental computers, and the fields automatically compensate for normal ship acceleration, though they cannot react fast enough to prevent short, unexpected jolts (such as impact shock passed through the hull or emergency evasive maneuvers).

Usually, power for artificial gravity systems is on a separate circuit from other systems for the crew's protection, and a ship would have to suffer quite a bit of damage to have those controls fail. Artificial gravity can be reduced or shut off entirely in localized areas, such as VIP quarters for beings from low gravity environments, or in the gymnasium for zero-G combat exercises.

Most Star Fleet ships maintain a 1G (Earth normal) field, as 1G is a convenient medium level, tolerable by most Federation and friendly species. A ship manned entirely by Vulcans might maintain a Vulcan-normal field, adjusting it downward only when visitors were aboard. Some smaller ships, particularly military vessels in front-line service, prefer to keep a zero-G condition, having become used to living and working without gravity.

## IMPULSE POWER

Most starships, and many sub-light vessels, are equipped with impulse power engines, a type of reaction thruster. Impulse engines are a cheap, clean reliable source of sub-light propulsion. Power is created by the operation of such engines, and this power can be diverted for use in ship's systems. (Nowhere near as much power is produced as with the matter/antimatter reaction of warp engines, however).

Impulse power alone can be used to drive a ship to nearly the speed of light, but only the use of warp drive makes interstellar travel practical. Still, variations of the impulse drive are in use by every major starfaring race in the galaxy because of its dependability for interplanetary travel and maneuvering.

## LOG, SHIP'S

Almost every vessel in space keeps a ship's log — a complete record of the ship's voyages and day-to-day operations. The captain and officers of a ship will record important orders and updates on the operation of their departments, this procedure being called "logging an order" or making a "log entry". The ship's computer, however, is constantly updating the memory banks devoted to the log with data about ship's condition and routine matters.

In times of crisis, a captain may request that the latest entries in the ship's log be beamed back to his nearest headquarters outpost (in the case of Star Fleet ships, to Star Fleet Command or a nearby Starbase). This is done if the captain feels there is a significant chance that the ship may be lost in action, to warn later expeditions of possible danger. If a ship is in immediate danger of destruction, important information from the log may be recorded and released in a ship's message torpedo. If a ship is crippled, a ship's recorder marker, containing a locator beacon and recordings of the most recent log entries, is launched automatically. Of course, the log contents are beamed back to headquarters automatically by the computer every so often in any case.

An officer on a landing party who is out of contact with the ship may record a "supplemental log entry" using a tricorder. This is a record of his actions and impressions on-the-scene, and can later be transferred to the official log when contact with the ship can be made.

## MATERIAL FABRICATION

Since it is impossible to predict with 100% accuracy what items a ship's crew will require on exploratory missions, larger ships carry supplies of raw materials and computer controlled mini-factories called "material fabrication units". The memory banks devoted to this system contain plans and manufacturing data for thousands upon thousands of common pieces of hardware, and others not so common. Clothing, small devices, and almost any other basic item can be manufactured quickly and in quantity by these processing devices.

Thus, ship's stores of repair parts, clothing, basic personal items, and expendables can be much smaller, with more being created from easy-to-store raw materials as desired. This allows a landing party, for instance, to be outfitted in clothing to match native costume. Patterns stored in the computer are consulted, and material fabrication machines turn out complete, tailored wardrobes, right down to belt buckles and bobby pins. In the same way, when sick bay requisitions simple items like tongue depressors, they can be turned out quickly. The ship's quartermaster is in charge of material fabrication and ship's stores, in the same way the mess department is in charge of food synthesizer machinery.



By the way, the use of material fabrication machines to produce uniforms eliminates the need for a ship's laundry (other than a small facility for personal items of clothing not recycled), as soiled uniforms are simply reduced to component parts and recycled, not washed.

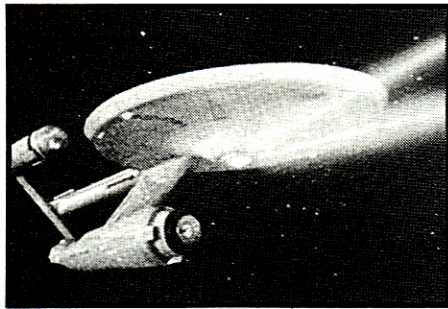

PHASERS

The phaser is the major shipborne weapons system in use by the Federation Star Fleet. The operation of the phaser sidearm is covered in the weapons section and under combat. Ships carry artillery-sized versions of these weapons, often mounted in pairs called "phaser banks".

Ship-mounted phasers are usually used for ship vs. ship combat, but can also be directed against ground targets. When so used, they can be fired accurately within a city block or so. Even more accuracy is possible if someone with an active communicator acts as a forward ground observer. When so used, they have the same effect as a hand phaser set on disintegrate, disrupt, or heavy stun (depending on the way the phaser bank is tuned), but affecting an area half a city block across! In this manner, a starship could easily level a city in a matter of minutes with phasers alone!

Phasers are actually armed and fired from phaser control rooms near the phaser banks themselves, but can usually be aimed and activated from repeater controls on the bridge. Phaser operation depends on keeping the banks cooled. A special coolant gas is used for this, and one of the main jobs of phaser technicians is maintaining this cooling system. The gas itself, however, is poisonous to humanoids (doing 3D10 damage to END per turn it is breathed), so phaser room duty is somewhat hazardous.

#### PHOTON TORPEDOES

Basically a Federation weapons system (though the basic technology is known to both Klingon and Romulan science), the photon torpedo is a formidable weapon for ship-to-ship combat. The torpedo itself is an elongated ovoid shape a bit less than a meter long; a magnetic bottle containing a small bit of matter/antimatter mix similar to that used by warp engines. When loaded and armed, it becomes a destructive fireball held in check by a powerful magnetic field. The fireball is then launched at target.

In addition to use as a torpedo-type projectile weapon, photon torpedoes can be laid like mines with time, impact, remote, or proximity fuses. Only larger ships can carry these weapons, however, because of the level of sophistication of the fire control equipment and the power required to establish the magnetic field needed to arm them safely. For this reason, Klingon and Romulan vessels

do not currently use these devices, though the technical know how is most likely available to them.

**DESIGNER'S NOTE:** Klingon and Romulan vessels do not use photon torpedoes at the time of the original U.S.S. Enterprise 5-year mission. It is only a step away for them, however, as the technology is similar to that used by the Romulan plasma weapon. In the "near future" — by the time of the first STAR TREK movie — Klingon vessels will at least have photon torpedoes. An interesting scenario might involve an experimental use of these aboard a Klingon battlecruiser encountered by the players!

#### SENSORS

The generic term "sensors" is used for the battery of detection, sampling, and analysis devices used by ships in space to examine their environment. Ship's sensors are used in navigation to fix exact position of a ship by examining the relative positions and spectral class of detectable stars and comparing them, through the ship's astronomical computers, to known patterns. Sensors also tie in with deflector shield controls to protect the ship from meteorites and other moving hazards of space.

Energy sensors can be directed at an object in space or a location on a planet's surface to determine the amount and type of energy being output by the object or location. This function can be fine tuned to give very accurate readings on the defensive screening of a ship or the radiation level of a dangerous area.

Material analysis sensors can tell a great deal about the dimensions, physical composition, and material properties of an object. In this respect, they give data much like a remote spectrograph, including exact chemical composition, assuming a close sensor scan can be made for a period of time. The dimensional data given by these sensors is used by the transporter to find a suitable place for beaming down a landing party, and to prevent them from being beamed into solid rock or other obstacles.

Life sensors measure the abundance, type and condition of living things at a distance. These sensors can tell one species from another — even one race from another (such as detecting the presence of Vulcan life readings aboard a derelict ship). This latter function requires a very close examination at close range, however. Life sensors can scan closely enough to guide the transporter for quick beamup, but only if the particular life patterns are known, or the living beings to be beamed are not among a large number of other, similar beings.

Reliable sensor data can be obtained by most standard sensor devices out to a distance of 100,000 miles, with sketchy, less-reliable data available to about twice that distance. Sensor scans are blocked by large amounts of rock or water, extremely thick atmospheres, electromagnetic interference, and certain types of dense or reflective materials.

#### STANDARD ORBIT

The so-called "standard orbits" used by many star vessels when holding near a planet are calculated according to planetary size and gravity, planetary conditions, locations and orbits of natural or artificial satellites, etc. Usually this orbit is from 1000 to 7000 miles above a planet's



surface. Orbits can usually be established that keep a ship directly overhead at all times, to facilitate landing party communications. Sometimes, however, local conditions may make this type of orbit impossible.

### STARDATE

Stardates are calculated from the standard Federation dating method. Keeping track of dates is harder than one might think on a faster-than-light ship because of Einsteinian time compression. The stardate is relative to position within the galaxy, and the method of computation is too complex to be discussed here. Dates are usually given in the form xxx.xx. (Sometimes one digit is given after the decimal point, sometimes two). Thus, Stardate 3305.6 would be read as "Stardate thirty-three oh five point six" not "Stardate three thousand five point six".

**DESIGNER'S NOTE:** A common usage among STAR TREK fans is to state regular calendar dates in Stardate form. This system makes the first two digits before the decimal point the same as the last two digits of the calendar year, and the second two digits the same as the numerical order of the calendar month. (Put a zero in front of the number if less than 10. In other words, August, the eighth month, is written as "08"). The two digits after the decimal point represent the day of the month (again, with an added zero if the number is less than ten).

Thus, the date "January 22, 1983" or "1/11/83" would be expressed as "Stardate 8301.11" in Stardate form. Though this designation is not precisely the Federation form (and episode dates do not translate in this manner) it is a useful and unique dating method, which we present here. Try it with your own gaming group!

### SUBSPACE RADIO



Normal radio signals (as a matter of fact, any electromagnetic phenomena) travel at the speed of light. Thus a message sent from a starship in that manner might arrive months, years, or even centuries after the ship itself had made port! This makes common radio or TV useless for interstellar communication.

Subspace radio is the standard means of faster-than-light communication used by all starfaring races. It avoids the speed-of-light problem because its signal uses a space warping effect that causes it to travel much faster.

Though it is much faster than normal radio, it is not instantaneous. Galactic distances are so far that even by subspace radio, a message may take days or weeks to reach its destination from a remote part of the galaxy. Thus, starship captains must often act on their own authority, knowing that new orders from Star Fleet may take too long to arrive, or be outdated by changes in the situation by the time they are received.

### TRACTOR BEAM

A form of "electromagnetic tow cable", allowing an item of smaller mass to be drawn toward (or merely anchored to) the mass controlling the beam. The opposite of a tractor beam is a "pressor beam", which pushes things away. Many larger ships are equipped with these devices, which can be used carefully in pairs to manipulate objects at a distance. Maximum range for tractor or pressor beams is about 100,000 miles.

Tractor beams can put quite a bit of strain on an object (especially if the object is trying to break away), and a more delicate structure such as a small vessel could suffer damage as a result of resisting their use.

### TRANSPORTER

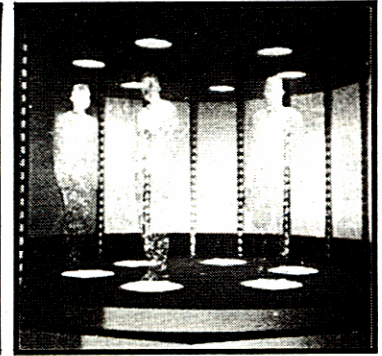

The transporter is a matter/energy scrambler, capable of recording the molecular and sub-molecular pattern of an object, disintegrating that object, and beaming it across space to be reformed at the other end. Both living and non-living material may be moved great distances at the speed of light in this manner. No receiving station is necessary for use of the transporter if reliable data can be obtained about the destination via sensor readings, or if a communicator can be used to provide a target signal.

The transporter can also "lock in" on distant items and beam them back to the transmitter station. Again, a target signal or sensor readings are necessary to allow the transporter to lock in on the coordinates of the desired item or person.

The range of the transporter device is about 16,000 miles, and the same things that block sensor readings block transport as well. In addition, transporters cannot beam through deflector shields.

Objects in transit (already dematerialized but not rematerialized) can be suspended as energy patterns for a time, but such suspension is dangerous as patterns can drift and be lost if care is not taken to maintain the transporter lock.



For each 5 minutes an object is held, the transporter operator must make a standard saving roll against his/her Transporter Operational Procedures skill level. If the roll fails, the lock is lost unless a LUC saving roll is made. Anything or anyone lost in this manner is irretrievable unless a desperation saving roll is made immediately by someone with a skill level high enough to succeed with a +40 modifier to the roll !

Transporting under normal conditions is no problem if the controls are operated by a qualified individual (Trans. Op. Proc. skill level 10 or above). Under ideal conditions, the transporter panel can even be set to operate automatically after a few seconds or minutes delay, allowing someone to beam himself with no operator at the panel.

The normal use for the transporter is for beaming down to a planet's surface, but it can also be used for beaming ship-to-ship. Beaming within the same ship is possible, but very dangerous since the fine control necessary and internal interference on shipboard could cause the transportees to materialize inside a solid object. Such a materialization would be fatal and could possibly cause an explosion.

A table of required saving rolls (on the Trans.Op. Proc. skill level) for some normal and special transporter operations is provided here.

#### TRANSPORTER OPERATIONS — SAVING ROLLS

No saving roll required for routine ship-to-planet, planet-to-planet, or ship-to-ship beaming. For other situations, make a standard saving roll on the Trans. Op. Proc. skill, with the appropriate modifications as listed:

S-P = ship-to-planet	P-S = planet-to-ship	
S-S = ship-to-ship	(S) = beaming within same ship	
S-P or P-S / bad atmospheric conditions or other local interference		+20
S-P or P-S / transporter rooms on both ends operating		-40
S-S / transporter only operating at one end		+10
P-S or S-S pickup / locking in using sensor readings only		+10
ANY / beaming to location already used once in last 24 hours		-20
ANY / beaming during low power situation (ship's normal power reserve below half)		+25
(S) / any beaming inside same ship		+40

Failure of a saving roll means that beaming cannot be accomplished and everything stays where it is. A second try can be made, but if it fails; something goes wrong and a transporter accident occurs. The result of a transporter accident is up to the gamemaster. Usually, it would result in loss of the object or person beamed, or in death through improper assembly at the target point or beaming into solid matter. Unless this risk is acceptable, no further attempt to beam can be made unless one or more of the restricting conditions change.

Federation transporters are of three types. The standard personnel transporter can accommodate up to six beings (or inanimate objects of approximately man-size or smaller) at one time. (All objects or beings beamed at the same time have one saving roll made for the group, with the same consequences shared by all.) This is the most commonly used variety.

Cargo transporters have 96 diamond-shaped transporter segments instead of the personnel transporters transmitter disks. These are used to transport bulky, non-living items. If they must be used for personnel, a saving roll on the Tran. Op. Proc. skill must be made even under ideal conditions or the transportee does not survive. (Cargo transporters are more coarsely tuned, with less fine control). Also, all penalty modifiers for adverse conditions are doubled!

Emergency transporters have 22 transmitter disks and are only used for emergency evacuation efforts. They have controls as fine as the normal personnel transporters, but are enormously wasteful of power. Thus, a saving roll is always required when using them, but penalty modifiers are not doubled.

Transporter usage must be set up in advance. It takes about 3 full combat turns to set up a transporter procedure on the console before the command to "energize" can be given. Once the slide is moved to begin energizing, it takes a full turn (10 seconds) to dematerialize and another full turn to rematerialize elsewhere.

During this time, the characters being beamed cannot move, communicate, or take any action whatsoever. However, they are invulnerable to most normal harm during this time, though they can be seen at the transmission end while dematerializing, and at the receiving end while rematerializing.

Though someone is on duty at all times in the transporter room, a call for a quick beamup will take 2 turns to process unless communication is established, sensors are locked on the target to be beamed up, and the transporter panel is ready. If this is the case, dematerialization will take place at the beginning of the next combat turn.

#### WARP DRIVE

The galaxy began to open to exploration in earnest with the development of the warp drive by the Alpha Centaurian scientist Zefrem Cochrane. Warp engines produce power through the controlled annihilation of a delicately balanced matter/antimatter mix. Part of this power is used for most ship's systems and the rest diverted to propel a star vessel at faster than light speeds. Klingon, Romulan, Gorn and other starfaring fleets use variations of the same warp drive system known to the Federation.

The matter/antimatter mix must be carefully controlled and contained. For safety's sake, most ships equipped with warp drive components place them away from the main body of the ship, mounted in nacelles on outriggers or other supports. If the matter/antimatter mix gets out of hand, the nacelles can then be jettisoned to explode away from the ship itself.

Warp speeds are measured by "warp factors", which denote a geometrical expansion of speed rather than a linear scale. To put it simply, where "warp factor 1" represents the speed of light, warp 2 is 8 times lightspeed (the cube of the warp factor number), warp 3 is 27 times lightspeed, warp 4 is 65 times lightspeed and so on. In actuality, however, these speeds vary according to the four-dimensional "shape" of space in a given area. Thus, a warp drive ship may cover much greater distances than these at a certain warp speed.

# Starship Combat

Starship combat in this game is unlike most other tactical space combat games. Success in warfare with complex machinery, from tanks to starships, depends on using the equipment to best advantage. STAR TREK is no different in this philosophy.

Where STAR TREK differs is in the approach to combat. A simple boardgame could have been used, but STAR TREK as developed here is intended as a role-playing experience. Unlike other tactical space combat systems, STAR TREK offers the opportunity to "role play" during ship combat as well as during ground or ship based adventures.

In the system presented here a number of players will interact, cooperating in an attempt to defeat an enemy ship (or a number of ships). The atmosphere of a game session then becomes much like that on the bridge of a starship, with each player having a responsibility to control one part of the ship's functions.

To keep track of the ship functions in play, each player uses a control sheet or panel. These players will communicate vital information back and forth during combat, using their panels to record the turn-by-turn changes in power levels, ship's weaponry status, crew casualties and more.

These rules are divided into sections for each active player; captain, engineer, helmsman, science officer, and communications officer. (Other officers may participate, give advice, etc. However, the other officers play a less crucial part during battle).

Each Player need only read and understand the rules pertaining to that player's position. As play proceeds, players will become familiar with how other positions fit into play. The gamemaster, however, must be knowledgeable in all sections of the rules, partly to guide the players, and partly because he will be using a simplified version of these rules to run the enemy ships.

Another difference between this and other tactical games is in movement. Speeds in the STAR TREK universe are extremely, almost unimaginably, fast! A ship going warp 1 is travelling at the speed of light (186,000 miles per second). As warp factors increase, the speed increases exponentially.

That is, at warp factor 2, a ship is moving at 8 times the speed of light. At warp 3, the speed is 27 times the

speed of light and so forth. By the time you reach warp 10, a ship is moving at 1000 times the speed of light!

Despite these enormous speeds, STAR TREK's weaponry (phasers, photon torpedoes, and such) work and are targetable at any speed. (In the episode *Journey to Babel*, for example, an Orion ship attacks the Enterprise while moving at warp 8; 512 times the speed of light!)

It is then obvious that ship speed does not matter to weapons fire. There are still problems involving speed, however.

Consider an example from current warfare. You are standing in the middle of a street when a small jet streaks over. If both you and the pilot each know the other is there, and both have weapons available and ready, you might just get one shot at each other as he screams by. Without sophisticated electronic help, you couldn't hope to hit each other. Even so, he's gone in a second and it will take some time for him to turn around for another pass.

The jet plane vs. pedestrian scenario is comparable to two starships, one moving at warp 1 and one at warp 2. By the time a captain can say "Fire photon torpedoes!" the other ship is one and one-half million miles away! (A bit far for even STAR TREK's weaponry!)

In other words, to have combat, the relative speeds of the combatants must be similar. Whether they are moving at warp 1 or at warp 10 is unimportant, as long as both are moving about the same speed.

Individual ship speed is important in one respect— it is harder on a ship to make a tight turn at high speed than the same turn at low speed. This will come into play in this game.

A character's individual skill ratings will affect that character's performance in certain areas of combat activity. Players will roll % dice in an attempt to make a saving roll on one skill area or another to determine how well the character performs in combat. As with all saving rolls, a score on the % dice equal to or less than the appropriate skill rating indicates success.

If there are not enough players for each of the 6 bridge positions, one player may handle more than one character. Both player characters and non-player characters may be involved in combat rounds.





## GENERAL INFORMATION

The tactical combat game begins when a ship first makes close sensor contact with another vessel, coming within identification range. The gamemaster can handle first sensor contact as appropriate for the situation. An enemy ship may hang around the edges of maximum sensor distance, barely detectable. In such a case, it would require a very good saving roll on the starship sensors skill (a +20 roll at least) to tell anything about the type of a ship, power systems, etc.

Eventually, if combat is to occur, the ships will approach close enough to be identified. This is when the ships first move onto the map. The speed of the two ships will be matched at this time and should be declared (as sub-light, warp 1, warp 2, etc.)

When playing scenarios from this book, starting positions and ship types will be specified. Use appropriate counters on the tactical display. Each ship has a different set of control panel displays as well. When there are players operating both sides, the full set of charts for each is used. When the gamemaster is operating enemy ships as part of a campaign situation, he has the option of using a simplified control system. The simplified system is useful when running several enemy ships, or resolving a combat situation in a campaign.

These rules will center around battles involving a Constitution class starship (like the Enterprise), but they can be used with any type of ship. A number of Federation ships and enemy ships are provided with this game, and others are forthcoming from FASA.

Next, read the section that pertains to the character you will be playing aboard ship. Gamemasters should read all sections.

### A NOTE ON HEXAGON MAPS

The mapboard used with the ship combat system is a grid of six-sided areas called hexagons or hexes. Those familiar with modern adventure games are probably used to hexboards, but for newcomers, a short explanation is in order.

Hexboards are often used in games like this one because they make space movement more realistic, providing six possible movement directions instead of the four offered by squares. The hexes on the enclosed mapboard are numbered for convenience in placing items for scenarios. Both numbered and unnumbered hexmaps in various sizes are available from most adventure gaming stores, if you wish to use a larger map for combat.

Each hexagon has six sides where it borders other hexes. These hex sides can be important in this game, for they are used to divide a ship's protective deflector screens into areas, and to determine a ship's facing for purposes of firing weapons and moving.

## SHIP'S CAPTAIN

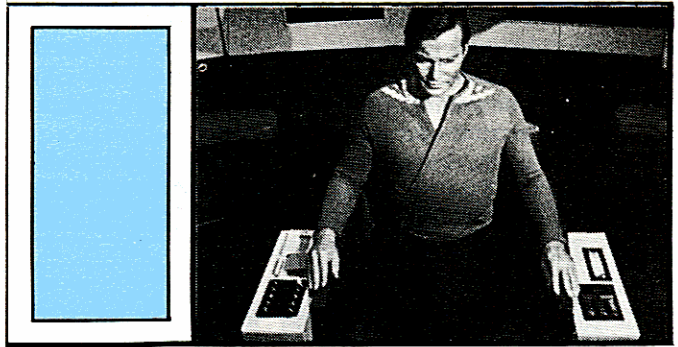

Once sensor contact and identification is made counters representing each vessel or base are placed on the blank hex map. Starting positions are noted for scenarios in this book, and the gamemaster should select counters and starting positions for combat encounters during play.

The STARSHIP COMBAT TACTICS/STRATEGY skill determines the relative starting positions of the opposing ships. The skill levels of the opposing ship commanders is compared, with the highest level commander considered to have the tactical advantage throughout the scenario (unless the character is a casualty, in which case the skill level of the replacement is used.)

The player with the tactical advantage decides at the beginning of the turn which side will move first. At times, it may be advantageous to move first, but sometimes it is better to delay movement.

The ship's captain makes the crucial decisions involving combat. It is up to the other officers to carry out the captain's decisions, and to provide him with the information necessary for him to make those decisions intelligently.

The captain may ask at any time for a status report on the readout panel before any crew member, or for any information on that panel. Using this information as a guide, he decides when to raise shields, when to fire weapons, how to maneuver them, etc. Just imagine yourself as Captain Kirk.

There is no control panel for the captain. His role is to make decisions only. A good captain will make decisions based on the recommendations of his crew and his own experience; delegating authority. A captain should give orders in a general manner, leaving the specific methods to the other officers.

For instance, a captain might tell the crew, "Bring her about, keeping our front shields to the enemy. Concentrate more power in the forward shields and fire photon torpedoes when the enemy is at close range." The captain wouldn't worry about where the power was specifically coming from; that's the engineer's job. He wouldn't worry about exactly how much power was put into forward and aft shields; that's the navigator's job, and so is moving the counter on the map. Neither would he worry about power for the photon torpedoes; that's the helmsman's job. The captain's job is coordinating these efforts to best advantage to neutralize an enemy vessel.

It is possible that a captain may be called on to make a saving roll on the STARSHIP COMBAT TACTICS / STRATEGY skill by the gamemaster. Sometimes, this procedure may be used to determine if a tactic is anticipated by the enemy vessel. Of course, it is the captain's score in this skill that determines which side gets combat initiative at the beginning of the combat.

## ENGINEER

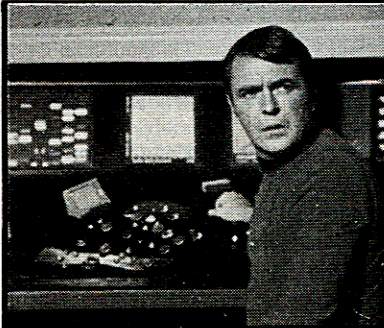

The engineering officer keeps track of how much power is available and where it goes. During the game, the only power consumption that must be dealt with is that used for battle. Power used to maintain current overall speed, life support, etc., need not concern us.

Power to run the ship comes from the matter/antimatter reaction in warp engines, and to a lesser extent, from the impulse engine generators. In the case of the Enterprise and her sister ships, the warp engine nacelles produce 20 points each of energy, and the impulse generators produce 4 points. (Total: 44 points). This is the amount of power available for use in one normal turn.

Power not used during a turn cannot be saved for use during a later turn. Also, damage to an engine or power loss due to engine stress may reduce the number of points an engine may produce.

The engineering console has power available tracks for engines on each ship, plus a total power available track. (Once you have experience using the chart, you may be able to tell at a single glance total power without adding it up and using the total power track. If so, you may quit using it). A cardboard counter is placed on each track at the maximum power level for that engine. This is placed on each track at the maximum power level as the engine takes damage or stress, then higher again as repairs are effected.

Each combat turn, the engineering officer may attempt a saving roll on % dice against his/her WARP DRIVE TECHNOLOGY skill level. If the roll is successful, the character has "nursed the engines along" and managed to pull one extra total point of power from them for that turn only. If the roll is 05 or less (no matter what the skill level), a two-point bonus is added for the turn. (Mr. Scott! Can you get us more power for the shields?" "I dinna know, Captain, but I'll gi'e it a try!") Once power available for the turn is determined, the engineering officer must channel it to the systems requiring it. For combat purposes, power may be directed for shields, weaponry, and tactical maneuver. The power allotted for these three areas must add up to no more than the total power available.

On many ships (including the Enterprise-type ships), it is possible to channel all power into shields. Doing so, however, leaves the ship unable to maneuver or fire weapons. Likewise, putting all power into weaponry leaves the ship stationary and vulnerable. Allocating power for maximum maneuverability leaves the ship without weapons or shields! Obviously, a compromise must be found, and the power allocation adjusted turn-by-turn as the needs of the captain and officers shift.

Using the Enterprise and her sister ships as an example, the shields track of the engineering console shows that all 44 available points (and on up to 46, if the engineer makes a good saving roll on WARP DRIVE TECHNOLOGY) could be diverted to the shields or to maneuver. The weaponry (in this case, photon torpedoes and phasers) section shows only 32 spaces, and this is the maximum power that can be placed in that area.

NOTE: In the case of maneuver, it takes 4 points of power (as allocated by the engineer) to produce one maneuver for the helmsman. Thus, the engineer should think in terms of groups of four when allocating power for maneuver.

The engineering officer should be guided by requests from the captain and other officers needing power when making allocations. Quite often, he/she will not be able to satisfy all requests completely, and so must try to compromise as best as possible. (Now you know why Scotty hits the Saurian Brandy so hard . . .)

Instead of making a saving roll to gain extra power for a turn, the engineering officer may instead roll on the STARSHIP ENGINEERING (GENERAL) skill level to reduce the amount of stress or damage that has been applied to an engine. On a successful roll, the engineer may move the counter on a damaged/overstressed engine back one step, bringing back one point of lost power from that engine. As before, a roll of 05 or less allows repair of two points of damage. Repairs are important, as when an engine drops to the "0" level, that engine is incapable of producing any power at all!

Instead of one of the other two saving rolls, the engineer may be asked to roll on the WARP DRIVE TECHNOLOGY skill to allow the helmsman to make an unusual change in overall speed. Overall speed is not on the engineer's console, but he makes this roll if it is needed and requested by the helmsman.

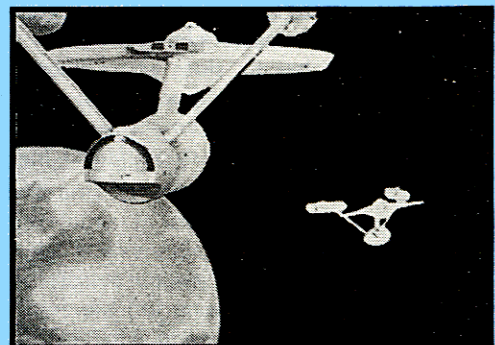



## NAVIGATOR

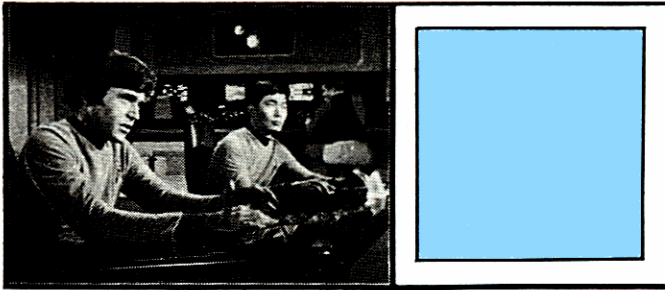

Most of the time, a navigator's major job is to plot a course between destinations for a starship. During combat, however, very little course plotting can be done. Therefore, the navigator's main responsibility in combat is operating the deflector screen.

There are six main deflector shield areas, each protecting one hex side of the hex containing the target ship. A navigator may power one, a few, or all these shields to any capacity up to their stated maximum, according to how many points were allocated for shields by the engineer and what direction the attack is likely to come from.

A skill level roll on DEFLECTOR SHIELD TECHNOLOGY may be made here by the navigator, with success granting him two extra points of shielding over and above the power allocated by the engineer. This does not represent an actual expenditure of more power, but rather the efficient use of the power by the navigator. These extra shield points can be put on any shield desired. They do not both have to be applied to the same shield.

Deflector shields prevent weapon hits from penetrating to damage a ship. If a weapon strikes on an unshielded side, or if a shield is not strong enough to deflect an attack, ship damage will result. It is important for a navigator to keep an unshielded or weakly shielded side away from enemy fire.

Shield energy may be divided among the six shield areas as desired by the navigator, as guided by the captain's orders. The Navigator receives 2 shield points for every 1 energy point received from the Engineer. If a ship suffers a hit, the number of damage points done by the weapon are subtracted from the amount on the shield that is struck. Move the counter on the appropriate track to show this.

If there is any question as to which hex side (and thus, which shield) has been struck, place a straight edge (ie., a ruler) between the center of the hex occupied by the ship firing to the center of the hex containing the target ship. The side of the target hex containing the straight edge determines the hex side and shield struck. If the edge passes through at exactly the joint between two hex sides, the captain of the target ship designates which side is struck. The Gamemaster shall be the final authority on any disputes.

If damage from a weapon hit exceeds shield capacity, the ship will be damaged (see Science Officer rules about damage). The navigator must inform the science officer when shield capacity is exceeded (that is, when shield strength is reduced to zero by a hit).

The navigator also controls the tractor/pressor beams. The effective range on these is 15 hexes. Power to these costs 1 point for every hex of range, plus whatever power is needed to overcome active resistance. A tractor

beam will draw an object to the ship, a pressor will push it away.

The size of the object being attracted/pushed away does not matter, as long as it is not much larger than the ship doing the attracting/pushing. However, if the ship being attracted/pushed has tractor/pressor beams of its own it may attempt to get away. For every point of power being used, it must match it similarly by either applying matching tractor/pressor force of its own, or by overcoming it with engine power, if possible. One point of maneuver is matched by four points of tractor/pressor power. Thus, if a 10-point tractor/pressor is focused on a ship, that ship may ignore it if it devotes 3 points of maneuver power to the purpose. If it cannot match it, it's drawn to the stronger ship at the rate of 1 hex per turn. A ship may use every point of power it is able to produce from its engines to get away. Therefore, you can see that these beams are not much use unless the vessel being attracted/ pushed is almost powerless.

## HELMSMAN

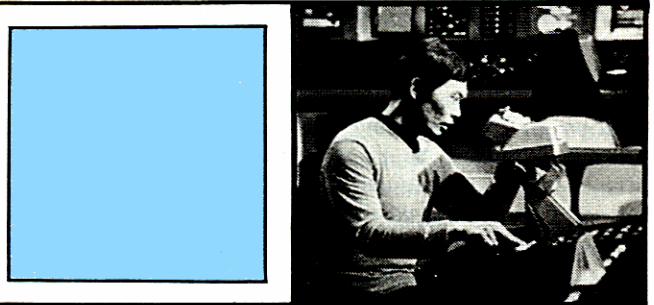

The helmsman is responsible for controlling ship maneuver and firing the ship's weaponry. As such, he is the officer with the longest section of rules to read and the most to do during a scenario. The helmsman is the officer responsible for actually moving the ship counter on the mapboard.

The helmsman's console first has a track for recording the current overall speed. (Sublight, warp 1, warp 2, etc.) Overall speed has nothing to do with the distance moved on the mapboard, but it has an effect on turning a ship during maneuver. Also, a ship may wish to change speed during a combat encounter to break off battle, or to follow an escaping ship. Note that the normal maximum safe speed for a Constitution class vessel is warp 6. Maximum emergency speed is warp 8. Emergency speed may be maintained only for 10 turns without placing stress on the superstructure and engines. For every turn speed is maintained over the max safe speed, 1 point of stress is applied to each engine and the superstructure.

Warp speed may be increased or decreased one step per combat turn. An enemy ship must match speeds to continue combat. If a helmsman desires a larger change in speed during one turn, he may ask the engineer to try for a saving roll on WARP DRIVE TECHNOLOGY skill. If the engineer's roll is successful, speed may be increased or decreased 2 steps that turn. (This maneuver is useful if a ship must flee, as the opposing ship will have to make a saving roll to follow).



Of course, a ship may travel no faster than it's stated maximum speed without risking damage. Top speeds and ship stress when they are exceeded is noted for each individual class of ship.

The next track is for keeping a record from turn to turn of maneuver points allotted. The engineer will inform the helmsman the number of power points allocated for the turn to maneuver. It takes 4 power points to provide one maneuver point on the helmsman's track. Thus, at the beginning of each turn the helmsman should move the counter on the maneuver points track to a number equal to  $\frac{1}{4}$  the power points allotted the the engineer to maneuver (rounded down). (If the engineer allots 12 power points, there are 3 maneuver points available. The engineer must allocate 16 power points to have 4 points of movement, etc.)

Maneuver is accomplished in phases. At the beginning of the combat turn, the captain with the highest STARSHIP COMBAT TACTICS / STRATEGY skill decides whether to take the first move himself, or give it to the enemy ship. (Settle ties with a quick roll of the dice each turn).

The helmsman of the ship moving first may then move the ship counter one hex on the board. The ship must move into the hex its front is pointing toward. Once moved, the counter may be rotated one hex-side in either direction to change facing, with no stress to the ship.

A ship may be turned two hex-sides, but it may suffer engine and/or superstructure damage from stress, depending on the overall speed of the ship. The turn stress chart may be different for different class ships. It is printed on the helmsman's console.

If stress damage is indicated, the engineer must move the counters on each warp engine's power available tracks to indicate the decrease in maximum power. (This damage can be repaired by the engineer later). Superstructure stress is kept track of by the science officer. Such damage cannot be decreased during combat; such repairs must be made after combat is over.

Turn stress can be decreased somewhat by a skilled helmsman. Once per turn, if stress damage is indicated on the chart, the helmsman may attempt a saving roll on the STARSHIP HELM OPERATIONS skill level. If successful, the damage is reduced one step. That is, the damage taken is as if the ship were moving one warp factor slower. For instance, a ship moving at warp 8 turns two hexsides in one phase. Each warp engine would ordinarily lose 2 points to stress and the superstructure lose 3 points. The helmsman, however, makes a successful saving roll. The damage is reduced to 1 point of engine stress per engine and 2 points of superstructure damage, as if the ship had only been moving at warp 7.

Instead of moving, a ship may simply be rotated one hex-side in place (or two, with stress damage taken) without moving at all. This action also uses up a maneuver point.

No matter what, a normal ship may not be turned more than two hexsides per turn. Movement of one hex and rotation, or rotation alone, costs one movement point. Move the counter on the movement points available and track one space to the left. When the available movement points reach zero, that ship can maneuver no more that turn.

Once the first ship is moved one hex, the opposing ship may move one hex in the same manner. (If there is more than one ship on a side, play alternates back and forth until one side is out of ships, then the remaining ships on the opposite side are moved for the first phase).

At any time, no matter who is maneuvering, a ship may decide to fire at an opposing ship. Maneuver stops at this point and fire is resolved. Several ships may fire at once, in which case the fire combat is resolved in the order it is declared.

Once all ships have moved for the phase, the next phase is begun, with the ships moving in the same order. These maneuver phases continue until a ship is out of maneuver points. That ship may then no longer maneuver (but it still may fire!) When all ships are out of maneuver points, the turn is ended.

A ship must use up all the maneuver points allocated at the beginnings of the turn in some fashion but exactly how they are used is up to the helmsman.

## FIRING WEAPONS

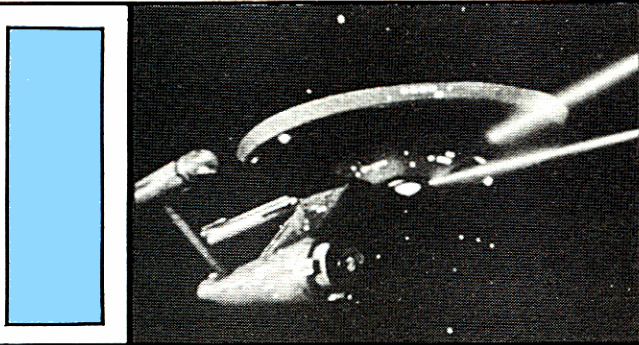

Some types of weapons, such as phaser and disruptor banks, must be charged with energy to fire. Each weapon of this type has a maximum charge capacity and may not fire more power in a given shot.

Federation photon torpedoes work differently, requiring only a small expenditure of energy (one point, in this case) to "arm" them. It is harder to hit with a launched torpedo than with a beam weapon, however.

The tracks on the helmsman's console show the type of weaponry on board and its charge levels. A counter is moved on each track to show the current status of each weapons system.

Unlike some other officers, the helmsman never arms or fires the weaponry without a direct order from the captain (or in his absence, the commanding officer present). Firing ship's weaponry is always a command-level decision. It is up to the helmsman to see to it that the power is there and ready when the captain needs the weapons.

The engineering officer will tell the helmsman how much power is available for weapons each turn, and this is allocated by the helmsman to whatever weapons the captain wishes to arm. The weapons are armed at the beginning of the turn. As they are fired, their tracks should be revised to "unarmed" status. Thus, each weapon can be fired only once during a combat turn.

Each weapon on board a ship has a firing arc. This arc specifies in what direction (relative to the ship's facing)



the weapon can be fired. The firing arc of a weapon depends on the type of weapon and where it is mounted, and may vary from ship to ship.

There are four possible firing arcs for normal ship weaponry; forward, port, starboard, and aft. A single weapon (or "bank" of more than one weapon installed together) may be specified on the helmsman's console as facing any of these arcs (possibly more than one). Thus, it can fire at an enemy only if the enemy falls within its arc of fire.

Arcs of fire for forward, port, starboard, and aft mounted weapons are shown on the accompanying chart below.

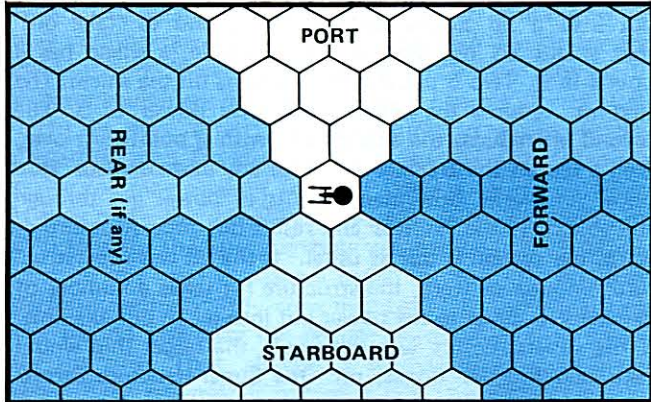

It is possible to fire different weapons at different targets in the same turn, but a set of weapons designated as a "bank" must have only one target designated for the turn. For instance, the Enterprise has a starboard phaser bank consisting of two weapons. Either or both may be fired, but if both are used in one phase, both must fire at the same target. This is because weapons in banks are all operated by the same fire control systems.

Note that because of restrictions in firing arcs, it is very important to place your limited power in weapons which face the enemy. It is the helmsman's job to anticipate enemy movement and have the proper weapons ready when the fire order is given.

A photon torpedo, or other projectile weapon, must be armed to be fired. To determine whether or not a hit is scored, the helmsman must 1) figure the range to the target, and 2) make a successful "to hit" roll. If a hit is scored, the target ship must determine what type of damage (if any) is done by the torpedo.

To figure range to target, count the hexes from the firing ship to the target by the shortest possible path. (Count the target's hex but not the hex the firing ship is in). Then consult the torpedo/projectile firing chart on the helmsman's console. Next to the range listing will be the "to hit" score. This number or less must be rolled on one 10-sided die to score a hit. The helmsman then rolls to determine a hit or miss.

For example, imagine the Enterprise is in combat with a Klingon battlecruiser. The two ships are 5 hexes apart when the order to fire photon torpedoes is given. Consulting the helmsman's console for the Enterprise, we see that a torpedo shot at a range of 5 hexes is a hit on a roll of 8 or less. The helmsman rolls a 4 — a hit!

If a ship has more than one projectile weapon (the Enterprise, for instance, has two photon torpedo tubes), both may be fired simultaneously. However, the roll

"to hit" must be made separately for each projectile.

When firing, the "to hit" roll may be modified by a saving throw on the helmsman's SHIP'S WEAPONRY TECHNOLOGY skill. If the saving throw is successful, the "to hit" number is increased by one. That is, if a successful saving throw is made, a helmsman who would have required a "to hit" roll of 8 or less, now hits on a nine or less! The navigator can try for this roll every time a shot is fired.

Some projectile weapons (photon torpedoes included) may be laid as mines. To lay mines, photon torpedoes are "fired" at empty hexes. No "to hit" roll is necessary; they always land in the hex for which they were intended. A counter is placed in the hex to mark the spot. Later, if a ship enters that hex, the mine explodes. These mines may be destroyed at any time by the ship that launched them, and more than one may be placed in a hex. Such mines are not sure hits, since ships may detect and dodge them at the last minute. Therefore, when encountering a mine, the target ship rolls a 10-sided die. On a roll of 5 or less, a hit is scored. Otherwise, no damage is taken.

To employ mines in a situation, use inverted unused counters. Use 3 'dummy' counters to every 1 actual mine. The player places these on the mapboard, writing down the hex numbers for the hexes the real mines are in. When a player enters a hex with a 'dummy' counter, the counter is removed with no damage effect, of course. When a ship enters a hex with a real mine, roll for hit, then remove the counter from play. A mine only explodes once. If a hit is scored, consult the torpedo/projectile table again for damage. Most projectile weapons do the same amount of damage regardless of range. Report such damage to the person operating the enemy ship, so the effects on shields and other systems can be evaluated.

Firing beam-type weapons (like phasers or disruptors) is a similar procedure. Such weapons, however, may have a varying amount of power devoted to their use. The amount of power devoted to a beam weapon will not affect the weapon's range, but will affect the amount of damage the weapon causes. A weapon must have at least one point of power allocated to be fired at all!

Beam-type weapons are usually more accurate at longer ranges than projectiles, but their damaging power is reduced at long range. Figure the range to the target as with a projectile and compare to the appropriate beam weapon firing chart to find the "to hit" chances as before. Technology skill may allow an increase in the "to hit" chances as before.

Once a hit is scored, compare the range of the shot on the beam weapon firing chart to determine the "damage +" done by that weapon at that range. This number is added to the number of points of power allocated to that weapon for the turn to determine the points of damage suffered by the enemy ship.

When firing more than one beam weapon designated as a bank, only one "to hit" roll is made. If successful, the power of all weapons fired in that bank (plus the damage + for each weapon) is taken as damage by the enemy.

Once a weapon (beam or projectile) is fired, the counter for that weapon is returned to the "unarmed" box. At the end of the turn, all weapons become "unarmed", whether fired or not. Thus, one cannot carry



over power put into unused weapons from one turn to the next.

If weapons are designated as damaged by incoming fire, the science officer will indicate this. The helmsman then places the counter for that weapon on "damaged". Such a weapon cannot have power put into it, or be fired, until repaired. Such repairs must ordinarily be done after the combat situation is over.

#### SCIENCE OFFICER



The science officer's main job during battle is the gathering and processing of information. Through scanners/sensors the science officer keeps track of the status of the enemy ship(s) and, through internal sensors and reports, of damage to her/his ship.

Extensive charts are not needed for this. The science officer's console has a track for recording the status of external ship sensors/scanners. These sensors are the only method to obtain information not obtainable by other means. Visual contact can still be maintained. Sensors do affect weaponry (see Helmsman). Usually, the counter should be on the "operational" space. If the sensors are damaged in battle, move the counter to the "damaged 1" or "damaged 2" space. The number refers to the number of turns sensors are out due to hits.

To use ship's sensors to discover information about another ship, a sensor lock must be obtained. This is attempted at the beginning of the turn before movement begins. The science officer should indicate the target ship, then make a successful saving roll (on % dice) on the ship's sensors skill. If successful, a sensor lock is obtained (move the counter to the "locked" position) and information can be obtained about the target ship.

Once a lock is accomplished, the Gamemaster (or enemy player, if there is one) must give the science officer the following information: 1) type and/or size of ship or object, if known by Federation; 2) life forms present and status (alive, how many, type); 3) whether or not defensive shields, if any are up; 4) composition of objects (steel, energy, unknown, etc.); 5) status of composition (fluctuating, solid, gaseous, etc.)

As the situation develops, players may want or need further information through these readings. The following are a few suggestions. Feel free to add as you see fit. 1) approximate damage to shields (down, up but weak, up full); 2) damage done to vessel (port warp engine destroyed, superstructure severely damaged); 3) status of life forms (approximate number of casualties); 4) changes in structure; 5) any transporters activated; 6) energy fluctuations

(equipment requiring large amounts of energy (weapons, etc. activated or fluctuations due to damage; approximate number of energy points available).

Only one ship may be "locked in" at a time. A lock remains until 1) the target ship scores a hit on the ship with sensor lock (whether or not the sensors are knocked out or 2) the science officer tries for another lock on a different ship.

Whenever damage to the ship is taken in battle, it is the responsibility of the science officer to determine what form the damage has taken. Points of damage are first taken from the appropriate deflector shield by the navigator. Each hit accumulates on the shield hit. Extra points put into a hit above the number needed to 'take out' that shield are not wasted. For example, a shield has 8 points in it. Two 5 point disruptor bolts hit the shield. The first hit reduces the shield's defensive power to 3. The second hit reduces the shield to 0, with 2 points left over. Roll a die on the Damage Table for any extra damage. Roll once, no matter how many points of power got through the shield. If the hit was any result but superstructure or warp, the system is out as usual. If the hit was superstructure, impulse or warp, the structure hit takes a number of damage hits equal to the power put into it. In our example, if the superstructure was the result, the target ship would take two hits, or boxes, on the Super-structure Stress/Damage track. Remember, the Klingons do not know how many points of shielding you have up.

If damage beyond the shield capacity is suffered, one roll on the damage chart must be made for each hit by a different weapon. In other words, each hit by a separate disruptor would require a separate roll on the damage table for the direction the hit came from. For each result (each hit) on superstructure, warp, or impulse the item hit receives a number of damage points (boxes on the appropriate track) equal to the power put into them. If a 5 point hit was on the warp engines, the marker on the warp track would be moved 5 boxes. If the hit result was any result other than warp, superstructure, or impulse, the system hit is damaged as usual. A 5 point hit on phasers does not knock out 5 phasers, just one.

Apply the results of the die rolls as follows:

**SENSORS OUT** — No sensor information obtained for 1 or 2 turns. (Roll a D10. 1-5 sensors are out 1 turn. 6-10 sensors are out 2 turns). Sensor lock is lost and must be regained with a saving roll.

**SHIELD GENERATOR DAMAGED** — The noted shield is no longer functional, and no shields can be maintained on that hex side for the duration of the scenario.

**WEAPON (phaser, torpedo tube, etc.) DAMAGED** - The named individual weapon no longer operates for the duration of the situation.

**SUPERSTRUCTURE HIT** — The science officer records the noted number of hits on the superstructure track. This does not necessarily represent the ship falling apart. What it does represent is systems damaged, hull damage, internal structure damage, electric conduit damage, etc. Basically, super damage represents portions of the vessel rendered unusable in the time scope of the situation.



**CASUALTIES** – The number given in parentheses after other damage is the number of casualties taken in the hit. Casualties are not necessarily deaths. Most often they are crew members injured or shook up enough that they can no longer function in the current situation without medical attention. (See Communications Officer section for further details on effects and recoding casualties taken).

**BRIDGE PERSONNEL OUT** – Bridge personnel are shaken about, making it possible for them to be unable to perform duties for the current turn. All bridge personnel must attempt a standard saving roll on their DEX attribute with a +20 die roll modifier to the attempt. Those who fail may not operate any equipment on their panels for the current turn. Those who make the roll may attempt to operate equipment controlled on their console at a +2 to all 1D10 die rolls. (They are still required to record damage, casualties, etc.) On the next turn, anyone who failed the saving roll may attempt another, with no die roll modifier. If they make the roll, they have a +20 on % rolls and +2 on D10 rolls for the turn. All those who passed in the previous turn do not need to make a saving roll this turn and may perform normally. Any crew members required to perform this second save may not change anything on their panels for the turn. Thus, all energy allocation will remain the same if the engineer is out of action, no weapons can be fired if the helmsman is out of action, etc.

**WARP ENGINE HIT** – The noted engine has its power available reduced by one on the engineer's console. (Such damage may be repaired later by the engineer). Warp damage does not necessarily mean structural damage. Warp engine hit includes circuits shorting out (therefore, possible repairs - see Engineer), electrical conduits broken, temporary outages of power, etc.

**IMPULSE ENGINE HIT** – As above, but for the impulse engines.

The science officer keeps track of the damage to the ship's superstructure on a track on the sciences console. The counter starts at zero and is moved ahead to reflect superstructure damage. If the counter reaches the last space (variable, according to type of ship), the ship's structure is irreparably damaged and the ship is no longer space-worthy. It is not destroyed – the crew may still escape by transporter or shuttles – but the ship cannot move or fire. It is, in effect, totally disabled.

**NOTE:**

Repairs after the scenario can be effected. Rarely during a situation will an Engineer be able to repair more than a few points of damage. The engineer will be busy trying to get more power out of the engines he has left, or more speed for the helmsman. Repairs to all damage take place at a rate of 1 superstructure point, 1 engine point, 1 shield, or 1 weapon repaired at a time. If a superstructure or engine suffers 50% or over damage, repairs must be effected at a Star Base. The rate of repair is one point per hour.

**COMMUNICATIONS OFFICER**

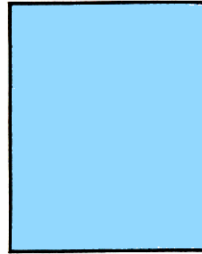

The communications officer keeps track of crew casualties. Casualties include any crew members too badly hurt during battle to continue to perform their duties.

There are three tracks for keeping count of crew casualties, one each for ones, tens, and hundreds. The total of the three tracks is the number of crewmen out of action.

Casualties cause loss of ship efficiency. Rather than keep track of personnel losses in individual departments (engineering, fire control, etc.) the communications officer keeps track of casualties on these tracks for the whole ship.

The reduction in efficiency due to crew loss is kept track of abstractly. For every 10% reduction in crew (every 43 crewmen on the Enterprise) all die rolls, except for individual's skill rolls, are modified by a +1 on the die roll. Die rolls affected are: 1) turn stress rolls and 2) weapons rolls. These modifications represent the loss of crewmen in these departments. Sulu may push the button, but someone has to be 'down there' keeping the equipment working during combat.

In addition, the communications officer controls all internal and external communication. There are no tracks on the communications console for this function, but it is an important one nevertheless. The communications officer may be called upon to hail an unidentified ship, call for the surrender of an enemy vessel, send a message to Star Fleet, etc.

Usually, the operation of a normal communications functions do not require saving rolls. However, the game-master has the option of asking the communications officer to make a saving roll on the Starship Communications Procedures skill level whenever an unusual or difficult communications task must be performed. Examples of such would be completing communication through atmospheric disturbances of enemy jamming, intercepting and decoding enemy transmissions, translating unknown languages, using the ship's computers, etc.

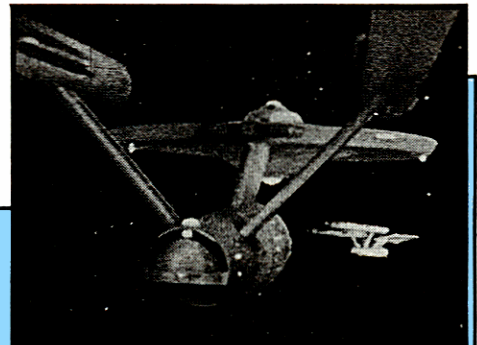

## EVASIVE MANEUVERS

A helmsman may take emergency evasive maneuvers to dodge an incoming missile (such as a photon torpedo). Beam weapons such as phasers, disruptor bolts, and plasma weapons cannot be dodged in this manner.

To attempt emergency evasive action, the captain must order such a maneuver immediately upon the enemy's announcement of firing. (A captain may place a standing order for such a maneuver at the beginning of the engagement, in which case it is up to the helmsmen to declare the action).

Evasion must be declared to either port (left) or starboard (right). The counter of the evading ship is immediately turned one hexside in that direction, but is not moved from its current hex. It must start further movement from this position, regardless of the results of evasion.

The helmsman then must attempt a saving roll against the Starship Helm Operations skill. If the roll is successful, the torpedo impacts against a different shield (the one now toward the firing ship), and does only ½ normal damage to shields and systems. If the roll fails, the torpedo or other missile has still hit the shield it originally would have struck, and does full normal damage.

A ship that has performed an evasive maneuver (successful or not), cannot fire any weapons during the current turn phase. If that ship has already had its opportunity to fire during that turn phase (whether it did so or not . . .), it may not fire during the next phase of opportunity.

The evasive maneuver can be attempted even if the ship in question has no movement points remaining during the turn. This is an exception to the normal course of the game. Gamemasters are warned not to allow this to be misused by heading for next turn. To discourage this practice, one point of stress damage to superstructure is taken every time an evasive maneuver is attempted.

## REVERSE

Starships can travel in reverse; the maximum allowance is 2 hexes per turn. If the ship did not move during the preceeding turn, there is no penalty for the change in direction. If the ship moved during the last turn, there is an automatic point of superstructure damage suffered and the helmsman must make a saving roll to avoid further superstructure damage. The helmsman must make the saving roll against his Starship Helm Operations stat with the following modification: +10 for every point moved during the preceeding turn. For example, if the Enterprise wished to make this direction change and moved 4 hexes during the preceeding turn, Sulu must roll an 89 with 40 added to the die roll.

If the saving roll is failed, additional superstructure damage points equal to the number of hexes moved during the preceeding turn are suffered. If Sulu misses the roll, the Enterprise will suffer the 1 automatic damage point and 4 additional points of damage to the ship's superstructure.

If the maneuver is attempted during the middle of a turn, the movement plotted for the current turn is used to figure the saving roll modification and additional damage.

The reverse maneuver can also be used to evade incoming photon torpedo or plasma bolt fire. The normal procedure is followed and if the saving roll is successful, only half of the normal damage is applied. Any automatic superstructure damage points are still applied.

If the saving roll is issued, full combat damage and any other penalty superstructure damage points are applied and normal movement is continued.

All of the reverse maneuver rules apply when changing from reverse to forward movement.

## STARSHIP EXPLOSIONS

There are times during starship combat when a ship will explode. This can be the result of continuous incoming fire or a simple declaration of self-destruction. The explosion is accomplished by a mixing of matter and anti-matter, which is intentional in self-destruction. When a ship faces a barrage of incoming enemy fire that causes its superstructure point total to drop below zero, it must make a saving roll on 1D10 greater than or equal to the number of points below zero. For example, if a ship suffered a number of points damage that caused its superstructure total to drop to -5, the ship's engineer would have to roll 5 or greater on 1D10 to prevent destruction. This roll is only made during the phase when the superstructure point total drops below 0. It is assumed that action can be taken to prevent the explosion in one phase.

The mixing of matter and anti-matter results in a very violent explosion. Ships that are close to such an explosion will take damage according to the following rules:

Range	Amount of Damage
1 hex	full amount of all remaining engine points
2 hexes	1/2 of all remaining engine points
3 hexes	1/4 of all remaining engine points
4 hexes	1/8 of all remaining engine points
5 hexes	1/16 of all remaining engine points
6 hexes	1/32 of all remaining engine points
7-10 hexes	1 point of damage

A ship within 10 hexes will always suffer at least one point of damage no matter how big or small the explosion was. The number of remaining engine points is calculated after all fire combat is completed for that phase and includes any and all warp and impulse points.

Ships may not fire through other ships, planets, or other obstacles big enough to be placed on the map during starship combat.



## GAMEMASTER

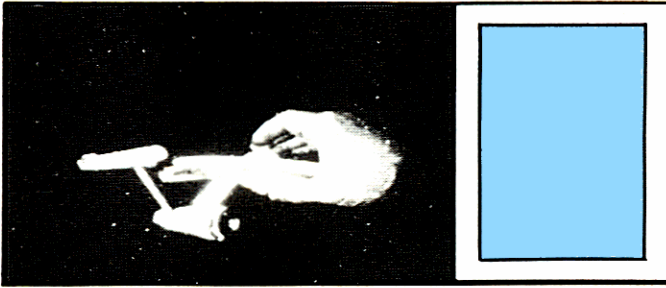

The gamemaster will often be called upon during a campaign to "role play" the opposing ships in a battle. It would be cumbersome to do so using the complete role-playing combat system outlined in the previous sections, especially if there is more than one enemy ship. For this reason, a simplified ship control system has been developed.

The simplified system is not intended for use by players to operate ships crewed by player characters, as the system — somewhat intentionally — limits the options more than the full system with multiple consoles. It may be possible that players will at some time wish to use the simplified system to battle. By the same token, if there is only one enemy ship involved in a battle (perhaps crewed by important non-player enemy characters) the gamemaster may wish to use the full system for the enemy as well.

Also, the full role-playing ship combat system makes a fine competitive game for two teams, each trying to defeat the other. Each ship type in this game (and in future expansions from FASA) has the gamemaster console. Some of the ships included also have the full set of charts (as does the Klingon D7).

In explaining the gamemaster-controlled "quick system", the gamemaster console for the Klingon D7 Battlecruiser will be used as reference, much as the Enterprise was often used as reference for the full role-playing rules. Other ships will vary slightly in weaponry and capabilities, but the basic rule system will apply to those as well, with rule variations noted with the ship descriptions. In reading these rules, it is best to keep the Klingon D7 Battlecruiser gamemaster console at hand for reference.

The Action Table on the gamemaster console replaces the system of energy allocation in the full system. This table presents various allocation options, some concentrating on maneuverability, some concentrating ship's power in shields and weaponry, others finding a middle ground. At the beginning of each turn, one option is chosen for a ship and the Action Counter is placed beside it. This shows which systems have power for that turn.

The Klingon D7, for example, has ten possible power allocation options. If it chooses to devote power solely to movement, it may move 9 or 10 hexes during the turn, but may not have any deflector screens or use any weapons. Other options allow less movement, but allow 1, 2, 3, or even 4 screens to be raised. Some of these other options allow some screens and some weapons to be active, others allow only screens or weapons but not both.

Thus, the gamemaster-operated ship must allocate resources like the player-controlled ship, but not in the same way. When an option is chosen, it means only that

power is available for such action. A ship must move at least the minimum number of movement hexes listed under its action choice, but weapons listed as available need not be fired, nor shields listed be raised if the player does not wish to use them.

A gamemaster (or non-player) controlled ship will not likely have a full set of bridge crewmen characters generated, nor even skill levels for individual crewmen noted. For this reason, the quick system requires only two skill ratings. A STARSHIP COMBAT TACTICS/STRATEGY skill level should be determined for the ship's captain. This rating is compared with the enemy captain's rating to decide combat initiative, as in the full system. Also, a CREW EFFICIENCY RATING should be noted for the non-player ship.

The crew efficiency rating is treated like a skill level, and can range from zero to 99 in the same manner. It is usually specified as part of a scenario, or determined by the gamemaster. (In the case of a chance encounter not prepared in advance by a gamemaster, % dice can be rolled to determine the crew efficiency rating for a ship.) A saving throw on the crew efficiency rating is made wherever a skill roll for an individual crew position would have been made in the full system.

The TURN CHART on the quick system console works just like the turn chart for the full system consoles. Maneuver, requiring a turn of one hex side per phase (that is, per hex of movement) can be made with no strain. A two-hex side turn may put stress on the engines and superstructure at high speeds.

If such a turn is made, stress damage is taken according to the overall speed of the ship (sublight, warp 1, warp 2, and so forth). These are recorded on the appropriate tracks. Once per turn, a saving throw on the crew efficiency rating may be attempted. If successful, the stress damage done by the turn is reduced one step, to the amount of damage that would have been done had the ship been moving at a speed one warp factor lower.

There is a track for keeping count of SUPERSTRUCTURE STRESS/DAMAGE, just as in the full system. It works the same - if a ship reaches the highest number on its track, it is hopelessly crippled and cannot move or fight.

The multiple tracks for ENGINE STRESS/DAMAGE and power in the full system have been combined into one track for the quick system. The counter on this track starts at the highest number (40, in the case of the Klingon D7), and is reduced as damage is taken from stress or weapon hits. Alongside the track are notations for various weapons, shields, and maximum speeds. Whenever the counter is moved down alongside one of these notations, the ship's capabilities are reduced accordingly, for lack of power.

For instance, on the Klingon D7, if the engine stress/damage track is reduced below 35, the ship's maximum speed is reduced to 8 hexes/turn. If further reduced below 34, one disruptor is considered inoperative due to lack of power. Thus, if the Klingon captain chose the full movement option this turn, he could move only 8 hexes even though the option allows him to move 10. Similarly, if he had chosen a low movement option that allowed him to fire all 4 disruptor banks, he would have been able to use only three, as he hasn't enough power for the fourth.



When systems like shields and weapons are inoperative due to power loss or use of the system, note this by placing a no power marker on the appropriate damage chart on the console. NOTE: These systems are not damaged! If power is restored to them they will work! For this reason, separate track must be kept of systems out due to power loss and systems out due to damage. These can overlap, as well. (A wise captain who is forced to power down one system will power down one already damaged anyway, if he has one!)

Once per turn, a saving throw may be attempted on the crew efficiency rating. If successful, the ship regains one point of engine/stress damage or one point of superstructure stress/damage as chosen by the person operating that ship. If reducing the amount of engine stress/damage raises the counter on the track above the level at which a system was powered down, that system may be powered up again.

Unlike the full system, in this system a deflector shield is either up or down. If it is up, it has its full protective power, which is noted on the ship statistics and on the full-system console for the navigator. The number of shields that can be up during a turn is determined by the option chosen. It is up to the person operating the ship to decide which shields will be raised, if any. These are indicated by placing a shield marker in the appropriate hex of the DEFLECTORS RAISED display on the console. Remember that a damaged or powered down deflector shield cannot be raised.

If a hit is taken on a shield (determined just as it is in the full system), the shield will absorb it if it does less damage points than the shield's rating. All damage done to the shield during the turn is cumulative for purposes of punching through that shield's protection. For each hit by a weapon once the shield is down, roll for damage as in the full system.

There is only one damage chart for the quick system, used no matter what side was attacked. Superstructure hits are noted on the appropriate track, as are engine hits. Note that on each gamemaster panel there is a note that states Impulse – No. Boxes. This is how many of the spaces on the engine track are impulse engines. If a hit is scored on impulse, this is the maximum number of spaces that can be marked off. If the chart indicates a shield is knocked out, place a DAMAGED counter on the shield struck on the deflector damage chart. If that deflector is already damaged, no further deflector damage is taken.

If a weapon is damaged, place a DAMAGE counter on one of the noted weapons, if the ship still has one that is undamaged. If all the appropriate weapons are damaged already, no further damage can be done. NOTE: Firing arcs are used to determine if a shot can be fired. However, which weapons are damaged is not kept track of. Therefore, which weapon is fired is not important, as long as the target is within the arc of any similar weapons.

Weapons charts are also on the quick system console, with range and to hit roll determined in the same manner as in the full system. In the quick system console, with range and to hit however, weapons are always fired at full strength. Instead of a "damage +" column, the third column on the weapons table will show the total damage delivered by each weapon of the listed type fired.

The "to hit" roll must be made for each separate weapon fired. Once the number of hits are established, however, the damage for those hits is totalled and applied to the enemy shields and ship as in the full system.

Note that the quick system has advantages and disadvantages in comparison to the full system. The full system provides the maximum in role-playing enjoyment and combat flexibility, but it would be inconvenient for a gamemaster to use this system (all consoles for the enemy run by the gamemaster) for every random encounter, or to use it for mass battles.

The quick system does not allow for as much variation in battle strategy as the full system. To some extent, this is good. We couldn't have the Enterprise being blown out of space every adventure, could we? The lack of variation is made up for, to some extent, by a bit more freedom. Not keeping track of which weapons on which side were knocked out, for example.

Overall, gamemasters are encouraged to use the full system for encounters with ships run by important non-player characters. Every crew should have at least one or two recurring villains who are as skilled and as resourceful as they. It keeps things interesting. The quick system should be used for random encounters, multi-ship battles and short engagements.

Also remember that the job of the gamemaster is not to frustrate the players at every turn or destroy them in battle. Ship combat should be challenging for the players, but not suicidal. The gamemaster is, in effect, "writing" an "episode" of STAR TREK in every game. It would be a poor episode if the Enterprise were blown up in the first five minutes! Be reasonable, even lenient, when necessary, to keep the players interested but not frustrated.

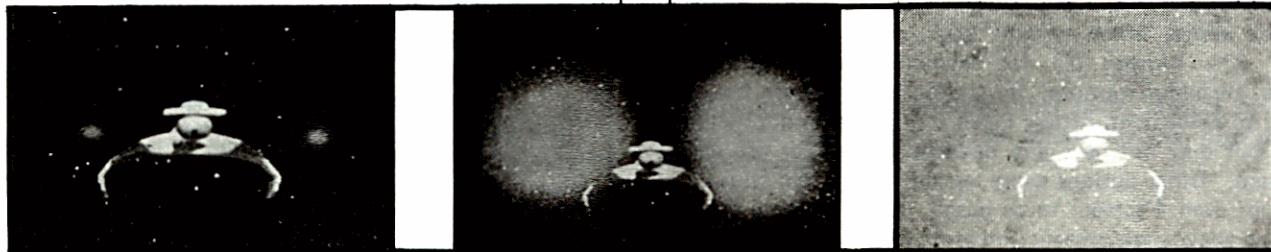



## SHIP COMBAT SAVING ROLL TABLE

Below is a list of all skill rolls normally used in ship combat. Four things are given: 1) Officer the roll is made by, 2) Name of the skill used, 3) When the roll can be made, and 4) the result of a successful roll.

### CAPTAIN

1) STARSHIP COMBAT STRATEGY/TACTICS, beginning of turn, no roll is made but skill is compared to opponent's skill.

### ENGINEER

Only one roll may be made per turn.

1) WARP DRIVE TECHNOLOGY, made at the beginning of the turn, success gains 1 extra point of power to be applied to total power available track (2 points if roll is 01-05).

2) STARSHIP ENGINEERING (GENERAL), made at the beginning of the turn, success reduces stress on one engine by one step (2 points on one engine or 1 point on each of two engines if the roll is 01-05).

3) WARP DRIVE TECHNOLOGY, made at the beginning of the turn, success allows helm to change overall warp speed by 2 steps instead of 1.

### NAVIGATOR

1) DEFLECTOR SHIELD TECHNOLOGY, made at the beginning of the turn, success gains 2 more points of shielding to be used anywhere.

### HELMSMAN

1) STARSHIP HELM OPERATION, made any time needed, success decreases all types of stress damage by 1.

2) SHIP'S WEAPONRY TECHNOLOGY, made when firing — may roll twice per turn, success gains a -1 on 'to hit' rolls of weaponry.

### SCIENCE OFFICER

1) SHIP'S SENSOR SKILL, made at the beginning of the turn, success gains sensor lock.

### COMMUNICATIONS OFFICER

1) STARSHIP COMMUNICATIONS PROCEDURES, may be made anytime, allows difficult tasks to be performed.

The gamemaster may roll on his ship's crew efficiency rating once per turn on any one of the skill rolls listed below.

- 1) Superstructure stress
- 2) Engine stress
- 3) Turn stress table
- 4) Speed change

## SHIP COMBAT SEQUENCE TABLE

The following is the sequence of events used in combat:

- 1) Determine which side has the tactical advantage (Compare captain's skill).
- 2) Decide which side is to move first. (Winner of No. 1 to decide).
- 3) Side moving first moves if movement plotted.
- 4) Opposing side moves.
- 5) Play rotates among all sides, more than two. When all ships have exhausted possible movement, a new turn is begun.

The following is the sequence taken at the start of a ship's turn:

- 1) Power available is determined by the engineer.
- 2) Any skill rolls to be made at the beginning of the turn are made.
- 3) Power is channeled as needed — to shields, maneuver, etc.
- 4) Power usage and weapon usage is kept track of during the turn.

The following is the sequence taken when firing at another ship:

- 1) Captain orders ready weapon fired. Weapon then marked unarmed.
- 2) Helmsman determines range.
- 3) Helmsman makes "to hit" roll with any applicable modifiers.
- 4) If a hit is achieved, determine damage.
- 5) Damage applied to opposing ship.
- 6) Sequence reverts to normal play.

If your vessel is hit during combat, use the sequence below:

- 1) Determine hexside hit.
- 2) Determine if shields hold.
- 3) If not, determine how many points of damage or what system was damaged.
- 4) Apply damage results.

## ROLE-PLAYING AND FEDERATION POLICY

If players are not guided by the philosophy and fictional background of STAR TREK, there is a danger that ship encounters will become bloody shoot-'em ups. Weaponry in STAR TREK's time is terribly devastating. One ship can level a planetary city in moments. A ship of the Constitution class carries enough firepower to destroy a planet. Such energies must not be used lightly!

The major element of play balance in ship combat scenarios is the Federation's reluctance to use deadly force. Federation star craft captains are trained to attempt to avoid combat situations through diplomacy and tactical bluff if possible. Federation representatives never fire first, and will usually allow an enemy vessel to break off battle, unless allowing the enemy to escape would jeopardize Federation security.

Even the Klingons and Romulans do not fight when there is nothing to be gained by fighting. Klingon captains tend to be trigger-happy, but only because winning victories is the only way they can advance in rank and status. Romulans are battle veterans, but function as disciplined military strategists, not beserk killers.

The drama and excitement of ship combat is heightened when the reasons for conflict are reasonable and when combat is only joined after the captain involved has tried every other reasonable method of solving the problem. Starship captains are not afraid of battle; they are simply mature, experienced beings who realize that violent action—while not always avoidable — is the last resort in galactic interaction.

When the game becomes a "Klingon hunt", the charm and message of STAR TREK goes out the window — and so does play balance. A Constitution class starship (all other factors equal) is capable of annihilating a Klingon D7 Battlecruiser, especially if the Klingon ship is played using the quick system. But the Federation vessel is constrained by the fact the the Federation is never an aggressor!

Ship combat is an important part of the game, and can be a good game in itself. But as part of a role-playing campaign, it must not be allowed to totally dominate the action. A gamemaster must insist that Federation officers behave like Federation officers and not like warmongers.

## SHIP COMBAT EXAMPLE

For our example of how the ship combat system works, let's use a Constitution class ship and a Gorn cruiser that has attacked it. Starting positions are marked on the map below as C1 for the Constitution class vessel and G1 for the Gorn cruiser. Lay out the full Constitution class panels and the gamemaster Gorn panel. Use markers to follow the example.

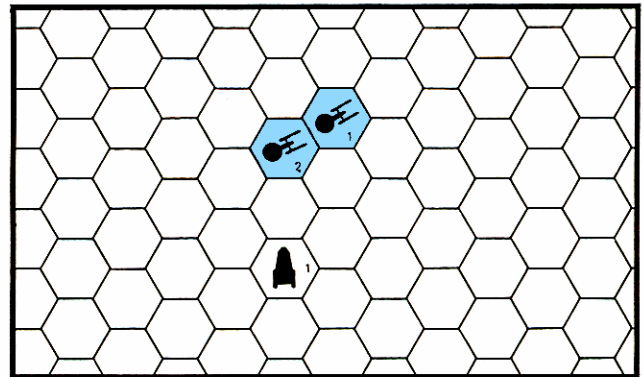

Let's assume that the ships have fired on each other previously, but with no damage to either (the shields held). All power is available to either vessel. C1's captain has a Strat/Tac skill of 64 and G1's skill level is 52. The Gorn crew has an efficiency rating of 49, just below average. Full panels are being used by the Federation players and the simple system is in use by the gamemaster.

The engineer has failed his roll to gain extra power for the engines, so C1 has 44 points of power available to use. 8 points are used for maneuver, yielding 2 movement points. 19 points are put into shields, and the other 17 are used for offensive weaponry.

The helmsman puts a marker on the "2" space on the movement points available track.

Of the 19 shield points, 9 are put into the forward shield and the other 10 into the port-fwd shield, as these two sides are toward the Gorn. These are marked on the appropriate tracks. Let's hope the Gorn doesn't move to get a clear shot at an unshielded side.

Two of the 17 weaponry points are used to arm the torpedoes. Ten are used to fully arm the fwd phasers, with the last 5 points going into the No. 1 port phaser. These are marked on the tracks on the helm panel.

The gamemaster chooses the 4th option. This allows him to move 3, 4, or 5 hexes. He marks the forward shield as up. He also will be able to fire one blaster.

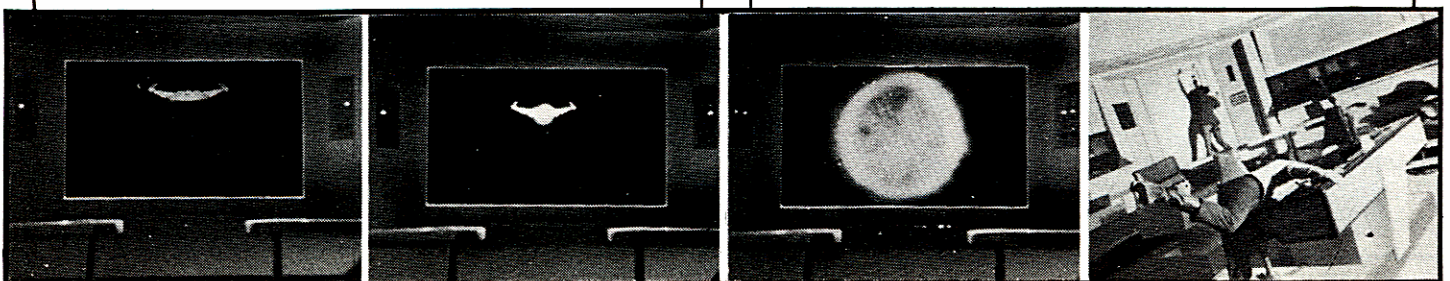



C1 has the option of moving first, and does so. It moves straight one hex. The helmsman moves the marker on the movement points track from 2 to 1.

The captain orders torpedoes fired. The markers are moved from the arm to the unarm space on the torpedo tracks. The range is 2 hexes. The "to hit" is 1-10; automatic, so both hit. The helmsman did not need to use his skill roll to gain a modifier. Torpedoes have ten points of power in them.

As you can see, the shot will hit the forward shield of the Gorn cruiser. Luckily for him, that's the shield he has up. Looking on the Gorn panel, we see that an 'up' deflector has 10 points of power in it. The first torpedo takes out the shield (10-10=0). The second torpedo therefore hits for full effect. The gamemaster rolls a 10-sided die to determine where the torpedo hit. He rolls a 10, an impulse hit. Note on the bottom of the gamemaster sheet it states "Impulse - 4 boxes". This is how many hits it takes to render the impulse engine useless on the Gorn cruiser. It took ten hits, but only has 4 boxes to lose. Therefore, the other 6 points in the attack are lost. The gamemaster moves the ENGINE STRESS/DAMAGE counter down 4 boxes from 40 to 36. He now has only 36 points of power available. He can now move only 6 hexes maximum.

Before the C1 captain can order phasers fired, the gamemaster announces he is firing his blaster at the Constitution class ship. At the range of 2 hexes the blaster is listed as having a "to hit" of 1-10, an automatic hit. Seven points go into the C1's port-fwd shield. Fortunately, there are 10 points in this shield, so all 7 points from the blaster are absorbed. The Gorn ship only had one shot, but does not let the Federation crew know this. He merely states that he has no further weapons he wishes to fire at the present time.

The C1 captain decides to go ahead and fire the phasers since the shield was knocked down by the torpedo attack. All three armed phasers are capable of firing on the Gorn. He first orders the No. 1 fwd phaser fired. At a range of 2, the hit is automatic, so again the helmsman does not need to make a skill roll for a + modifier. At a range of 2, there is a damage of + 3. There were 5 points of power put into this phaser, so it now has 8 points of attack power. A 10-sided die is rolled. A 2 is rolled, resulting in a Superstructure hit. The marker on the Superstructure stress/damage track is placed on the "8" box because 8 points were in the attack. One more hit like that and the Gorn will be helpless! The second fwd phaser is fired. Same range, automatic hit again. 8 more points hit. A die is rolled for location. A 6 is rolled; a shield hit. The fwd shield on the Gorn ship is damaged. A marker is placed on the "FWD" space on the deflector's damaged track. Even though 8 points went into the hit, only one deflector is damaged. This leaves one phaser to be fired - the No. 1 port phaser. It has 5 points in it also. The damage + makes this an 8 point attack as with the others. A die is rolled - a 7 is the result, a warp hit. The marker on the engine stress/damage track is moved down 8 more spaces, to 28. Maximum speed is now down to 5 hexes. plus 1 less blaster and 1 less deflector can be used.

Both vessels have now fired all available weaponry. Both still have movement left, however. It is the Gorn's turn to move, as the C1 moved last. The Gorn decides he

has had it, and decides to increase his speed and get away. He cannot do so immediately, however. He must instead finish out the turn, as a change in overall speed must be declared (and rolled for, if necessary) at the beginning of a combat turn.

Once the next turn begins, the Gorn announces his intention to increase speed two increments, pulling out of the battle altogether. He rolls against his Crew Efficiency Rating of 49 (necessary to increase speed by two increments instead of one). He rolls a 23! He announces his speed increase (Federation sensors would pick this change up). The Federation captain decides not to pursue, and the combat is over.

## BASIC COMBAT SCENARIO

This scenario is the most basic encounter possible between a Constitution class starship and a Klingon D7 Battlecruiser. This scenario is recommended for the first time you play the combat game, as it allows players to quickly get the feel of the basics before going on to more complicated backgrounds.

**FEDERATION FORCES:** One Constitution class starship (perhaps the Enterprise), at full capacity. Ship begins from one edge of the map, shields down and weapons unarmed. Sensor identification has just been established of the enemy vessel.

**KLINGON FORCES:** One D7 battlecruiser at full capacity. Weaponry and shield status first turn at discretion of Klingon player (or gamemaster). Sensor identification of enemy ship accomplished some time ago. Unshielded status of enemy known. Captain's STARSHIP COMBAT STRATEGY/TACTICS skill level = 48. Crew efficiency rating = 44.

**Background:** An ambitious young Klingon captain decides to make a name for himself by defeating a starship. The starship is on patrol near Klingon space, in an area of high stellar noise that made it possible for the Klingon to get within striking range before being detected by sensors.

(NOTE: This should be a fairly minor challenge for a starship crew, particularly for the crew of the Enterprise! If it proves too easy, increase the captain's skill and the crew efficiency. A force of two battlecruisers should prove interesting as well.)

**VICTORY CONDITIONS:** The Klingon captain wins a decisive victory if the Federation ship is immobilized by superstructure or engine damage, or the starship takes more than 60% casualties. The Klingon wins a marginal victory if the Federation ship is forced to withdraw. The Federation captain wins a marginal victory if the Klingon is forced to withdraw or immobilized with the starship taking more than ½ damage to engines or superstructure, or more than 20% casualties. If the Klingon ship is forced to withdraw or is immobilized with less damage and casualties taken, it is a decisive victory for the Federation player. Any result in-between is no victory for either side.

(For variation, use an inverted counter to represent a planet. Place it in any hex. Weapons cannot fire through the hex. For lots of variation, use two or three counters placed 5 or 6 hexes apart. Planet hexes may not be entered unless the ship wishes to orbit. In orbit, the ship can not turn in place, except to prepare to leave orbit in the current turn.)

# Encounters in Space

(Excerpts from the definitive Star Fleet text on procedures for ship encounters, friendly and unfriendly.)

Text by Garth of Izar, Captain, Star Fleet.

Annotated, with additional material by James T. Kirk, Captain, Star Fleet.

Annotation and update material will be presented in parentheses.

Additional comments and material for use in game/simulations by FASA, under contract with Star Fleet Training division. Game/simulations material will be presented in bold.

## ON FIRST SENSOR CONTACT:

The most dangerous period of an encounter between two star vessels is the period of time between first sensor contact and identification of the unknown ship. It is during this period that a commander is most likely to make a mistake in judgement — and mistakes here can cost you your ship, or cause you to open fire on a friendly vessel.

This period of time is to be used for gathering as much information as you can. Make it work for you by opening your eyes to what even the smallest clues can tell you about an unknown vessel's intent. Long before you can gain a positive identification, you can learn important bits of information that may save your ship and your crew.

Look first at the unknown's course and speed. An intercept course is a red warning! In the vastness of space, such things cannot be accidental — the odds against it are enormous. If your courses will intersect, or even come very close, the unknown is seeking you out. On the other hand, if the unknown's course is simply carrying it through your sensor area, you cannot even assume the unknown knows you are present. *(Neither, of course, can you assume it does not... —Kirk)*

An object moving at sublight speed may not even be a ship, but no natural object can travel faster than light. If it exceeds Warp 1, it is of intelligent manufacture.

*(Exception: The so-called "Lights of Zetar" are the only known life form capable of greater-than-light speed without technological aid. None of these unique alien life forms are believed to remain in existence, but it does raise the extremely remote, but still actual, possibility of purely natural faster-than-light travel. Of course tachyons and certain other subatomic particles have also been discovered to move faster than light as well, a fact known to Captain Garth. It must be assumed he was referring to the fact that no natural phenomenon travels faster than light at will. This statement was true at the time he wrote it, and no other form of life but the "Lights of Zetar" have appeared to dispute it. —Kirk)*

A parallel course, especially one that matches your speed, is also revealing. Such a vessel does not wish to approach immediately, only observe and perhaps follow. It is possible that the commander of such a vessel may be

underestimating your sensor distance and does not know that you are aware of his presence. It also may be that the commander of the unknown vessel wants you to know he is there, for reasons of his own.

Watch the approach of a vessel as it comes closer, noting its closing speed. This will determine the amount of time you have to gather data before it comes close enough to identify or to fire on you! Use this time to find out all you can, even if all you have are seconds. At the end of this time, you will have to make decisions and make them fast, based only on what you can learn during this period. Do not act from ignorance.

**In terms of the combat game, most of this happens before the actual starship combat procedure takes place. The gamemaster will most likely only tell you that you detected an object. You must ask questions and make a successful Starship Sensors saving roll to gain more information. Use Garth's guidelines to know what to ask, and what the information received can tell you as a commander.**

## ON IDENTIFICATION:

Vessels that come close enough to be identified positively as star vessels fall into four categories. There are Star Fleet regulations to deal with each, but they are of necessity vague, leaving many important decisions to the commander in space. But there is an overlying philosophy that guides procedures for all types of encounters — the desire to preserve peace.

Where conflict can be avoided, without endangering the security of the Federation, the Star Fleet commander is duty-bound to do so. Above all law, above all regulation is this simple principle. We must share this galaxy with all its living, thinking peoples. Even a vessel belonging to an unfriendly power, when encountered in open space, is to be accorded its rights and privileges without undue challenge. It is the starship commander's job to judge when a ship is exercising free privilege, and when it is committing an act of aggression. The line can be a very fine one indeed.

Star Fleet regulations prohibit firing on any vessel unless such vessel "by its presence or overt actions presents a clear and present danger to the security of the Federation, the safety and rightful free passage of its citizens, or the dutiful proceedings of a vessel under its registry". Regulations further state that a vessel which "behaves in a manner that overtly and directly threatens the security of a Star Fleet vessel" may be fired upon only when "in the carefully considered judgement of its commander, no other action can be reasonably taken to avoid armed conflict, without by so doing presenting a greater threat to the Federation, its citizens, or to the ship in question itself".

While those words seem straightforward enough, they leave the hard part of the decision right in the lap of the commander of a vessel in space. When you are that commander, you and you alone will make that decision: perhaps face a Star Fleet Board of Inquiry to defend that decision. That is, you may face a Board if you are left alive to do so. With most mistakes, you won't be and neither will your crew.



Let us examine the four types of ship-to-ship encounter, with some practical suggestions on how each can be handled within Star Fleet regulations, with an eye toward protecting friendly relations with other cultures without jeopardizing your ship or the Federation's security.

#### ON ENCOUNTERING FRIENDLY VESSELS:

When a familiar identification beacon is received, you may breathe a silent sigh of relief, but it is not yet time to completely relax your guard. Confirm communicated ID with visual sighting. Even then, there is a certain set of protocols to be observed, not only for security reasons but as a measure of respect to the master of a vessel in space.

When encountering friendly vessels, establish visual communications as soon as possible. **Such communication should be possible between two vessels about the same time they are close enough to make positive identification of each other. This occurs when the vessels enter the board, in the combat game.** Refusal of visual contact without sufficient explanation should alert you to the possibility of trouble. Insist on such contact where you are in a position to do so. Also, do not hasten to approach a vessel that will not permit such contact, and do not permit such a vessel to approach you.

Star Fleet regulations allow a commander to hold a vessel at maximum positive sensor range **board's edge, in the combat game** if it refuses, or cannot give, visual communication. If a vessel, even a friendly one, refuses this privilege, you are required to give it a warning, quoting the regulation. If the vessel continues approach, you are required by Star Fleet regulation to raise defensive shields go on defensive alert status. At this point, the vessel is no longer, under regulations, considered "friendly". It must be treated as potentially hostile.

#### ON ENCOUNTERING NEUTRAL VESSELS:

Under Star Fleet regulations, vessels belonging to neutral powers (such as the Orion colonial planets) must be treated as "friendly" vessels until their overt actions present an "unfriendly posture". Dealing with neutrals is tricky business, chiefly because what constitutes an "unfriendly posture" is left entirely to a star vessel commander to interpret in the field. If questioned later, your actions regarding neutrals may be examined by a Board of Inquiry.

*(An examination of Captain Garth's own exemplary record reveals that he often acted first to protect his ship and the Federation's security, and "worried about the Board later". His only justification for his actions — and the only justification needed — was that he was again and again proved right. His record shows that he tended to "err on the side of peace" whenever possible, granting a suspicious vessel all possible leeway, until such time as the safety of his crew was directly threatened. Again and again, he made correct decisions based on very little evidence. Such a "feeling" for command decisions based on very little evidence cannot be taught by a text. It can only be learned by experience — Kirk)*

#### ON ENCOUNTERING UNFRIENDLY VESSELS:

A vessel is considered "unfriendly" when it belongs to a power defined as unfriendly, such as the Klingon Empire (*the Romulan Confederation and the Gorn Alliance are other "unfriendly" powers . . . — Kirk*), or when by its actions (firing weapons, refusing to hold distance and/or communicate meaningfully etc.) it has displayed an "unfriendly posture".

The raising of defensive shields, however, can be interpreted as an act preparatory to aggressive action. Thus, shields should be withheld if there is no clear and present danger to the ship. A ship proceeding on an intercept course, refusing communication, can be considered presenting an unfriendly posture, as can one passing closely within range of arms, despite requests to the contrary. Still, shields should be raised only if the commander feels an attack is imminent.

Once shields are up, expect to take fire! Prepare weapons and lock them for maximum effect. But do not fire unless you can establish that you actually are under attack. Regulations do not define this condition, but the proceedings of previous Star Fleet Boards of Inquiry can give us some guidelines.

If a vessel raises defensive shields when approaching rapidly, or maneuvers deliberately to bring firepower to bear, it must be considered hostile. Rarely, you may even be forced to fire first. If so, be very, very sure you can defend your actions later, but do not let indecision cripple you! Protect your ship and carry out your duty as best you can!

When you do fire, Star Fleet policy is to rapidly destroy the enemy's capability to perform damage. In other words, you must attempt to remove the enemy's ability to fight. This does not always require destruction of the enemy vessel or even massive loss of life. In fact, destruction and loss of life is to be avoided, unless the vessel's "mere, unarmed presence presents a clear and present danger to security or safety", in which case it may be destroyed. Boards of Inquiry rarely find total destruction of a vessel to be justifiable.

Once an enemy ship shows a willingness to break off hostilities, allow it to do so, but retain a full defensive posture. Demand immediate removal of the threat to security, either by removal of the ship from the area or surrender of the enemy ship. A ship that performs an act of war (such as attacking within clearly defined Federation territory, or attacking an identified, unarmed vessel on legitimate business) cannot be allowed to leave and must be forced to surrender or be disabled. **(A ship is disabled when it cannot attain warp speed, and has no offensive weaponry active).**

*(Certain unfriendly vessels, particularly those of the Romulan Confederation, have never been known to surrender. When encountered in Federation space, in violation of the pertinent Treaty, they must be destroyed if they attack overtly. Commanders are cautioned never to closely approach a Romulan vessel except under direct orders from Star Fleet, as Romulan commanders have orders to destroy their vessels to escape capture and boarding. — Kirk)*

## ON ENCOUNTERING UNKNOWN VESSELS:

The Star Fleet ship commander treads on thin ice indeed when encountering a ship not belonging to any known starfaring power. In encounters with an unknown race, a commander must be particularly careful not to initiate action that would be interpreted as hostile. Give someone new room to be your friend before you make an enemy of him. Star Fleet vessels are under strict orders not to open fire on, or take an unfriendly posture toward, a vessel of unknown origin unless it commits an openly hostile act, or openly declares hostilities.

Frankly, we could lose a lot of good men and ships this way, but it is this stance that separates the Federation from conquerors such as the Klingon Empire. Historically, this policy has paid off more often than not. The Andorian Stellar League was met in its first human encounter by an armed vessel. How much different would be the Federation's history if that meeting had resulted in conflict? Would there indeed have been a Federation at all?

You will never be sure, when you meet that first unknown race, what the results will be. Act with prudence. Think of the safety of your ship, yes! But think also of the future of the Federation: War is not a dishonorable profession. I have been a warrior all my life. But peace is more honorable still, and it is worth great risk to establish and maintain.

*(Historical note: At one point during the first star command voyage of Garth of Izar, his ship encountered a badly damaged ship belonging to no known race. Before communication could be established, the small ship turned and opened fire. Garth's vessel was damaged, but — though he raised defensive screens — he did not immediately return fire. Keeping a heavily-screened side to the vessel, he held course past them and continued beyond the vessel, stopping just within sensor range.*

*(The unknown vessel broke off the attack. Soon after, the two vessels established communication and shipboard computers managed to translate parts of the alien language. It was learned that the small ship had encountered a medium-size war vessel of the Klingon Empire, and had been badly damaged when the Klingons attacked them before the small ship could use its superior speed and maneuverability to escape. The commander of the vessel, upon detecting Garth's ship, assumed the Klingons had followed to finish him off and opened fire.*

*(More than 120 members of this heretofore unencountered race were slain by the Klingon attack. Three members of Garth's crew had been killed in the retaliation. Despite the inauspicious beginning, the newly encountered race went on to establish mutually beneficial trade and defense agreements with the Federation. The three slain crewmen were posthumously awarded the Star Fleet Medal of Honor and the Federation Peace Prize, and a Board of Inquiry commended Capt. Garth for showing "unusual and meritorious restraint in the pursuit of peace, despite overwhelming evidence of hostile intent". Later, Garth was heard informally to remark, "If I'd been wrong, they'd have called me a fool and a criminal — but I'd have never had to hear it." — Kirk)*

## SHIP CLASSIFICATIONS

Star Fleet has thousands of ships. The ships are classified by type or use. There may be several classes of ships of one type. Each type is given a range of unique hull numbers. Each class within this type is given a sub-range of these numbers. The types of ships currently in use in Star Fleet and their hull number ranges are given below.

TYPE	HULL	NUMBERS
Cruisers	1000	— 1999
Frigates	2000	— 2999
Destroyers	3000	— 5999
Scouts	6000	— 9000
Escorts	9000	—11999
Command	12000	—12499
Courier	12500	—15999
Explorer, Small	16000	—18999
Explorer, Medium	19000	—20999
Explorer, Large	21000	—21999
Research, Small	22000	—23999
Research, Medium	24000	—25999
Research, Large	26000	—26999
Colonization, Small	27000	—27999
Colonization, Medium	28000	—29999
Colonization, Large	30000	—31999
Transport, Sm, Robot	32000	—37999
Transport, Md, Robot	38000	—45999
Transport, Lg, Robot	46000	—55999
Transport, Sm, Manned	56000	—65999
Transport, Md, Manned	66000	—69999
Transport, Lg, Manned	70000	—89999
Miscellaneous	90000	—99999

Non-Star Fleet vessels (privately owned, commercial, etc.) are given registration numbers according to classification.

Axxxxxx	Transport, Sm, Robot
Bxxxxxx	Transport, Md, Robot
Cxxxxxx	Transport, Lg, Robot
Fxxxxxx	Transport, Sm, Manned
Gxxxxxx	Transport, Md, Manned
Hxxxxxx	Transport, Lg, Manned
Lxxxxxx	Passenger, Sm
Mxxxxxx	Passenger, Md
Nxxxxxx	Passenger, Lg
Rxxxxxx	Miscellaneous
Sxxxxxx	Miscellaneous

Ships under 10000 metric tons are considered 'small'. From 10001 to 60000 tons are 'medium', and from 60001 tons up are 'large'.



# Starship Data

## NELSON Class Scout

### CREW

Officers	- Command	- 20
	- Ensign	- 40
Enlisted	-	- 120
TOTAL		- 180

### SHIP DATA

Weight (empty)	95,000 Metric tons
Standard Range	9 Years at LYV
Max Safe Cruise Speed	WF6
Emergency Speed	WF8
Weaponry (offensive)	2 banks - 2 each phasers
Length Overall	262.5 m
Breadth Overall	127 m
Height Overall	60.5 m

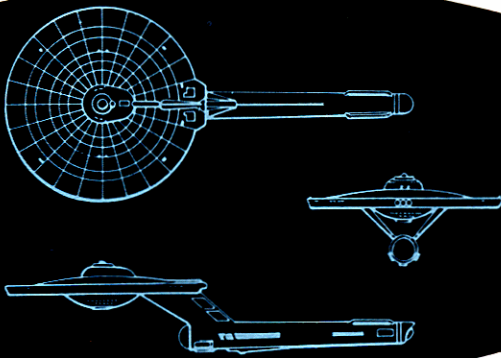

## LARSON Class Destroyer

### CREW

Officers	- Command	- 15
	- Ensign	- 50
Enlisted	-	- 130
TOTAL		- 195

### SHIP DATA

Weight (empty)	95,000 Metric tons
Standard Range	9 Years at LYV
Max Safe Cruising Speed	WF7
Emergency Speed	WF9
Weaponry (offensive)	3 banks - 2 each phasers 2 photon torpedo tubes
Length Overall	269 m
Breadth Overall	134 m
Height Overall	62 m

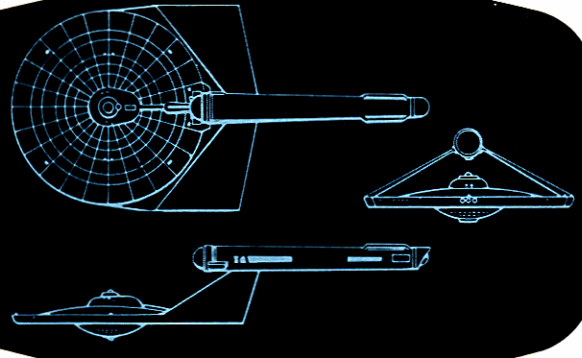

## DERF Class Survey Ship

### CREW

Officers	- Command	- 5
	- Ensign	- 16
Enlisted	-	- 51
TOTAL		- 72

### SHIP DATA

Weight (empty)	32000 Metric tons
Std Range	6 yrs at LYV
Max Safe Crs Spd	WF 6
Emergency Spd	WF 8
Weaponry	4 phasers (2 banks of 2)
Length (overall)	274 m
Breadth (overall)	128 m
Height (Overall)	65 m

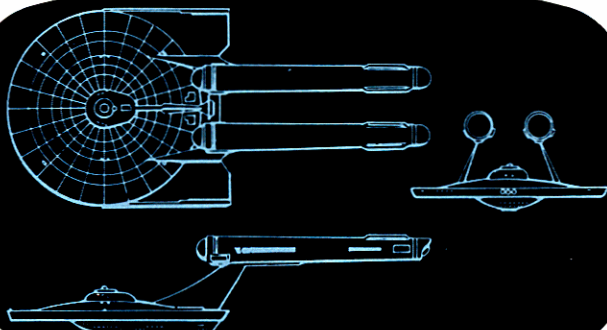

## LOKNAR Class Mdm. Frigate

### CREW

Officers	- Command	- 7
	- Ensign	- 24
Enlisted	-	- 48
TOTAL		- 79

### SHIP DATA

Weight (empty)	35000 metric tons
Standard Range	6 years at LYV
Max Safe Cruise Spd	WF 7
Emergency Speed	WF 9
Weaponry (offensive)	8 phasers (4 banks of 2) 4 photon torpedo tubes
Length overall	290 m
Breadth overall	127 m
Height overall	56 m

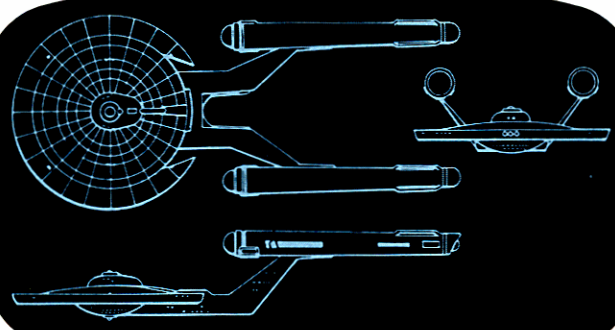

## Gorn Cruiser

CREW  
 Officers -- -- 20  
 Enlisted -- -- 100  
 - TOTAL - 120

SHIP DATA  
 Weight (empty) 50,000 Metric tons  
 Standard range 4 Years at LYV  
 Max Safe Cruise Speed WF 6  
 Emergency Speed WF 8  
 Weaponry 2 banks - 2 each blasters  
 Length Overall 115 m  
 Breadth Overall 81 m  
 Height Overall 40 m

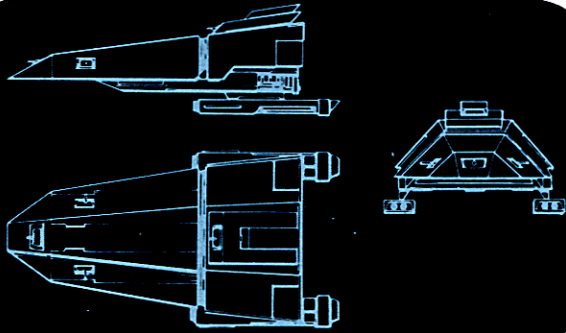

## Romulan "Bird of Prey"

CREW  
 Officers -- -- 30  
 Enlisted -- -- 120  
 - TOTAL - 150

SHIP DATA  
 Weight (empty) 60,000 Metric tons  
 Standard Range 5 Years at LYV  
 Max Safe Cruising Speed WF 4  
 Emergency Speed WF 6  
 Weaponry (offensive) 1 plasma bolt  
 1 cloaking device  
 1 Beam Weapon  
 Length Overall 152 m  
 Breadth 225 m  
 Height 37 m

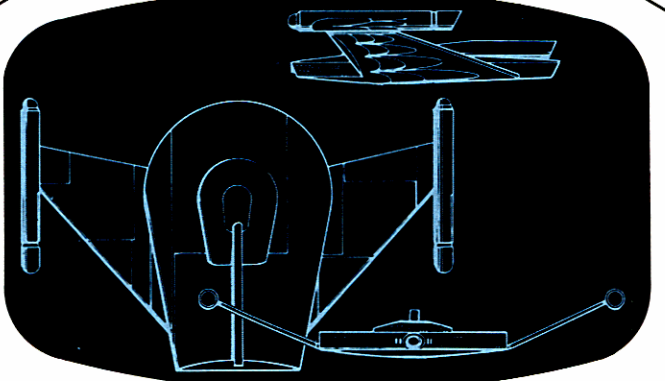

## Tholian Spinner Class

CREW  
 Crew unknown

SHIP DATA  
 Weight (empty) 25,000 Metric tons  
 Standard Range 4 Years at LYV  
 Max Safe Cruise Speed WF 8  
 Emergency Speed WF 10  
 Weaponry 2 energy projectors  
 web generator  
 Length 75 m  
 Diameter 67 m

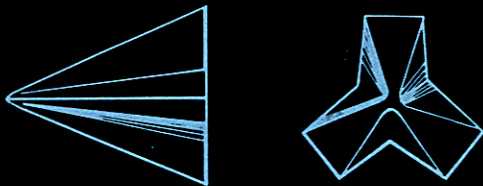

## Orion Blockade Runner

CREW  
 Crew (TOTAL) - 23

SHIP DATA  
 Weight (empty) 20,000 Metric tons  
 Standard Range 6 Years at LYV  
 Max Safe Cruise Speed WF 8  
 Emergency Speed WF 10  
 Weaponry 6 Distruptors  
 Length 100 m  
 Breadth 33 m  
 Height 32 m

Example Only, the Orions have no standard classes.

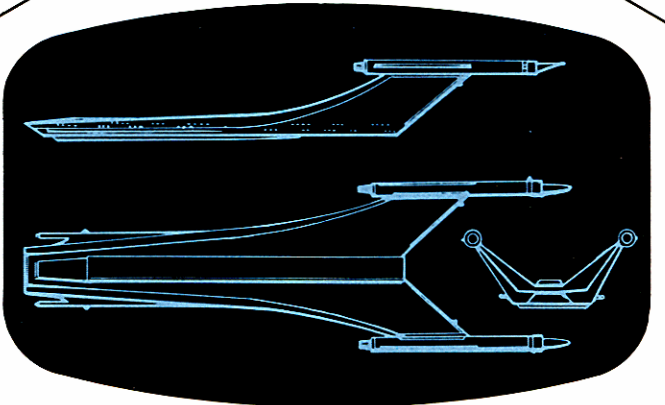



### "Nelson" class Destroyer Vessel

The Nelson class was designed to fill the need for small, lightly armed vessels to be used in the Exploration division in areas away from known borders with potentially hostile groups.

This class of ship carries 3 shuttlecraft, and has laboratories and exploratory/research facilities. It usually is deployed alone, not with fleets.

#### SHIP NAMES

Named for historical and fictional people and places who have become legendary. Hull series 7350-7799.

#### GAME INFORMATION

2 fwd phasers (4 pts. each max.)  
Range +2 to 8 hexes, +1 9-15 hexes  
Shields 5 pts. max in each  
2 pts. impulse power  
16 pts. warp power (1 engine)  
2 power points = 1 maneuver point

### "Derf" class Survey Ship

The Derf class is a medium exploration ship used for survey work. The circular top hull is four decks high. The uppermost small deck is the bridge. The second is weapons, crew quarters, and lounges. Third deck is crew quarters and rec areas. Fourth deck is recycling, fabrication, ships computers, and hydroponics. The lower hull is also 4 decks. The top 3 are 3.2 m high, the fourth is 9 m. The top 2 are storage fwd and engineering in the rear 1/3 of each. Transporters (2-6 man, 1 small cargo) are here. The 3rd deck is mostly part storage, the bottom deck is mostly open space. Shuttles recover buoys, enter forward, where the retrieved equipment undergoes an "assembly line" maintenance routine. When repaired, a shuttle takes the device out the aft door and replaces it on the navigation route. Early warning sensors, beacons, and communication relay stations undergo the same treatment. Special shuttles with small tractor beams are used for this procedure.

#### SHIP NAMES

Named after historical places in the Federation. Hull series 20100 -- 20179.

### "Larson" class Destroyer Vessel

A small fighting vessel used to patrol border areas. Used also as an escort for transport and colonization convoys. Designed at the same time as the Nelson class scout and Constitution class heavy cruiser, by the same design firm.

#### SHIP NAMES

Named after famous military leaders and battles. Hull series 4300-4499.

#### GAME INFORMATION

6 phasers — 2 fwd, 2 port, 2 stbd  
Each max 3 pts. power  
Range +2 to 8 hexes, +1 9-15 hexes  
2 photon torpedo tubes firing forward — 5 points damage each (cost 1 pt. to arm in full system)  
Shields 7 pts. each  
Impulse power 2 points  
Warp power 20 points (1 engine)  
2 power points — 1 maneuver point

### "Loknar" class Mdm Frigate

This is a "muscle" ship of the Federation. An Andorian design, the ship is designed to move quickly to trouble spots and fight. The weaponry is not as formidable as it first appears, however. The 8 phasers are not as individually powerful as those on the heavy cruiser. The difference is in total firepower. The ship is designed solely for fighting. There are no research facilities.

The main 'dish' is 5 decks high and contains weaponry systems control, quarters, mess, recreation facilities, etc. The 5m high smaller area atop contains the bridge and AC/water recycling equipment. The connector contains additional crew facilities. The engineering hull section contains warp engine controls, hydroponics, waste recycling, etc. The rear hull contains the impulse engine room, additional weaponry controls, cargo area, and shuttle bays. The Loknar class carries 2 shuttles, each with its own landing and storage facilities.

Incidentally, some Vulcans do serve on Loknar class ships, but there are no ships in this class crewed predominantly by Vulcans.

#### SHIP NAMES

Named after large cities in the Federation, normally capitols of provinces, countries, and planets. The class was given the hull series 2700 — 2799.

#### GAME INFORMATION

Has 8 phasers, 4 firing forward (2 with forward and stbd arcs, the other 2 with forward and port arcs) and 4 aft (aft arc only). Three torpedoes fire forward (fwd arc) and 1 aft (aft arc). When using the full system, torpedoes have 6 points of power in an attack and cost 1 pt to arm. Phaser can have up to 4 pts put into each of them and normally have a "+" of from 1 to 2 points of extra power in them. (1 from a range of 9 to 16 and 2 pts under 9 hexes).

The ship has 2 impulse points and 13 points in each of 2 warp engines. The shields can each have 14 points in them. Each point of power from engineering produces 2 pts of shielding. It takes 3 engineering power points to produce 1 maneuvering point.

## GORN CRUISER

The ship has 4 blasters, each using 2 points of power to produce 1 point of attack force. Bonuses are 2 points out to 7 hexes, 1 from 8-10, and none from 11 hexes up. Two fire fwd and stbd; the other 2 fire fwd and port. The deflectors can have up to 10 points put in them. The engines produce 40 points of power ( 4 imp, 36 warp).

## THOLIAN SPINNER CLASS

The Tholian Spinner has two energy projectors (up to 6 pts each) with a bonus of 2 pts to 4 hexes, and 1 point from 5-8. Both fire fwd and to each side. The engines produce 30 points of power (2 imp, 28 warp). It takes 3 points to produce 1 maneuver point. Shields may have up to 10 points in them.

The unique feature of the Spinner is the web generator. This device enables the ship to surround an immobile object with a "spider web" of energy, thus capturing it. The reason the object must be immobile is that a web takes a long time to generate, about 180 minutes for 1 ship. Two tholian ships can do the job in half the time (90 minutes). More ships will, of course, cut the time proportionately. Once completed, nothing can break out of it (*The Tholian Web* episode). The ship's other weaponry is capable of delivering a good solid punch, so watch out!

## ORION BLOCKADE RUNNER

A pirate ship, built for speed, fast guns, and little defense. Its speed *is* its defense. The ship has 6 disruptors (of Klingon design), each capable of having 4 points put into them. A bonus of 1 pt is given under a 9 hex range. 2 disr. fire fwd, 1 each stbd and port, and 2 aft.

The shields each can have up to 6 points in them. The ship has 3 impulse factors and 2 warp engines producing 15 points of power each. It takes 3 power points to produce 1 maneuvering point. The ship, although small, has 16 superstructure points because it has been reinforced throughout.

## ROMULAN "BIRD OF PREY"

This ship has two unique features; a plasma bolt projector and a cloaking device. The cloak can be used to make the ship invisible to visual sighting. Movement, however, can be picked up by scanners, though such sensing is tricky (+10 penalty to STARSHIP SENSORS skill roll). Also, when scanning for a cloaked ship, a sensor lock can only be maintained for one turn. Thus, the science officer looking for a cloaked ship must make a successful saving roll every turn to keep track of a cloaked ship.

A ship that has no sensor lock may not fire blindly into a hex, hoping a cloaked ship will still be there. Those hexes are big, and an essentially invisible ship simply cannot be hit, even if you know by process of elimination where it is. The only effective weapon vs. an undetected (by sensors) cloaked ship is a photon minefield. Proximity fused mines still are set off by a cloaked ship. Therefore, it's best to sit still as much as possible when using the cloak, as a ship in cloak cannot be detected by sensors if it has not moved in the past turn.

The best way to handle the cloak in game terms is to simply take the counter off the board when the cloak is in use and not picked up by sensors. Since this is a role-playing game and not a board game, this is handled fairly easily, since the gamemaster controls the situation anyway. If the counter is taken off the board, the gamemaster should jot the hex number down on a scrap of paper. If the ship is moved, write down the hex numbers moved through.

The cloak cannot be used when the plasma weapon is to be fired — there is not enough power for both. Each takes 15 points of power. The impulse only produced 2 points and the warp only 24 for a total of 26 points of power. So the ship must become visible to fire. If the weapon is to be fired, the player (or GM) may keep his ship invisible until he intends to fire, thereby not tipping the other player off as to his intentions. The plasma weapon has a forward arc.

Shield may have up to 8 points of power in them.





# Gamemaster Hints and Suggestions

If you have played role-playing games before, you will soon discover that gamemastering a session of **STAR TREK: The Role-Playing Game** is more challenging (but hopefully more rewarding) than games you may have run before. This is largely because the STAR TREK universe has much internal detail. Gamemasters have a lot of leeway, but to remain true to STAR TREK, they must keep in mind some basic assumptions about the universe, the player characters, and their responsibilities to Star Fleet.

Perhaps the most important decision you will make as a gamemaster comes right at the beginning. You (along with the players) must decide what type of crew the players will belong to and what positions they will hold. You may start out playing the crew of the U.S.S. Enterprise, but later you will discover that the most fun comes from creating all-new characters to serve on a different Star Fleet vessel. After all, play involving the U.S.S. Enterprise requires players to act according to the personalities and capabilities of the established series characters. This is fun, but for a long campaign, it is even more fun to develop personalities from scratch.

One possibility is to make the players junior officers aboard the Enterprise. With this option, characters can be built from scratch. Junior officers get a lot of landing party duty, which gets players into the action. There are some limitations involved here, as well. If the players get into trouble, it is all too easy to let the established series characters bail them out. After a while, this can become boring. Still, playing a first-contact or exploratory team from the Enterprise can be very exciting for a number of scenarios, allowing the players to interact with their favorite STAR TREK characters without becoming tied down by them. (An excellent example of how such a team works can be found in the STAR TREK novel *The Galactic Whirlpool* by David Gerrold. Gerrold's Enterprise contact team would translate well into this game).

Perhaps the most enjoyable set-up for a continuing campaign is when player characters are assigned to a different ship altogether. There are a number of other starships of the Constitution class. Each has about the same layout and capabilities of the U.S.S. Enterprise, though there are some differences the Gamemaster and players can create. But with a different ship of the same class, the characters can hold down any set of positions and develop their characters and the histories of those characters as they wish. Of course, the players' ship may cross paths with the Enterprise from time to time. The officers of both ships may even be acquainted. And in this new STAR TREK universe you are creating, some of the crew of the players' ship may even have been transferred from the U.S.S. Enterprise itself!

Another interesting basis for a campaign is the crew of a small ship, perhaps an Explorer class courier/transport. Such a ship, with a crew of 9, provides a marvelous way for gamemaster and players to have the best of both worlds. A small group of players can be in command,

operating along the fringes of the Federation with some say in where they go and what they do. Even so, the crew is small enough that players get a lot of landing party duty as well. An Explorer class ship operating as a scout vessel makes for a very lively campaign background.

Once the background for the campaign is decided on, the players should start creating characters to fill the various jobs decided on by the gamemaster. Gamemasters should be guided by the players' wishes, their personalities, and their strengths and weaknesses as game players in choosing jobs for the players.

A person who is not a very strong decision-maker should not be made captain, unless doing so is an attempt to get them out of their shell. (The designers have seen even the shyest and most passive players perk right up and become dynamic leaders when given their own ships. Sometimes. Other times, shy people hate command positions. Go by the desires of the player as much as possible).

Style of play is all important. Gamers with itchy trigger fingers will most likely be unhappy as medical officers, but make good security specialists. Cerebral types make excellent science specialists, and gadgetry fans like engineering. Note that these are just simple guidelines! Treat your players as individuals and let them get into positions they want as much as possible!

When placing players in job categories, also bear in mind that you want to get everyone involved as much as possible. Ship's historian sounds like an interesting position, but is called for in very few adventures, so this post would likely be best filled by a non-player character. If there is dissention about who should be captain, perhaps the best solution is to have a non-player captain! This will also give the gamemaster a bit more control over the situation.

The gamemaster must guard against the tendency to overplay his non-player personnel, thus leaving the players with little to do. Role-play the non-players in a colorful, realistic manner, but let the player characters take the lead and set the pace of play as much as possible.

Encourage players to make their characters as three-dimensional as possible by giving them little personality quirks and special interests and hobbies. Look at the crew of the Enterprise for examples. Kirk has an interest in American history. Scotty disdains shore leave in favor of reading technical journals. Dr. McCoy is fond of Saurian Brandy, dancing girls, and a good time. Sulu practices fencing and botany. Nurse Chapel is in love with Mr. Spock, but can't do anything about it. Nor can Spock, who can't return her feelings because he represses all emotion. Characterization, so important to a writer, is also important to a role-playing gamer. Besides, these little character traits can help you, as gamemaster, come up with ideas for scenarios.

Quite often, the players will want to play themselves, as they might have been had they lived in the fictional STAR TREK universe. Sometimes, these are the

best campaigns of all! The character's personalities, interests, etc. are largely the player's own. When doing this, you may wish to suspend the character creation rules a bit and help the players draw up characters that match their own physical capabilities. Be prepared to stretch a point here, as players would rather play more-or-less idealized versions of themselves that possess their strengths, but play down their weaknesses. After all this game is played for fun. Don't saddle someone with a character that makes the player unhappy just for the sake of making a point.

Now you have a campaign background, and well-rounded characters to fill the jobs on the ship you selected. Your next job as a gamemaster is to develop some adventure situations for your players. The game material in this box has some starting points for adventures, but you soon will want to create your own. Here are some suggestions to get you started:

**FIRST SURVEY:** The ship is assigned to run the first survey of a newly-discovered class "M" world. Up until now, the only visitor here was a survey ship that made some sensor readings from orbit and departed. You must beam down a landing party and gather data so that Star Fleet Command can decide if the planet is suitable for colonization, mining, agriculture, or other uses. In addition, you must watch for any signs of intelligent inhabitants. If any are found, you must decide if they are primitive (in which case they must be approached about establishing diplomatic relations with the Federation).

Planets of this sort may or may not have intelligent inhabitants, but they will certainly have plants and/or animals that are unknown to the Federation, or at least unfamiliar to the players. There may be a source of some rare mineral or important biological material to be found. It is also possible in certain parts of the galaxy that Klingon survey parties may also be interested in this world, particularly if it is strategically located near important Federation trade or population centers.

**DIPLOMATIC COURIER:** The ship is dispatched to pick up a Federation ambassador and transport her/him to an important conference. The conference may be with officials of a planetary government considering signing trade and/or mining agreements with the Federation, or with two warring independent powers where the Federation is acting as an intermediary. In either case, there may be other powers interested in seeing that the ambassador does not arrive, or that his/her mission does not succeed.

**MEDICAL EMERGENCY:** A nearby planet has reported a medical emergency (outbreak of disease, biological attack, ecological disaster, natural disaster), and only your ship is close enough to bring aid. The medical staff will be kept busy aiding the worst casualties and searching for new techniques and treatments. The other departments may have their hands full as well, especially if the emergency situation proves to be planned rather than accidental.

**DISTRESS CALL:** The communications officer picks up a distress call, perhaps from a damaged ship in space, perhaps from a planet's surface. The details of the emergency may not be known in full when the ship arrives to help. The cause of the problem may still be nearby, ready

to cause trouble again. It's also possible that the whole thing is a hoax to draw the ship into a trap . . .

**ALIEN DERELICT:** A drifting ship is detected by sensors. Upon investigation, the ship may prove to be of familiar, or of totally alien design. In either case, the players must probe with sensors and perhaps go on board to uncover the mystery of the silent vessel and its passengers.

These are only a few suggestions to start your imagination humming. The best sources for ideas are the episodes of STAR TREK themselves, and the large number of original works of STAR TREK fiction written by fans and professionals. Check the bibliography in this rules set for a partial list of STAR TREK materials, plus other useful reference books for the STAR TREK gamemaster.

### A NOTE ON GALACTIC MAPPING

By this time you may have noticed that there is no master map of the galaxy in this game. In most science fiction games based around galactic travel, a great deal of time (not to mention many, many expansion books) is spent mapping the known galaxy, mainly so travel times from point X to point Y can be determined. In most games, travel time is all important, as the characters must be role-played through these periods. Random encounters may occur at these times, for one thing. Also, experience and character improvement can depend on how much time is spent in space.

A master map of the STAR TREK universe could possibly be constructed given a large enough amount of time. Indeed, Ballantine books published just such a map, "The Star Trek Maps" not too many years ago. (This work is still in print, to the best of our knowledge, if you are interested in consulting it). The people who designed that map faced the same problems we faced.

Mainly, the problems are wrapped up in the fact that STAR TREK was created as a dramatic presentation first, and a self-consistent fictional universe second. It is in travel times and relative location of planetary systems that the consistency of the STAR TREK universe most falls apart. The Enterprise travelled between locations in space that even it's fastest warp speeds would not have sufficed to cover in the lifetime of the crew, let alone a "five-year mission". Several times, writers used a star system more than once, unaware or uncaring that it had before housed an entirely different set of planets and planetary inhabitants.

Mapping just the area of space patrolled by the U.S.S. Enterprise would require explaining why that area bordered both Klingon and Romulan space (as well as Gorn space, Tholian space, the First Federation, etc.). Did any other starship have anywhere to go?

These inconsistencies were necessary to tell a good story, which was STAR TREK's major aim, after all. It makes things hard on the galactographers among us, however.

Yet, to be honest, it could have been done. If enough outcry is made over the lack of such a map, it no doubt will be done, in time. But the structure of **STAR TREK: The Role-Playing Game** is consciously designed to make galactic mapping of this scale unnecessary.



The structure of **STAR TREK: The Role-Playing Game** is episodic in nature, much like the television series itself. Our aim was to capture the flavor of STAR TREK, the television series. Therefore, as in the series, it really does not matter what happens between adventures.

An adventure situation in STAR TREK truly begins where the "teaser" of the episode begins — at the point a dramatic conflict or confrontation first arises. This may be an encounter with an alien vessel, a call from Star Fleet Command with new orders, an intercepted distress signal, etc. The day-to-day operation of a star vessel really does not matter, except where it affects an adventure situation.

For this reason, we chose not to burden the gamemaster or game players with minutiae about how often a starship must replenish dilithium crystals, or is paid. In an adventure situation, it simply does not matter. Between adventures, the crew performs duties and enjoys normal recreations "offstage". We'll visit them again when things get exciting.

Even the system for improving characters during a longer campaign series is designed to take advantage of these quiet times without having to carefully chart their length or events. The STAR TREK TV series — and this game — is a window on the exciting part of the STAR TREK universe without the tedium of the long, uneventful days in space.

For this reason, gamemasters are encouraged to prepare each scenario with a short background of what has happened "up till now". That is, start where the decision-making for the players begins. If a mysterious message is intercepted, simply tell the players what it is, where it comes from, and how long it will take to get there from where they start the game. The details are up to you. You must "set the stage" much as the "teaser" of a STAR TREK episode does for the audience.

Suggested devices for starting an adventure are messages from Star Fleet Command and Captain's Log entries (where the captain is a non-player character). Or you can simply say something like this:

**GAMEMASTER:** Your ship is two days out from Calvery IV, proceeding at Warp 3, on a routine call to deliver a Federation diplomatic pouch and other official greetings. Unexpectedly, your communications officer picks up a faint subspace signal from the direction of that system, calling for Federation assistance. The message is too faint to make out much else, and it is unlikely in this part of space that any other Federation vessel will intercept the signal.

**CAPTAIN:** Can the communications officer pick up anything else?

**GAMEMASTER** (to communications officer): Make a standard saving roll on Communications Procedures.

**COMMUNICATIONS OFFICER** (rolling): I made it! What do I hear?

**GAMEMASTER:** There's a lot of interference, but by switching antennas you get a bit more. The voice is male and human-sounding. You catch a reference to "the insect plague" and another to "Government House" being "besieged by the horde". Abruptly, in mid-sentence, the message stops and you pick up no further transmission.

**CAPTAIN:** That sounds urgent! And we're three days away at Warp 3! How far at Warp 6?

**GAMEMASTER:** Warp 3 is 27 times lightspeed and Warp 6 is 216 times lightspeed. That's 8 times as fast.

**CAPTAIN** (consulting pocket calculator): That's . . . nine hours or so. (To navigator and helmsman) All right Mr. Devareux, Mr. Wickes . . . Increase speed to warp 6 on the same course. (Turning to communications officer) Mr. L'rann, send a message to Star Fleet Command detailing the situation and tell them we're on our way.

**GAMEMASTER:** Just so you'll know, it will take six days at this distance for a message to reach the nearest starbase.

**CAPTAIN:** So we'll be on our own. Very well. The science officer will consult the library computer for information on the planet. Department heads will meet in the briefing room in thirty minutes for discussion.

**SCIENCE OFFICER:** Captain, a computer file search on insect life on Calvert IV might be appropriate . . .

**CAPTAIN:** So ordered, Commander Levine. (Dropping out of character) Everybody check with the gamemaster on your own departments. I'm going to grab a snack!

By starting an adventure in this manner, much of the hassle of galactic mapping is eliminated. Since where a ship goes and what it does is largely determined by its patrol area and by Star Fleet orders anyway, very little advance planning needs be done by the players involving where the ship will go. The gamemaster should be aware, however, that he must establish distances and times to locations where the adventure will lead the players. If the trail of adventure leads to more than one world, travel times should be established by the gamemaster for best dramatic effect, just as a writer would do for the STAR TREK series!

You will find, as we did, that players really do not miss galactic mapping. Those used to games such as TRAVELLER or SPACE OPERA may find it disconcerting at first, but **STAR TREK: The Role-Playing Game** is a decidedly different type of role-playing game and requires a different approach. Once you adjust to it, you'll like it just as well as the detailed planning and mapping in other games.

# Designers Notes

What can you say about a project that absolutely possesses a design team from the time it is begun? Adventure games come and go, but the chance to do STAR TREK comes along once and once only.

As long-time fans of the series, the Fantasimulations Associates design group started this project with an advantage. Virtually every piece of STAR TREK research material available was already at our fingertips in our personal libraries. What we didn't have, we were able to borrow from other fans who were as excited about the project as we were ourselves. Thanks in this regard go particularly to Mike Drennan, who loaned us his autographed copy of Bjo Trimble's STAR TREK CONCORDANCE for the duration. Long out of print, this reference work proved invaluable in our research. We put a lot of wear on that copy (and on Greg Poehle's as well), checking and rechecking references to series episodes. Where the game is accurate, it is largely thanks to Ms. Trimble's exhaustive work. Where the game is not, we take the rap entirely. Being fans ourselves, we were all too aware of the enormous responsibility involved in designing STAR TREK: The Role-Playing Game. Unlike a fictional universe created especially for a game, the work we did had to be consistent with three seasons of television scripts AND with the popular fan wisdom that fills in the gaps in STAR TREK history the series did not show. To add to the problem, the series itself is not internally consistent, leading us time and again to make assumptions based on best guess and common sense.

Of course, since the STAR TREK series left the air, more has been added to that fictional universe than ever existed on the screen. It has been the response of fans that has made the background of STAR TREK so rich and full. Add to those 78 TV episodes 22 animated series episodes, dozens of original professional novels, a dozen or so more "official" STAR TREK publications showing plans, designs, sketches, speculations, histories, etc. and literally showing plans, designs, sketches, speculations, histories, etc. and literally thousands of pieces of fan fiction! The STAR TREK universe is huge, and getting bigger all the time.

It would be impossible to coordinate all of this material — much of it incompatible — into a game that would fit into a reasonably-sized box at a reasonable price. It was left to us to determine what was the "essential" STAR TREK material, leaving it to gamemasters and players to add whichever specialized material they preferred on their own.

Toward this end we started with some guidelines. Material in the 78 prime-time episodes was accepted as "official" — the true history of the STAR TREK universe around which the game would be based. Even here we ran into a number of inconsistencies, where one episode's assumptions contradicted another's. When this happened, we went with the information that best supported the generally held fan beliefs on the matter.

We agonized over some of these decisions, but in the long run it will be the fans who decide what is and is not

STAR TREK for their campaigns. Feel free to change even basic assumptions if it suits you. Don't be offended if we state something as "fact" that does not fit with your personal images. Simply run your campaign to suit what STAR TREK means to you. It's your campaign, and we are by no means the final arbiters on such matters.

We then decided to accept the animated STAR TREK series where it did not conflict with the live-action episodes. One exception was made to this decision — the inclusion of the Kzinti race from Larry Niven's animated episode *The Slaver Weapon*. The omission is not made out of a dislike for the concept — far from it! The Kzinti are a marvelously developed truly alien race. But as great fans of Mr. Niven's "Known Space" series of stories, we could not help but feel that it was in that fictional universe that the Kzinti truly belonged. Thus, they do not appear in this work. Those STAR TREK fans who have not been exposed to the Kzinti outside of the animated episode *The Slaver Weapon* are encouraged to try some of Mr. Niven's *Known Space* fiction, especially the novels which form the capstone for the series, *Ringworld* and *The Ringworld Engineers*!

Next, we looked to the fans themselves (ourselves, we should say) for some of the basic assumptions made by fans that have become almost as much a part of the STAR TREK legend as the series episodes themselves. Fan fiction in the STAR TREK universe goes a million different directions. There are any number of "alternate history" STAR TREK's, if you desire. (If you do run an alternate history campaign, we'd be interested to hear about it!) But it's not possible to include material from fan-developed alternate histories in this game package.

What we did include were widely-held fan beliefs about items of general interest. We know, for example, Kirk's exact age from his dialogue in *The Deadly Years*. But how old is Spock? McCoy? Uhura? We needed these details, but the series could not provide them. (Often, the series writers couldn't agree themselves. Early on, McCoy was intended to be older than Kirk. A later STAR TREK director decided, though, that McCoy was Kirk's contemporary — about the same age. This was in connection with cutting the intended appearance of McCoy's daughter Joanna out of the original script for *The Way to Eden*. We have stuck with the original concept of an older McCoy).

Material exclusively from professionally-published STAR TREK novels and the various books of STAR TREK "non-fiction" material such as plans and histories has been adopted only when it has become a generally accepted part of the STAR TREK legend, used as official by more than one source. Some of this material is not available to us for use, other parts of it are not consistent with the established STAR TREK universe, and still more of it was judged as being pure speculation that was not an "official" or accepted part of STAR TREK lore.

Some of our own speculations herein may contradict certain STAR TREK novels, or ignore changes intro-



duced in those novels. Gamemasters and players are free to use or not use this material as they wish, but remind you that much of the material in some STAR TREK novels is considered to be "alternate universe" material happening in a different "space-time" from the mainstream STAR TREK material. One prominent example is the late James Blish's novel *Spock Must Die!* In that novel, the Klingon problem is settled once and for all, with the Organians regressing their culture to a pre-space flight level. Yet other authors (and the later STAR TREK movies) have gone ahead with Klingon-centered novels regardless. Whether or not the Klingons are still a threat is up to you – in which universe do you want to set your campaign?

Mentioning the STAR TREK movies brings up another initial assumption we had to make. The setting of this game is the period of time surrounding the TV series missions – the original five-year mission commanded by Captain James T. Kirk. The many changes in the STAR TREK universe between the last animated episode and *STAR TREK: The Motion Picture* are not considered in the basic game package, though we have gone to great lengths to insure that nothing we establish here is in direct conflict with the films.

If you wish to set your personal adventure world the time period of *STAR TREK: The Motion Picture* or *The Wrath of Khan*, by all means do so. At this time, we are not ready to expand into that area, but there's no telling what the future will bring, if the interest exists. Changes for the "future" STAR TREK material is minor and can be handled by the average fan on her/his own.

Inevitably, we found places in the STAR TREK background material where no "official" answers existed for our questions. When this happened, we were forced to fall back on our own imagination and common sense. Your speculations are as good as ours in these cases, and you should feel free to add or subtract material as it suits you. Data like this was added with as much care as we could take, trying to come up with answers that made sense in the context of the larger STAR TREK universe.

An example of such material is the Gorn hand weapon. We only see one Gorn in the live-action series, and he carries no arms. (*Arena*) Surely the space-travelling Gorn have energy weapons, but of what type? If we want to make viable Gorn adversaries available in the game, we must create some of the Gorn technology, such as ships and hand weapons. We hope you will find the ones we developed to your liking. If not, develop your own speculations and send suggestions to us c/o FASA.

A lot of basic design work must be done right at first which then shapes the entire game system. The results of these decisions have affected every piece of material in this first package, and will affect all material to come.

There are three basic systems that must be planned first – character creation, character tactical movement/combat, and starship tactical movement/combat. We'd like to briefly discuss each system, and the reasons behind our design decisions for each. These systems do not just happen accidentally, nor are they selected without a lot of forethought and compromise between playability and realism.

## CHARACTER CREATION NOTES

From the start, it was evident that we would have to limit somewhat the choices of character race for player characters. Early on, the decision was made to limit player characters in the basic game package to Federation Star Fleet crewpersons. Playing Klingons, Romulans, Gorn, etc. would be a lot of fun, as STAR TREK's villains were among the best characters in the series! (Witness William Campbell's portrayal of Captain Koloth in David Gerrold's episode *The Trouble With Tribbles*. Koloth is designer Guy McLimore's favorite STAR TREK villain, and *Tribbles* his favorite episode . . . ) But putting all the material necessary for such play into the initial package was impossible!

Klingons as player characters implies a completely detailed background for the Klingon Empire, details on Klingon Fleet organization, Klingon ships of all types, Klingon rank and promotion, Klingon training programs and skills, Klingon arts and culture, Klingon personal habits of dress and grooming, etc. In other words, we would have to create a whole cultural heritage practically from scratch!

This is not to say that we aren't going to tackle the project! (A whole culture or two to speculate on . . . are you kidding? Of course we're going to do it!) But it wouldn't go in the package at any reasonable price. Instead, we have provided enough material to use Klingons, Romulans and the like as non-player races, or to do some limited campaign work as player characters, if you desire.

Meanwhile, we are preparing material for extensive supplements for the Klingons, the Romulans and perhaps other non-player races. These packages will contain complete background histories, character creation systems, plus new skills, ships, weapons, equipment – everything you need to play the crew of the dreaded D-7 Battlecruiser *Klothos*, or whatever you desire. (If you have suggestions, research material, or speculations you would like to see considered for these expansions, write the designers c/o FASA).

The player character races that were selected for the basic game are the races we know the most about from STAR TREK. There are bound to be other Federation races that serve on Star Fleet vessels, but only these were ever shown in enough detail to build a character profile for them.

STAR TREK was hampered by the fact that – although you might like to have some totally non-human crewpersons – it is extremely hard to fill a casting call for a non-humanoid being: The animated series brought forth some help in this regard, but 22 half-hour episodes is too little time to provide much background information. It is here where the gamemaster should begin to use his own imagination. What are Andorians, Tellarites, etc. really like? We'll be doing more later in this regard as well, both as expansions and as part of adventure material.

The Academy procedure for character creation came out of a need to have the player characters in decision making positions, and a desire to provide some background for character role-play. It takes a bit of time to generate a character in this game, but we've tried to make the proce-



sure as easy and fun as possible. There may be those among you who desire a more elaborate system, providing more background data on the characters. If so, let us know and we'll try to develop one. Also planned is a more complete system expansion for creating Star Fleet enlisted personnel instead of just officers.

### TACTICAL COMBAT NOTES

When trying to decide how to design this section, we remembered one old adage - when something works well, use it! And that is exactly what we did. We had been playing GRAV BALL (by FASA). We enjoyed the movement and action system. It worked well, giving the feel of simultaneous movement while retaining a simple system. Most si-move systems require paper plotting of moves in advance. While realistic results can be obtained, the system is slow and cumbersome.

GRAV BALL, on the other hand, is fast and fun when played a few times. The system is easily learned. It plays fast. Record keeping is simple. To put it simply, we liked it well enough to use it.

The sequence of play is determined by DEX. This gives the side with a "fast" character an advantage, as it should. The decision on how many AP was made simply - an "average" character should be able to move between 6 and 10 squares. This was just a number that "sounded good", based on our ground scale and established combat movement conventions. The number of points an action took was determined by calculation, doing (check our bruises from 'dive rolling'), and observing. We kept the list of actions as short as we felt possible, wanting people to be able to handle most actions, but not wanting to bog the system down with details like "eat food: 2 AP". If you want to add to the list, feel free. Just use common sense. If someone comes up with a generally useful addition to the list, let us know and it can be "officially" added to the system.

Combat evolved from our working knowledge of almost every game published on tactical combat. From the action list and character system we had it was a simple matter (although lo-o-o-o-ong!) to develop this aspect. Again, we just "worked through" what really happens in a combat situation. We drew on our own and other's experience (you should see the looks we got from neighbors) and worked out situations live.

The "to hit" modifiers list is not intended to be exhaustive. Occasionally you will not be able to fit something a character wishes to do into one of the modifiers listed. Again, feel free to add. We could not cover everything.

Weaponry was based as much as possible on research from the series. Where no data was available we made educated guesses, based on the technology level and psychological/social background of the designing race.

### STARSHIP COMBAT NOTES

Some of the background on ship combat design was given in the section in question. The major reasons for the design philosophy are as follows: 1) We had to be true to

the series first 2) It had to be as simple as possible to understand and play 3) It had to be fun and 'feel' right.

First of all, realize that science took a back seat in this section to STAR TREK's brand of "realism" and to playability. If we stuck to known science, combat would not even be possible at the speeds talked about. For that matter, the speeds used are almost impossible to even think about. So we went with the Roddenberry philosophy - scientific accuracy where possible, but stretch where necessary to make a good story.

The transporter and the warp drive are examples of "suspension of disbelief" in STAR TREK, where absolute scientific accuracy had to bend to those of Gene Roddenberry in creating STAR TREK itself. Again, we had the problem of conflicting material. We went with the most popular opinions when in doubt.

The next major design philosophy decision was that this was a role-playing game. We did not want another board-game with spaceships. It's been done many times. Some of them are good and we like playing them, but we wanted a whole new approach. Everyone playing the game (or, specifically, the ship combat) should be involved. Most games on the market are designed to be played by 2 players - one on each side. Ours was to have a variable number, usually 6. Each was to have duties comparable to their counterpart on a starship (specifically, the Enterprise). The key thoughts were interaction and role-playing. The players must work together to be successful. Everyone must be involved. Most of all, you had to feel that you were on the bridge of that ship.

The ship's captain has the least to do, and the most to do. A contradiction? No, it's just that he/she has no control panel to use, but yet must be aware of all those around him. He handles no systems or data, yet controls them all. His job is as it should be decision-making.

The engineer panel is not earth-shaking. Many games use a power allocation system. What we have done is make it an interesting job to decide who gets what power. Everyone is always wanting more power than the engineer can get from those engines.

The helmsman and navigator are interesting jobs. The movement of the ship is easy enough, but watch those tight turns at high speed! We felt that the easiest approach to handling turns was to be realistic. The tighter the turn, especially at higher speeds, the more the damage. Information from the series backed up this observation. The weapons and shields are straight-forward enough. Almost all of this was designed through researching the series episodes themselves.

The science and communications posts are again based on what their counterparts did in the series. It is up to the players to utilize role-playing to the fullest to obtain information about the opposition.

Remember, role-play the character you are portraying (or the position). Use the skill rolls. The game can be played as a board game, but is at its best when played the way intended.

The main thing to remember is the system was designed to cover a lot of possibilities. Feel free to adapt and change to suit your personal style of playing.



**CONSTITUTION Class  
Hvy. Cruiser**

190,000 Metric tons

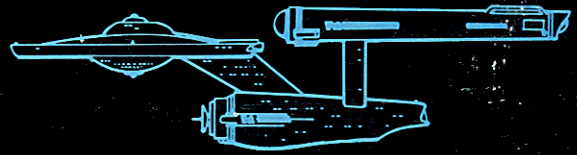

**DERF Class Survey Ship**

115,000 Metric tons

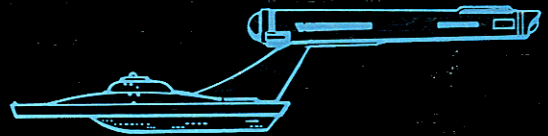

**KLINGON D-7 Battlecruiser**

110,000 Metric tons



**LOKNAR Class Mdm. Frigate**

100,000 Metric tons



**LARSON Class Destroyer**

95,000 Metric tons

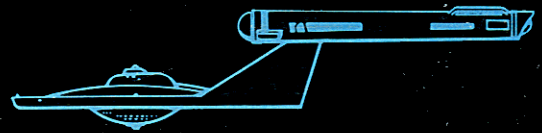

**NELSON Class Scout**

95,000 Metric tons



**ROMULAN Bird of Prey**

60,000 Metric tons



**GORN Cruiser**

50,000 Metric tons





# STAR TREK™

THE ROLE PLAYING GAME

ADVENTURE BOOK

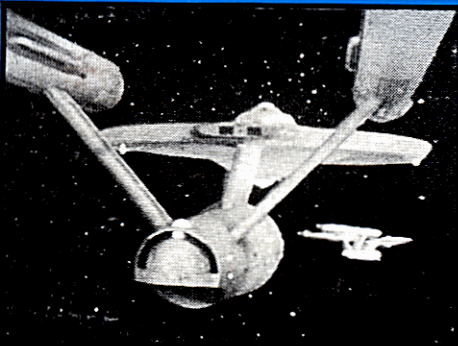

Ghosts of Conscience

Again, Troublesome Tribbles



In The Presence of My Enemies





*Space ... the final frontier.*

*These are the voyages of the Starship Enterprise.*

*Its five-year mission: to explore strange new  
worlds, to seek out new life and new civilizations  
to boldly go where no man has gone before...*



**fasa**

Written by Fantasimulations Associates  
Designers: Guy W. McLimore, Jr.  
Greg K. Poehlein  
David F. Tepool

Illustrations and Drawings: Mitch O'Connell  
Jordan Weisman

Graphic Design: Jordan Weisman

Editor: Helena Szepe

Copyright 1966, 1983 Paramount Pictures Corporation  
All Rights Reserved  
Printed in the United States of America

No part of this book may be reproduced in any form, or by any means without permission in writing from the publisher.

STAR TREK™ is the trademark of Paramount Pictures Corporation.

STAR TREK™: The Role-Playing Game is manufactured by FASA Corporation under exclusive license from Paramount Pictures Corporation, the trademark owner.

Manufactured by Patch Press, Inc.

Published by FASA Corporation  
P.O. Box 6930  
Chicago, Illinois  
60680-6930

Playtesters and consultants:

Kim Guinn  
Jeff Lockridge  
Wilda Klingelhoefner  
Karen Tackett  
Carlyn Nugent  
John M. Ford  
Mike Drennan  
Joan Tepool  
Jason Tepool  
Terri Klingelhoefner  
Scott Collins  
Samantha Jude Cook  
MINICON 1982 con committee and attendees

Special thanks to Ken Ballard of ABC Hobbycraft for putting up with all the foolishness. . .



# Table of Contents

<b>Ghosts of Conscience</b> . . . . .	5
The Adventuring Group . . . . .	5
Background . . . . .	5
Deep in Unknown Space . . . . .	5
File Information . . . . .	7
Approaching the Hood . . . . .	7
The Retrieval Party . . . . .	7
The Wreck of the Hood . . . . .	8
Special Locations - USS Hood . . . . .	8
Moving About on the USS Hood . . . . .	9
Combat Encounters . . . . .	10
Endgame . . . . .	10
Designer's Notes . . . . .	11
<b>Again Troublesome Tribbles</b> . . . . .	12
Beginning the Adventure . . . . .	12
Planetary Situation . . . . .	12
Topographic Sensors and Landing Sites . . . . .	13
Arrival by Shuttle and First Encounter . . . . .	13
The Chameleon . . . . .	14
The Trip to the Laboratory Station . . . . .	14
Genetics Research Station 17 . . . . .	15
The Klingons Arrive . . . . .	16
Morning at GRS17 . . . . .	17
Endgame . . . . .	18
Klingon Landing Party . . . . .	19
GRS17 Personnel Files . . . . .	19
Federation Genetics Research Station 17 . . . . .	20
GRS17 Floor Plans . . . . .	21
Animals of Aleph III . . . . .	23
Example Encounter Map . . . . .	25
Secondary Site Map . . . . .	26
<b>Gamemaster and Player Character sheets for Mission Class Courier</b> . . . . .	center 4 pages
General Map of GRS17 and Surrounding Area . . . . .	27
<b>In the Presence of My Enemies</b> . . . . .	28
The Adventure Group . . . . .	28
Background (optional) . . . . .	28
Approaching the Lorealyn System . . . . .	28
Prisoners of the Klingon Empire . . . . .	29
Jailbreak! . . . . .	29
Moving About the Ship . . . . .	30
General Alarm . . . . .	31
Areas of Interest . . . . .	31
Endgame . . . . .	33
Non-Player Character Information . . . . .	33
 Mission Class Courier Deck Plans . . . . .	 34
 <b>Part Two: Ship Descriptions</b>	
Constitution Class Heavy Cruiser . . . . .	1
Klingon D-7 Class Battlecruiser . . . . .	10



**This page was intentionally left blank.**



# Ghosts of Conscience

**WARNING:** The material in this adventure scenario description is intended for use by gamemasters. In the interest of fairness and maximum enjoyment, do not read this material unless you intend to act as gamemaster for this adventure!

## THE ADVENTURING GROUP

This adventure should be undertaken by the crew of a Constitution-class starship (either the U.S.S. Enterprise or one of her sister ships). Since most of the action takes place on board another ship of this class, use of the deck plans for the Constitution class is required. These plans, in miniature form, are part of the boxed set of **STAR TREK: The Role-Playing Game**. They are also available, sized for counters and 15mm miniature figures, separately from FASA. Use of the larger, more detailed plan set is helpful for combat situations.

**NOTE:** The ship involved in this scenario can be any Constitution class vessel. Where the text refers to the Enterprise, substitute the ship you are using. Certain aspects of this adventure will have special meaning for the Enterprise crew, however. If your campaign has established the U.S.S. Hood as your base of operations, feel free to change the trapped ship's name as well.

## BACKGROUND

The captain of the U.S.S. Enterprise receives a set of sealed orders at Starbase 11. He is instructed to take his ship and proceed "with all possible haste" to a set of coordinates. Upon arriving, the sealed orders are to be opened and followed to the letter. The coordinates given do not correspond to any known star system, and are deep in unknown space. Actually, the coordinates do not refer to a single point, but to a course that the Enterprise must match at a certain place and time, leading the captain to believe that they are being sent to intercept some sort of moving object.

The Enterprise must proceed at Warp 6 for 5 days to reach the coordinates provided at the correct time.

## DEEP IN UNKNOWN SPACE

As the coordinates in question are approached, long-range sensors indicate the presence of a highly unusual gravitational anomaly. If the captain is a non-player character, he will open his sealed orders at this point, but leave it up to the captain what to do, if he/she is a player character. If the orders are opened, give the information in that section to the captain. If not, the helmsman must attempt a saving roll on the Starship Helm Operation skill. If the roll succeeds, the ship is barely brought into the

proper course, despite a rapidly shifting set of gravitational stresses and a strange rotating magnetic field. If the roll fails, the coordinates are missed by a fraction because of the unexpected gravity shifts, and the ship takes damage from the unknown forces. (If the sealed orders were opened immediately, the captain is warned about what she/he is facing, and the helmsman needs make no saving roll).

If the ship takes damage as above, locate damage in a manner similar to ship combat. Roll 1D10 on the following table:

- 1 = Forward
- 2 = Starboard/forward
- 3 = Starboard/aft
- 4 = Aft
- 5 = Port aft
- 6 = Port/forward
- 7-10 = Roll Again

The ship takes damage, as if it had been hit for 1 point of damage on this side with shields **DOWN**. (Whether shields were really up or down is unimportant, as they do not protect against gravity stresses).

Make one damage roll as above for every 10 points (or fraction thereof) the Helm saving roll was missed by. Thus, if the helmsman has a Helm skill level of 45, and rolls a 72, make three damage rolls. Once the damage rolls are made, the helmsman is able to bring the ship around precisely where it should be, slipping into course and speed as provided by Star Fleet.

The crew will find that they are now trailing a true astronomical wonder. A pair of neutron stars — dense spheres of neutronium — orbit each other in a whirligig dance. As they rotate, they are moving rapidly throughout this previously unexplored section of the galaxy. Indeed, their projected course will not take them any closer to the Federation, nor anywhere near any other major spacefaring civilization.

The whirling neutron stars are responsible for the wild gravitational fluctuations. Now that the phenomenon is known, the helmsman can easily correct for the changes, especially at this distance. Harder to handle are the shifting lines of force of the stars' magnetic fields, which will jam all subspace radio transmissions and make sensor readings difficult. Despite this, long range sensors get a fuzzy reading indicating a ship may be trapped in the center of the spinning system itself. At this point, if the sealed orders have not yet been opened, they should be examined by the captain. The text of these orders is noted below.

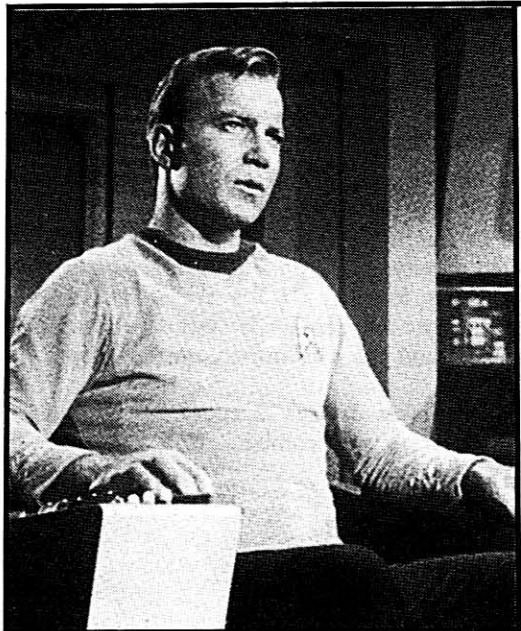

STARDATE 7662.4  
UNITED FEDERATION OF PLANETS  
STAR FLEET INTELLIGENCE CORPS

TOP SECRET

TO THE CAPTAIN OF THE U.S.S. Enterprise:

On Stardate 7636.2, the starship U.S.S. Hood was ordered to your present coordinates on a top secret mission to investigate the astronomical phenomenon of two rotating neutron stars, first reported by a Federation scout in this area. Using instruments provided to them by Star Fleet Intelligence, plus their own ship's sensors, they were instructed to obtain information about the magneto-gravitic structure of the system, and how it affected the fabric of space in this area.

It is believed by a number of Federation scientists that such a series of magnetic/gravitic effects can create — under the proper conditions — a time/space interphase, such as that experienced by the starship U.S.S. Enterprise near Tholian space on Stardate 5693.4. DESIGNER'S NOTE: See the episode *The Tholian Web*. A greater understanding of this effect is considered to be of vital importance.

At some time during their observations, the Hood became caught in the gravitational field of the system and was drawn in. Before they were trapped, they managed to launch a message buoy. The buoy transmitted the news of their plight by subspace radio once it was out of the system's magnetic field. Security restrictions made it impossible for them to send back their gathered data in this manner, however.

The crew of the Enterprise is instructed to move the ship close enough to the rotating stars to locate the Hood. If possible, they are to beam aboard a party of volunteers to recover coded records from the Engineering, Medical, Life Sciences, Physics and Chemistry departments, plus

important summaries to be found in the possession of the ship's captain. Computer codewords for retrieval of this Top Secret data are provided with these orders.

According to the data provided with the Hood's message, the ship was likely to be drawn into an interphase area believed to exist at the center of formations like the one they were observing. The Hood was provided with drugs devised to combat the madness-inducing effects of close proximity to an interphase area, but the Hood reported that such drugs were proving to be less effective as duration close to the phenomenon increased. Thus, though survivors on board the Hood are unlikely to exist, such survivors are to be considered dangerous and are considered expendable.

Individual crew members of the U.S.S. Enterprise are also considered expendable, but the information MUST be retrieved and returned to the Intelligence Corps officer at Starbase 11. Thus, the survival of the Enterprise is of primary importance, as it is the only capital ship capable of such a mission presently in the quadrant and near enough to help.

Once the information is retrieved, the Hood is to be destroyed by the Enterprise, for security reasons.

Again, drugs for combating the detrimental effects of interphase have been provided in sealed containers in the Enterprise's cargo holds. These drugs should be administered to all personnel aboard, with heavier doses given to the volunteer party aboard the Hood. We warn again that the drugs begin to lose effectiveness after a time, so haste in accomplishing the mission is advised.

Retrieval of the necessary data is considered the top priority by this office. Details of the mission are to be provided to the crew only on a "need to know" basis, at the discretion of the captain. The retrieval party is to be all volunteers, but it is recommended that at least one medical officer, one astrophysics specialist (perhaps the science officer), and one engineering officer be present. In addition, security regulations require the presence of at least one security officer above the rank of Lieutenant J. G.

(signed) Admiral J. L. Kilgore  
Star Fleet Intelligence Corps  
Starbase 11



## FILE INFORMATION

The captain and members of the landing party will certainly wish to consult the files regarding the Enterprise's earlier experiences with an interphase phenomenon. (The episode *The Tholian Web* presents this mission's results). The following notes can be called up from the computer files, for use in briefing the characters (particularly if they are NOT Enterprise crewmen already familiar with the situation). Players who are not familiar with the episode in question will especially need to see this information.

**INTERPHASE:** This phenomenon has been described as a "flaw" in the fabric of space-time. It is a pocket outside of known reality — perhaps a doorway to alternate universes. Such an area has only been closely observed once, in an area on the fringes of Tholian space, by the crew of the U.S.S. Enterprise. At that time, the interphase area was in deep space, apparently a natural phenomenon. It is believed by Star Fleet astrophysicists, however, that such an area could be created artificially by rapidly shifting gravitic and magnetic fields of great strength.

When in the close proximity of an interphase area, the synapses of the brain seem to be subtly affected. Sensory distortion results after a time, leading eventually to madness, with the victim most often becoming violent — even homicidal. Drugs have been developed that inhibit this effect, but these drugs lose their effectiveness after a time.

Within the actual interphase area itself, an object is caught between universes. Any use of large amounts of power (including the use of beamed weaponry and warp drives) disturbs the interphase area, and may cause objects to shift back and forth randomly between universes. Such objects may appear and disappear at random, or appear only as ghostly images.

## APPROACHING THE HOOD

As expected, the ship trapped at the center of the interphase area is indeed the Hood. Sensor readings taken at the time of the Enterprise's arrival indicate that it shifted momentarily into the "other" universe beyond the interphase momentarily at that moment. (This was probably due to the effect of the Enterprise's warp engines). If not further disturbed by warp power or weapons fire, the computer projections indicate that the Hood will remain stable for 5 hours before shifting again. This gives the Enterprise party a "window" in which to operate.

To beam over a party, the Enterprise must approach closer on impulse power only. At the moment of closest approach, there will be one chance to transport. (Therefore, the party can be no larger than seven people — no more can be transported by one location at once safely by the more reliable standard transporter). The Enterprise then withdraws outside of transporter range for three hours. At the end of this time, it will make a second close pass, beaming aboard the party. Communicators will not penetrate the magnetic interference to contact the ship (though they should work for communication among

landing party members on the Hood), so the characters must be gathered at one predetermined location (the bridge is suggested) for beam up at the end of three hours.

If the rendezvous is missed by one or more, the Enterprise will have time for one more pass one hour later, beaming up any stragglers who have reached to drop into the other universe, never to return. By that time, the Enterprise should have retrieved the landing party and set course for home.

Each approach attempt is tricky, requiring split-second timing and great skill at the helm. Gravitational gradients shift quickly, and sensors are of limited help in compensating for these gravitational shifts, due to magnetic sensor interference. For each approach, require a saving roll as before on the helmsman's Starship Helm Operation skill. Failure means the helmsman has misjudged the approach slightly. Damage is taken from gravitational stress. Roll once for damage as before, as if struck by a weapon for one point of damage with shields down. If the damage result calls for bridge personnel to be shaken about, consider that the transporter room people were shaken as well. No attempt to transport can be made in this case, and it will take 30 minutes to reposition for another try.

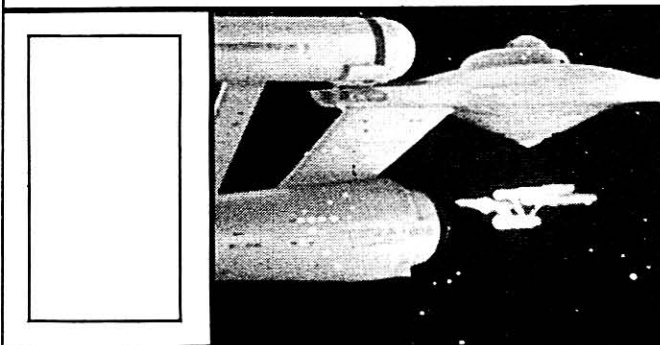

## THE RETRIEVAL PARTY

Sensor readings are fuzzy, but they indicate that the Hood is basically structurally sound and has an atmosphere. There is no power being produced by the warp engines, but it is possible that impulse power will still be running lights and routine services. Considering that the Hood has been here at least 8 days, it is unlikely that any survivors will be encountered. To be on the safe side, however, the captain (or whoever commands the party) will certainly wish to issue phasers — perhaps Phaser II.

The information to be retrieved will be in the ship's computer, but each part can only be accessed at one certain location, with a special set of codewords provided with the sealed orders. These locations are:

- Special Studies Lab - Deck 3 - Primary Hull
- Primary Hull Engineering Section - Deck 6 - Primary Hull
- Main Medical Lab - Deck 7 - Primary Hull
- Main Engineering Section - Deck 16 - Secondary Hull
- Botany Section - Deck 18 - Secondary Hull

Before the retrieval codewords will work, however, a special override program must be initiated from the bridge computer station. Thus, it is probably easiest if the retrieval team is beamed to that location. This, of course, is entirely up to the team's commander or the captain.

In addition, the team is to retrieve the summaries and personal notes made by the Hood's captain. Security procedures would call for this information to be stored separately from the computer, on a memory ship which would most likely be kept in the safe in the captain's cabin on deck 5 of the primary hull.

## THE WRECK OF THE U.S.S. HOOD

When the retrieval party materializes, they will find the Hood a darkened, empty derelict. Only the emergency lighting systems are operating, making the rooms and corridors gloomy chambers. Most rooms are a shambles of broken instruments and corpses can be found in the corridors. Almost all have died violently. Crewmen and women will be found murdered — by each other.

It should become apparent to the party after visiting a few areas that there are quite a few less bodies than there should be! Don't up and tell them this — let them infer it from your descriptions. For instance, if they beam in on the bridge, point out off-handedly that only a few bodies are there. Corridors will have a body or two here and there, but most staterooms and small areas will be empty. If someone in the party gets suspicious and starts paying attention to the number of bodies, you may then confirm that the ship does seem to be somewhat emptier than it should.

When the players start to move about the ship, they will soon learn what happened to the crewmen who are missing. Each time a new major area is entered (like a lab, engineering section, bridge, etc.), or every 5 minutes of real time, roll 1D10, and consult the following table for results.

1-5 Nothing happens

6-7 A member of the party (determine randomly) glimpses movement out of the corner of his/her eye. Investigation reveals nothing. After a few such incidents, characters will begin to make out momentary flickers of ghostly images of people.

8 A ghostly image appears in full view, lasting for several seconds before vanishing. Each image should be of a different person or group of people. The people are wearing Star Fleet uniforms and seem to be in distress or torment. Groups may be fighting among themselves. Use your imagination and give vivid descriptions. Some of the "ghosts" may see and react to the party (violently), but they can neither be touched nor heard - only seen.

9-10 Another ghostly image (or images) appears. (Roll 1D10-5 for the number of figures, with a minimum of one). They can see and react to the party.<sup>1</sup> They will flicker momentarily, then suddenly become solid! The party will be immediately attacked by the insane crewpersons! (See notes on combat situations below . . .)

The best approach is NOT to roll the first few such encounters, giving the characters a chance to build some caution (and get very, very nervous!) Let them notice a couple of movements (as in 6-7 above) first, then actually see a figure clearly (as in 8 above) before starting to roll randomly. If the gamemaster desires, he/she can simply make up ALL the encounters as they become dramatically desirable. There is nothing inherently unfair about this approach to these encounters IF AND ONLY IF the gamemaster realizes that her/his aim is NOT to kill off players, but to give them a challenging, exciting game! If you have any doubts about your motives, use the random table.

The special locations where information must be retrieved from computer terminals are noted below, along with little problems they may encounter in certain areas. Feel free to leave out some of these hazards, if you think they will prove too difficult for your party. If things are going too smoothly, devise additional hazards to restore game balance.

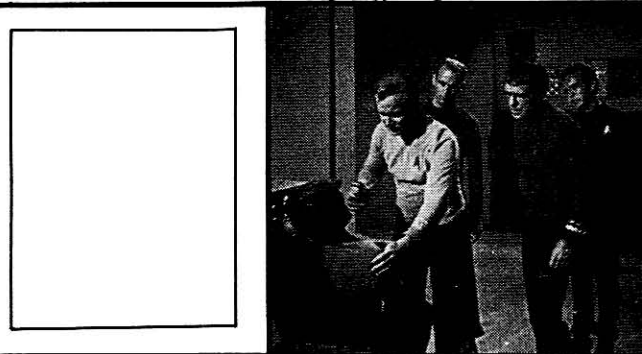

## SPECIAL LOCATIONS — U.S.S. HOOD

**TURBOELEVATORS:** These aren't working anywhere on the ship. There's nothing wrong with the systems, but one insane crewman accidentally threw the main switch-off in the elevator repair room on deck 6. (The party won't know that, of course, though a cursory examination of the circuitry by someone with the general engineering skill will reveal that the elevators have been turned off, probably in the maintenance ship). The players could go there and turn them back on, and the gamemaster should allow this if they want to do so. It would probably be just as fast, however, to simply use the gangways and stairs. (See notes on moving about the ship presented just after this section).

**BRIDGE:** As stated earlier, there are only a few crewmen here. It looks like those whose bodies remain had a great battle. Consoles have been smashed with heavy objects and bodies are sprawled awkwardly. The computer console at the science officer's station is broken, thanks to a swung chair. If inspected by someone with 10 or above skill level in Computer Technology, it will be found to be repairable. One attempt at a saving roll on that skill may be made each 10 minutes of the game time. Success means the computer is repaired enough to give the codewords that free the other stations to release data when requested.



**SPECIAL STUDIES LAB (D3 PRIMARY):** This is the lab where most of the research was coordinated. There are two dead crewmen here who apparently killed each other. The computer terminal is intact, though. When the information is requested and codewords given, it will be transferred to a memory chip, which will then pop out of a slot. At the same time, the information will be scanned on a small viewscreen. (This will be true at each location where information is requested).

If the players wish to look at the information readout on the screen, it will zip by too fast for detailed reading. They will get the general drift of it, though, and discover the real purpose of the Star Fleet Intelligence Corps' interest in the interphase phenomenon. The intelligence corps intends to use the information in attempts to create an interphase condition under controlled conditions, with an eye toward making a weapon out of it.

An "interphase gun" would be a powerful weapon, indeed, capable of making an entire ship — perhaps a whole fleet — vanish out of space/time altogether! The reasons for tight security are immediately obvious.

**CAPTAIN'S CABIN (D5 PRIMARY):** The door into this area will not open normally and must be cut through with phasers. (This will take about 10 minutes, and will drain one phaser entirely — these doors are reinforced! Of course, there are plenty of phasers around on the bodies of security men and in the armory. It is possible the players will not think of this, and the gamemaster should not point it out if they forget!) Once inside, they will find that the door mechanism has been deliberately jammed from the inside. The body of the ship's commanding officer, Captain Hugo Revere, is slumped in a chair at the computer console, his hand resting on a memory chip near the readout slot.

If the tape is played, it proves to be Capt. Revere's final log entry. He is responsible for the ship still having impulse power for lights and routine systems. He explains how he jammed the door when the rioting got out of hand to protect the main power busses, having observed that the maddened crewmen did not have enough sense remaining to make an organized effort with phaser to cut through the door. He knew someone would be sent to retrieve the data, and saw to it that the ship's power would still be on when they arrived. He further explained that he has taken poison from the sick bay stores, to insure he will not go mad and undo the protective measures he has set up. Revere also reveals the combination to his safe in his cabin, which contains the all-important summaries and other notes on a data chip.

Capt. Revere's last words are especially revealing; "I have performed my duty, as you who listen to this must perform your own. This duty has cost the lives of over four hundred fine men and women — my comrades and friends. I pray that, if this terrible new device is ever constructed, it will be controlled by far wiser men than those who sent us on this god forsaken mission in the first place. Let their ghosts be your conscience. The best of luck to you, wherever you are. Carry out your orders. Revere out."

The information can be retrieved from the computer with no difficulty, dispensed as a data chip. If scanned, this data reveals a lot of technical information, but nothing particularly interesting.

**MAIN MEDICAL LAB (D7 PRIMARY):** This is a particularly gruesome area. Throughout sick bay, doctors and nurses have turned surgical instruments on each other or on themselves. The information in the computer is intact and can be retrieved as a data chip and scanned. In his report, the medical officer notes that he is doubtful current ships could carry adequate shielding against the effects of the interphase to make its use as a weapon practical. A personal note appended to the information soundly denounces the whole idea as "stupid and totally without merit", and "contrary to everything Star Fleet stands for".

**MAIN ENGINEERING SECTION (D16 SECONDARY):** This place is a total ruin, with warp power completely shut down and consoles smashed beyond repair. Miraculously, the computer console itself still works, albeit a bit sluggishly. A saving roll on the computer operation skill must be made successfully to get the information transferred to a chip. (If the first attempt fails, an attempt may be made every 10 minutes until success is gained).

If the information is scanned, it will reveal the chief engineer's observation that the power required for such a weapon is far beyond what any ship currently existing can produce, approaching that generated by a major industrial world.

**BOTANY SECTION (D18 SECONDARY)** This is more of a garden than a lab, but there is a small terminal where the information can be obtained. Nothing particularly useful will be learned by scanning the data as it is loaded onto a data chip.

## MOVING ABOUT ON THE U.S.S. HOOD

Since the Hood is virtually identical to the ship your player characters serve aboard, there should be no secret about where things are and how to get there. With the turboelevators out, it will take time to get around, but that is all.

The simplest method of playing out the scenario is to lay the deck plans for the Constitution-class cruiser out in front of the players and let them show you where they want to go. The CHARACTERS know quite well where any major section of this ship is located, even if the PLAYERS are new and not familiar with the plans. Help them out when they ask directions to a particular place common to all ships of this type. For specific data about things unique to this ship, they may want to consult any computer terminal for information, but don't help them unless they do.

Have them show you the route they will take to go from place to place, but don't make them move it out in combat turns until you determine something unusual (like a combat encounter with crazed crewmen) is about to occur. Let them examine the maps as much as they want — this is a familiar type of ship, and not a labyrinth.

## COMBAT ENCOUNTERS

When ghostly figures start showing up, the players should start to worry. Even so, the first time one becomes solid and attacks, they may be surprised. Crazy crewmen will not use phasers and such, or exhibit any coherent strategy or cooperation. Still, they will fight in a "berserk" fashion, ignoring normal rolls for unconsciousness until the unconsciousness threshold is passed.

For simplicity's sake, don't try to roll up statistics for each crewman or crewwoman that pops up. Instead, use the following statistics, which have been modified to allow for berserk rage and lack of intelligent strategy.

STR 70 END 50 INT 20 DEX 50 CHA 30 LUC 40 PSI 0  
PERSONAL COMBAT (unarmed): 20

Some crewmen will pick up heavy objects, others will just go into hand-to-hand combat. Note that they are likely to attack each other as well as the party, although the more unfamiliar party will be the main target.

Though the Hood is primarily crewed by humans, throw in an occasional non-human crewperson, modifying the statistics above using the racial modifiers noted in the section of the rules on creating characters.

Each time phasers are used on board (against crewmen, or as a cutting torch) roll 1D10. On a roll of 1 or 2, the ship lurches and flickers in and out of existence momentarily, indicating that the use of phasers is disturbing the interphase. No other effect is created by the use of phasers, but the FEAR of disturbing the interphase will probably cause players to limit their use of phasers, evening the odds somewhat against crazy crewmen.

Also remember that crewmen can phase OUT of this universe as easily as IN! For each turn of combat, roll 1D10 for each insane crewman. On a roll of 1, that crewman flickers and fades away! (The truly vicious game-master could require players to make a LUC save each time they disturb the interphase with phaser fire. Failure would cause that crewman to flicker in and out of the "other" universe beyond the tear in space-time. A second LUC save attempt would have to be made immediately. If that one succeeded, the player remained in this universe. If it failed, the player was lost into the other universe. This is not recommended by the designers, though it is a realistic possibility, as we dislike killing off player characters through no fault of their own. Use your own judgement, based on how loud your players are likely to howl if an important character is lost.

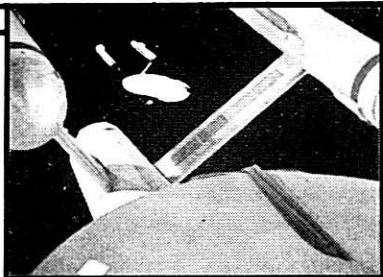

## ENDGAME

Once the information is gathered from terminals all over the ship, the characters should meet in the pre-designated area for beam up on schedule. While they are waiting for pickup, throw one last encounter at them.

The ship flickers briefly, and suddenly a number of crewmen blink out of nowhere. (Choose the number of attackers for play balance. There should probably be about the same number as there are members of the retrieval party). These crewmen attack, very near to the time for pickup.

Let the battle continue for a few turns, then beam the characters aboard. Any insane crewmen at the retrieval site will also be beamed aboard. These people are still insane, but no longer subject to being drawn away into the other universe. They must now be restrained (giving you one last battle in the Enterprise transporter room!), but they can probably be cured.

The beaming back of the insane crewmen may lead characters to think about ways of rescuing others. It might be suggested by a non-player transporter technician that another pass be made (if there is time), with a multi-person emergency transporter used on wide-band acceptance to beam aboard any living beings it can grab. The procedure is dangerous, but the crewmen aboard the doomed ship have nothing to lose.

If the procedure is attempted, the Enterprise must take the same risks outlined in the section of the scenario dealing with the beam-down pass. At the critical moment, one 22-man transporter is activated. Roll 2D10+2 to determine the number of life patterns picked up by the transporter, then attempt a saving roll on the transporter operator's Transporter Operations skill level for each pattern. Each roll that fails means that crewman was lost in transit, but each success brings one crewman aboard. (I hope someone in the party thought to provide security personnel to restrain so many insane crewmen).

The use of so much transporter power so near the interphase area will affect the interphase, however. The Hood will flicker in and out of this reality several times, then vanish forever. Still, some may be saved. Star Fleet expected no survivors, but perhaps the Enterprise can beat the odds once more, bringing back the information, and a few crewmen — ghosts to haunt the conscience of the Star Fleet bureaucracy.

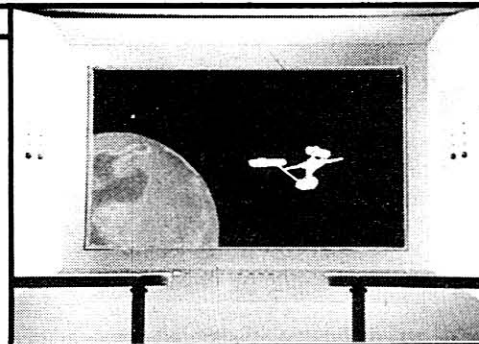



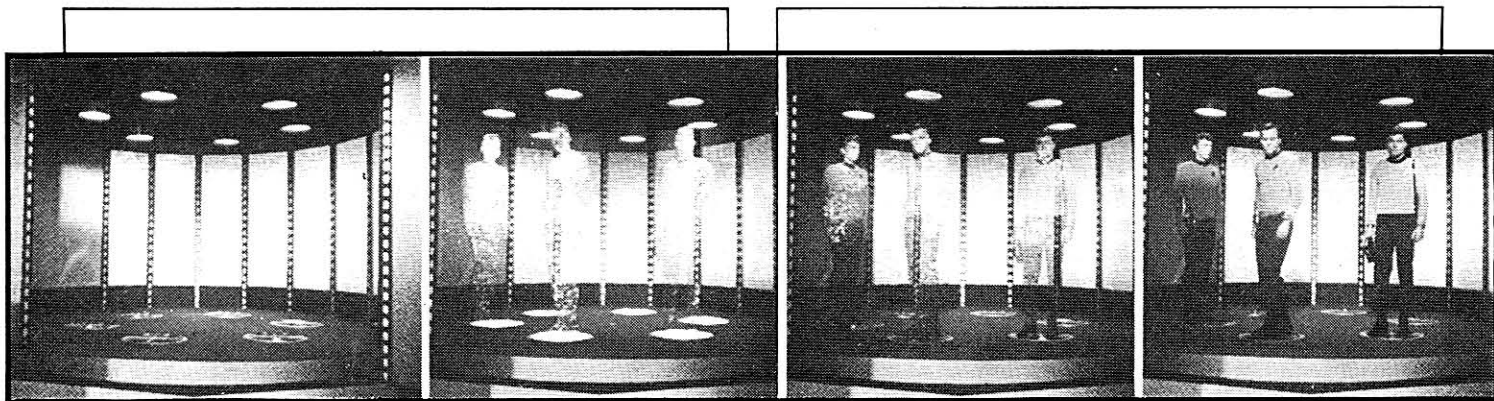

### DESIGNER'S NOTES:

First, a quick note about interphase, environment suits, and *The Tholian Web*. In that episode, Kirk survives being shuttled back and forth in space-time only because he is wearing an environment suit. Presumably, in the "other" dimension Kirk is trapped in for a time, there is nothing but vacuum. McCoy has to give him Tri-Ox to revive him when he is finally beamed aboard.

So why are my ghostly crewmen still alive? The honest answer is "because it makes the game more interesting that way". Frankly, anything else detracted from the atmosphere (excuse the pun) of the scenario. It was a purely pragmatic decision on my part as a designer. If this minor point spoils your enjoyment of the game, I apologize. Feel free to rework in any logical way you wish.

I can think of several ways the crewmen could have survived. Perhaps the other side of this particular interphase area intersects a planet with atmosphere. It is also possible that the crewmen do not actually fade entirely into the other universe, but are held "in transit" (such as is possible with the transporter), not needing to breathe. (This would make it similar to the "corridor" in which Lazarus traps himself and his double in the episode *The Alternative Factor* . . . There! That provides me with a precedent from STAR TREK lore after all!) It is also quite possible that physical laws do not work the same on the other side of this "tear in space-time".

If it bugs the players, explain it in one of these ways, or make something up on your own. I really felt, in this case, that the story was more important than the scientific point. So sue me — STAR TREK did the same thing any number of times.

\* \* \* \* \*

This scenario grew out of my desire to express my feeling that any bureaucracy, no matter how benevolent, can be led into colossal blunders if they allow people to be subordinated to the pursuit of singleminded goals. No doubt in the enlightened world of STAR TREK's future such tragedies will be few and far between, but they will occur. When they do, it will take the bravery, resourcefulness, and compassion of the individual commander and crewman to salvage whatever she or he can from the waste of bureaucratic foolishness.

Perhaps this theme is too weighty for an adventure game, but *Ghosts of Conscience* is also a good adventure without consideration of its moral. The television series STAR TREK was not content to merely entertain. Gene Roddenberry and company attempted to reflect how the concerns of today's men and women would affect the people of STAR TREK's tomorrow. Therefore, we occasionally incorporate these concerns into the game, to remain true to STAR TREK's ideals.

Players are likely to get pretty upset with Star Fleet over this whole thing, particularly since the evidence they are gathering (if they bother to watch when it displays) indicates that the interphase effect will not make a practical weapon in any case. (Honestly, anyone with a little sense could have told them that. This whole thing must have been planned by a very short-sighted bureaucrat. Such things DO happen, however, even in the finest organizations).

If Kirk is involved, he would most likely do his duty and turn in the information — but he would raise an incredible fuss, perhaps jeopardizing his career in the process. With his clout due to his phenomenal record, he would be likely, in the end, to win out, and probably could at least get the idiot bureaucrats who planned the mission demoted to apprentice deck-scrubbers.

Spock, who abhors any unnecessary endangering of life, would be even more profoundly affected, but he would approach things from a logical Vulcan standpoint. It would not be out of character for him to take matters into his own hands and find an eminently logical way to have the evidence accidentally destroyed before it could be turned over to the Fleet.

Let your players work out what they want to do on their own, but this designer won't be disappointed if they find a way to thwart Star Fleet's intentions without violating their sense of duty or getting caught violating orders. (They'd best be very careful if they want to avoid a court-martial. But if they decide to risk it, give them a reasonable chance to get away with it).

If your players take this adventure personally, and react with indignation and caring to the loss of the U.S.S. Hood, this designer will feel he has succeeded — at least a bit — in an attempt to be true to the ideals that make STAR TREK a legend.

Guy W. McLimore, Jr.

# Again, Troublesome Tribbles

This scenario, though designed for the familiar U. S. S. Enterprise crew as player characters, can be adapted easily for use by an Star Fleet crew. It is most fun, however, when the situation develops around Kirk, as it gradually dawns on him what is happening – again!

In this adventure, the crew of the U. S. S. Enterprise will meet some old “friends” while performing an otherwise routine mission. Gamemasters and players familiar with the STAR TREK episode *The Trouble With Tribbles* by David Gerrold will find the most enjoyment here. Familiarity with the animated series episode *More Tribbles, More Troubles* by Gerrold is also desirable, but not necessary.

Gamemasters are encouraged to have fun with this one. “Role-play” the non-player characters and ham it up to the hilt! This scenario is strictly for fun (though it is quite possible for player characters to be injured or even killed, if they aren’t careful)! If the gamemaster and the players really get into their characters, this can be a role-playing experience to be long remembered...

## BEGINNING THE ADVENTURE

Give the following transmission record to the communications officer for relay to the captain. (Give directly to the captain if the communications officer is a non-player character (NPC):

TO: Captain James T. Kirk, commanding U. S. S. Enterprise  
(or to whomever is commanding in your campaign)

FROM: Star Fleet Command, sciences division  
Adm Stilak, director

You are instructed to proceed to Federation Genetics Research Station 17 on planet Aleph III in your patrol area. GRS17 is being closed by order of this division, and the Enterprise is instructed to inform station personnel and aid them in closing the station. Three days are allotted for completion of experiments in progress and collection of data, samples, personal belongings, etc. After this time, the station is to be closed and personnel transported by Enterprise to Star Fleet offices on Deep Station K-7 for reassignment.

Planetary conditions on Aleph III prevent the direct reception of subspace radio messages (or even orbit-to-ground communication) by base receivers. Thus, Enterprise’s visit will be the first word base personnel will receive about the move. Accordingly, proper identification codes and explanations for the base administrator and staff have been provided along with this transmission. This information is now in the Enterprise ship’s computer, to be delivered to base personnel.

Enterprise is warned that Aleph III’s environment is rated “hostile” in early survey records. No environmental suits are necessary on planet’s surface, but the thin environment calls for the use of life support masks when outdoors.

Aleph III has a non-native sentient population, but certain lifeforms possibly harmful to landing party personnel are present. Necessary precautions should be taken to protect the landing party.

GRS17 is located in a mountainous area containing large amounts of magnetic ore. This ore jams most subspace and orbit-to-ground communication attempts and makes transporter travel into the area extremely hazardous. Use of shuttlecraft to transport the landing party is strongly suggested. A shuttle landing area was prepared when the base was established, and coordinates for this area have been provided to your ship’s computer, along with this transmission. Enterprise personnel will then have to walk or use small conveyances to reach the base itself, about 1.5 km away. (The base structure and non-essential materials are to be left behind by Enterprise, for later pickup and removal by Star Fleet transport vessels.)

Aleph III is three days away at normal cruising speed of Warp 3, when the message is received. No other pressing business is at hand, and the gamemaster should avoid presenting the ship with any reasons for delay or reasons for undue haste.

## PLANETARY SITUATION

The Aleph star system is located in the Organian Treaty Area near Klingon space. (This fact should be mentioned offhandedly by the gamemaster, with no particular emphasis, to avoid tipping the players off to possible Klingon intervention).

Upon arrival at the planet itself, the Enterprise will discover that the situation from orbit is much as they were led to believe by Star Fleet Command. The planet is a class “M” world with a thin, but breathable, atmosphere. Much of the planet is pretty rough country, however, with the base planted atop a rock mountain in very rough terrain.

As promised, communication with the base is blocked by magnetic interference. Transporter personnel will recommend that transporters not be used except in direst emergency due to the interference.

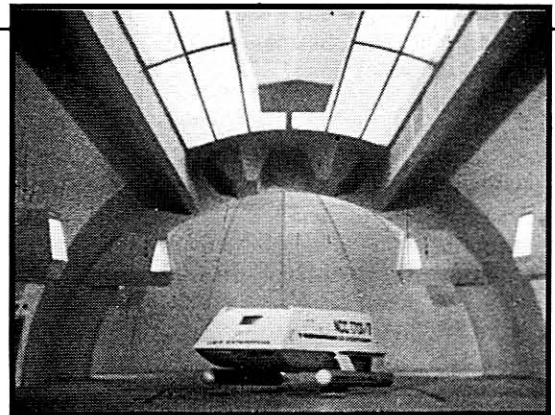

AGAIN, TROUBLESOME TRIBBLES  
(with thanks to David Gerrold)



(If at any time the transporters are used to beam something or someone down, a saving roll must be made by the transporter operator on her/his Transporter Operational Procedures skill score. Such a roll is made at a +50 penalty! If the roll fails, no transport can be made. On a second attempt, if the roll fails, all equipment and personnel have their patterns scrambled. This will cause equipment to be destroyed and people to be grotesquely and painfully killed! The gamemaster should discourage use of the transporter if at all possible, but the final decision is up to the players. Do not tell them the exact modifier applied to the saving roll, but let them know that it will be an extremely high one. For more information, see transporter rules.)

It is about 1.5 km from the landing site noted to the base. Topographical sensors indicate a rough path from the site up onto the mountain where the base lies. The site lies due west of the lab, at the foot of the hill upon which the station is constructed. The terrain is rough, and suggest travel on foot, since no conveyance rugged enough for the terrain can be fit into a shuttlecraft. (The trip on foot should not take more than 1 hour, based on the terrain, if a leisurely pace is taken.)

There are two shuttlecraft available to carry the party to the landing site. Each can carry a maximum of seven people, but only one pilot is required. Any person with a Shuttlecraft Pilot skill of 10+ can make a normal flight (like the one to the prechosen landing site) with no trouble. There are reported to be 9 members of the research station party, so you will no doubt have to return to the ship in more than one group, even if both shuttles go to the surface.

Landing party composition is up to the Captain, but Star Fleet recommendations indicate a need for the following personnel:

- 1) Sciences specialist-genetics to help complete experiments and accumulate data
- 2) Engineering specialist to help close down the station's power plant and physical systems
- 3) Security team—two or more specialists armed with Phaser II for protection against native animal life
- 4) Medical officer to check on physical/mental well-being of station personnel

Any others assigned to the landing party are up to the Captain. It should be remembered that the party will be out of communication with the ship for the three days it will take to close the station. The station will have facilities and supplies enough to accommodate the party, but it will be impractical to return to the ship without very good reason, so any special equipment needed should be taken on the first trip.

(GAMEMASTERS: Be sure and warn the players again that standard communicators will not work from planet's surface. It is theoretically possible to beam down an item, but because of magnetic interference, it is extremely dangerous to try it with vital equipment or living organisms. Beaming up is impossible, as there can be no clear signal from the surface to lock in on. Even sensors may be affected, as long as the ship is in standard orbit over the planet's main continent, with the magnetic mountains.)

## TOPOGRAPHIC SENSORS AND LANDING SITES

If topographical sensor readings (readings of the general ground layout) are taken of the general area near the laboratory station, require a Starship Sensors skill roll with a +30 penalty, due to magnetic interference. A successful scan around the general area, however, will reveal a second possible landing site (see map). The second site is east of the lab, and a bit farther away. The path up to the station is more circuitous, but better maintained. (Better time can be made on the better road, but it is a bit farther. It will take about the same amount of time this way, but be a bit easier going for the party in terms of terrain. See the map for AP penalties, etc.)

The captain may choose to use the second site instead of the one Star Fleet recommended. (Actually, the second one was discovered and prepared more recently by the station personnel themselves, and is the one the supply vessel regularly uses, but the players have no way of knowing that). Because no prepared coordinates have been provided for the second site, a skill roll on Shuttle Pilot skill should be secretly made for each shuttle landing at the second site. (This is due to the magnetic interference causing problems with the shuttle sensors). If the save is failed, the landing is a bit rough. No one will be hurt, but that shuttle will suffer damage. If inspected, any competent pilot will recognize a damaged power nacelle. This shuttle will be unable to take off without at least 4 hours of work (and a successful saving roll thereafter) by someone with the Shuttlecraft Systems Technology Skill. Of course, the players should be told nothing beyond a reminder that landing will be a bit trickier at the second site, due to the interference.

## ARRIVAL BY SHUTTLE AND FIRST ENCOUNTER

The shuttle trip will be uneventful (except for the landing at the second site, if saving rolls are failed). Upon disembarking (remember the need for life support masks in the thin air), the players will find a hilly, rough landscape with outcroppings of rock and growths of scrub vegetation. The disturbance of the shuttle's landing will scatter any animal life in the immediate area, but a tricorder sweep will detect various smaller life readings in the area. See the detail map of the appropriate landing site).

The site itself is just a cleared area of bare soil, with most of the large rocks cleared away. Around the edges are rockpiles scrub vegetation, and some small life forms, if tricorders are used for readings. If the second site is chosen, a small space cargo vehicle will be present at the site. (See information below -- the *Chameleon*).

If crew members investigate the life readings, they will find TRIBBLES among the bushes, contentedly nibbling grass. (How does a tribble nibble? Ask one next time you find one...) If they are familiar Enterprise characters, or have encountered tribbles before in your campaign, they will of course recognize them immediately. If not, just describe them as "small round creatures covered with sleek fur, possessing no discernable head, tail or appendages." Players familiar with STAR TREK will catch on immediately.

The tribbles, of course, are harmless and will immediately grow fond of anyone who picks them up, strokes them, feeds them, etc. There are tribbles all over the place. If the bushes are searched, hundreds can be spotted near the landing site. (If the players search very long, roll an encounter from the appropriate table below.) Once they recover from their shock at the unexpected shuttle landing, the tribbles approached by the party will resume a contented purring.

No other life readings are immediately noticeable, but the players will note that tricorder readings are sketchy and unclear, due to magnetic interference. All readings are taken with +30 penalty to the required saving throw throughout this adventure.

### THE CHAMELEON

If the players arrive at the second landing site, having detected it from orbit, they will find a small cargo vessel has already landed there. (There is plenty of room for all the vessels, even another shuttle or two). The ship is recognizable (on a successful saving throw on INT by any Star Fleet officer) as a common type of scout vessel, but it has been modified heavily. (See plans below for more details.) Immediately noticeable is the addition of a belly pod, presumably for cargo, and an oversize sensor dish. It bears no registry number. (If asked about this later, Cyrano Jones, the ship's owner, will claim it was "just painted" and he "hasn't had a chance" to restore the registry numbers. This is patently, and obviously, untrue, as the ship's not-very-attractive coat of greenish-brown paint is worn and old.)

The ship has a set of cargo doors on the pod and a smaller airlock door on the upper deck. There is no ladder up to that door. Both doors are locked with some sort of electronic locking device.

If the party is curious enough to consider breaking in (and they really have no legitimate excuse to do so), they must either electronically pick the lock or burn their way in with a phaser. The latter way is faster, but not as easy as it looks. The cargo doors are reinforced, and it will take a phaser on Heat setting 5 minutes and 20 power points to burn open. (This will totally drain a phaser I, and seriously deplete a phaser II.) A door thus damaged can be fixed, but it will take 2 hours to do so.

Burning in with the Disintegrate setting is a bit faster, but it will take three shots to open a man-sized hole. A door so damaged cannot be fixed without a major work detail, thus making the door unable to hold pressure. The cargo hold is already down to planetary normal pressure.

The upper airlock door (if it can be reached) is not quite as tough, requiring only 12 points of drain on the Heat setting to burn out the lock or one Disintegrate shot to remove the door entirely. Both the inner and outer doors must be damaged to get inside, however, and this will reduce the interior pressure, rather violently, to the lower pressure level of the exterior. Probably nothing will be damaged, but the outrush of air will probably knock down anyone standing in the airlock when the second door is breached. (DEX save required to remain standing. If someone falls, and fails a subsequent LUC save, he/she may well

fall out of the airlock entirely! The drop will do 2D6 damage, if you're feeling nasty.) It's not really all that much of a pressure change, and won't affect anyone who has anticipated it and is prepared. If the players don't think of it on their own, let them reap the consequences.

The cargo area is empty at this time, but a search of the control cabin will reveal Cyrano's pilot certificate in a wall niche, and other papers in his cabin would also identify him. If the characters are not Enterprise personnel, don't tell them the name, simply say that it's a human name they don't recognize.

If the control cabin is well searched (for 20 minutes or more) by someone with Helm, Engineering (general) or Navigation skill over 10, make a saving roll on INT for that character or characters. If the save is successful, they will discover Cyrano's added controls, which allow the cargo module to be jettisoned in space and exploded by remote control. (The walls of the cargo module are lined with reflective materials which will act on sensors in a manner similar to radar "chaff", masking Cyrano's escape, at increased speed, in an emergency.)

Other than this, players will learn very little from exploring the *Chameleon*, but it will delay them for awhile, and exploring it will also most likely disable the ship, at least temporarily, so it cannot be later used for escape.

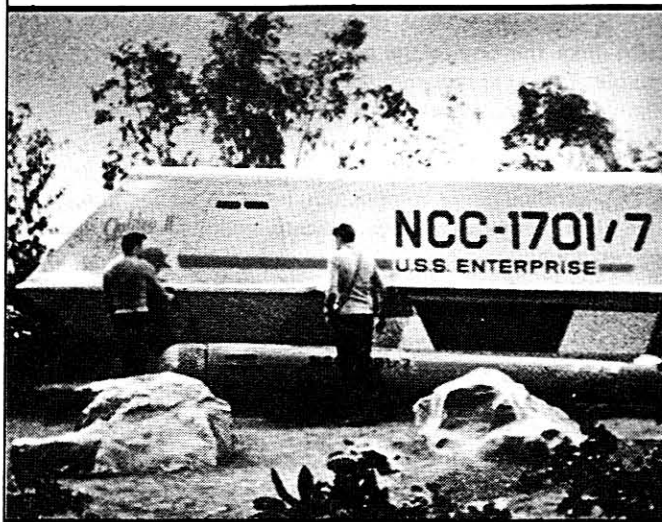

### THE TRIP TO THE LABORATORY STATION

The amount of time it takes to walk to the station depends on which landing site was used, and how cautiously they proceed. If walking at a normal pace, the rough path from the recommended landing site will cost the characters 2 AP per square of travel on the large area map, based on the 15 minute turn used at this scale of movement. Travel on the other path is a bit easier, costing only 1.5 AP/square. AP costs double, however, if the characters are proceeding slowly with weapons drawn and/or tricorders continually scanning for life.

Roll 1D10 for encounters at the end of each 15 minute turn. On the poor path, encounters take place on a roll of 1 through 5. On the better-travelled path from the second landing site, there will be an encounter only on a 1 through 3.



If an encounter is indicated, roll saving throws on the Computer Operation skill for any character specifically designated as doing a continuous general life scan with a tricorder. If such a save is successful, the life form (s) in question will be detected at a range of 250 meters. (See tricorder rules). If no detection is made, roll 1D10. A roll of 1 through 5 means the encounter takes place at close range, with visual sighting at about 30 meters. A roll of 6 through 10 (0) means the encounter is at very close quarters, with the animals(s) not spotted until it/they are within 10 meters!

Either way, take a sheet of standard mapping squares (1/2" squares are fine for use with counters) and place the characters in the center. Note the direction the path takes and place scrub vegetation, large rocks and outcroppings, etc. to your liking. (An example, which you may use for an encounter, is provided below). If the life forms were detected by tricorder, the players will know which direction they are approaching from before the animals enter the map (if they do), and have time to prepare. Otherwise, they don't see them until they are on the map. At very close quarters, some types of creature may be waiting in ambush!

Roll on the path encounter table to determine what type of encounter occurs. The animals are described in an appropriate section at the end of this adventure, including their special hazards and special encounter notes. Resolve the encounter in a normal fashion, with combat (if necessary) taking place at the usual scale of 1.5 meter squares and 10 second turns. Non-combat encounters can be resolved more informally, as the gamemaster desires.



## PATH ENCOUNTER TABLES

ROLL (2D10)	ENCOUNTER
2-3	Hugger Grass (waist-high) (Not found on the well-travelled path . . .)
4-5	False Tribbles (1D10)
6-7	Hummers (1D10-3)
8-9	Blue Dervishes (1D10-5/minimum 1) (Those unfamiliar with this animal who HAVE encountered the Red Dervish must make an INT saving throw attempted secretly by the gamemaster to notice the differences in size and color . . .)
10-11	Tribbles (2D10)
12-13	Hindenburg Rollers (1D10)
14-15	Pop Lizards (1D10-2) (Secretly decide on a square for each to be located in, and give any figure entering that square a 50/50 chance of having it pop up and grab a boot . . .)
16-17	Blade Barnacles (1D10-5/minimum 1) (Make a secret INT save for the highest INT character in the party. If the save is successful, someone saw one move. Otherwise, they just look like rocks unless touched).
18-20	Red Dervishes (1D10-5/minimum 1) (Attack immediately . . .)

## GENETICS RESEARCH STATION 17

Upon arriving at GRS17, the party will find three possible entrances: the two vehicle hangars and the personnel airlock. Those approaching from the east will see the lab vehicle hangar first, while those coming from the west will first find the personnel airlock and general vehicle hangar. All three entrances have intercom buzzers with visual capability nearby on the wall, so which is used doesn't really matter.

At this point, if the gamemaster has not already examined the floor plan and description of GRS17 and the character information on the station's crew, he/she should stop and do so. One character who is present has no character information presented here. That character is Cyrano Jones, pilot of the Chameleon, who delivers supplies to the station. He is a familiar STAR TREK character, and his statistics appear in the Familiar Characters section of the STAR TREK: The Role-Playing Game rules book.

Characters will probably first meet station administrator Kelly and/or Security Officer Navarti. Navarti will offer a tour of the station if the players are interested. (If Kirk is along and truly playing his role, he will no doubt find duties for the other party members and go on the tour with the charming Ens. Navarti alone). If the tour is taken, the characters will learn a lot about the station, including the location of important systems (power plant, life sup-

port), the nature of the work in progress, and the fact that the power plant and genetics labs are radiation shielded "to minimize radiation leakage and protect sensitive equipment." (See the station floor plan and station information section for more data about GRS17). They will also get to quickly meet all of the station personnel.

If, on the other hand, they get right down to business and explain about the station closing down, they will get varying degrees of cold shoulder from the station crew. Navarti is fairly new to the station and will have less reaction. Kelly will be disappointed but businesslike, as will Ostrander and Leon. Evanofski will be extremely disappointed and a bit sarcastic.

The sciences specialists, however, will be very upset. The two Andorians will be especially angry, and will probably at first refuse to cooperate at all, unless the characters apply a bit of diplomacy. A successful roll on Negotiation/Diplomacy will bring about grudging acceptance for a time, but Loctril and his Andorian cohort Trastan will gripe and complain constantly, giving the landing party no end of headaches. Unless watched closely and cajoled along, they will stall progress of the closing as long as possible.

When introducing the crew of the station, mention the presence of the supply ship pilot, but don't name him until he is actually introduced to the landing party. (Bring him around last, if possible, for best effect). Cyrano, of course, will bear no particular ill will toward Kirk — he prefers to let bygones be bygones. He will welcome his "old friends" warmly (assuming this party is indeed from the Enterprise and includes people he has met).

The warm welcome will become indignant if the party has forced entry to the Chameleon and he finds out about it. Indeed, even administrator Kelly will have a hard time keeping his good humor if the supply ship has been gratuitously damaged! (After all, they all know Cyrano well from his many trips here. The station personnel don't know your party, and may already dislike them somewhat because of their mission to close the station!)

Gamemasters should let station crew and landing party members get acquainted and allow the party to settle in without too much fuss. If the party gets semi-favorable reactions from the station personnel, perhaps an offer will be made to take members of the landing party out in one of the station's vehicles the next day for a look around (while remote experiments, live traps, etc. are picked up). Generally, the gamemaster should attempt to instill a (false) sense of security into the group at this time, all the better to surprise them the next morning.

Eventually, things will wind down and the landing party will be shown quarters for the night. The station has limited facilities for guests (one small visitor's bunkroom with three bunk pairs), but with Cyrano already there, a large party may have to move some characters into the (currently empty) sickbay. The station is too small to maintain shifts, so everything is shut down at night, with only a proximity alarm system operating, that will reveal movement of man-size objects within 30 meters (2 squares on the small area map) of the station's walls. Such an alarm would cause the computer to alert security officer Navarti immediately.

## THE KLINGONS ARRIVE

During the night, a Klingon D-7 battlecruiser will enter orbit about the planet, establishing orbit on the far side of the planet from the Federation vessel. This is purely coincidental — the Klingons are unaware of the Federation ship's presence, and the Federation ship should remain unaware of them, since they are in the planet's "sensor shadow".

The Klingons have been sent on a high-risk mission. Imperial Klingon intelligence services have learned of the presence of the station (which is one reason it is being closed down), and some of the research results are known to them. The Klingon government is most interested in the dervish hormone (see Animal Descriptions: red dervish), which is proving to be such a promising stimulant. It is their hope to develop the stimulant for use by combat troops, but to do so they must obtain dervish genetic material (or a couple of live dervishes) and important scientific data kept at the station.

The needed material can only be done by raiding the station itself. Of course, since the station is in neutral territory, such a raid would be an act of war. Thus, the D-7 in question is carried on the Klingon official records as "missing in action". The vessel is allegedly being operated as a "privateer" or pirate vessel, a dodge made famous by the Orions and borrowed by the Klingons for this mission. If things go awry, the Klingon Imperial Council can deny knowledge of the vessel's actions.

Denial of official sanction would leave a Klingon captain in dire straits if caught. Thus, only a captain who was badly out of favor with the Fleet would be "volunteered" for such a risky mission. One such is commanding this expedition — a captain who has been bested to the point of humiliation twice by the Federation in this sector of space. It is his hope to redeem himself in the eyes of the Imperial Council with this mission. Long time STAR TREK fans know this captain well, as does the crew of the Enterprise. His name is Koloth.

Upon arrival in orbit, a landing party will be sent down in a shuttlecraft. To be on the safe side, the shuttle will descend to well within the atmosphere (and the magnetic interference) before circling the world to the landing site where Cyrano's ship is parked. It is Cyrano himself who is unwittingly responsible for many of the Klingon intelligence reports on this station. (He still frequents the K-7 space station bar, and talks far too much about his "friends on GRS17".) Thus, the Klingons know just where Cyrano's usual landing area can be found.

The Klingon landing party will consist of a genetics specialist, a medical officer, and four security officers (one of whom is a pilot). The mission is commanded by Koloth himself. (No risk means no glory...) They will ground at the eastern landing site about dawn.

If they find the Federation shuttle as well as Cyrano's ship, the Klingons will know there are more people here, but not how many. If it is an Enterprise shuttle, Koloth will be extremely pleased, having a personal score to settle as well. Either way, he will disable both ships to prevent escape. This will take a few hours to accomplish, since he will want to do so in a manner that will allow them to be repaired and taken to the battlecruiser later.



If the Federation shuttle is at the other landing site, the Klingons will disable Cyrano's ship, but be totally unaware of the armed Federation party's presence. This could be a fatal oversight for Koloth, who is no master strategist anyway. He will still spend several hours checking out Cyrano's ship, as he expects no trouble and is in no hurry.

The Klingons intend to simply waltz in and take the situation with little resistance. They of course will have to kill all station personnel, eliminate the bodies, and leave no trace of their presence. If they know about the Federation crew, they will plan to be more careful. Either way, plans will go awry, thanks to the disruption of the station's schedule caused by its imminent closing.

### MORNING AT GRS17

On a normal day at the station, a party would not go out to check live traps, etc. until afternoon. With the station's closing, however, administrator Kelly and security officer Navarti will suggest an early start. Maintenance specialist Leon and Zoologist Lane will plan to go out with Cyrano to see how much station equipment he could transport in his ship. They will offer very offhandedly to take one or two landing party members with them, but won't push it. More than two can't go, since they are taking Cyrano's small grav vehicle (see notes in the descriptions of the station's general vehicle hangar) and intend to pick up some live traps on the way back.

The grav vehicle group will arrive in time to surprise the Klingons at the landing site. If no landing party player characters went along, don't bother playing out the resulting combat. Assume Cyrano is the only survivor (having turned and run off with the grav sled at the earliest opportunity). He will return post-haste to the station. If player characters are along, it gets more interesting. Only three Klingons will be outside when they pull up, but the grav vehicles' approach will not go unnoticed. The Klingons outside (Koloth and two security officers) will be under cover and will start firing as soon as the others are in range. Thus, the first hint of trouble the party gets will be the low thrumming of a disruptor bolt. The Klingons will take prisoners if possible, the Klingon med officer trying to keep badly hurt figures from both sides alive.

The smartest thing the Federation players can do is bug out, when faced with a heavily armed landing party. (Cyrano will anyway. He'll take the grav vehicle if possible, but he'll take off on foot if absolutely necessary. Gamemasters are encouraged to let him get away. Otherwise, this scenario turns into a cakewalk for the Klingons, who walk in on a totally unprepared Federation party and usually wipe them out. That isn't the idea of the game! It's no fun at all if the party has no chance to win.

If there is a fight, set up a square grid of the area as shown in the landing site layout presented here, and deploy counters. Remember that the Federation players have no way of knowing how many Klingons are actually around, but a smart player will see the Klingon shuttle and know there can't be more than 7 of them!

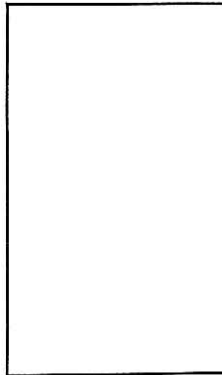

There is a very, very slight chance that the Federation players could get enormously lucky and take the Klingons out right here. The gamemaster shouldn't make it easy on them to do this. If it happens, the characters deserve special commendations and probably promotions. And the gamemaster should be shot at sunrise. A party who stays and fights should lose and quickly, if the gamemaster is playing the Klingons intelligently.

Captured characters will be left in the care of the medical officer at the Klingon shuttle, while the others proceed to the station, right behind Cyrano. If Cyrano got away with the grav sled, he'll be about 30 minutes ahead of the Klingons when he gets back to the station. This gives the group a bit of time to plan. Navarti will suggest that the station crew (except herself) be evacuated to the landing party's shuttle if it is still safe at the other landing site. Whether or not this is done is up to the commander of the landing party, but it will have to be a direct order, backed up with muscle, to get the Andorian scientists to go along with it. Even so, the station will have to be defended, as there is no time to take or even destroy all important data and samples. Gamemasters should watch the clock, giving the characters no more than 30 minutes of *real* time to plan and set up.

If Cyrano is on foot, he will have only about 5 minutes lead on the Klingons. There's no time to do anything but bar the door and prepare to repel the siege. Remember those areas (power plant and genetics labs) protected by radiation-proof walls. These areas cannot be cut into by Klingon disruptors, and might offer a last refuge for trapped players. The Klingons can use disruptors to burn into any other area, the process taking one disruptor bolt to blast a lock at a door and three shots to burn open a wall.

The Federation players have several actions available, if they think of them. Don't point them out, but make sure the players have the knowledge they need to use them, if they think of them on their own.

The caged animals could be released as the Klingons approach. This would be *really* nasty for the Klingons! None of the station people would think of this, as they are used to the animals and don't realize how dangerous they are to those who know nothing about them. The red dervishes, in particular, would attack the Klingons (or anyone else) on sight!

The radiation gun in the genetics lab could be turned on by the Klingons, but it is too big and clumsy to

be moved, and it requires too much power anyway. Still, if the Klingons can be lured into the genetic restructuring lab...

Other nasty surprises could be prepared if they are thought up rapidly. With most of the group sealed off in the genetics lab, one person in the life support systems room could introduce a large amount of heavy sedatives (from the animal labs) into the atmosphere processing machinery. When the Klingons enter the station, they'll quickly be overcome by the drugs saturating the air. This ploy requires shutting off the air system in the genetics labs, but the group could last several hours in there anyway.

If the players think up other ingenious booby traps and strategies, give them a chance. Don't allow obviously ridiculous or overly complicated schemes to thwart the Klingons. Koloth and crew aren't stupid, after all! Play the Klingons nasty and sneaky. They aren't simply going to stroll in and expect no resistance at all, wearing big signs reading "Shoot Me"!

## ENDGAME

Toward the end of the adventure, the gamemaster should try to get a "feel" for how it is going. Are the players under siege in the station? Have a number of them been captured? Perhaps things are going the other way and the Federation party is making mincemeat of the Klingons. In an open-ended situation like the one described, anything can happen.

If the characters are in a very tight predicament, there are ways they can get out, as described above. Feel free to extend the scenario as much as you like. You may find that with large or very clever Federation parties it is best to allow the Klingons more people (two shuttles, perhaps) starting out. Be sure and plan several escape routes for Koloth, too — he's too good a villain to waste!

An interesting space battle sequence can be worked in here as well. Of course, the Klingons cannot risk word of this raid reaching the Organians. Even though Aleph III is outside the treaty area, the raid looks bad on the Klingon's diplomatic record and might lead the Organians to take a tougher line with them in further awarding of development treaties inside the protected zone. Thus, the Klingons cannot afford to let a shuttle return to the Enterprise, or, failing that, allow the Enterprise to escape.

If the Klingons are in danger of losing the battle for the station, Koloth will return to his shuttle and go back to his ship. The ship will then attempt to ambush any shuttle that leaves the planet's surface. Ordinarily, this would be bad news for Federation crew — a shuttle can put up no significant fight against a Klingon vessel. If the Federation shuttle is taken up, the Klingon vessel will move in for the kill. Unfortunately for them, this is bound to alert the Enterprise to the Klingon presence. Stage this battle by allowing the two ships to enter the field from opposite sides of the ship combat display, with the shuttle represented by a counter placed in the center of the display.

Since a shuttle is generally destroyed by one shot, let's offer the shuttle's crew at least a chance of survival. If fired upon, grant a saving roll on the operator's shuttlecraft pilot skill to dodge. If this roll fails, grant a second save,

this time on the highest LUC score in the crew, for the shot to simply disable the shuttle's engines, leaving it immobile. (Consider a mobile shuttle to be able to move 1 hex per turn. This whole combat takes place at sublight velocity anyway.)

The Enterprise should move quickly to protect the shuttle by keeping itself between the shuttle and the Klingon battlecruiser. Tractor beams should be locked on the shuttle to bring it aboard as soon as possible. (If a tractor beam is locked on, the shuttle can be brought aboard at the end of the turn. The rear deflector shield, however, must be down for the *entire* turn, thus leaving the Enterprise somewhat vulnerable. The rear of the ship need not face the shuttle to bring it aboard).

Of course, if Cyrano's ship is used to return to the Enterprise, the set of combat charts provided is used. Note also that the cargo pod of the Chameleon can be jettisoned and exploded. The hull of the cargo pod is lined with a reflective substance that, when scattered, acts as a sensor fooler, fouling sensor readings and making weapons lock-on impossible. This feature is Cyrano's special escape trick. The explosion (which takes place in any hex of the pilot's choice adjacent to the Chameleon will do no damage than to the pod itself), but will create an area of space that is temporarily opaque to sensors.

The pod explosion creates an area of three hexes (in a triangular pattern) full of the reflective substance. No line-of-sight for firing weapons can be drawn through these hexes, nor can a sensor lock be maintained on a vessel inside or behind this area. The effect lasts six turns.

The Chameleon is small enough to be brought aboard the Enterprise through the shuttle doors, as with a shuttlecraft as described earlier. The same saving rolls to escape enemy fire should be offered as well.





## KLINGON LANDING PARTY

Statistics for Koloth appear in the rulebook for **STAR TREK: The Role-Playing Game** under Familiar Characters. The Klingon security forces are as shown there. The stats for the Klingon doctor and Klingon Geneticist are shown here.

### KLINGON MEDICAL OFFICER

STR 65 END 65 INT 73 DEX 70  
CHA 42 LUC 20 PSI 15  
Significant skills: Botany 40  
Language (Galacta) 68  
Medicine (Klingon) 72  
Medicine (Human) 44  
Zoology 37  
Marksmanship (modern) 41  
Pers. cmbt. (unarmed) 33

### KLINGON GENETICIST

STR 60 END 55 INT 61 DEX 55  
CHA 32 LUC 17 PSI 13  
Significant skills: Botany 63  
Computer operation 55  
Planetary ecology 32  
Medicine (Klingon) 21  
Zoology 66  
Marksmanship (modern) 35  
Pers. cmbt. (unarmed) 39

## GRS17 PERSONNEL FILES

**KELLY, Robert L.** /civilian/Human, male/ Age 52  
Administrator GRC17, Federation Science Council

STR 39 END 51 INT 66 DEX 34  
CHA 79 LUC 57 PSI 27  
Significant skills: Administration 82  
Computer operations 77  
Gr. vehicle operation 52  
Leadership 31  
Negotiation/diplomacy 88  
Pers. cmbt. (unarmed) 01  
Marksmanship (modern) 04

Personal notes: A very competent administrator and negotiator, Kelly can be invaluable in an argument, but is useless in a fight, though he will try valiantly. He is amiable and easy to get along with.

**LOCTRILL, D'vin (Ph. D.)** /civilian/Andorian, male/Age 46  
Chief researcher GRC17, Federation Science Council

STR 60 END 65 INT 84 DEX 43  
CHA 64 LUC 30 PSI 28  
Significant skills: Computer operations 63  
Medicine (Andorian) 18  
Negotiation/diplomacy 01  
Pers. cmbt. (unarmed) 15  
Physical chemistry 72  
Zoology 94

Personal notes: Dr. Loctrill is a hard-nosed, short-sighted researcher with a one-track mind. He will resist any attempt

to distract his work up to the limits of his authority and somewhat beyond. Though he will not betray the group purposely, his stubbornness can lead to trouble.

**NAVARTI, Corie S./** Ensign/Human, female/Age 29  
Security officer GRS17

STR 59 END 68 INT 777 DEX 91  
CHA 74 LUC 42 PSI 12  
Significant skills: Ground veh. operation 82  
Language (Klingonese) 88  
Leadership 63  
Medicine (Human) 21  
Pers. weapons technology 78  
Pers. Cmbt. (unarmed) 55  
Marksmanship (modern) 69  
Starship security 77  
Zoology 12  
Communications sys. tech. 31

Personal notes: Navarti is the newest addition to the station's crew, having been here only two months. She's just begun to be accepted as competent and useful by the Andorian researchers, who liked the old security officer because he was lax and easy to get around. Navarti has been trying to tighten up security. She finds Cyrano amusing, but is aware he is a blabbermouth. Navarti is proud of the job she's doing, and will resent any usurpation of her authority, especially if it is simply because she's a woman. Conversely, she will warm quickly to someone who asks her advice and treats her with the respect due her position.

**OSTRANDER, Kal V./C. P. O./**Human, male/Age 28  
Station engineering officer GRS17

STR 67 END 42 INT 88 DEX 85  
CHA 62 LUC 23 PSI 12  
Significant skills: Computer technology 94  
Computer operation 69  
Electronics technology 81  
Ground veh. operation 44  
Life support technology 66  
Mechanical engineering 81  
Pers. cmbt. (unarmed) 38  
Marksmanship (modern) 22  
Shuttlecraft pilot 49  
Shuttle systems technology 31  
Communications syst. tech. 66

Personal notes: Ostrander would have been promoted further by now if he weren't so bored with everything non-technical. He's a voracious reader of technical works and is an admirer of Lt. Cmdr. Scott's works. (If Scotty is along, Ostrander will stick close to him and be very anxious to show off in front of him.)

**EVANOFSKI, Doris L. (M. D.)/Lt./**Human, female/ Age 59  
Medical officer GRS17

Significant skills: Botany 89  
Medicine (Human) 89  
Medicine (Andorian) 62  
Medicine (Vulcan) 40  
Pers. Cmbt. (unarmed) 81  
Planetary ecology 42  
Psychology (Human) 61  
Zoology 46

Personal notes: Evanofski (who insists on being called "Doc" or "Doc Doris") is an extremely competent doctor who prefers to project a folksy, "earth mother" image. She's fond of Navarti, and has taken the younger woman under her wing, so to speak. "Doc Doris" looks a bit chubby, but she's in excellent physical condition for her age, and can fight like a wildcat hand-to-hand. She never uses phasers or other deadly weapons — doesn't even know how to point one anymore! She is outspoken to the point of brashness, but is capable of great warmth and affection. No one at the station knows but Navarti, that Evanofski is holder of the Star Fleet Citation for Conspicuous Gallantry — a result of her participation in a dangerous space rescue operation.

DESTRY, Carver C. (Ph. D.)/civilian/Human, male/ Age 32  
Zoologist GRS17

STR 55 END 55 INT 75 DEX 60  
CHA 22 LUC 11 PSI 35  
Significant skills: Botany 51  
Pers. Combat (unarmed) 22  
Marksmanship (modern) 12  
Planetary ecology 81  
Zoology 83

Personal notes: Dr. Destry is quiet and retiring, usually taking a back seat to Loctrill. Despite this, he is a good scientist and will perform with surprising bravery in a crisis situation.

LANE, Daniel G./civilian/Human, male/Age 29  
Junior zoologist GRS17

STR 69 END 44 INT 77 DEX 63  
LUC 82 PSI 31  
Significant skills: Personal cmbt. (unarmed) 16  
Marksmanship (modern) 29  
Zoology 66

Personal notes: Lane has been Dr. Destry's assistant for a long time. He is not fond of Dr. Loctrill, and has constant clashes with Dr. Trastan. Lane is impetuous and high-spirited.

TRASTAN, R'val (Ph. D.)/civilian/Andorian, male/Age 38  
Associate geneticist GRS17

STR 65 END 60 INT 70 DEX 60 CHA 28 LUC 44  
PSI 46  
Significant skills: Botany 61  
Planetary ecology 31  
Zoology 77  
Pers. cmbt. (unarmed) 31  
Marksmanship (modern) 12

Personal notes: Trastan is strictly a yes-man and toady for Dr. Loctrill. If this on has ever had an original thought, it was lost amidst the foot-kissing.

LEON, Randolph Q./Petty Off. 2nd cl./Human, male/  
Age 24

Maintenance specialist GRS17

STR 60 END 50 INT 52 DEX 45 CHA 36 LUC 77  
PSI 10

Significant skills: Computer operation 44  
Pers. cmbt. (unarmed) 38  
Marksmanship (modern) 20  
Carousing 66  
Communications syst. tech. 53

Personal notes: As assistant to Ostrander and general station handyman, Leon is a good source of information on all the station gossip. He's friendly and likeable, and very approachable, especially over a tall, cool drink.

## FEDERATION GENETICS RESEARCH STATION 17

Floor plan descriptions General vehicle hangar: Contains Cyrano's model KEF-82 gravcarrier and two AP-16 2-man gravsleds used for fast movement around the immediate area to check traps and experiments.

Surface operations ready room: Among other items are 20 life-support masks, a charging station for standard hand weapons (takes 1 minute — 6 turns — to charge a hand weapon), 10 communicators (useless on this planet) — these are still crated), 6 phaser I stunners (stun setting only).

Sick bay: 2 diagnostic beds, plus the usual assortment, as might be found on board a ship.

Chief researcher's quarters: Wall display of ceremonial Andorian weapons, none of which are really functional. Phaser I under pillow (fully charged).

Administrator's private office: Override key for security doors is hidden in a secret desk compartment. (INT save at a 30-points penalty required to find.) The key will open any security door in the building.

Power system's control: Power controls for all systems. Security doors cannot be overridden from here!

Small animal pens: 1 blue dervish, 20 white mice, 6 rhesus monkeys, 2 hummers (soundproof cages), 4 pop lizards, 4 Hindenburg rollers, 10 tribbles, 4 false tribbles in well-marked cages.

Zoology lab: 1 cage with 3 false tribbles, and 1 sound-proofed cage with 1 hummer.

Animal pathology lab: Dissection equipment.

Lab storage: 4 phaser I stunners (charged -- stun only), 16 doses each light, medium and heavy sedatives for use on animals. (Will work on any humanoid species like Humans, Vulcans or Klingons.)



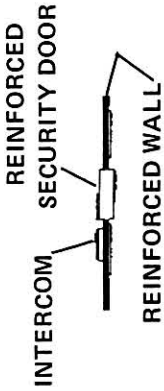
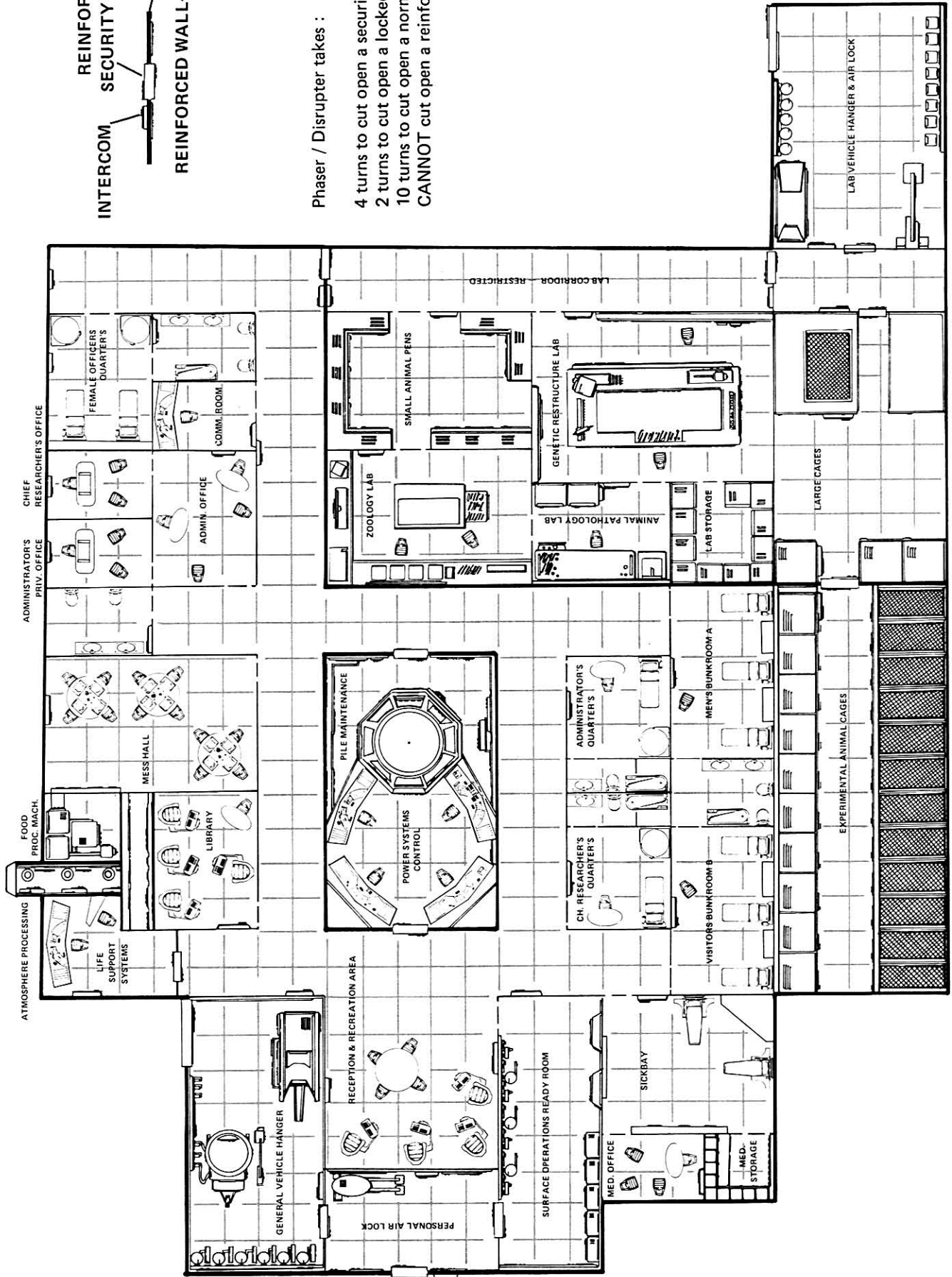

Phaser / Disrupter takes :

- 4 turns to cut open a security door.
- 2 turns to cut open a locked sliding door.
- 10 turns to cut open a normal wall.
- CANNOT cut open a reinforced wall.

Genetics restructuring lab: Radiation inducer gun (on gimbals: Can be focused upon any point in room). This item is usually used on low power, but can be overloaded for a single burst that does 6D10 burn damage to anyone in any 4-square area. It has a radiation poisoning effect when used in this manner that will affect anyone in the room not protected with an anti-radiation suit. This form of radiation poisoning causes the victim to take 1D10-2 points of damage per turn until the radiation sickness is neutralized by Hyronaline or other anti-radiation sickness drug. There are 6 anti-radiation suits in a cabinet in this room.

Large cages: 6 red dervishes, 6 blue dervishes, 2 blade barnacles, 16 hummers (in one soundproofed cage), 6 Hindenburg rollers

Experimental cages: 6 blue dervishes

Lab vehicle hangar: 1 KEF-82 gravcar (with rear passenger seats removed to provide more cargo space), 2 AP-16 2-man grav sleds.

Female officer's quarters: 1 phaser II (fully charged) in Navarti's bureau drawer (locked — Navarti has the key).

## CHAMELEON

Master & Owner: Cyrano Jones  
 Purpose: Planetary Scouting and light cargo

Weight: without cargo module	2000 metric tons
with cargo module	2750 metric tons
Standard Range:	2 years at LYV
Max Safe Crs Speed:	WF3 (with module)
	WF5 (no module)
Emergency Speed:	WF6 (with module)
	WF8.5 (no module)
Weaponry:	none
Length:	32 meters
Breadth:	10 meters
Height:	10 meters
Crew:	1

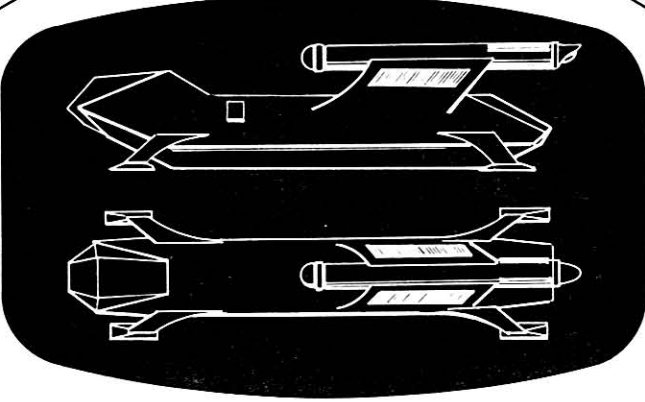
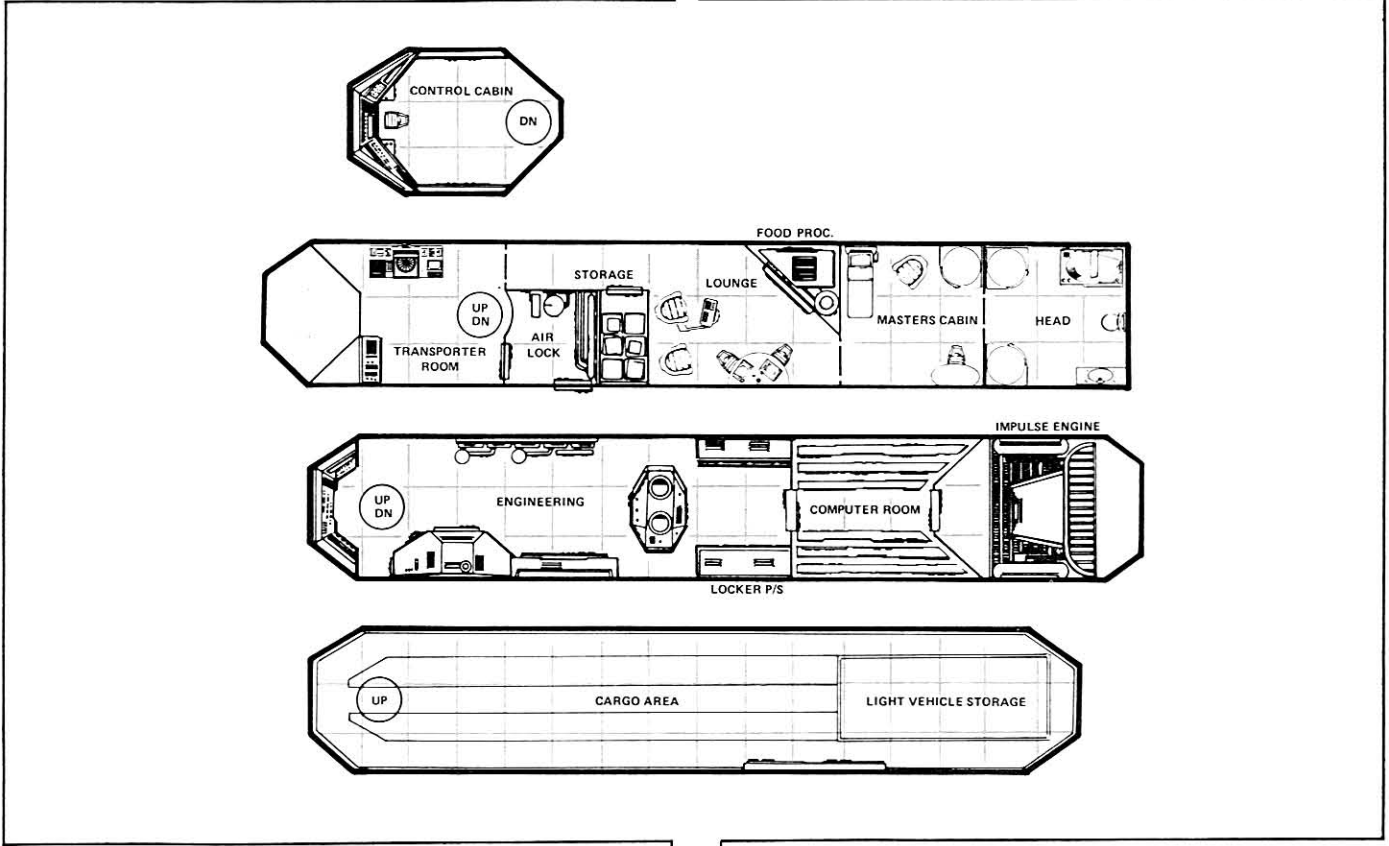

## ANIMALS OF ALEPH III

**GAMEMASTERS:** The wierd nature of Aleph III's animal life lends itself to trying out the extensive alien animal creation rules in **STAR TREK: The Role-Playing Game**. The following creatures are only the beginning. Feel free to add any fiendish creations of your own, bearing in mind that the animals of Aleph III should be *dangerous*. Don't create such incredible creatures that the party is quickly killed off. The red dervish should be about the most vicious killer you have. Some lesser predators and annoying (but not particularly life-threatening) creation like the hummer could easily be added for extra play value. Remember that a few examples of each type of animal would probably be in the station's collection. Also, some of the animals you create should have a feature that makes them of interest (like the dervish's natural stimulant hormone). Have fun creating new creatures to befuddle the party!

### RED DERVISH

Carnivore/mammal/medium

AP 18 DAMAGE 1D10+2 ARMOR 1 pt.  
STR 43 END 48 DEX 85 MNT 3

Tripedal mammal with reddish fur and three mouths, each on a 1 ft. long stalk, mounted on an inverted-cone-shaped body. The red dervish moves by spinning rapidly, and attacks anything that moves. (An immobile character will not be attacked if the dervish has not already seen it move this encounter...) It spins up to its prey at high speed and rotates in place, ripping with its sharp-toothed mouths. Dervishes are absolutely fearless, never running from prey. (Exceptions: see Blade Barnacle, Hummer.)

### BLUE DERVISH

Herbivore/mammal/small

AP 20 DAMAGE 1D10-3 ARMOR 1 pt.  
STR 23 END 28 DEX 91 MNT 3

Genetically reengineered version of the red dervish, produced by the laboratory because the dervish produces a hormone which is a fantastic natural stimulant. (Effects of dervish hormone on humanoids are like a heavy stimulant, but with after-effects and saving throws like a medium stimulant...) The blue dervish produces more hormone (and is faster and more agile because of it), but is much less dangerous. Unlike the larger version, the blue dervish is afraid of everything, and will not let anything or anyone approach closely if it can get away. The blue dervish has been introduced into the planet's ecology on an experimental basis, so some can be found in the wild state.

### BLADE BARNACLE

Herbivore/mollusk/medium

AP 2 DAMAGE 2D10 passive (rough contact)  
ARMOR 10 pts. STR 44 END 54 DEX 22  
MNT 2

This creature, when immobile, looks like a large, rough-surfaced rock. It moves slowly on twenty small legs on its underside and feeds on plant life which it crushes under its heavy body. If approached, it settles on its rough shell to the ground and extends hard, incredibly sharp ridges that cover its upper surface in a radial pattern. Any-

thing touching this surface roughly takes 2D10 damage from sharp edges. Otherwise, the blade barnacle is fairly harmless. The barnacle looks a lot like a rough boulder when immobile, and has developed its protective features to shield against such vicious predators as the red dervish.

### HUMMER

Herbivore/avian/small

AP 10 DAMAGE 1D10-3 ARMOR none  
STR 14 END 15 DEX 38 MNT 3

The hummer is a flightless ground bird like a small road runner. It has no special attack forms (other than a rather ineffectual pecking attack) and no armor. It defends itself rather well nonetheless. The bird gets its name because it has a set of vibratory organs (like simple vocal cords) under a wattle of flesh behind its head. The hummer uses this organ to make a warbling, humming sound that is extremely irritating to most forms of life that hear. Most life forms will not willingly stay around a hummer because their sound affects them like fingernails drawn across a blackboard! (Lab specimens are stunned at a distance and silenced in soundproofed cages). Any creature within hearing of a hummer (about 30 meters) must save vs. INT each turn or run away, unable to stand the sound. (Animals run automatically, unless very highly motivated!) Hummers are being studied for the unusual effect their sound has on the nervous system.

### POP LIZARD

Carnivore/reptile/very small

AP 12 DAMAGE 1D10+1 ARMOR 1 pt.  
STR 25 END 15 DEX 82 MNT 3

The pop lizard looks more like a thin starfish or octopus. It has 5-10 arms extending radially from its body. The body sports a round mouth with lots of little sharp teeth. The pop lizard buries itself just below the surface and waits for prey. When it feels the vibrations of movement above, it pops up, wraps its arms around the prey (or fastens on with grippers along the edges of the arms), and starts chewing. It would have a hard time chewing through a boot, but it will manage it in 11-20 turns (1D10+10) if not killed, stunned or otherwise removed. It can't be just pulled off by hand, as it will then grab the hand and start chewing!

### TRIBBLE

See listing in the animals section of **STAR TREK: The Role-Playing Game**.

### FALSE TRIBBLE

Herbivore/mammal/very small

AP 6 Damage 1D10+3 (touch) ARMOR none  
STR 5 DEX 5 END 5 MNT 1

The false tribble looks and acts just like a normal tribble (though it does not make the distinctive purring sound). If attacked, bitten by an animal, or even just touched, the false tribble's silky fur stiffens into razor-sharp stiff fibers, which do 1D10+3 damage. The scientists are studying the false tribble to learn about the structure of its razor-like fur.

**HUGGER GRASS**

(This is a plant, not an animal, but why quibble). A fibrous grass-like ground cover that can grow up to waist-high in some places. When disturbed by the presence of a moving objects, it will cling to that object, wrapping itself around it. The surface of this plant is covered with microscopic hooked fibers (like a natural form of Velcro) that catches in hair or clothing and makes the tough fibers hard to strip off. A figure must make a STR saving roll immediately (if the grass is waist-high). If the roll fails, the figure is held fast, unable to pull free. Hugger grass is sensitive to heat, and applications of heat (like a wide-angle phaser beam on a mild heat setting — too mild to hurt a person) will cause the grass to release itself and withdraw. It will then remain dormant (“stunned”) for 1D10 turns until it recovers.



**Red Dervish**

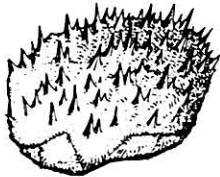

**Blade Barnacle**

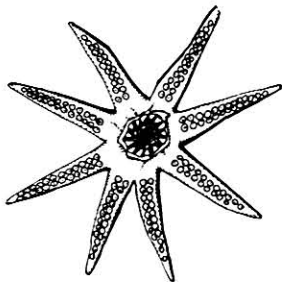

**Pop Lizard**



**Hindenburg Roller**

**HINDENBURG ROLLER**

The Hindenburg roller has developed a unique form of locomotion into an even more unique form of self-protection. The roller is a small bag of gas, self-inflated as it processes water into oxygen and hydrogen. (Hydrogen is used for inflation and the oxygen is breathed in and then expelled). The roller doesn't hold enough hydrogen to become lighter than air, but it does get somewhat buoyant. It releases the gas (and its breathed-out oxygen) through small ports all over its body, coordinating the gas jets to send it rolling rapidly along the ground. The gas explains also why the roller is avoided by most carnivores. If a roller is punctured or damaged, its abraded scaly outer skin strikes a spark and the roller explodes, doing 2D10 damage to the attacker. (Anything else within 2 meters takes 1D10 as well.) Any beam weapon attack, including phaser stun, will have the same effect. The station's scientist capture rollers with special live traps.

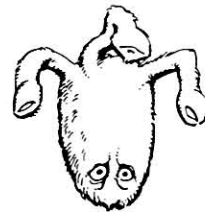

**Blue Dervish**

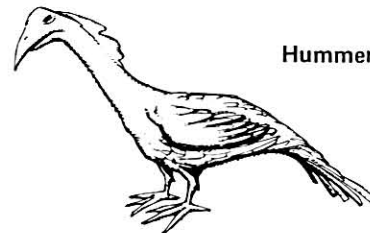

**Hummer**



**Tribble**



**False Tribble**



**Hugger Grass**



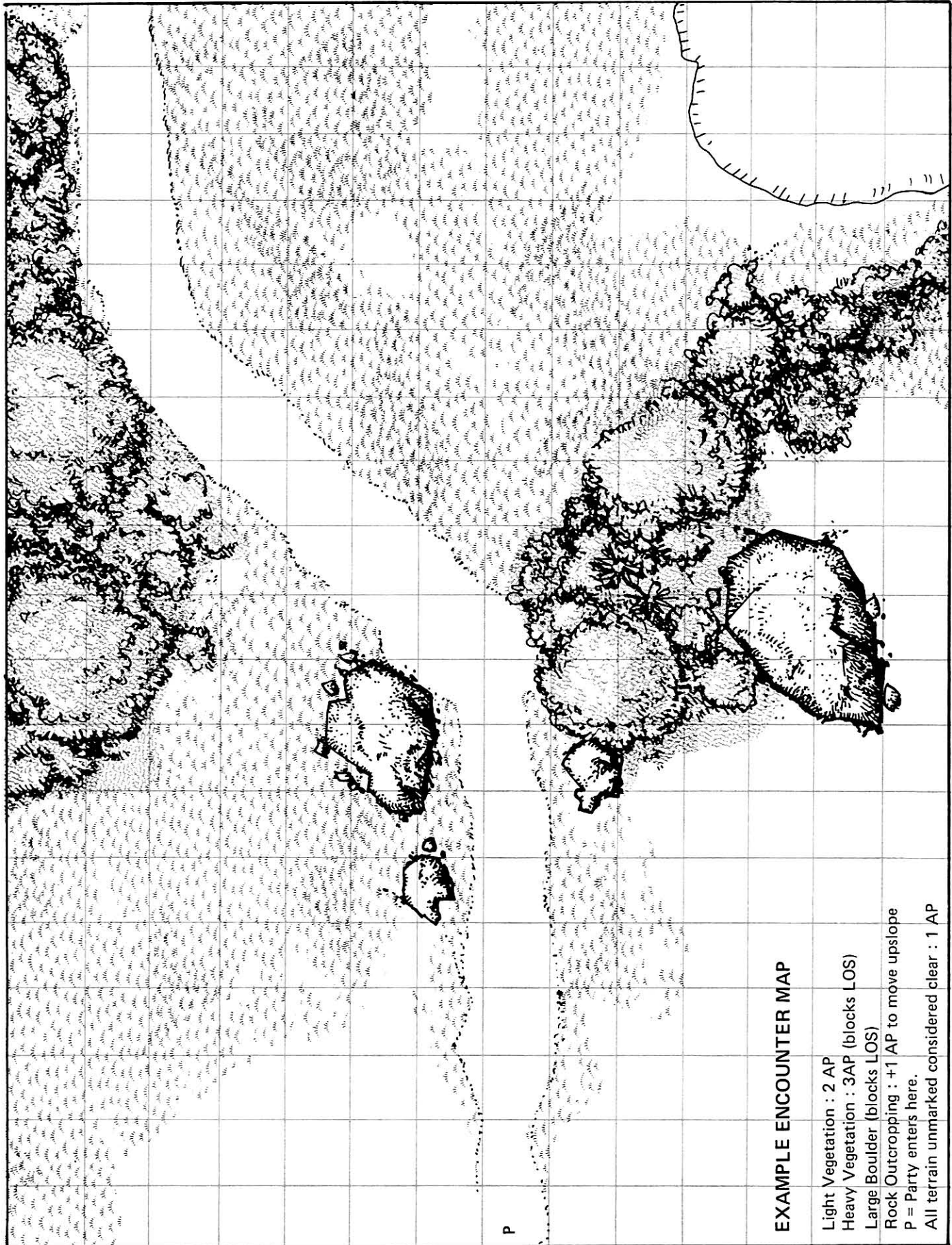

**EXAMPLE ENCOUNTER MAP**

- Light Vegetation : 2 AP
- Heavy Vegetation : 3AP (blocks LOS)
- Large Boulder (blocks LOS)
- Rock Outcropping : +1 AP to move upslope
- P = Party enters here.
- All terrain unmarked considered clear : 1 AP

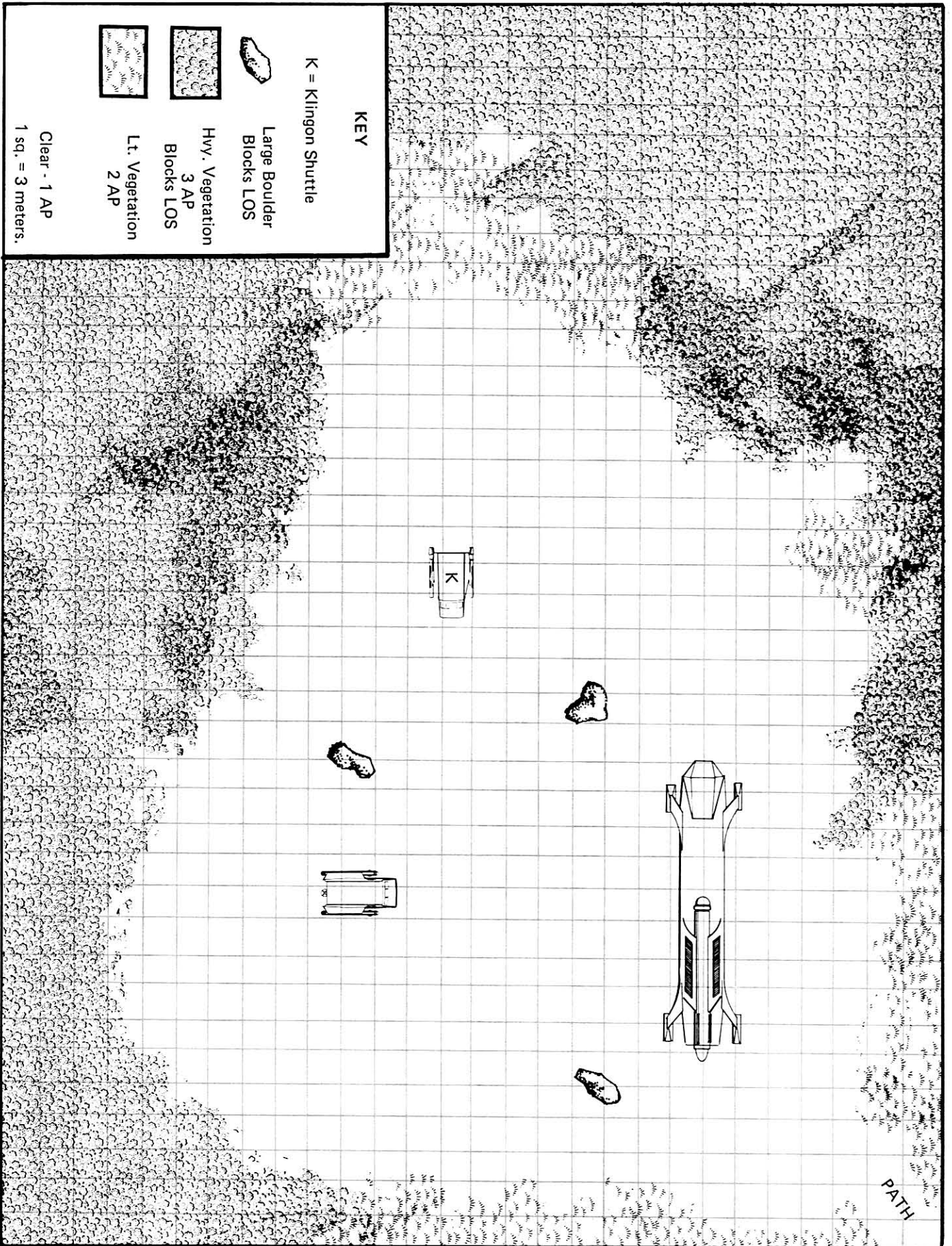



SENSORS/SCANNERS

DMGD	DMGD	OPER	LOCK
1	2		

SUPERSTRUCTURE  
STRESS/DAMAGE

0	1	2	3	4	5	6
---	---	---	---	---	---	---

### DAMAGE RESULTS

FORWARD		STARBOARD-FORWARD		PORT-FORWARD	
1	Sensors Damaged	1	Sensors damaged	1	Sensors damaged
2	Sensors Damaged	2	Sensors damaged	2	Sensors damaged
3	Forward shield damaged	3	Stbd-Fwd shield damaged	3	Port-Fwd shield damaged
4	Phaser damaged	4	Phaser damaged	4	Phaser damaged
5	Superstructure hit	5	Superstructure hit	5	Superstructure hit
6	Superstructure hit (1)	6	Superstructure hit (1)	6	Superstructure hit (1)
7	Superstructure hit (1)	7	Superstructure hit (1)	7	Superstructure hit (1)
8	Superstructure hit (2)	8	Superstructure hit (2)	8	Superstructure hit (2)
9	Bridge personnel out 1 turn	9	Superstructure hit (2)	9	Superstructure hit (2)
10	Bridge personnel out 1 turn	10	Bridge personnel out 1 turn	10	Bridge personnel out 1 turn

AFT		STARBOARD-AFT		PORT-AFT	
1	Aft Shield damaged	1	Stbd-Aft shield Damaged	1	Port-Aft shield damaged
2	Impulse engine hit	2	Impulse engine hit	2	Impulse engine hit
3	Impulse engine hit	3	Impulse engine hit	3	Impulse engine hit
4	Impulse engine hit	4	Starboard warp engine hit	4	Port warp engine hit
5	Starboard warp engine hit	5	Starboard warp engine hit	5	Port warp engine hit
6	Starboard warp engine hit	6	Starboard warp engine hit	6	Port warp engine hit
7	Port warp engine hit	7	Starboard warp engine hit	7	Port warp engine hit
8	Port warp engine hit	8	Starboard warp engine hit	8	Port warp engine hit
9	Superstructure hit	9	Superstructure hit	9	Superstructure hit
10	Superstructure hit	10	Superstructure hit	10	Superstructure hit

# HELM

MISSION CLASS COURIER

## CURRENT SPEED

SUB LIGHT	W1	W2	W3	W4	W5	W6	W7	W8	W9
--------------	----	----	----	----	----	----	----	----	----

## MOVEMENT POINTS AVAILABLE

0	1	2	3	4	5	6	7	8	9	10
---	---	---	---	---	---	---	---	---	---	----

## TURN STRESS CHART

SPEED	ENGINE STRESS	SUPER STRESS
SUB	—	—
W1	—	—
W2	—	—
W3	—	—
W4	—	—
W5	—	1
W6	1	1
W7	1	2
W8	2	2
W9	2	3
W10	3	3

## PHASER (FORWARD ARC)

DMGD	UN ARM	1	2	3
------	-----------	---	---	---

## PHASER FIRING CHART

RANGE	TO HIT	DMG+
1	1-10	2
2	1-10	2
3	1-9	2
4	1-9	2
5	1-8	2
6	1-8	2
7	1-7	2
8	1-6	1
9	1-5	1
10	1-4	1
11	1-3	1
12	1-2	1
13	1	1



# NAVIGATOR

MISSION CLASS COURIER

## DEFLECTORS

FORWARD	DMGD	STARBOARD FORWARD	DMGD	FORWARD PORT	DMGD	AFT	DMGD	STARBOARD AFT	DMGD	PORT AFT	DMGD
	0		0		0		0		0		0
	1		1		1		1		1		1
	2		2		2		2		2		2
	3		3		3		3		3		3
	4		4		4		4		4		4
	5		5		5		5		5		5
	6		6		6		6		6		6
	7		7		7		7		7		7
8	8	8	8	8	8						

## COMMUNICATIONS

### CASUALTIES

0	1	2	3	4	5	6	7	8	9
---	---	---	---	---	---	---	---	---	---

# ENGINEERING

MISSION CLASS COURIER

IMPULSE ENGINE

0	1	2
---	---	---

WARP ENGINE NO. 1 STARBOARD

0	1	2	3	4	5	6
---	---	---	---	---	---	---

WARP ENGINE NO. 2 PORT

0	1	2	3	4	5	6
---	---	---	---	---	---	---

TOTAL POWER AVAILABLE

0	1	2	3	4	5	6	7	8	9	10	11	12	13	14	15	16
---	---	---	---	---	---	---	---	---	---	----	----	----	----	----	----	----

POWER TO MOVEMENT

0	1	2	3	4	5	6	7	8	9	10	11	12	13	14	15	16
---	---	---	---	---	---	---	---	---	---	----	----	----	----	----	----	----

NOTE: 1½ POWER POINTS = 1 MOVEMENT POINT

POWER TO SHIELDS

0	1	2	3	4	5	6	7	8	9	10	11	12	13	14	15	16
---	---	---	---	---	---	---	---	---	---	----	----	----	----	----	----	----

POWER TO PHASER

0	1	2	3
---	---	---	---



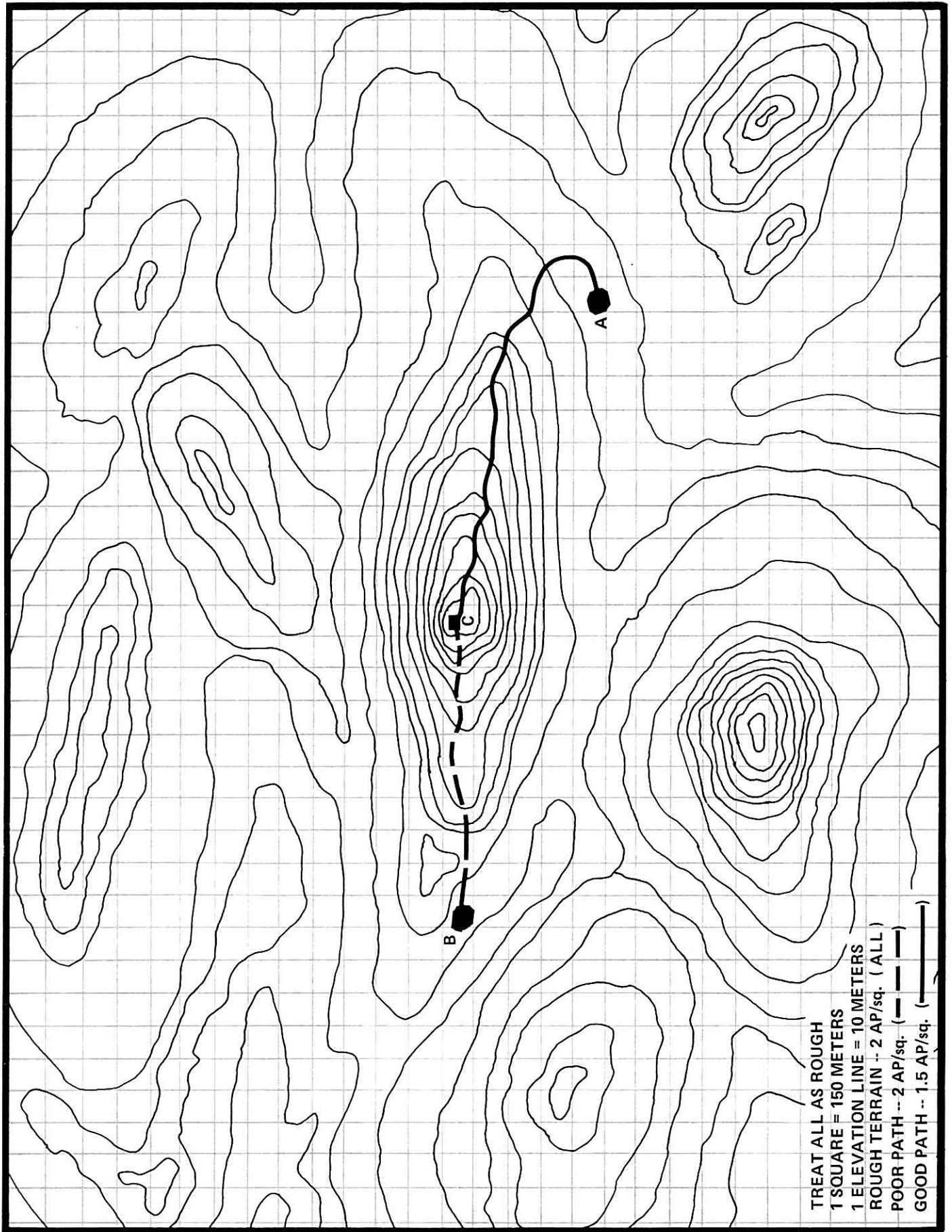

# In The Presence of My Enemies

## THE ADVENTURING GROUP

This adventure is intended for use with a small group of Federation Star Fleet characters who fall into the hands of the Klingon Empire. It may be used with the background provided as a stand-alone adventure, or act as a "sub-adventure" to be used whenever a group of characters is captured by Klingons as part of an adventure situation.

Characters can start the game aboard a standard Federation shuttle, or use the *Mission* class courier/transport provided with this adventure scenario. The shuttle would be used if characters have come only a short, interplanetary distance (perhaps dropped off by a larger ship). If the characters have come across interstellar distances (such as in our suggested background) use the courier/transport.

## BACKGROUND (optional)

The people of the Lorealyn system are one of many races contacted by the Federation that resemble humanity so closely that differences cannot immediately be detected without medical examination. Before contact, they have developed a thriving interplanetary capability, with colonies on Lorealyn II and Lorealyn IV established by the people of Lorealyn III.

But it is Lorealyn V that most interests Federation scientists, for it is on this volcanic world, unsuitable for human habitation, that crystalline deposits of extremely unusual properties have been discovered. Volcanic crystals have been discovered with much more densely packed structure than dilithium, leading some Federation scientists to believe that they could be on the verge of a breakthrough in power systems design — if enough crystals can be obtained.

The Lorealyn government has been offered Federation membership, and it has been pointed out to them how lucrative it can be to sell valuable crystals to the Federation, thanks to the UFP's free trade policies. But other interests are also seeking alliance with Lorealyn.

Lorealyn lies in the Organian Treaty Zone between the Klingon Empire and the UFP. The Organians will not interfere directly in either groups dealing with an independent intelligent race, but they would act to prevent the Klingons from using their usual "conquer and pillage" tactics on Lorealyn. Thus, the Klingon Diplomatic Corps must slug it out with the Federation symbolically, across a bargaining table with the Lorealyn government.

The Klingon offers have been unusually generous, revealing to UFP representatives just how much importance the Empire places on the Lorealyn crystals. Most recently, the Klingons have offered Lorealyn dominion over two rich agricultural worlds currently administered by the Klingons in a nearby system. They also promise to provide

warp technology and help with ship construction, so those planets can be exploited for Lorealyn's rapidly growing population. At this point, Lorealyn is on the verge of siding with the Empire.

In a last-ditch effort to sway the Lorealyn decision, the Federation diplomats have sent for Federation ambassador Carlos Luis Rivera. Rivera is a senior diplomat who is among the most respected in the Federation. His reputation for honesty and fairness are widely known. After consultation with the Federation council, he intends to approach the Lorealyn's with a new proposal that far outreaches any promises the Klingons can realistically make. Diplomatic opinion is that, though the proposal itself might not be enough to sway the Lorealyns, Rivera is likely to turn the tide of negotiation in favor of the UFP if he presents the plan personally.

The players have been assigned as crew of a special-commanded *Mission* class starship, the *Magnan* (NCC-13843), which has been outfitted as a VIP diplomatic courier. This ship will convey Ambassador Rivera to the conference in plenty of time to present the new proposal. The trip is considered to be a "milk run" — an easy, unexciting job.

Accompanying Rivera will be a mixed bag of officers, going as observers and technical advisors. Thus just about any group of player characters can be used, assuming they have at least one pilot. There should be no more than eight crewpersons, however, as that is all the courier can handle comfortably. (If a shuttle is used, there can be no more than 6 crewmen, plus Rivera.)

## APPROACHING THE LOREALYN SYSTEM

All goes pretty smoothly until the ship approaches the Lorealyn system itself. The ship has been maintaining subspace radio silence (standard procedure in the case of diplomatic ships operating in areas of known Klingon activity) during the approach. Suddenly, sensors indicate a Klingon D-7 battlecruiser closing fast. The enemy ship is very close, and was using the system's outer planet as sensor cover until it pulled its ambush.

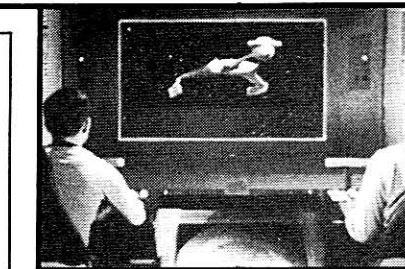



Ship combat data for the *Mission* class ship is provided. It should be painfully obvious that it is no match for a D-7! Nonetheless, the characters are sure to try. Set up for combat with the two ships just entering the opposite sides of the map, both at warp 7. Unbeknownst to the players, the Klingon commander does not intend to destroy their ship — he wishes to take them alive. The disruptors aboard this particular D-7 have been retuned to be capable of stun effect. If the D-7 can manage to penetrate the shields of the small Federation craft, and do even one point of damage beyond that, the stun effect will knock out everyone on board.

If the players are aboard a standard Federation shuttle, it's even easier. One shot from the D-7 will take care of them, as a shuttle has no shields and can't run at warp speed. Either way, the players will lose consciousness.

**DESIGNER'S NOTE:** I can't imagine how it could happen, but if the players in a *Mission* class vessel manage to escape by significantly damaging a D-7, the gamemaster is justified — for the sake of the adventure — in ringing in a later SECOND D-7 to take them out! It's cheating, but you can make it up to them later when they escape (which anyone that resourceful should do easily) by decorating them (promotions might be in order as well, especially for the pilot) for conspicuous gallantry. Anyone who even makes a good showing against a D-7 with one phaser and weak shields is GOOD!

## PRISONERS OF THE KLINGON EMPIRE

The Klingons, in typically ruthless fashion, have taken the initiative to see to it that Ambassador Rivers doesn't reach the conference. They could have destroyed the ship, but they feared Organian retribution if something went wrong and they were discovered. Besides, the Ambassador has knowledge of use to the Empire, and Klingon interrogators are very persuasive.

The characters will wake up in detention cells (on deck 7 starboard side of the main hull, though they won't know that). They will be segregated by sex and put two persons to a cell. This particular D-7 still uses old-fashioned solid steel cell doors (instead of force fields) with a small view slot at eye level, covered by a small hinged plate on the outside. Their communicators, phasers, and other equipment is of course gone. The ambassador is not among them, and only the people incarcerated in the same cell can communicate directly to each other.

The problem, of course, is one of escape. This may seem like an impossible task on board a D-7 battlecruiser with all those Klingons, but it can be done, if the players are daring and resourceful and if the gamemaster provides reasonable opportunities. The players must escape the cells, find a way out, and — somewhere along the way — locate and rescue the ambassador, if he is still alive. (He is, but they don't know that . . .)

The information carried by the ambassador does not need to be recovered — the details are all in his head, or can easily be reconstructed by the Federation diplomatic office. What is required at the conference is the Ambassador's presence, to present the plan. Rescuing him takes top priority.

Certainly the party will be missed when they turn up overdue, but no one has any way of knowing where they are. For that matter, the players themselves cannot be sure. In actuality, they are on board a D-7 battlecruiser now in orbit around Lorealyn III itself, and have been unconscious only three hours, but they will have to find this out for themselves.

The Klingons got clean away with the kidnapping itself, bringing the Federation vessel aboard and stowing it on the hangar deck of the battlecruiser after stunning the occupants. Unfortunately, they were spotted and hailed by Lorealyn interplanetary ships before they could leave the system. The captain, to avoid suspicion, claimed to be a late-arriving ship attached to the Klingon Diplomatic Corps delegation, and came into orbit about the very planet on which the conference was being held!

The Klingon captain is now sweating out the conference, waiting for it to be over (in two days) so he can slip away with the captives, under the noses of both Lorealyn and Organian observers. This is quite a break for the Federation crew, who need only get off the ship by transporter, or by shuttle, or on their own vessel (still in the shuttle bay) to escape clean. The Klingons dare not fire on them if they can get off the ship, or they will give away the whole scheme! If the players despair early, or are wasting time waiting to be rescued, have the fact that they are orbiting Lorealyn III be leaked to them, perhaps through overhearing a guard's conversation. This should spur them to make an escape attempt.

## JAILBREAK!

There are any number of ways a jailbreak can be attempted. If the characters are self-starters, they will devise their own methods. In this, as in many parts of this adventure, it will be up to the gamemaster to play fair with the situation and give good plans a reasonable chance to work. Remember to "role-play" the Klingon guards! For the most part, guarding is a tedious job, and guards do make mistakes. These guards would not be used to having highly motivated prisoners and might underestimate them. On the other hand, the guards are all trained fighting men, and are not dimwitted pushovers, either!

Generally speaking, there will be two guards on duty in the main office/guardroom. The desk in the forward port corner of the room belongs to the security chief, and it is used by him exclusively. It is always locked (the chief has the key), and the top right-hand drawer contains a fully-charged disruptor pistol. The center drawer has a memo (in Klingonese — make a saving roll on that language skill to read it) discussing the transfer of the ambassador from detention section to interrogation on deck 9 forward for the day. A second memo in the same drawer (also in Klingonese, requiring translation) mentions that the prisoner's personal effects have been taken to the special studies lab (boom of deck 5, though this is not noted in the memo) for later examination for any new developments in Federation technology.

The bottom drawer of the desk contains two charged phasers (I or II, depending on what the party carried), which the chief held out as souvenirs. The desk itself uses an electronic locking system. A person with

electronics technology skill would have a chance to bypass the lock (with a skill saving roll at a +25 penalty), but it would require stealing some tools (perhaps from the nearby elevator repair shop).

The other oval desk is used by the guard on duty. There is always one guard here, armed with a disruptor pistol. This desk is unlocked but contains nothing of significance. The top of it, however, has a security monitor that can receive pictures from any security camera on the ship. This is not the main monitor room — that is on deck 9 in the forward pod. This one can link with those monitors, but is not used often. The controls, of course, are in Klingonese. The desk also has the controls for the double security doors in the hall outside, and the single security door to extreme starboard and aft of the security section near the guard lounges. A large red button (unlabeled) on the edge of the desk is a general alarm, designed to warn of a prisoner escape. If this button is pushed, the internal surveillance room and the whole ship will be alerted. A guard will be reluctant to push it, if he feels he can handle the situation himself (fearing his efficiency will come into question).

There is a 50% chance (roll 1-5 on 1D10) that a second guard will be here. If the roll is 1, the second guard is the security chief himself. (See the Klingon personnel and encounter section of this adventure for statistics on guards, the security chief, etc.)

The twin security doors at the forward end of the security section are, as was mentioned earlier, controlled from the duty desk in the office. They are reinforced, and cannot be cut through by hand weapons. A security camera is present in the space between the doors, and it is this camera that is most often scanned by the desk monitor mentioned above. There is also a buzzer and camera on each side of the double door, for the announcement and clearance of people coming in or out. These are ONLY monitored by the duty desk.

The guard's messroom will have 1D10-6 guards present. They will immediately rush out and search the whole section if an alarm is sounded. If they are not disturbed, they will probably never notice anything wrong until one or more wanders down the cell block or up to the office. There is a 1/10 chance of this happening every ten minutes or so. If one should find the prisoners mission, a general alarm will be sounded immediately.

The "back exit" of the security section (to extreme starboard near the gangway) has a reinforced security door, controlled from the forward main security office. There is also a buzzer and camera here, monitored by the duty desk. Next to this exit is a guardsmen's lounge. This area is considered by most of the guards to be a good place to catch a catnap. There is a 50% chance there will be a single guard here asleep.

If the players don't come up with an escape plan right away, offer them an opportunity. Perhaps a guard will be a little less than alert when bringing meals to one of the cells. If all else fails, have one of the more resourceful players brought under guard to the security office and put under interrogation in the small rooms there. Perhaps an opportunity to jump the guards will present itself.

If nothing else, have two guards escort the highest ranking prisoner forward to the main interrogation facility on deck 9 of the forward pod. Give the prisoner no chance

to escape on the way up. When he or she arrives there, while being interrogated they should get a glimpse at least of the ambassador. On the way back, a guard may stumble or be distracted momentarily. No Star Fleet officer (or STAR TREK fan) would miss such an opportunity!

Play it by ear until the prisoners are released from the cell block. (The security chief has a master electronic key to all security doors, and the guard on duty will have one that will at least open the cells in this section.) From here, how the play proceeds is up to the players. Be prepared to be flexible and to think on your feet. Some guidelines are provided for encounters and sensitive areas of the ship, but the gamemaster is on his own here much of the time. Make use of the deck plans and descriptions of the D-7 battlecruiser supplied in STAR TREK: The Role-Playing Game.

## MOVING ABOUT THE SHIP

The interior of a D-7 battlecruiser will be new to most characters (if not to the players). The gamemaster is advised NOT to display deck plans for simple sneaking around the ship. Describe roughly what the party sees as they move along, illustrating with rough sketches where necessary. Parties with at least one person who has the Klingonese language skill will have less trouble getting around, since they can read signs. Require a standard skill saving throw on the language score before giving significant information in this way.

Characters who wish to operate Klingon equipment (such as computer terminals) are at a +10 penalty for doing so if they have a 20 or more in Klingonese and at a +35 penalty if they have less knowledge or no knowledge of Klingonese. Require language skill rolls for gaining useful information from computers.

If the characters steal Klingon uniforms, it will help them be less conspicuous at a distance, but they will not LOOK like Klingons closer up. Any attempt to use Klingon uniforms subtracts one from the roll to be spotted in the corridors.

Fortunately, the corridors on the D-7 are not as crowded as on Federation vessels. Klingon crewmen tend to simply come and go from duty stations and not wander around so much. Thus, when characters are moving down a length of corridor, roll 1D10. On a 5 or less, they are not spotted by anyone. (On a 6 or less if wearing Klingon uniforms). Roll again every time they turn a corner or go up or down in turbolifts or on gangways or stairs. Turbolifts are directed by voice commands in Klingonese only, requiring a language saving roll to use one.





If a figure is encountered in the halls, roll 1D10 on the encounter table below to see what happens:

1 - 3 LOWER-GRADE CREW

If the party is wearing Klingon uniforms, there is a 75% chance that such crewmen will simply ignore them, even if the party really doesn't look much like Klingons. Low-grade crewmen know it is usually better not to get involved with such things. Otherwise, they will attempt to run away, calling security as soon as they get to a place of relative safety. If security does not answer, however, (perhaps put out of action by the escapees), low-grade crew will not sound a general alarm.

4 - 5 MID-GRADE CREW

50% will attempt to subdue obvious intruders, otherwise will run and try to call security. If weapons are displayed, will automatically run.

6 - 7 JUNIOR OFFICERS

Will attempt to subdue intruders unless fired upon. Then 75% will run and call security, 25% will sound general alarm as soon as possible.

8 - 9 SECURITY PATROL

Armed with hand disruptors and agonizers. Will attempt to subdue or kill intruders, sounding a general alarm if outnumbered or outgunned.

10 SENIOR OFFICER

Always accompanied by one security guard, armed as above. Senior officers also armed as above. Guard will attack. 50% of officers will attack, otherwise will attempt to get away and sound general alarm.

When a group is encountered as above, there will be 1 to 3 individuals (except with senior officers, who will be encountered individually with their bodyguard.) Roll 1D10. On a roll of 1-5, only one Klingon is encountered. On a roll of 6-8, two, and on a roll of 9-10, three are encountered. If a general alarm has been sounded, there will always be 3 guards in a party.

If the party enters a large room or area that is often used (like a messroom, engineering section, etc.) there will be 1D10 Klingons present; a mixture of officers and crewmen usually. If the area is sensitive to the operation of the ship, there will also be one armed security guard.

Small rooms and areas that are not heavily used will only be occupied 50% of the time, and then only by one or two people. Most rooms have intercom panels where security could be called, or a general alarm given.

When an encounter occurs, the players will usually get surprise on the encountered group 50% of the time. If surprise is gained, they get one full turn of action before the Klingons can take any attack actions. (Running away or other movement is not an attack option, but stopping to call security or set off an alarm counts as an "attack" for these purposes.) If no surprise is gained, the groups start even.

Either way, set up the room on a square grid (or use FASA's D-7 deck plans in 15mm, available now) and go into the combat mode. Using an intercom requires performing an "Operate Familiar Device" action, then making at least a "Short Communication" for a total minimum AP

expenditure of 3. Setting off a general alarm does not require communication, and takes only 2 AP. Either action can only be taken by someone standing next to an intercom panel. Intercom panels are usually next to the main door in and out of a room, so assume someone standing at the door can use one. You can't use the intercom or set off the alarm while in personal combat with someone.

Remember in combat situations that repeated disruptor fire or a large melee will attract attention and make a lot of noise. Eventually, someone overhearing the fracas will set off a general alarm. Roll 1D10 each turn of combat. On a roll of 1 or 2, someone has heard the noise and set off a general alarm.)

## GENERAL ALARM

Setting off a general alarm is the worst thing that can happen to the players. If this happens, general quarters will be sounded 1D10 turns later, summoning all hands to duty stations. Chances for encountering people in the halls goes up to 70%, and all encounters will be with security teams. Within minutes, the whole ship will know the prisoners are out and will be looking for them. Chances are, if this happens, the players have had it, unless they do some quick running, good fighting, or fast thinking. Fortunately, most junior crewmen and even officers would be reluctant to set off such an alarm if they thought they could handle the situation on their own.

If the situation does occur, however, the players will probably be recaptured, and some may be killed (though the medical section will try to save any they can — the group is still somewhat valuable as prisoners). A second escape attempt is possible, but should be made harder.

## AREAS OF INTEREST

The following areas may be of special interest to the players, if they can get to them. If the players can operate a computer terminal (and if they think of it), they probably can call up a display map of the general layout of the ship. Such a map would not tell about sensitive areas of the ship — such information is classified. But it would tell them how to get to many of the places on this list.

**BRIDGE:** The most well-guarded area of the ship. The players should stay far away from here!

**DECK 4 TRANSPORTER ROOMS:** An escape can be made from here, if the lone armed guard always present can be dealt with. Using the transporter will light an indicator on the bridge, but too late to stop one beamout. (There won't be time to do it twice before power to that transporter gets shut down on the bridge, however!) The controls are, similar to Federation design, but successful use does require a saving roll on the transporter operation skill. (Failure means you can't get it up to function, but doesn't cause any harm. You just can't beam out.)

A person who both reads Klingonese (making a saving roll on that language skill) and is well versed in transporter operation (20 skill level or better) needs not make a saving roll to use this transporter to beam down.

Before the players can escape via transporter, they must be aware they are in orbit about a planet! Otherwise,

to where are they transporting? Precise coordinates are not needed, if they know they are in orbit around Lorealyn 111, since the transporter console can be set to prevent them from beaming into solid rock and to put them down on solid ground instead of over water or in mid-air.

If they wish to go somewhere in particular, they must get coordinates from the computer. This will take a few minutes and requires a saving roll on computer operation skill and a saving roll on the Klingonese language skill.

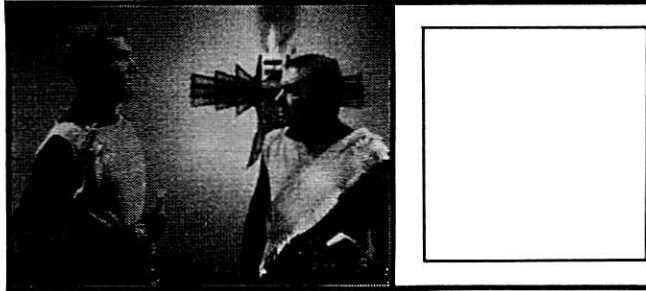

**AUXILIARY CONTROL ROOM (D6 FWD POD):** This area is guarded by two armed guards, but if the players can get in here, they can cause all sorts of trouble. Operating the controls requires reading Klingonese (making the appropriate saving roll), or suffering a +25 penalty to the appropriate skill roll to operate the equipment. Because the equipment is unfamiliar, it requires some sort of a saving roll to even perform routine actions. Even so, this place is important because these controls can be set up to *override* the main bridge controls. Doing so will automatically set off a general alarm. This will summon three more guards to this room in six turns, but if the players leave before that, no one will be sure where they are, though they will know the auxiliary controls have been tampered with. This place is best used to create a diversion or to do something too subtle to be noticed.

**DECK 7 EMERGENCY TRANSPORTERS:** In a pinch and this is one) these can be used to escape.

**INTERROGATION ROOM (D9 FWD POD):** The ambassador is here, drugged and under guard by two armed guardsmen. There is a high-ranking security officer (also armed) here as well, questioning the prisoner. The ambassador is in no shape to fight, but he can walk unaided if released. If medical supplies are available, a light stimulant will bring him around enough to run and fight if necessary.

**SHUTTLE STAGING AREA (D2 MAIN HULL):** There are Klingon shuttles in this area, but it should not be necessary to use them, as the captured Federation ship is above in the shuttle bay. This fact is known to the three workmen who can be found here, and they will reveal it if strongly persuaded at gunpoint. (They will *not* reveal that the ship is guarded).

**SHUTTLE BAY (D1 MAIN HULL):** The Federation ship is here and operational. It is guarded by two security guards armed with disruptor rifles, who stand to either side of the hatch. There are controls on one wall which can be programmed to open the shuttle bay doors after a set time delay. Anyone who makes a Klingonese language saving roll can set these controls. Opening the bay doors will sound a general alert, but if the ship takes off immediately, it will

be too late to stop it by the time the bridge crew can react. Once the ship is launched, the crew is safe — the Klingons will not dare fire on them while orbiting Lorealyn.

**AUXILIARY BRIDGE (D6 MAIN HULL):** This area is guarded by two security men, but it has no override controls and is useless to the players. It does have a standard computer terminal, however.

**DECK 7 MAIN HULL TRANSPORTER ROOM:** See earlier notes on other transporter rooms. This one is guarded by one guard, and there is a 50% chance there will be 1D10 other people there as well (coming or going), since this transporter is so often used.

**SMALL ARMS ARSENAL (D7 MAIN HULL):** This room has a locked security door and a guard outside in the corridor with a disruptor rifle. The guard has no key, but the key carried by the security chief also opens this door. It cannot be cut through with hand weapons. Inside are all the disruptors (of both types) the characters could want, plus a facility that could be used to recharge phasers. (A recharge would take 5 minutes to set up, and another 5 to accomplish per phaser).

**ELEVATOR REPAIR FACILITY:** This is potentially the most valuable place the characters could get to. From here, all the turboelevators can be controlled. There are no guards here — this is a security weak point the Klingons haven't thought of! There are two technicians present, however. See the description of this place in the deck plan descriptions for more information.

**TROOP TRANSPORTERS AND SMALL ARMS ARSENALS (D8 MAIN HULL):** These areas are guarded by a force of three guards. The arsenals are protected as with the other arsenal described earlier. The transporters can be used to escape, subject to the restrictions for transporter escape mentioned earlier, and the restrictions on this type of transporter noted in the deck plan descriptions.

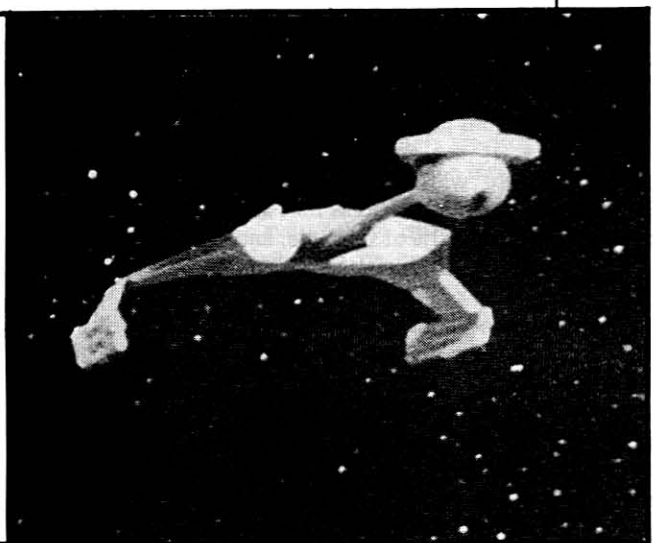



## ENDGAME

If the players get off the ship with the ambassador, the Klingons will be revealed as the cutthroats they are, and the Lorealyns will certainly ally with the Federation and order the Klingons out of the system. (They'll leave quickly; half the military fleet for the quadrant is here, trying to impress the Lorealyn government with Star Fleet military technology!)

If the players duck out without the ambassador, the Klingons will deny everything. They will eliminate the ambassador, of course, immediately to get rid of the incriminating evidence. Unless the players have proof of their allegations, they will not be able to get the Lorealyn government to ally with the Federation. The suspicions, however, will prevent them from allying with the Klingons.

They will declare neutrality for the time being and end the conference. This is considered a draw, for those who are "keeping score".

Either with or without the ambassador, any players left behind after an escape will be immediately killed upon capture by the Klingons to eliminate evidence against them. For this reason, encourage players not to split up unless they are aware that the ones who stay behind will likely not be coming back. We also don't recommend using familiar STAR TREK characters in this scenario, unless you are willing to risk killing them off in your campaign, or wish to pull a last minute *deus ex machina* save by the gamemaster if the players blow it.

This is a tough adventure, and is not for inexperienced players. It is a highly rewarding game experience however, and survivors who get the ambassador out should be decorated at the very least! Those who get out should get 1D10 +5 points in Klingon Psychology skill and perhaps 1D10-3 in Klingonese, due to exposure to the people and the language close up under unusual circumstances. They will also gain some working knowledge of the inside of a D-7 battlecruiser, which may prove useful later.

This is a highly "gamemaster-intensive" scenario too, relying on the gamemaster to make things up as she/he goes along. It is not an easy adventure to run, but it is likely to be unforgettable for both gamemaster and players!

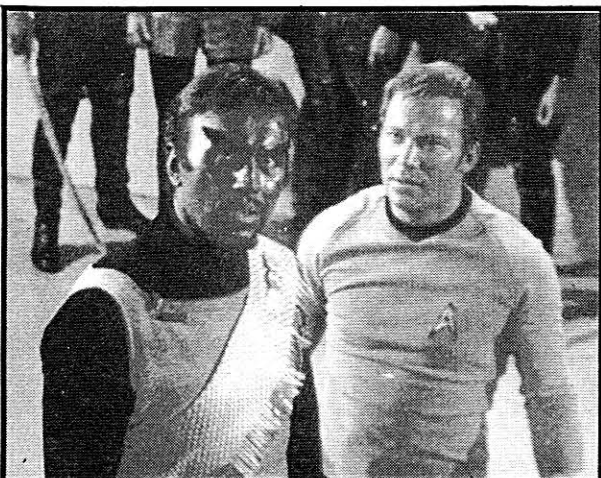

## NON-PLAYER CHARACTER INFORMATION

The statistics for Federation ambassador Carlos Luis Rivera and the Klingon security chief mentioned in this adventure are noted below, along with an assortment of typical Klingon crewmen for random encounters.

RIVERA, Carlos Luis/civilian/Human, male/Age 55  
Ambassador from United Federation of Planets

STR 45 END 40 INT 83 DEX 61 CHA 96 LUC 75  
PSI 44

Significant skills: Computer Operation 66  
Languages (Klingonese) 63  
Marksmanship (modern) 12  
Personal combat (unarmed) 77  
(The ambassador is a martial arts enthusiast)

### KLINGON SECURITY CHIEF

STR 78 END 73 INT 65 DEX 63 CHA 45 LUC 20  
PSI 15

Significant skills: Marksmanship (modern) 60  
Pers. cmbt. (unarmed) 62  
Starship security 55  
Small unit tactics 68  
Interrogation 59

### TYPICAL KLINGON GUARD

See "non-player character races" section in rules book.

### TYPICAL KLINGON SENIOR OFFICER

Use same statistics as Klingon Captain under "non-player character races" section of the rule book.

TYPICAL KLINGON JUNIOR OFFICER/TECHNICIAN  
STR 55 END 55 INT 50 DEX 55 CHA 40 LUC 20  
PSI 10

Significant skills: Marksmanship (modern) 40  
Pers. cmbt. (unarmed) 30

### TYPICAL KLINGON LOWER-GRADE CREW

STR 55 END 55 INT 45 DEX 55 CHA 20 LUC 20  
PSI 10

Significant skills: Marksmanship (modern) 25  
Pers. cmbt. (unarmed) 35

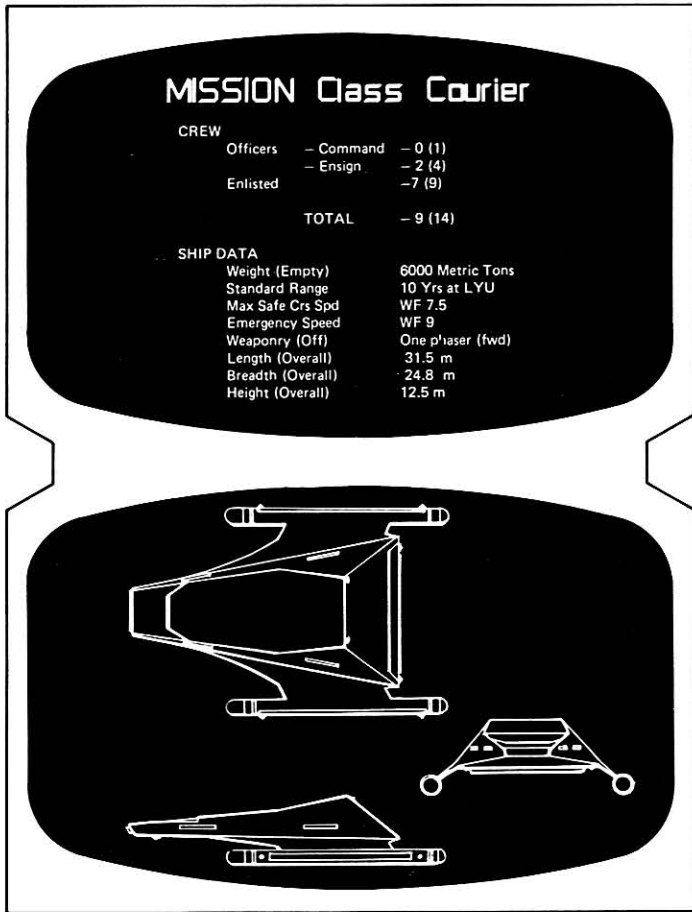

**SHIP BACKGROUND**

Designed primarily as a courier ship, the class has been given serial numbers in 3 types: courier; research, small; and transport, small, manned. Crew composition depends on mission. Crew listings above are for the transport and courier versions. The ship has 2 normal height (3m) decks and 1 smaller (2m) deck. Top deck has engineering. Lowest deck has bridge (fwd), cargo space, and 1-3 man transporter. Center deck has crew quarters and gallery, which acts as a small lounge.

**SHIP NAMES**

Couriers are named after famous diplomats. Research ships are named after scientists, and transports are named after Naval officers of history. Courier ships use the hull number range 13500 - 13999. Research ships use the hull series 16600 - 16699. Transports use the series 61000 - 61399. Examples are below.

Mission	NCC-13500	Coura	NCC-13501
Peton	NCC-13502	Galileo	NCC-16600
Huygens	NCC-16601	Kuiper	NCC-16602
Jgonas	NCC-61000	Jones	NCC-61001
Walkad	NCC-61002		

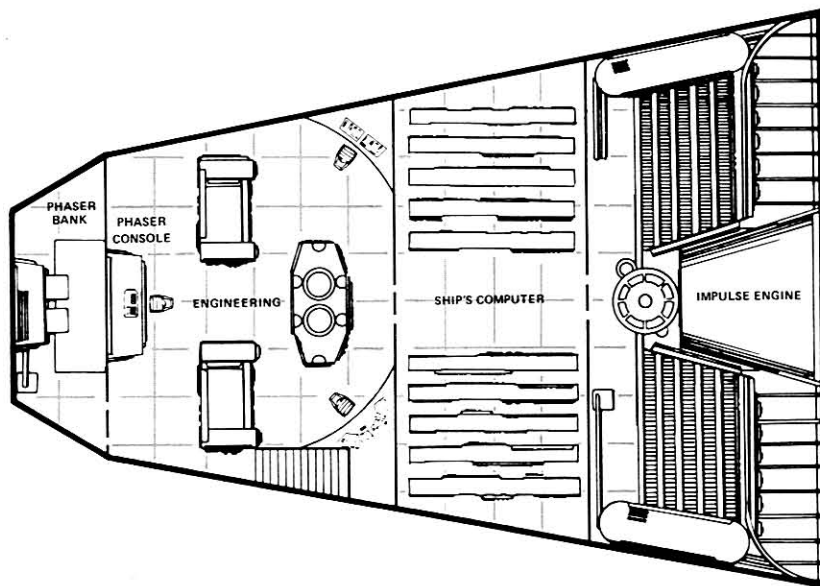

**TOP DECK**



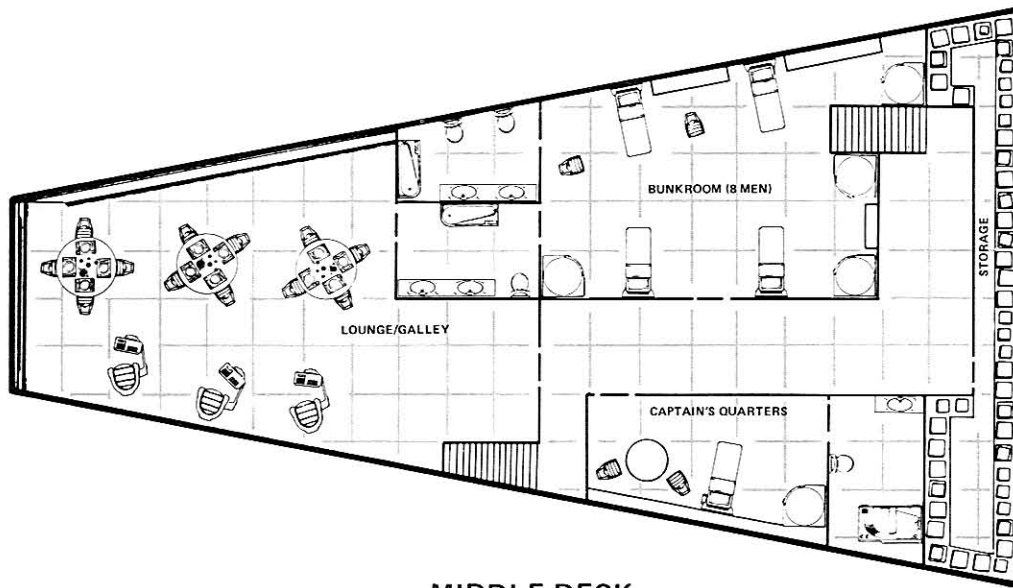

MIDDLE DECK

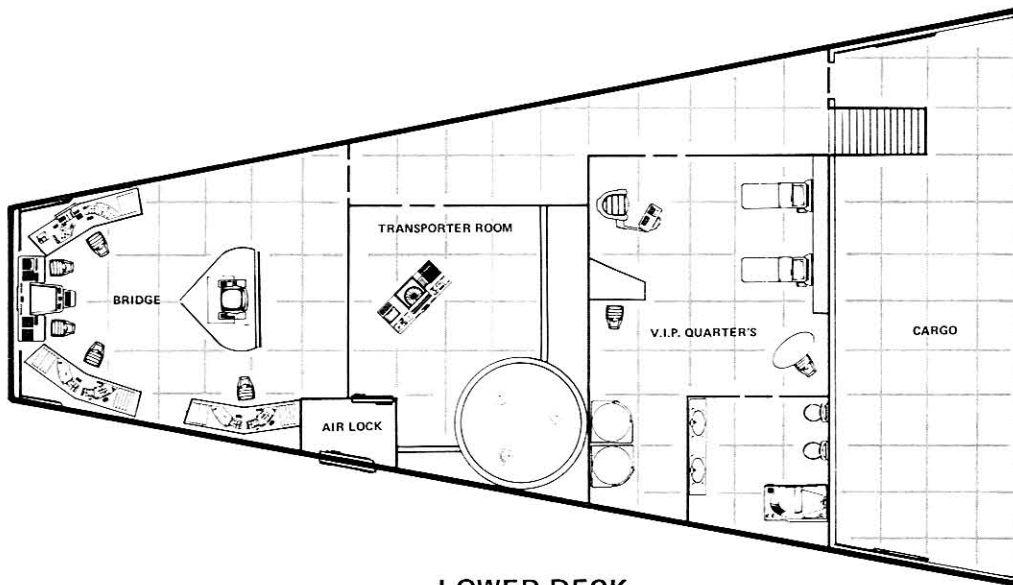

LOWER DECK

This section is different on the various types of ships.  
 V.I.P. Quarter's on Courier ships.  
 Research Lab on Research ships.  
 Cargo bay on Transport ships.

SHIP RECOGNITION HANDBOOK :

CONSTITUTION CLASS HEAVY CRUISER

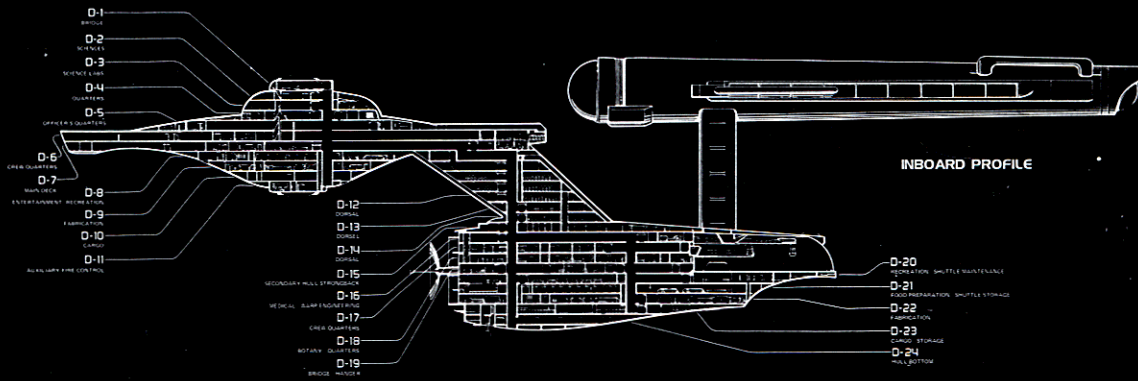

SHIP RECOGNITION HANDBOOK :

KLINGON EMPIRE D-7 CLASS BATTLECRUISER

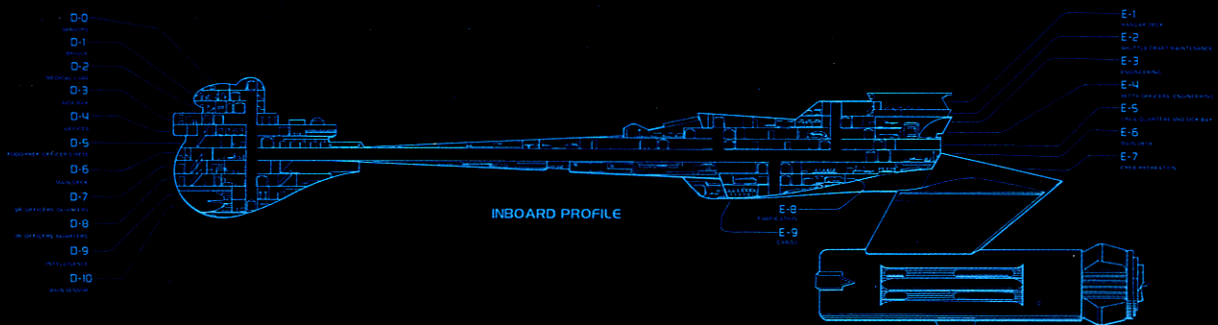



UNITED FEDERATION OF PLANETS  
STAR FLEET ACADEMY

SHIP RECOGNITION HANDBOOK  
FRIENDLY POWERS  
UFP STAR FLEET  
CONSTITUTION CLASS HEAVY CRUISER

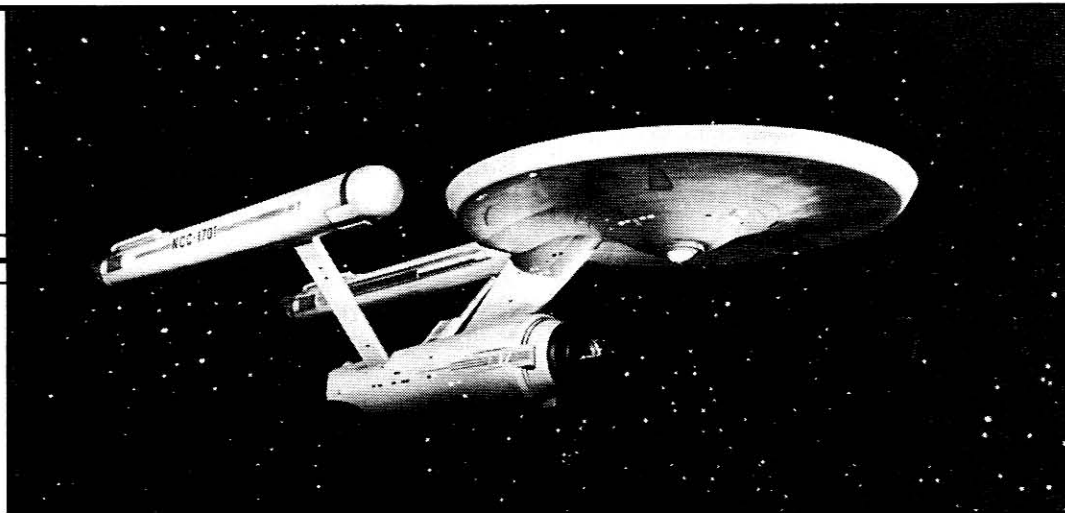

Original manual property of Star Fleet Academy, United Federation of Planets. Unauthorized possession is prohibited by Federation Code A639, paragraph 85, and is punishable by fine, imprisonment or both.

Popular edition published by permission of Star Fleet Command, as granted Stardate 8212.17. Copyright 1982 FASA Corporation. All rights reserved.

For use with ship recognition deck plans—Constitution class heavy cruiser

#### DIMENSIONS

Overall length	289 m
Overall width	127 m
Overall height	73 m
Deck ceiling height	2.5 m

Weight (empty) 190000 metric tons

#### MOBILITY DATA

Max safe cruising speed	WF 6
Emergency speed	WF 8

#### ARMAMENTS

Phasers	3 banks of 2
Mounted upper main hull (P/S) and lower main hull (fwd center)	
Photon torpedoes	2 tubes
Mounted upper main hull (top bubble fwd)	

#### OTHER FEATURES

Transporters	
6-person standard use	4
22-person emergency	5
Cargo	2
Shuttlecraft	6
(More than minimum number may be carried, at Captain's discretion.)	
Tractor Beams	
Lower secondary hull (fwd)	1
Main propulsion	
Warp nacelles	2 (P/S)
Impulse drive	1 (aft decks 6 & 7)

#### EMERGENCY SEPARATION

Under extreme circumstances, it is possible to separate the saucer-shaped main hull from the dorsal connector/engineering hull combination and operate both sections independently at sublight speeds. Such separation has never taken place during the active service of the Constitution class heavy cruisers, but it could be done in case of dire emergency.

To implement separation, the ship must first slow to sublight speed. If performed as part of an abandoned ship situation, the crippled portion of the ship is evacuated into the other section. The sections are then separated by activation of explosive bolts at the joint.

The saucer-shaped main hull is then controlled by the regular bridge while the secondary hull (with dorsal, and warp pods) can be controlled from the auxiliary bridge forward on deck 19.



After separation, the saucer can maneuver at up to .96 lightspeed on the main impulse engines located at the aft end of the saucer. This hull does not contain warp engine pods, and so does not have sufficient power to operate combat shielding. (Anti-collision shields are run off battery power.) Phaser weaponry is likewise powerless, but photon torpedo tubes can be armed once each without exhausting power reserves.

The separated secondary hull has full available warp pod power for shielding, but no weapons are mounted on the secondary hull. It is not capable of warp speed, since the structural integrity of the ship has been compromised somewhat by separation. The ship can proceed, using warp power, at up to .98 lightspeed, however.

The secondary hull is capable of full self-destruct, since it has the warp nacelles. The primary hull can initiate self-destruct powerful enough to atomize itself, but no damage from this type of explosion is likely to be taken by nearby shipping.

Once separated, the two sections cannot be re-joined, short of the use of major shipyard facilities or specially-equipped workcrews from such a facility.

#### CREW COMPLEMENT

COMMAND	43
ENSIGN GRADE	387
TOTAL	430

#### HULL NUMBERS AND NAMES

(Only 13 of these vessels have been built so far. More may be commissioned. 4 have been destroyed at the time of this writing. These are marked below as \*. Construction of replacements for these vessels is underway, and they will most likely be commissioned with the same names as the originals.)

CONSTELLATION	NCC 1017 *
CONSTITUTION (Class)	NCC 1700
DEFIANT	NCC 1764 *
ENTERPRISE	NCC 1701
EXCALIBUR	NCC 1664 *
EXETER	NCC 1672
FARRAGUT	NCC 1647
HOOD	NCC 1703
INTREPID	NCC 1631 *
LEXINGTON	NCC 1709
POTEMKIN	NCC 1702
REPUBLIC	NCC 1373
YORKTOWN	NCC 1717

#### SHUTTLECRAFT

The shuttlecraft carried on board many Star Fleet vessels are very important in many landing party situations. Shuttles are used to transport landing parties when the transporter is unusable or impractical for some reason. Shuttles can serve as small courier vessels as well.

Every Starbase and most small Star Fleet outposts have shuttlecraft of standard design berthed at that base. Many larger craft in the fleet carry shuttles in "shuttle bays".

(Constitution class starships, for instance, carry an assigned minimum of six shuttles, though some may be in non-operational condition at times. Individual captains may choose to carry more shuttles if they desire, and many do. The U.S.S. Enterprise, for instance, usually has seven or more...)

There are also "floating" shuttlecraft operated by Star Fleet. These shuttles are used by any facility that has them, being taken over by the ship or facility at the destination end. The use of "floaters" is convenient when you need an extra shuttle, but inconvenient when a "floater" must be serviced, or when too many "floaters" accumulate at one facility. Generally speaking, "floating" shuttles are found in worse state of disrepair than assigned shuttles, requiring a % dice roll every time one is used for a major flight (interplanetary or harsh conditions landing). If the roll is 05 or less, the shuttle has a minor breakdown in flight and must be repaired. Repairs will take a number of hours equal to a 1D10 roll, and require a successful save on Shuttlecraft Systems Technology at the end of that time. (If the roll fails, it can be repeated every hour until it succeeds, or until it has failed five times – in which case the shuttle can not be repaired in flight and a distress signal must be sent and help awaited.)

The basic Star Fleet shuttlecraft is a well-engineered standard design. Parts and service are available at nearly every Federation outpost of any appreciable size, and on any star vessel carrying them. A few have even been sold for civilian use.

The standard shuttlecraft carries up to 7 people comfortably, but can be operated easily by one person with a minimum Shuttlecraft Pilot skill of 10. In a pinch, it can actually carry up to 12 persons on a short hop from orbit to planet's surface, but it's life support systems will not support such a load for very long. For this reason, and because there are no chairs for more than the standard compliment of 7, it would never be used to carry more except in extreme emergency.

Shuttlecraft are not intended for faster-than-light travel, possessing only an advanced ion-propulsion drive similar in some respects to standard impulse drives. Maximum speed is .89 of lightspeed. Shuttles are not armed in Star Fleet, though it is possible that a civilian-owned surplus shuttle might have been rigged with a single small phaser.

Takeoff and landing is done vertically, on three sturdy landing pads. Shuttles are built to last, and some in service have been around over 20 years! During that time, there have been only a few cosmetic and electronic design changes and additions. Shuttles do not have deflector shields, other than for protection against small meteors and other space debris. Any single hit with ship's weaponry



will destroy one (though a LUC save on the pilot should be made if one is fired on, with success meaning a near miss on such a small target). For this reason, shuttles have no real effect on the ship combat game. (Despite rumors to the contrary, shuttles are not used in warfare – at least not by the Federation!)

In recent years, one special type of shuttlecraft is being tested for possible addition to Star Fleet standard equipment. The *aquashuttle*, developed for “landings” on water-covered worlds, bears little resemblance to the standard shuttle, though it has a number of similarities internally. (Many of the same parts can be used, in fact, so an aquashuttle can be serviced anywhere a standard shuttle can).

The aquashuttle carries a maximum normal load of six passengers, with an emergency load limit of 10 for short hops. It is capable of interstellar flight at a maximum speed of .82 lightspeed. It can also submerge in water (or any similar fluid) to a depth of 1200 meters and travel at 70 kilometers an hour. It has specially padded and belted seats to alleviate problems with rough seas.

Unlike the standard shuttle, the aquashuttle is equipped with a single forward-mounted phaser cannon, designed for use on dangerous undersea life. This weapon would be useless as a space combat weapon, except against a totally unarmed ship. Against planetside targets, treat it as much damage at each setting as a phaser rifle.

The aquashuttle has a dorsal observation bubble with two seats and panels controlling a number of underwater detection and research instruments. These instruments work much like underwater tricorders, and can be treated as such, combining science and medical functions, but with double the effective range. Someone must be seated in the bubble for these instruments to be operated.

Aquashuttles are not yet standard equipment on Star Fleet vessels. They are being tested on a number of Constitution class vessels (including the U.S.S. Enterprise), and other large vessels. Other specialized shuttle designs are in the design stages, with some already being tested.

All shuttlecraft carry registration numbers corresponding to their home ship, followed by a slash and the shuttle number. (Aquashuttles follow this with an “A”.) Starbase and other permanent ground-based shuttles sport a four-digit base number instead of the ship registration number. “Floating” shuttles bear four alphabetic characters, a slash, and a single digit to designate them.

(EXAMPLES: U.S.S. Enterprise shuttle NCC-1701/7; Starbase Three shuttle NCC-6994/9; “Floating” shuttle NCC-KGGX/2).

Naming of shuttles is left strictly up to base or starship personnel. Many ships and bases have a unifying theme for their shuttles. The U.S.S. Enterprise, for instance, names all their shuttles after famous explorers and scientific discoverers. Thus they have standard shuttles with names like “Galileo” and “Columbus”, and an aquashuttle named “Cousteau”. On some ships, the christening of a new shuttle is a great excuse for a party. (Morale officers, take note!)

## GENERAL NOTES

1) Crews consist of officer grades only. These are the elite of Star Fleet. All crewmembers rank Ensign or above.

2) Crews on most ships generally run 1/4 to 1/3 female.

3) Crews generally are drawn primarily from one race. Usually less than 2% are from other Federation races. This is to establish a cohesive social environment and to minimize the number of separate environments, medical supply stocks, and food stocks that must be carried.

4) Ship’s duties to include:

- A. Investigation/exploration of unknown worlds/civilizations.
- B. Providing aid to established colonies.
- C. Acting as a diplomatic envoy of the Federation.
- D. Enforcing trade laws.
- E. Acting defensively if need be in it’s assigned sector.
- F. Operating independently of higher authority when needed.

## DECK DESCRIPTIONS

### MAIN HULL

#### DECK 0: Sensors

Sensor equipment is located here under a dome. Access is through the ceiling of deck 1. This equipment supplements readings received from the main dish.

#### DECK 1: Bridge

##### Center deck

This central ‘command area’ is built lower than the surrounding deck. The ship’s captain’s command chair is swivel mounted so that he/she may swing to observe any station on deck. The chair arm-rests contain controls for the ship’s log, computer access, and ship intercom.

Immediately in front of the captain’s chair are the helm (port and navigation station (starboard)). Their combined panels have controls for ship’s weaponry, deflectors, and navigation.

Surrounding this central area is a raised platform containing 8 work stations. Starting at the turbo-lift doors and moving counter-clockwise these stations are:

**COMMUNICATIONS:** Contains controls for all forms of communications, external and internal. Access to computer banks makes cross-reference possible for various forms of communications, in addition to access to all known codes used by any and all life forms. Internal communications can be to any individual station or room in the ship, several at a time, or ship-wide communications.

**SCIENCES/COMPUTER:** Controls all sensor information received. Virtually any type of data is capable of being received via sensors. Data received is analyzed, evaluated, and stored in the ship’s computer. This computer stores an enormous amount of information (see Computer section of **STAR TREK: The Role-Playing Game** rules) on

almost any topic. Information obtained from the computer can be fed to any viewing screen or intercom station on board. The small hooded viewscreen to the left of the station (as you look at it) is capable of presenting any visual data stored, including photos, graphs, tables, etc. A standard private reception earplug provides audio data from various sources (many courtesy the communications station). All data (visual and audio) is stored on molecular stasis record chips.

**NAVIGATION SUBSYSTEMS STATION:** Provides visual readout on all navigational equipment and systems on board. This station is normally manned (by the assistant chief navigator) only when the ship is on alert status.

**WEAPONS SUBSYSTEMS STATION:** Monitors all weapons (offensive) systems and subsystems. Normally manned only during an alert by the weapons officer.

**WEAPONS SYSTEMS STATION:** Monitors all systems relating to defense, including deflector screen. Normally unmanned.

**MAIN VIEWSCREEN:** Not a manned station. This is a large video screen facing the helm/nav/command complex but easily seen by most bridge personnel. Through use of exterior and interior monitors, drone monitors, and transmissions from other vessels and bases, visuals are projected here electronically for the bridge personnel's use. Normally the view is in the direction of travel. A 360 degree view is possible, however. Magnification is possible up to about 1000 x normal.

**ENGINEERING SUBSYSTEMS:** Provides readouts on all subsystems. Normally unmanned.

**ENVIRONMENTAL SYSTEMS:** Monitors all environmental systems of the ship. Any changes in gravity, atmosphere, etc. are controlled and changed from here. Normally unmanned.

**ENGINEERING:** All engineering systems are monitored here. All power generation and channeling is controlled at this station. Manned by the Chief Engineer when his duties do not require his presence elsewhere.

#### DECK 2: Sciences

Forward deck, port to starboard

CHEMISTRY LAB  
ENERGY LAB

Center deck, port to starboard

BIOLOGY LAB: Used to study new life forms encountered.

GEOLOGY LAB: Used to study geological and structure of natural bodies encountered. This lab is used in conjunction with the adjacent energy lab to analyze new possibilities of fuel.

Aft of center, port to starboard

SCIENCE OFFICER'S OFFICE  
ION LAB

Aft deck

PHYSICS, UPPER LEVEL: The lab on deck 3 extends upward into this area.

DECK 3: Science labs

Forward deck

PHOTON TORPEDO BANK: 2 photon torpedo tubes and firing apparatus. Working clockwise.

BOTANICAL LABS: Besides studying new forms encountered, studies are conducted for more efficient plant life to be used in hydroponics for oxygen generation.

STORAGE: For lab equipment.

COMMUNICATIONS: Backup for bridge; acts as a switchboard for routine internal communications.

PHYSICS: Lower level of lab.

COSMOLOGY LAB

SPECIAL STUDIES: Used for any purpose deemed necessary by the Science Officer. May be used by a task force composed of personnel from many different labs and/or off-board scientists. In this instance the lab would be used as a general lab/conference/briefing facility for a group studying a special problem, such as an unknown creature or disease threatening a planet. Also used as a classroom for ship personnel.

DECK 4: Quarters

Center deck

CONFERENCE ROOM: For the use of junior officers and passengers on this deck, and for bridge personnel use.

In a ring around, as shown.

STATEROOMS: For the use of junior officers and important passengers requiring double occupancy.

Surrounding these are water storage tanks, pumps, and associated machinery.

DECK 5: Officer's quarters

(These will be dealt with in rings, starting at the center with number 1)

Ring number 1

LOUNGE AREA: Intended for senior officers, but by long-standing tradition open to any crewmember or visitor. Food service slots for snacks, drinks, etc. are present, as well as viewscreens for entertainment channels or video games.

Ring numbers 2, 3, and 4

STATEROOMS: Single occupancy rooms are for Senior Officer (Captain, Science Officer, First Officer, Chief Medical Officer, Chief Engineer, etc.) and VIPs. Double occupancy are for Junior Officers and passengers. Exact placement of specific officers' quarters varies from ship to ship.

Outer rings

MACHINERY, BATTERIES, PHASER BANK ROOMS (port and starboard upper), AIR CONDITIONING, ETC.



**DECK 6: Crew quarters**

**Aft deck**

**IMPULSE ENGINES:** Extends down into deck 7  
**ENGINEERING/IMPULSE:** Equipment, controls for impulse engines. Extends down into deck 7.

**ELEVATOR MAINTENANCE SHOP:** This area contains equipment for repair and maintenance of turbo-elevators. Computerized controls exist here for monitoring all elevator functions. Cars can be recalled here or sent to any location on a priority basis, overriding local elevator control.

**Remainder of deck**

**STATEROOMS:** Double occupancy staterooms for crew. These occupy the majority of 7 rings on this deck.

**MESS ROOMS:** Occupy center core of deck. Food is delivered via a small turbo-lift from food service facilities. This smaller lift runs parallel to normal-sized turbo lifts through the ship. Since crew operates in 3 shifts around the clock, mess rooms are used in shifts. Crew is able to more or less eat when they please during their shift, however. Those desiring to do so may get food from the various outlets scattered around the vessel (adjacent to turbo lift doors and in some lounges). They may then eat in their rooms or, when necessary, at their duty station.

**LOUNGES:** Scattered throughout the ship. These small lounges allow for crew interaction on a small scale. These small lounges contain video and musical equipment, reading material on monitors (some locations have printers to produce hard copy), and other small-scale leisure equipment (such as games). Many activities are set up, with tri-dimensional chess playoffs, bridge tournaments, and other competitive activities quite popular. Inter-divisional competitions are quite popular. Many crew members use the lounges for informal gathering places to play musical instruments and have sing-alongs.

**BRIEFING ROOM:** A small room used for crew instruction, meetings, small hearings, etc. In use almost around the clock, as instruction in all areas is strongly encouraged. Classes are held as refreshers, to impart new information, and for anyone just plain interested in broadening his/her horizons. Not all her classes held are of a "practical" nature. Informal courses in tri-dimensional chess, literature, music, etc are also held. Crewmembers with specialized knowledge can get special duty arrangements if they are willing to teach what they know. These rooms can also be reserved for private use by small groups.

**DECK 7: Main deck**

**Forward deck**

**SENSOR/DEFLECTOR EQUIPMENT**

**Aft deck**

**IMPULSE ENGINES:** From deck 6.

**Center Core**

**SHIP'S COMPUTER:** Memory banks for the ship's computer. Extends down into deck 8. These are the most extensive memory banks on board a vessel in Star Fleet. They contain the entire knowledge of the Federation.

**EMERGENCY BRIDGE:** Used if the main bridge (deck 1) is out of commission due to damage or malfunction.

(The remainder of this deck is dealt with in 'rings', with ring 1 being the innermost. Descriptions will start with the room farthest forward, then proceed clockwise.)

**Ring 1**

**HEAD**

**MEDICAL LAB:** Used for research and tests in the medical department.

**OPERATING ROOM/EXAMINING ROOM:** Used examine badly injured personnel, and for surgery.

**INTENSIVE CARE UNIT:** Used to monitor critically injured or ill. Each bed unit has built-in monitors. (See **STAR TREK: The Role-Playing Game** medical section)

**HEAD**

**MEDICAL SUPPLIES STORAGE**

**CHIEF SURGEON'S LAB:** Used primarily by the Chief Surgeon and his assistants for research and studies.

**CHIEF SURGEON'S OFFICE**

**INTENSIVE CARE UNIT**

**Ring 2**

**CONVALESCENT WARD:** For the recovery of critical patients.

**HEAD**

**CONVALESCENT WARD**

**THERAPEUTIC BATHS**

**HEAD**

**STATEROOM:** For Medical personnel

**DENTAL UNIT (3 Rooms)**

**OBSTETRICS**

**SHIP'S CAPTAIN'S OFFICE:** Reception area outside in the smaller room. This is the office used when Captain is not on the bridge or in his quarters. Used for formal individual or small meetings. He will normally use the outer office of his quarters for informal talks. Has a private bathroom.

**CHART ROOM:** A holdover from the non-electronic/computer age. Although all navigational data is stored in the computer, the old naval tradition of a chart room still is strong. This room contains hard copies of navigational charts. This room has facsimile equipment to reproduce charts and maps, and a viewscreen.

**CHIEF NAVIGATOR'S OFFICE**

**STORAGE**

**BIO-CHEMICAL LAB**

**DOCTOR'S OFFICE (2)**

**MEDICAL RESEARCH LAB:** Acts as a general purpose medical lab for all types of studies connected to this department.

**MEDICAL RECEPTIONIST**

**MEDICAL SECTION WAITING ROOM**

**NURSE'S QUARTERS/OFFICE**

**HEAD**

**CONVALESCENT WARD**

**HEAD**

**CONVALESCENT WARD**

Ring 3

**VISICOMS:** These "visual telephones" can be used to contact any area of the ship, or even to record personal messages to be beamed home. Messages are stored by the computer and sent out at regular intervals under the control of the ship's computer and the Chief Communications Officer.

**STATEROOM**

**HEAD**

**STATEROOM**

**TRANSPORTER ROOM NUMBER 2:** 6-man transporter

**TRANSPORTER ROOM NUMBER 4:** 6-man transporter

**CHAPEL:** Used for religious services, weddings, memorial services, etc.

**STATEROOMS:** (3) These, directly across from the Captain's office, could be used for VIP's.

**BRIG:** Consists of 10 cells, all with force-field protective doors (non-solid).

**MESSROOM/WAITING ROOM:** Used for security personnel on duty.

**SECURITY OFFICE:** Used by whomever is in charge of security detail on the current watch.

**BRIEFING ROOM:** This is a briefing room used primarily by bridge personnel and medical department. Used also as a staging area for personnel about to use the transporters for last-minute instructions. Used also as a de-briefing area for landing parties.

**TRANSPORTER ROOM NUMBER 3:** Transporter normally used on most vessels for landing parties.

**TRANSPORTER ROOM NUMBER 1:** 6-man transporter.

**MESSROOM:** Used primarily by medical personnel.

**LIBRARY:** Although most stations have monitors to access the ship's computer, most single staterooms do not. Therefore, personnel may be found here at almost any time, studying. Also, privacy not easily obtained in the lounges is available here. Printers to obtain hard copy are also located here.

**EXECUTIVE OFFICER'S OFFICE:** Used by the second in command.

Ring 4

**CARGO HOLDS:** Used for bulk storage of liquids and other bulk storage. Occupies the entire ring except for:

**SMALL ARMS ARSENAL:** Located directly aft/port of the **BRIEFING ROOM/SECURITY OFFICE**. This room is normally locked and guarded, either by personnel or monitor.

Ring 5/6

Consists of double-occupancy staterooms and lounges.

**DECK 8: Entertainment/Recreation**

Center core

**SHIP'S COMPUTER BANKS:** From deck 7.

Forward deck

**22-MAN TRANSPORTER:** Used for emergencies only, such as abandoning ship.

Aft of this, moving clockwise

**LOUNGE**

**RECREATION CENTER:** Through the use of holographic projections and other complicated scenery, it is possible here to 'cure homesickness' to some extent. The machinery is capable of producing, with the help of the ship's computer, realistic simulations of the sky, wind, vegetation, animals, etc. of the user's home planet, or any other setting desired. Normally, a setting is kept simulating a park-like environment associated with the main crew complement's home world(s). This equipment could be dangerous in the wrong hands (or if it malfunctions), as it is quite capable of creating deadly environments, such as an Earth blizzard, hurricane-like winds, even a flood. This area is constantly monitored by the ship's computer to avoid such problems.

**22-MAN TRANSPORTER**

**SHIP'S LAUNDRY:** Takes clothing and breaks them down into original components, extracts foreign matter, then recreates the item in the needed shape and size. The ship's computer stores sizes, so clothing is always immediately available.

**FOOD PREPARATION FACILITIES:** Automated food preparation for the ship. Food is sent via small turbo-lifts to the entire ship. Almost any type of food or drink can be recreated here, with a menu of thousands of items from all over the Federation.

**22-MAN TRANSPORTER**

**GYMNASIUM:** A large room, complete with equipment, showers, and lockers. Besides allowing crew members to work out on their own, mandatory classes are held to keep personnel in shape. This area has local gravity controls for simulation of high-gravity worlds or zero-G combat exercises.

**ENTERTAINMENT FACILITY:** For large group activity, such as receptions, movies, etc. Holographic facilities are used here also, really making the viewer a part of the story. Holographic projected 'mail call' is done here also.

Outer ring

**AIR CONDITIONING EQUIPMENT**

**FRESH WATER STORAGE**

**DECK 9: Fabrication**

Center core

**MATERIALS RECLAMATION FACILITY:** All material thrown away is channeled through here to be broken down into components. From here components go to bulk storage or fabrication units for manufacturing.

Ring Number 1

Stbd/Fwd

**ORGANIC FABRICATION**

Stbd/Aft

**NON-ORGANIC METALLIC FABRICATION**

Port/Aft

**SANITARY WASTES RECOVERY SYSTEMS:** All wastes are brought here for recycling. Nothing is wasted aboard ship.

Port/Fwd

**NON-ORGANIC NON-METALLIC FABRICATION**





Outer ring  
RAW MATERIALS STORAGE

DECK 10: Cargo  
Aft deck  
CARGO TRANSPORTER (See **STAR TREK: The Role-Playing Game** rules on transporters.)

Remainder of deck  
CARGO HOLDS  
RAW MATERIAL STORAGE

DECK 11: Auxiliary Fire Control  
Center deck  
AUXILIARY FIRE CONTROL: From this location, phaser weaponry can be fired manually, in case equipment allowing remote firing from the bridge is damaged.

Forward deck  
FORWARD PHASER BANK

Remainder of deck  
RAW MATERIAL STORAGE

DECK 11A: Lower sensor platform  
SENSOR EQUIPMENT

DECK 9—DORSAL  
AUXILIARY MACHINERY ROOM

OBSERVATION LOUNGE: These occupy most of the small dorsal decks. Having 'windows' to outside, these are popular informal gathering areas.

DECK 11—DORSAL

DECK 13—LOUNGE  
OBSERVATION LOUNGE

DECK 12—DORSAL  
CAPTAIN'S VERANDA: An observation lounge used by the command officers, especially for guests and dignitaries.

DECK 13—LOUNGE

DECK 14—DORSAL  
LOUNGE (Central)  
STORAGE (Outer)

SECONDARY HULL (ENGINEERING HULL)

DECK 15: SECONDARY HULL STRONGBACK  
Center of hull (Fwd to Aft)  
SENSOR EQUIPMENT ACCESS: Access to main sensor dish equipment is through here.  
VISICOMS  
DORSAL AND SECONDARY HULL AIR CONDITIONING EQUIPMENT

Outer structure is support pylons, water tanks, and dorsal connectors.

DECK 16: Medical/Warp Engineering

Forward deck, port to starboard  
HEAD  
DENTAL OFFICES  
DOCTOR'S OFFICE  
MEDICAL RESEARCH LAB  
STORAGE LOCKER

Continuing Aft, Stbd of corridor  
STORAGE

Port of Corridor  
OPERATING/EXAMINING ROOM  
INTENSIVE CARE UNIT

Aft of Medical Unit  
MAINTENANCE SHOPS (8): Used by engineering for all types of repairs. Some oft-used parts are stored here, although fabrication units can produce most items as needed.

Aft of Dental Offices, stbd side of corridor  
RECEPTION/NURSES STATION  
CONVALESCENT WARDS (2)  
TURBO-ELEVATOR REPAIR SHOPS: Lift units are brought here for repair and storage.

Port side of corridor  
MEDICAL STORAGE  
MEDICAL OFFICE: Usually the Assistant Chef Surgeon.  
PRIVACY ROOMS: Used for private meditation.

Aft of turbo repair  
ENGINEERING COMPUTERS: Although a part of the main ship computer, separate facilities are maintained for easy access by engineering department.

Aft of shops/computer  
WARP ENGINEERING: Controls and panels for both warp engines. Aft of this is access to Jeffries tube to engines. Support pylons for warp drives connect here.

Aft deck  
UPPER HANGAR DECK/HANGAR DOORS: This extends down 3 more decks.

**DECK 17: Crew quarters**

Forward deck, port to starboard

MESSROOM

BOTANICAL: Opening from deck 18 for tall vegetation.

Center deck

STATEROOMS: 12 double occupancy quarters for personnel assigned to medical/engineering in this hull.

Outer deck, port and stbd, fwd to aft

MESSROOM

ENVIRONMENTAL SUIT LOCKERS: These are scattered throughout the ship on most decks.

STORAGE

Aft deck

OBSERVATION GALLERY: Observation area for shuttle facilities. This area oft times is crowded with off-duty personnel when shuttles are in use, as minor diversions are welcome at times.

CONTROL TOWER: (One each side) Operation of shuttle bay doors, shuttle elevator/turntable, atmosphere control, and cargo handling in the bay are handled from here.

**DECK 18: Botany/quarters**

(Fwd of deck is main sensor array)

Forward deck, port to starboard

HYDROPONICS LAB: Fresh fruit and vegetables, along with various other plants are grown here. There is no possible way enough food can be grown on board for the entire crew; the truth is, most crew members are not used to this type of food anyway. However, some food is grown for special occasions, as are flowers for use in weddings, etc. This section is manned by personnel from the botanical section. There is space devoted on a request basis for hobbyists.

BOTANY SECTION: (Lower level) Used to maintain plant life for study or transport.

Center deck, Port

MESSROOM

LIBRARY

ENVIRONMENTAL SUIT LOCKER

Aft deck

SHUTTLECRAFT HANGAR (open)

**DECK 19: Bridge, Hangar**

Forward deck

BRIDGE/SHIP'S COMPUTER: Duplicate of primary hull bridge/computer. Used when secondary hull operates independently of main hull.

Aft of BRIDGE, port to starboard

BRIEFING ROOM: Used primarily for personnel using shuttlecraft.

STATEROOMS

Center deck

STATEROOMS (To shuttle deck)

Outer hull, port side

BRIG

SECURITY SECTION

SMALL ARMS ARSENAL

STORAGE

ENVIRONMENTAL SUIT LOCKER

Outer hull, stbd side

STORAGE

STORAGE

ENVIRONMENTAL SUIT LOCKER

Aft deck

HANGAR DECK. Located center is elevator/turntable to lower deck. This ship class carries 6 shuttlecraft, normally stored below this deck. Usually at least one shuttlecraft is ready for takeoff at all times.

**DECK 20: Recreation/shuttle maintenance**

Forward deck

SUN DECK: Relaxation area for off-duty personnel, used to 'get a tan'. This deck is not, of course, actually exposed to radiation from outside the ship. Sunny tan-producing conditions are simulated with safe ultraviolet lighting disguised with holograms.

POOL: Full-size swimming pool (18.3 m) available for use by aquatic alien races such as the Aquans of Argo.

Aft of pool, port

RECREATION AREA: As in main hull.

Aft of pool, stbd

SHOWER ROOMS

LOCKER ROOMS

GYMNASIUM

Center deck, port to starboard

STORAGE

ENVIRONMENTAL SUIT LOCKER

STORAGE BATTERIES

STORAGE BATTERIES

ENVIRONMENTAL SUIT LOCKER

STORAGE

Aft deck, fore to aft

SHUTTLECRAFT MAINTENANCE AREA: Repair area with shops and parts storage.

STORAGE

CARGO HOLDS

HANGAR DOORS OPERATING MACHINERY

**DECK 21: Food preparation, shuttle storage**

Forward deck

POOL MACHINERY

POOL (Second level)

STORAGE: Both sides of pool



Center deck, fwd to aft, port to starboard  
SHIP'S LAUNDRY  
MATERIALS RECLAMATION FACILITY  
FOOD PREPARATION: Supplements primary hull facilities in addition to serving secondary and dorsal hulls.

Aft deck  
SHUTTLECRAFT STORAGE AREA: Home to shuttles when not being serviced or on "standby".

DECK 22: Fabrication

Forward deck, port to starboard  
SANITARY WASTES RECOVERY  
22-MAN TRANSPORTER (Emergency use only)  
ENVIRONMENTAL SUIT LOCKER  
MANUAL FOOD PREPARATION: Used by those personnel wishing to prepare food without the aid of the food preparation machinery. Available to those hobbyists who like to cook.  
MESSROOM: For food prepared manually.  
22-MAN TRANSPORTER  
ENVIRONMENTAL SUIT LOCKER

Center deck, port to starboard  
RAW MATERIALS STORAGE: along port side.  
ORGANIC FABRICATION  
NON-ORGANIC NON-METALLIC FABRICATION  
REFRIGERATED AND FROZEN MATERIALS STORAGE: Along all of stbd side.

Aft deck  
STORAGE: As per rest of deck  
NON-ORGANIC METALLIC FABRICATION

DECK 23: Cargo, storage

Forward deck, port to starboard  
STORAGE  
TRACTOR BEAM MACHINERY  
STORAGE

Rest of deck, except for aft, is STORAGE

Aft deck  
CARGO TRANSPORTER

DECK 24: Hull bottom

Forward deck  
TRACTOR BEAM PROJECTOR

Rest of deck is storage, cargo holds.

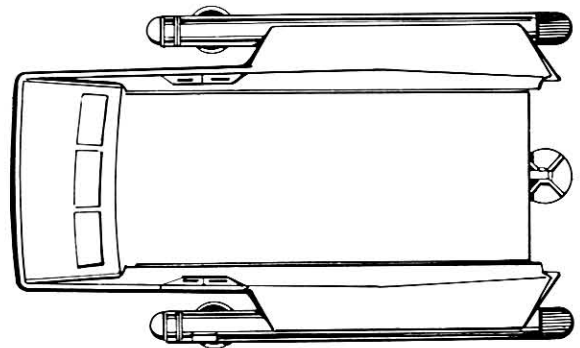

SHUTTLECRAFT PLAN VIEW

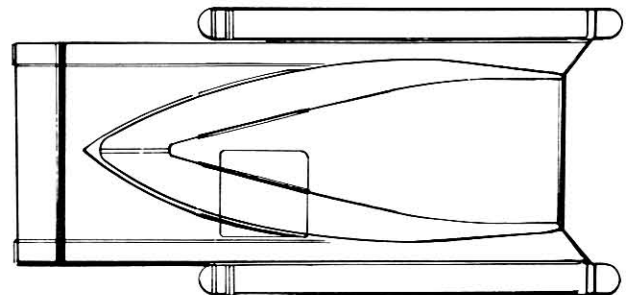

AQUASHUTTLE PLAN VIEW

**UNITED FEDERATION OF PLANETS  
STAR FLEET ACADEMY**

**SHIP RECOGNITION HANDBOOK  
UNFRIENDLY POWERS  
KLINGON EMPIRE  
D-7 CLASS BATTLECRUISER**

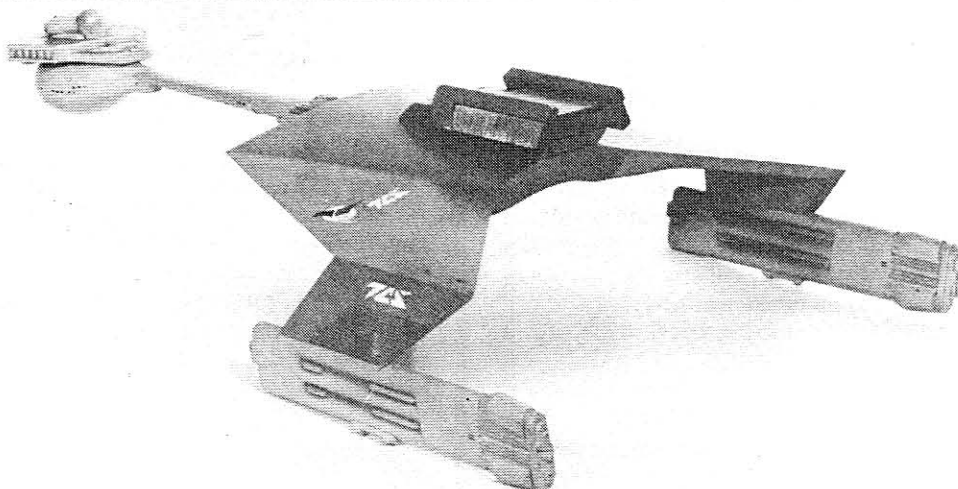

Original manual property of Star Fleet Academy, United Federation of Planets. Unauthorized possession is prohibited by Federation Code A639, paragraph 85, and is punishable by fine, imprisonment or both.

Popular edition published by permission of Star Fleet Command, as granted Stardate 8212.12. Copyright 1982 FASA Corporation. All rights reserved.

For use with ship recognition deck plans-Klingon D-7 Battlecruiser

**DIMENSIONS**

Overall Length	216 m
Overall Width	152 m
Overall Height	55 m
Weight (empty)	110,000 metric tons
Deck ceiling height	2.4 m

**MOBILITY DATA**

Max safe cruising speed	WF 6
Emergency speed	WF 8

**ARMAMENT**

**Disruptors** 2 banks of 2  
 Mounted port and starboard on forward edge of warp engine nacelles  
 (Note: This is standard armament as of commissioning of the class ship. Later versions may be armed differently. See armament info under "Variations").

**OTHER FEATURES**

<b>Transporters</b>	
6-person standard use	3
18-person emergency	1
22-person combat drop cargo	5
	2
<b>Shuttlecraft</b>	5
<b>Tractor Beams</b>	
Bottom of forward pod	2 (P/S)
Forward of hangar deck	3
Entrance - hangar deck	2 (P/S)
<b>Main propulsion units</b>	
Warp nacelles	2 (P/S)
Impulse drive	1 (aft decks 3 & 4)
Aux. impulse drive	1 (aft end of boom)
	(used only after emergency separation)

**EMERGENCY SEPARATION**

Under extreme circumstances, it is possible to separate the forward pod and boom from the main hull and operate both sections independently at sublight speed. Such separation would only be attempted if one section or the other were badly damaged, in an attempt to break off combat and escape with the other section.

To implement separation, the ship must first slow to sublight speed. A separate boom does not possess enough spare power to fire disruptor weaponry (on variants mounted with such) but a photon torpedo (on variants equipped with them) may be armed once and fired. The boom has no shielding once separated.



The separated main hull, since it has the warp engines, has enough power to operate normal shielding and weapons. It is not, however, capable of warp drive on its own, as its structural integrity has been somewhat compromised by the separation of the boom. The separate main hull is capable of up to .97 lightspeed.

The main hull, once separated, is still capable of full self-destruct. The boom section may also destroy itself completely, but since the anti-matter explosion of warp nacelles is the dangerous part of a self-destruct situation (dangerous to other shipping, that is), no damage is likely to be taken by shipyard facilities or specially-equipped workcrews from such a facility.

The usual procedure for separation involves setting the main hull (with shields and weapons) to fighting a holding action while most important officers escape in the severed boom. It is naturally not widely known among Klingon crews, but the main hull section can have its self-destruct mechanism activated by remote signal from the boom. Desperate Klingon captains are suspected of having used this capability more than once to inflict damage on pursuing ships and giving the boom section time to escape.

#### CREW COMPLEMENT

##### NAVAL PERSONNEL

COMMAND	32
ENSIGN	
(equiv. Klingon grade)	60
ENLISTED	260
TOTAL	352

##### COMBAT TROOPS

OFFICERS	5
NCOs	15
ENLISTED	200
TOTAL	220

(NOTE: Klingon battlecruisers of this type have been known to carry larger numbers of troops by shopping most in cryothermia (cold-sleep). Cold-sleep capsules can be stored in the major cargo holds, with a temporary reawakening facility set up in one hold upon reaching the destination world or just before. Up to five times as many troops can be carried by a ship otherwise free of cargo in this manner. Since 5% of all troops shipped this way die during reawakening, officers and non-coms are usually transported awake, with only enlisted combat personnel placed in cold-sleep). (Gamemasters who have need for determining whether or not someone survives Klingon cold-sleep techniques should roll % dice for each individual checked. A result of 05 or less indicates death upon awakening).

#### KLINGON SHUTTLECRAFT

The Klingon shuttlecraft is roughly the same size as the Federation standard shuttle. It can be operated by one person but can carry a total of seven plus small equipment. The shuttle is capable of reaching a speed of .83 lightspeed. It carries a disruptor cannon in a front top turret. (Twice the range and damage of a disruptor rifle). This cannon is useless in ship-to-ship combat. It is used mainly for defense of the shuttle while on the ground.

#### VARIANTS IN D-7 PARAMETERS

NOTE: Variant ID number/letter combinations are Star Fleet designations, as the variant IDs used by the Klingons themselves are as yet unknown. Also, this list may not be exhaustive. It covers all D7 variants encountered up to the time this manual was prepared. Data that is approximate is noted as such, as most information has been gathered from encounters. This is continuously being augmented by Star Fleet Intelligence units.

(Game-related data will be given in parentheses as needed. This will allow those who desire it the option of drawing up needed control sheets to incorporate the variants in their games).

D7A Class ship, as far as we know. This was the first D7 encountered by Star Fleet. There are 4 disruptors in 2 banks of 2. They are located on the engine pods, 2 port and 2 starboard. (This is the D7 given on the full and gamemaster-controlled panels). This is by far the most common type of D7 in use. Number in use is unknown, however. Crew: 352 Naval, 220 combat.

D7B This is an up-gunned model of the D7A, the only known difference being the addition of 3 more disruptors under the forward pod. (These are the same in game terms as the D7A. They have a forward firing arc.) This model was encountered after the signing of the Organian treaty. It has been seen only outside the Organian Treaty Zone.

D7C This is a troop transport version. 1100 combat troops can be carried in this version. (See previous notes). Normal D7A weaponry is still carried.

D7P This variant is phaser-type weaponry. Rumor has it that only one vessel was thus equipped. The vessel supposedly exploded when the weaponry was used. This has not been confirmed.

D7R This is the variant in Romulan use. (Many notes on this variant are given in the deck descriptions). The ship carries 4 disruptors as per the D7A. It also carries a cloaking device and a plasma weapon (as per the Romulan Bird of Prey). The plasma weapon is located underneath the forward pod. The Romulans are known to have at least 8 of these vessels in use.

D7S Only one of these is known to exist. There may be more in use, however. Appears to be a normal D7A with one addition — a stasis projector. This is a beam weapon that effectively blocks the use of warp or impulse power on the target ship. The target is incapable of movement, transporter, or weapons use. (Range is 10 hexes; "to hit" is 1-10 at a range of 1, 1-9 at 2 hexes, 1-8 at 3 hexes, and so on. If the beam hits, the stasis field takes effect immediately).

The weapon has several drawbacks which have prevented its widespread use. First, it drains a lot of power from the firing vessel. (Movement limited to 1 hex per turn. No other weapon or shield use). Second, the beam cannot be used on more than one target at a time. Any attempt to do so breaks the hold on the original target. Third, the beam must be kept in use continuously to maintain the stasis field effect. (Only the first "to hit" must be

rolled. Consecutive maintenance on the target is automatic). Once the beam is turned off, power returns to the target immediately. Fourth, the beam can be maintained only for a limited time - 10 minutes. (60 game turns)

(It can be seen that two D7s, one with the stasis projector, and the other almost any type, can be quite deadly, if the stasis field can be turned on successfully on a lone ship. The other Klingon can then 'pound' the target into submission).

**D7W** This vessel uses a new type of warp drive capable of producing more power in the same amount of engine space. (Each warp engine can produce 25 points of power for use). Maneuverability is not increased (5 power points to produce 1 maneuver point). Improved shields, however, seem to make up for this. (Shields can go up to 15 points of power). Offensive weaponry is not affected, however.

#### DECK DESCRIPTIONS — FORWARD POD DECKS

**DECK 0:** Secondary sensors

**SENSOR DOME:** The hull covering this deck is transparent to sensors and acts as a protective bubble for secondary sensor devices so they can be serviced easily.

**DECK 1:** Bridge

**BRIDGE:** The major control center of the ship is here. The main viewscreen is forward, with the command chair on a swivel mount in the center. To port of the screen is the main sciences console, with the communications console to starboard. Swivel-mounted gunners' console/couches are to the extreme port and starboard of the command chair. These control all weapons functions. Aft of the command chair and to starboard is the navigation console. Helm controls are to port, with the two units connected by a low bank of control machinery.

**DECK 2:** Life sciences

Port side

**BIOCHEMISTRY LAB:** This lab is used to study life forms encountered. Although this is not a research-exploration oriented vessel (as the Constitution class vessels of the Federation), some basic research facilities are maintained.

Starboard side

**MEDICAL RESEARCH LAB:** This lab is sometimes used for development of truth drugs, poisons, torture techniques, and other more subtle additions to the Klingon biochemical arsenal, as well as for more mundane medical research. The lab is equipped with a monitor bed and complete diagnostic/surgical unit.

**DECK 3:** Life sciences

Forward deck, port to starboard

**CHIEF SURGEON'S OFFICE**

**MEDICAL PATHOLOGY LAB**

**SUPPLY STORAGE**

**OPERATING ROOM:** Contains two monitor beds and diagnostic/surgical units.

**MEDICAL RECEPTION ROOM:** Usually manned by an orderly, who handles minor cases.

**INTENSIVE CARE UNIT:** Contains five monitor beds and two desks with monitor repeater screens.

**HEAD**

Extreme port and starboard

**LOUNGE/WAITING ROOM**

Center deck, port to starboard

**PHYSICAL THERAPY ROOM**

**ASST. MEDICAL OFFICER'S OFFICE**

**MEDICAL OFFICE (JUNIOR OFFICERS)**

**RECOVERY WARD:** Beds here are not equipped with medical monitors.

**HEAD**

Aft deck

**AUXILIARY COMPUTER BANKS — LIFE SCIENCES**

**DECK 4:** Command offices

Forward deck, port to starboard

**TRANSPORTER ROOM 4P:** This station (and its twin to starboard) is used for most standard missions, landing parties, etc.

**BRIEFING ROOM 4A:** Computer readout screen recessed below table emblem, controlled from any table edge station.

**BRIEFING ROOM 4B**

**CAPTAIN'S OFFICE**

**HEAD**

**EXECUTIVE OFFICER'S OFFICE**

**BRIEFING ROOM 4C**

**BRIEFING ROOM 4D**

**TRANSPORTER ROOM 4S**

Center deck

**MAIN SHIP'S COMPUTER BANKS**

Aft deck

**SENIOR OFFICERS' MESS:** Food delivery units are at center aft, and is served by stewards. The long Captain's Table also has its own food delivery system.

**DECK 5:** Food preparation

Forward deck, port to starboard

**JUNIOR OFFICERS' MESS:** Food delivery systems are built into the tables, though the selection is less elaborate than in the senior officers' mess. There are no steward/attendants.

**MANUAL FOOD PREPARATION:** Kitchen facilities available to officers for preparation of special dishes.

Center deck

**REFRIGERATED STORAGE**

**AUTOMATED FOOD PREPARATION:** Standard menu items are prepared here for delivery to food delivery locations elsewhere.

Aft deck

**EMERGENCY STANDARD GAS STORAGE:** Atmospheric gas storage, under high pressure, for emergency replenishment of life support equipment.



## DECK 6

Forward deck, port to starboard

**INSPIRATIONAL MEDIA ROOM:** Used for indoctrination and propaganda, with periodic attendance required for most junior officers. Most crewpersons are exposed to various types of propaganda almost constantly. (VARIANT: Romulan-operated D-7 Battlecruiser – **EXPANDED COMBAT ARENA:** This area features more extensive combat sports facilities, with all members of the crew required to participate. Those who excel at sports and combat exercises are highly regarded, and may earn special privileges with good performance. Training is rigorous and highly disciplined.)

**OFFICERS' GYM:** Includes a wide assortment of physical training equipment including weight machines, parallel bars, and a small arena similar to a (round) Terran "boxing ring". The arena is used for unarmed combat practice, and staging occasional trials by combat, sometimes called for under Klingon law.

Center deck

**AUXILIARY CONTROL ROOM:** A "second bridge" with security-locked override controls. Command chair, helm and navigator's station are at center, as on the main bridge. Stations around the periphery (clockwise from elevator) are Weapons Control, Sciences, Viewscreen, Communications, and Engineering Auxiliary. (When the main bridge is in operation, engineering controls are centered in the engineering section). This control room can be used if the regular bridge is damaged or captured by enemy boarding parties.

Aft deck, port to starboard

**CONFERENCE ROOM (VARIANT: Romulan-operated D-7 Battlecruiser – LOCKER ROOM)**

**LOCKER ROOM:** Includes lockers, showers and head.

Boom section on this level contains the turbo-elevator connection to the main hull and bulk water storage port starboard.

DECK 7: Senior officers' quarters

Aft deck

**EMERGENCY TRANSPORTERS:** Multi-station transporter used only for abandon ship operation. (Such units draw an enormous amount of power, and are unsuitable for regular use). Small rooms port and starboard contain stores of emergency survival equipment.

Outer deck, clockwise from aft

**COMMANDING OFFICER'S QUARTERS:** Living room, bedroom and head

**CHIEF ENGINEER'S QUARTERS**

**HEAD:** Shared by Chief Engineer and Chief of Security

**SECURITY CHIEF'S QUARTERS**

**EXECUTIVE OFFICER'S QUARTERS**

Inner deck, clockwise from elevator

**STORAGE AREAS**

## HEAD

### CHIEF MEDICAL OFFICER'S QUARTERS

Center deck

**ECM EQUIPMENT ROOM:** Central location for electronic counter measures circuitry and monitoring, including sensor foolers and, on Romulan variants of the D-7, cloaking device hardware.

DECK 8: Junior officers' quarters

All junior officers (including chief helmsman, chief navigator, communications chief, weapons officer, and science officer, among others) live in double bunkrooms with shared bathroom facilities. Exact arrangement of quarters varies from ship to ship.

DECK 9: Intelligence facilities

Forward deck, port to starboard

**INTERROGATION ROOM:** For interrogation of important prisoners. Includes a monitor bed and medical equipment (including surgical facilities). Also featured are the famous Klingon agonizer booths, which serve the same function as the hand-held agonizer, but with finer control and more power. (VARIANT: Romulan-operated D-7 Battlecruiser) **SHRINE:** This room is usually outfitted as a shrine to the Romulan god-warriors. Each ship has its own special patron warrior deity, which will serve as a central figure for the shrine. Other statues and representations of god-warriors and other great herces will also be present. Traditionally, only a Romulan who has spilled blood in battle (a Romulan rite-of-passage) may enter without desecrating the shrine and inviting divine retaliation. Such retaliation is supposed to come in the form of bad luck or defeat in battle.

**CLEARANCE FOR MAIN SENSOR TUBE**

**INTERNAL SURVEILLANCE ROOM:** From this room, nearly any location on the ship can be monitored, if the proper security clearance is obtained. There are always security officers here, checking crew areas and sensitive locations on random searches. If characters are trying to hide or evade a search on board this vessel, allow the Klingon crew a saving roll on the Crew Efficiency Rating (or the Starship Security rating of the Security Officer, if one has been designated). A successful roll will cause intruders to be spotted if they enter a sensitive or important area.

Aft deck

**BATTERY POWER:** For emergency use.

DECK 10: Main sensors

Port and starboard

**RAW MATERIALS STORAGE:** For use in food preparation and/or material fabrication.

Forward deck

**MAIN SENSOR DISH:** Recessed in a shielded tube for maximum protection.

Center deck, port to starboard  
SENSOR MONITOR ROOM  
SCIENCES OFFICE

## DECK DESCRIPTIONS – MAIN HULL

### DECK 1: Shuttlecraft landing area

Aft deck  
SHUTTLE BAY DOORS  
SECONDARY TRACTOR BEAMS: Used for bringing aboard small vessels and other objects of interest.

Center deck  
SHUTTLE LANDING AREA: Including landing beacons and drone launchers. Drones are used as targets for ship combat practice, and as probes. They are capable of sublight speeds only and are not suitable as weapons under normal circumstances, although they can be fitted with warheads for special uses.

Forward deck  
ELEVATORS: Port and starboard, for lowering shuttles, drones and personnel to the shuttle staging area.

MAIN HULL TRACTOR BEAMS: Mounted on the forward hull of this deck.

### DECK 2: Shuttle staging area

Aft deck  
DRONE STORAGE: Storage area for drones of all types. This area is served by one of the landing area elevators.

SHUTTLE PARKING: Shuttlecraft are stored here between missions. Also, this serves as a staging area where shuttle passengers embark and disembark. The elevator then takes the already loaded shuttle to the bay above for launch. This is different from embarkation procedures used by Star Fleet ships such as the Constitution class vessels.

Center deck, port to starboard  
SERVICE SHOPS: For maintenance and repair of drones, environmental suits, and other major pieces of hardware.

SHUTTLE REPAIR AREA: Maintenance area for shuttlecraft.

Forward deck  
SERVICE SHOPS: As above.  
EMERGENCY GENERATOR: Emergency power system, based on advanced fusion reactors. Reactor radiator fins are across the front of the hull in this area. This is the upper level, with the reactors continuing into the deck below, and accessed from that level.

### DECK 3

Aft deck  
MAIN IMPULSE ENGINES: For driving the ship at sublight speeds. This deck is open, with the engines continuing into the deck below but accessible at both levels.

Center deck  
EMERGENCY GENERATOR: Continued from the deck above, including monitor systems and controls.  
ENGINEERING COMPUTER BANKS: Computers controlling most engineering functions including warp and impulse engines, power systems, and life support.

Forward center deck, port to starboard  
NON-COMMISSIONED OFFICERS QUARTERS: These four-person bunkrooms with attached shared bath facilities are mainly occupied by non-coms having duties in engineering.

CHIEF ENGINEER'S OFFICE  
ENGINEERING SHOPS: Combined workrooms/laboratories for parts fabrication, testing, repair, etc.

Extreme port and starboard  
WATER TANKS

Forward deck  
ENGINEERING SHOPS: As above.  
LIFE SUPPORT MACHINERY

### DECK 4

Aft deck  
IMPULSE ENGINES: Continued from deck above, including monitors and systems controls.

Center deck, port to starboard  
POWER CONVERSION CHAMBERS: These systems convert warp nacelle power (from matter-antimatter reactions) to power usable for ship systems such as weapons, shields, etc. This is a sensitive area of the ship and is usually well guarded.

WASTE WATER RECOVERY: All waste water on the ship (including drain water, and water precipitated by the air conditioning system) is eventually recycled through these systems and back into the water holding tanks. The system is so efficient on modern ships that water actually accumulates (due to its being brought on board in food) and must on rare occasions be vented when all tanks are full!

Extreme port and starboard:  
WATER TANKS

Forward deck  
BUNKROOMS: For enlisted personnel, most of whom are assigned to maintenance, engineering, and ship services.

Extreme forward deck  
PHYSICS LABORATORY

### DECK 5 (BOOM): Laboratories

Forward to aft  
WATER STORAGE TANKS  
PUMP ROOM  
ZOOLOGY LAB  
CHEMISTRY LAB (port)  
BOTANY LAB (starboard)  
ION PHYSICS STUDIES LAB (engine development impulse) (port)



**SPECIAL STUDIES LAB (starboard)**

Forward deck, port to starboard

**SICK BAY RECOVERY WARDS:** Medical facilities on this deck are oriented toward the combat troops, whereas Deck 3 Forward Pod facilities are intended for naval personnel.

**EXAMINING ROOM:** Equipped with monitor beds and diagnostic equipment.

**MEDICAL STORAGE AREA**

**OPERATING ROOM**

**INTENSIVE CARE UNIT:** The desk in this room has repeater monitor screens for all monitor beds in the unit.

Extreme port and starboard

**AIR CONDITIONING/FILTERING UNITS**

Center and aft decks

**BUNKROOMS:** For combat troops carried by all large Klingon vessels. These troops are used as occupation forces on conquered worlds, boarding parties, and as armed members of landing parties.

**DECK 6**

Aft deck, port to starboard

**TROOPERS' MESS:** Food service machinery on the aft and starboard walls delivers basic meals, without the variety or extras offered by the units used by naval personnel.

**EXAMINING ROOM:** Equipped with monitor beds and diagnostic equipment.

**MEDICAL STORAGE AREA**

**OPERATING ROOM**

**INTENSIVE CARE UNIT:** The desk in his room has repeater monitor screens for all monitor beds in the unit.

Extreme port and starboard

**AIR CONDITIONING/FILTERING UNITS**

Center and aft decks

**BUNKROOMS:** For combat troops carried by all large Klingon vessels. These troops are used as occupation forces on conquered worlds, boarding parties, and as armed members of landing parties.

**DECK 6**

Aft deck, port to starboard

**TROOPERS' MESS:** Food service machinery on the aft and starboard walls delivers basic meals, without the variety or extras offered by the units used by naval personnel. Meals are served in shifts at set times.

**AUXILIARY BRIDGE:** This control room is designed for use if the boom and forward pod are separated from the the main hull in an emergency. The two sections can be operated separately, though only at sublight speeds. Separation would only be performed in an emergency such as the crippling of the main hull in battle. Once separated, the two units cannot be rejoined without major repair facilities.

**NAVAL ENLISTED MEN'S MESS:** Food service for naval enlisted men and non-coms, of a slightly better quality and less regimented nature than that provided for ground troops. Klingon military philosophy does not favor "pampering" the combat soldier. (VARIANT: Romulan-operated D-7 Battlecruiser — Romulan combat troops are elite fighters who are treated as heroes. Their mess facilities are usually the best on the ship. Romulans as a rule generally do not go in for "frills", being a spartan warrior race, but they do not mistreat the average combat soldier. Morale is very high among Romulan ground troops.)

Center deck, port and starboard

**SECONDARY COMPUTER BANKS:** Major computer complex for the main hull.

Middeck center

**EMERGENCY BATTERIES**

Forward deck

**BUNKROOMS:** These quarters are mostly for the junior enlisted men.

Extreme port and starboard

**FUEL PROCESSING AND STORAGE:** For impulse drives and auxiliary generators.

Extreme forward deck

**AUXILIARY BOOM IMPULSE DRIVES:** For use when boom is separated from main hull in emergencies.

**DECK 7 (BOOM):** Cargo

Forward to aft

**WATER STORAGE TANKS**

**PUMP ROOM CARGO STORAGE AREAS (4)**

**DECK 7 (PORT)**

Aft deck, port to starboard

**CREW GYMNASIUM:** Includes attached locker room. This area is somewhat misnamed, as it is mostly available to non-coms and not to enlisted personnel, except at scheduled times.

**TRANSPORTER ROOM:** This is the transporter facility used most often by enlisted personnel on routine duty. This transporter is also used when tight security must be maintained, as when transferring prisoners.

**FROZEN FOOD LOCKER**

Center deck, port to starboard

**SHIP'S LAUNDRY:** Klingon basic uniforms are not endlessly recycled, like Star Fleet uniforms on larger ships. Instead, they must be laundered. The ship's laundry uses special dry electrostatic processes to remove soil and stains.

**MEDIA ROOM:** Similar in purpose to the media room on Deck 7 in the forward pod, but used mainly by enlisted men and combat troops, who are required to see "inspirational" media presentations on a regular basis.

Forward deck, port to starboard

**FIRING RANGE:** All Klingon enlisted personnel are required to maintain a minimum competency with firearms. This range, and all firearms instruction, is overseen by the security department.

**OFFICERS' LOUNGE (forward):** Mostly used by officers in the security department, though it is theoretically open to any officer. Security personnel are the most mistrusted people aboard Klingon vessels, and maintain a discreet social distance from other officers. This is reasonable, as one of their major jobs is watching and informing on the crew and the other officers. Not even the Captain of a ship can totally trust his security officers. The Chief of Security is third in command, and every ship has at least one (usually several) operatives of the Klingon Secret Police aboard in undercover guise to watch the captain himself on behalf of the Klingon Imperial Fleet Command.

**SMALL ARMS ARSENAL (aft):** This guarded room contains disruptor pistols and rifles, as well as other weapons sometimes issued by the security department. Weapons may be recharged or repaired here, under the watchful eye of the ship's chief armorer.

Extreme port

**MACHINERY:** Includes warp drive channelling circuitry, life support systems, shield systems, etc.

#### DECK 7 (STARBOARD)

Aft deck, port to starboard

**FROZEN FOOD LOCKER**

**AUTOMATED FOOD PREPARATION:** This facility prepares the basic meals for the troopers' mess.

Center deck, port to starboard

**ELEVATOR REPAIR FACILITY:** For repair of turbo-elevators. This area contains master controls for all turbo-elevators, including the capability of locking out a station, so no cars can stop there. Controls here can also override local control and call a specific car from anywhere, or send a car from one station to another with a "priority override" program, preventing any other car from taking precedence.

**GUARD LOUNGES:** For use by security guards who are "on call", but have no specifically assigned duties.

Forward deck, port to starboard — security section

**INTERNAL SECURITY OFFICE:** The home of the dreaded Internal Security Department. An enlisted man called here would be scared to death — and with good reason. Even officers of other departments get nervous when sent here for one reason or another!

**INTERROGATION ROOMS:** These rooms are little more than cubicles — not as well equipped as the interrogation facility in the pod on Deck 9. These rooms are mainly used for internal security interrogations.

**SECURITY MESSROOM:** This messroom is small, but equipped with food service the equal of the non-com's mess room on Deck 6. Again, this is a reflection of the social distance between security personnel and other ship's crew. It is also convenient to have a small mess area for guards "on call".

**CELLBLOCK:** All cells have audio-visual monitoring devices, but not all may be actively watched. (You never know...) On most D-7 vessels, the cell doors are transparent force fields which cannot be penetrated by material objects, or disrupted by known hand weapons fire. Early models, however, may have old-fashioned steel doors with electronic locks.

(VARIANT: Romulan-operated D-7 Battlecruiser — On Romulan ships, the security area is much smaller, as there are almost never prisoners to guard. Romulans are also less paranoid about internal security. The security facilities shown would be cut back to a simple office or two and a couple of brig cells. The security mess room would remain on most such ships. The rest of the room would be converted to quarters for security guards and soldiers.)

Extreme starboard

**MACHINERY:** As noted on portside plan, this deck.

#### DECK 8

Aft deck, port to starboard

**GENERAL FABRICATION:** Automated fabrication equipment for manufacture in quantity of small items of hardware. Computer-controlled machinery such as this feeds from raw materials storage areas. Many things can be recycled almost endlessly in this manner, thus cutting down on the number of specialized items that must be stocked and carried by the quartermaster's department in ship stores.

**SMALL ARMS ARSENAL 8S:** Same as the portside arsenal.

**ORGANIC FABRICATIONS:** Automated fabrication of organic compounds and organic materials, such as some plastics and resins.

Forward deck, port to starboard

**SHIP STORES:** This is the central distribution point for the quartermaster's department, responsible for fabrication, control, distribution and repair of ship's equipment. Everything from blankets to communicators is handled by this office. Fabrication of weapons and weapon parts is also done by this department, but under the strict controls of the security department. (Weapons and parts are not stored here, but rather kept in the armories.) Uniforms are made by this department and stored here, and recycled when too worn or damaged for further washings. Like all supply personnel in armed services anywhere, Klingon quartermasters are great traders and "scroungers", making outrageous deals to get needed equipment and supplies. In this respect, they have perhaps more freedom to act than any Klingon ship personnel. Not even security wants to upset the quartermaster too much, unless it is absolutely necessary.

**METALLIC FABRICATION:** Automated equipment for fabricating metallic items.

**SANITARY WASTE RECOVERY:** All waste materials are processed through automated machinery, which breaks it down into component elements for storage in raw materials storage compartments.

**MATERIALS RECLAMATION:** Worn uniforms, broken parts and materials, etc. are brought here, where they are broken down into component materials for later recycling as new items, much in the same manner that waste materials are handled next door.



Extreme port and starboard

**STORAGE AREAS:** For raw materials and equipment used by the various systems on this deck. Retrieval of materials from this area is by automated conveyor systems, though entry by ship personnel is possible through normally-sealed access hatches.

DECK 9: Cargo

All of Deck 9 is devoted to cargo handling and storage. Two large cargo transporters are present (one each to extreme forward port and starboard) for beaming non-living items only. Tuning on cargo transporters is less precise than personnel transporters. Any living organism sent in this manner runs a risk of being reassembled in less than viable condition. (Gamemasters: If living organisms are sent in this manner, roll 1D10 for each. On a roll of 1, the animal or being in question has experienced reassembly error of one type or another. If so, roll 1D10 again. On a roll of 1, the error has caused brain damage, and the organism is hopelessly and permanently insane. This will not likely be a subtle insanity, but rather total idiocy or outright raving, incoherent lunacy. On a roll of 2-5, the being or animal is badly deformed in some way, the extent and effects of such deformity left to the gamemaster. On a roll of 6-10, the organism is too badly damaged to live, and dies within 1D10 hours, unless put out of its misery sooner).

The rest of the deck is made up of several cargo holds. Special cargo requiring unusual handling or special security is stored in the small holds to extreme center port or starboard. More partitions can be added in any way that cargo handlers desire.

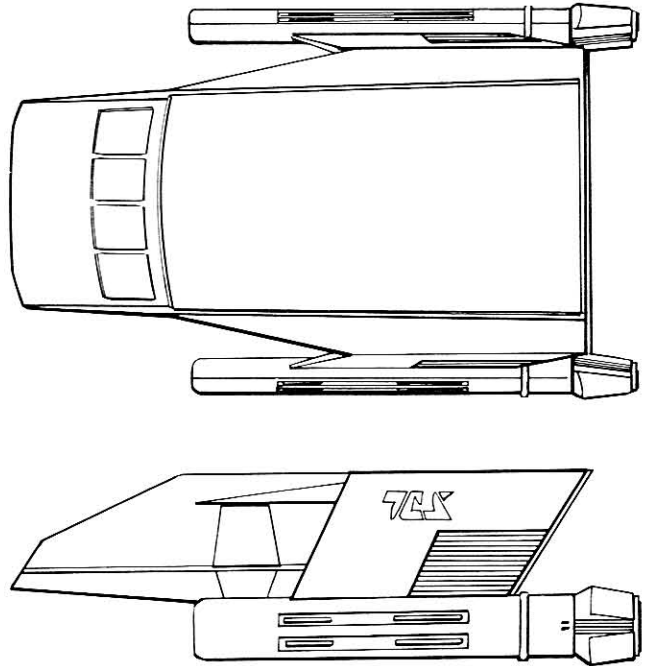

SHUTTLECRAFT PLAN AND PROFILE VIEWS

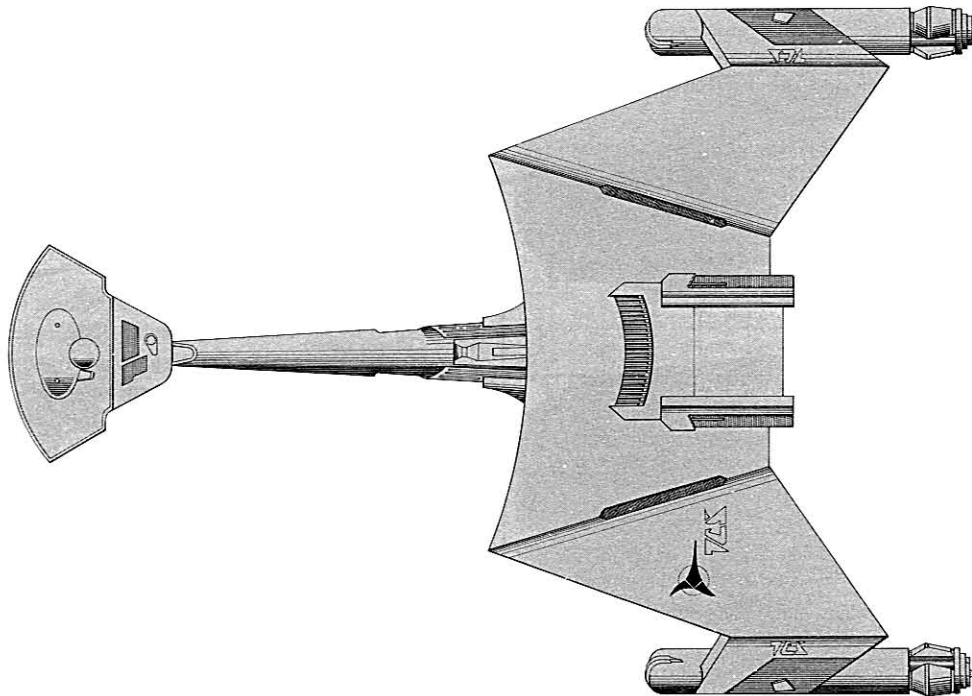

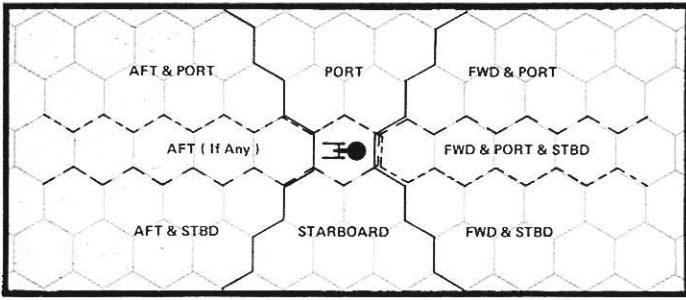

**1 Photon Torpedos 2**

DMGD	UN ARM	ARM
------	--------	-----

DMGD	UN ARM	ARM
------	--------	-----

**1 Forward Phasers 2**

DMGD	UN ARM	1	2	3	4	5
------	--------	---	---	---	---	---

DMGD	UN ARM	1	2	3	4	5
------	--------	---	---	---	---	---

**1 Starboard Phasers 2**

DMGD	UN ARM	1	2	3	4	5
------	--------	---	---	---	---	---

DMGD	UN ARM	1	2	3	4	5
------	--------	---	---	---	---	---

**1 Port Phasers 2**

DMGD	UN ARM	1	2	3	4	5
------	--------	---	---	---	---	---

DMGD	UN ARM	1	2	3	4	5
------	--------	---	---	---	---	---

TURN STRESS CHART			PHASER FIRING CHART		
Speed	Engine Stress	Super Stress	Range	To-Hit	DMG+
Sub	—	—	1	1-10	3
W1	—	—	2	1-10	3
W2	—	—	3	1-10	3
W3	—	—	4	1-10	3
W4	—	—	4	1-10	3
W5	—	1	5	1-9	3
W6	1	1	6	1-9	3
W7	1	2	7	1-8	3
W8	2	3	8	1-8	3
			9	1-7	3
			10	1-7	3
			11	1-6	2
			12	1-6	2
			13	1-5	2
			14	1-5	2
			15	1-4	2
			16	1-4	2
			17	1-3	2
			18	1-3	1
			19	1-2	1
			20	1	1

TORPEDO FIRING CHART		
Range	To-Hit	DMGE
1	1-10	10
2	1-10	all ranges.
3	1-9	
4	1-9	
5	1-8	
6	1-7	
7	1-6	
8	1-5	
9	1-4	
10	1-3	
11	1-2	
12	1	

0	6
1	7
2	8
3	9
4	10
5	11

sub-light
W1
W2
W3
W4
W5
W6
W7
W8

**Movement Points Available**

**Current Speed**



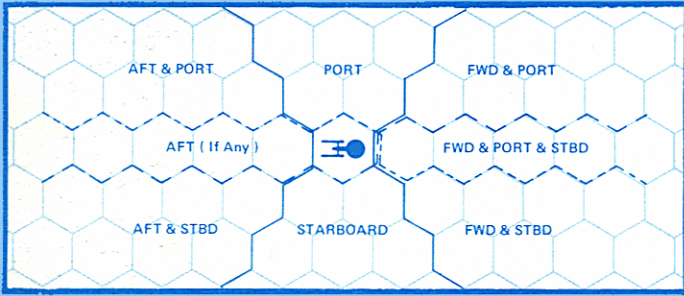

1 **Photon Torpedos** 2

DMGD	UN ARM	ARM
------	--------	-----

DMGD	UN ARM	ARM
------	--------	-----

1 **Forward Phasers** 2

DMGD	UN ARM	1	2	3	4	5
------	--------	---	---	---	---	---

DMGD	UN ARM	1	2	3	4	5
------	--------	---	---	---	---	---

1 **Starboard Phasers** 2

DMGD	UN ARM	1	2	3	4	5
------	--------	---	---	---	---	---

DMGD	UN ARM	1	2	3	4	5
------	--------	---	---	---	---	---

1 **Port Phasers** 2

DMGD	UN ARM	1	2	3	4	5
------	--------	---	---	---	---	---

DMGD	UN ARM	1	2	3	4	5
------	--------	---	---	---	---	---

TURN STRESS CHART			PHASER FIRING CHART		
Speed	Engine Stress	Super Stress	Range	To-Hit	DMG+
Sub	—	—	1	1-10	3
W1	—	—	2	1-10	3
W2	—	—	3	1-10	3
W3	—	—	4	1-10	3
W4	—	—	4	1-10	3
W5	—	1	5	1-9	3
W6	1	1	6	1-9	3
W7	1	2	7	1-8	3
W8	2	3	8	1-8	3
			9	1-7	3
			10	1-7	3
			11	1-6	2
			12	1-6	2
			13	1-5	2
			14	1-5	2
			15	1-4	2
			16	1-4	2
			17	1-3	2
			18	1-3	1
			19	1-2	1
			20	1	1

TORPEDO FIRING CHART		
Range	To-Hit	DMGE
1	1-10	10
2	1-10	all ranges.
3	1-9	
4	1-9	
5	1-8	
6	1-7	
7	1-6	
8	1-5	
9	1-4	
10	1-3	
11	1-2	
12	1	

0	6	sub-light
1	7	W1
2	8	W2
3	9	W3
4	10	W4
5	11	W5
		W6
		W7
		W8

**Movement  
Points  
Available**

**Current Speed**

# COMMUNICATIONS

Constitution Class Heavy Cruiser

## Casualties

1	2	3	4	5	6	7	8	9	0
---	---	---	---	---	---	---	---	---	---

### Hundreds

1	2	3	4	5	6	7	8	9	0
---	---	---	---	---	---	---	---	---	---

### Tens

1	2	3	4	5	6	7	8	9	0
---	---	---	---	---	---	---	---	---	---

### Ones

+1	+2	+3	+4	+5	+6	+7	+8	+9	+10
----	----	----	----	----	----	----	----	----	-----

## Die Roll Modifications

### SHIP COMBAT SAVING ROLL TABLE

Below is a list of all skill rolls normally used in ship combat. Four things are given: 1) Officer the roll is made by, 2) Name of the skill used, 3) When the roll can be made, and 4) the result of a successful roll.

#### CAPTAIN

1) STARSHIP COMBAT STRATEGY/TACTICS, beginning of turn, no roll is made but skill is compared to opponent's skill.

#### ENGINEER

Only one roll may be made per turn.

1) WARP DRIVE TECHNOLOGY, made at the beginning of the turn, success gains 1 extra point of power to be applied to total power available track (2 points if roll is 01-05).

2) STARSHIP ENGINEERING (GENERAL), made at the beginning of the turn, success reduces stress on one engine by one step (2 points on one engine or 1 point on each of two engines if the roll is 01-05).

3) WARP DRIVE TECHNOLOGY, made at the beginning of the turn, success allows helm to change overall warp speed by 2 steps instead of 1.

#### NAVIGATOR

1) DEFLECTOR SHIELD TECHNOLOGY, made at the beginning of the turn, success gains 2 more points of shielding to be used anywhere.

#### HELMSMAN

1) STARSHIP HELM OPERATION, made any time needed, success allows stress chart rolls to be made one row higher than normal.

2) SHIP'S WEAPONRY TECHNOLOGY, made when firing — may roll twice per turn, success gains a -1 on 'to hit' rolls of weaponry.

#### SCIENCE OFFICER

1) SHIP'S SENSOR SKILL, made at the beginning of the turn, success gains sensor lock.

#### COMMUNICATIONS OFFICER

1) STARSHIP COMMUNICATIONS PROCEDURES, may be made anytime, allows difficult tasks to be performed.



# COMMUNICATIONS

Constitution Class Heavy Cruiser

## Casualties

1	2	3	4	5	6	7	8	9	0
---	---	---	---	---	---	---	---	---	---

### Hundreds

1	2	3	4	5	6	7	8	9	0
---	---	---	---	---	---	---	---	---	---

### Tens

1	2	3	4	5	6	7	8	9	0
---	---	---	---	---	---	---	---	---	---

### Ones

+1	+2	+3	+4	+5	+6	+7	+8	+9	+10
----	----	----	----	----	----	----	----	----	-----

## Die Roll Modifications

### SHIP COMBAT SAVING ROLL TABLE

Below is a list of all skill rolls normally used in ship combat. Four things are given: 1) Officer the roll is made by, 2) Name of the skill used, 3) When the roll can be made, and 4) the result of a successful roll.

#### CAPTAIN

1) STARSHIP COMBAT STRATEGY/TACTICS, beginning of turn, no roll is made but skill is compared to opponent's skill.

#### ENGINEER

Only one roll may be made per turn.

1) WARP DRIVE TECHNOLOGY, made at the beginning of the turn, success gains 1 extra point of power to be applied to total power available track (2 points if roll is 01-05).

2) STARSHIP ENGINEERING (GENERAL), made at the beginning of the turn, success reduces stress on one engine by one step (2 points on one engine or 1 point on each of two engines if the roll is 01-05).

3) WARP DRIVE TECHNOLOGY, made at the beginning of the turn, success allows helm to change overall warp speed by 2 steps instead of 1.

#### NAVIGATOR

1) DEFLECTOR SHIELD TECHNOLOGY, made at the beginning of the turn, success gains 2 more points of shielding to be used anywhere.

#### HELMSMAN

1) STARSHIP HELM OPERATION, made any time needed, success allows stress chart rolls to be made one row higher than normal.

2) SHIP'S WEAPONRY TECHNOLOGY, made when firing — may roll twice per turn, success gains a -1 on 'to hit' rolls of weaponry.

#### SCIENCE OFFICER

1) SHIP'S SENSOR SKILL, made at the beginning of the turn, success gains sensor lock.

#### COMMUNICATIONS OFFICER

1) STARSHIP COMMUNICATIONS PROCEDURES, may be made anytime, allows difficult tasks to be performed.

0	1	2	3	4	<b>Impulse</b>
---	---	---	---	---	----------------

0	1	2	3	4	5	6	7	8	9	10	11	12	13	14	15	16	17	18	19	20
---	---	---	---	---	---	---	---	---	---	----	----	----	----	----	----	----	----	----	----	----

**Warp Engine 1-Starboard**

0	1	2	3	4	5	6	7	8	9	10	11	12	13	14	15	16	17	18	19	
---	---	---	---	---	---	---	---	---	---	----	----	----	----	----	----	----	----	----	----	--

**Warp Engine 2-Port**

**Total Power Available**

0	1	2	3	4	5	6	7	8	9	10	11	12	13	14	15	16	17	18	19	20	21	22	46
23	24	25	26	27	28	29	30	31	32	33	34	35	36	37	38	39	40	41	42	43	44	45	

**Power to Movement**

0	1	2	3	4 1	5	6	7	8 2	9	10	11	12 3	13	14	15	16 4	17	18	19	20 5	21	22
23	24 6	25	26	27	28 7	29	30	31	32 8	33	34	35	36 9	37	38	39	40 10	41	42	43	44 11	

**Power to Shields**

0	1 2	2 4	3 6	4 8	5 10	6 12	7 14	8 16	9 18	10 20	11 22	12 24	13 26	14 28	15 30	16 32	17 34	18 36	19 38	20 40	21 42	22 44	46 92
23 46	24 48	25 50	26 52	27 54	28 56	29 58	30 60	31 62	32 64	33 66	34 68	35 70	36 72	37 74	38 76	39 78	40 80	41 82	42 84	43 86	44 88	45 90	

**Power to Weapons**

0	1	2	3	4	5	6	7	8	9	10	11	12	13	14	15	16	17	18	19	20	21	22	23	24	25	26	27	28	29	30	31
---	---	---	---	---	---	---	---	---	---	----	----	----	----	----	----	----	----	----	----	----	----	----	----	----	----	----	----	----	----	----	----

																32																
--	--	--	--	--	--	--	--	--	--	--	--	--	--	--	--	----	--	--	--	--	--	--	--	--	--	--	--	--	--	--	--	--

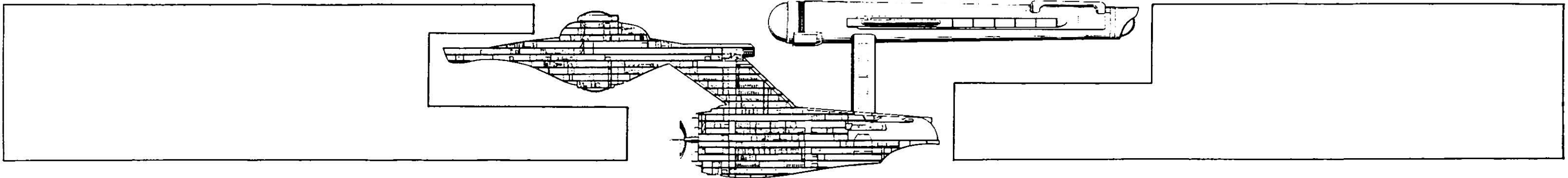



0	1	2	3	4	Impulse
---	---	---	---	---	---------

0	1	2	3	4	5	6	7	8	9	10	11	12	13	14	15	16	17	18	19	20
---	---	---	---	---	---	---	---	---	---	----	----	----	----	----	----	----	----	----	----	----

Warp Engine 1-Starboard

0	1	2	3	4	5	6	7	8	9	10	11	12	13	14	15	16	17	18	19	
---	---	---	---	---	---	---	---	---	---	----	----	----	----	----	----	----	----	----	----	--

Warp Engine 2-Port

Total Power Available

0	1	2	3	4	5	6	7	8	9	10	11	12	13	14	15	16	17	18	19	20	21	22	46
23	24	25	26	27	28	29	30	31	32	33	34	35	36	37	38	39	40	41	42	43	44	45	

Power to Movement

0	1	2	3	4 1	5	6	7	8 2	9	10	11	12 3	13	14	15	16 4	17	18	19	20 5	21	22
23	24 6	25	26	27	28 7	29	30	31	32 8	33	34	35	36 9	37	38	39	40 10	41	42	43	44 11	

Power to Shields

0	1 2	2 4	3 6	4 8	5 10	6 12	7 14	8 16	9 18	10 20	11 22	12 24	13 26	14 28	15 30	16 32	17 34	18 36	19 38	20 40	21 42	22 44	46 92
23	24 46	25 48	26 50	27 52	28 54	29 56	30 58	31 60	32 62	33 64	34 66	35 68	36 70	37 72	38 74	39 76	40 78	41 80	42 82	43 84	44 86	45 88	

Power to Weapons

0	1	2	3	4	5	6	7	8	9	10	11	12	13	14	15	16	17	18	19	20	21	22	23	24	25	26	27	28	29	30	31
---	---	---	---	---	---	---	---	---	---	----	----	----	----	----	----	----	----	----	----	----	----	----	----	----	----	----	----	----	----	----	----

																32																
--	--	--	--	--	--	--	--	--	--	--	--	--	--	--	--	----	--	--	--	--	--	--	--	--	--	--	--	--	--	--	--	--

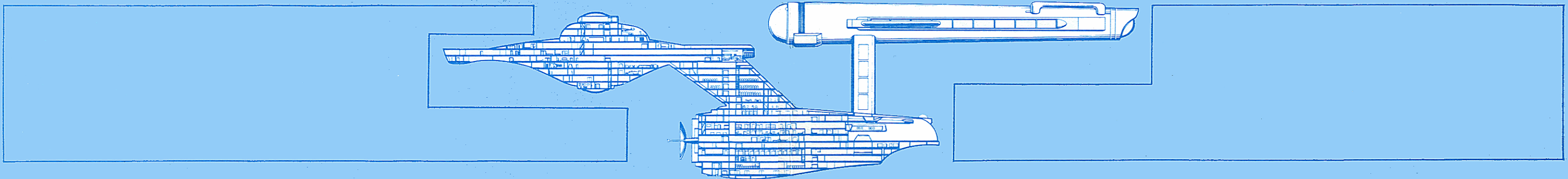

# NAVIGATOR

Constitution Class Heavy Cruiser

## Deflectors

	1	2	3	4	5	6
<b>Forward</b>	DMGD	DMGD	DMGD	DMGD	DMGD	DMGD
	0	0	0	0	0	0
	1	1	1	1	1	1
	2	2	2	2	2	2
	3	3	3	3	3	3
	4	4	4	4	4	4
	5	5	5	5	5	5
	6	6	6	6	6	6
	7	7	7	7	7	7
	8	8	8	8	8	8
	9	9	9	9	9	9
	10	10	10	10	10	10
	11	11	11	11	11	11
	12	12	12	12	12	12
	13	13	13	13	13	13
	14	14	14	14	14	14
	15	15	15	15	15	15
16	16	16	16	16	16	

	1	2	3	4	5	6
<b>STBD Aft</b>	DMGD	DMGD	DMGD	DMGD	DMGD	DMGD
	0	0	0	0	0	0
	1	1	1	1	1	1
	2	2	2	2	2	2
	3	3	3	3	3	3
	4	4	4	4	4	4
	5	5	5	5	5	5
	6	6	6	6	6	6
	7	7	7	7	7	7
	8	8	8	8	8	8
	9	9	9	9	9	9
	10	10	10	10	10	10
	11	11	11	11	11	11
	12	12	12	12	12	12
	13	13	13	13	13	13
	14	14	14	14	14	14
	15	15	15	15	15	15
16	16	16	16	16	16	

	1	2	3	4	5	6
<b>Aft</b>	DMGD	DMGD	DMGD	DMGD	DMGD	DMGD
	0	0	0	0	0	0
	1	1	1	1	1	1
	2	2	2	2	2	2
	3	3	3	3	3	3
	4	4	4	4	4	4
	5	5	5	5	5	5
	6	6	6	6	6	6
	7	7	7	7	7	7
	8	8	8	8	8	8
	9	9	9	9	9	9
	10	10	10	10	10	10
	11	11	11	11	11	11
	12	12	12	12	12	12
	13	13	13	13	13	13
	14	14	14	14	14	14
	15	15	15	15	15	15
16	16	16	16	16	16	

	1	2	3	4	5	6
<b>Port Aft</b>	DMGD	DMGD	DMGD	DMGD	DMGD	DMGD
	0	0	0	0	0	0
	1	1	1	1	1	1
	2	2	2	2	2	2
	3	3	3	3	3	3
	4	4	4	4	4	4
	5	5	5	5	5	5
	6	6	6	6	6	6
	7	7	7	7	7	7
	8	8	8	8	8	8
	9	9	9	9	9	9
	10	10	10	10	10	10
	11	11	11	11	11	11
	12	12	12	12	12	12
	13	13	13	13	13	13
	14	14	14	14	14	14
	15	15	15	15	15	15
16	16	16	16	16	16	

	1	2	3	4	5	6
<b>Port Forward</b>	DMGD	DMGD	DMGD	DMGD	DMGD	DMGD
	0	0	0	0	0	0
	1	1	1	1	1	1
	2	2	2	2	2	2
	3	3	3	3	3	3
	4	4	4	4	4	4
	5	5	5	5	5	5
	6	6	6	6	6	6
	7	7	7	7	7	7
	8	8	8	8	8	8
	9	9	9	9	9	9
	10	10	10	10	10	10
	11	11	11	11	11	11
	12	12	12	12	12	12
	13	13	13	13	13	13
	14	14	14	14	14	14
	15	15	15	15	15	15
16	16	16	16	16	16	



Tractor Beam

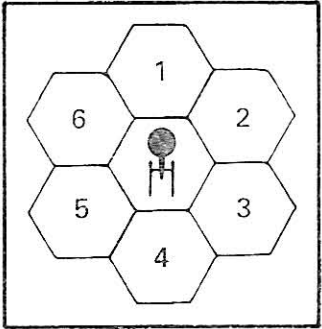

# NAVIGATOR

Constitution Class Heavy Cruiser

## Deflectors

	1	2	3	4	5	6
Forward	DMGD	DMGD	DMGD	DMGD	DMGD	DMGD
	0	0	0	0	0	0
	1	1	1	1	1	1
	2	2	2	2	2	2
	3	3	3	3	3	3
	4	4	4	4	4	4
	5	5	5	5	5	5
	6	6	6	6	6	6
	7	7	7	7	7	7
	8	8	8	8	8	8
	9	9	9	9	9	9
	10	10	10	10	10	10
	11	11	11	11	11	11
	12	12	12	12	12	12
	13	13	13	13	13	13
	14	14	14	14	14	14
	15	15	15	15	15	15
16	16	16	16	16	16	

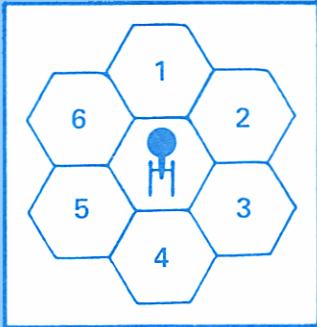

Tractor Beam

DMGD 2	DMGD 1	OPER	LOCK
-----------	-----------	------	------

# SCIENCE

Constitution Class Heavy Cruiser

## Sensors

### Superstructure Damage

	0	1	2	3	4	5	6	7	8	9
10	11	12	13	14	15	16	17	18	19	20

Forward		STBD - Forward		Port-Forward	
1	Sensors out 1-2 turns	1	Sensors out 1-2 turns	1	Sensors out 1-2 turns
2	Fwd. shield generator dmgd.	2	Stbd.-fwd.shield gen. dmgd.	2	Port-fwd. shield gen. dmgd.
3	One fwd. phaser dmgd. (2)	3	Stbd. warp engine hit	3	Port warp engine hit
4	Superstructure hit (4)	4	Superstructure hit (1)	4	Superstructure hit (1)
5	Superstructure hit (8)	5	Superstructure hit (4)	5	Superstructure hit (4)
6	1 photon torpedo tube dmgd.	6	Superstructure hit (10)	6	Superstructure hit (10)
7	Superstructure hit (10)	7	Superstructure hit (10)	7	Superstructure hit (10)
8	Superstructure hit (14)	8	Superstructure hit (20)	8	Superstructure hit (20)
9	Bridge personnel out	9	1 stbd. phaser dmgd.	9	1 port phaser dmgd.
10	Bridge personnel out	10	Bridge personnel out	10	Bridge personnel out

AFT		STBD - Aft		Port-Aft	
1	Tractor beam dmgd.	1	Stbd. warp engine hit	1	Port warp engine hit
2	Superstructure hit (2)	2	Stbd. warp engine hit	2	Port warp engine hit
3	Superstructure hit (4)	3	Stbd. warp engine hit	3	Port warp engine hit
4	Stbd.-warp engine hit	4	Impulse engine hit (1)	4	Impulse engine hit
5	Stbd.-warp engine hit	5	Superstructure hit (4)	5	Superstructure hit (4)
6	Impulse engine hit	6	Superstructure hit (4)	6	Superstructure hit (10)
7	Impulse engine hit	7	Superstructure hit (10)	7	Superstructure hit (10)
8	Port warp engine hit	8	Superstructure hit (20)	8	Superstructure hit (20)
9	Port warp engine hit	9	Stbd.-aft shield gen. dmgd.	9	Port-aft shield gen. dmgd.
10	Aft shield gen. dmgd.	10	Stbd.-warp engine hit	10	Port warp engine hit



DMGD 2	DMGD 1	OPER	LOCK
-----------	-----------	------	------

## Sensors

## Superstructure Damage

0	1	2	3	4	5	6	7	8	9	
10	11	12	13	14	15	16	17	18	19	20

Forward		STBD - Forward		Port-Forward	
1	Sensors out 1-2 turns	1	Sensors out 1-2 turns	1	Sensors out 1-2 turns
2	Fwd. shield generator dmgd.	2	Stbd.-fwd.shield gen. dmgd.	2	Port-fwd. shield gen. dmgd.
3	One fwd. phaser dmgd. (2)	3	Stbd. warp engine hit	3	Port warp engine hit
4	Superstructure hit (4)	4	Superstructure hit (1)	4	Superstructure hit (1)
5	Superstructure hit (8)	5	Superstructure hit (4)	5	Superstructure hit (4)
6	1 photon torpedo tube dmgd.	6	Superstructure hit (10)	6	Superstructure hit (10)
7	Superstructure hit (10)	7	Superstructure hit (10)	7	Superstructure hit (10)
8	Superstructure hit (14)	8	Superstructure hit (20)	8	Superstructure hit (20)
9	Bridge personnel out	9	1 stbd. phaser dmgd.	9	1 port phaser dmgd.
10	Bridge personnel out	10	Bridge personnel out	10	Bridge personnel out

AFT		STBD - Aft		Port-Aft	
1	Tractor beam dmgd.	1	Stbd. warp engine hit	1	Port warp engine hit
2	Superstructure hit (2)	2	Stbd. warp engine hit	2	Port warp engine hit
3	Superstructure hit (4)	3	Stbd. warp engine hit	3	Port warp engine hit
4	Stbd.-warp engine hit	4	Impulse engine hit (1)	4	Impulse engine hit
5	Stbd.-warp engine hit	5	Superstructure hit (4)	5	Superstructure hit (4)
6	Impulse engine hit	6	Superstructure hit (4)	6	Superstructure hit (10)
7	Impulse engine hit	7	Superstructure hit (10)	7	Superstructure hit (10)
8	Port warp engine hit	8	Superstructure hit (20)	8	Superstructure hit (20)
9	Port warp engine hit	9	Stbd.-aft shield gen. dmgd.	9	Port-aft shield gen. dmgd.
10	Aft shield gen. dmgd.	10	Stbd.-warp engine hit	10	Port warp engine hit

# NELSON Class Scout

	Move 7, 8, 9 hexes 0 Def 1 Phaser
	Move 4, 5, 6 hexes 0 Def 2 Phasers
	Move 4, 5, 6 hexes 1 Def 1 Phaser
	Move 0, 1, 2, 3 0-1 Def 2 Phasers
	Move 0, 1, 2, 3 2 Def 1 Phasers
	Move 0, 1, 2, 3 3 Def 0 Phasers

Turn Chart			Phaser Table		
Spd	Eng	Sup	Rng	To	Dmg
Sub	—	—		Hit	
W1	—	—	1	1-10	6
W2	—	—	2	1-10	6
W3	—	—	3	1-10	6
W4	—	—	4	1-9	6
W5	1	—	5	1-9	5
W6	1	1	6	1-8	5
W7 (EM)	2	1	7	1-8	5
			8	1-7	5
			9	1-7	4
			10	1-6	4
			11	1-5	4
			12	1-4	3
			13	1-3	3
			14	1-2	3
			15	1	0

  

Dmg Chart	
Die	Dmg
Roll	
1	Super
2	Super
3	Super
4	Defl
5	Defl
6	Phaser
7	IMPU
8	W Eng
9	W Eng
10	W Eng

## ENGINE STRESS/DAMAGE

MAX SPD 8	18
	17
MAX SPD 7	16
	15
MAX SPD 6	14
	13
MAX SPD 5 -2DEFL	12
	11
MAX SPD 4	10
	9
-1 Phaser MAX SPD 3	8
	7
-3 DEFL MAX SPD 2	6
	5
-2 Phasers MAX SPD 1	4
	3
MAX SPD 0	2
	1

### DEFLECTORS UP

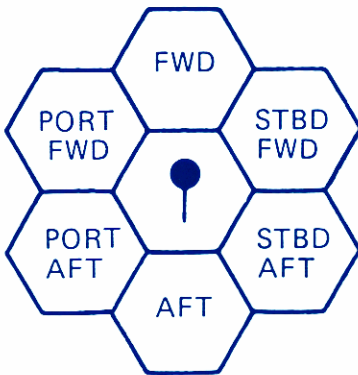

### DEFLECTORS AT 10 POINTS

### PHASERS DAMAGED

1	2
---	---

### DEFLECTORS DMGD

FWD	STBD FWD	PORT FWD
AFT	STBD AFT	PORT AFT

### SUPERSTRUCTURE STRESS/DAMAGE

1	2	3	4	5	6	7	8	9
---	---	---	---	---	---	---	---	---

CAPTAIN'S STRAT/TAC. SKILL \_\_\_\_\_

CREW EFFICIENCY RATING \_\_\_\_\_

IMPULSE ENGINE = 2 BOXES



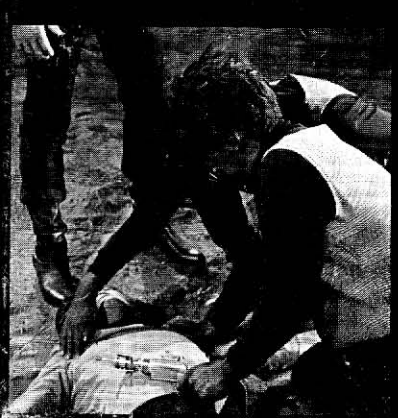

*Space ... the final frontier.*

*These are the voyages of the Starship Enterprise.*

*Its five-year mission: to explore strange new worlds, to seek out new life and new civilizations to boldly go where no man has gone before...*

Now you can join the Enterprise; all that is required is right here. Included in the game is:

1. **The Basic Rule Book:** This 128-page, two-color, 8½ x 11 inch book contains all of the rules needed to create and play a Star Fleet character. Rules for man-to-man combat, starship combat, planetary generation, and culture and alien generation are also included. This book is heavily illustrated with pictures from the TV series.
2. **Adventure Book:** This 48-page, 8½ x 11 book contains three introductory adventures and descriptions of the Enterprise and Klingon D-7 deck plans.
3. **Deck Plan Book:** This 80-page, 8½ x 11 inch pull-apart book contains scaled deck plans of the U.S.S. Enterprise and the Klingon D-7 class Battlecruiser. The scale of these plans is 1 inch = 6 meters. Also included with this book are several reference sheets used with the starship combat system.
4. **Starship Combat Hex Grid:** This 22½ x 33 inch hex grid is used with the starship combat system.
5. **112 Illustrated Counters:** One side of these counters is used with the starship combat system. The other side depicts figures and can be used with man-to-man combat.
6. **Two 20-sided dice.**

FASA Corporation, P.O. Box 6930 Chicago, IL 60680



# KLINGON D-7 Battlecruiser

## ENGINE STRESS/DAMAGE

	Move 9 or 10 hexes no Defl - no Disr
	Move 7 or 8 hexes 1 Defl or 2 Disr
	Move 4, 5, or 6 hexes 0 Defl and up to 3 Disr
	Move 4, 5, or 6 hexes 1 Defl and up to 2 Disr
	Move 4, 5, or 6 hexes 2 Defl and no Disr
	Move 0, 1, 2, or 3 hexes 0 Defl and up to 4 Disr
	Move 0, 1, 2, or 3 hexes 1 Defl and up to 3 Disr
	Move 0, 1, 2, or 3 hexes 2 Defl and up to 2 Disr
	Move 0, 1, 2, or 3 hexes 3 Defl and 1 Disr
	Move 0, 1, 2, or 3 hexes 4 Defl and no Disr

Turn Chart			Disruptor Firing		
SPD	ENG	SUP	RANGE	TO HIT	DMG
Sub	—	—	1	1-10	8
W1	—	—	2	1-10	8
W2	—	—	3	1-9	8
W3	—	—	4	1-9	7
W4	—	1	5	1-8	7
W5	1	1	6	1-8	7
t6	1	2	7	1-7	6
t7	2	3	8	1-7	6
W8	3	4	9	1-6	6
			10	1-6	5
			11	1-5	5
			12	1-5	5
			13	1-4	4
			14	1-4	4
			15	1-3	4
			16	1-3	3
			17	1-2	3
			18	1-1	3

DMG Chart	
Die Roll	Effect
1	Sup
2	Sup
3	Sup
4	Sup
5	1Dis Dmgd
6	1 Defl Dmgd
7	Eng
8	Eng
9	Eng
10	Imp

**IMPULSE ENGINE  
= 4 BOXES**

### DISRUPTORS DAMAGED

1	2	3	4
---	---	---	---

### DEFLECTORS UP

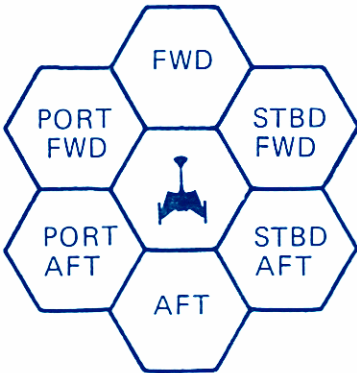

### DEFLECTORS AT 8 POINTS

### DEFLECTORS DMGD

FWD	STBD FWD	PORT FWD
AFT	STBD AFT	PORT AFT

CAPTAIN'S STRAT/TAC. SKILL \_\_\_\_\_

CREW EFFICIENCY RATING \_\_\_\_\_

### SUPERSTRUCTURE STRESS/DAMAGE

1	2	3	4	5	6	7	8	9	10
11	12	13	14	15	16	17	18	19	20

40		-3 DISR MAX SPD 4	20
39			19
38			18
37		-2 DEFL	17
36	MAX SPD 8	MAX SPD 3	16
35			15
34		-1 DISR	14
33		-4 DISR	13
32	MAX SPD 7	MAX SPD 2	12
31			11
30			10
29		-1 DEFL	9
28	MAX SPD 6	MAX SPD 1	8
27		-2 DISR	7
26			6
25		-3 DEFL	5
24	MAX SPD 5	MAX SPD 0	4
23			3
22			2
21			1



# ROMULAN Bird of Prey

Move 6,7,8 hexes 0 Def 0,1 Beam 0 Plas
Move 6,7,8 hexes 1Def 0 Beam 0 Plas
Move 3,4,5 hexes 0 Def 0 Beam 1 Plas
Move 3,4,5 hexes 0 Def 1 Beam 0 Plas
Move 3,4,5 hexes 1 Def 0,1 Beam 0 Plas
Move 0, 1, 2 hexes 0 Def 0,1 Beam 0,1Plas
Move 0, 1, 2 hexes 1Def 0 Beam 1 Plas
Move 0, 1, 2 hexes 1 Ref 1 Beam 0 Plas
Move 0, 1, 2 hexes 2 Def 1 Beam 0 Plas
Move 0, 1, 2 hexes 3 Def 0 Beam 0 Plas

Turn Chart			Plasma Firing			Beam firing		
Spd	Eng Dmg	Super Dmg	Rng	To Hit	Dmg	Rng	To Hit	Dmg
Sub	—	—	1	1-10	16	1	1-10	8
W1	—	—	2	1-9	16	2	1-10	9
W2	—	—	3	1-8	16	3	1-9	7
W3	—	1	4	1-7	12	4	1-9	7
W4	1	1	5	1-7	12	5	1-8	6
W5	1	2	6	1-7	12	5	1-8	5
W6	2	2	7	1-6	10	7	1-6	4
W7 (EM)	2	3	8	1-6	10	8	1-4	3
			9	1-5	8	9	1-2	2
			10	1-5	8	10	1	1
			11	1-4	6			
			12	1-3	6			
			13	1-2	4			
			14	1	4			

DMG Chart	
Die Roll	DMG
1	Super
2	Super
3	Super
4	Plasma
5	Beam
6	Shield
7	Cloak
8	Warp
9	Warp
10	IMP

IMPULSE = 2 BOXES

CLOAK	PLASMA	BEAM
DMGD	DMGD	DMGD

Cloak replaces Plasma on above table.

## DEFLECTORS UP

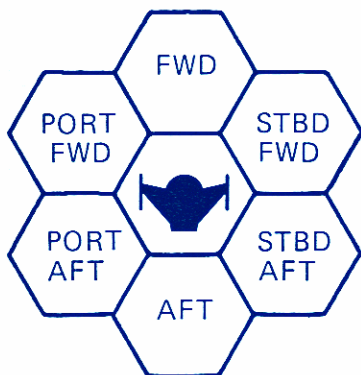

## DEFLECTORS AT 8 POINTS

## CAPTAIN'S STRAT/TAC. SKILL CREW EFFICIENCY RATING

### DEFLECTORS DMGD

FWD	STBD FWD	PORT FWD
AFT	STBD AFT	PORT AFT

## SUPERSTRUCTURE STRESS/DAMAGE

1	2	3	4	5	6	7	8	9	10
11	12	13	14	15					

## ENGINE STRESS/DAMAGE

26			13
25		MAX SPD 3	12
24	-1 DEF MAX SPD 7		11
23			10
22		MAX SPD 2	9
21	MAX SPD 6	-3 DEF	8
20			7
19		MAX SPD 1	6
18	MAX SPD 5		5
17			4
16	-2 DEF	MAX SPD 0	3
15	MAX SPD 4		2
14			1

Power below 15  
No Plasma or  
Cloak Usable.

# GORN Cruiser

## ENGINE STRESS/DAMAGE

Move 6, 7, 8 hexes 0 Defl 0,1 Blast
Move 6, 7, 8 hexes 1 Defl 0 Blast
Move 3, 4, 5 hexes 0 Defl 0, 1, 2 Blast
Move 3, 4, 5 hexes 1 Defl 0, 1 Blast
Move 3, 4, 5 hexes 2 Defl 0 Blast
Move 0, 1, 2 hexes 0 Defl 0,1,2,3,4 Bl
Move 0, 1, 2 hexes 1 Defl 0, 1, 2, 3 Bl
Move 0, 1, 2 hexes 2 Defl 0, 1, 2 Bl
Move 0, 1, 2 hexes 3 defl 0, 1 Bl
Move 0, 1, 2 hexes 4 Defl 0 Blasts

Turn Chart			Blaster Firing		
SPD	ENG	Super	Rng	To	Dmg
	DMG	DMG			
Sub	—	—	1	1-10	7
W1	—	—	2	1-10	7
W2	—	—	3	1-9	7
W3	—	1	4	1-9	6
W4	1	1	5	1-8	6
W5	1	2	6	1-8	6
W6	2	2	6	1-7	5
W7 (EM)	2	3	7	1-6	5
			8	1-5	4
			9	1-5	4
			9	1-4	4
			10	1-3	3
			11	1-2	2
			12	1	1

DMG Chart	
Die	DMG
1	Super
2	Super
3	Super
4	Super
5	1 Blaster
6	1 Shield
7	Warp
8	Eng
9	Warp
10	Eng
	IMP Eng

**IMPULSE ENGINE  
= 4 BOXES**

### BLASTERS DAMAGED

1	2	3	4
---	---	---	---

40	-2 Blast -2 DEFL	20
39	MAX SPD 3	19
38		18
37		17
36		16
35	MAX SPD 6      MAX SPD 2	15
34		14
33		13
32		12
31	-1 Blast      -3 Blast -1 DEFL      -3 DEFL	11
30	MAX SPD 5      MAX SPD 1	10
29		9
28		8
27		7
26		6
25	MAX SPD 4      MAX SPD 0	5
24		4
23		3
22		2
21		1

### DEFLECTORS UP

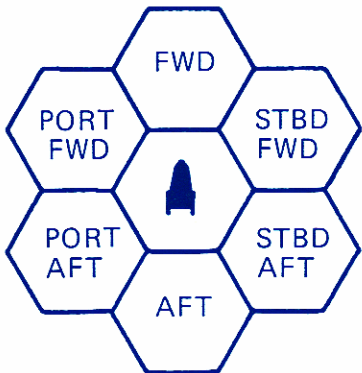

### DEFLECTORS DMGD

FWD	STBD FWD	PORT FWD
AFT	STBD AFT	PORT AFT

### DEFLECTORS AT 10 POINTS

CAPTAIN'S STRAT/TAC. SKILL \_\_\_\_\_

CREW EFFICIENCY RATING \_\_\_\_\_

### SUPERSTRUCTURE STRESS/DAMAGE

1	2	3	4	5	6	7	8	9	10
11	12	13	14	15	16				



# ORION Blockade Runner

Move 9, 10, 11 0 Def 1 Disr
Move 9, 10, 11 1 Def 0 Disr
Move 6, 7, 8 hexes 0 Def 0-3 Disr
Move 6, 7, 8 hexes 1 Def 0-2 Disr
Move 6, 7, 8 hexes 2 Def 0-1 Disr
Move 3, 4, 5 hexes 0 Def 0-6 Disr
Move 3, 4, 5 hexes 1 Def 0-4 Disr
Move 3, 4, 5 hexes 2 Def 0-3 Disr
Move 3, 4, 5 hexes 3 Def 0-1 Disr
Move 3, 4, 5 hexes 4 Def 0 Disr
Move 0, 1, 2 hexes 0-1 Def 0-7 Disr
Move 0, 1, 2 hexes 2 Def 0-5 Disr
Move 0, 1, 2 hexes 3 Def 0-4 Disr
Move 0, 1, 2 hexes 4 Def 0-2 Disr
Move 0, 1, 2 hexes 5 Def 0-1 Disr

Turn Chart			Disruptor Firing		
Spd	Eng Dmg	Super Dmg	Rng	To Hit	Dmg
SUB	—	—	1	1-10	5
W1	—	—	2	1-10	5
W2	—	—	3	1-9	5
W3	—	—	4	1-9	5
W4	—	—	5	1-8	4
W5	—	—	6	1-8	4
W6	1	1	9	1-7	4
W7	1	1	8	1-7	3
W8	2	1	9	1-6	3
W9	2	2	10	1-6	3
W10 (EM)	3	2	11	1-5	2
			12	1-5	2
			13	1-4	2
			14	1-3	1
			15	1-3	1
			16	1	1

Dmg Chart	
Die Roll	DMG
1	Super
2	Super
3	Super
4	Defl
5	Defl
6	Disr
7	Disr
8	Warp
9	Warp
10	IMP

DEFLECTORS DMGD		
FWD	STBD FWD	PORT FWD
AFT	STBD AFT	PORT AFT

IMPULSE ENGINE = 3 BOXES

ENGINE STRESS/DAMAGE

33	MAX SPD 10	17
32	-3 DISR	16
31	MAX SPD 4	15
30	MAX SPD 9 -1 DEF	14
29		13
28	-4 DISR -4 DEF MAX SPD 3	12
27	MAX SPD 8	11
26		10
25	MAX SPD 2	9
24	-1 DEF -2 DEF MAX SPD 7 -5 DISR	8
23		7
22	-5 DEF MAX SPD 1	6
21	MAX SPD 6	5
20	-2 DISR -6 DISR	4
19	MAX SPD 0	3
18	MAX SPD 5 -3 DEF	2
		1

DEFLECTORS UP

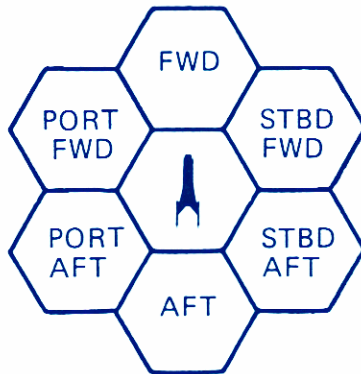

DEFLECTORS AT 6 POINTS

DISRUPTORS DAMAGED

1
2
3
4
5
6

CAPTAIN'S STRAT/TAC. SKILL \_\_\_\_\_

CREW EFFICIENCY RATING \_\_\_\_\_

SUPERSTRUCTURE STRESS/DAMAGE

1	2	3	4	5	6	7	8	9	10
11	12	13	14	15	16				

# LARSON Class Destroyer

## ENGINE STRESS/DAMAGE

Move 9, 10, 11 0 Def 1 Phaser
Move 6, 7, 8 hexes 0 Def 0-2 Phasers
Move 6, 7, 8 hexes 1 Def 0 Phasers
Move 3, 4, 5 hexes 0 Def 0-4 Phasers
Move 3, 4, 5 hexes 1 Def 0-2 Phasers
Move 3, 4, 5 hexes 2 Def 0 Phasers
Move 0, 1, 2 hexes 0 Def 0-6 Phasers
Move 0, 1, 2 hexes 1 Def 0-4 Phasers
Move -, 1, 2 hexes 2 Def 0-2 Phasers
Move 0, 1, 2 hexes 3 Def 0 Phasers

Turn Chart			Phaser Table		
Spd	Eng	Sup	Rng	To	Dmg
Sub	-	-	1	1-10	5
W1	-	-	2	1-10	5
W2	-	-	3	1-10	5
W3	-	-	4	1-9	5
W4	1	-	5	1-9	4
W5	1	1	6	1-8	4
W7	2	1	7	1-8	4
W7	2	2	8	1-7	4
W8 (EM)	3	2	9	1-7	3
			10	1-6	3
			11	1-4	3
			12	1-4	3
			13	1-3	2
			14	-2	2
			15	1	2

DMG Chart	
Die	Dmg
1	Super
2	Super
3	Super
4	Defl
5	Phaser
6	Phot
7	IMP
8	W Eng
9	W Eng
10	W Eng

Torpedo Table		
Rng	To Hit	Dmg
1	1-10	6 All Ranges
2	1-9	
3	1-8	
4	1-7	
5	1-6	
6	1-5	
7	1-4	
8	1-3	
9	1-2	
10	1-1	

22	21	20	MAX SPD 9
-1 DEFL		19	-1 Phaser
MAX SPD 10		18	
	MAX SPD 8	17	
		16	
-2 Phaser	MAX SPD 7	15	
	-2 DEFL	14	
	MAX SPD 6	13	
		12	
	MAX SPD 5	11	
		10	
-4 Phaser	MAX SPD 4	9	
		8	
	-3 DEFL	7	-5 PH
	MAX SPD 3	6	MAX SPD 2
		5	
	-6 Phaser	4	
	MAX SPD 1	3	
		2	
	MAX SPD 0	1	

Torpedoes (2) can be fired any turn if undamaged.

### DEFLECTORS DMGD

FWD	STBD FWD	PORT FWD
AFT	STBD AFT	PORT AFT

### TORPS DMGD

1	2
---	---

### PHASERS DAMAGED

1	2	3	4	5	6
---	---	---	---	---	---

### DEFLECTORS UP

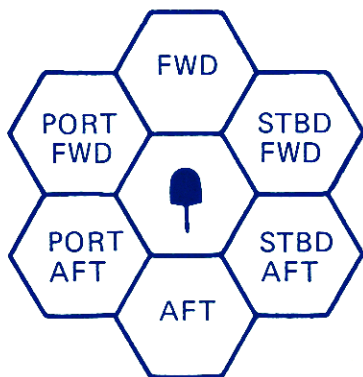

### DEFLECTORS AT 12 POINTS

CAPTAIN'S STRAT/TAC. SKILL \_\_\_\_\_  
CREW EFFICIENCY RATING \_\_\_\_\_

### SUPERSTRUCTURE STRESS/DAMAGE

1	2	3	4	5	6	7	8	9	10
11	12	IMPULSE ENGINE = 2 BOXES							



# LOKNAR Class Mdm. Frigate

Move 7, 8, 9 hexes 0 Def 1 Phaser	
Move 7, 8, 9 hexes 1 Def 0 Phaser	
Move 4, 5, 6 hexes 0 Def 0-4 Phasers	
Move 4, 5, 6 1 Def 0-2 Phasers	
Move 4, 5, 6 hexes 2 Def 0 Phasers	
Move 0-3 hexes 0 Def 0-7 Phasers	
Move 0-3 hexes 1 Def 0-5 Phasers	
Move 0-3 hexes 2 Def 0-3 Phasers	
Move 0-3 hexes 3 Def 0-1 Phasers	
Move 0-3 hexes 4 Def 0 Phasers	

Torpedoes (4) can be fired any turn if undamaged.

### DEFLECTORS UP

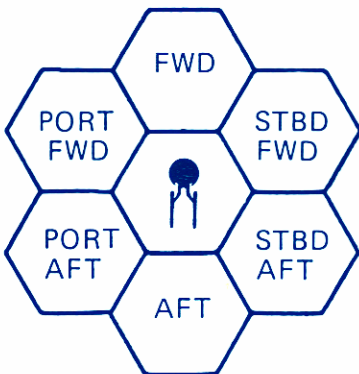

DEFLECTORS AT 14 POINTS

### SUPERSTRUCTURE STRESS/DAMAGE

1	2	3	4	5	6	7	8	9	10		
11	12	13	14	CAPTAIN'S STRAT/TAC. SKILL _____						CREW EFFICIENCY RATING _____	

Turn Chart			Phaser Firing		
Spd	Eng Dmg	Super Dmg	Rng	To Hit	Dmg
Sub	—	—	1	1-10	6
W1	—	—	2	1-10	6
W2	—	—	3	1-9	6
W3	—	—	4	1-9	5
W4	—	—	5	1-8	5
W5	—	1	6	1-8	5
W6	1	1	7	1-7	4
W7	1	2	8	1-7	4
W8	2	2	9	1-6	4
W9	2	3	10	1-6	3
W10 (EM)	3	3	11	1-5	3
			12	1-5	3
			13	1-4	2
			14	1-3	2
			15	1-2	1
			16	1	1

Dmg Chart	
Die Roll	Dmg
1	Super
2	Suocer
3	Phaser
4	Torp
5	Pha
6	Defl
7	Warp
8	Warp
9	Warp
10	IMP

IMPULSE ENGINE = 3 BOXES

### TORPEDOES DAMAGED

1	2	3	4
---	---	---	---

### DEFLECTORS DMGD

FWD	STBD FWD	PORT FWD
AFT	STBD AFT	PORT AFT

### PHASERS DAMAGED

1
2
3
4
5
6
7
8

Torpedo Table		
Rng	To Hit	Dmg
1	1-10	6 All Ranges
2	1-9	
3	1-7	
4	1-5	
5	1-3	
6	1-1	

### ENGINE STRESS/DAMAGE

28	-1 DEFL	-3 DEFL	14
27	MAX SPD 8		13
26	-4 Phaser MAX SPD 3		12
25			11
24	1- Phaser MAX SPD 7		10
23	MAX SPD 2		9
22	-5 Phaser		8
21	-2 DEFL MAX SPD 6 -4 DEFL		7
20	-2 Phaser MAX SPD 1		6
19			5
18	MAX SPD 5 -6 Phaser		4
17	MAX SPD 0		3
16	-3 Phaser		2
15	MAX SPD 4		1

# THOLIAN Spinner Class

## ENGINE STRESS/DAMAGE

Move 8, 9, 10 0 Def 0, 1 Pro
Move 5, 6, 7 hexes 0 Def 0, 1, 2 Pro
Move 5, 6, 7 hexes 1 Def 0, 1 Pro
Move 2, 3, 4 hexes 0, 1 Def 0, 1, 2 Pro
Move 2, 3, 4 hexes 2 Def 0, 1 Pro
Move 0, 1 hexes 0, 1 Def 0, 1, 2 Pro
Move 0, 1 hexes 2 Def 0, 1 Pro
Move 0, 1 hexes 3 Def 0 Pro
Move 0, 1, 2 hexes Web, 0 Def, 0 Pr
Move 0, 1, 2 hexes Web, 1 Def, 0 Pro
Move 0, 1, 2 hexes Web, 2 Def, 0 Pro

Turn Chart				Projector Firing		
Spd	Eng Dmg	Super Dmg	Rng	To Hit	Dmg	
Sub	—	—	1	1-10	8	
W1	—	—	2	1-10	9	
W2	—	—	3	1-9	7	
W3	—	—	4	1-9	7	
W4	—	—	5	1-8	6	
W5	—	1	5	1-8	5	
W7	1	1	7	1-6	4	
W7	1	1	8	1-4	3	
W8	2	2	9	1-2	2	
W9	2	2	10	1	1	
W10 (EM)	2	3				

DMG Chart	
Die	DMG
1	Super
2	Super
3	Super
4	1 Web
5	1 Projector
6	1 Shield
7	Warp
8	Warp
9	Warp
10	IMP

30	MAX SPD 9	20
29	-2 Proj	19
28	MAX SPD 5	18
27	MAX SPD 8	17
26		16
25	-1 Proj MAX SPD 4	15
24	MAX SPD 7	14
23		13
22	MAX SPD 3	12
21	-1 DEFL MAX SPD 6 -2 DEFL	11

### DEFLECTORS UP

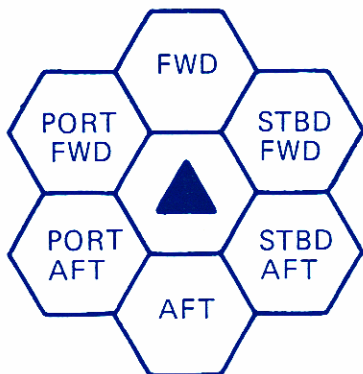

### DEFLECTORS DMGD

FWD	STBD FWD	PORT FWD
AFT	STBD AFT	PORT AFT

### PROJECTORS DMGD

1	2
---	---

WEB

DMGD
------

DEFLECTORS AT 10 POINTS  
(½ Strength when web is being used)

### SUPERSTRUCTURE STRESS/DAMAGE

1	2	3	4	5	6	7	8	9	10
11	12	13	14						

IMPULSE ENGINE = 2 BOXES

MAX SPD 2



MAX SPD 1

MAX SPD 0

CAPTAIN'S STRAT/TAC. SKILL \_\_\_\_\_  
CREW EFFICIENCY RATING \_\_\_\_\_

10
9
8
7
6
5
4
3
2
1



 1	 2	 3	 4	 5	 6	 7	Defector Dam.	Defector Dam.	Defector Dam.	Defector Dam.	Defector Dam.	Defector Dam.	 P S
 8	 9	 10	 11	 12	 13	 14	Sensors	 P S	 P S	 P S	 P S	 P S	 P S
 1	 2	 3	 4	 5	 6	 7	Current Speed	Move ment Points	 P S	 P S	 P S	00	0
 8	 9	 10	 11	 12	 13	 14	 P S	 P S	 P S	 P S	 P S	000	+
 7	 8	 9	 10	 11	 12	 13	 P S	 P S	 P S	 P S	 P S	 P S	 P S
 1	 2	 3	 4	 5	 6	 7	 P S	 P S	 P S	 P S	 P S	 P S	 P S
 2	 4	 6	 8	 4	 5	 6	Weapons Dam.	Weapons Dam.	Weapons Dam.	Sup. Dam.	Engine Dam.	Move	 P S
 1	 3	 5	 7	 1	 2	 3	Defector	Defector	Defector	Defector	Defector	Defector	 P S
 1	 2	 3	 4	 5	 6	 7	Weapons Dam.	Weapons Dam.	Weapons Dam.	Sup. Dam.	Engine Dam.	Move	 P 1 S
 8	 9	 10	 11	 12	 13	 14	Defector	Defector	Defector	Defector	Defector	Defector	 P 2 S
 1	 3	 5	 1	 2	 3	 4	Defector Dam.	Defector Dam.	Defector Dam.	Defector Dam.	Defector Dam.	Defector Dam.	 P 3 S
 2	 4	 6	 5	 6	 7	 8	Weapons Dam.	Weapons Dam.	Weapons Dam.	Sup. Dam.	Engine Dam.	Move	 P S
 9	 10	 1	 2	 3	 4	 1	 P S	 P S	 P S	 P S	 P S	 P S	 P S
 11	 12	 5	 6	 7	 8	 2	Impulse	Warp 1	Warp 2	Total	Weapons	Defector	Move
 1	 2	 3	 4	 5	 6	 7	 P S	 P S	 P S	 P S	 P S	 P S	 P S
 8	 9	 10	 11	 12	 13	 14	Tractor Beam	 P S	 P S	 P S	 P S	 P S	 P S